



FCC RF Test Report

APPLICANT : Motorola Mobility LLC
EQUIPMENT : Mobile Cellular Phone
BRAND NAME : Motorola
MODEL NAME : XT2215-2, XT2215-3, XT2215-4, XT2215DL
FCC ID : IHDT56AA4
STANDARD : 47 CFR Part 2, 96
CLASSIFICATION : Citizens Band End User Devices (CBE)
EQUIPMENT TYPE : End User Equipment
TEST DATE(S) : Dec. 17, 2021 ~ Jan. 13, 2022

We, Sporton International Inc. (ShenZhen), would like to declare that the tested sample has been evaluated in accordance with the procedures given in ANSI C63.26 and shown compliance with the applicable technical standards.

The test results in this report apply exclusively to the tested model / sample. Without written approval of Sporton International Inc. (ShenZhen), the test report shall not be reproduced except in full.

Reviewed by: Derreck Chen / Supervisor

Approved by: Eric Shih / Manager



Sporton International Inc. (ShenZhen)

1/F, 2/F, Bldg 5, Shiling Industrial Zone, Xinwei Village, Xili, Nanshan, Shenzhen, 518055
People's Republic of China



Table of Contents

History of this test report..... 3

Summary of Test Result..... 4

1 General Description 5

 1.1 Applicant..... 5

 1.2 Manufacturer 5

 1.3 Feature of Equipment Under Test..... 5

 1.4 Modification of EUT 5

 1.5 Specification of Accessory 6

 1.6 Maximum EIRP Power and Emission Designator 6

 1.7 Testing Site..... 7

 1.8 Test Software 7

 1.9 Applied Standards 8

2 Test Configuration of Equipment Under Test 9

 2.1 Test Mode..... 9

 2.2 Connection Diagram of Test System 10

 2.3 Support Unit used in test configuration 11

 2.4 Measurement Results Explanation Example 11

 2.5 Frequency List of Low/Middle/High Channels..... 12

3 Conducted Test Items..... 14

 3.1 Measuring Instruments..... 14

 3.2 Conducted Output Power 15

 3.3 EIRP 16

 3.4 Occupied Bandwidth 17

 3.5 Conducted Band Edge 18

 3.6 Conducted Spurious Emission 19

 3.7 Frequency Stability..... 20

4 Radiated Test Items 21

 4.1 Measuring Instruments..... 21

 4.2 Test Setup 21

 4.3 Test Result of Radiated Test..... 22

 4.4 Radiated Spurious Emission 23

5 List of Measuring Equipment..... 24

6 Uncertainty of Evaluation 25

Appendix A. Test Results of Conducted Test

Appendix B. Test Results of Radiated Test

Appendix C. Test Setup Photographs



Summary of Test Result

Report Clause	Ref Std. Clause	Test Items	Result (PASS/FAIL)	Remark
3.2	§2.1046	Conducted Output Power	Reporting only	-
-	§96.41	Peak-to-Average Ratio	Not Applicable	Not applicable for End User Devices
3.3	§96.41	Maximum E.I.R.P	Pass	-
		Maximum Power Spectral Density	Not Applicable	Not applicable for End User Devices
3.4	§2.1049 §96.41	Occupied Bandwidth	Reporting only	-
3.5	§2.1051 §96.41	Conducted Band Edge Measurement Adjacent Channel Leakage Ratio	Pass	-
3.6	§2.1051 §96.41	Conducted Spurious Emission	Pass	
3.7	§2.1055	Frequency Stability for Temperature & Voltage	Pass	-
4.4	§2.1051 §96.41	Radiated Spurious Emission	Pass	Under limit 12.77 dB at 10875.00 MHz

Declaration of Conformity:

The test results with all measurement uncertainty excluded are presented in accordance with the regulation limits or requirements declared by manufacturers.

Comments and Explanations:

The declared of product specification for EUT presented in the report are provided by the manufacturer, and the manufacturer takes all the responsibilities for the accuracy of product specification.



1 General Description

1.1 Applicant

Motorola Mobility LLC
222 W,Merchandise Mart Plaza, Chicago IL 60654 USA

1.2 Manufacturer

Motorola Mobility LLC
222 W,Merchandise Mart Plaza, Chicago IL 60654 USA

1.3 Feature of Equipment Under Test

Product Feature	
Equipment	Mobile Cellular Phone
Brand Name	Motorola
Model Name	XT2215-2, XT2215-3, XT2215-4, XT2215DL
FCC ID	IHDT56AA4
Tx Frequency	LTE Band 48: 3550 MHz ~ 3700 MHz
Rx Frequency	LTE Band 48: 3550 MHz ~ 3700 MHz
Bandwidth	5MHz / 10MHz / 15MHz / 20MHz
Antenna Gain	LTE Band 48 : -6.0 dBi
Type of Modulation	QPSK / 16QAM / 64QAM / 256QAM
IMEI Code	Conducted: 351475460011370 Radiation: 351475460012023
HW Version	DVT2
SW Version	S1SD32.29
EUT Stage	Identical Prototype

Remark:

1. The above EUT's information was declared by manufacturer. Please refer to the specifications or user's manual for more detailed description.
2. The four models XT2215-2, XT2215-3, XT2215-4 and XT2215DL are only for market differentiation, all the others are the same.

1.4 Modification of EUT

No modifications are made to the EUT during all test items.

1.5 Specification of Accessory

Specification of Accessory				
AC Adapter 1	Brand Name	Motorola(Chenyang)	Model Name	MC-101
AC Adapter 2	Brand Name	Motorola(Salcomp)	Model Name	MC-101
AC Adapter 3	Brand Name	Motorola(AOHAI)	Model Name	MC-101
Battery	Brand Name	Motorola(ATL)	Model Name	MD50
USB Cable 1	Brand Name	Motorola(Saibao)	Model Name	SC18D22297
USB Cable 2	Brand Name	Motorola(Cabletech)	Model Name	SC18D22298
USB Cable 3	Brand Name	Motorola(Luxshare)	Model Name	SC18D22299

1.6 Maximum EIRP Power and Emission Designator

LTE Band 48		QPSK		16QAM/64QAM	
BW (MHz)	Frequency Range (MHz)	Maximum EIRP(W)	Emission Designator (99%OBW)	Maximum EIRP(W)	Emission Designator (99%OBW)
5	3552.5~3697.5	0.0561	4M51G7D	0.0338	4M50W7D
10	3555~3695	0.0562	9M09G7D	0.0339	9M09W7D
15	3557.5~3692.5	0.0561	13M5G7D	0.0339	13M5W7D
20	3560~3690	0.0566	17M9G7D	0.0350	18M0W7D

LTE Band 48 CA		QPSK		16QAM/64QAM	
BW (MHz)	Frequency (MHz)	Maximum EIRP(W)	Emission Designator (99%OBW)	Maximum EIRP(W)	Emission Designator (99%OBW)
5MHz+20MHz	(3553.5 ~ 3690 MHz)	0.0328	23M2G7D	0.0288	23M3W7D
10MHz+20MHz	(3555.5 ~ 3690 MHz)	0.0345	28M1G7D	0.0275	28M3W7D
15MHz+20MHz	(3557.8 ~ 3690 MHz)	0.0337	33M0G7D	0.0307	33M0W7D
20MHz+5MHz	(3560 ~ 3696.7 MHz)	0.0335	23M3G7D	0.0301	23M3W7D
20MHz+10MHz	(3560 ~ 3694.5 MHz)	0.0317	28M2G7D	0.0268	27M9W7D
20MHz+15MHz	(3560 ~ 3692.2 MHz)	0.0339	32M8G7D	0.0272	33M2W7D
20MHz+20MHz	(3560 ~ 3690 MHz)	0.0343	37M9G7D	0.0283	38M0W7D

Note: All modulations have been tested, and only the worst test results of PSK & QAM are shown in the report.



1.7 Testing Site

Sporton International Inc. (Shenzhen) is accredited to ISO/IEC 17025:2017 by American Association for Laboratory Accreditation with Certificate Number 5145.01.

Test Firm	Sporton International Inc. (Shenzhen)		
Test Site Location	1/F, 2/F, Bldg 5, Shiling Industrial Zone, Xinwei Village, Xili, Nanshan, Shenzhen, 518055 People's Republic of China TEL: +86-755-86379589 FAX: +86-755-86379595		
Test Site No.	Sporton Site No.	FCC Designation No.	FCC Test Firm Registration No.
	TH01-SZ	CN1256	421272

Test Firm	Sporton International Inc. (Shenzhen)		
Test Site Location	101, 1st Floor, Block B, Building 1, No. 2, Tengfeng 4th Road, Fenghuang Community, Fuyong Street, Baoan District, Shenzhen City Guangdong Province China 518103 TEL: +86-755-33202398		
Test Site No.	Sporton Site No.	FCC Designation No.	FCC Test Firm Registration No.
	03CH01-SZ	CN1256	421272

1.8 Test Software

Item	Site	Manufacturer	Name	Version
1.	03CH01-SZ	AUDIX	E3	6.2009-8-24



1.9 Applied Standards

According to the specifications of the manufacturer, the EUT must comply with the requirements of the following standards:

- ♦ ANSI C63.26-2015
- ♦ ANSI / TIA-603-E
- ♦ 47 CFR Part 2, 96
- ♦ FCC KDB 971168 D01 Power Meas. License Digital Systems v03r01
- ♦ FCC KDB 940660 D01 Part 96 CBRS v03
- ♦ FCC KDB 412172 D01 Determining ERP and EIRP v01r01

Remark:

1. All test items were verified and recorded according to the standards and without any deviation during the test.
2. This EUT has also been tested and complied with the requirements of FCC Part 15, Subpart B, recorded in a separate test report.



2 Test Configuration of Equipment Under Test

2.1 Test Mode

Antenna port conducted and radiated test items listed below are performed according to KDB 971168 D01 Power Meas. License Digital Systems v03r01 with maximum output power.

For radiated measurement, pre-scanned in three orthogonal panels, X, Y, Z. The worst cases (Y plane) were recorded in this report.

Test Items	Band	Bandwidth (MHz)						Modulation				RB #			Test Channel		
		1.4	3	5	10	15	20	QPSK	16QAM	64QAM	256QAM	1	Half	Full	L	M	H
Max. Output Power	48	-	-	v	v	v	v	v	v	v	v	v	v	v	v	v	v
Adjacent Channel Leakage Ratio	48	-	-	v	v	v	v	v	v	v	v	v		v	v	v	v
26dB and 99% Bandwidth	48	-	-	v	v	v	v	v	v	v				v	v	v	v
Conducted Band Edge	48	-	-	v	v	v	v	v	v	v			v	v	v	v	v
Conducted Spurious Emission	48	-	-	v	v	v	v	v	v	v			v	v	v	v	v
E.R.P / E.I.R.P	48	-	-	v	v	v	v	v	v	v	v			v	v	v	v
Frequency Stability	48	-	-		v			v					v		v	v	v
Radiated Spurious Emission	48	Worst Case														v	
Remark	<ol style="list-style-type: none"> The mark "v" means that this configuration is chosen for testing The mark "-" means that this bandwidth is not supported. The device is investigated from 30MHz to 10 times of fundamental signal for radiated spurious emission test under different RB size/offset and modulations in exploratory test. Subsequently, only the worst case emissions are reported. For QAM modulation, LTE 256QAM only verify output power, the 256QAM power < 16QAM/64QAM, full tests were assessed 16QAM/64QAM. All test items are based on engineering evaluation. All the radiated test cases were performed with Adapter 1, USB Cable 1 and Earphone. 																

Test Items	Band	Bandwidth (MHz)							Modulation				RB #			Test Channel		
		20+20	20+15	15+20	20+10	10+20	20+5	5+20	QPSK	16QAM	64QAM	256QAM	1	Half	Full	L	M	H
Max. Output Power	48C	v	v	v	v	v	v	v	v	v	v	v	v		v	v	v	v
Adjacent Channel Leakage Ratio	48C	v	v	v	v	v	v	v	v	v	v			v	v	v	v	
26dB and 99% Bandwidth	48C	v	v	v	v	v	v	v	v	v	v			v	v	v	v	
Conducted Band Edge	48C	v	v	v	v	v	v	v	v	v	v			v	v	v	v	
Conducted Spurious Emission	48C	v	v	v	v	v	v	v	v	v	v			v	v	v	v	
E.R.P / E.I.R.P	48C	v	v	v	v	v	v	v	v	v	v			v	v	v	v	
Radiated Spurious Emission	48C	Worst Case																v
Note	<ol style="list-style-type: none"> The mark "v" means that this configuration is chosen for testing The mark "-" means that this bandwidth is not supported. The device is investigated from 30MHz to 10 times of fundamental signal for radiated spurious emission test under different RB size/offset and modulations in exploratory test. Subsequently, only the worst case emissions are reported. All test items are based on engineering evaluation. All the radiated test cases were performed with Adapter 1, USB Cable 1 and Earphone. 																	

2.2 Connection Diagram of Test System

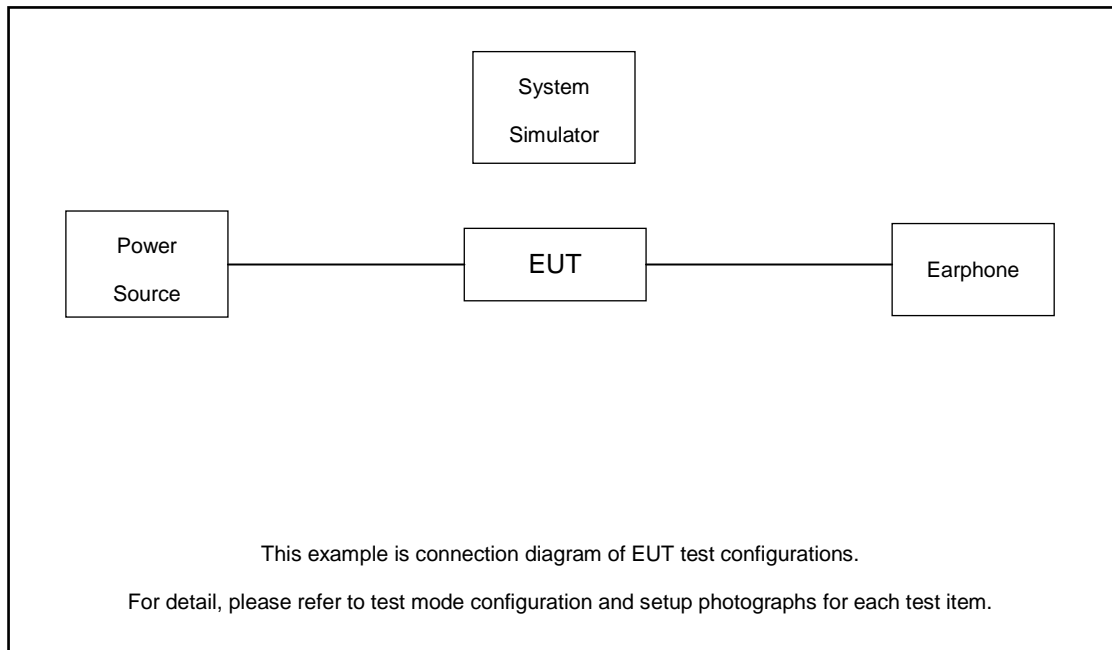

2.3 Support Unit used in test configuration

Item	Equipment	Trade Name	Model No.	FCC ID	Data Cable	Power Cord
1.	Power Supply	GWINSTEK	PSS-2002	N/A	N/A	Unshielded, 1.8 m
2.	LTE Base Station	Anritsu	MT8821C	N/A	N/A	Unshielded, 1.8 m
3.	Earphone	N/A	N/A	N/A	N/A	N/A

2.4 Measurement Results Explanation Example

For all conducted test items:

The offset level is set in the spectrum analyzer to compensate the RF cable loss and attenuator factor between EUT conducted output port and spectrum analyzer. With the offset compensation, the spectrum analyzer reading level is exactly the EUT RF output level.

The spectrum analyzer offset is derived from RF cable loss and attenuator factor.

Offset = RF cable loss + attenuator factor.

Following shows an offset computation example with cable loss 5.5 dB and 10dB attenuator.

Example :

Offset(dB) = RF cable loss(dB) + attenuator factor(dB).

$$= 5.5 + 10 = 15.5 \text{ (dB)}$$



2.5 Frequency List of Low/Middle/High Channels

LTE Band 48 Channel and Frequency List				
BW [MHz]	Channel/Frequency(MHz)	Lowest	Middle	Highest
20	Channel	55340	55990	56640
	Frequency	3560.0	3625.0	3690.0
15	Channel	55315	55990	56665
	Frequency	3557.5	3625.0	3692.5
10	Channel	55290	55990	56690
	Frequency	3555.0	3625.0	3695.0
5	Channel	55265	55990	56715
	Frequency	3552.5	3625.0	3697.5



LTE Band 48C_CA Channel and Frequency List					
BW [MHz]	Channel/Frequency(MHz)		Lowest	Middle	Highest
5 + 20	PCC	Channel	55273	55898	56523
		Frequency	3553.3	3615.8	3678.3
	SCC	Channel	55390	56015	56640
		Frequency	3565	3627.5	3690
20 + 5	PCC	Channel	55340	55965	56590
		Frequency	3560	3622.5	3685
	SCC	Channel	55457	56082	56707
		Frequency	3571.7	3634.2	3696.7
10 + 20	PCC	Channel	55295	55896	56496
		Frequency	3555.5	3615.6	3675.6
	SCC	Channel	55439	56040	56640
		Frequency	3569.9	3630	3690
20 + 10	PCC	Channel	55340	55941	56541
		Frequency	3560	3620.1	3680.1
	SCC	Channel	55484	56085	56685
		Frequency	3574.4	3634.5	3694.5
15 + 20	PCC	Channel	55318	55893	56469
		Frequency	3557.8	3615.3	3672.9
	SCC	Channel	55489	56064	56640
		Frequency	3574.9	3632.4	3690
20 + 15	PCC	Channel	55340	55916	56491
		Frequency	3560	3617.6	3675.1
	SCC	Channel	55511	56087	56662
		Frequency	3577.1	3634.7	3692.2
20 + 20	PCC	Channel	55340	55891	56442
		Frequency	3560	3615.1	3670.2
	SCC	Channel	55538	56089	56640
		Frequency	3579.8	3634.9	3690

3 Conducted Test Items

3.1 Measuring Instruments

See list of measuring instruments of this test report.

3.1.1 Test Setup

3.1.2 Conducted Output Power

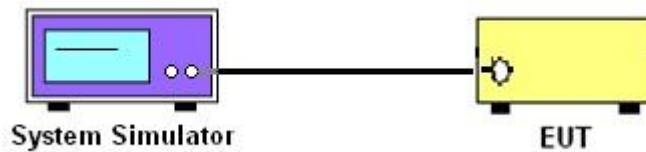

3.1.3 Occupied Bandwidth, Conducted Band-Edge and Conducted Spurious Emission

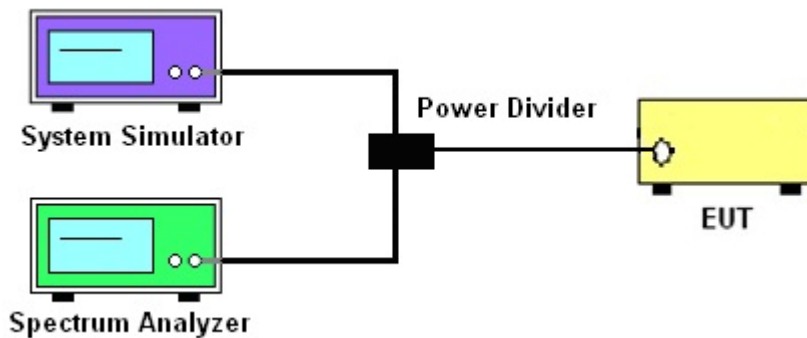

3.1.4 Frequency Stability

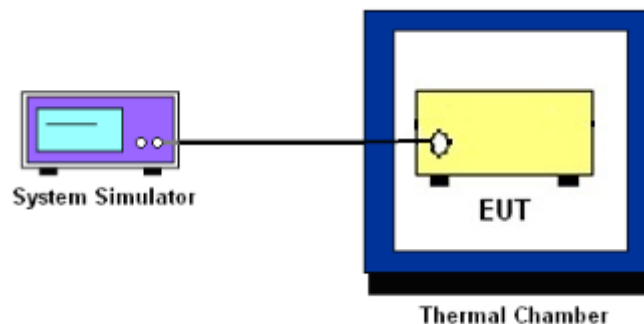

3.1.5 Test Result of Conducted Test

Please refer to Appendix A.



3.2 Conducted Output Power

3.2.1 Description of the Conducted Output Power Measurement

A system simulator was used to establish communication with the EUT. Its parameters were set to force the EUT transmitting at maximum output power. The measured power in the radio frequency on the transmitter output terminals shall be reported.

3.2.2 Test Procedures

1. The transmitter output port was connected to the system simulator.
2. Set EUT at maximum power through the system simulator.
3. Select lowest, middle, and highest channels for each band and different modulation.
4. Measure and record the power level from the system simulator.

3.3 EIRP

3.3.1 Description of the EIRP Measurement

EIRP and PSD limits for CBRS equipment as below table:

Device		Maximum EIRP (dBm/10 MHz)	Maximum PSD (dBm/MHz)
Applied	End User Device	23	n/a
<input type="checkbox"/>	Category A CBSD	30	20
<input type="checkbox"/>	Category B CBSD	47	37

Remark: The worst case EIRP shown in this section is found with LTE operating only using 1RB. As such, the EIRP/10MHz and full channel EIRP values will be identical since 1RB is fully contained within all available channel bandwidths for LTE Band 48 (i.e. 5, 10, 15, 20MHz)

3.3.2 Test Procedures for EIRP

1. Establishing a communications link with the call box (Base station) to measure the Maximum conducted power, the parameters were set to force the EUT transmitting at maximum output power level. Use the average power measurement function to measure total channel power of each channel bandwidth (per ANSI C63.26-2015 Section 5.2.1)
2. Determining ERP and/or EIRP from conducted RF output power measurements (Per ANSI C63.26-2015 Section 5.2.5.5)
 - EIRP = $P_T + G_T - L_C$, ERP = EIRP -2.15, where
 - P_T = transmitter output power in dBm
 - G_T = gain of the transmitting antenna in dBi
 - L_C = signal attenuation in the connecting cable between the transmitter and antenna in dB



3.4 Occupied Bandwidth

3.4.1 Description of Occupied Bandwidth Measurement

The occupied bandwidth is the width of a frequency band such that, below the lower and above the upper frequency limits, the mean powers emitted are each equal to a specified percentage 0.5% of the total mean transmitted power.

The 26 dB emission bandwidth is defined as the frequency range between two points, one above and one below the carrier frequency, at which the spectral density of the emission is attenuated 26 dB below the maximum in-band spectral density of the modulated signal. Spectral density (power per unit bandwidth) is to be measured with a detector of resolution bandwidth equal to approximately 1.0% of the emission bandwidth.

3.4.2 Test Procedures

The testing follows ANSI C63.26-2015 Section 5.4.3 (26dB) and Section 5.4.4 (99OB)

1. The EUT was connected to spectrum analyzer and system simulator via a power divider.
2. The spectrum analyzer center frequency is set to the nominal EUT channel center frequency. The span range for the spectrum analyzer shall be between two and five times the anticipated OBW.
3. The nominal resolution bandwidth (RBW) shall be in the range of 1 to 5 % of the anticipated OBW, and the VBW shall be at least 3 times the RBW.
4. Set the detection mode to peak, and the trace mode to max hold.
5. Determine the reference value: Set the EUT to transmit a modulated signal. Allow the trace to stabilize. Set the spectrum analyzer marker to the highest level of the displayed trace.
(this is the reference value)
6. Determine the “-26 dB down amplitude” as equal to (Reference Value – X).
7. Place two markers, one at the lowest and the other at the highest frequency of the envelope of the spectral display such that each marker is at or slightly below the “-X dB down amplitude” determined in step 6. If a marker is below this “-X dB down amplitude” value it shall be placed as close as possible to this value. The OBW is the positive frequency difference between the two markers.
8. Use the 99 % power bandwidth function of the spectrum analyzer and report the measured bandwidth.



3.5 Conducted Band Edge

3.5.1 Description of Conducted Band Edge Measurement

Part 96.41 (e) (1) (i)

For CBSD the emission limits outside the fundamental are as follows:

Within 0 MHz to 10 MHz above and below the assigned channel ≤ -13 dBm/MHz

Greater than 10 MHz above and below the assigned channel ≤ -25 dBm/MHz

Part 96.41 (e) (1) (ii)

For End User Devices the emission limits outside the fundamental are as follows:

Within 0 MHz to B MHz above and below the assigned channel ≤ -13 dBm/MHz

Greater than B MHz above and below the assigned channel ≤ -25 dBm/MHz

where B is the bandwidth in megahertz of the assigned channel or multiple contiguous channels of the End User Device.

Notwithstanding the emission limits in this paragraph, the Adjacent Channel Leakage Ratio for End User Devices shall be at least 30 dB.

Part 96.41 (e) (2)

For CBSDs and End User Devices, the conducted power of emissions below 3540 MHz or above 3710 MHz shall not exceed -25 dBm/MHz, and the conducted power of emissions below 3530 MHz or above 3720 MHz shall not exceed -40 dBm/MHz

3.5.2 Test Procedures

The testing follows FCC KDB 971168 D01 v03r01 Section 6.1.

1. The EUT was connected to spectrum analyzer and system simulator via a power divider.
2. The band edges of low and high channels for the highest RF powers were measured.
3. Set RBW $\geq 1\%$ EBW in the 1MHz band immediately outside and adjacent to the band edge.
4. Beyond the 1 MHz band from the band edge, RBW=1MHz was used
5. Offset has included the duty factor for LTE Band 48. Duty factor $=10 \log (1/x)$, where x is the measured duty cycle.
6. Set spectrum analyzer with RMS detector.
7. The RF fundamental frequency should be excluded against the limit line in the operating frequency band.



3.6 Conducted Spurious Emission

3.6.1 Description of Conducted Spurious Emission Measurement

96.41 (e)(2)

The conducted power of any emissions below 3530 MHz or above 3720 MHz shall not exceed -40dBm/MHz.

3.6.2 Test Procedures

The testing follows FCC KDB 971168 D01 v03r01 Section 6.1.

1. The EUT was connected to spectrum analyzer and system simulator via a power divider.
2. The RF output of EUT was connected to the spectrum analyzer by RF cable and attenuator. The path loss was compensated to the results for each measurement.
3. The middle channel for the highest RF power within the transmitting frequency was measured.
4. The conducted spurious emission for the whole frequency range was taken.
5. Make the measurement with the spectrum analyzer's RBW = 1MHz, VBW = 3MHz.
6. Set spectrum analyzer with RMS detector.
7. Taking the record of maximum spurious emission.
8. The RF fundamental frequency should be excluded against the limit line in the operating frequency band.
9. The limit line is -40dBm/MHz.

3.7 Frequency Stability

3.7.1 Description of Frequency Stability Measurement

The frequency stability shall be measured by variation of ambient temperature and variation of primary supply voltage to ensure that the fundamental emission stays within the authorized frequency block. The frequency stability of the transmitter shall be maintained within $\pm 0.00025\%$ ($\pm 2.5\text{ppm}$) of the center frequency

3.7.2 Test Procedures for Temperature Variation

The testing follows FCC KDB 971168 D01 v03r01 Section 9.0.

1. The EUT was set up in the thermal chamber and connected with the system simulator.
2. With power OFF, the temperature was decreased to -30°C and the EUT was stabilized before testing. Power was applied and the maximum change in frequency was recorded within one minute.
3. With power OFF, the temperature was raised in 10°C step up to 50°C . The EUT was stabilized at each step for at least half an hour. Power was applied and the maximum frequency change was recorded within one minute.

3.7.3 Test Procedures for Voltage Variation

The testing follows FCC KDB 971168 D01 v03r01 Section 9.0.

1. The EUT was placed in a temperature chamber at $25\pm 5^{\circ}\text{C}$ and connected with the system simulator.
2. The power supply voltage to the EUT was varied from 85% to 115% of the nominal value measured at the input to the EUT.
3. The variation in frequency was measured for the worst case.

4 Radiated Test Items

4.1 Measuring Instruments

See list of measuring instruments of this test report.

4.2 Test Setup

4.2.1 For radiated test below 30MHz

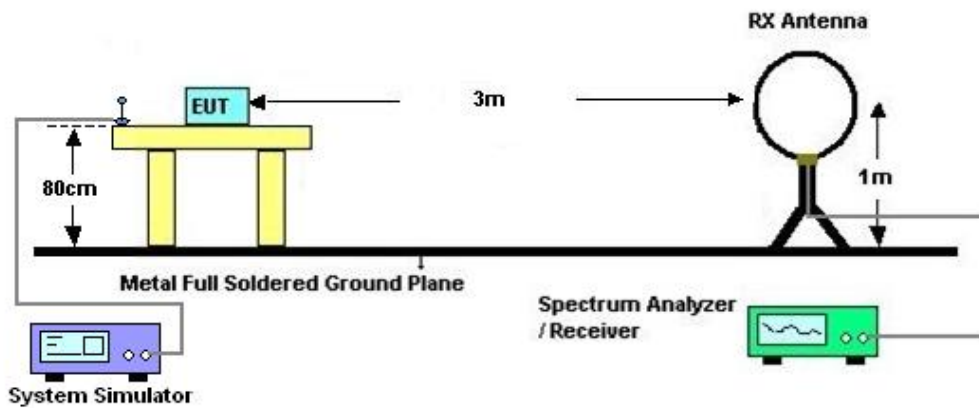

4.2.2 For radiated test from 30MHz to 1GHz

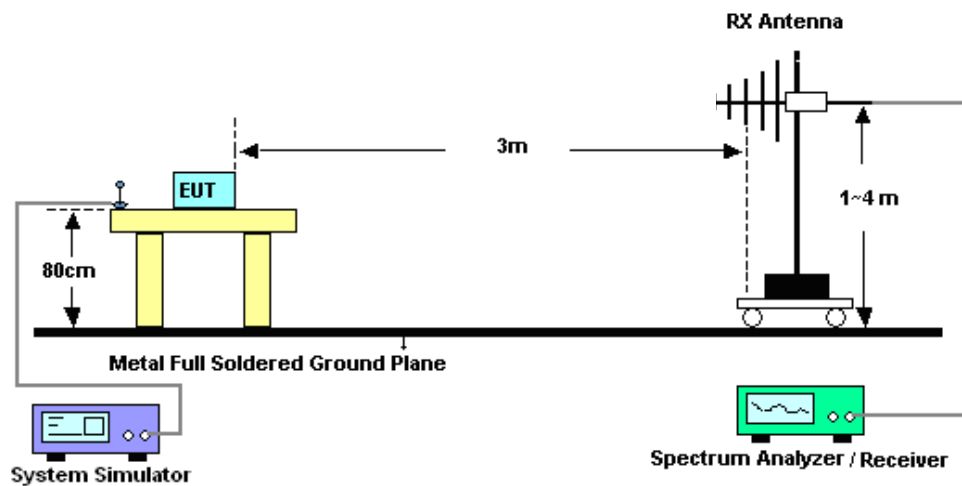

4.2.3 For radiated test above 1GHz

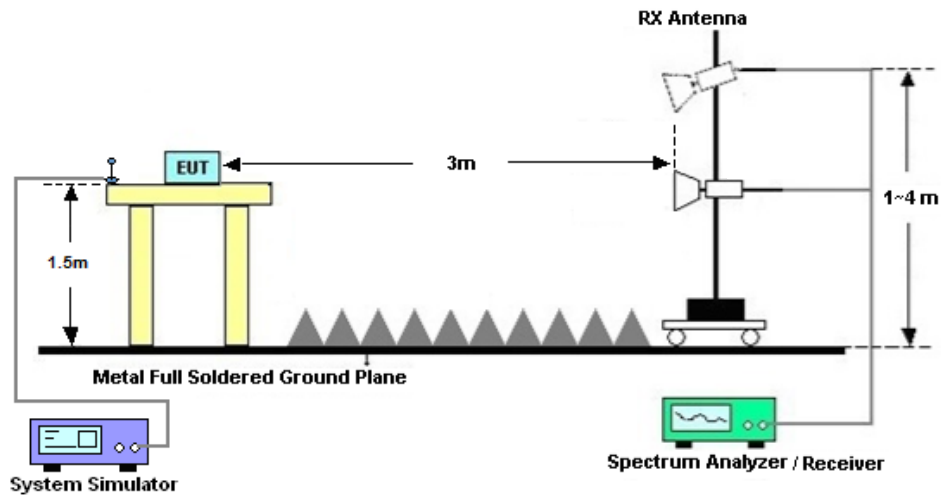

4.3 Test Result of Radiated Test

The low frequency, which started from 9 kHz to 30MHz, was pre-scanned and the result which was 20dB lower than the limit line was not reported.

Please refer to Appendix B.



4.4 Radiated Spurious Emission

4.4.1 Description of Radiated Spurious Emission Measurement

The radiated spurious emission was measured by substitution method according to ANSI / TIA-603-E. The power of any emission outside of the authorized operating frequency ranges must be attenuated below the transmitter power (P) by a factor of at least -40dBm / MHz. The spectrum is scanned from 30 MHz up to a frequency including its 10th harmonic.

4.4.2 Test Procedures

1. The EUT was placed on a turntable with 0.8 meter height for frequency below 1GHz and 1.5 meter height for frequency above 1GHz respectively above ground.
2. The EUT was set 3 meters from the receiving antenna mounted on the antenna tower.
3. The table was rotated 360 degrees to determine the position of the highest spurious emission.
4. The height of the receiving antenna is varied between 1m to 4m to search the maximum spurious emission for both horizontal and vertical polarizations.
5. During the measurement, the system simulator parameters were set to force the EUT transmitting at maximum output power.
6. Make the measurement with the spectrum analyzer's RBW = 1MHz, VBW = 3MHz, taking the record of maximum spurious emission.
7. A horn antenna was substituted in place of the EUT and was driven by a signal generator. Tune the output power of signal generator to the same emission level with EUT maximum spurious emission.
$$\text{EIRP (dBm)} = \text{S.G. Power} - \text{Tx Cable Loss} + \text{Tx Antenna Gain}$$
$$\text{ERP (dBm)} = \text{EIRP} - 2.15$$
8. The RF fundamental frequency should be excluded against the limit line in the operating frequency band.
The limit line is -40dBm/MHz



5 List of Measuring Equipment

Instrument	Manufacturer	Model No.	Serial No.	Characteristics	Calibration Date	Test Date	Due Date	Remark
Spectrum Analyzer	R&S	FSV40	101078	10Hz~40GHz	Apr. 08, 2021	Dec. 17, 2021~ Dec. 31, 2021	Apr. 07, 2022	Conducted (TH01-SZ)
DC Power Supply	TTI	PL330P	290070	Max 32V, 3A	Oct. 25, 2021	Dec. 17, 2021~ Dec. 31, 2021	Oct. 24, 2022	Conducted (TH01-SZ)
Power Divider	TOJOIN	PS-2SM-04265	60.06.020.0077	0.4GHz~26.5GHz	Dec. 26, 2020	Dec. 17, 2021~ Dec. 31, 2021	Dec. 25, 2021	Conducted (TH01-SZ)
Power Divider	TOJOIN	PS-2SM-04265	60.06.020.0077	0.4GHz~26.5GHz	Dec. 25, 2021		Dec. 24, 2022	Conducted (TH01-SZ)
Thermal Chamber	Ten Billion Hongzhangroup	LP-150U	H2014081803	-40~+150°C	Jul. 14, 2021	Dec. 17, 2021~ Dec. 31, 2021	Jul. 13, 2022	Conducted (TH01-SZ)
EXA Spectrum Analyzer	KEYSIGHT	N9010A	MY55150213	10Hz~44GHz	Jul. 21, 2021	Jan. 13, 2022	Jul. 20, 2022	Radiation (03CH01-SZ)
Loop Antenna	R&S	HFH2-Z2	100354	9kHz~30MHz	Jun. 22, 2020	Jan. 13, 2022	Jun. 21, 2022	Radiation (03CH01-SZ)
Bilog Antenna	TeseQ	CBL6112D	35407	30MHz~2GHz	Jul. 15, 2021	Jan. 13, 2022	Jul. 14, 2022	Radiation (03CH01-SZ)
Double Ridge Horn Antenna	ETS-Lindgren	3117	00119436	1GHz~18GHz	Jul. 25, 2021	Jan. 13, 2022	Jul. 24, 2022	Radiation (03CH01-SZ)
SHF-EHF Horn	com-power	AH-840	101071	18GHz~40GHz	Apr. 11, 2021	Jan. 13, 2022	Apr. 10, 2022	Radiation (03CH01-SZ)
HF Amplifier	KEYSIGHT	83017A	MY53270105	0.5GHz~26.5GHz	Oct. 16, 2021	Jan. 13, 2022	Oct. 15, 2022	Radiation (03CH01-SZ)
LF Amplifier	Burgeon	BPA-530	102209	0.01~3000Mhz	Apr. 07, 2021	Jan. 13, 2022	Apr. 06, 2022	Radiation (03CH01-SZ)
HF Amplifier	MITEQ	AMF-7D-00101800-30-10P-R	1943528	1GHz~18GHz	Oct. 15, 2021	Jan. 13, 2022	Oct. 14, 2022	Radiation (03CH01-SZ)
HF Amplifier	MITEQ	TTA1840-35-HG	1871923	18GHz~40GHz	Jul. 21, 2021	Jan. 13, 2022	Jul. 20, 2022	Radiation (03CH01-SZ)
AC Power Source	Chroma	61601	616010001985	N/A	NCR	Jan. 13, 2022	NCR	Radiation (03CH01-SZ)
Turn Table	EM	EM1000	N/A	0~360 degree	NCR	Jan. 13, 2022	NCR	Radiation (03CH01-SZ)
Antenna Mast	EM	EM1000	N/A	1 m~4 m	NCR	Jan. 13, 2022	NCR	Radiation (03CH01-SZ)

NCR: No Calibration Required



6 Uncertainty of Evaluation

Uncertainty of Radiated Emission Measurement (30 MHz ~ 1000 MHz)

Measuring Uncertainty for a Level of Confidence of 95% ($U = 2Uc(y)$)	2.48dB
---	--------

Uncertainty of Radiated Emission Measurement (1 GHz ~ 18 GHz)

Measuring Uncertainty for a Level of Confidence of 95% ($U = 2Uc(y)$)	3.53dB
---	--------

Uncertainty of Radiated Emission Measurement (18 GHz ~ 40 GHz)

Measuring Uncertainty for a Level of Confidence of 95% ($U = 2Uc(y)$)	4.02dB
---	--------



Appendix A. Test Results of Conducted Test

Test Engineer :	Yao Zhou	Temperature :	24~26°C
		Relative Humidity :	50~53%

Conducted Output Power(Average power)

LTE Band 48:

BW [MHz]	Modulation	RB Size	RB Offset	Power Low Ch. / Freq.	Power Middle Ch. / Freq.	Power High Ch. / Freq.
Channel				55340	55990	56640
Frequency (MHz)				3560	3625	3690
20	QPSK	1	0	23.35	23.41	23.25
20	QPSK	1	49	23.48	23.47	23.28
20	QPSK	1	99	23.52	23.53	23.34
20	QPSK	50	0	21.27	21.28	21.18
20	QPSK	50	24	21.25	21.19	21.10
20	QPSK	50	50	21.17	21.18	21.05
20	QPSK	100	0	21.26	21.20	21.07
20	16QAM	1	0	21.17	21.31	21.29
20	16QAM	1	49	21.05	21.36	21.29
20	16QAM	1	99	21.17	21.44	21.24
20	16QAM	50	0	20.20	20.23	20.15
20	16QAM	50	24	20.26	20.29	20.20
20	16QAM	50	50	20.14	20.23	20.12
20	16QAM	100	0	20.26	20.27	20.24
20	64QAM	1	0	20.18	20.09	20.07
20	64QAM	1	49	20.22	20.11	20.24
20	64QAM	1	99	20.07	20.14	20.21
20	64QAM	50	0	19.33	19.30	19.11
20	64QAM	50	24	19.20	19.40	19.42
20	64QAM	50	50	19.05	19.33	19.26
20	64QAM	100	0	19.29	19.38	19.17
20	256QAM	1	0	17.30	17.39	17.61
20	256QAM	1	49	17.51	17.30	17.44
20	256QAM	1	99	17.59	17.43	17.52
20	256QAM	50	0	17.64	17.50	17.54
20	256QAM	50	24	17.37	17.61	17.43
20	256QAM	50	50	17.55	17.59	17.57
20	256QAM	100	0	17.25	17.52	17.42
Channel				55315	55990	56665
Frequency (MHz)				3557.5	3625	3692.5
15	QPSK	1	0	23.35	23.39	23.32
15	QPSK	1	37	23.38	23.49	23.40
15	QPSK	1	74	23.35	23.49	23.46
15	QPSK	36	0	21.12	21.21	21.05
15	QPSK	36	20	21.20	21.09	21.13



15	QPSK	36	39	21.21	21.08	21.30
15	QPSK	75	0	21.10	21.25	21.11
15	16QAM	1	0	21.20	21.06	21.18
15	16QAM	1	37	21.19	21.18	21.07
15	16QAM	1	74	21.15	21.06	21.30
15	16QAM	36	0	20.17	20.17	20.05
15	16QAM	36	20	20.28	20.28	20.26
15	16QAM	36	39	20.17	20.11	20.17
15	16QAM	75	0	20.12	20.23	20.27
15	64QAM	1	0	20.20	20.28	20.06
15	64QAM	1	37	20.26	20.07	20.26
15	64QAM	1	74	20.23	20.21	20.22
15	64QAM	36	0	19.34	19.19	19.14
15	64QAM	36	20	19.09	19.12	19.33
15	64QAM	36	39	19.12	19.16	19.24
15	64QAM	75	0	19.30	19.34	19.21
15	256QAM	1	0	17.62	17.56	17.26
15	256QAM	1	37	17.55	17.26	17.41
15	256QAM	1	74	17.51	17.58	17.55
15	256QAM	36	0	17.63	17.37	17.56
15	256QAM	36	20	17.56	17.35	17.53
15	256QAM	36	39	17.51	17.38	17.25
15	256QAM	75	0	17.45	17.27	17.42
Channel				55290	55990	56690
Frequency (MHz)				3555	3625	3695
10	QPSK	1	0	23.50	23.31	23.50
10	QPSK	1	25	23.41	23.39	23.40
10	QPSK	1	49	23.40	23.30	23.34
10	QPSK	25	0	21.23	21.08	21.26
10	QPSK	25	12	21.11	21.14	21.09
10	QPSK	25	25	21.19	21.19	21.18
10	QPSK	50	0	21.27	21.23	21.18
10	16QAM	1	0	21.27	21.20	21.16
10	16QAM	1	25	21.14	21.11	21.10
10	16QAM	1	49	21.17	21.18	21.30
10	16QAM	25	0	20.21	20.26	20.11
10	16QAM	25	12	20.08	20.25	20.19
10	16QAM	25	25	20.24	20.27	20.09
10	16QAM	50	0	20.22	20.11	20.07
10	64QAM	1	0	20.27	20.11	20.29
10	64QAM	1	25	20.10	20.24	20.17
10	64QAM	1	49	20.21	20.17	20.24
10	64QAM	25	0	19.22	19.29	19.35
10	64QAM	25	12	19.14	19.23	19.24
10	64QAM	25	25	19.21	19.16	19.26
10	64QAM	50	0	19.15	19.18	19.30
10	256QAM	1	0	17.41	17.46	17.37
10	256QAM	1	25	17.43	17.38	17.51
10	256QAM	1	49	17.30	17.53	17.37
10	256QAM	25	0	17.44	17.45	17.30



10	256QAM	25	12	17.26	17.28	17.41
10	256QAM	25	25	17.61	17.59	17.54
10	256QAM	50	0	17.49	17.26	17.49
Channel				55265	55990	56715
Frequency (MHz)				3552.5	3625	3697.5
5	QPSK	1	0	23.47	23.35	23.45
5	QPSK	1	12	23.43	23.42	23.47
5	QPSK	1	24	23.49	23.30	23.42
5	QPSK	12	0	21.21	21.19	21.25
5	QPSK	12	7	21.12	21.20	21.17
5	QPSK	12	13	21.29	21.27	21.17
5	QPSK	25	0	21.05	21.16	21.21
5	16QAM	1	0	21.09	21.29	21.22
5	16QAM	1	12	21.26	21.24	21.05
5	16QAM	1	24	21.20	21.13	21.29
5	16QAM	12	0	20.07	20.22	20.13
5	16QAM	12	7	20.13	20.07	20.22
5	16QAM	12	13	20.28	20.14	20.17
5	16QAM	25	0	20.19	20.05	20.14
5	64QAM	1	0	20.08	20.23	20.30
5	64QAM	1	12	20.15	20.05	20.05
5	64QAM	1	24	20.14	20.22	20.12
5	64QAM	12	0	19.19	19.05	19.11
5	64QAM	12	7	19.27	19.27	19.24
5	64QAM	12	13	19.16	19.15	19.35
5	64QAM	25	0	19.16	19.18	19.28
5	256QAM	1	0	17.29	17.53	17.61
5	256QAM	1	12	17.48	17.65	17.62
5	256QAM	1	24	17.28	17.58	17.52
5	256QAM	12	0	17.55	17.50	17.52
5	256QAM	12	7	17.50	17.40	17.27
5	256QAM	12	13	17.45	17.63	17.43
5	256QAM	25	0	17.42	17.63	17.52



LTE Band 48_CA:

CA_48C								
Combination 20MHz+20MHz (100RB+100RB)								
PCC Channel	SCC Channel	Modulation	PCC		SCC		Total RB Size	Measured Power (dBm)
			RB Size	RB offset	RB Size	RB offset		
55340	55538	QPSK	100	0	100	0	200	18.91
			1	0	1	99	2	13.08
			1	99	1	0	2	21.35
		16QAM	100	0	100	0	200	19.07
			1	0	1	99	2	13.15
			1	99	1	0	2	20.52
		64QAM	100	0	100	0	200	18.06
			1	0	1	99	2	12.79
			1	99	1	0	2	19.13
		256QAM	100	0	100	0	200	16.58
			1	0	1	99	2	13.07
			1	99	1	0	2	16.43
55891	56089	QPSK	100	0	100	0	200	19.05
			1	0	1	99	2	12.91
			1	99	1	0	2	21.32
		16QAM	100	0	100	0	200	19.02
			1	0	1	99	2	12.98
			1	99	1	0	2	20.47
		64QAM	100	0	100	0	200	18.01
			1	0	1	99	2	12.68
			1	99	1	0	2	19.57
		256QAM	100	0	100	0	200	16.52
			1	0	1	99	2	12.89
			1	99	1	0	2	16.46
56442	56640	QPSK	100	0	100	0	200	18.75
			1	0	1	99	2	12.83
			1	99	1	0	2	21.15
		16QAM	100	0	100	0	200	18.82
			1	0	1	99	2	12.84
			1	99	1	0	2	20.25
		64QAM	100	0	100	0	200	17.86
			1	0	1	99	2	12.61
			1	99	1	0	2	18.94
		256QAM	100	0	100	0	200	16.35
			1	0	1	99	2	12.76
			1	99	1	0	2	16.30
Combination 20MHz+15MHz (100RB+75RB)								
PCC Channel	SCC Channel	Modulation	PCC		SCC		Total RB Size	Measured Power (dBm)
			RB Size	RB offset	RB Size	RB offset		
55340	55511	QPSK	100	0	75	0	175	19.11
			1	0	1	74	2	13.01
			1	99	1	0	2	21.30
		16QAM	100	0	75	0	175	18.84
			1	0	1	74	2	12.76
			1	99	1	0	2	20.31



		64QAM	100	0	75	0	175	17.86				
			1	0	1	74	2	12.54				
			1	99	1	0	2	18.74				
				256QAM	100	0	75	0	175	16.52		
					1	0	1	74	2	12.69		
					1	99	1	0	2	16.41		
				55916	56087	QPSK	100	0	75	0	175	19.11
							1	0	1	74	2	12.82
							1	99	1	0	2	21.20
16QAM	100					0	75	0	175	18.97		
	1					0	1	74	2	12.88		
	1					99	1	0	2	20.35		
	64QAM	100	0			75	0	175	17.63			
		1	0			1	74	2	12.39			
		1	99			1	0	2	18.57			
256QAM	100	0	75			0	175	16.47				
	1	0	1			74	2	12.95				
	1	99	1			0	2	16.38				
56491	56662	QPSK	100			0	75	0	175	19.02		
			1			0	1	74	2	12.79		
			1			99	1	0	2	21.28		
		16QAM	100			0	75	0	175	19.04		
			1			0	1	74	2	12.93		
			1			99	1	0	2	20.29		
			64QAM	100	0	75	0	175	17.83			
				1	0	1	74	2	12.47			
				1	99	1	0	2	18.75			
		256QAM	100	0	75	0	175	16.28				
			1	0	1	74	2	12.89				
			1	99	1	0	2	16.32				
		Combination 15MHz+20MHz (75RB+100RB)										
		PCC Channel	SCC Channel	Modulation	PCC		SCC		Total RB Size	Measured Power (dBm)		
					RB Size	RB offset	RB Size	RB offset				
		55318	55489	QPSK	75	0	100	0	175	19.15		
					1	0	1	99	2	13.12		
					1	74	1	0	2	21.05		
16QAM	75			0	100	0	175	19.38				
	1			0	1	99	2	13.41				
	1			74	1	0	2	20.87				
64QAM	75			0	100	0	175	17.72				
	1			0	1	99	2	12.30				
	1			74	1	0	2	18.69				
256QAM	75			0	100	0	175	16.46				
	1			0	1	99	2	12.55				
	1			74	1	0	2	16.08				
55893	56064	QPSK	75	0	100	0	175	19.21				
			1	0	1	99	2	13.07				
			1	74	1	0	2	21.28				
		16QAM	75	0	100	0	175	19.14				
			1	0	1	99	2	13.16				



		64QAM	1	74	1	0	2	20.69
			75	0	100	0	175	17.49
			1	0	1	99	2	12.29
		256QAM	1	74	1	0	2	18.76
			75	0	100	0	175	16.55
			1	0	1	99	2	12.77
56469	56640	QPSK	1	74	1	0	2	16.35
			75	0	100	0	175	19.23
			1	0	1	99	2	12.89
		16QAM	1	74	1	0	2	21.28
			75	0	100	0	175	19.15
			1	0	1	99	2	13.24
		64QAM	1	74	1	0	2	20.69
			75	0	100	0	175	17.74
			1	0	1	99	2	12.44
		256QAM	1	74	1	0	2	18.91
			75	0	100	0	175	16.28
			1	0	1	99	2	12.61
1	74	1	0	2	16.38			
Combination 20MHz+10MHz (100RB+50RB)								
PCC Channel	SCC Channel	Modulation	PCC		SCC		Total RB Size	Measured Power (dBm)
			RB Size	RB offset	RB Size	RB offset		
55340	55484	QPSK	100	0	50	0	150	18.66
			1	0	1	49	2	12.45
			1	99	1	0	2	20.94
		16QAM	100	0	50	0	150	18.91
			1	0	1	49	2	12.64
			1	99	1	0	2	20.08
		64QAM	100	0	50	0	150	18.07
			1	0	1	49	2	12.76
			1	99	1	0	2	19.13
		256QAM	100	0	50	0	150	16.33
			1	0	1	49	2	12.61
			1	99	1	0	2	15.94
55941	56085	QPSK	100	0	50	0	150	18.73
			1	0	1	49	2	12.57
			1	99	1	0	2	21.01
		16QAM	100	0	50	0	150	18.91
			1	0	1	49	2	12.92
			1	99	1	0	2	20.26
		64QAM	100	0	50	0	150	17.91
			1	0	1	49	2	12.77
			1	99	1	0	2	19.15
		256QAM	100	0	50	0	150	16.53
			1	0	1	49	2	12.85
			1	99	1	0	2	16.18
56541	56685	QPSK	100	0	50	0	150	18.65
			1	0	1	49	2	12.68
			1	99	1	0	2	20.99
		16QAM	100	0	50	0	150	18.92



		64QAM	1	0	1	49	2	12.85
			1	99	1	0	2	20.28
			100	0	50	0	150	17.99
		256QAM	1	0	1	49	2	12.62
			1	99	1	0	2	18.96
			100	0	50	0	150	16.54
			1	0	1	49	2	12.83
			1	99	1	0	2	16.26
			Combination 10MHz+20MHz (50RB+100RB)					
PCC Channel	SCC Channel	Modulation	PCC		SCC		Total RB Size	Measured Power (dBm)
			RB Size	RB offset	RB Size	RB offset		
55295	55439	QPSK	50	0	100	0	150	19.04
			1	0	1	99	2	12.87
			1	49	1	0	2	21.38
		16QAM	50	0	100	0	150	18.70
			1	0	1	99	2	12.90
			1	49	1	0	2	20.40
		64QAM	50	0	100	0	150	17.77
			1	0	1	99	2	12.50
			1	49	1	0	2	18.70
		256QAM	50	0	100	0	150	16.65
			1	0	1	99	2	12.87
			1	49	1	0	2	16.45
55896	56040	QPSK	50	0	100	0	150	19.08
			1	0	1	99	2	12.61
			1	49	1	0	2	21.34
		16QAM	50	0	100	0	150	18.91
			1	0	1	99	2	12.88
			1	49	1	0	2	20.38
		64QAM	50	0	100	0	150	17.68
			1	0	1	99	2	12.43
			1	49	1	0	2	18.58
		256QAM	50	0	100	0	150	16.66
			1	0	1	99	2	12.70
			1	49	1	0	2	16.44
56496	56640	QPSK	50	0	100	0	150	19.07
			1	0	1	99	2	12.77
			1	49	1	0	2	21.12
		16QAM	50	0	100	0	150	18.91
			1	0	1	99	2	12.77
			1	49	1	0	2	20.37
		64QAM	50	0	100	0	150	17.74
			1	0	1	99	2	12.43
			1	49	1	0	2	18.86
		256QAM	50	0	100	0	150	16.47
			1	0	1	99	2	12.62
			1	49	1	0	2	16.31
Combination 20MHz+5MHz (100RB+25RB)								
PCC Channel	SCC Channel	Modulation	PCC		SCC		Total RB Size	Measured Power (dBm)
			RB Size	RB offset	RB Size	RB offset		



55340	55457	QPSK	100	0	25	0	125	18.94
			1	0	1	24	2	12.94
			1	99	1	0	2	21.25
		16QAM	100	0	25	0	125	18.59
			1	0	1	24	2	12.54
			1	99	1	0	2	20.60
		64QAM	100	0	25	0	125	17.84
			1	0	1	24	2	12.55
			1	99	1	0	2	18.72
		256QAM	100	0	25	0	125	16.10
			1	0	1	24	2	12.67
			1	99	1	0	2	16.00
55965	56082	QPSK	100	0	25	0	125	18.82
			1	0	1	24	2	12.66
			1	99	1	0	2	21.00
		16QAM	100	0	25	0	125	18.84
			1	0	1	24	2	12.76
			1	99	1	0	2	20.78
		64QAM	100	0	25	0	125	17.59
			1	0	1	24	2	12.25
			1	99	1	0	2	18.88
		256QAM	100	0	25	0	125	16.16
			1	0	1	24	2	12.47
			1	99	1	0	2	16.16
56590	56707	QPSK	100	0	25	0	125	18.83
			1	0	1	24	2	12.91
			1	99	1	0	2	21.01
		16QAM	100	0	25	0	125	18.71
			1	0	1	24	2	12.54
			1	99	1	0	2	20.69
		64QAM	100	0	25	0	125	17.76
			1	0	1	24	2	12.53
			1	99	1	0	2	18.87
		256QAM	100	0	25	0	125	16.31
			1	0	1	24	2	12.67
			1	99	1	0	2	16.14
Combination 5MHz+20MHz (25RB+100RB)								
PCC Channel	SCC Channel	Modulation	PCC		SCC		Total RB Size	Measured Power (dBm)
			RB Size	RB offset	RB Size	RB offset		
55273	55390	QPSK	25	0	100	0	125	18.67
			1	0	1	99	2	12.64
			1	24	1	0	2	21.10
		16QAM	25	0	100	0	125	19.13
			1	0	1	99	2	13.16
			1	24	1	0	2	20.59
		64QAM	25	0	100	0	125	17.79
			1	0	1	99	2	12.54
			1	24	1	0	2	19.30
		256QAM	25	0	100	0	125	16.16
			1	0	1	99	2	12.39



55898	56015	QPSK	1	24	1	0	2	16.07		
			25	0	100	0	125	18.77		
			1	0	1	99	2	12.84		
		16QAM	1	24	1	0	2	21.00		
				25	0	100	0	125	19.04	
				1	0	1	99	2	12.90	
			64QAM	1	24	1	0	2	20.37	
					25	0	100	0	125	17.97
					1	0	1	99	2	12.61
		256QAM	1	24	1	0	2	19.22		
				25	0	100	0	125	16.27	
				1	0	1	99	2	12.58	
56523	56640	QPSK	1	24	1	0	2	16.07		
			25	0	100	0	125	18.73		
			1	0	1	99	2	12.78		
		16QAM	1	24	1	0	2	21.16		
				25	0	100	0	125	19.15	
				1	0	1	99	2	12.96	
			64QAM	1	24	1	0	2	20.37	
					25	0	100	0	125	17.69
					1	0	1	99	2	12.34
		256QAM	1	24	1	0	2	19.23		
				25	0	100	0	125	16.36	
				1	0	1	99	2	12.67	
1	1	24	1	0	2	16.23				



EIRP

The worst case EIRP shown in this section is found with LTE operating only using 1RB. As such, the EIRP/10MHz and full channel EIRP values will be identical since 1RB is fully contained within all available channel bandwidths for LTE Band 48 (i.e. 5, 10, 15, 20MHz)

LTE Band 48 (GT - LC = -6.0 dB) QPSK									
Bandwidth	5M			10M			15M		
Channel	55265	55990	56715	55290	55990	56690	55315	55990	56665
	(Low)	(Mid)	(High)	(Low)	(Mid)	(High)	(Low)	(Mid)	(High)
Conducted Power (dBm/10MHz)	23.49	23.30	23.42	23.50	23.31	23.50	23.38	23.49	23.40
Conducted Power (Watts/10MHz)	0.2234	0.2138	0.2198	0.2239	0.2143	0.2239	0.2178	0.2234	0.2188
EIRP (dBm/10MHz)	17.49	17.30	17.42	17.50	17.31	17.50	17.38	17.49	17.40
EIRP (Watts/10MHz)	0.0561	0.0537	0.0552	0.0562	0.0538	0.0562	0.0547	0.0561	0.0550

LTE Band 48 (GT - LC = -6.0 dB) QPSK			
Bandwidth	20M		
Channel	55340	55990	56640
	(Low)	(Mid)	(High)
Conducted Power (dBm/10MHz)	23.52	23.53	23.34
Conducted Power (Watts/10MHz)	0.2249	0.2254	0.2158
EIRP (dBm/10MHz)	17.52	17.53	17.34
EIRP (Watts/10MHz)	0.0565	0.0566	0.0542



LTE Band 48 (GT - LC = -6.0 dB) 16QAM									
Bandwidth	5M			10M			15M		
Channel	55265	55990	56715	55290	55990	56690	55315	55990	56665
	(Low)	(Mid)	(High)	(Low)	(Mid)	(High)	(Low)	(Mid)	(High)
Conducted Power (dBm/10MHz)	21.20	21.13	21.29	21.17	21.18	21.30	21.15	21.06	21.30
Conducted Power (Watts/10MHz)	0.1318	0.1297	0.1346	0.1309	0.1312	0.1349	0.1303	0.1276	0.1349
EIRP (dBm/10MHz)	15.20	15.13	15.29	15.17	15.18	15.30	15.15	15.06	15.30
EIRP (Watts/10MHz)	0.0331	0.0326	0.0338	0.0329	0.0330	0.0339	0.0327	0.0321	0.0339

LTE Band 48 (GT - LC = -6.0 dB) 16QAM			
Bandwidth	20M		
Channel	55340	55990	56640
	(Low)	(Mid)	(High)
Conducted Power (dBm/10MHz)	21.17	21.44	21.24
Conducted Power (Watts/10MHz)	0.1309	0.1393	0.1330
EIRP (dBm/10MHz)	15.17	15.44	15.24
EIRP (Watts/10MHz)	0.0329	0.0350	0.0334



LTE Band 48 (GT - LC = -6.0 dB) 64QAM									
Bandwidth	5M			10M			15M		
Channel	55265	55990	56715	55290	55990	56690	55315	55990	56665
	(Low)	(Mid)	(High)	(Low)	(Mid)	(High)	(Low)	(Mid)	(High)
Conducted Power (dBm/10MHz)	20.08	20.23	20.30	20.27	20.11	20.29	20.20	20.28	20.06
Conducted Power (Watts/10MHz)	0.1019	0.1054	0.1072	0.1064	0.1026	0.1069	0.1047	0.1067	0.1014
EIRP (dBm/10MHz)	14.08	14.23	14.30	14.27	14.11	14.29	14.20	14.28	14.06
EIRP (Watts/10MHz)	0.0256	0.0265	0.0269	0.0267	0.0258	0.0269	0.0263	0.0268	0.0255

LTE Band 48 (GT - LC = -6.0 dB) 64QAM			
Bandwidth	20M		
Channel	55340	55990	56640
	(Low)	(Mid)	(High)
Conducted Power (dBm/10MHz)	20.22	20.11	20.24
Conducted Power (Watts/10MHz)	0.1052	0.1026	0.1057
EIRP (dBm/10MHz)	14.22	14.11	14.24
EIRP (Watts/10MHz)	0.0264	0.0258	0.0265



LTE Band 48 (GT - LC = -6.0 dB) 256QAM									
Bandwidth	5M			10M			15M		
Channel	55265	55990	56715	55290	55990	56690	55315	55990	56665
	(Low)	(Mid)	(High)	(Low)	(Mid)	(High)	(Low)	(Mid)	(High)
Conducted Power (dBm/10MHz)	17.48	17.65	17.62	17.61	17.59	17.54	17.63	17.37	17.56
Conducted Power (Watts/10MHz)	0.0560	0.0582	0.0578	0.0577	0.0574	0.0568	0.0579	0.0546	0.0570
EIRP (dBm/10MHz)	11.48	11.65	11.62	11.61	11.59	11.54	11.63	11.37	11.56
EIRP (Watts/10MHz)	0.0141	0.0146	0.0145	0.0145	0.0144	0.0143	0.0146	0.0137	0.0143

LTE Band 48 (GT - LC = -6.0 dB) 256QAM			
Bandwidth	20M		
Channel	55340	55990	56640
	(Low)	(Mid)	(High)
Conducted Power (dBm/10MHz)	17.64	17.50	17.54
Conducted Power (Watts/10MHz)	0.0581	0.0562	0.0568
EIRP (dBm/10MHz)	11.64	11.50	11.54
EIRP (Watts/10MHz)	0.0146	0.0141	0.0143



LTE Band 48 CA (GT - LC = -6.0 dB) QPSK									
Bandwidth	20M + 20M			20M + 15M			15M + 20M		
Channel PCC	55340	55891	56442	55340	55916	56491	55318	55893	56469
	(Low)	(Mid)	(High)	(Low)	(Mid)	(High)	(Low)	(Mid)	(High)
Channel SCC	55538	56089	56640	55511	56087	56662	55489	56064	56640
	(Low)	(Mid)	(High)	(Low)	(Mid)	(High)	(Low)	(Mid)	(High)
Conducted Power (dBm/10MHz)	21.35	21.32	21.15	21.30	21.20	21.28	21.05	21.28	21.28
Conducted Power (Watts/10MHz)	0.1365	0.1355	0.1303	0.1349	0.1318	0.1343	0.1274	0.1343	0.1343
EIRP (dBm/10MHz)	15.35	15.32	15.15	15.30	15.20	15.28	15.05	15.28	15.28
EIRP (Watts/10MHz)	0.0343	0.0340	0.0327	0.0339	0.0331	0.0337	0.0320	0.0337	0.0337

LTE Band 48 CA (GT - LC = -6.0 dB) QPSK									
Bandwidth	20M + 10M			10M + 20M			20M + 5M		
Channel PCC	55340	55941	56541	55295	55896	56496	55340	55965	56590
	(Low)	(Mid)	(High)	(Low)	(Mid)	(High)	(Low)	(Mid)	(High)
Channel SCC	55484	56085	56685	55439	56040	56640	55457	56082	56707
	(Low)	(Mid)	(High)	(Low)	(Mid)	(High)	(Low)	(Mid)	(High)
Conducted Power (dBm/10MHz)	20.94	21.01	20.99	21.38	21.34	21.12	21.25	21.00	21.01
Conducted Power (Watts/10MHz)	0.1242	0.1262	0.1256	0.1374	0.1361	0.1294	0.1334	0.1259	0.1262
EIRP (dBm/10MHz)	14.94	15.01	14.99	15.38	15.34	15.12	15.25	15.00	15.01
EIRP (Watts/10MHz)	0.0312	0.0317	0.0316	0.0345	0.0342	0.0325	0.0335	0.0316	0.0317



LTE Band 48 CA (GT - LC = -6.0 dB) QPSK			
Bandwidth	5M + 20M		
Channel PCC	55273	55898	56523
	(Low)	(Mid)	(High)
Channel SCC	55390	56015	56640
	(Low)	(Mid)	(High)
Conducted Power (dBm/10MHz)	21.10	21.00	21.16
Conducted Power (Watts/10MHz)	0.1288	0.1259	0.1306
EIRP (dBm/10MHz)	15.10	15.00	15.16
EIRP (Watts/10MHz)	0.0324	0.0316	0.0328

LTE Band 48 CA (GT - LC = -6.0 dB) 16QAM									
Bandwidth	20M + 20M			20M + 15M			15M + 20M		
Channel PCC	55340	55891	56442	55340	55916	56491	55318	55893	56469
	(Low)	(Mid)	(High)	(Low)	(Mid)	(High)	(Low)	(Mid)	(High)
Channel SCC	55538	56089	56640	55511	56087	56662	55489	56064	56640
	(Low)	(Mid)	(High)	(Low)	(Mid)	(High)	(Low)	(Mid)	(High)
Conducted Power (dBm/10MHz)	20.52	20.47	20.25	20.31	20.35	20.29	20.87	20.69	20.69
Conducted Power (Watts/10MHz)	0.1127	0.1114	0.1059	0.1074	0.1084	0.1069	0.1222	0.1172	0.1172
EIRP (dBm/10MHz)	14.52	14.47	14.25	14.31	14.35	14.29	14.87	14.69	14.69
EIRP (Watts/10MHz)	0.0283	0.0280	0.0266	0.0270	0.0272	0.0269	0.0307	0.0294	0.0294



LTE Band 48 CA (GT - LC = -6.0 dB) 16QAM									
Bandwidth	20M + 10M			10M + 20M			20M + 5M		
Channel PCC	55340	55941	56541	55295	55896	56496	55340	55965	56590
	(Low)	(Mid)	(High)	(Low)	(Mid)	(High)	(Low)	(Mid)	(High)
Channel SCC	55484	56085	56685	55439	56040	56640	55457	56082	56707
	(Low)	(Mid)	(High)	(Low)	(Mid)	(High)	(Low)	(Mid)	(High)
Conducted Power (dBm/10MHz)	20.08	20.26	20.28	20.40	20.38	20.37	20.60	20.78	20.69
Conducted Power (Watts/10MHz)	0.1019	0.1062	0.1067	0.1096	0.1091	0.1089	0.1148	0.1197	0.1172
EIRP (dBm/10MHz)	14.08	14.26	14.28	14.40	14.38	14.37	14.60	14.78	14.69
EIRP (Watts/10MHz)	0.0256	0.0267	0.0268	0.0275	0.0274	0.0274	0.0288	0.0301	0.0294

LTE Band 48 CA (GT - LC = -6.0 dB) 16QAM			
Bandwidth	5M + 20M		
Channel PCC	55273	55898	56523
	(Low)	(Mid)	(High)
Channel SCC	55390	56015	56640
	(Low)	(Mid)	(High)
Conducted Power (dBm/10MHz)	20.59	20.37	20.37
Conducted Power (Watts/10MHz)	0.1146	0.1089	0.1089
EIRP (dBm/10MHz)	14.59	14.37	14.37
EIRP (Watts/10MHz)	0.0288	0.0274	0.0274



LTE Band 48 CA (GT - LC = -6.0 dB) 64QAM									
Bandwidth	20M + 20M			20M + 15M			15M + 20M		
Channel PCC	55340	55891	56442	55340	55916	56491	55318	55893	56469
	(Low)	(Mid)	(High)	(Low)	(Mid)	(High)	(Low)	(Mid)	(High)
Channel SCC	55538	56089	56640	55511	56087	56662	55489	56064	56640
	(Low)	(Mid)	(High)	(Low)	(Mid)	(High)	(Low)	(Mid)	(High)
Conducted Power (dBm/10MHz)	19.13	19.57	18.94	18.74	18.57	18.75	18.69	18.76	18.91
Conducted Power (Watts/10MHz)	0.0818	0.0906	0.0783	0.0748	0.0719	0.0750	0.0740	0.0752	0.0778
EIRP (dBm/10MHz)	13.13	13.57	12.94	12.74	12.57	12.75	12.69	12.76	12.91
EIRP (Watts/10MHz)	0.0206	0.0228	0.0197	0.0188	0.0181	0.0188	0.0186	0.0189	0.0195

LTE Band 48 CA (GT - LC = -6.0 dB) 64QAM									
Bandwidth	20M + 10M			10M + 20M			20M + 5M		
Channel PCC	55340	55941	56541	55295	55896	56496	55340	55965	56590
	(Low)	(Mid)	(High)	(Low)	(Mid)	(High)	(Low)	(Mid)	(High)
Channel SCC	55484	56085	56685	55439	56040	56640	55457	56082	56707
	(Low)	(Mid)	(High)	(Low)	(Mid)	(High)	(Low)	(Mid)	(High)
Conducted Power (dBm/10MHz)	19.13	19.15	18.96	18.70	18.58	18.86	18.72	18.88	18.87
Conducted Power (Watts/10MHz)	0.0818	0.0822	0.0787	0.0741	0.0721	0.0769	0.0745	0.0773	0.0771
EIRP (dBm/10MHz)	13.13	13.15	12.96	12.70	12.58	12.86	12.72	12.88	12.87
EIRP (Watts/10MHz)	0.0206	0.0207	0.0198	0.0186	0.0181	0.0193	0.0187	0.0194	0.0194



LTE Band 48 CA (GT - LC = -6.0 dB) 64QAM			
Bandwidth	5M + 20M		
Channel PCC	55273	55898	56523
	(Low)	(Mid)	(High)
Channel SCC	55390	56015	56640
	(Low)	(Mid)	(High)
Conducted Power (dBm/10MHz)	19.30	19.22	19.23
Conducted Power (Watts/10MHz)	0.0851	0.0836	0.0838
EIRP (dBm/10MHz)	13.30	13.22	13.23
EIRP (Watts/10MHz)	0.0214	0.0210	0.0210



LTE Band 48 / 5MHz

QPSK

Middle Channel / 1RB0

Middle Channel / 1RBmax

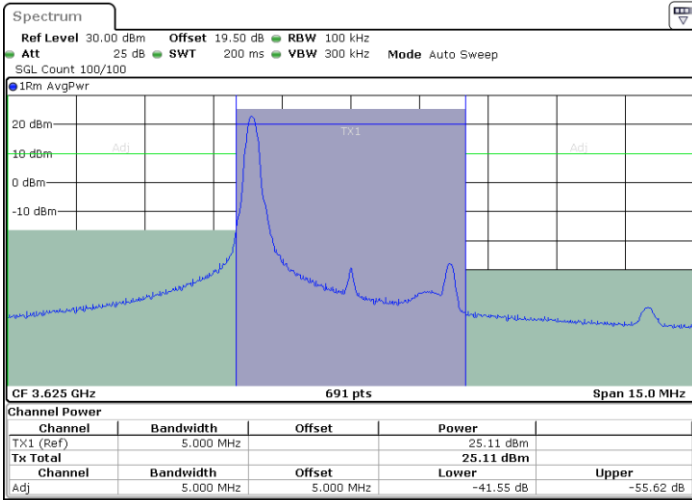

Date: 20.DEC.2021 08:00:56

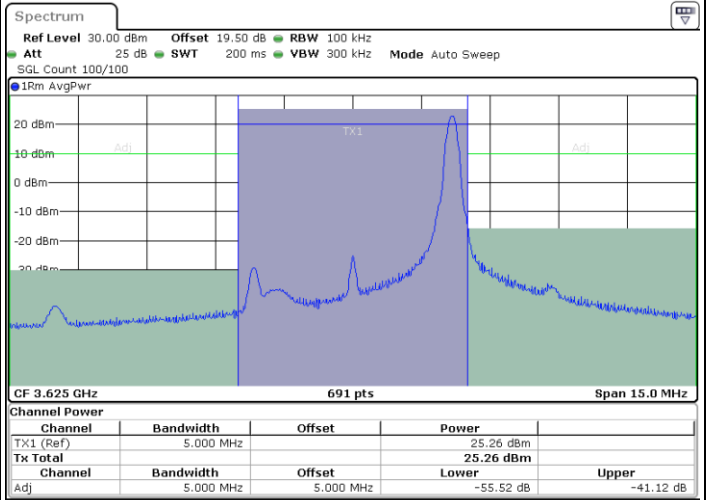

Date: 20.DEC.2021 08:13:10

Middle Channel / Full RB

N/A

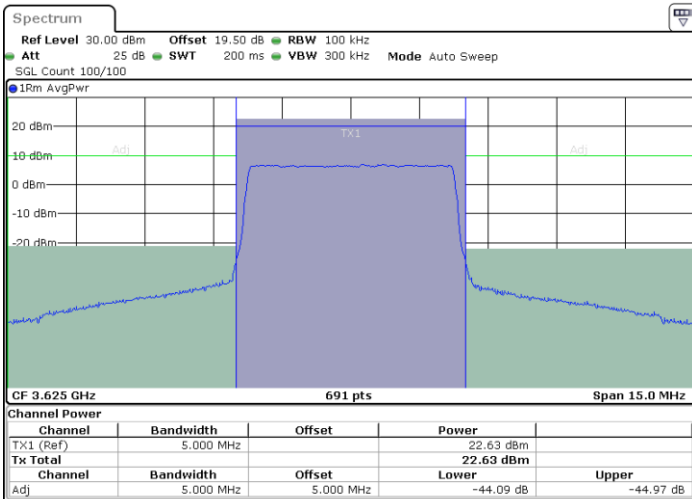

Date: 20.DEC.2021 08:07:03

Blank



LTE Band 48 / 5MHz

QPSK

Highest Channel / 1RB0

Highest Channel / 1RBmax

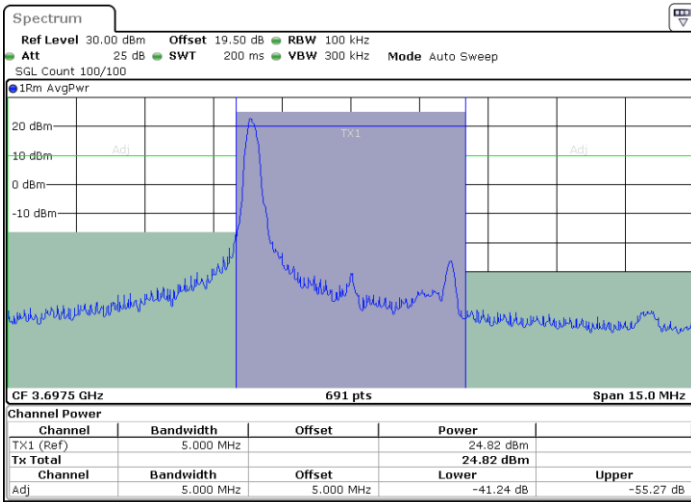

Date: 20.DEC.2021 08:01:38

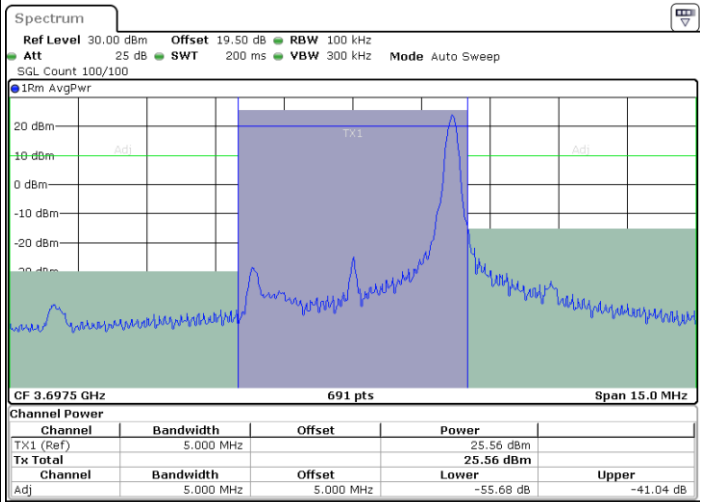

Date: 20.DEC.2021 08:13:52

Highest Channel / Full RB

N/A

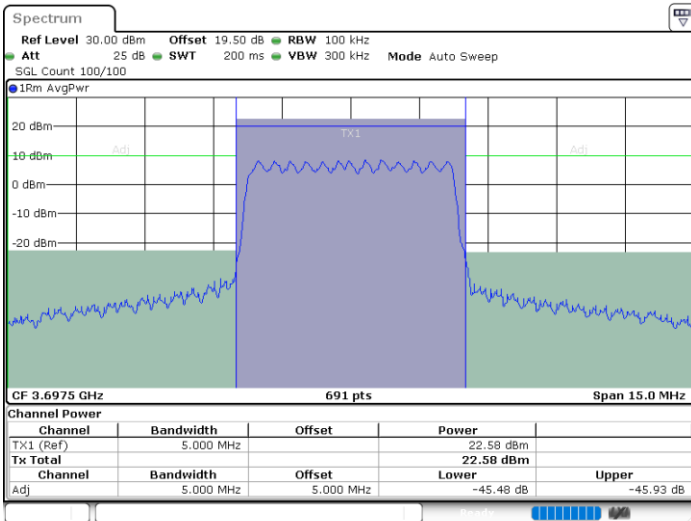

Date: 20.DEC.2021 08:07:45

Blank



LTE Band 48 / 10MHz

QPSK

Lowest Channel / 1RB0

Lowest Channel / 1RBmax

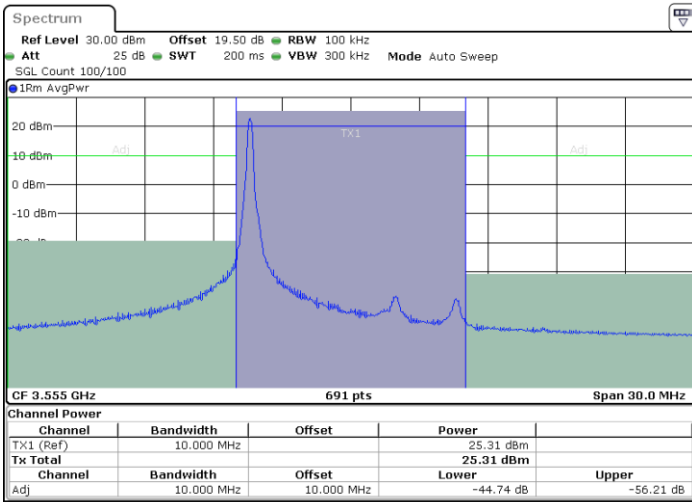

Date: 20.DEC.2021 08:17:18

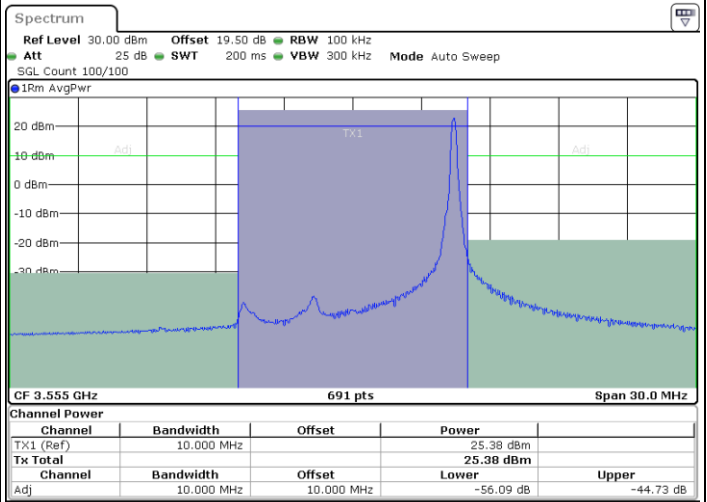

Date: 20.DEC.2021 08:29:36

Lowest Channel / Full RB

N/A

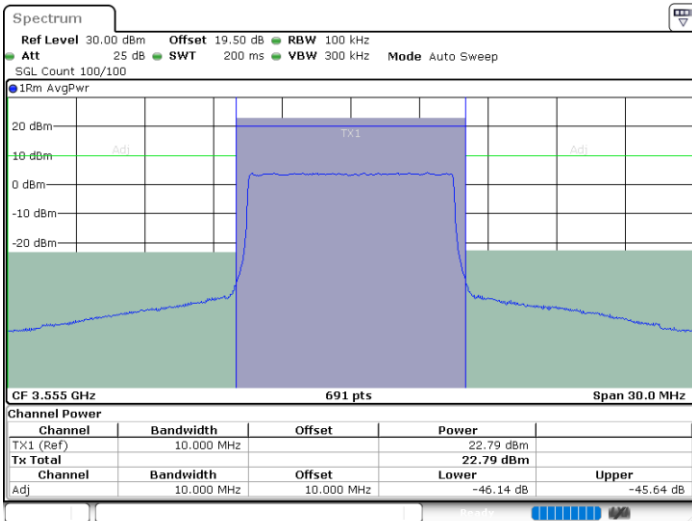

Date: 20.DEC.2021 08:23:27

Blank



LTE Band 48 / 10MHz

QPSK

MiddleChannel / 1RB0

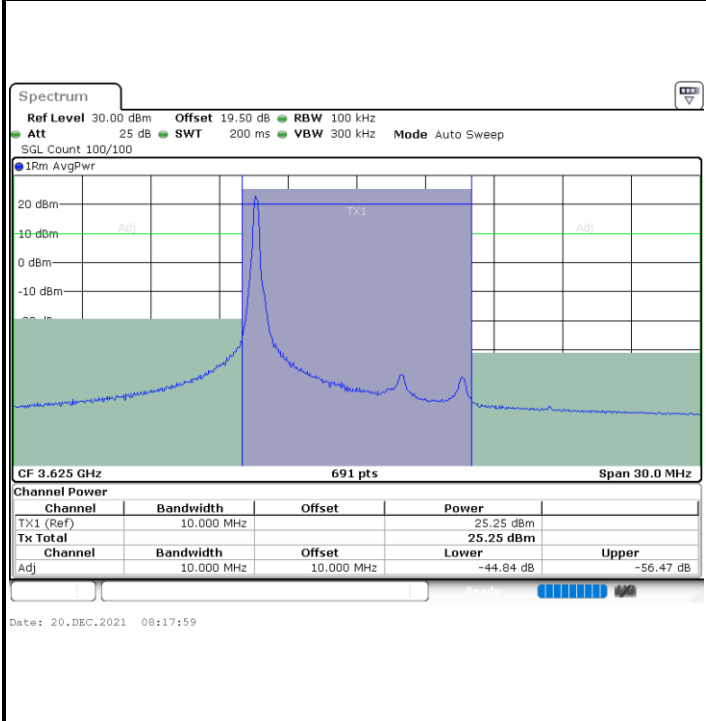

Middle Channel / 1RBmax

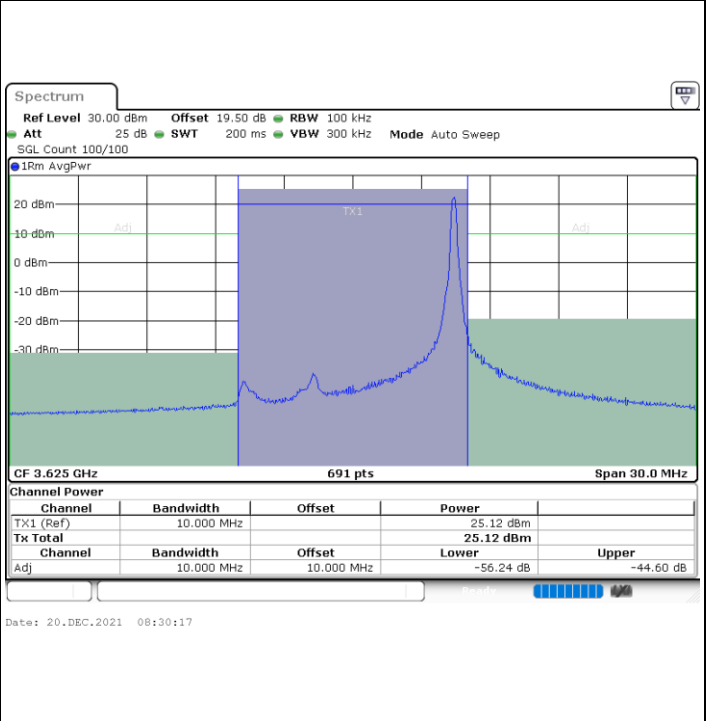

Middle Channel / Full RB

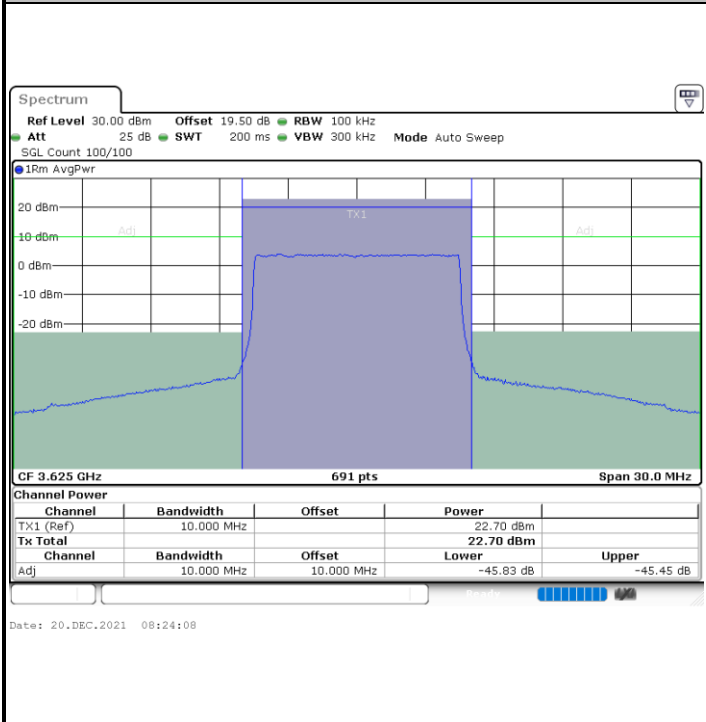

N/A

Blank



LTE Band 48 / 10MHz

QPSK

Highest Channel / 1RB0

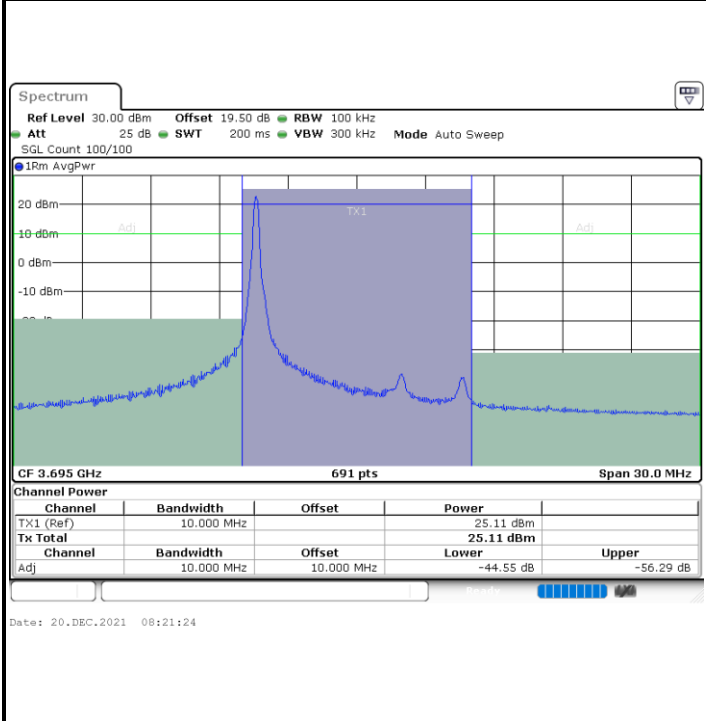

Highest Channel / 1RBmax

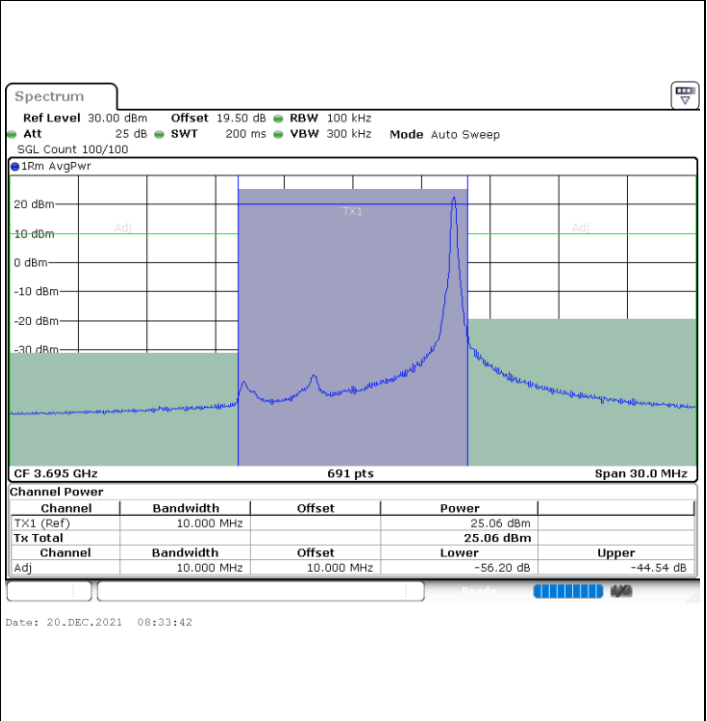

Highest Channel / Full RB

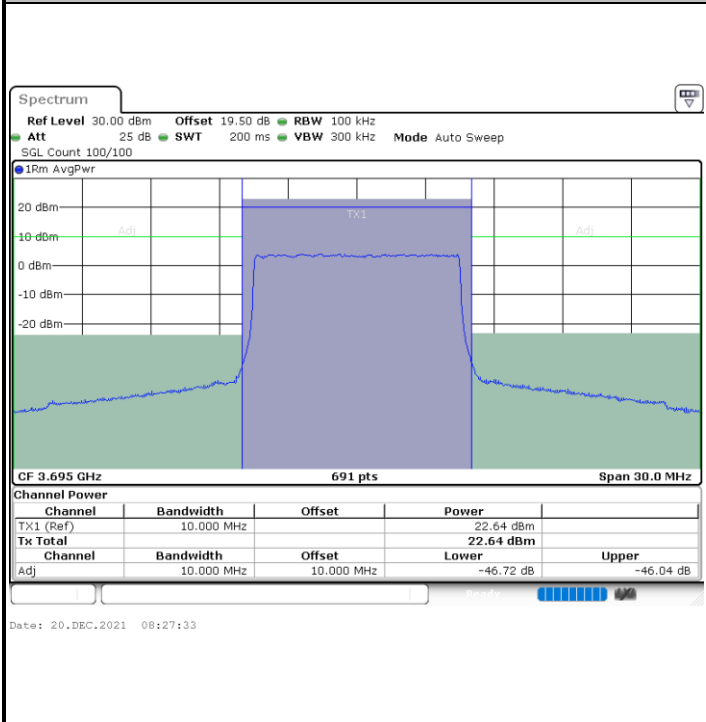

N/A

Blank



LTE Band 48 / 15MHz

QPSK

Lowest Channel / 1RB0

Lowest Channel / 1RBmax

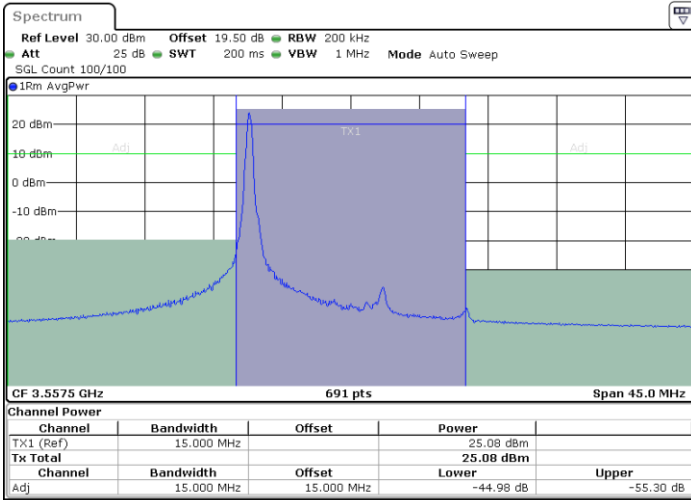

Date: 20.DEC.2021 08:34:24

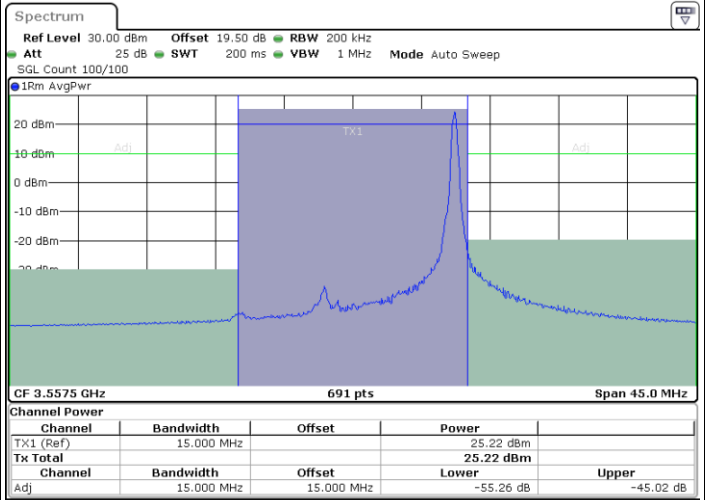

Date: 20.DEC.2021 09:55:38

Lowest Channel / Full RB

N/A

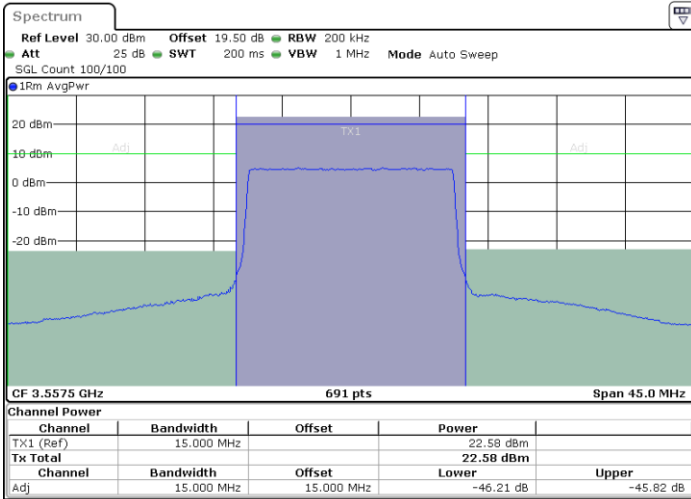

Date: 20.DEC.2021 08:40:35

Blank



LTE Band 48 / 15MHz

QPSK

Middle Channel / 1RB0

Middle Channel / 1RBmax

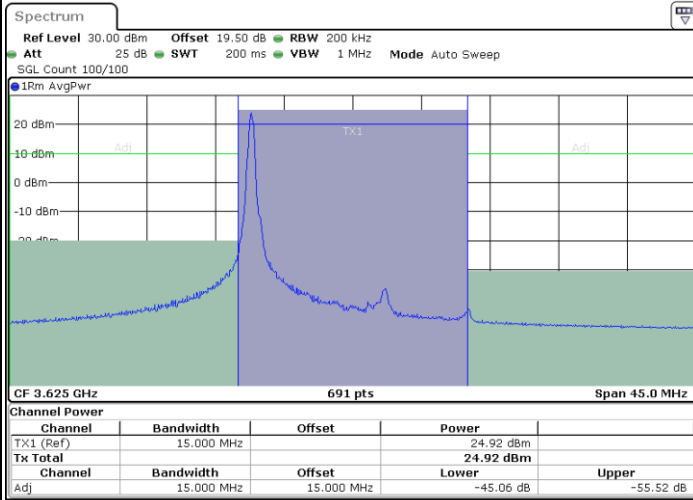

Date: 20.DEC.2021 08:37:48

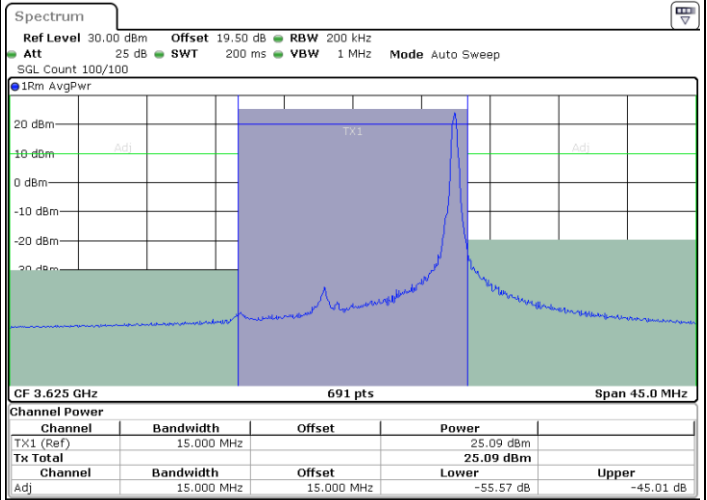

Date: 20.DEC.2021 09:59:02

Middle Channel / Full RB

N/A

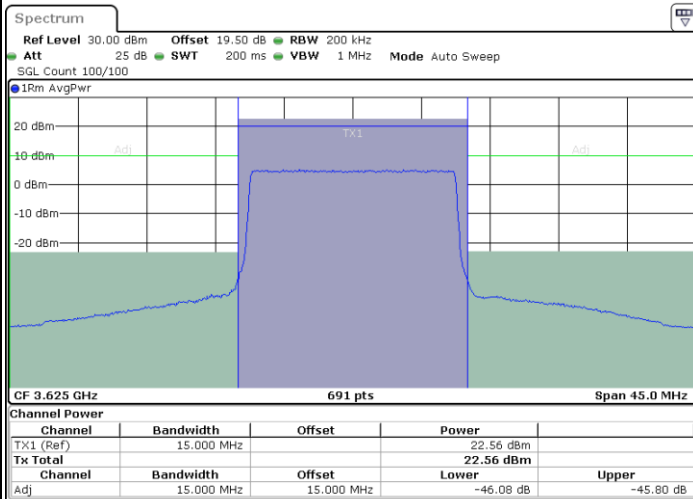

Date: 20.DEC.2021 08:45:29

Blank



LTE Band 48 / 15MHz

QPSK

Highest Channel / 1RB0

Highest Channel / 1RBmax

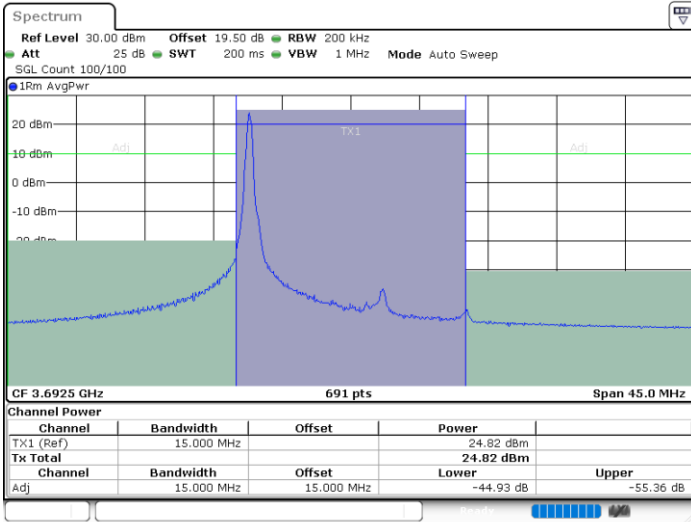

Date: 20.DEC.2021 08:38:29

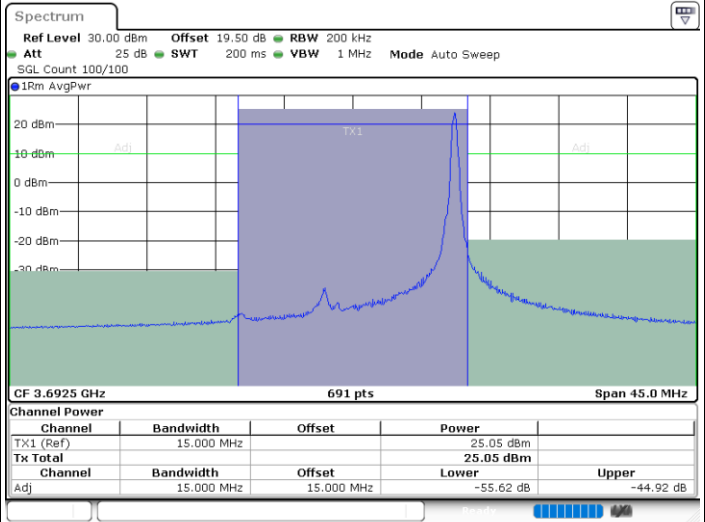

Date: 20.DEC.2021 09:59:43

Highest Channel / Full RB

N/A

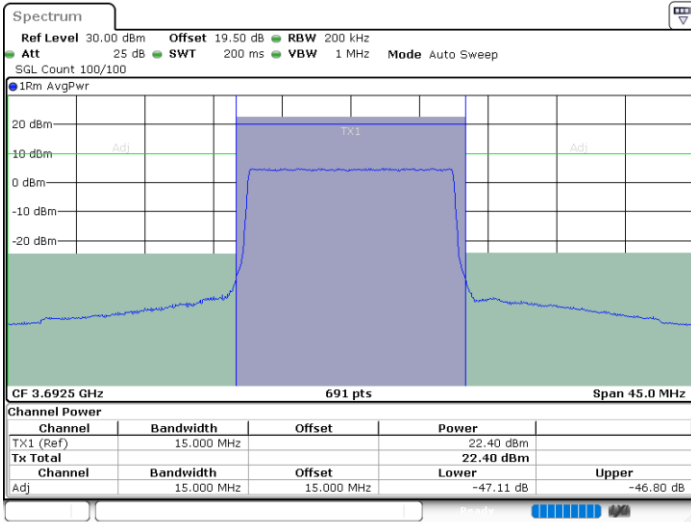

Date: 20.DEC.2021 10:24:40

Blank



LTE Band 48 / 20MHz

QPSK

Lowest Channel / 1RB0

Lowest Channel / 1RBmax

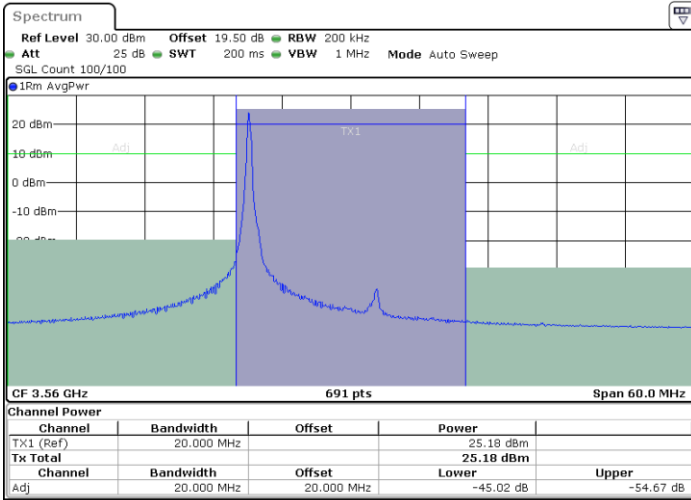

Date: 20.DEC.2021 10:09:10

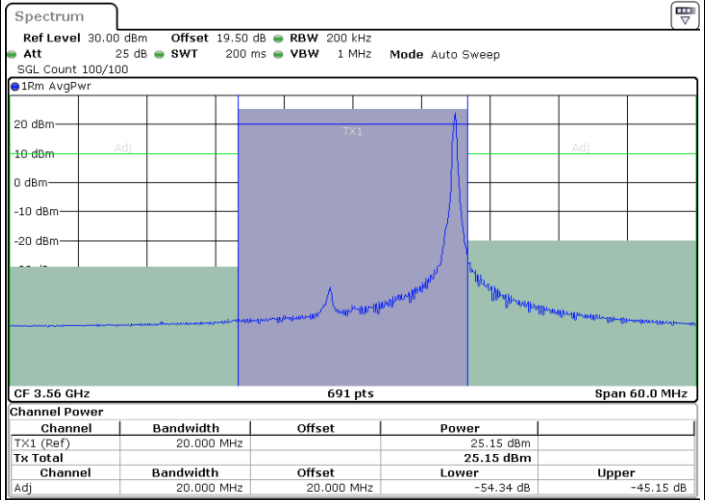

Date: 20.DEC.2021 10:15:10

Lowest Channel / Full RB

N/A

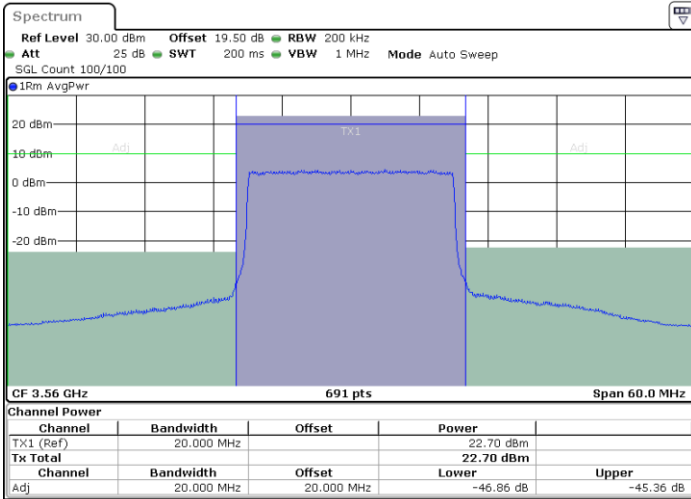

Date: 20.DEC.2021 10:03:09

Blank



LTE Band 48 / 20MHz

QPSK

Middle Channel / 1RB0

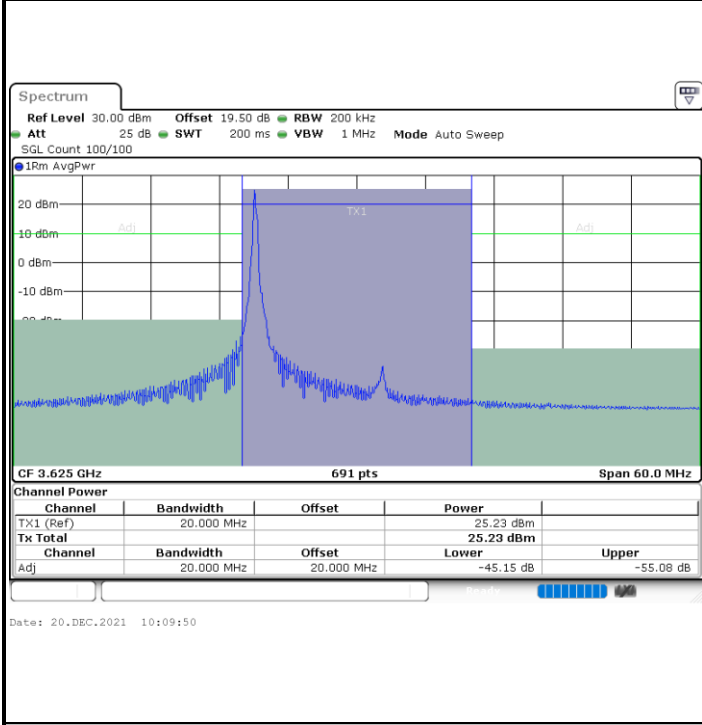

Middle Channel / 1RBmax

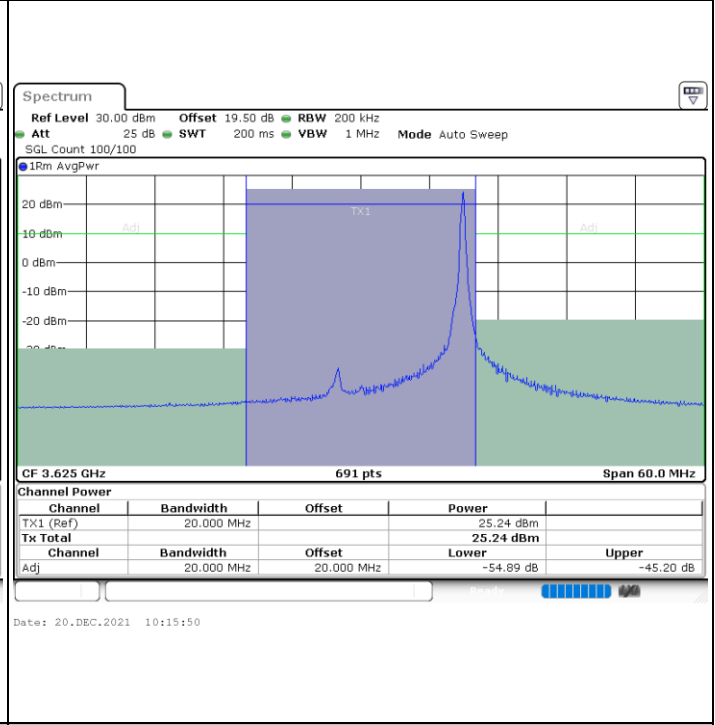

Middle Channel / Full RB

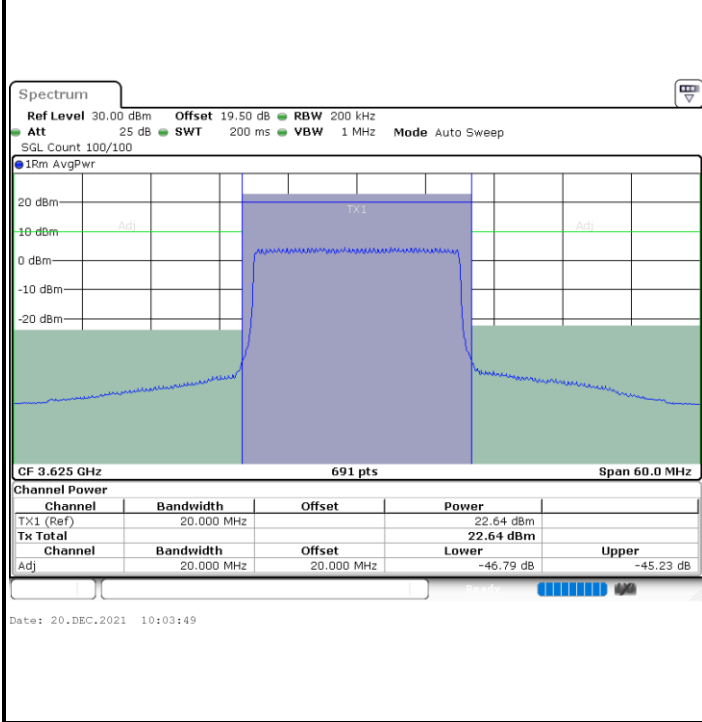

N/A

Blank



LTE Band 48 / 20MHz

QPSK

Highest Channel / 1RB0

Highest Channel / 1RBmax

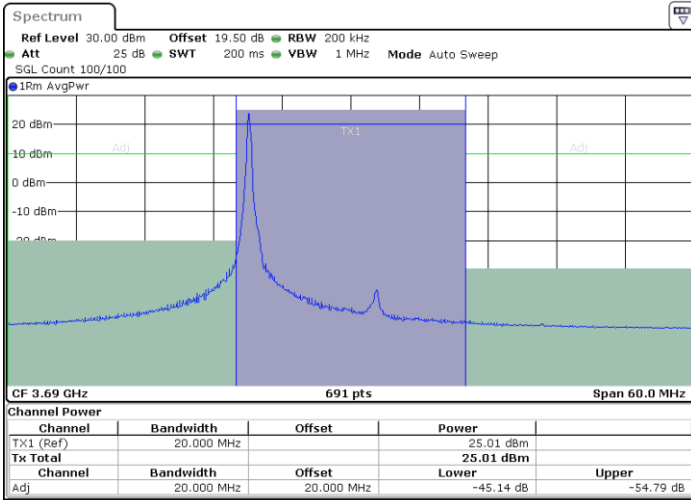

Date: 20.DEC.2021 10:13:09

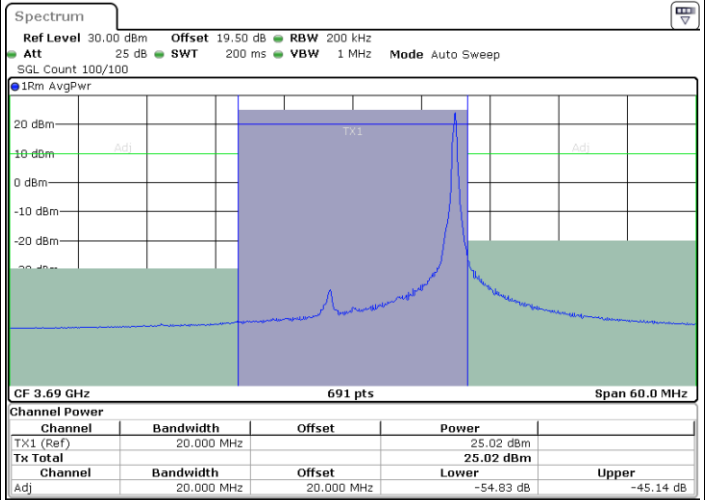

Date: 20.DEC.2021 10:19:10

Highest Channel / Full RB

N/A

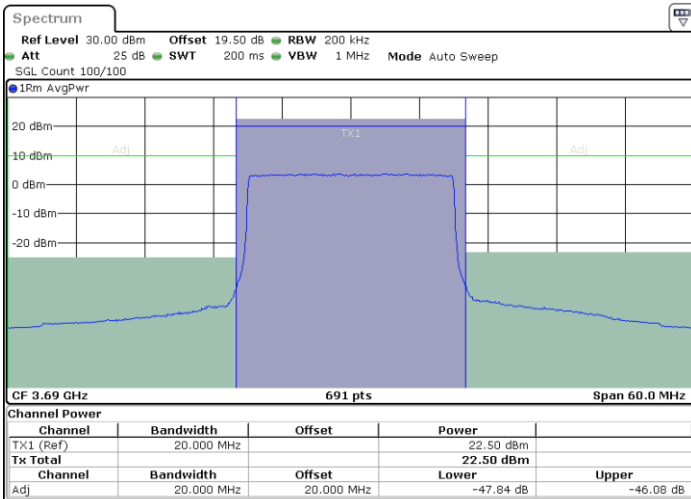

Date: 20.DEC.2021 10:07:09

Blank



LTE Band 48 / 5MHz

16QAM

Lowest Channel / 1RB0

Lowest Channel / 1RBmax

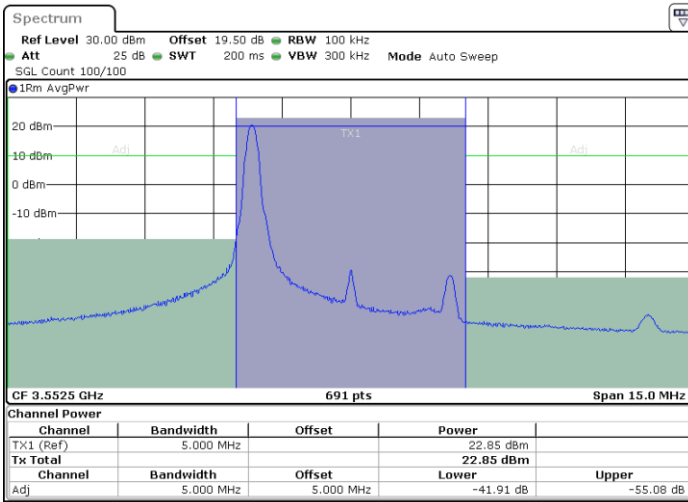

Date: 20.DEC.2021 07:58:16

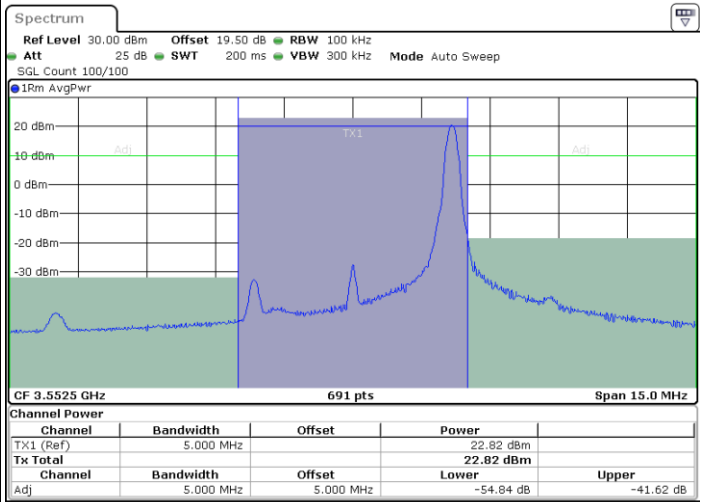

Date: 20.DEC.2021 08:10:30

Lowest Channel / Full RB

N/A

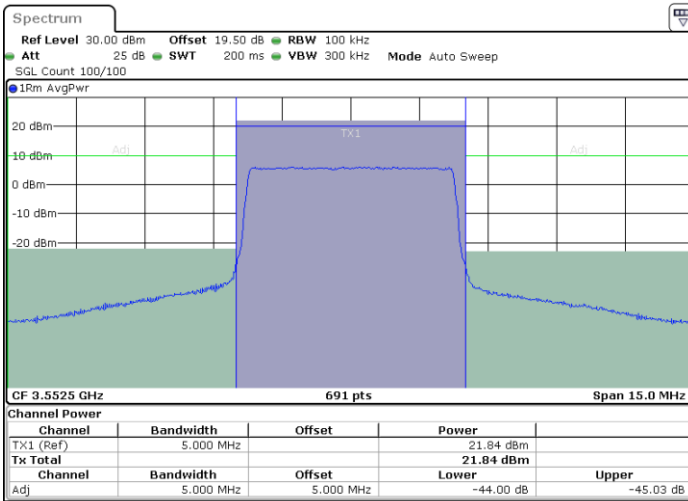

Date: 20.DEC.2021 08:04:22

Blank



LTE Band 48 / 5MHz

16QAM

Middle Channel / 1RB0

Middle Channel / 1RBmax

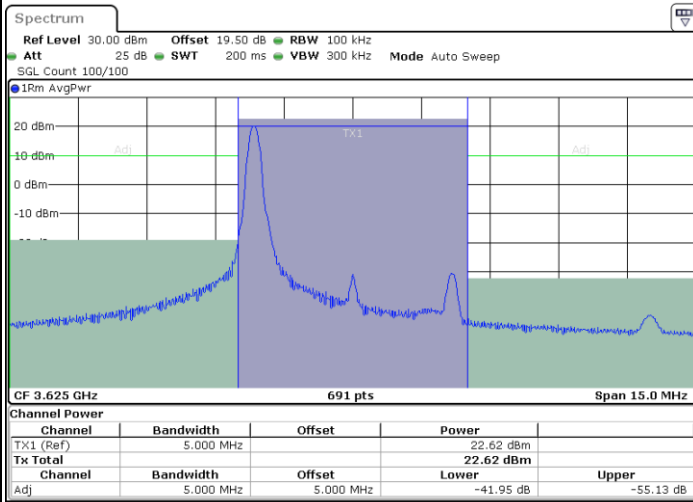

Date: 20.DEC.2021 08:00:16

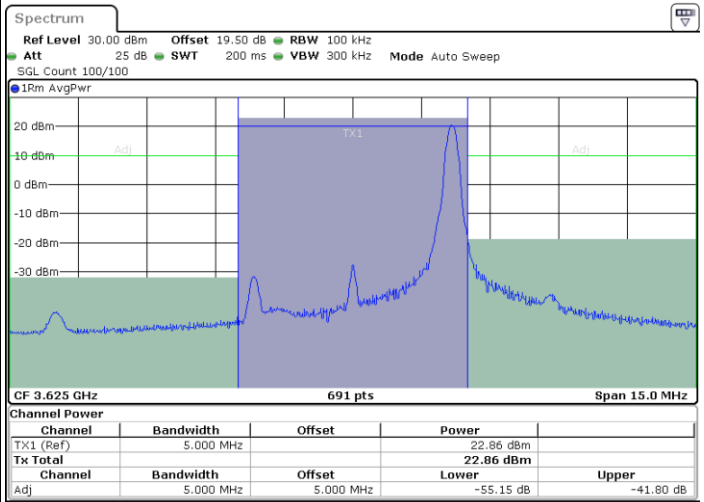

Date: 20.DEC.2021 08:12:30

Middle Channel / Full RB

N/A

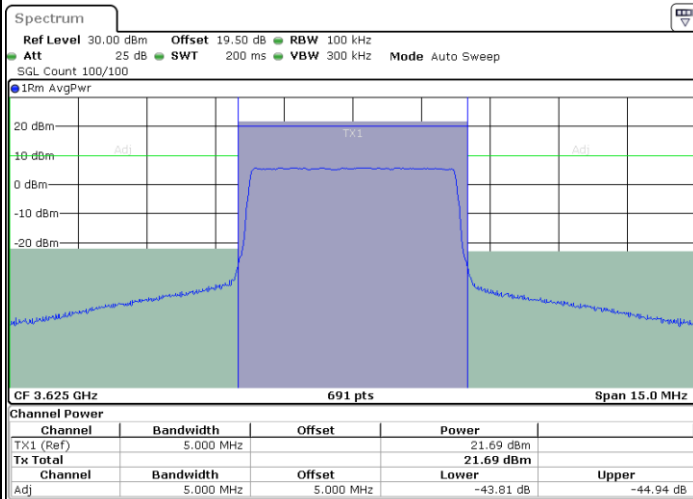

Date: 20.DEC.2021 08:06:23

Blank



LTE Band 48 / 5MHz

16QAM

Highest Channel / 1RB0

Highest Channel / 1RBmax

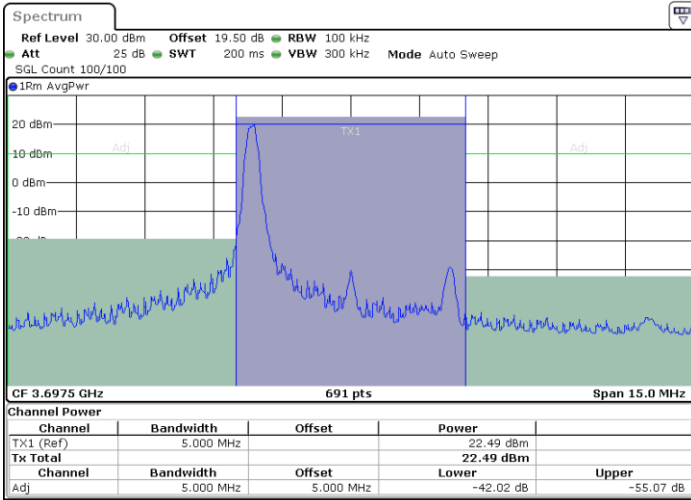

Date: 20.DEC.2021 08:02:19

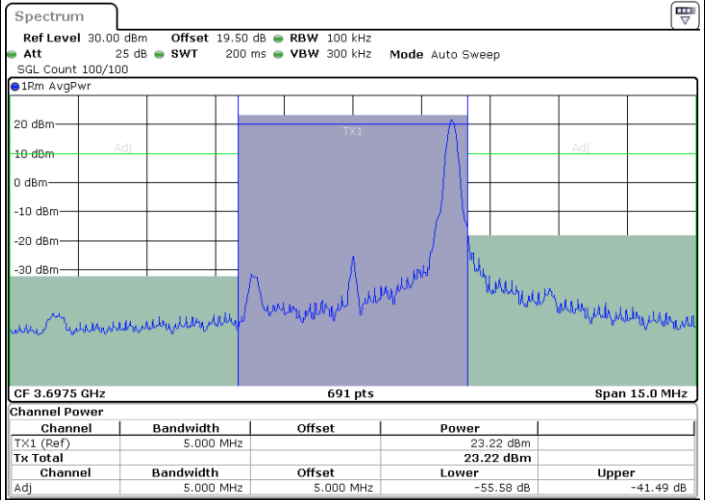

Date: 20.DEC.2021 08:14:33

Highest Channel / Full RB

N/A

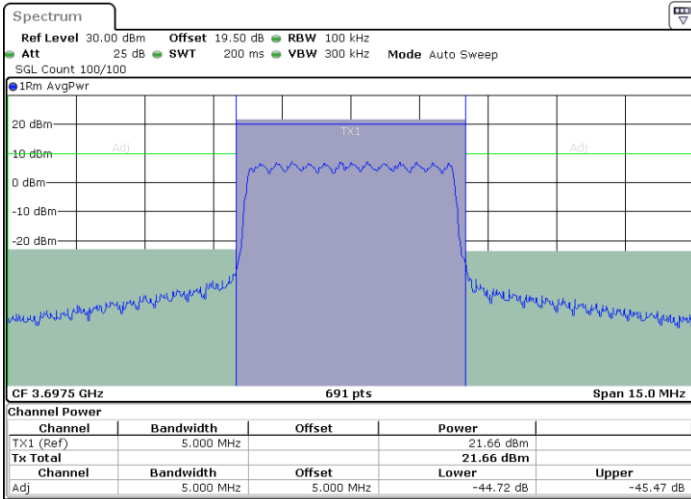

Date: 20.DEC.2021 08:08:26

Blank



LTE Band 48 / 10MHz

16QAM

Lowest Channel / 1RB0

Lowest Channel / 1RBmax

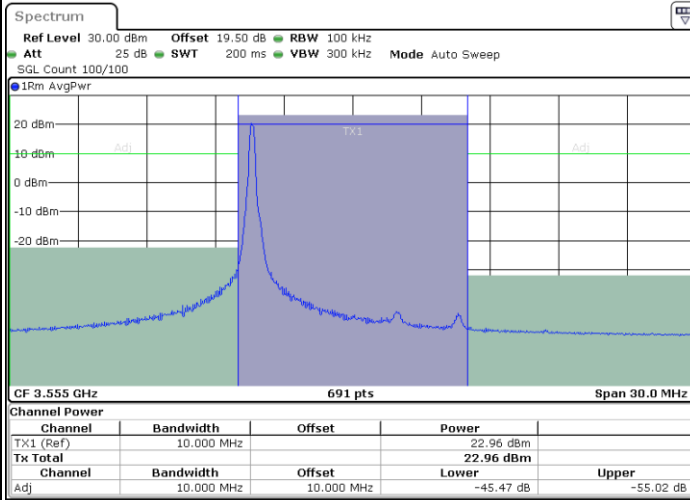

Date: 20.DEC.2021 08:16:37

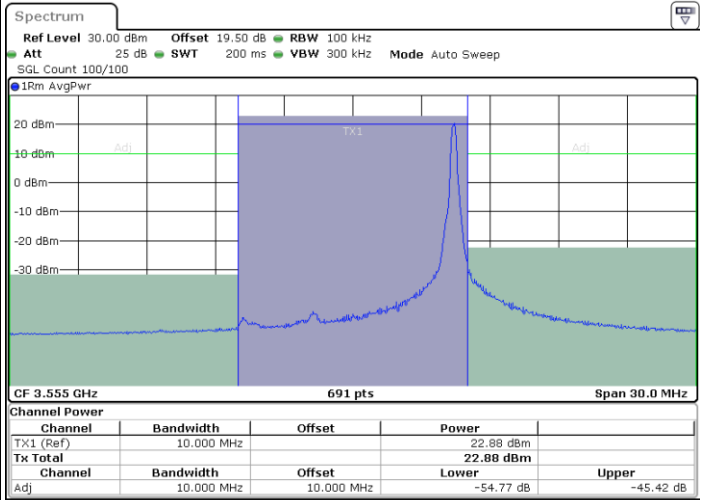

Date: 20.DEC.2021 08:28:55

Lowest Channel / Full RB

N/A

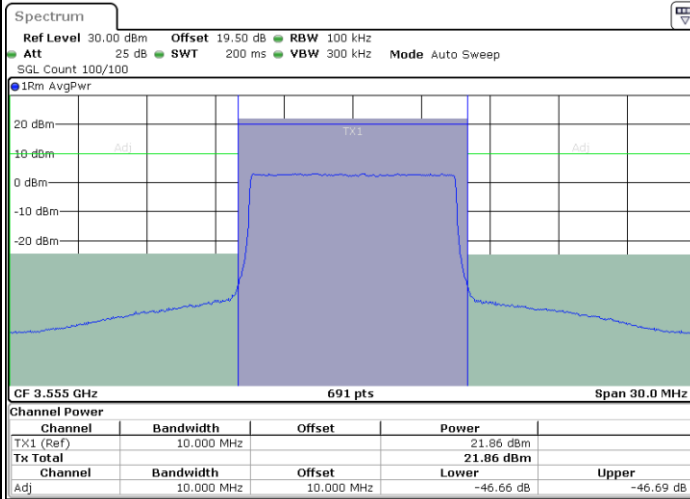

Date: 20.DEC.2021 08:22:46

Blank



LTE Band 48 / 10MHz

16QAM

MiddleChannel / 1RB0

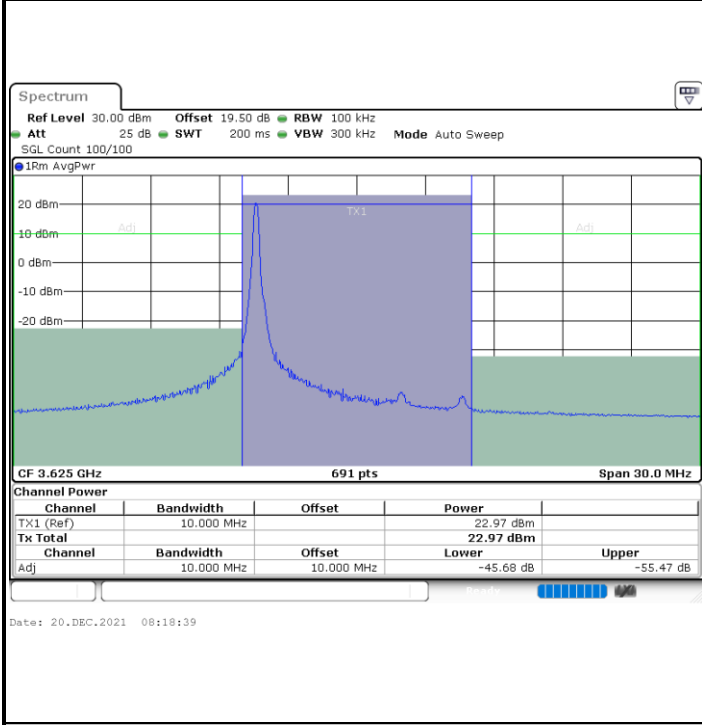

Middle Channel / 1RBmax

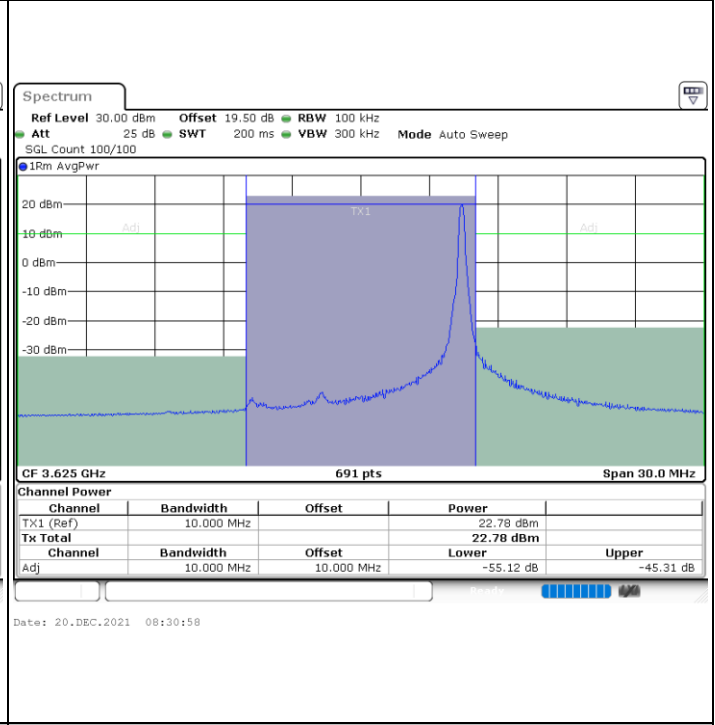

Middle Channel / Full RB

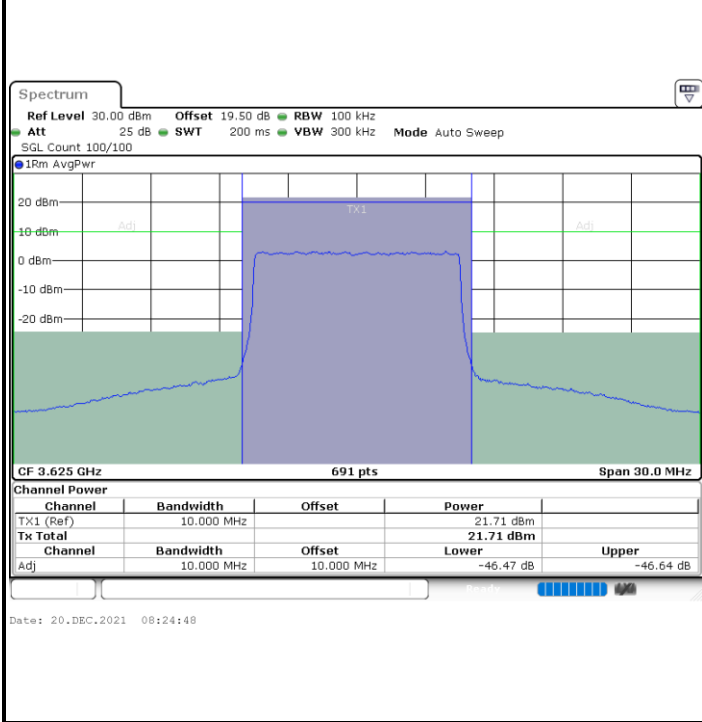

N/A

Blank



LTE Band 48 / 10MHz

16QAM

Highest Channel / 1RB0

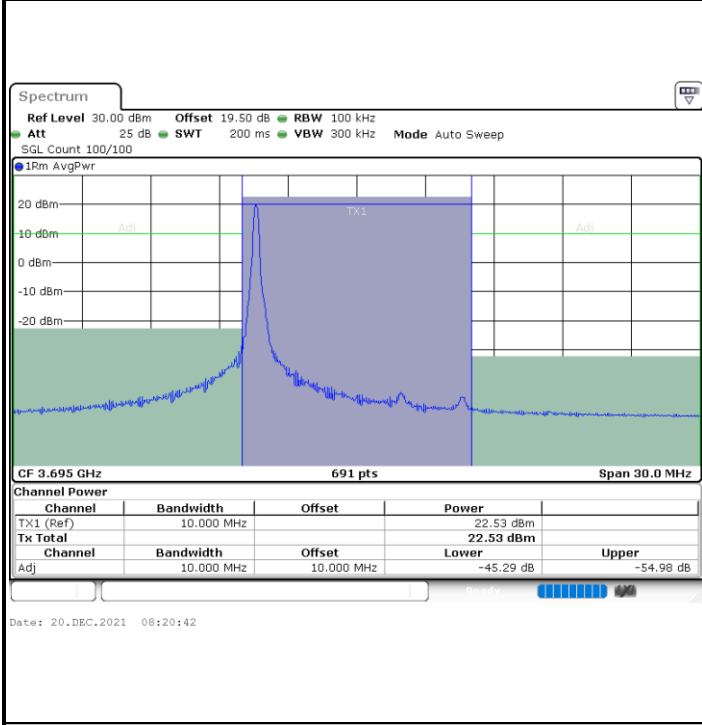

Highest Channel / 1RBmax

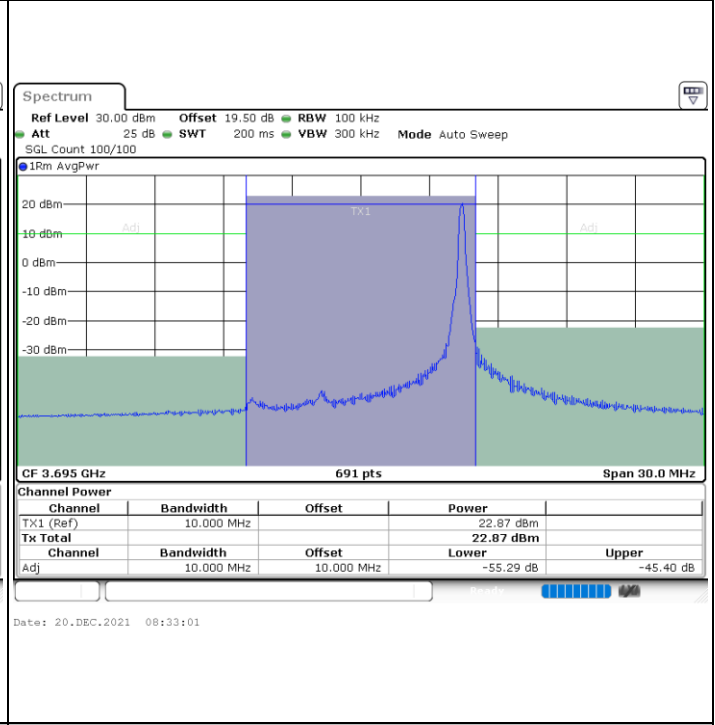

Highest Channel / Full RB

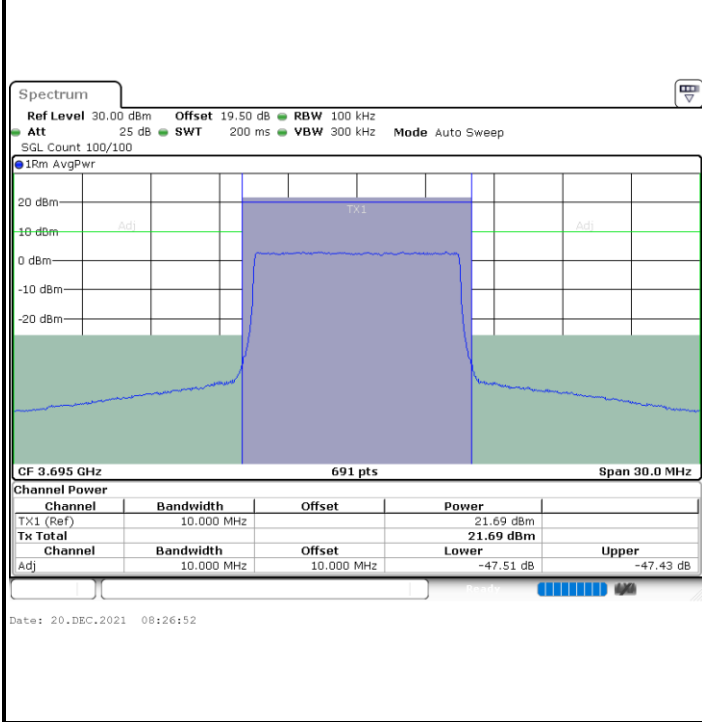

N/A

Blank



LTE Band 48 / 15MHz

16QAM

Lowest Channel / 1RB0

Lowest Channel / 1RBmax

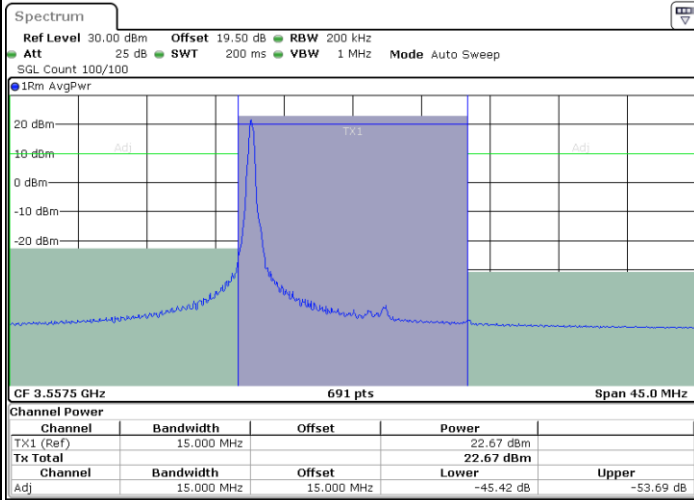

Date: 20.DEC.2021 08:35:05

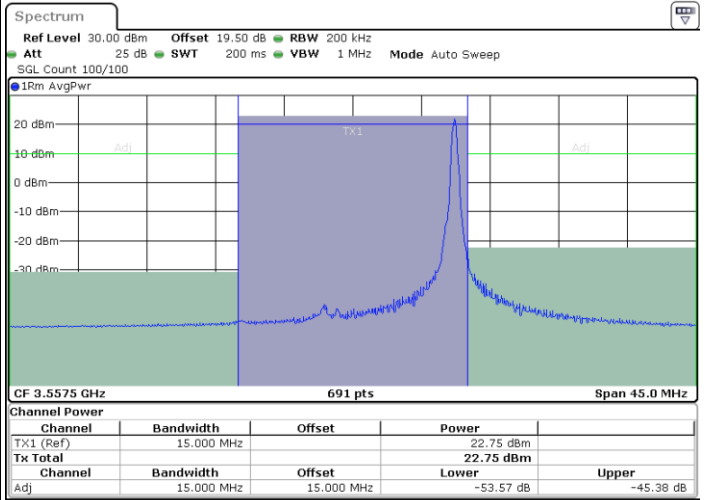

Date: 20.DEC.2021 09:56:20

Lowest Channel / Full RB

N/A

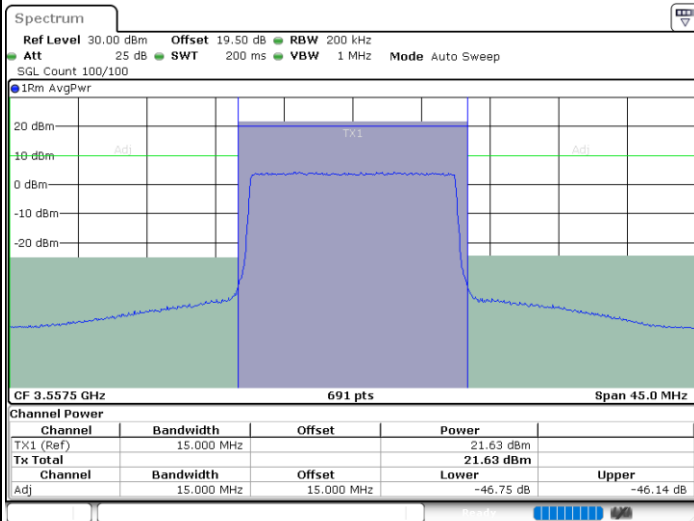

Date: 20.DEC.2021 08:41:16

Blank



LTE Band 48 / 15MHz

16QAM

Middle Channel / 1RB0

Middle Channel / 1RBmax

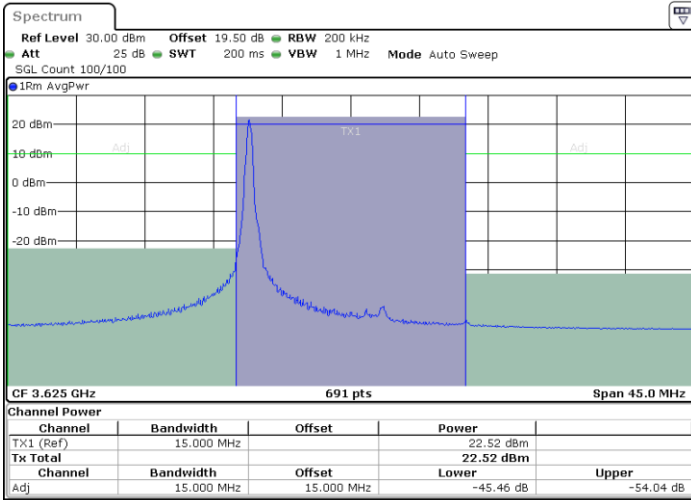

Date: 20.DEC.2021 08:37:08

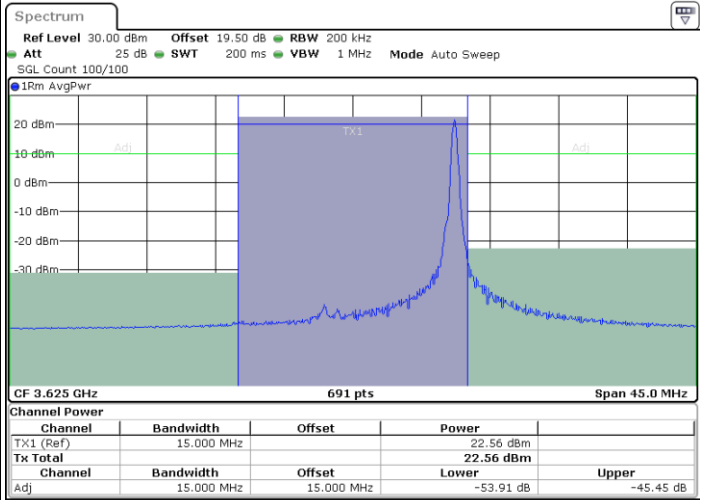

Date: 20.DEC.2021 09:58:21

Middle Channel / Full RB

N/A

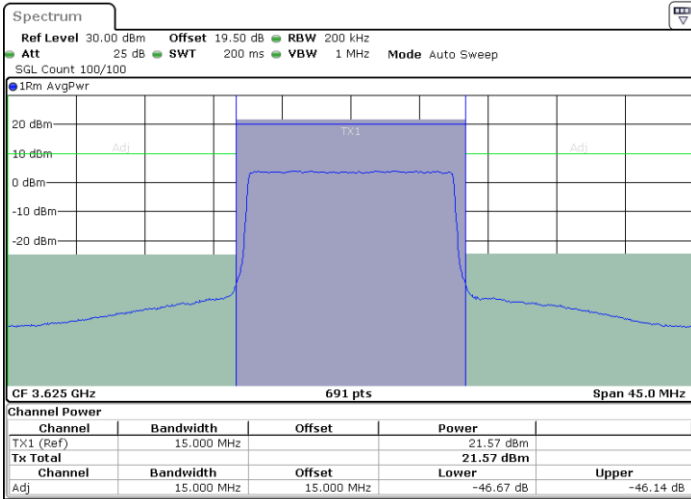

Date: 20.DEC.2021 08:44:48

Blank



LTE Band 48 / 15MHz

16QAM

Highest Channel / 1RB0

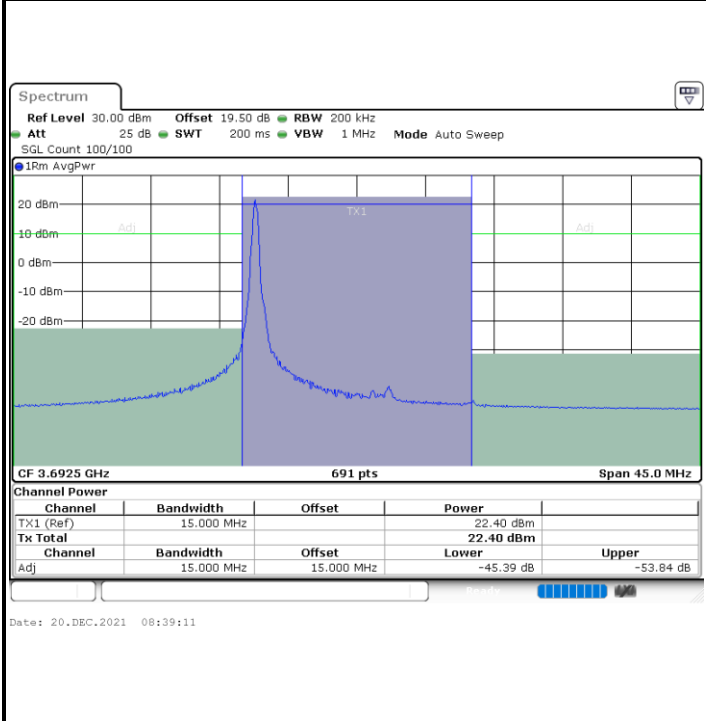

Highest Channel / 1RBmax

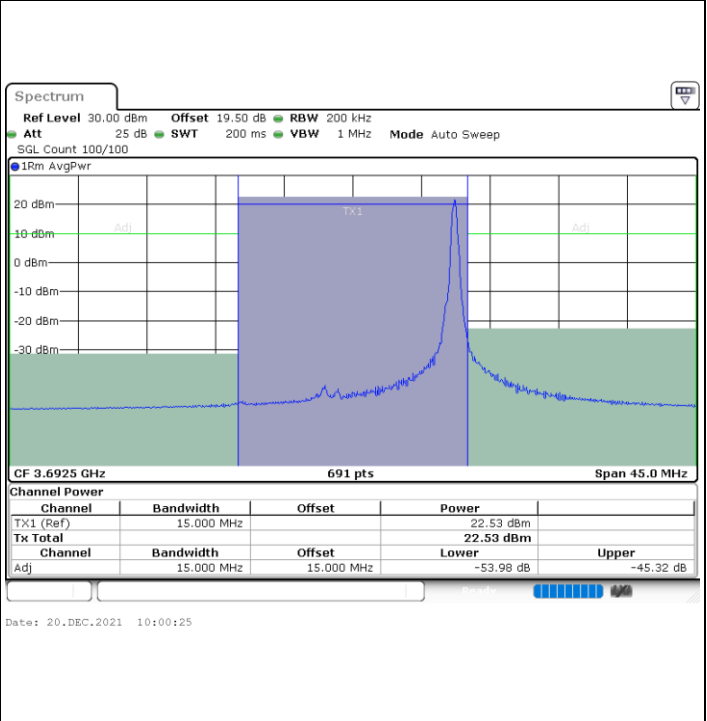

Highest Channel / Full RB

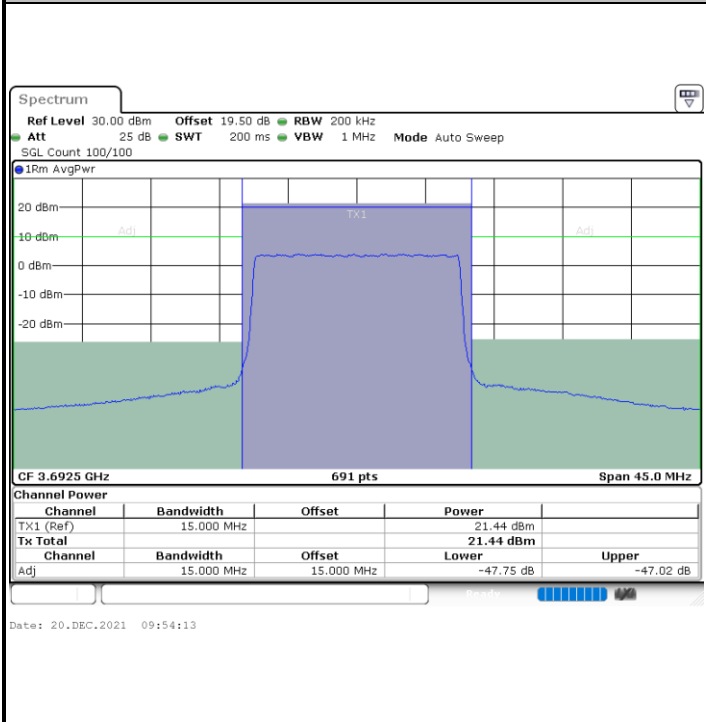

N/A

Blank



LTE Band 48 / 20MHz

16QAM

Lowest Channel / 1RB0

Lowest Channel / 1RBmax

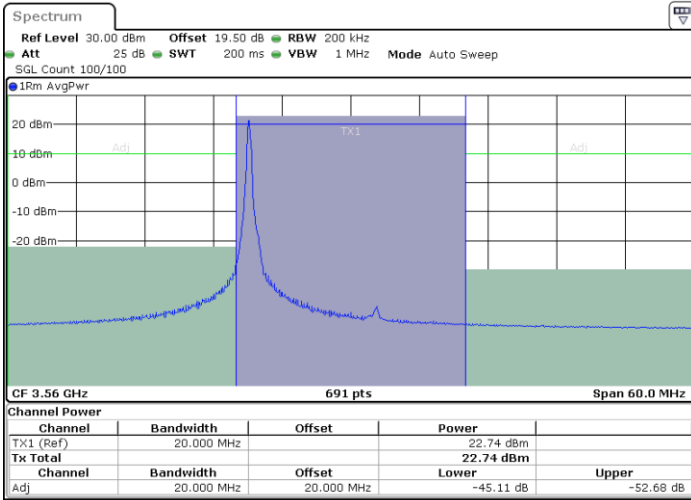

Date: 20.DEC.2021 10:08:30

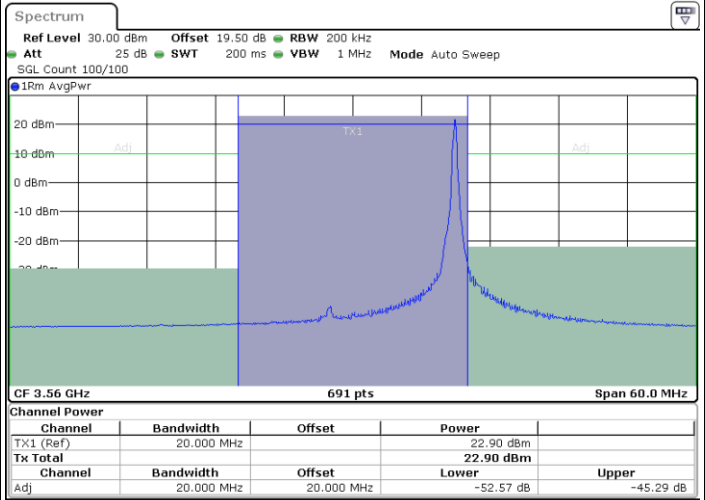

Date: 20.DEC.2021 10:14:30

Lowest Channel / Full RB

N/A

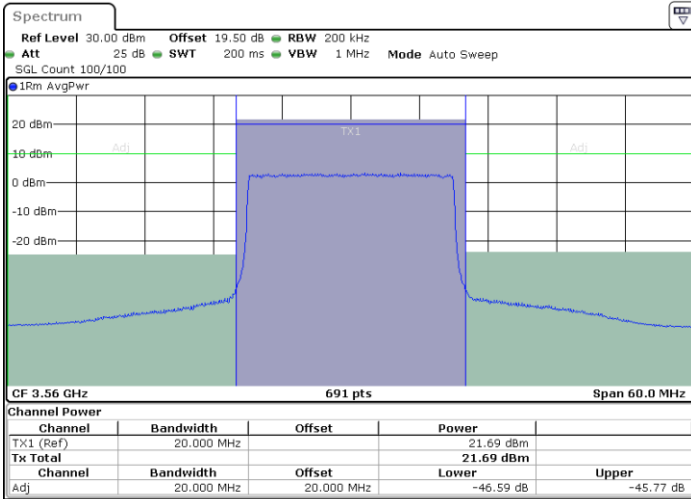

Date: 20.DEC.2021 10:02:28

Blank



LTE Band 48 / 20MHz

16QAM

Middle Channel / 1RB0

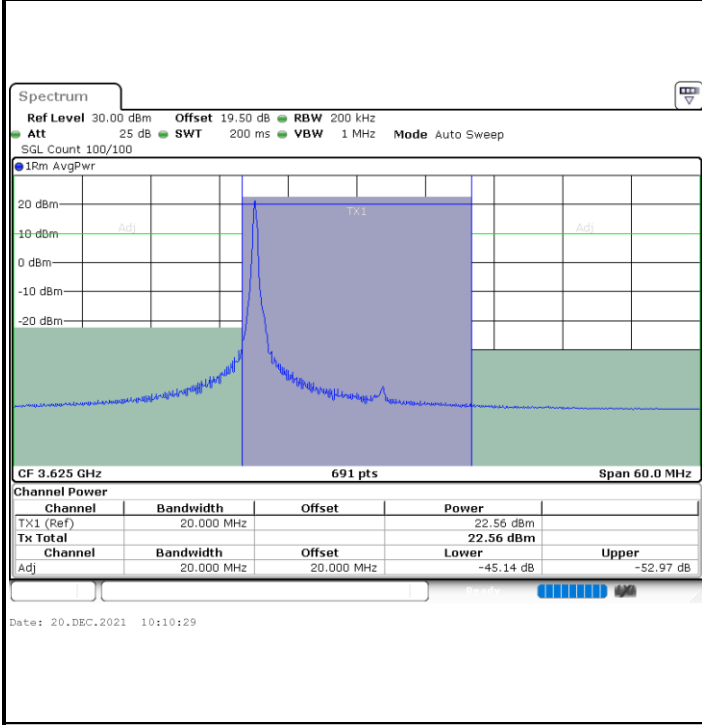

Middle Channel / 1RBmax

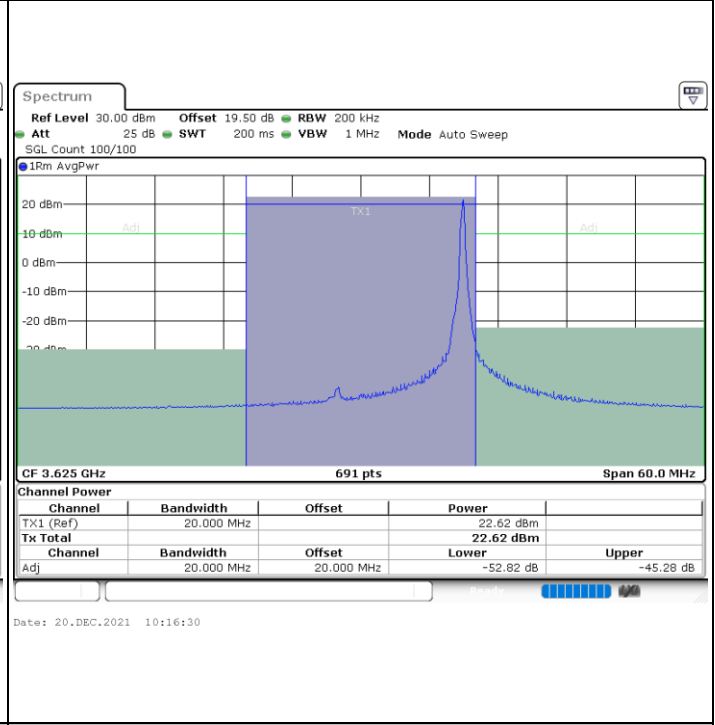

Middle Channel / Full RB

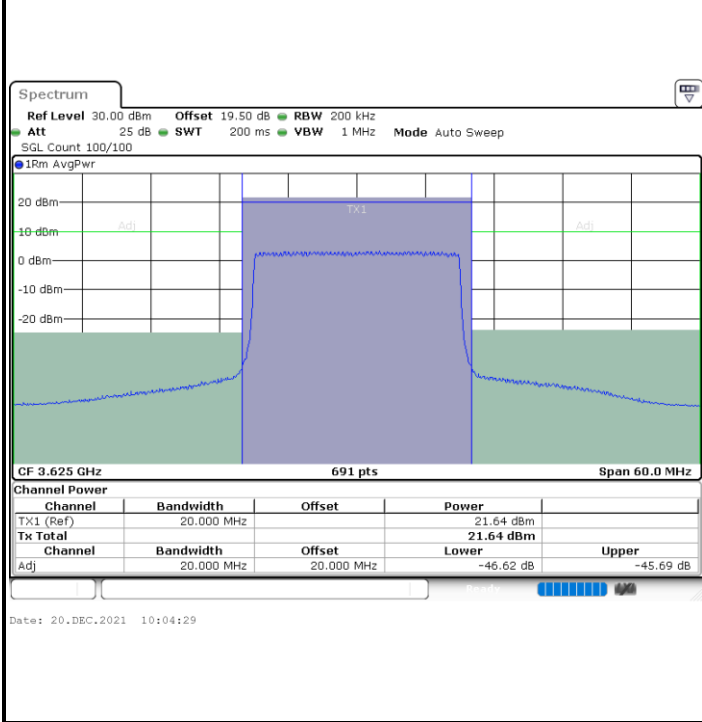

N/A

Blank



LTE Band 48 / 20MHz

16QAM

Highest Channel / 1RB0

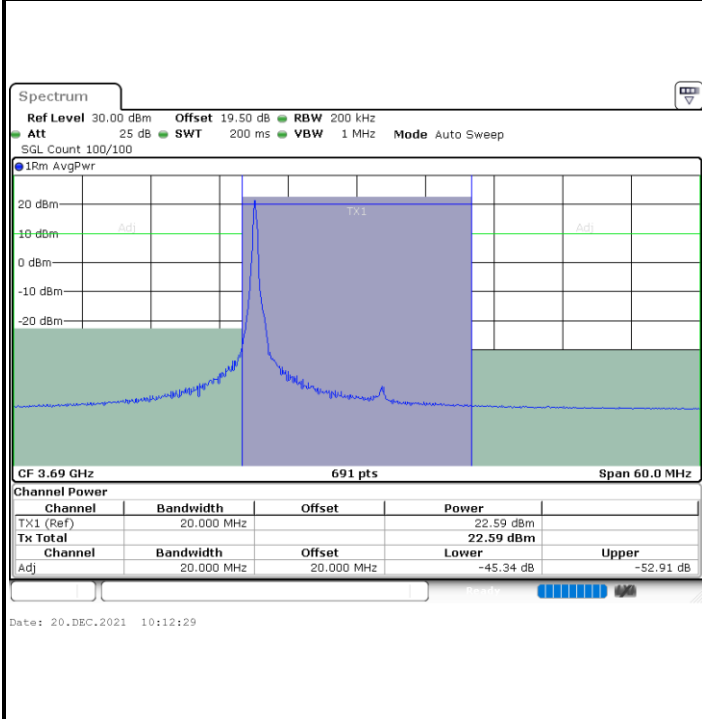

Highest Channel / 1RBmax

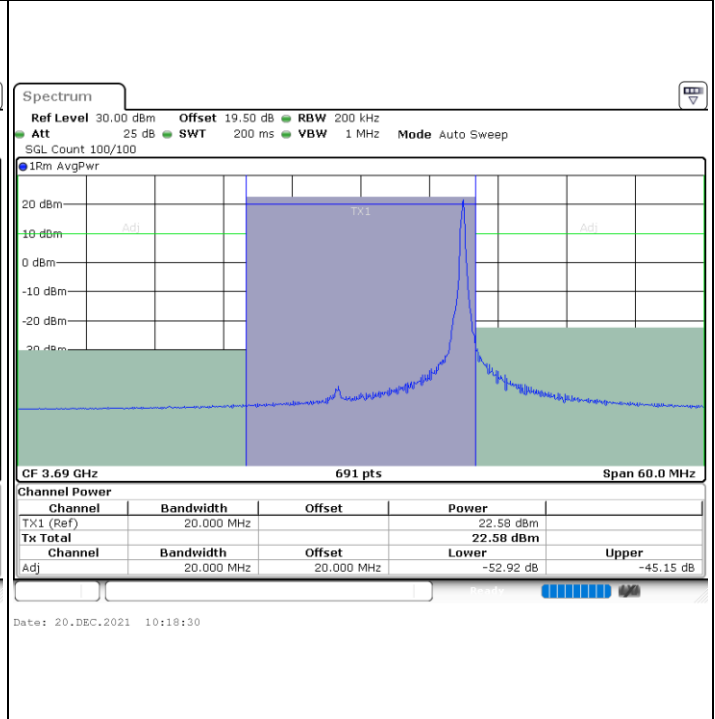

Highest Channel / Full RB

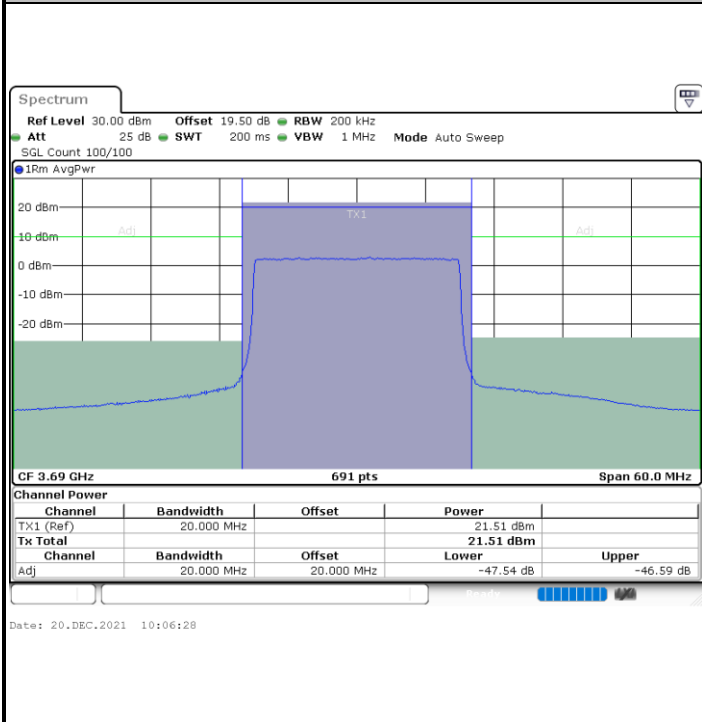

N/A

Blank



LTE Band 48 / 5MHz

64QAM

Lowest Channel / 1RB0

Lowest Channel / 1RBmax

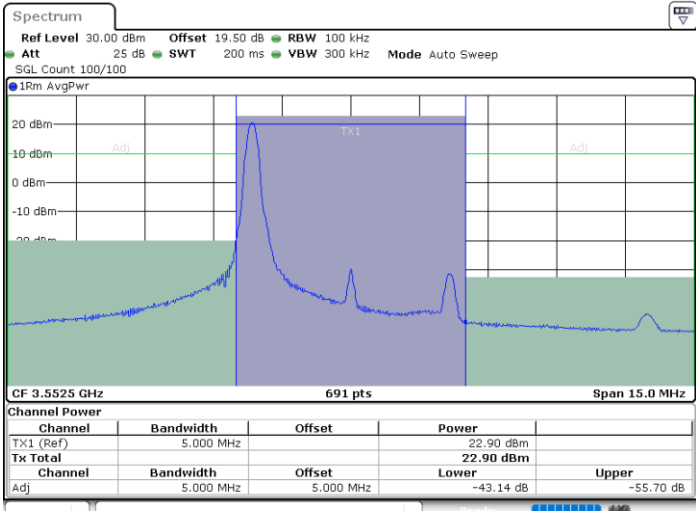

Date: 20.DEC.2021 07:58:56

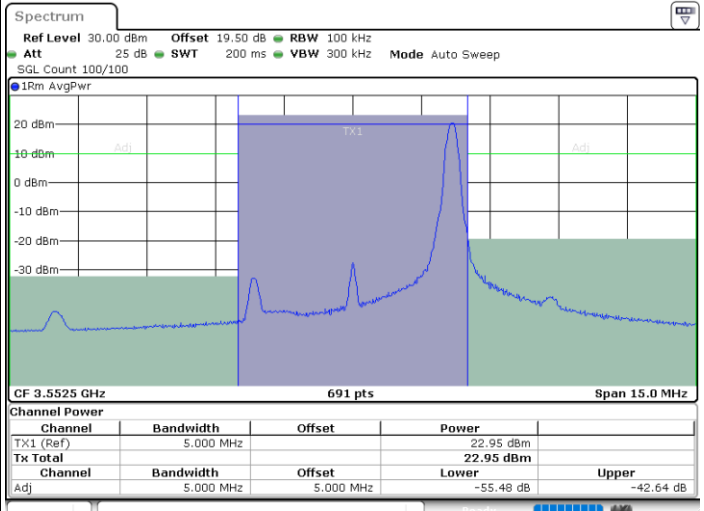

Date: 20.DEC.2021 08:11:10

Lowest Channel / Full RB

N/A

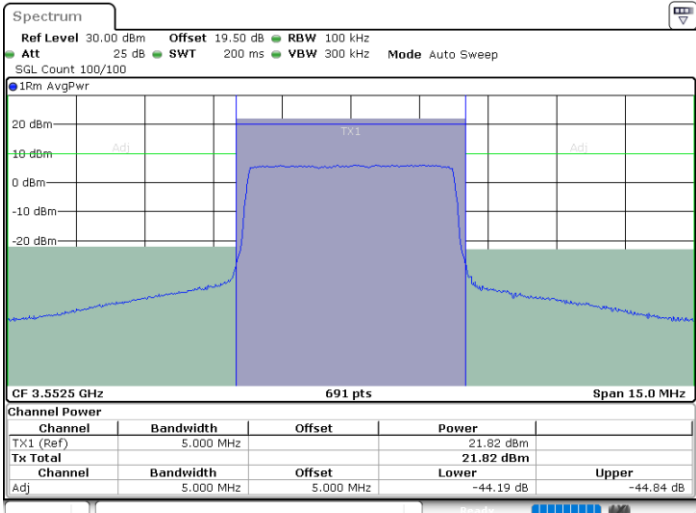

Date: 20.DEC.2021 08:05:03

Blank



LTE Band 48 / 5MHz

64QAM

Middle Channel / 1RB0

Middle Channel / 1RBmax

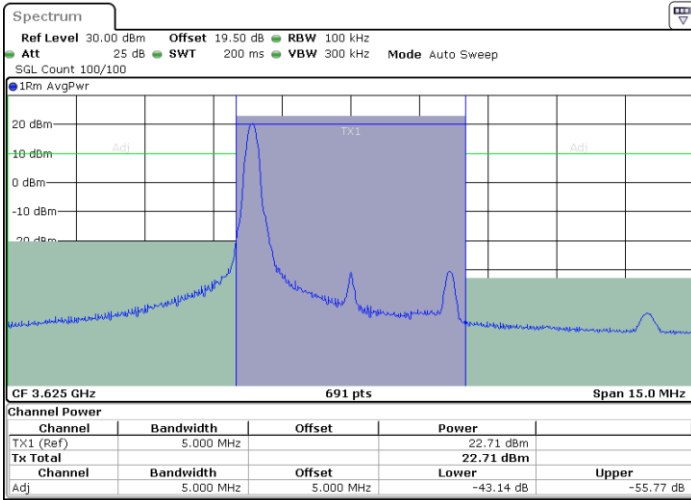

Date: 20.DEC.2021 07:59:36

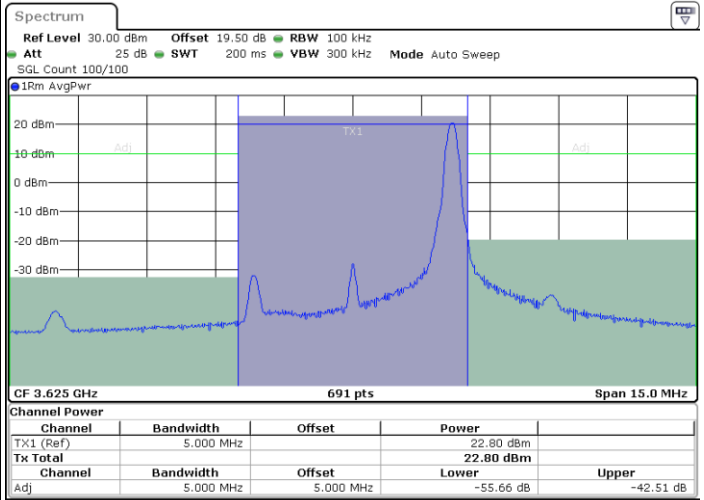

Date: 20.DEC.2021 08:11:50

Middle Channel / Full RB

N/A

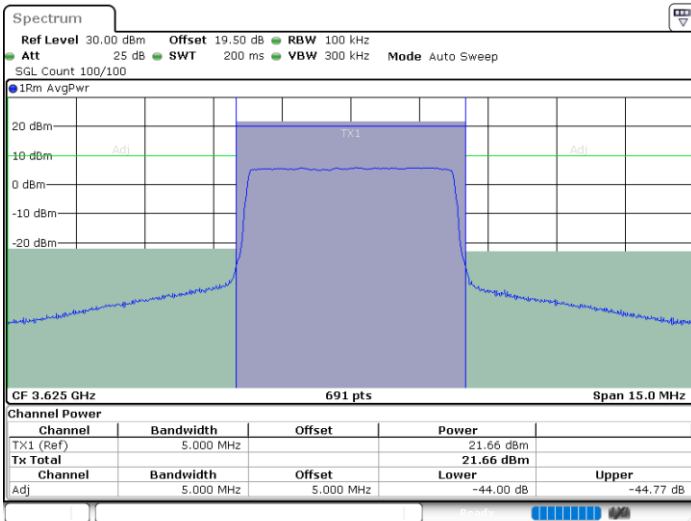

Date: 20.DEC.2021 08:05:43

Blank



LTE Band 48 / 5MHz

64QAM

Highest Channel / 1RB0

Highest Channel / 1RBmax

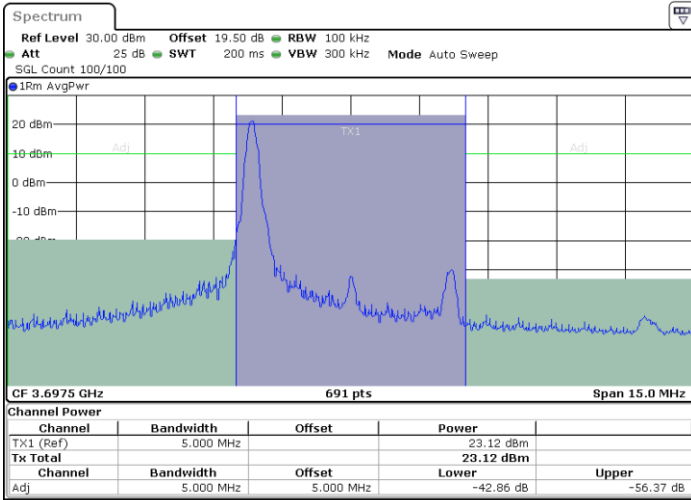

Date: 20.DEC.2021 08:03:01

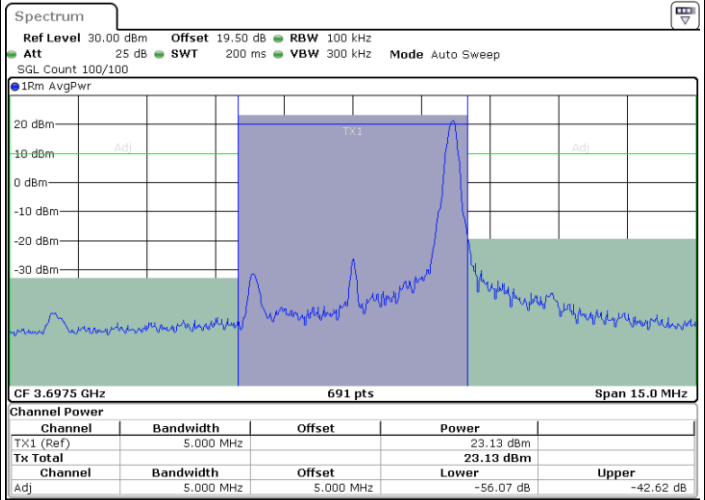

Date: 20.DEC.2021 08:15:15

Highest Channel / Full RB

N/A

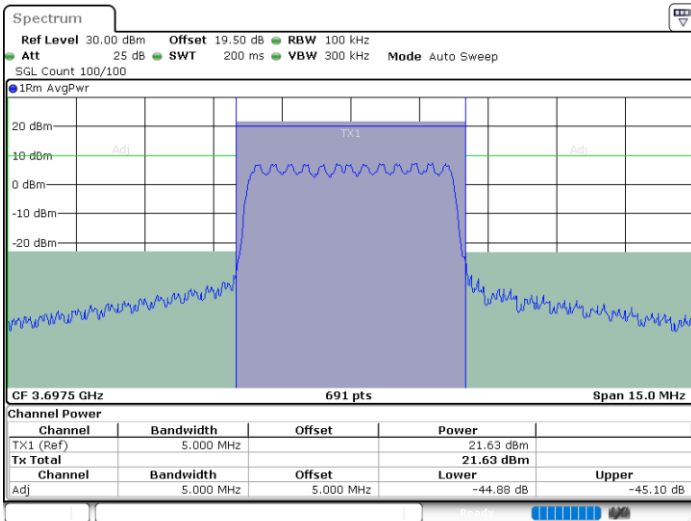

Date: 20.DEC.2021 08:09:08

Blank



LTE Band 48 / 10MHz

64QAM

Lowest Channel / 1RB0

Lowest Channel / 1RBmax

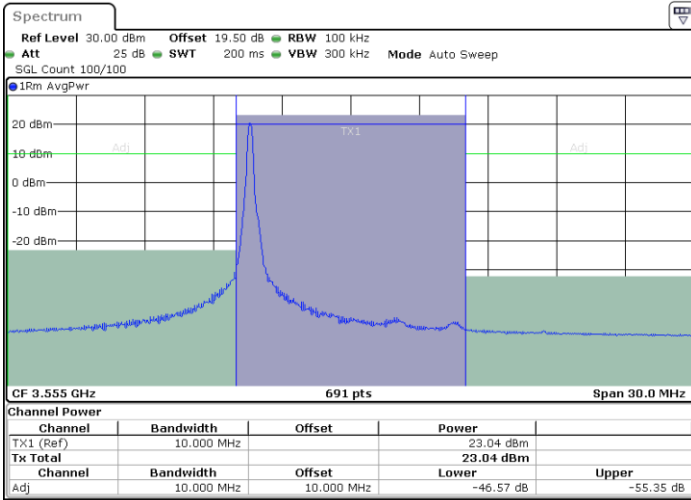

Date: 20.DEC.2021 08:15:56

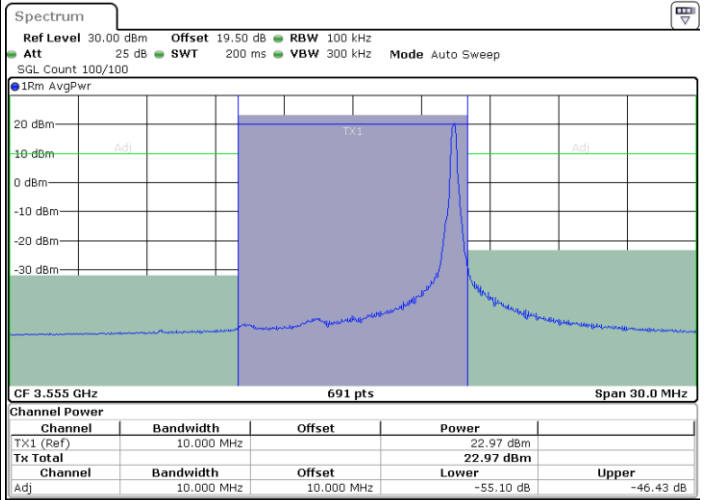

Date: 20.DEC.2021 08:28:15

Lowest Channel / Full RB

N/A

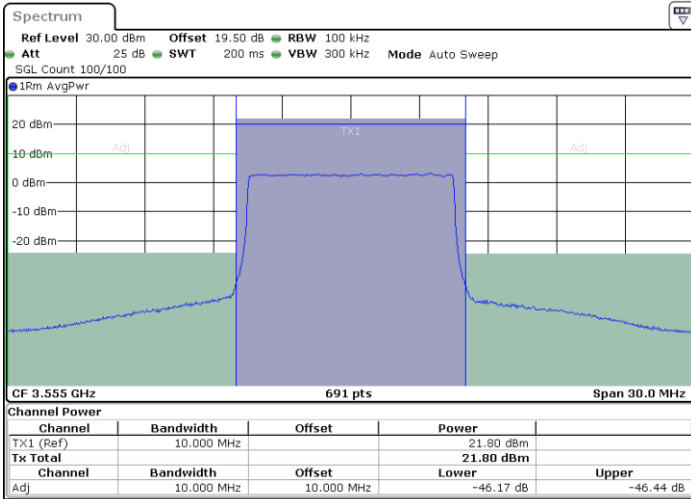

Date: 20.DEC.2021 08:22:05

Blank



LTE Band 48 / 10MHz

64QAM

MiddleChannel / 1RB0

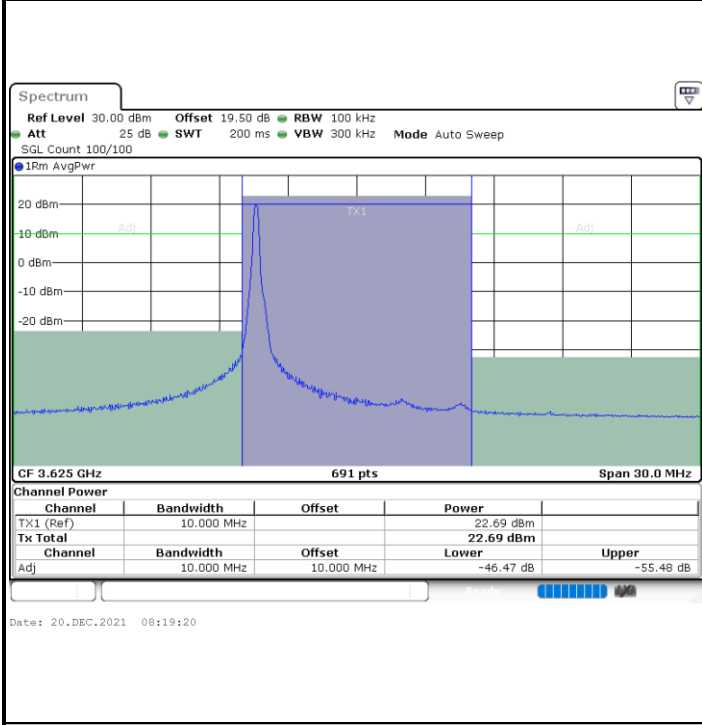

Middle Channel / 1RBmax

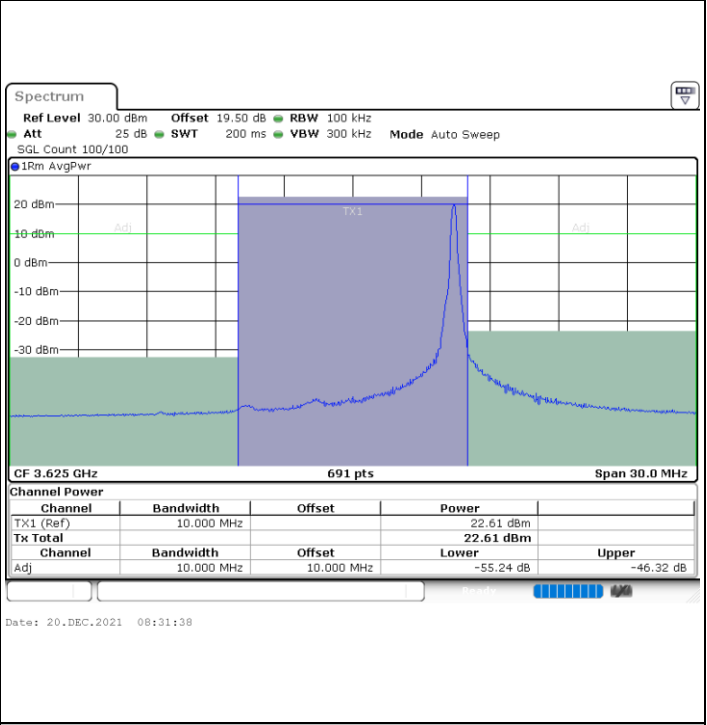

Middle Channel / Full RB

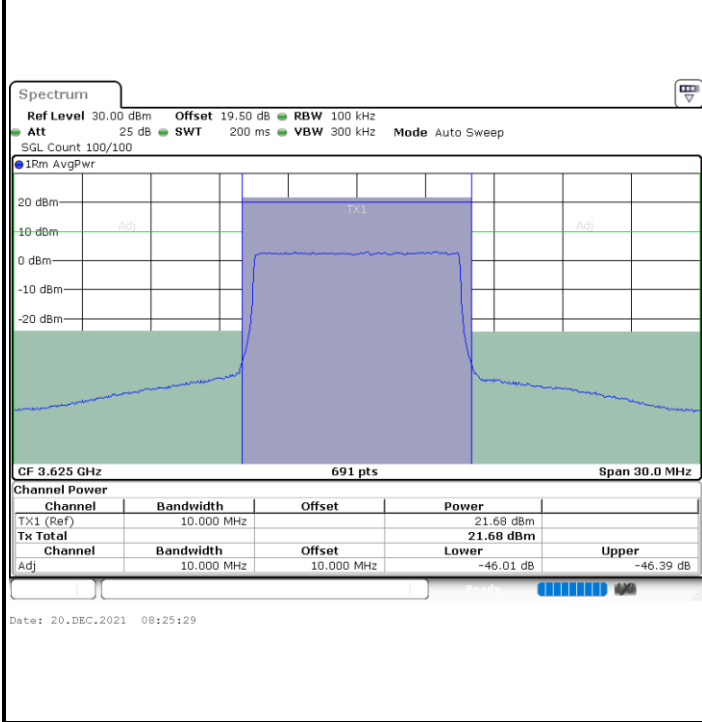

N/A

Blank



LTE Band 48 / 10MHz

64QAM

Highest Channel / 1RB0

Highest Channel / 1RBmax

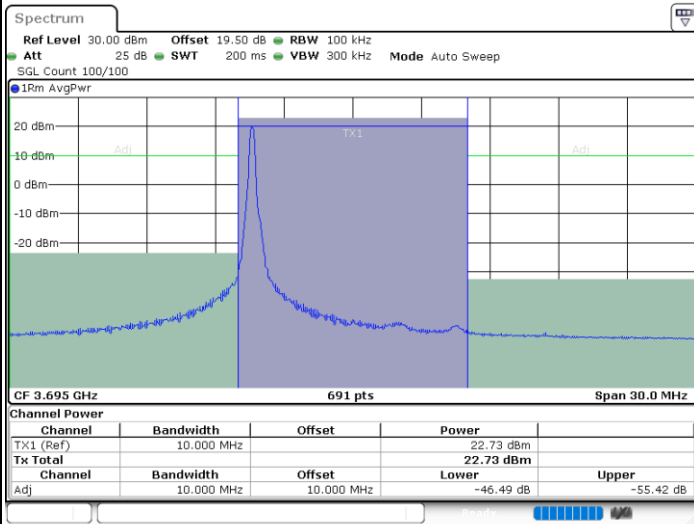

Date: 20.DEC.2021 08:20:01

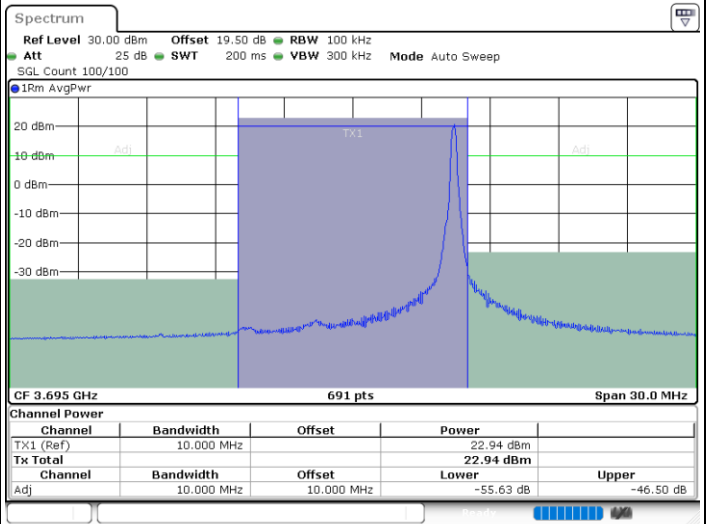

Date: 20.DEC.2021 08:32:19

Highest Channel / Full RB

N/A

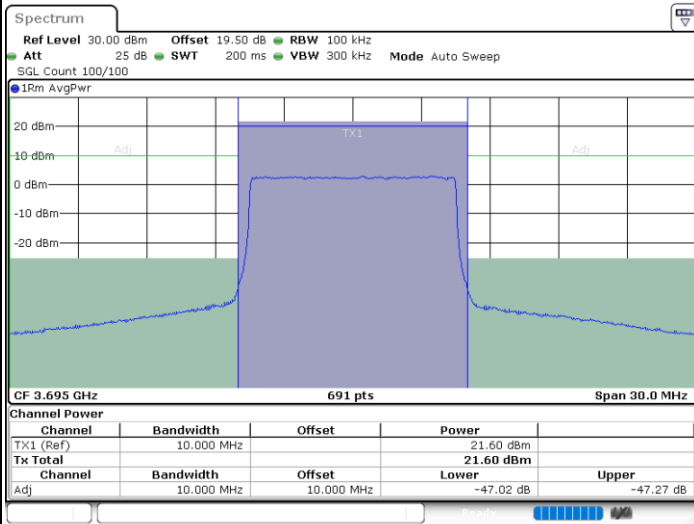

Date: 20.DEC.2021 08:26:10

Blank



LTE Band 48 / 15MHz

64QAM

Lowest Channel / 1RB0

Lowest Channel / 1RBmax

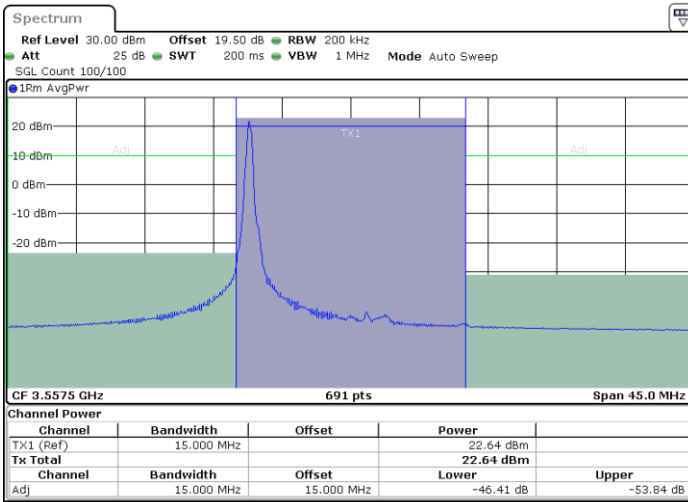

Date: 20.DEC.2021 08:35:46

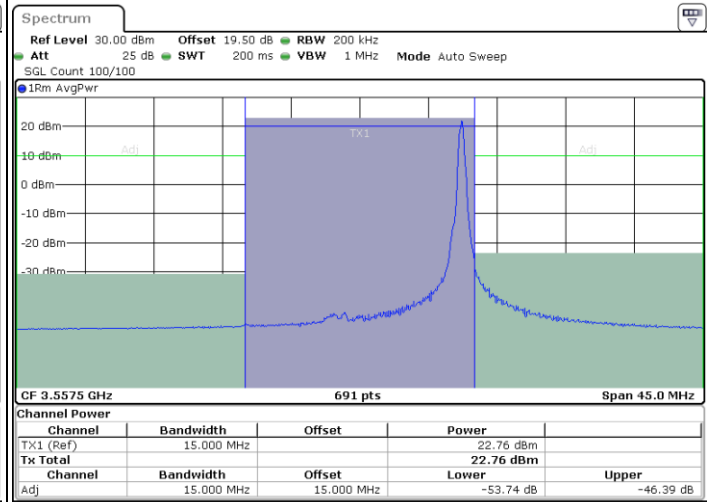

Date: 20.DEC.2021 09:57:01

Lowest Channel / Full RB

N/A

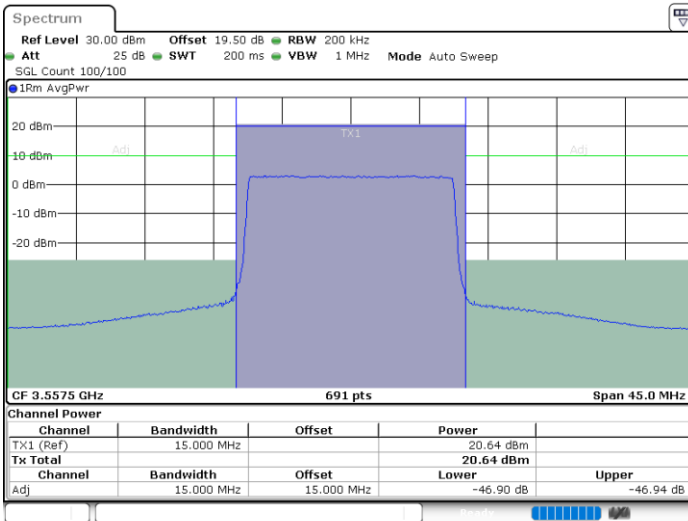

Date: 20.DEC.2021 10:23:35

Blank



LTE Band 48 / 15MHz

64QAM

Middle Channel / 1RB0

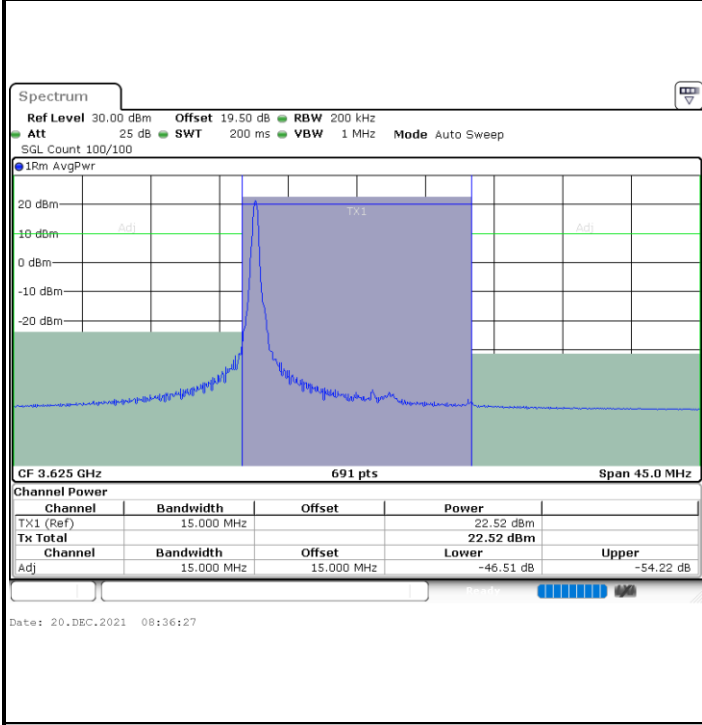

Middle Channel / 1RBmax

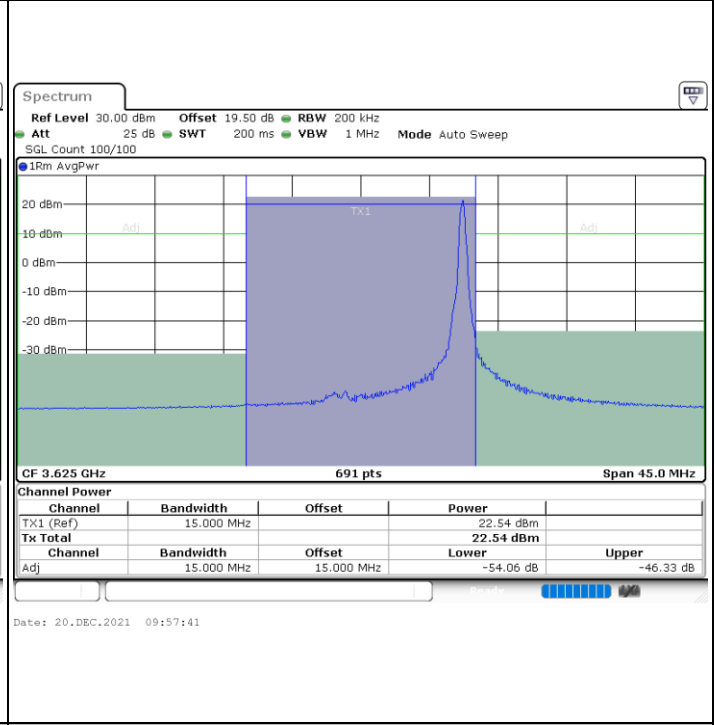

Middle Channel / Full RB

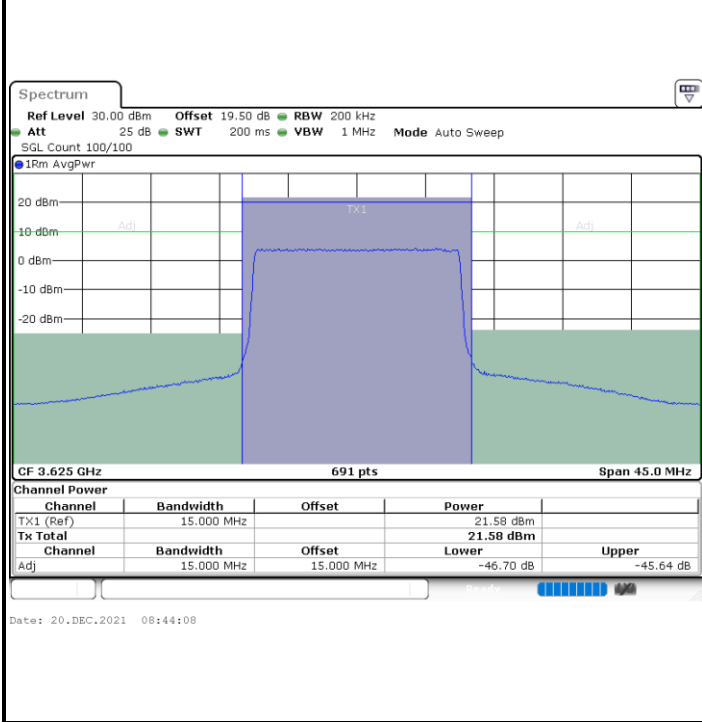

N/A

Blank