



FCC RF Test Report

APPLICANT : Motorola Mobility LLC
EQUIPMENT : Mobile Cellular Phone
BRAND NAME : Motorola
MODEL NAME : XT2213-1, XT2213DL, XT2213-2, XT2213-3
FCC ID : IHDT56AA3
STANDARD : 47 CFR Part 2, 27(M), 27(H), 27(F), 27(N)
CLASSIFICATION : PCS Licensed Transmitter Held to Ear (PCE)
TEST DATE(S) : Dec. 26, 2021 ~ Jan. 20, 2022

We, Sporton International Inc. (Kunshan), would like to declare that the tested sample has been evaluated in accordance with the procedures given in ANSI C63.26-2015 and shown compliance with the applicable technical standards.

The test results in this report apply exclusively to the tested model / sample. Without written approval of Sporton International Inc. (Kunshan), the test report shall not be reproduced except in full.

Jason Jia

Reviewed by: Jason Jia / Supervisor

Alex Wang

Approved by: Alex Wang / Manager



Sporton International Inc. (Kunshan)

**No. 1098, Pengxi North Road, Kunshan Economic Development Zone Jiangsu Province 215300
People's Republic of China**



TABLE OF CONTENTS

REVISION HISTORY... 3
SUMMARY OF TEST RESULT ... 4
1 GENERAL DESCRIPTION ... 5
1.1 Applicant ... 5
1.2 Manufacturer ... 5
1.3 Product Feature of Equipment Under Test ... 5
1.4 Product Specification of Equipment Under Test ... 5
1.5 Specification of Accessory ... 6
1.6 Modification of EUT ... 7
1.7 Maximum ERP/EIRP and Emission Designator ... 7
1.8 Testing Location ... 8
1.9 Test Software ... 8
1.10 Applicable Standards ... 8
2 TEST CONFIGURATION OF EQUIPMENT UNDER TEST ... 10
2.1 Test Mode ... 10
2.2 Connection Diagram of Test System ... 12
2.3 Support Unit used in test configuration and system ... 13
2.4 Measurement Results Explanation Example ... 13
2.5 Frequency List of Low/Middle/High Channels ... 14
3 CONDUCTED TEST ITEMS ... 18
3.1 Measuring Instruments ... 18
3.2 Test Setup ... 18
3.3 Test Result of Conducted Test ... 18
3.4 Conducted Output Power and ERP/EIRP ... 19
3.5 Peak-to-Average Ratio ... 20
3.6 Occupied Bandwidth ... 21
3.7 Conducted Band Edge ... 22
3.8 Conducted Spurious Emission ... 24
3.9 Frequency Stability ... 25
4 RADIATED TEST ITEMS ... 26
4.1 Measuring Instruments ... 26
4.2 Test Setup ... 26
4.3 Test Result of Radiated Test ... 27
4.4 Radiated Spurious Emission ... 28
5 LIST OF MEASURING EQUIPMENT ... 29
6 UNCERTAINTY OF EVALUATION ... 30
APPENDIX A. TEST RESULTS OF CONDUCTED TEST
APPENDIX B. TEST RESULTS OF RADIATED TEST
APPENDIX C. TEST SETUP PHOTOGRAPHS



REVISION HISTORY

| REPORT NO. | VERSION | DESCRIPTION | ISSUED DATE |
|------------|---------|-------------------------|---------------|
| FG1D1722C | Rev. 01 | Initial issue of report | Feb. 08, 2022 |
| | | | |
| | | | |
| | | | |
| | | | |
| | | | |
| | | | |
| | | | |
| | | | |
| | | | |
| | | | |
| | | | |
| | | | |
| | | | |
| | | | |
| | | | |
| | | | |
| | | | |
| | | | |
| | | | |
| | | | |



SUMMARY OF TEST RESULT

| Report Section | FCC Rule | Description | Limit | Result | Remark |
|----------------|---|---|-------------------------------------|-------------|---|
| 3.4 | §2.1046 | Conducted Output Power | - | Report Only | - |
| | §27.50(b)(10) §27.50(c)(10) | Effective Radiated Power (Band 12) (Band 13) (Band 17) (Band 71) | ERP < 3 Watt | PASS | - |
| | §27.50(h)(2) | Equivalent Isotropic Radiated Power (Band 7) (Band 38) (Band 41) | EIRP < 2Watt | | - |
| 3.5 | N/A | Peak-to-Average Ratio | <13 dB | PASS | - |
| 3.6 | §2.1049 | Occupied Bandwidth | - | Report Only | - |
| 3.7 | §2.1051 §27.53(c)(2)(4) §27.53(g) | Conducted Band Edge Measurement (Band 12) (Band 13) (Band 17) (Band 71) | < 43+10log ₁₀ (P[Watts]) | PASS | - |
| | §27.53(m)(4) | Conducted Band Edge Measurement (Band 7) (Band 38) (Band 41) | §27.53(m)(4) | | |
| 3.8 | §2.1051 §27.53(c)(2) §27.53(g) | Conducted Spurious Emission (Band 12) (Band 13) (Band 17) (Band 71) | < 43+10log ₁₀ (P[Watts]) | PASS | - |
| | §2.1051 §27.53(m)(4) | Conducted Spurious Emission (Band 7) (Band 38) (Band 41) | < 55+10log ₁₀ (P[Watts]) | | |
| 3.9 | §2.1055 §27.54 | Frequency Stability Temperature & Voltage | Within Authorized Band | PASS | - |
| 4.4 | §2.1053 §27.53(c)(2) §27.53(f) §27.53(g) | Radiated Spurious Emission (Band 12) (Band 13) (Band 17) (Band 71) | < 43+10log ₁₀ (P[Watts]) | PASS | Under limit 4.91 dB at 7260.00 MHz |
| | §2.1053 §27.53(m)(4) | Radiated Spurious Emission (Band 7) (Band 38) (Band 41) | < 55+10log ₁₀ (P[Watts]) | | |

Declaration of Conformity:

The test results with all measurement uncertainty excluded are presented in accordance with the regulation limits or requirements declared by manufacturers.

Comments and Explanations:

The declared of product specification for EUT presented in the report are provided by the manufacturer, and the manufacturer takes all the responsibilities for the accuracy of product specification.



1 General Description

1.1 Applicant

Motorola Mobility LLC
222 W,Merchandise Mart Plaza, Chicago IL 60654 USA

1.2 Manufacturer

Motorola Mobility LLC
222 W,Merchandise Mart Plaza, Chicago IL 60654 USA

1.3 Product Feature of Equipment Under Test

| Product Feature | |
|-----------------|--|
| Equipment | Mobile Cellular Phone |
| Brand Name | Motorola |
| Model Name | XT2213-1, XT2213DL, XT2213-2, XT2213-3 |
| FCC ID | IHDT56AA3 |
| IMEI Code | Conducted: 353739480009600 Radiation: 353739480012232 |
| HW Version | DVT2 |
| SW Version | S1SA32.27 |
| EUT Stage | Identical Prototype |

Remark: The four models XT2213-1, XT2213DL, XT2213-2 and XT2213-3 are only for market differentiation, all the others are the same.

1.4 Product Specification of Equipment Under Test

| Standards-related Product Specification | |
|---|---|
| Tx Frequency | LTE Band 7 : 2500 MHz ~ 2570 MHz LTE Band 12 : 699 MHz ~ 716 MHz LTE Band 13 : 777 MHz ~ 787 MHz LTE Band 17 : 704 MHz ~ 716 MHz LTE Band 38 : 2570 MHz ~ 2620 MHz LTE Band 41 : 2496 MHz ~ 2690 MHz LTE Band 71: 663 MHz ~ 698 MHz |
| Rx Frequency | LTE Band 7 : 2620 MHz ~ 2690 MHz LTE Band 12 : 729 MHz ~ 746 MHz LTE Band 13 : 746 MHz ~ 756 MHz LTE Band 17 : 734 MHz ~ 746 MHz LTE Band 38: 2570 MHz ~ 2620 MHz LTE Band 41 : 2496 MHz ~ 2690 MHz LTE Band 71: 617 MHz ~ 652 MHz |
| Bandwidth | LTE Band 7 : 5MHz/ 10MHz / 15MHz / 20MHz LTE Band 12 : 1.4MHz / 3MHz / 5MHz / 10MHz LTE Band 13 : 5MHz / 10MHz |



| | |
|--|---|
| | LTE Band 17 : 5MHz / 10MHz LTE Band 38 : 5MHz / 10MHz / 15MHz / 20MHz LTE Band 41 : 5MHz / 10MHz / 15MHz / 20MHz LTE Band 71 : 5MHz / 10MHz / 15MHz / 20MHz |
| Maximum Output Power to Antenna | <Ant. 0> LTE Band 7 : 22.62 dBm LTE Band 12 : 22.84 dBm LTE Band 13 : 22.84 dBm LTE Band 17 : 22.80 dBm LTE Band 38 : 22.64 dBm LTE Band 41 : 25.66 dBm LTE Band 41C : 22.61 dBm LTE Band 71 : 23.01 dBm <Ant. 1> LTE Band 13 : 23.07 dBm |
| Antenna Gain | <Ant. 0> LTE Band 7 : -2.1 dBi LTE Band 12 : -3.4 dBi LTE Band 13 : -3.0 dBi LTE Band 17 : -3.4 dBi LTE Band 38 : -2.1 dBi LTE Band 41 : -2.1 dBi LTE Band 71 : -3.2 dBi <Ant. 1> LTE Band 13 : -4.46 dBi |
| Type of Modulation | QPSK / 16QAM / 64QAM / 256QAM (Downlink only) |

Note:

1. The ERP is calculated from output power and antenna gain, so the maximum ERP is shown in the report for Antenna 0 of LTE Band 13.
2. LTE Band 41 supports HPUE mode.

1.5 Specification of Accessory

| Specification of Accessory | | | | |
|----------------------------|------------|---------------------|------------|------------|
| AC Adapter 1 | Brand Name | Motorola(Salcomp) | Model Name | MC-101 |
| AC Adapter 2 | Brand Name | Motorola(AOHAI) | Model Name | MC-101 |
| AC Adapter 3 | Brand Name | Motorola(Chenyang) | Model Name | MC-101 |
| Battery 1 | Brand Name | Motorola(SCUD) | Model Name | JK50 |
| Battery 2 | Brand Name | Motorola(ATL) | Model Name | JK50 |
| USB Cable 1 | Brand Name | Motorola(Saibao) | Model Name | SC18D22297 |
| USB Cable 2 | Brand Name | Motorola(Cabletech) | Model Name | SC18D22298 |
| USB Cable 3 | Brand Name | Motorola(Luxshare) | Model Name | SC18D22299 |



1.6 Modification of EUT

No modifications are made to the EUT during all test items.

1.7 Maximum ERP/EIRP and Emission Designator

| LTE Band 7 | | QPSK | | 16QAM/64QAM | |
|-------------|-----------------------|-----------------|------------------------------|-----------------|------------------------------|
| BW (MHz) | Frequency Range (MHz) | Maximum EIRP(W) | Emission Designator (99%OBW) | Maximum EIRP(W) | Emission Designator (99%OBW) |
| 20 | 2510.0 ~ 2560.0 | 0.1127 | 17M9G7D | 0.0931 | 17M9W7D |
| LTE Band 12 | | QPSK | | 16QAM/64QAM | |
| BW (MHz) | Frequency Range (MHz) | Maximum ERP(W) | Emission Designator (99%OBW) | Maximum ERP(W) | Emission Designator (99%OBW) |
| 10 | 704.0 ~ 711.0 | 0.0536 | 9M05G7D | 0.0440 | 9M01W7D |
| LTE Band 13 | | QPSK | | 16QAM/64QAM | |
| BW (MHz) | Frequency Range (MHz) | Maximum ERP(W) | Emission Designator (99%OBW) | Maximum ERP(W) | Emission Designator (99%OBW) |
| 10 | 782.0 | 0.0587 | 9M03G7D | 0.0492 | 8M97W7D |
| LTE Band 17 | | QPSK | | 16QAM/64QAM | |
| BW (MHz) | Frequency Range (MHz) | Maximum ERP(W) | Emission Designator (99%OBW) | Maximum ERP(W) | Emission Designator (99%OBW) |
| 10 | 709.0 ~ 711.0 | 0.0531 | 9M05G7D | 0.0440 | 9M01W7D |
| LTE Band 38 | | QPSK | | 16QAM/64QAM | |
| BW (MHz) | Frequency Range (MHz) | Maximum EIRP(W) | Emission Designator (99%OBW) | Maximum EIRP(W) | Emission Designator (99%OBW) |
| 20 | 2580.0 ~ 2610.0 | 0.1132 | 17M9G7D | 0.0899 | 17M8W7D |
| LTE Band 41 | | QPSK | | 16QAM/64QAM | |
| BW (MHz) | Frequency Range (MHz) | Maximum EIRP(W) | Emission Designator (99%OBW) | Maximum EIRP(W) | Emission Designator (99%OBW) |
| 20 | 2506.0 ~ 2680.0 | 0.2270 | 17M9G7D | 0.1807 | 17M8W7D |
| LTE Band 71 | | QPSK | | 16QAM/64QAM | |
| BW (MHz) | Frequency Range (MHz) | Maximum ERP(W) | Emission Designator (99%OBW) | Maximum ERP(W) | Emission Designator (99%OBW) |
| 20 | 673.0 ~ 688.0 | 0.0583 | 17M9G7D | 0.0486 | 17M9W7D |



| LTE Band 41 CA | QPSK | | 16QAM/64QAM | |
|----------------|-----------------|------------------------------|-----------------|------------------------------|
| BW (MHz) | Maximum EIRP(W) | Emission Designator (99%OBW) | Maximum EIRP(W) | Emission Designator (99%OBW) |
| 20MHz+20MHz | 0.1125 | 37M7G7D | 0.0906 | 37M5W7D |

Note:

- LTE Band 12 overlaps the entire frequency range of LTE Band 17. Therefore, the test results provided in this report covers Band 12 as well as Band 17.
- LTE Band 41 overlaps the entire frequency range of LTE Band 38. Therefore, the test results provided in this report covers Band 41 as well as Band 38.
- All modulations have been tested, and only the worst test results of PSK & QAM are shown in the report .
- Based on engineering evaluation, only the maximum bandwidth and the worst modulation test results are shown in the report.

1.8 Testing Location

Sporton International Inc. (Kunshan) is accredited to ISO/IEC 17025:2017 by American Association for Laboratory Accreditation with Certificate Number 5145.02.

| | | | |
|---------------------------|--|----------------------------|---------------------------------------|
| Test Firm | Sporton International Inc. (Kunshan) | | |
| Test Site Location | No. 1098, Pengxi North Road, Kunshan Economic Development Zone Jiangsu Province 215300 People's Republic of China TEL : +86-512-57900158 FAX : +86-512-57900958 | | |
| Test Site No. | Sporton Site No. | FCC Designation No. | FCC Test Firm Registration No. |
| | 03CH04-KS TH01-KS | CN1257 | 314309 |

1.9 Test Software

| Item | Site | Manufacture | Name | Version |
|------|-----------|-------------|------|--------------|
| 1. | 03CH04-KS | AUDIX | E3 | 6.2009-8-24a |

1.10 Applicable Standards

According to the specifications of the manufacturer, the EUT must comply with the requirements of the following standards:



- ♦ 47 CFR Part 2, 27(M), 27(H), 27(F), 27(N)
- ♦ ANSI C63.26-2015
- ♦ FCC KDB 971168 D01 Power Meas License Digital Systems v03r01
- ♦ FCC KDB 412172 D01 Determining ERP and EIRP v01r01

Remark:

1. All test items were verified and recorded according to the standards and without any deviation during the test.
2. This EUT has also been tested and complied with the requirements of FCC Part 15, Subpart B, recorded in a separate test report.



2 Test Configuration of Equipment Under Test

2.1 Test Mode

Antenna port conducted and radiated test items listed below are performed according to KDB 971168 D01 Power Meas License Digital Systems v03r01 with maximum output power.

Radiated measurements are performed by rotating the EUT in three different orthogonal test planes to find the maximum emission.

| Test Items | Band | Bandwidth (MHz) | | | | | | Modulation | | | RB # | | | Test Channel | | |
|------------------------|------|-----------------|---|---|----|----|----|------------|-------|-------|------|------|------|--------------|---|---|
| | | 1.4 | 3 | 5 | 10 | 15 | 20 | QPSK | 16QAM | 64QAM | 1 | Half | Full | L | M | H |
| Max. Output Power | 7 | - | - | v | v | v | v | v | v | v | v | | v | v | v | v |
| | 12 | v | v | v | v | - | - | v | v | v | v | | v | v | v | v |
| | 13 | - | - | v | v | - | - | v | v | v | v | | v | v | v | v |
| | 17 | - | - | v | v | - | - | v | v | v | v | | v | v | v | v |
| | 38 | - | - | v | v | v | v | v | v | v | v | | v | v | v | v |
| | 41 | - | - | v | v | v | v | v | v | v | v | | v | v | v | v |
| | 71 | - | - | v | v | v | v | v | v | v | v | | v | v | v | v |
| Peak-to-Average Ratio | 7 | - | - | | | | v | v | v | v | | | v | | v | |
| | 12 | | | | v | - | - | v | v | v | | | v | | v | |
| | 13 | - | - | | v | - | - | v | v | v | | | v | | v | |
| | 41 | - | - | | | | v | v | v | v | | | v | | v | |
| | 71 | - | - | | | | v | v | v | v | | | v | | v | |
| 26dB and 99% Bandwidth | 7 | - | - | | | | v | v | v | | | | v | | v | |
| | 12 | | | | v | - | - | v | v | | | | v | | v | |
| | 13 | - | - | | v | - | - | v | v | | | | v | | v | |
| | 41 | - | - | | | | v | v | v | | | | v | | v | |
| | 71 | - | - | | | | v | v | v | | | | v | | v | |
| Conducted Band Edge | 7 | - | - | v | v | v | v | v | v | v | v | | v | v | | v |
| | 12 | v | v | v | v | - | - | v | v | v | v | | v | v | | v |
| | 13 | - | - | v | v | - | - | v | v | v | v | | v | v | | v |
| | 41 | - | - | v | v | v | v | v | v | v | v | | v | v | | v |
| | 71 | - | - | v | v | v | v | v | v | v | v | | v | v | | v |



| Test Items | Band | Bandwidth (MHz) | | | | | | Modulation | | | RB # | | | Test Channel | | | |
|-----------------------------|---|-----------------|---|---|----|----|----|------------|-------|-------|------|------|------|--------------|---|---|---|
| | | 1.4 | 3 | 5 | 10 | 15 | 20 | QPSK | 16QAM | 64QAM | 1 | Half | Full | L | M | H | |
| Conducted Spurious Emission | 7 | - | - | v | v | v | v | v | | | | v | | | v | v | v |
| | 12 | v | v | v | v | - | - | v | | | | v | | | v | v | v |
| | 13 | - | - | v | v | - | - | v | | | | v | | | v | v | v |
| | 41 | - | - | v | v | v | v | v | | | | v | | | v | v | v |
| | 71 | - | - | v | v | v | v | v | | | | v | | | v | v | v |
| Frequency Stability | 7 | - | - | | v | | | v | | | | | | v | | v | |
| | 12 | | | | v | - | - | v | | | | | | v | | v | |
| | 13 | - | - | | v | - | - | v | | | | | | v | | v | |
| | 41 | - | - | | v | | | v | | | | | | v | | v | |
| | 71 | - | - | | v | | | v | | | | | | v | | v | |
| E.R.P / E.I.R.P | 7 | - | - | v | v | v | v | v | v | v | v | v | | v | v | v | v |
| | 12 | v | v | v | v | - | - | v | v | v | v | v | | v | v | v | v |
| | 13 | - | - | v | v | - | - | v | v | v | v | v | | v | v | v | v |
| | 17 | - | - | v | v | - | - | v | v | v | v | v | | v | v | v | v |
| | 38 | - | - | v | v | v | v | v | v | v | v | v | | v | v | v | v |
| | 41 | - | - | v | v | v | v | v | v | v | v | v | | v | v | v | v |
| | 71 | - | - | v | v | v | v | v | v | v | v | v | | v | v | v | v |
| Radiated Spurious Emission | 7 | Worst Case | | | | | | | | | | | | | v | | |
| | 12 | Worst Case | | | | | | | | | | | | | v | | |
| | 13 | Worst Case | | | | | | | | | | | | | v | | |
| | 41 | Worst Case | | | | | | | | | | | | | v | | |
| | 71 | Worst Case | | | | | | | | | | | | | v | | |
| Note | <ol style="list-style-type: none"> The mark "v" means that this configuration is chosen for testing The mark "-" means that this bandwidth is not supported. The device is investigated from 30MHz to 10 times of fundamental signal for radiated spurious emission test under different RB size/offset and modulations in exploratory test. Subsequently, only the worst case emissions are reported. | | | | | | | | | | | | | | | | |



| Test Items | Band | Bandwidth (MHz) | | | | | | | | | | Modulation | | | RB # | | | Test Channel | | | | | | | |
|-----------------------------|---|-----------------|-------|-------|-------|-------|------|------|-------|-------|-------|------------|-------|-------|------|------|------|--------------|---|---|---|---|---|--|--|
| | | 20+20 | 20+15 | 15+20 | 20+10 | 10+20 | 20+5 | 5+20 | 15+15 | 15+10 | 10+15 | QPSK | 16QAM | 64QAM | 1 | Half | Full | L | M | H | | | | | |
| Max. Output Power | 41C_CA | v | v | v | v | v | v | v | v | v | v | v | v | v | v | v | | | | v | v | v | | | |
| 26dB and 99% Bandwidth | 41C_CA | v | | | | | | | | | | | | v | v | | | | v | | v | | | | |
| Conducted Band Edge | 41C_CA | v | v | v | v | v | v | v | v | v | v | v | v | v | v | v | | | v | v | | v | | | |
| Conducted Spurious Emission | 41C_CA | v | v | v | v | v | v | v | v | v | v | v | v | | | | v | | | v | v | v | | | |
| E.I.R.P. | 41C_CA | v | v | v | v | v | v | v | v | v | v | v | v | v | v | v | | | | v | v | v | | | |
| Radiated Spurious Emission | 41C_CA | Worst Case | | | | | | | | | | | | | | | | | | | | | v | | |
| Note | 1. The mark "v " means that this configuration is chosen for testing 2. The mark "-" means that this bandwidth is not supported. 3. The device is investigated from 30MHz to 10 times of fundamental signal for radiated spurious emission test under different RB size/offset and modulations in exploratory test. Subsequently, only the worst case emissions are reported. | | | | | | | | | | | | | | | | | | | | | | | | |

2.2 Connection Diagram of Test System

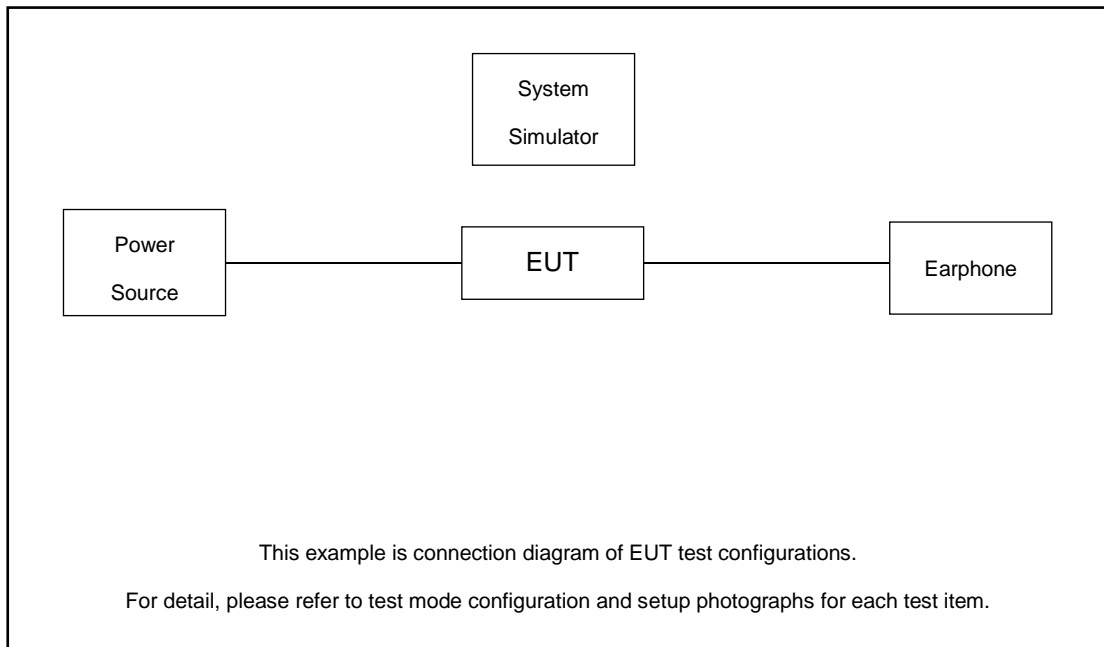



2.3 Support Unit used in test configuration and system

| Item | Equipment | Trade Name | Model No. | FCC ID | Data Cable | Power Cord |
|------|------------------|------------|-----------|--------|------------|-------------------|
| 1. | Power Supply | GWINSTEK | PSS-2002 | N/A | N/A | Unshielded, 1.8 m |
| 2. | LTE Base Station | Anritsu | MT8820C | N/A | N/A | Unshielded, 1.8 m |
| 3. | Earphone | N/A | N/A | N/A | N/A | N/A |

2.4 Measurement Results Explanation Example

For all conducted test items:

The offset level is set in the spectrum analyzer to compensate the RF cable loss between EUT conducted output port and spectrum analyzer. With the offset compensation, the spectrum analyzer reading level is exactly the EUT RF output level.

The spectrum analyzer offset is derived from RF cable loss.

$$\text{Offset} = \text{RF cable loss.}$$

Following shows an offset computation example with cable loss 4.7 dB.

Example :

$$\begin{aligned} \text{Offset(dB)} &= \text{RF cable loss(dB)}. \\ &= 4.7 \text{ (dB)} \end{aligned}$$



2.5 Frequency List of Low/Middle/High Channels

| LTE Band 7 Channel and Frequency List | | | | |
|---------------------------------------|------------------------|--------|--------|---------|
| BW [MHz] | Channel/Frequency(MHz) | Lowest | Middle | Highest |
| 20 | Channel | 20850 | 21100 | 21350 |
| | Frequency | 2510 | 2535 | 2560 |
| 15 | Channel | 20825 | 21100 | 21375 |
| | Frequency | 2507.5 | 2535 | 2562.5 |
| 10 | Channel | 20800 | 21100 | 21400 |
| | Frequency | 2505 | 2535 | 2565 |
| 5 | Channel | 20775 | 21100 | 21425 |
| | Frequency | 2502.5 | 2535 | 2567.5 |

| LTE Band 12 Channel and Frequency List | | | | |
|--|------------------------|--------|--------|---------|
| BW [MHz] | Channel/Frequency(MHz) | Lowest | Middle | Highest |
| 10 | Channel | 23060 | 23095 | 23130 |
| | Frequency | 704 | 707.5 | 711 |
| 5 | Channel | 23035 | 23095 | 23155 |
| | Frequency | 701.5 | 707.5 | 713.5 |
| 3 | Channel | 23025 | 23095 | 23165 |
| | Frequency | 700.5 | 707.5 | 714.5 |
| 1.4 | Channel | 23017 | 23095 | 23173 |
| | Frequency | 699.7 | 707.5 | 715.3 |

| LTE Band 13 Channel and Frequency List | | | | |
|--|------------------------|--------|--------|---------|
| BW [MHz] | Channel/Frequency(MHz) | Lowest | Middle | Highest |
| 10 | Channel | - | 23230 | - |
| | Frequency | - | 782 | - |
| 5 | Channel | 23205 | 23230 | 23255 |
| | Frequency | 779.5 | 782 | 784.5 |



| LTE Band 17 Channel and Frequency List | | | | |
|--|------------------------|--------|--------|---------|
| BW [MHz] | Channel/Frequency(MHz) | Lowest | Middle | Highest |
| 10 | Channel | 23780 | 23790 | 23800 |
| | Frequency | 709 | 710 | 711 |
| 5 | Channel | 23755 | 23790 | 23825 |
| | Frequency | 706.5 | 710 | 713.5 |

| LTE Band 38 Channel and Frequency List | | | | |
|--|------------------------|--------|--------|---------|
| BW [MHz] | Channel/Frequency(MHz) | Lowest | Middle | Highest |
| 20 | Channel | 37850 | 38000 | 38150 |
| | Frequency | 2580 | 2595 | 2610 |
| 15 | Channel | 37825 | 38000 | 38175 |
| | Frequency | 2577.5 | 2595 | 2612.5 |
| 10 | Channel | 37800 | 38000 | 38200 |
| | Frequency | 2575 | 2595 | 2615 |
| 5 | Channel | 37775 | 38000 | 38225 |
| | Frequency | 2572.5 | 2595 | 2617.5 |

| LTE Band 41 Channel and Frequency List | | | | |
|--|------------------------|--------|--------|---------|
| BW [MHz] | Channel/Frequency(MHz) | Lowest | Middle | Highest |
| 20 | Channel | 39750 | 40620 | 41490 |
| | Frequency | 2506 | 2593 | 2680 |
| 15 | Channel | 39725 | 40620 | 41515 |
| | Frequency | 2503.5 | 2593 | 2682.5 |
| 10 | Channel | 39700 | 40620 | 41540 |
| | Frequency | 2501 | 2593 | 2685 |
| 5 | Channel | 39675 | 40620 | 41565 |
| | Frequency | 2498.5 | 2593 | 2687.5 |



| LTE Band 71 Channel and Frequency List | | | | |
|--|------------------------|--------|--------|---------|
| BW [MHz] | Channel/Frequency(MHz) | Lowest | Middle | Highest |
| 20 | Channel | 133222 | 133322 | 133372 |
| | Frequency | 673.0 | 680.5 | 688.0 |
| 15 | Channel | 133197 | 133297 | 133397 |
| | Frequency | 670.5 | 680.5 | 690.5 |
| 10 | Channel | 133172 | 133272 | 133422 |
| | Frequency | 668.0 | 678.0 | 693.0 |
| 5 | Channel | 133147 | 133247 | 133447 |
| | Frequency | 665.5 | 675.5 | 695.5 |

| LTE Band 41C_CA Channel and Frequency List | | | | | |
|--|------------------------|-----------|--------|---------|--------|
| BW [MHz] | Channel/Frequency(MHz) | Lowest | Middle | Highest | |
| 20 + 20 | PCC | Channel | 39750 | 40521 | 41292 |
| | | Frequency | 2506.0 | 2583.1 | 2660.2 |
| | SCC | Channel | 39948 | 40719 | 41490 |
| | | Frequency | 2525.8 | 2602.9 | 2680.0 |
| 20 + 15 | PCC | Channel | 39750 | 40546 | 41341 |
| | | Frequency | 2506.0 | 2585.6 | 2665.1 |
| | SCC | Channel | 39921 | 40717 | 41512 |
| | | Frequency | 2523.1 | 2602.7 | 2682.2 |
| 15 + 20 | PCC | Channel | 39728 | 40523 | 41319 |
| | | Frequency | 2503.8 | 2593.3 | 2662.9 |
| | SCC | Channel | 39899 | 40694 | 41490 |
| | | Frequency | 2520.9 | 2600.4 | 2680.0 |
| 20 + 10 | PCC | Channel | 39750 | 40571 | 41391 |
| | | Frequency | 2506.0 | 2588.1 | 2670.1 |
| | SCC | Channel | 39894 | 40715 | 41535 |
| | | Frequency | 2520.4 | 2602.5 | 2684.5 |
| 10 + 20 | PCC | Channel | 39705 | 40526 | 41346 |
| | | Frequency | 2501.5 | 2583.6 | 2665.6 |
| | SCC | Channel | 39849 | 40670 | 41490 |
| | | Frequency | 2515.9 | 2598.0 | 2680.0 |



| LTE Band 41C_CA Channel and Frequency List | | | | | |
|--|-----|-----------|--------|--------|--------|
| 20 + 5 | PCC | Channel | 39750 | 40595 | 41440 |
| | | Frequency | 2506.0 | 2590.5 | 2675.0 |
| | SCC | Channel | 39867 | 40712 | 41557 |
| | | Frequency | 2517.7 | 2602.2 | 2686.7 |
| 5 + 20 | PCC | Channel | 39683 | 40528 | 41373 |
| | | Frequency | 2499.3 | 2583.8 | 2668.3 |
| | SCC | Channel | 39800 | 40645 | 41490 |
| | | Frequency | 2511.0 | 2595.5 | 2680.0 |
| 15 + 15 | PCC | Channel | 39725 | 40545 | 41365 |
| | | Frequency | 2503.5 | 2585.5 | 2667.5 |
| | SCC | Channel | 39875 | 40695 | 41515 |
| | | Frequency | 2518.5 | 2600.5 | 2682.5 |
| 10 + 15 | PCC | Channel | 39703 | 40549 | 41395 |
| | | Frequency | 2501.3 | 2585.9 | 2670.5 |
| | SCC | Channel | 39823 | 40669 | 41515 |
| | | Frequency | 2513.3 | 2597.9 | 2682.5 |
| 15 + 10 | PCC | Channel | 39725 | 40571 | 41417 |
| | | Frequency | 2503.5 | 2588.1 | 2672.7 |
| | SCC | Channel | 39845 | 40691 | 41537 |
| | | Frequency | 2515.5 | 2600.1 | 2684.7 |

3 Conducted Test Items

3.1 Measuring Instruments

See list of measuring instruments of this test report.

3.2 Test Setup

3.2.1 Conducted Output Power



3.2.2 Peak-to-Average Ratio, Occupied Bandwidth, Conducted Band-Edge and Conducted Spurious Emission



3.2.3 Frequency Stability

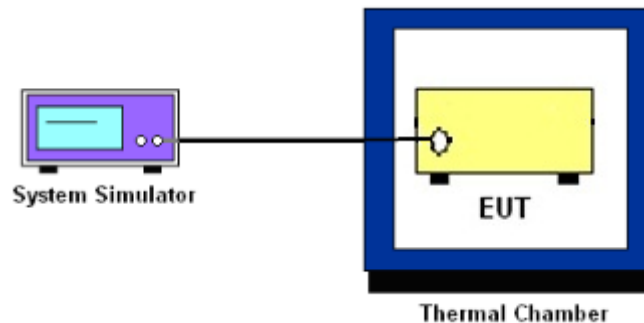

3.3 Test Result of Conducted Test

Please refer to Appendix A.



3.4 Conducted Output Power and ERP/EIRP

3.4.1 Description of the Conducted Output Power Measurement and ERP/EIRP Measurement

A system simulator was used to establish communication with the EUT. Its parameters were set to force the EUT transmitting at maximum output power. The measured power in the radio frequency on the transmitter output terminals shall be reported.

The ERP of mobile transmitters must not exceed 3 Watts for LTE Band 12, Band 13 and Band 17 and Band 71.

The EIRP of mobile transmitters must not exceed 2 Watts for LTE Band 7 and Band 38 and Band 41.

According to KDB 412172 D01 Power Approach,

$EIRP = P_T + G_T - L_C$, $ERP = EIRP - 2.15$, where

P_T = transmitter output power in dBm

G_T = gain of the transmitting antenna in dBi

L_C = signal attenuation in the connecting cable between the transmitter and antenna in dB

3.4.2 Test Procedures

1. The testing follows ANSI C63.26 Section 5.2
2. The transmitter output port was connected to the system simulator.
3. Set EUT at maximum power through the system simulator.
4. Select lowest, middle, and highest channels for each band and different modulation.
5. Measure and record the power level from the system simulator.



3.5 Peak-to-Average Ratio

3.5.1 Description of the PAR Measurement

Power Complementary Cumulative Distribution Function (CCDF) curves provide a means for characterizing the power peaks of a digitally modulated signal on a statistical basis. A CCDF curve depicts the probability of the peak signal amplitude exceeding the average power level. Most contemporary measurement instrumentation include the capability to produce CCDF curves for an input signal provided that the instrument's resolution bandwidth can be set wide enough to accommodate the entire input signal bandwidth. In measuring transmissions in this band using an average power technique, the peak-to-average ratio (PAR) of the transmission may not exceed 13 dB.

3.5.2 Test Procedures

1. The testing follows ANSI C63.26 Section 5.2.3.4 (CCDF).
2. The EUT was connected to spectrum and system simulator via a power divider.
3. Set the CCDF (Complementary Cumulative Distribution Function) option in spectrum analyzer.
4. The highest RF powers were measured and recorded the maximum PAPR level associated with a probability of 0.1 %.
5. Record the deviation as Peak to Average Ratio.



3.6 Occupied Bandwidth

3.6.1 Description of Occupied Bandwidth Measurement

The occupied bandwidth is the width of a frequency band such that, below the lower and above the upper frequency limits, the mean powers emitted are each equal to a specified percentage 0.5% of the total mean transmitted power.

The 26 dB emission bandwidth is defined as the frequency range between two points, one above and one below the carrier frequency, at which the spectral density of the emission is attenuated 26 dB below the maximum in-band spectral density of the modulated signal. Spectral density (power per unit bandwidth) is to be measured with a detector of resolution bandwidth equal to approximately 1.0% of the emission bandwidth.

3.6.2 Test Procedures

1. The testing follows ANSI C63.26 Section 5.4
2. The EUT was connected to spectrum analyzer and system simulator via a power divider.
3. The spectrum analyzer center frequency is set to the nominal EUT channel center frequency. The span range for the spectrum analyzer shall be between two and five times the anticipated OBW.
4. The nominal resolution bandwidth (RBW) shall be in the range of 1 to 5 % of the anticipated OBW, and the VBW shall be at least 3 times the RBW.
5. Set the detection mode to peak, and the trace mode to max hold.
6. Determine the reference value: Set the EUT to transmit a modulated signal. Allow the trace to stabilize. Set the spectrum analyzer marker to the highest level of the displayed trace.
(this is the reference value)
7. Determine the “-26 dB down amplitude” as equal to (Reference Value – X).
8. Place two markers, one at the lowest and the other at the highest frequency of the envelope of the spectral display such that each marker is at or slightly below the “-X dB down amplitude” determined in step 6. If a marker is below this “-X dB down amplitude” value it shall be placed as close as possible to this value. The OBW is the positive frequency difference between the two markers.
9. Use the 99 % power bandwidth function of the spectrum analyzer and report the measured bandwidth.



3.7 Conducted Band Edge

3.7.1 Description of Conducted Band Edge Measurement

27.53 (c)

For operations in the 776-788 MHz band, the FCC limit is $43 + 10\log_{10}(P[\text{Watts}])$ dB below the transmitter power $P(\text{Watts})$ in a 100 kHz bandwidth. However, in the 100 kHz bands immediately outside and adjacent to the frequency block, a resolution bandwidth of at least 30 kHz may be employed. In addition, the power of any unwanted emissions in any 6.25 kHz bandwidth for all frequencies between 763-775 MHz and 793-806 MHz shall be attenuated below the transmitter power, P (dBW), by at least $65 + 10 \log_{10} p(\text{watts})$, dB, for mobile and portable equipment.

27.53 (g)

For operations in the 600MHz band and 698 -746 MHz band, the FCC limit is $43 + 10\log_{10}(P[\text{Watts}])$ dB below the transmitter power $P(\text{Watts})$ in a 100 kHz bandwidth. However, in the 100 kilohertz bands immediately outside and adjacent to a licensee's frequency block, a resolution bandwidth of at least 30 kHz may be employed.

27.53(m)(4)

For mobile digital stations, the attenuation factor shall be not less than $40 + 10 \log (P)$ dB on all frequencies between the channel edge and 5 megahertz from the channel edge, $43 + 10 \log (P)$ dB on all frequencies between 5 megahertz and X megahertz from the channel edge, and $55 + 10 \log (P)$ dB on all frequencies more than X megahertz from the channel edge, where X is the greater of 6 megahertz or the actual emission bandwidth as defined in paragraph (m)(6) of this section. In addition, the attenuation factor shall not be less that $43 + 10 \log (P)$ dB on all frequencies between 2490.5 MHz and 2496 MHz and $55 + 10 \log (P)$ dB at or below 2490.5 MHz. Mobile Satellite Service licensees operating on frequencies below 2495 MHz may also submit a documented interference complaint against BRS licensees operating on channel BRS Channel 1 on the same terms and conditions as adjacent channel BRS or EBS licensees.



3.7.2 Test Procedures

1. The testing follows ANSI C63.26 section 5.7
2. The EUT was connected to spectrum analyzer and system simulator via a power divider.
3. The band edges of low and high channels for the highest RF powers were measured.
4. Set RBW \geq 1% EBW in the 1MHz band immediately outside and adjacent to the band edge.
5. Beyond the 1 MHz band from the band edge, RBW=1MHz was used.
6. Set spectrum analyzer with RMS detector.
7. The RF fundamental frequency should be excluded against the limit line in the operating frequency band.
8. Checked that all the results comply with the emission limit line.

Example:

The limit line is derived from $43 + 10\log(P)$ dB below the transmitter power P(Watts)
= P(W)- [43 + 10log(P)] (dB)
= [30 + 10log(P)] (dBm) - [43 + 10log(P)] (dB) = -13dBm.

9. For LTE Band 7, 38, 41, the other 40 dB, and 55 dB have additionally applied same calculation above.
10. When using the integration method, the starting frequency of the integration shall be centered at one-half of the RBW away from the band edge.



3.8 Conducted Spurious Emission

3.8.1 Description of Conducted Spurious Emission Measurement

The power of any emission outside of the authorized operating frequency ranges must be lower than the transmitter power (P) by a factor of at least $43 + 10 \log (P)$ dB.

For Band 7,38,41:

The power of any emission outside of the authorized operating frequency ranges must be lower than the transmitter power (P) by a factor of at least $55 + 10 \log (P)$ dB.

It is measured by means of a calibrated spectrum analyzer and scanned from 30 MHz up to a frequency including its 10th harmonic.

3.8.2 Test Procedures

1. The testing follows ANSI C63.26 section 5.7
2. The EUT was connected to spectrum analyzer and system simulator via a power divider.
3. The RF output of EUT was connected to the spectrum analyzer by RF cable and attenuator. The path loss was compensated to the results for each measurement.
4. The middle channel for the highest RF power within the transmitting frequency was measured.
5. The conducted spurious emission for the whole frequency range was taken.
6. Make the measurement with the spectrum analyzer's RBW = 1MHz, VBW = 3MHz.
7. Set spectrum analyzer with RMS detector.
8. Taking the record of maximum spurious emission.
9. The RF fundamental frequency should be excluded against the limit line in the operating frequency band.
10. The limit line is derived from $43 + 10\log(P)$ dB below the transmitter power P(Watts)
= $P(W) - [43 + 10\log(P)]$ (dB)
= $[30 + 10\log(P)]$ (dBm) - $[43 + 10\log(P)]$ (dB)
= -13dBm.
11. For Band 7, 38, 41
The limit line is derived from $55 + 10\log(P)$ dB below the transmitter power P(Watts)
= $P(W) - [55 + 10\log(P)]$ (dB)
= $[30 + 10\log(P)]$ (dBm) - $[55 + 10\log(P)]$ (dB)
= -25dBm.



3.9 Frequency Stability

3.9.1 Description of Frequency Stability Measurement

The frequency stability shall be measured by variation of ambient temperature and variation of primary supply voltage to ensure that the fundamental emission stays within the authorized frequency block. The frequency stability of the transmitter shall be maintained within $\pm 0.00025\%$ ($\pm 2.5\text{ppm}$) of the center frequency.

3.9.2 Test Procedures for Temperature Variation

1. The testing follows ANSI C63.26 section 5.6.4
2. The EUT was set up in the thermal chamber and connected with the system simulator.
3. With power OFF, the temperature was decreased to -30°C and the EUT was stabilized before testing. Power was applied and the maximum change in frequency was recorded within one minute.
4. With power OFF, the temperature was raised in 10°C step up to 50°C . The EUT was stabilized at each step for at least half an hour. Power was applied and the maximum frequency change was recorded within one minute.

3.9.3 Test Procedures for Voltage Variation

1. The testing follows ANSI C63.26 section 5.6.5
2. The EUT was placed in a temperature chamber at $20\pm 5^{\circ}\text{C}$ and connected with the system simulator.
3. The power supply voltage to the EUT was varied from 85% to 115% of the nominal value for other than hand carried battery equipment.
4. For hand carried, battery powered equipment, reduce the primary ac or dc supply voltage to the battery operating end point, which shall be specified by the manufacturer.
5. The variation in frequency was measured for the worst case.

4 Radiated Test Items

4.1 Measuring Instruments

See list of measuring instruments of this test report.

4.2 Test Setup

4.2.1 For radiated test below 30MHz

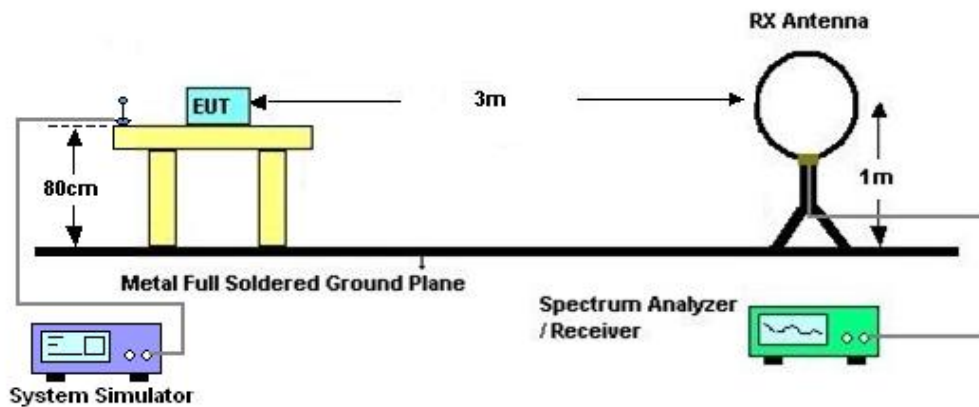

4.2.2 For radiated test from 30MHz to 1GHz

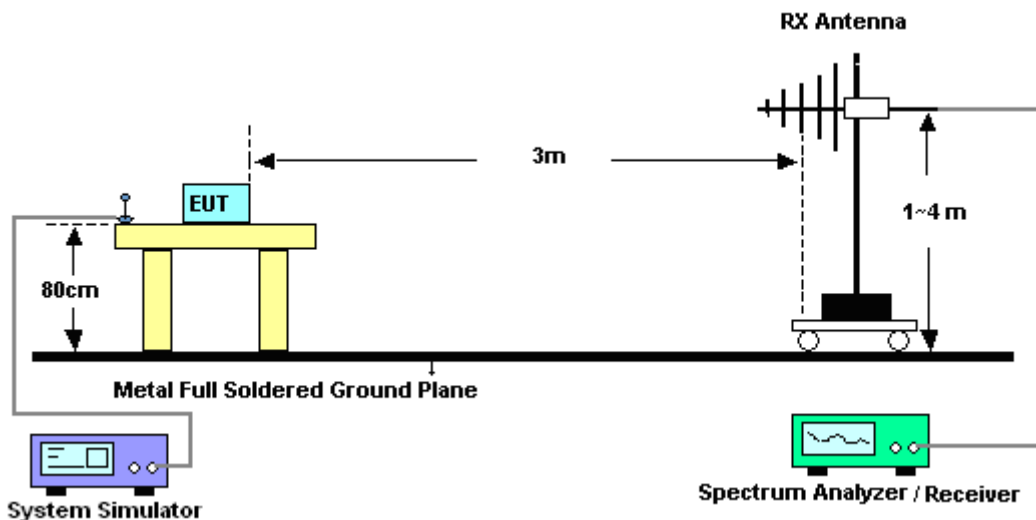

4.2.3 For radiated test above 1GHz

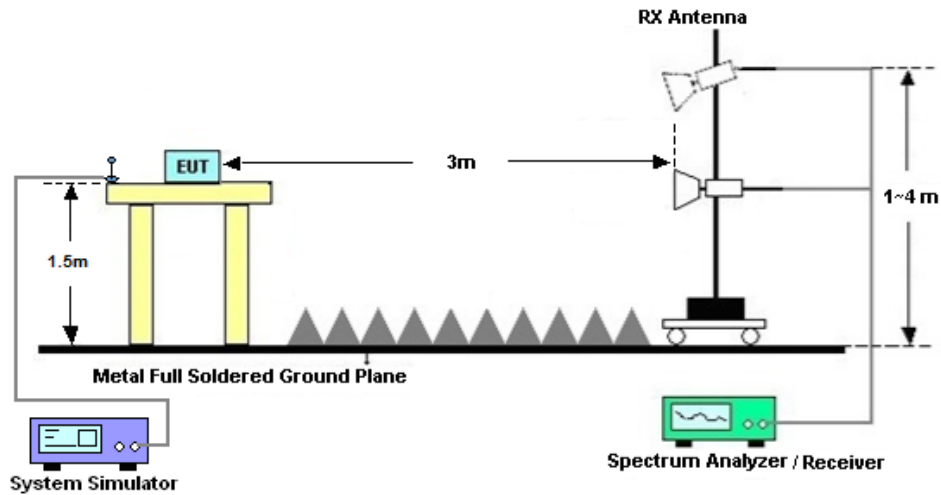

4.3 Test Result of Radiated Test

The low frequency, which started from 9 kHz to 30MHz, was pre-scanned and the result which was 20dB lower than the limit line was not reported.

Please refer to Appendix B.



4.4 Radiated Spurious Emission

4.4.1 Description of Radiated Spurious Emission

The radiated spurious emission was measured by substitution method according to ANSI C63.26. The power of any emission outside of the authorized operating frequency ranges must be attenuated below the transmitter power (P) by a factor of at least $43 + 10 \log (P)$ dB.

For Band 7, 38, 41

The power of any emission outside of the authorized operating frequency ranges must be attenuated below the transmitter power (P) by a factor of at least $55 + 10 \log (P)$ dB.

For LTE Band 13

For operations in the 746-758 MHz, 775-788 MHz, and 805-806 MHz bands, emissions in the band 1559-1610 MHz shall be limited to -70 dBW/MHz equivalent isotropically radiated power (EIRP) for wideband signals, and -80 dBW EIRP for discrete emissions of less than 700 Hz bandwidth.

The spectrum is scanned from 30 MHz up to a frequency including its 10th harmonic.

4.4.2 Test Procedures

1. The testing follows ANSI C63.26 Section 5.5
2. The EUT was placed on a turntable with 0.8 meter height for frequency below 1GHz and 1.5 meter height for frequency above 1GHz respectively above ground.
3. The EUT was set 3 meters from the receiving antenna mounted on the antenna tower.
4. The table was rotated 360 degrees to determine the position of the highest spurious emission.
5. The height of the receiving antenna is varied between 1m to 4m to search the maximum spurious emission for both horizontal and vertical polarizations.
6. During the measurement, the system simulator parameters were set to force the EUT transmitting at maximum output power.
7. Make the measurement with the spectrum analyzer's RBW = 1MHz, VBW = 3MHz, taking the record of maximum spurious emission.
8. A horn antenna was substituted in place of the EUT and was driven by a signal generator.
9. Tune the output power of signal generator to the same emission level with EUT maximum spurious emission.
10. $EIRP (dBm) = S.G. Power - Tx Cable Loss + Tx Antenna Gain$
11. $ERP (dBm) = EIRP - 2.15$
12. The RF fundamental frequency should be excluded against the limit line in the operating frequency band.
The limit line is derived from $43 + 10\log(P)$ dB below the transmitter power P(Watts)
 $= P(W) - [43 + 10\log(P)] (dB)$
 $= [30 + 10\log(P)] (dBm) - [43 + 10\log(P)] (dB)$
 $= -13dBm.$
13. For Band 7, 38, 41:
The limit line is derived from $55 + 10\log(P)$ dB below the transmitter power P(Watts)



5 List of Measuring Equipment

| Instrument | Manufacturer | Model No. | Serial No. | Characteristics | Calibration Date | Test Date | Due Date | Remark |
|--------------------------------|--------------|--------------------------------|-------------|-------------------------|------------------|---------------------------------|---------------|--------------------------|
| Spectrum Analyzer | R&S | FSV40 | 101040 | 10Hz~40GHz | Oct. 14, 2021 | Dec. 26, 2021~ Jan. 20, 2022 | Oct. 13, 2022 | Conducted (TH01-KS) |
| Power divider | STI | STI08-0055 | - | 0.5~40GHz | Aug. 26, 2021 | Dec. 26, 2021~ Jan. 20, 2022 | Aug. 25, 2022 | Conducted (TH01-KS) |
| Temperature & humidity chamber | Hongzhan | LP-150U | H2014011440 | -40~+150°C 20%~95%RH | Jul. 12, 2021 | Dec. 26, 2021~ Jan. 20, 2022 | Jul. 11, 2022 | Conducted (TH01-KS) |
| EXA Spectrum Analyzer | Keysight | N9010A | MY55150244 | 10Hz-44G,MAX 30dB | Apr. 13, 2021 | Jan. 19, 2022 | Apr. 12, 2022 | Radiation (03CH04-KS) |
| Loop Antenna | R&S | HFH2-Z2 | 100321 | 9kHz~30MHz | Oct. 30, 2021 | Jan. 19, 2022 | Oct. 29, 2022 | Radiation (03CH04-KS) |
| Bilog Antenna | TeseQ | CBL6111D | 49922 | 30MHz-1GHz | May 30, 2021 | Jan. 19, 2022 | May 29, 2022 | Radiation (03CH04-KS) |
| Horn Antenna | Schwarzbeck | BBHA9120D | 1356 | 1GHz~18GHz | Apr. 18, 2021 | Jan. 19, 2022 | Apr. 17, 2022 | Radiation (03CH04-KS) |
| SHF-EHF Horn | Com-power | AH-840 | 101070 | 18GHz~40GHz | Jan. 05, 2022 | Jan. 19, 2022 | Jan. 04, 2023 | Radiation (03CH04-KS) |
| Amplifier | SONOMA | 310N | 187289 | 9KHz-1GHz | Jan. 05, 2022 | Jan. 19, 2022 | Jan. 04, 2023 | Radiation (03CH04-KS) |
| Amplifier | MITEQ | EM18G40G GA | 060728 | 18~40GHz | Jan. 05, 2022 | Jan. 19, 2022 | Jan. 04, 2023 | Radiation (03CH04-KS) |
| high gain Amplifier | MITEQ | AMF-7D-00 101800-30-1 0P | 2025788 | 1Ghz-18Ghz | Jul. 30, 2021 | Jan. 19, 2022 | Jul. 29, 2022 | Radiation (03CH04-KS) |
| Amplifier | Keysight | 83017A | MY57280106 | 500MHz~26.5GHz | Oct. 13, 2021 | Jan. 19, 2022 | Oct. 12, 2022 | Radiation (03CH04-KS) |
| AC Power Source | Chroma | 61601 | F104090004 | N/A | NCR | Jan. 19, 2022 | NCR | Radiation (03CH04-KS) |
| Turn Table | ChamPro | EM 1000-T | 060762-T | 0~360 degree | NCR | Jan. 19, 2022 | NCR | Radiation (03CH04-KS) |
| Antenna Mast | ChamPro | EM 1000-A | 060762-A | 1 m~4 m | NCR | Jan. 19, 2022 | NCR | Radiation (03CH04-KS) |

NCR: No Calibration Required



6 Uncertainty of Evaluation

The measurement uncertainties shown below were calculated in accordance with the requirements of ANSI 63.26-2015. All the measurement uncertainty value were shown with a coverage K=2 to indicate 95% level of confidence. The measurement data show herein meets or exceeds the CISPR measurement uncertainty values specified in CISPR 16-4-2 and can be compared directly to specified limit to determine compliance.

Uncertainty of Radiated Emission Measurement (30 MHz ~ 1000 MHz)

| | |
|---|-------|
| Measuring Uncertainty for a Level of Confidence of 95% (U = 2Uc(y)) | 3.3dB |
|---|-------|

Uncertainty of Radiated Emission Measurement (1 GHz ~ 40 GHz)

| | |
|---|-------|
| Measuring Uncertainty for a Level of Confidence of 95% (U = 2Uc(y)) | 2.8dB |
|---|-------|



Appendix A. Test Results of Conducted Test

| | | | |
|-----------------|------------|---------------------|---------|
| Test Engineer : | Simle Wang | Temperature : | 22~23°C |
| | | Relative Humidity : | 40~42% |

Conducted Output Power(Average power) and ERP/EIRP

LTE Band 7:

| BW [MHz] | Modulation | RB Size | RB Offset | Power Low Ch. / Freq. | Power Middle Ch. / Freq. | Power High Ch. / Freq. | EIRP(W) | | |
|-----------------|------------|---------|-----------|-----------------------|--------------------------|------------------------|---------|--------|--------|
| Channel | | | | 20850 | 20850 | 21350 | | | |
| Frequency (MHz) | | | | 2510 | 2535 | 2560 | L | M | H |
| 20 | QPSK | 1 | 0 | 22.46 | 22.62 | 22.49 | 0.1086 | 0.1127 | 0.1094 |
| 20 | QPSK | 1 | 99 | 22.39 | 22.48 | 22.43 | 0.1069 | 0.1091 | 0.1079 |
| 20 | QPSK | 100 | 0 | 21.46 | 21.61 | 21.58 | 0.0863 | 0.0893 | 0.0887 |
| 20 | 16QAM | 1 | 0 | 21.75 | 21.79 | 21.73 | 0.0923 | 0.0931 | 0.0918 |
| 20 | 64QAM | 1 | 0 | 20.56 | 20.69 | 20.65 | 0.0701 | 0.0723 | 0.0716 |
| Channel | | | | 20825 | 21100 | 21375 | EIRP(W) | | |
| Frequency (MHz) | | | | 2507.5 | 2535 | 2562.5 | L | M | H |
| 15 | QPSK | 1 | 0 | 22.35 | 22.56 | 22.44 | 0.1059 | 0.1112 | 0.1081 |
| 15 | 16QAM | 1 | 0 | 21.72 | 21.64 | 21.64 | 0.0916 | 0.0899 | 0.0899 |
| Channel | | | | 20800 | 21100 | 21400 | EIRP(W) | | |
| Frequency (MHz) | | | | 2505 | 2535 | 2565 | L | M | H |
| 10 | QPSK | 1 | 0 | 22.43 | 22.51 | 22.46 | 0.1079 | 0.1099 | 0.1086 |
| 10 | 16QAM | 1 | 0 | 21.60 | 21.70 | 21.60 | 0.0891 | 0.0912 | 0.0891 |
| Channel | | | | 20775 | 21100 | 21425 | EIRP(W) | | |
| Frequency (MHz) | | | | 2502.5 | 2535 | 2567.5 | L | M | H |
| 5 | QPSK | 1 | 0 | 22.36 | 22.45 | 22.47 | 0.1062 | 0.1084 | 0.1089 |
| 5 | 16QAM | 1 | 0 | 21.70 | 21.65 | 21.67 | 0.0912 | 0.0902 | 0.0906 |



LTE Band 12:

| BW [MHz] | Modulation | RB Size | RB Offset | Power Low Ch. / Freq. | Power Middle Ch. / Freq. | Power High Ch. / Freq. | ERP(W) | | |
|-----------------|------------|---------|-----------|-----------------------|--------------------------|------------------------|--------|--------|--------|
| Channel | | | | 23060 | 23095 | 23130 | ERP(W) | | |
| Frequency (MHz) | | | | 704 | 707.5 | 711 | L | M | H |
| 10 | QPSK | 1 | 0 | 22.78 | 22.84 | 22.75 | 0.0528 | 0.0536 | 0.0525 |
| 10 | QPSK | 1 | 49 | 22.61 | 22.68 | 22.57 | 0.0508 | 0.0516 | 0.0504 |
| 10 | QPSK | 50 | 0 | 21.66 | 21.79 | 21.74 | 0.0408 | 0.0421 | 0.0416 |
| 10 | 16QAM | 1 | 0 | 21.89 | 21.98 | 21.96 | 0.0431 | 0.0440 | 0.0438 |
| 10 | 64QAM | 1 | 0 | 20.78 | 20.87 | 20.80 | 0.0333 | 0.0340 | 0.0335 |
| Channel | | | | 23035 | 23095 | 23205 | ERP(W) | | |
| Frequency (MHz) | | | | 701.5 | 707.5 | 718.5 | L | M | H |
| 5 | QPSK | 1 | 0 | 22.63 | 22.78 | 22.68 | 0.0511 | 0.0528 | 0.0516 |
| 5 | 16QAM | 1 | 0 | 21.78 | 21.83 | 21.88 | 0.0420 | 0.0425 | 0.0430 |
| Channel | | | | 23025 | 23095 | 23195 | ERP(W) | | |
| Frequency (MHz) | | | | 700.5 | 707.5 | 717.5 | L | M | H |
| 3 | QPSK | 1 | 0 | 22.75 | 22.72 | 22.71 | 0.0525 | 0.0521 | 0.0520 |
| 3 | 16QAM | 1 | 0 | 21.71 | 21.93 | 21.91 | 0.0413 | 0.0435 | 0.0433 |
| Channel | | | | 23017 | 23095 | 23173 | ERP(W) | | |
| Frequency (MHz) | | | | 699.7 | 707.5 | 715.3 | L | M | H |
| 1.4 | QPSK | 1 | 0 | 22.70 | 22.67 | 22.62 | 0.0519 | 0.0515 | 0.0509 |
| 1.4 | 16QAM | 1 | 0 | 21.78 | 21.86 | 21.80 | 0.0420 | 0.0428 | 0.0422 |

LTE Band 13:

| BW [MHz] | Modulation | RB Size | RB Offset | Power Low Ch. / Freq. | Power Middle Ch. / Freq. | Power High Ch. / Freq. | ERP(W) | | |
|-----------------|------------|---------|-----------|-----------------------|--------------------------|------------------------|--------|--------|--------|
| Channel | | | | 23230 | | | ERP(W) | | |
| Frequency (MHz) | | | | - | 782 | - | - | M | - |
| 10 | QPSK | 1 | 0 | - | 22.84 | - | - | 0.0587 | - |
| 10 | QPSK | 1 | 49 | | 22.77 | | | 0.0578 | |
| 10 | QPSK | 50 | 0 | | 21.81 | | | 0.0463 | |
| 10 | 16QAM | 1 | 0 | | 22.07 | | | 0.0492 | |
| 10 | 64QAM | 1 | 0 | | 20.96 | | | 0.0381 | |
| Channel | | | | | 23205 | | | 23230 | |
| Frequency (MHz) | | | | 779.5 | 782 | 784.5 | L | M | H |
| 5 | QPSK | 1 | 0 | 22.68 | 22.76 | 22.72 | 0.0566 | 0.0577 | 0.0571 |
| 5 | 16QAM | 1 | 0 | 21.77 | 21.92 | 21.98 | 0.0459 | 0.0475 | 0.0482 |



LTE Band 17:

| BW [MHz] | Modulation | RB Size | RB Offset | Power Low Ch. / Freq. | Power Middle Ch. / Freq. | Power High Ch. / Freq. | ERP(W) | | |
|-----------------|------------|---------|-----------|-----------------------|--------------------------|------------------------|--------|--------|--------|
| Channel | | | | 23780 | 23790 | 23800 | | | |
| Frequency (MHz) | | | | 709 | 710 | 711 | L | M | H |
| 10 | QPSK | 1 | 0 | 22.74 | 22.80 | 22.71 | 0.0524 | 0.0531 | 0.0520 |
| 10 | QPSK | 1 | 49 | 22.58 | 22.69 | 22.56 | 0.0505 | 0.0518 | 0.0502 |
| 10 | QPSK | 50 | 0 | 21.73 | 21.77 | 21.69 | 0.0415 | 0.0419 | 0.0411 |
| 10 | 16QAM | 1 | 0 | 21.85 | 21.98 | 21.94 | 0.0427 | 0.0440 | 0.0436 |
| 10 | 64QAM | 1 | 0 | 20.78 | 20.86 | 20.81 | 0.0333 | 0.0340 | 0.0336 |
| Channel | | | | 23755 | 23790 | 23825 | ERP(W) | | |
| Frequency (MHz) | | | | 706.5 | 710 | 713.5 | L | M | H |
| 5 | QPSK | 1 | 0 | 22.68 | 22.75 | 22.63 | 0.0516 | 0.0525 | 0.0511 |
| 5 | 16QAM | 1 | 0 | 21.81 | 21.95 | 21.86 | 0.0423 | 0.0437 | 0.0428 |

LTE Band 38:

| BW [MHz] | Modulation | RB Size | RB Offset | Power Low Ch. / Freq. | Power Middle Ch. / Freq. | Power High Ch. / Freq. | EIRP(W) | | |
|-----------------|------------|---------|-----------|-----------------------|--------------------------|------------------------|---------|--------|--------|
| Channel | | | | 37850 | 38000 | 38150 | | | |
| Frequency (MHz) | | | | 2580 | 2595 | 2610 | L | M | H |
| 20 | QPSK | 1 | 0 | 22.62 | 22.64 | 22.58 | 0.1127 | 0.1132 | 0.1117 |
| 20 | QPSK | 1 | 99 | 22.36 | 22.45 | 22.43 | 0.1062 | 0.1084 | 0.1079 |
| 20 | QPSK | 100 | 0 | 21.57 | 21.59 | 21.56 | 0.0885 | 0.0889 | 0.0883 |
| 20 | 16QAM | 1 | 0 | 21.61 | 21.64 | 21.56 | 0.0893 | 0.0899 | 0.0883 |
| 20 | 64QAM | 1 | 0 | 20.27 | 20.41 | 20.32 | 0.0656 | 0.0678 | 0.0664 |
| Channel | | | | 37825 | 38000 | 38175 | EIRP(W) | | |
| Frequency (MHz) | | | | 2577.5 | 2595 | 2612.5 | L | M | H |
| 15 | QPSK | 1 | 0 | 22.45 | 22.58 | 22.43 | 0.1084 | 0.1117 | 0.1079 |
| 15 | 16QAM | 1 | 0 | 21.48 | 21.58 | 21.50 | 0.0867 | 0.0887 | 0.0871 |
| Channel | | | | 37800 | 38000 | 38200 | EIRP(W) | | |
| Frequency (MHz) | | | | 2575 | 2595 | 2615 | L | M | H |
| 10 | QPSK | 1 | 0 | 22.52 | 22.54 | 22.44 | 0.1102 | 0.1107 | 0.1081 |
| 10 | 16QAM | 1 | 0 | 21.58 | 21.55 | 21.46 | 0.0887 | 0.0881 | 0.0863 |
| Channel | | | | 37775 | 38000 | 38225 | EIRP(W) | | |
| Frequency (MHz) | | | | 2572.5 | 2595 | 2617.5 | L | M | H |
| 5 | QPSK | 1 | 0 | 22.54 | 22.46 | 22.41 | 0.1107 | 0.1086 | 0.1074 |
| 5 | 16QAM | 1 | 0 | 21.55 | 21.53 | 21.41 | 0.0881 | 0.0877 | 0.0853 |



LTE Band 41:

| BW [MHz] | Modulation | RB Size | RB Offset | Power Low Ch. / Freq. | Power Middle Ch. / Freq. | Power High Ch. / Freq. | EIRP(W) | | |
|-----------------|------------|---------|-----------|-----------------------|--------------------------|------------------------|---------|--------|--------|
| Channel | | | | 39750 | 40620 | 41490 | | | |
| Frequency (MHz) | | | | 2506 | 2593 | 2680 | L | M | H |
| 20 | QPSK | 1 | 0 | 25.57 | 25.66 | 25.62 | 0.2223 | 0.2270 | 0.2249 |
| 20 | QPSK | 1 | 99 | 25.36 | 25.41 | 25.39 | 0.2118 | 0.2143 | 0.2133 |
| 20 | QPSK | 100 | 0 | 24.55 | 24.65 | 24.61 | 0.1758 | 0.1799 | 0.1782 |
| 20 | 16QAM | 1 | 0 | 24.57 | 24.67 | 24.66 | 0.1766 | 0.1807 | 0.1803 |
| 20 | 64QAM | 1 | 0 | 23.27 | 23.40 | 23.39 | 0.1309 | 0.1349 | 0.1346 |
| Channel | | | | 39725 | 40620 | 41515 | EIRP(W) | | |
| Frequency (MHz) | | | | 2503.5 | 2593 | 2682.5 | L | M | H |
| 15 | QPSK | 1 | 0 | 25.43 | 25.61 | 25.52 | 0.2153 | 0.2244 | 0.2198 |
| 15 | 16QAM | 1 | 0 | 24.49 | 24.62 | 24.52 | 0.1734 | 0.1786 | 0.1746 |
| Channel | | | | 39700 | 40620 | 41540 | EIRP(W) | | |
| Frequency (MHz) | | | | 2501 | 2593 | 2685 | L | M | H |
| 10 | QPSK | 1 | 0 | 25.49 | 25.54 | 25.51 | 0.2183 | 0.2208 | 0.2193 |
| 10 | 16QAM | 1 | 0 | 24.53 | 24.53 | 24.62 | 0.1750 | 0.1750 | 0.1786 |
| Channel | | | | 39675 | 40620 | 41565 | EIRP(W) | | |
| Frequency (MHz) | | | | 2498.5 | 2593 | 2687.5 | L | M | H |
| 5 | QPSK | 1 | 0 | 25.43 | 25.50 | 25.49 | 0.2153 | 0.2188 | 0.2183 |
| 5 | 16QAM | 1 | 0 | 24.47 | 24.50 | 24.58 | 0.1726 | 0.1738 | 0.1770 |

LTE Band 71:

| BW [MHz] | Modulation | RB Size | RB Offset | Power Low Ch. / Freq. | Power Middle Ch. / Freq. | Power High Ch. / Freq. | ERP(W) | | |
|-----------------|------------|---------|-----------|-----------------------|--------------------------|------------------------|---------|--------|--------|
| Channel | | | | 133222 | 133322 | 133372 | | | |
| Frequency (MHz) | | | | 673 | 683 | 688 | L | M | H |
| 20 | QPSK | 1 | 0 | 22.88 | 23.01 | 22.81 | 0.0566 | 0.0583 | 0.0557 |
| 20 | QPSK | 1 | 99 | 22.71 | 22.83 | 22.78 | 0.0545 | 0.0560 | 0.0553 |
| 20 | QPSK | 100 | 0 | 21.78 | 21.89 | 21.83 | 0.0440 | 0.0451 | 0.0445 |
| 20 | 16QAM | 1 | 0 | 22.14 | 22.22 | 22.12 | 0.0478 | 0.0486 | 0.0475 |
| 20 | 64QAM | 1 | 0 | 20.96 | 21.07 | 21.05 | 0.0364 | 0.0373 | 0.0372 |
| Channel | | | | 133197 | 133297 | 133397 | EIRP(W) | | |
| Frequency (MHz) | | | | 670.5 | 680.5 | 690.5 | L | M | H |
| 15 | QPSK | 1 | 0 | 22.83 | 22.95 | 22.77 | 0.0560 | 0.0575 | 0.0552 |
| 15 | 16QAM | 1 | 0 | 22.00 | 22.13 | 22.02 | 0.0462 | 0.0476 | 0.0465 |
| Channel | | | | 133172 | 133272 | 133422 | EIRP(W) | | |
| Frequency (MHz) | | | | 668 | 678 | 693 | L | M | H |
| 10 | QPSK | 1 | 0 | 22.78 | 22.92 | 22.76 | 0.0553 | 0.0571 | 0.0551 |
| 10 | 16QAM | 1 | 0 | 21.96 | 22.13 | 22.02 | 0.0458 | 0.0476 | 0.0465 |
| Channel | | | | 133147 | 133247 | 133447 | EIRP(W) | | |
| Frequency (MHz) | | | | 665.5 | 675.5 | 695.5 | L | M | H |
| 5 | QPSK | 1 | 0 | 22.79 | 22.85 | 22.88 | 0.0555 | 0.0562 | 0.0566 |
| 5 | 16QAM | 1 | 0 | 22.05 | 22.17 | 21.96 | 0.0468 | 0.0481 | 0.0458 |



LTE Band 41C:

| Combination 20MHz+20MHz (100RB+100RB) | | | | | | | |
|---------------------------------------|------------|---------|-----------|---------|-----------|----------------|---------|
| Channel | Modulation | PCC | | SCC | | Measured Power | EIRP(W) |
| | | RB Size | RB offset | RB Size | RB offset | | |
| L | QPSK | 1 | Max | 1 | 0 | 22.35 | 0.1059 |
| M | QPSK | 1 | Max | 1 | 0 | 22.61 | 0.1125 |
| H | QPSK | 1 | Max | 1 | 0 | 22.56 | 0.1112 |
| L | 16QAM | 1 | Max | 1 | 0 | 21.16 | 0.0805 |
| M | 16QAM | 1 | Max | 1 | 0 | 21.67 | 0.0906 |
| H | 16QAM | 1 | Max | 1 | 0 | 21.38 | 0.0847 |
| L | 64QAM | 1 | Max | 1 | 0 | 19.68 | 0.0573 |
| M | 64QAM | 1 | Max | 1 | 0 | 19.94 | 0.0608 |
| H | 64QAM | 1 | Max | 1 | 0 | 19.76 | 0.0583 |
| Combination 20MHz+15MHz (100RB+75RB) | | | | | | | |
| Channel | Modulation | PCC | | SCC | | Measured Power | EIRP(W) |
| | | RB Size | RB offset | RB Size | RB offset | | |
| M | QPSK | 1 | Max | 1 | 0 | 22.54 | 0.1107 |
| M | 16QAM | 1 | Max | 1 | 0 | 21.31 | 0.0834 |
| Combination 15MHz+20MHz (75RB+100RB) | | | | | | | |
| Channel | Modulation | PCC | | SCC | | Measured Power | EIRP(W) |
| | | RB Size | RB offset | RB Size | RB offset | | |
| M | QPSK | 1 | Max | 1 | 0 | 22.29 | 0.1045 |
| M | 16QAM | 1 | Max | 1 | 0 | 21.05 | 0.0785 |
| Combination 15MHz+15MHz (75RB+75RB) | | | | | | | |
| Channel | Modulation | PCC | | SCC | | Measured Power | EIRP(W) |
| | | RB Size | RB offset | RB Size | RB offset | | |
| M | QPSK | 1 | Max | 1 | 0 | 22.34 | 0.1057 |
| M | 16QAM | 1 | Max | 1 | 0 | 21.18 | 0.0809 |
| Combination 20MHz+10MHz (100RB+50RB) | | | | | | | |
| Channel | Modulation | PCC | | SCC | | Measured Power | EIRP(W) |
| | | RB Size | RB offset | RB Size | RB offset | | |
| M | QPSK | 1 | Max | 1 | 0 | 22.21 | 0.1026 |
| M | 16QAM | 1 | Max | 1 | 0 | 21.32 | 0.0836 |
| Combination 10MHz+20MHz (50RB+100RB) | | | | | | | |
| Channel | Modulation | PCC | | SCC | | Measured Power | EIRP(W) |
| | | RB Size | RB offset | RB Size | RB offset | | |
| M | QPSK | 1 | Max | 1 | 0 | 22.03 | 0.0984 |
| M | 16QAM | 1 | Max | 1 | 0 | 21.18 | 0.0809 |
| Combination 15MHz+10MHz (75RB+50RB) | | | | | | | |
| Channel | Modulation | PCC | | SCC | | Measured Power | EIRP(W) |
| | | RB Size | RB offset | RB Size | RB offset | | |
| M | QPSK | 1 | Max | 1 | 0 | 22.24 | 0.1033 |
| M | 16QAM | 1 | Max | 1 | 0 | 21.14 | 0.0802 |



| Combination 10MHz+15MHz (50RB+75RB) | | | | | | | |
|-------------------------------------|------------|---------|-----------|---------|-----------|----------------|---------|
| Channel | Modulation | PCC | | SCC | | Measured Power | EIRP(W) |
| | | RB Size | RB offset | RB Size | RB offset | | |
| M | QPSK | 1 | Max | 1 | 0 | 22.52 | 0.1102 |
| M | 16QAM | 1 | Max | 1 | 0 | 21.13 | 0.0800 |
| Combination 20MHz+5MHz (100RB+25RB) | | | | | | | |
| Channel | Modulation | PCC | | SCC | | Measured Power | EIRP(W) |
| | | RB Size | RB offset | RB Size | RB offset | | |
| M | QPSK | 1 | Max | 1 | 0 | 22.49 | 0.1094 |
| M | 16QAM | 1 | Max | 1 | 0 | 21.15 | 0.0804 |
| Combination 5MHz+20MHz (25RB+100RB) | | | | | | | |
| Channel | Modulation | PCC | | SCC | | Measured Power | EIRP(W) |
| | | RB Size | RB offset | RB Size | RB offset | | |
| M | QPSK | 1 | Max | 1 | 0 | 22.18 | 0.1019 |
| M | 16QAM | 1 | Max | 1 | 0 | 21.01 | 0.0778 |



LTE Band 7

Peak-to-Average Ratio

| Mode | LTE Band 7 / 20MHz | | | |
|-----------|--------------------|---------|---------|-------------|
| Mod. | QPSK | 16QAM | 64QAM | Limit: 13dB |
| RB Size | Full RB | Full RB | Full RB | Result |
| Middle CH | 5.33 | 6.38 | 4.43 | PASS |

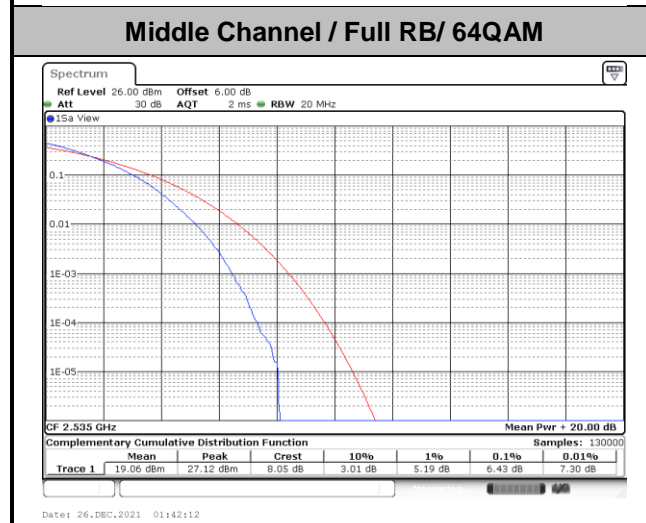
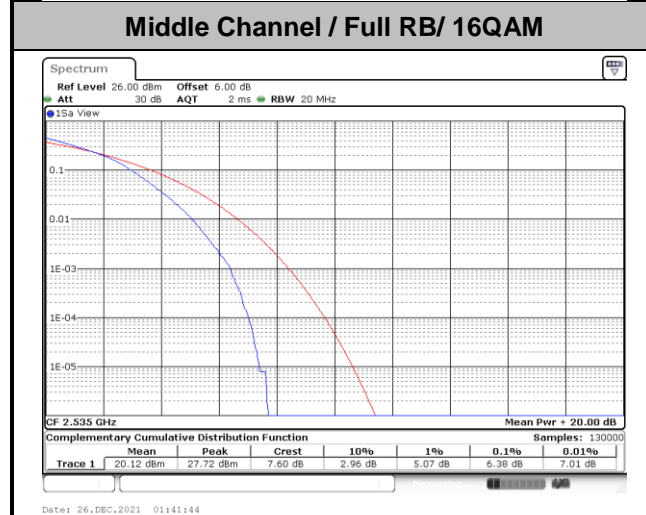
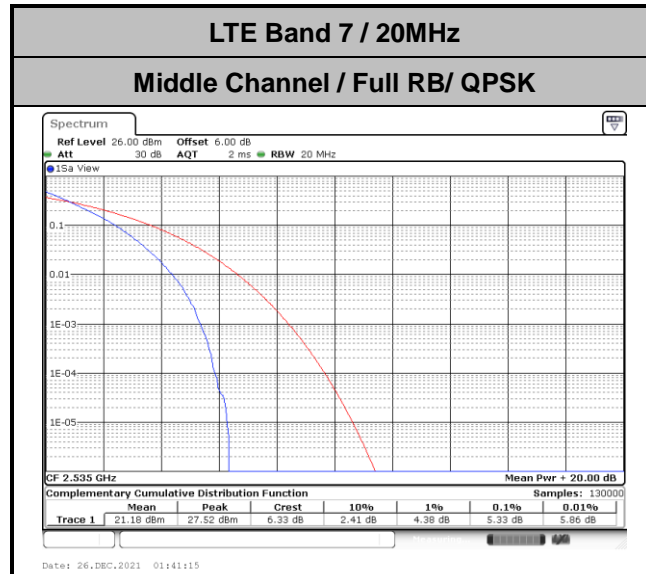



26dB Bandwidth

| | | |
|------------------|----------------------------------|--------------|
| Mode | LTE Band 7 : 26dB BW(MHz) | |
| BW | 20MHz | |
| Mod. | QPSK | 16QAM |
| Middle CH | 19.14 | 18.94 |

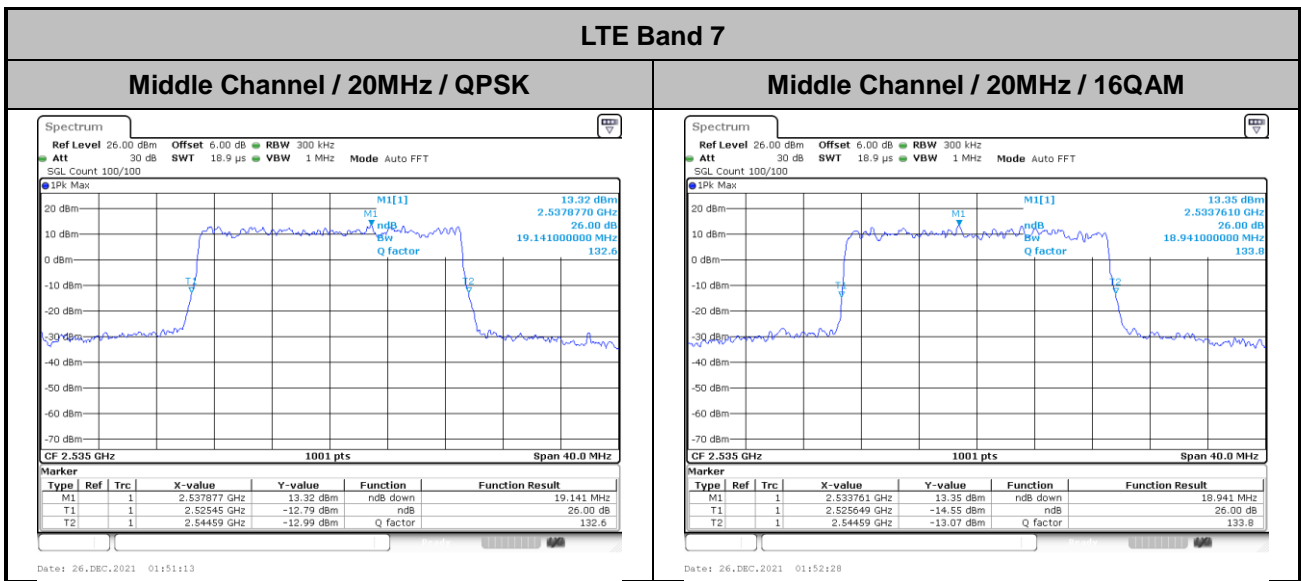



Occupied Bandwidth

| | | |
|-----------|--------------------------|-------|
| Mode | LTE Band 7 : 99%OBW(MHz) | |
| BW | 20MHz | |
| Mod. | QPSK | 16QAM |
| Middle CH | 17.90 | 17.90 |

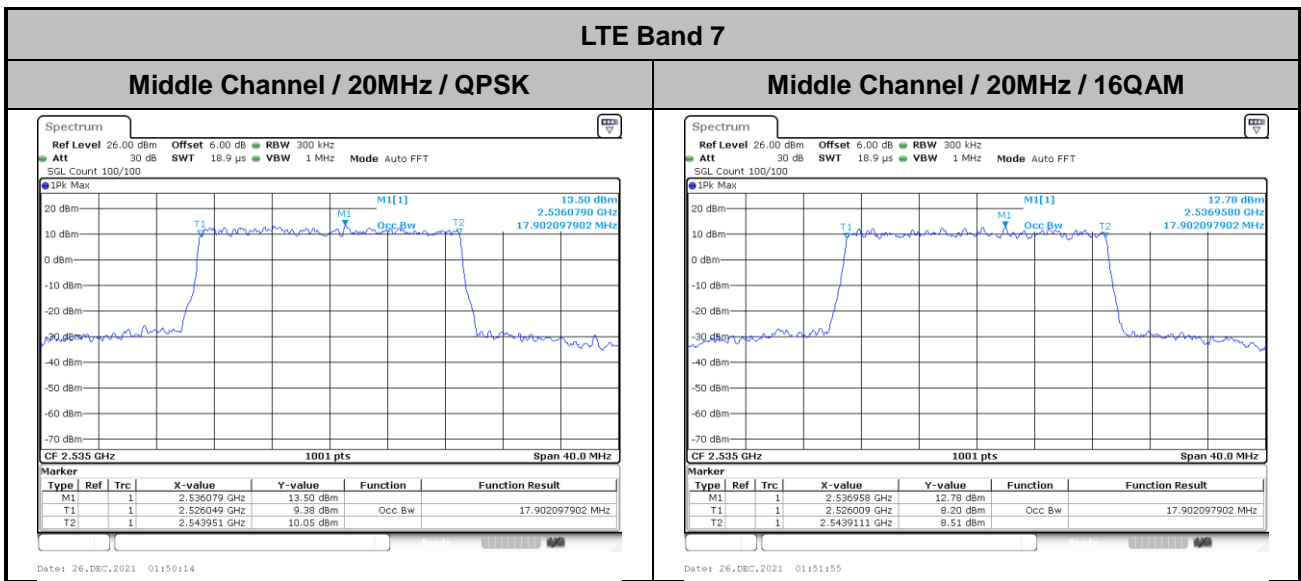



Conducted Band Edge

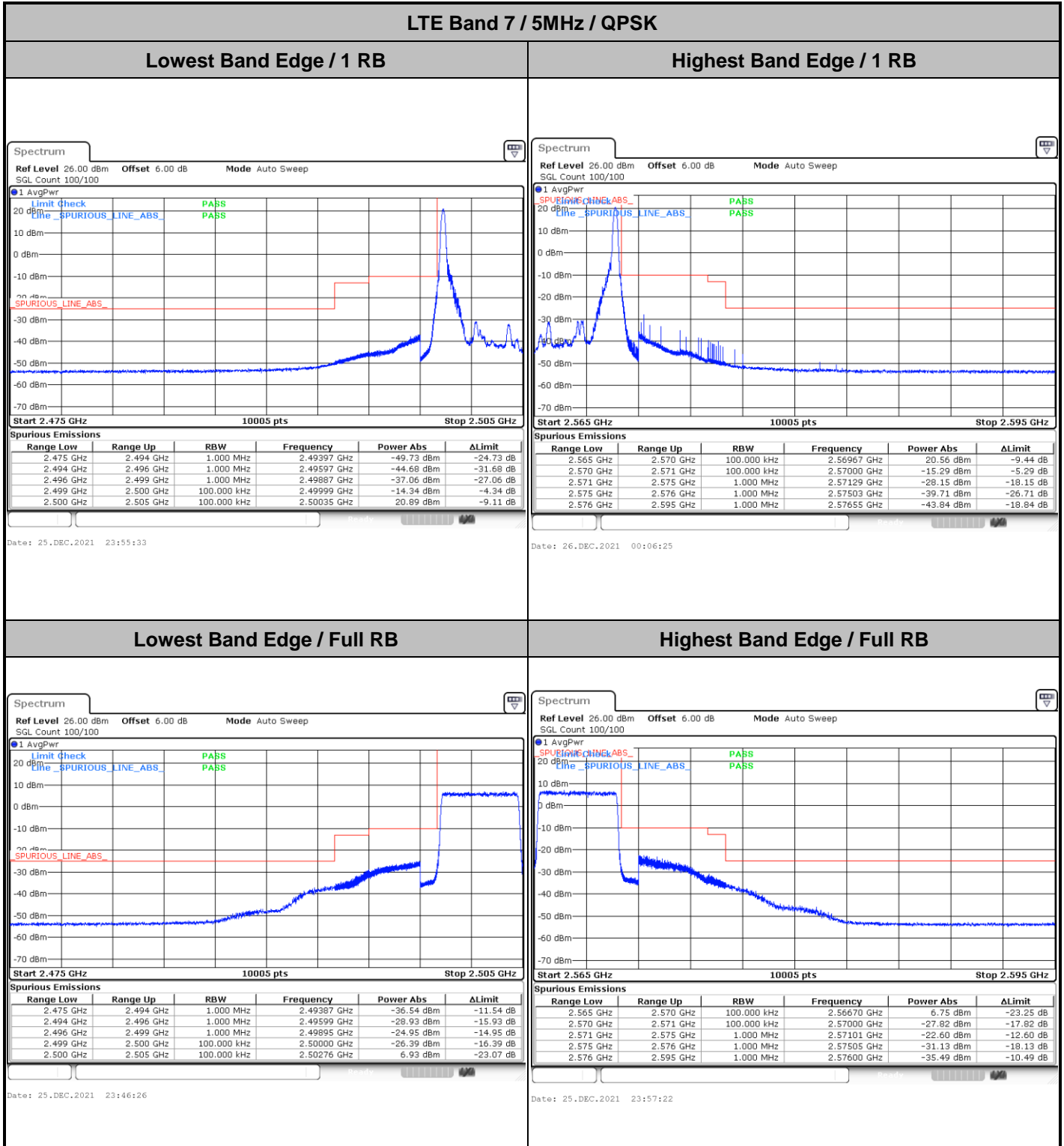



LTE Band 7 / 5MHz / 16QAM

Lowest Band Edge / 1RB

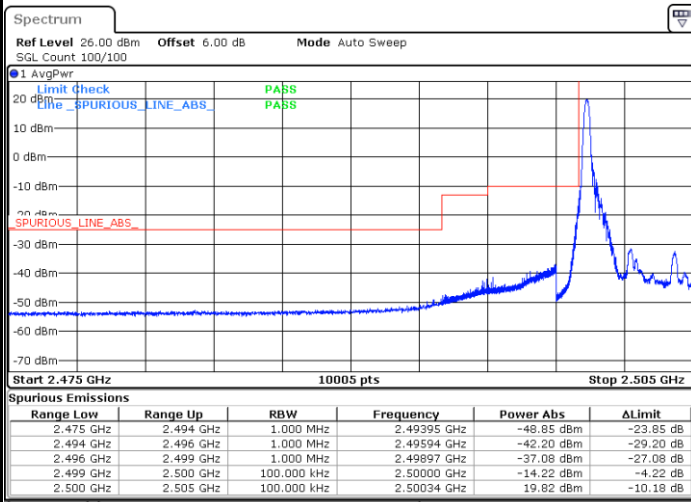

Date: 25.DEC.2021 23:53:44

Highest Band Edge / 1 RB

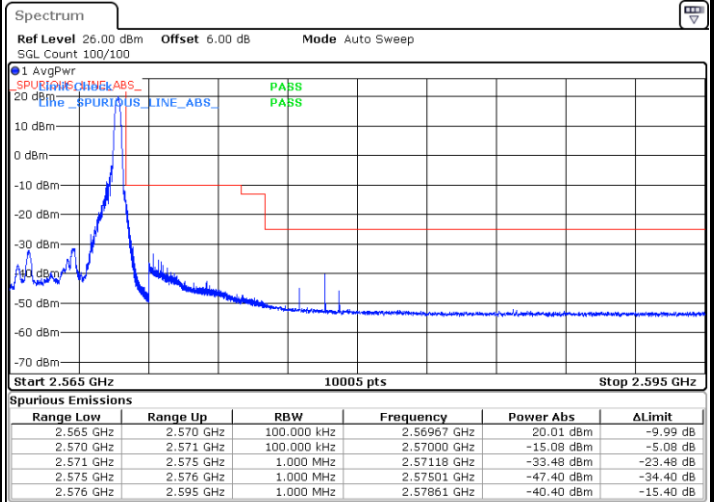

Date: 26.DEC.2021 00:04:37

Lowest Band Edge / Full RB

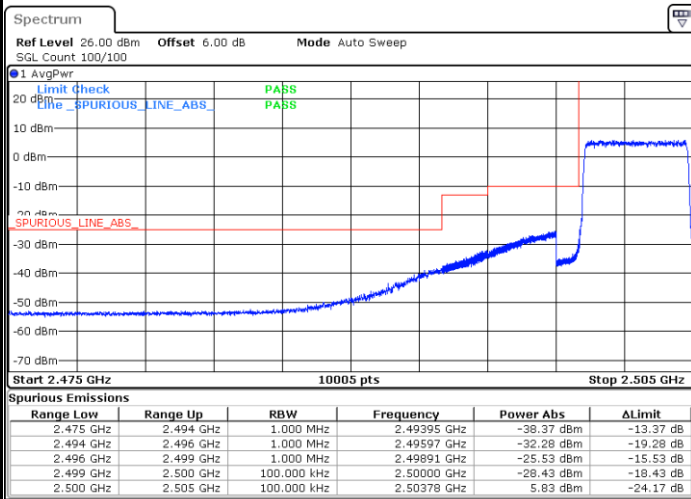

Date: 25.DEC.2021 23:48:15

Highest Band Edge / Full RB

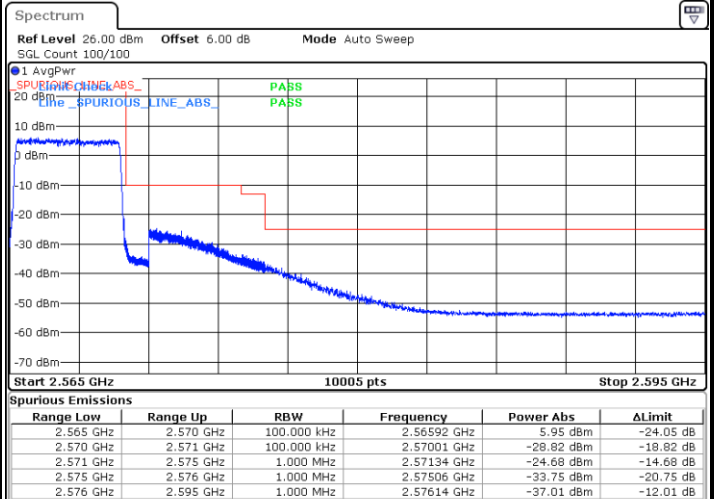

Date: 25.DEC.2021 23:59:11



LTE Band 7 / 5MHz / 64QAM

Lowest Band Edge / 1RB

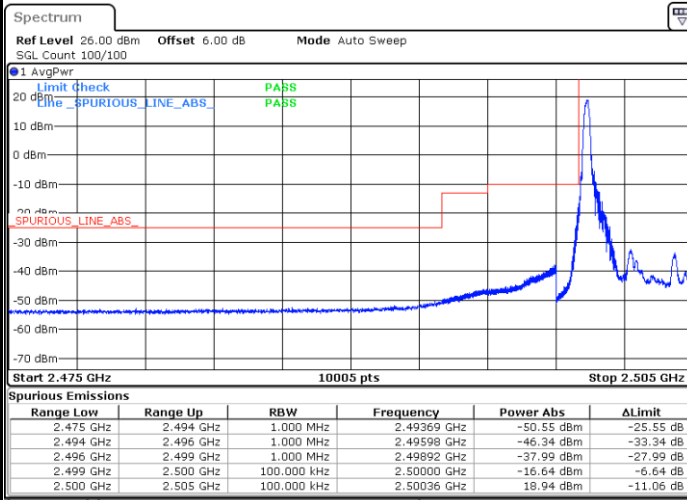

Date: 25.DEC.2021 23:51:54

Highest Band Edge / 1 RB

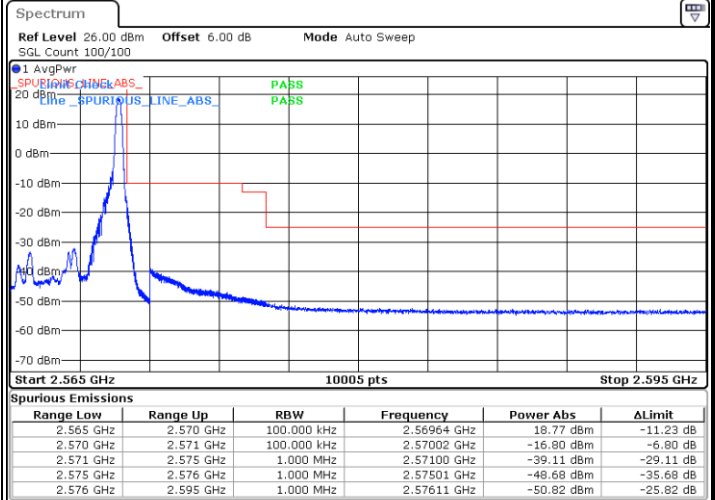

Date: 26.DEC.2021 00:02:48

Lowest Band Edge / Full RB

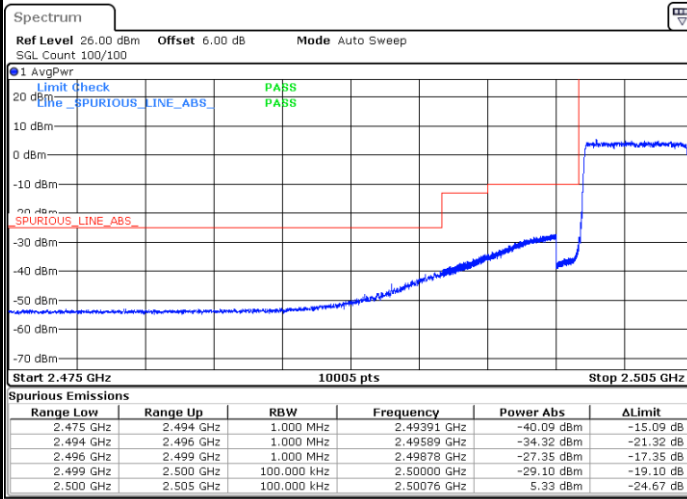

Date: 25.DEC.2021 23:50:04

Highest Band Edge / Full RB

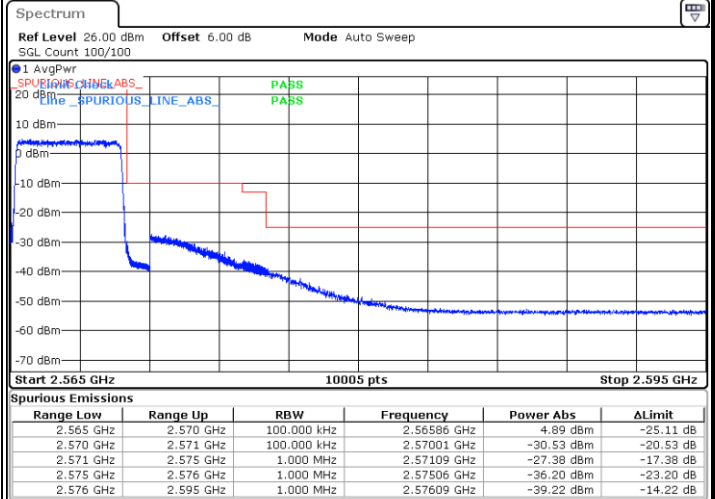

Date: 26.DEC.2021 00:00:59



LTE Band 7 / 10MHz / QPSK

Lowest Band Edge / 1 RB

Highest Band Edge / 1 RB

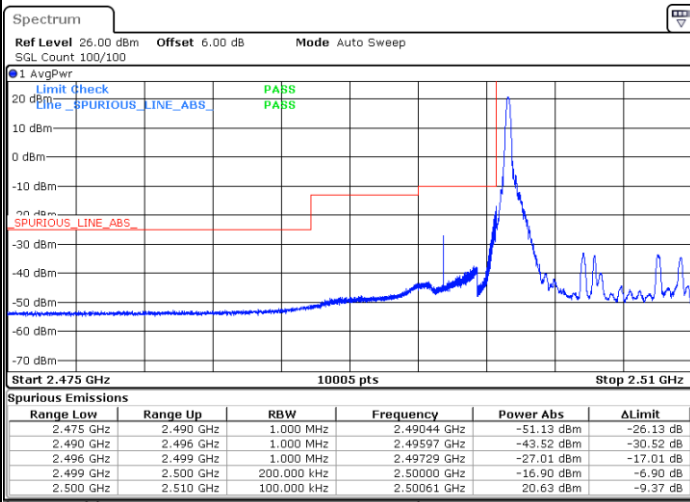

Date: 26.DEC.2021 00:17:14

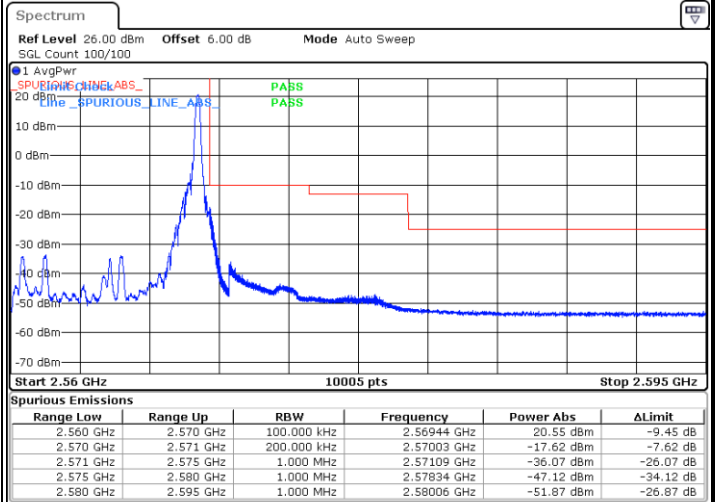

Date: 26.DEC.2021 00:28:01

Lowest Band Edge / Full RB

Highest Band Edge / Full RB

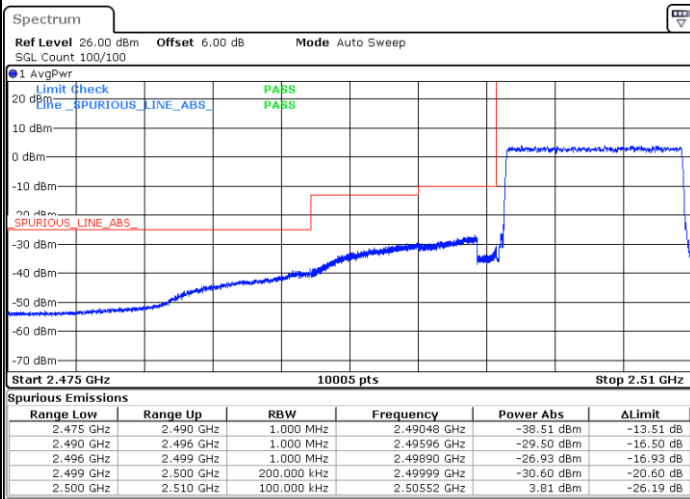

Date: 26.DEC.2021 00:08:14

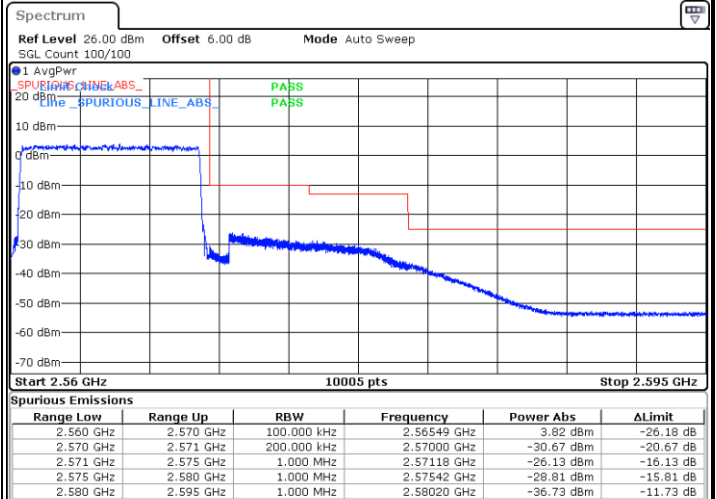

Date: 26.DEC.2021 00:19:02



LTE Band 7 / 10MHz / 16QAM

Lowest Band Edge / 1 RB

Highest Band Edge / 1 RB

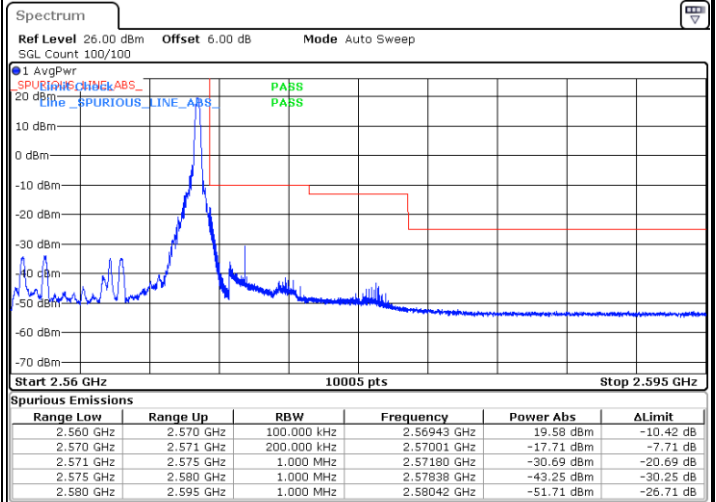
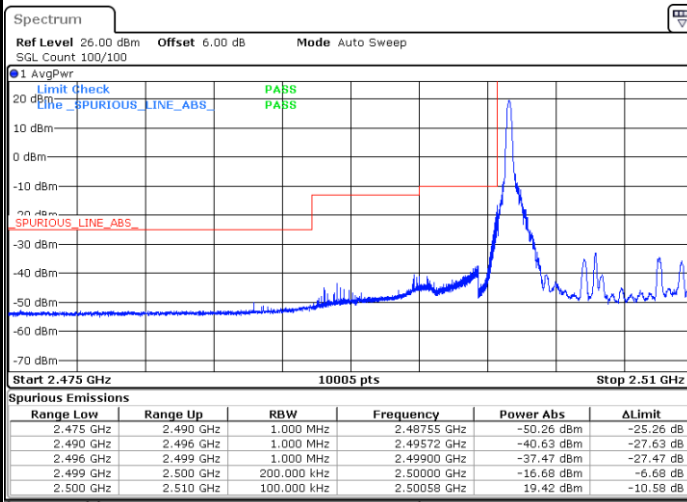

Date: 26.DEC.2021 00:15:26

Date: 26.DEC.2021 00:26:13

Lowest Band Edge / Full RB

Highest Band Edge / Full RB

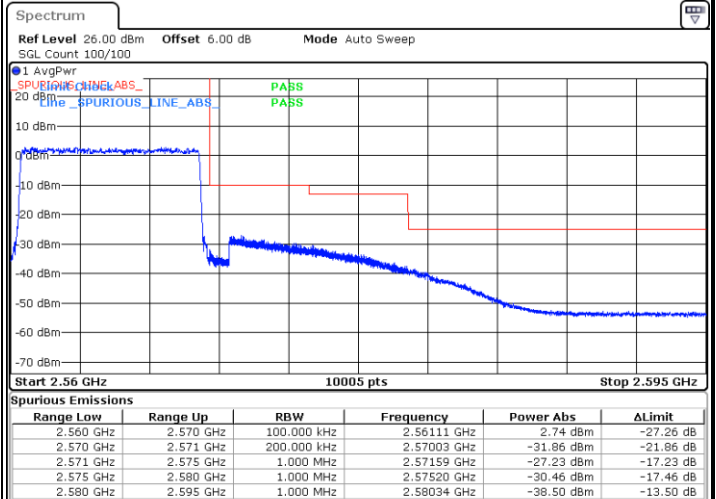
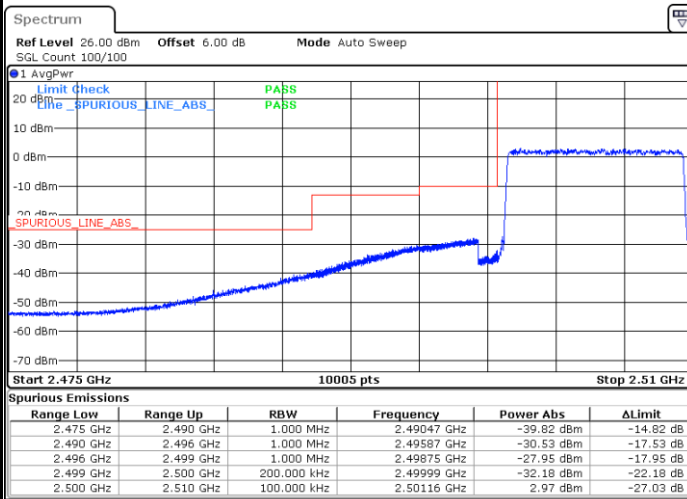

Date: 26.DEC.2021 00:10:01

Date: 26.DEC.2021 00:20:50



LTE Band 7 / 10MHz / 64QAM

Lowest Band Edge / 1 RB

Highest Band Edge / 1 RB

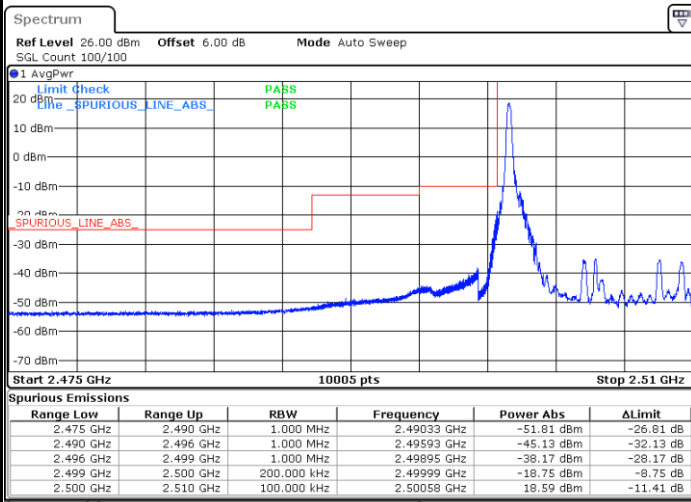

Date: 26.DEC.2021 00:13:38

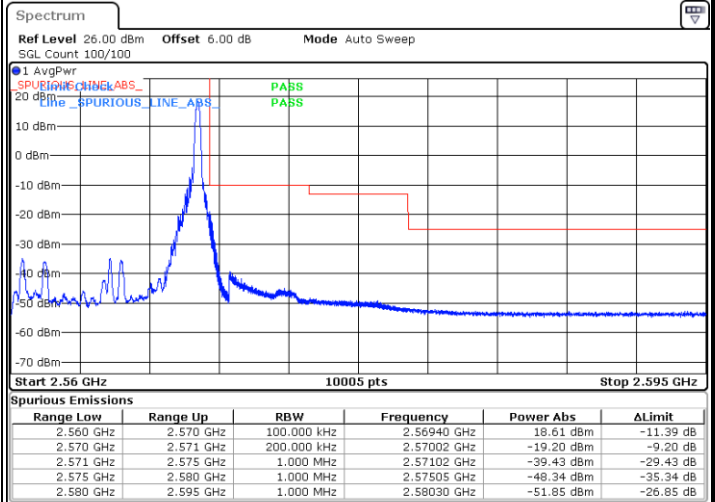

Date: 26.DEC.2021 00:24:26

Lowest Band Edge / Full RB

Highest Band Edge / Full RB

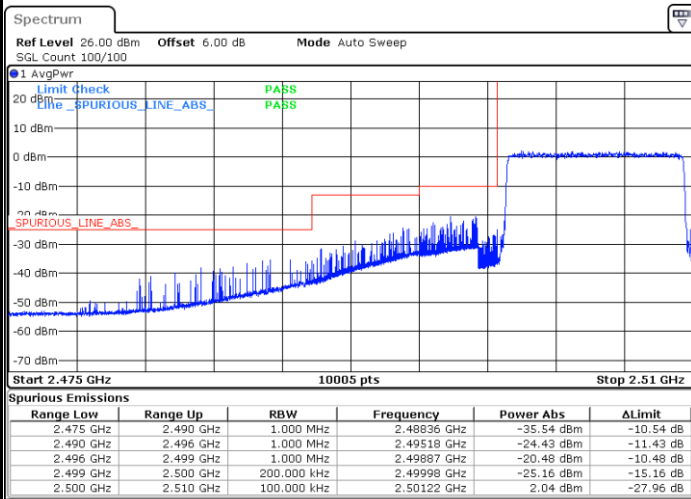

Date: 26.DEC.2021 00:11:50

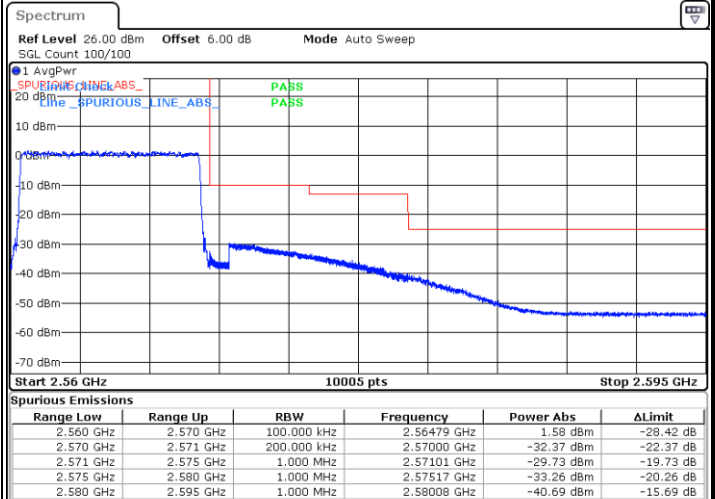

Date: 26.DEC.2021 00:22:38



LTE Band 7 / 15MHz / QPSK

Lowest Band Edge / 1 RB

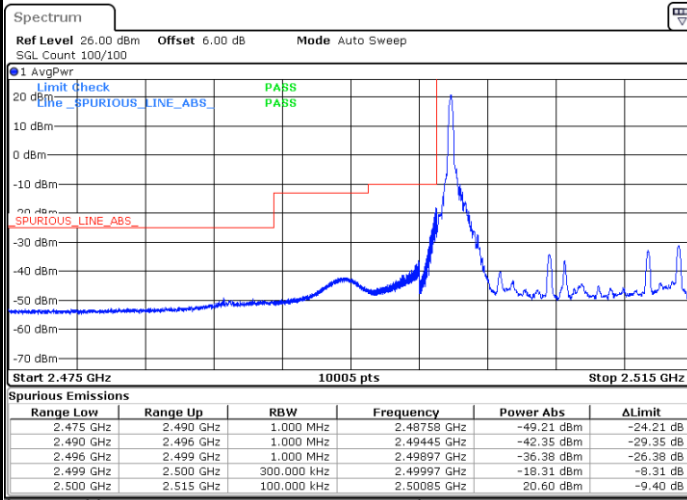

Date: 26.DEC.2021 00:38:50

Highest Band Edge / 1 RB

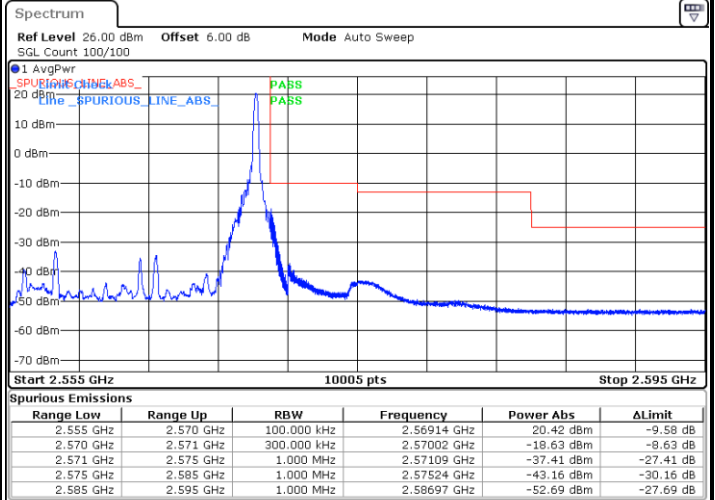

Date: 26.DEC.2021 00:49:37

Lowest Band Edge / Full RB

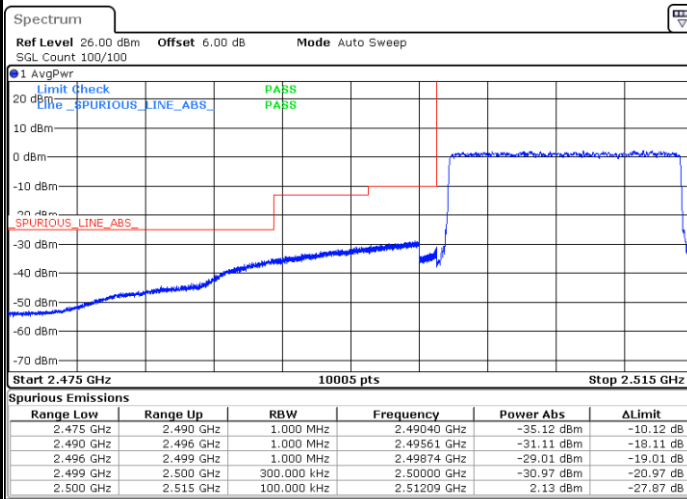

Date: 26.DEC.2021 00:29:50

Highest Band Edge / Full RB

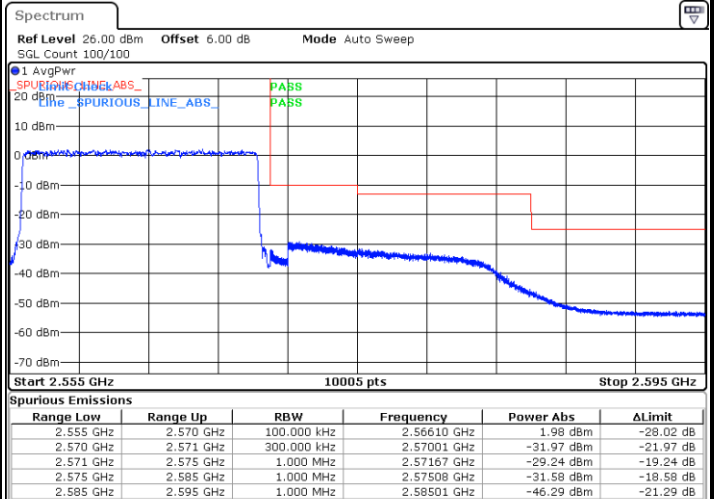

Date: 26.DEC.2021 00:40:38



LTE Band 7 / 15MHz / 16QAM

Lowest Band Edge / 1 RB

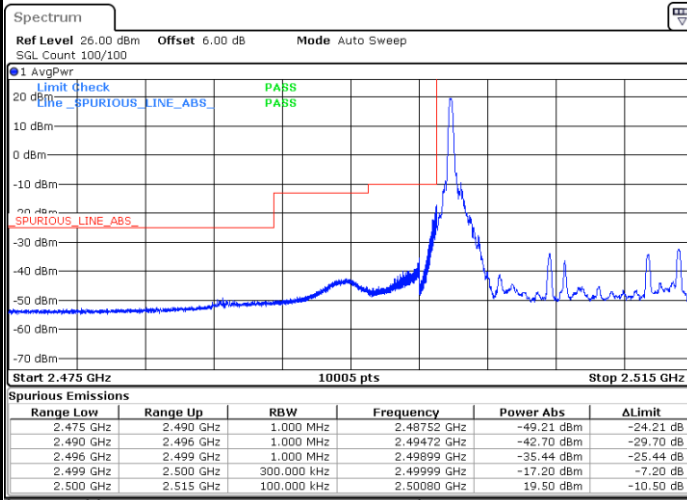

Date: 26.DEC.2021 00:37:02

Highest Band Edge / 1 RB

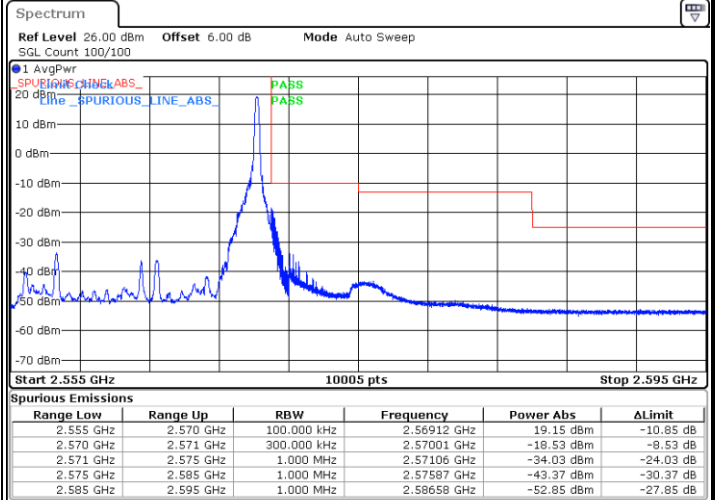

Date: 26.DEC.2021 00:47:49

Lowest Band Edge / Full RB

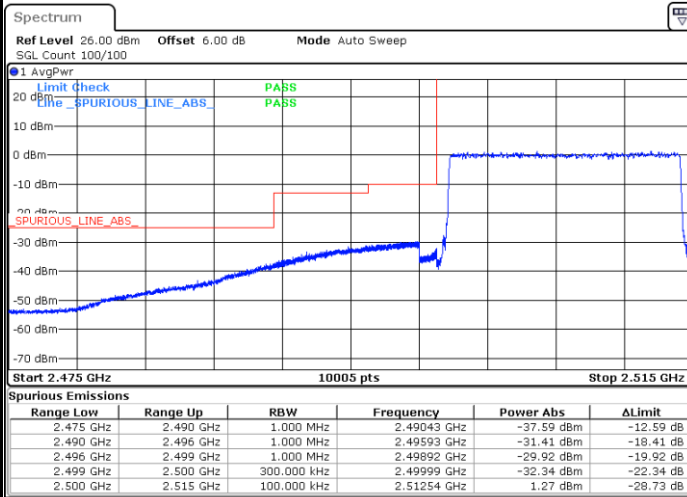

Date: 26.DEC.2021 00:31:38

Highest Band Edge / Full RB

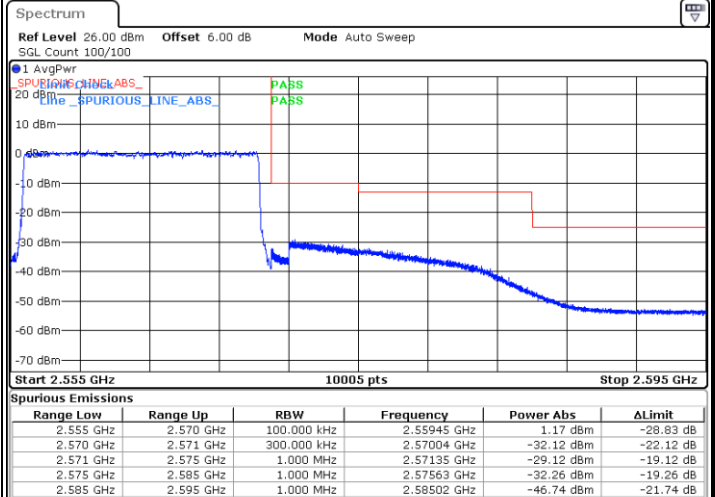

Date: 26.DEC.2021 00:42:26



LTE Band 7 / 15MHz / 64QAM

Lowest Band Edge / 1 RB

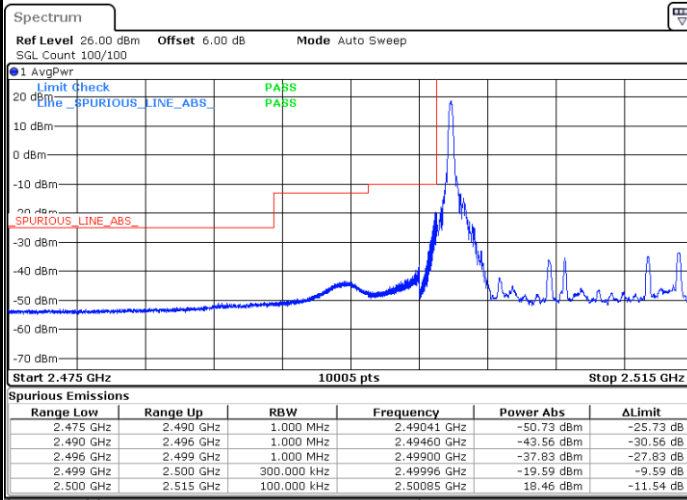

Date: 26.DEC.2021 00:35:14

Highest Band Edge / 1 RB

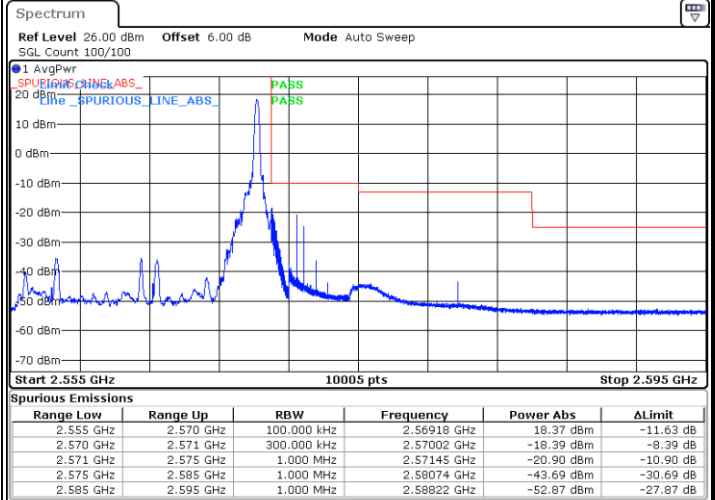

Date: 26.DEC.2021 00:46:02

Lowest Band Edge / Full RB

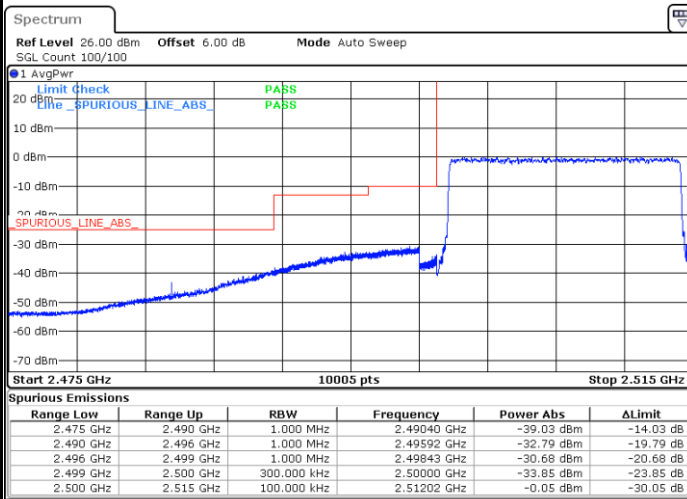

Date: 26.DEC.2021 00:33:26

Highest Band Edge / Full RB

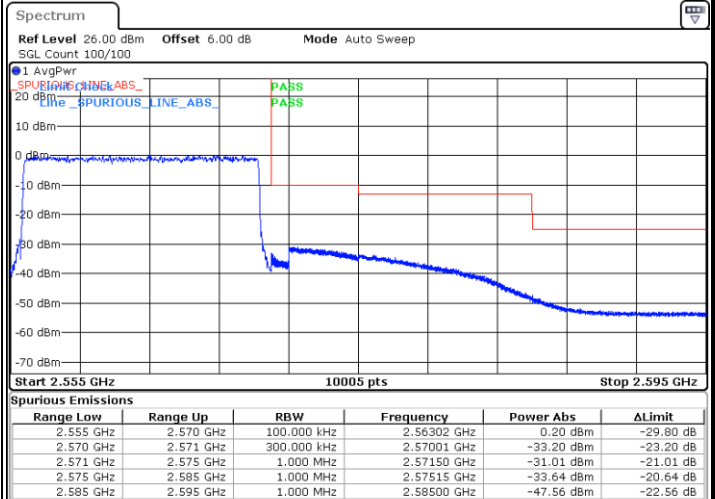

Date: 26.DEC.2021 00:44:14



LTE Band 7 / 20MHz / QPSK

Lowest Band Edge / 1 RB

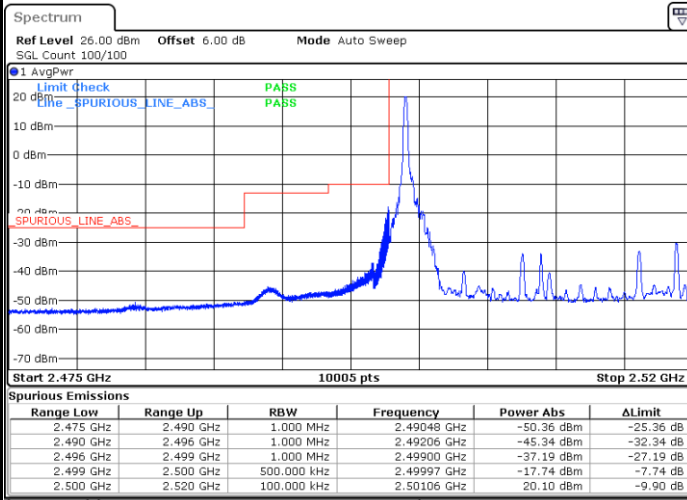

Date: 26.DEC.2021 01:00:23

Highest Band Edge / 1 RB

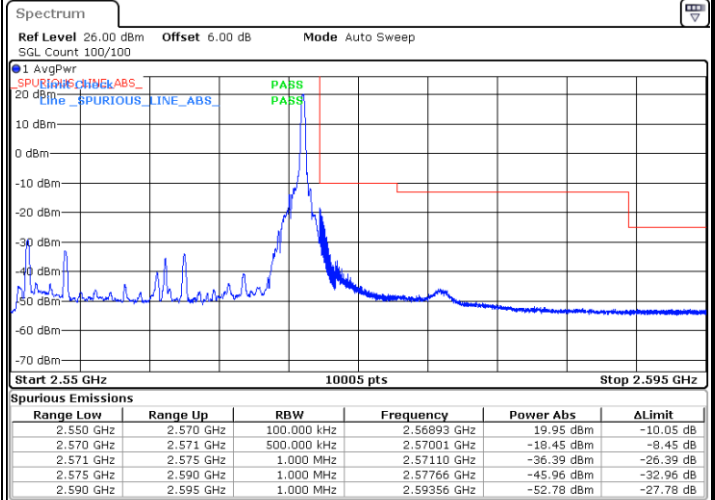

Date: 26.DEC.2021 01:11:10

Lowest Band Edge / Full RB

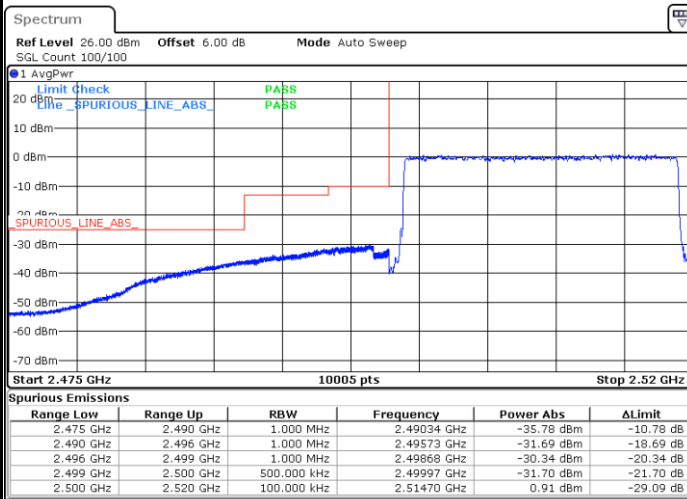

Date: 26.DEC.2021 00:51:25

Highest Band Edge / Full RB

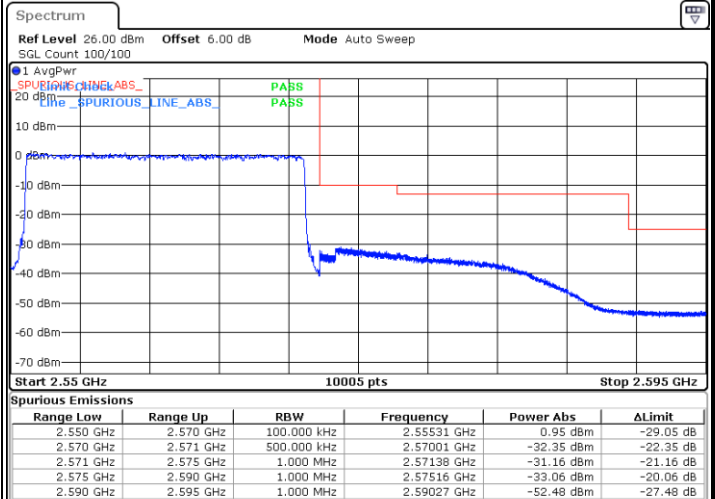

Date: 26.DEC.2021 01:02:11



LTE Band 7 / 20MHz / 16QAM

Lowest Band Edge / 1 RB

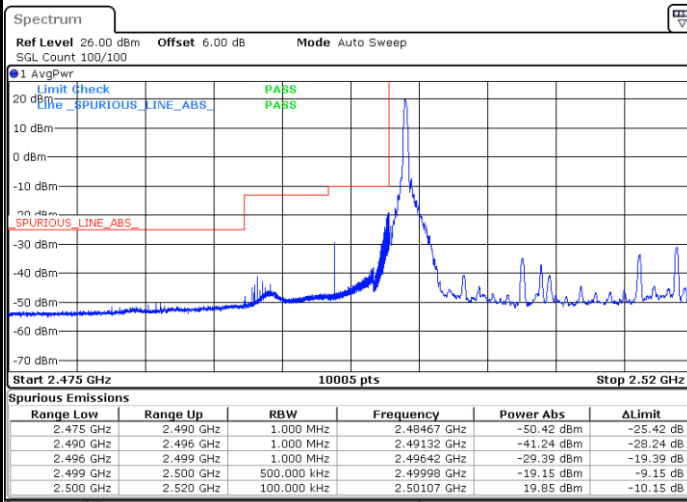

Date: 26.DEC.2021 00:58:35

Highest Band Edge / 1 RB

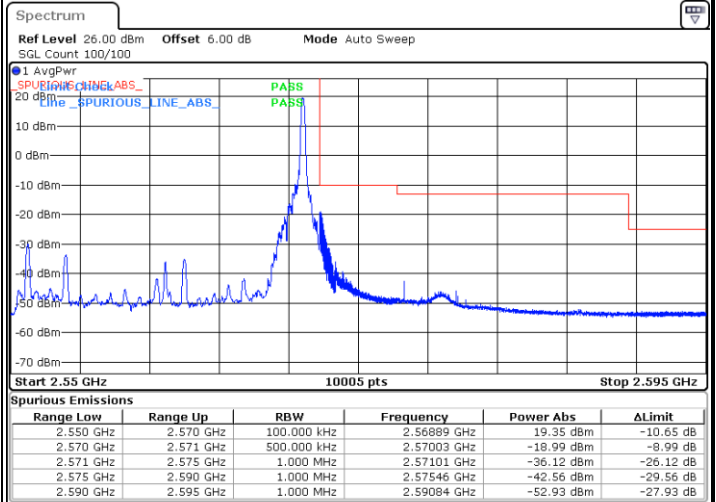

Date: 26.DEC.2021 01:09:23

Lowest Band Edge / Full RB

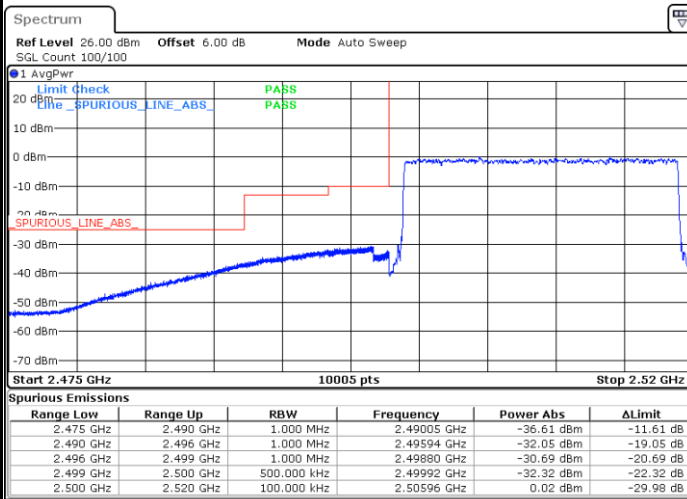

Date: 26.DEC.2021 00:53:13

Highest Band Edge / Full RB

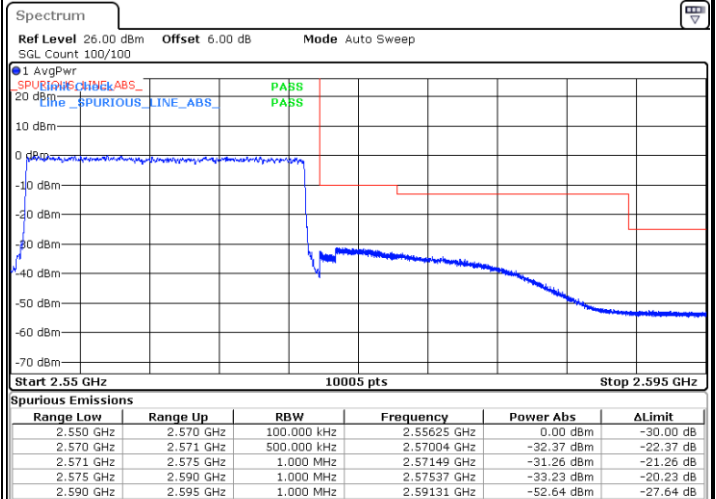

Date: 26.DEC.2021 01:04:00



LTE Band 7 / 20MHz / 64QAM

Lowest Band Edge / 1 RB

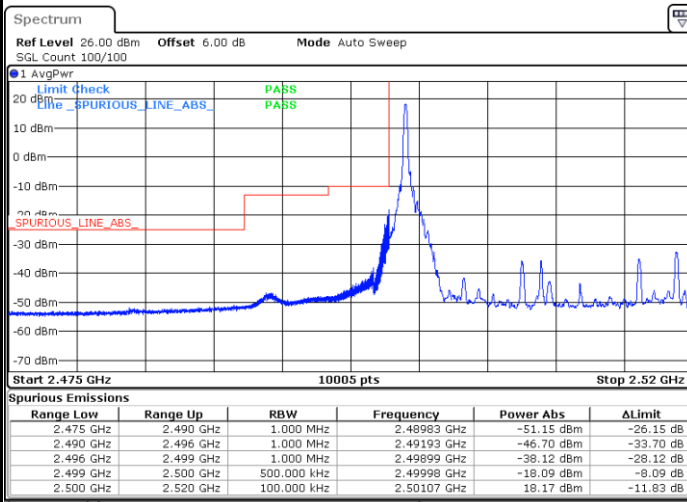

Date: 26.DEC.2021 00:56:48

Highest Band Edge / 1 RB

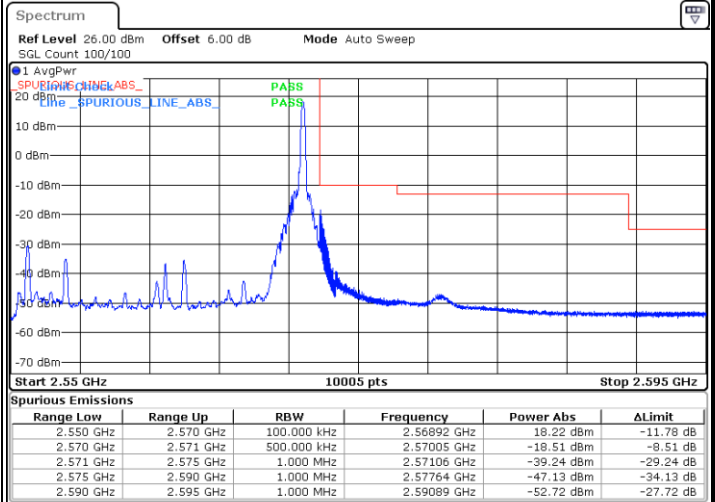

Date: 26.DEC.2021 01:07:35

Lowest Band Edge / Full RB

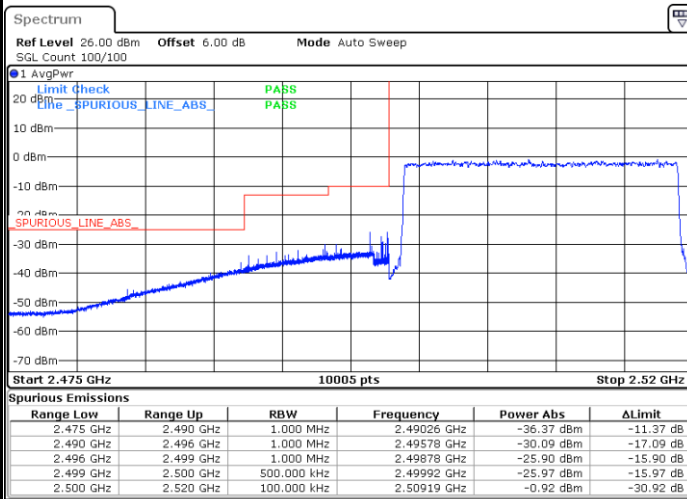

Date: 26.DEC.2021 00:55:00

Highest Band Edge / Full RB

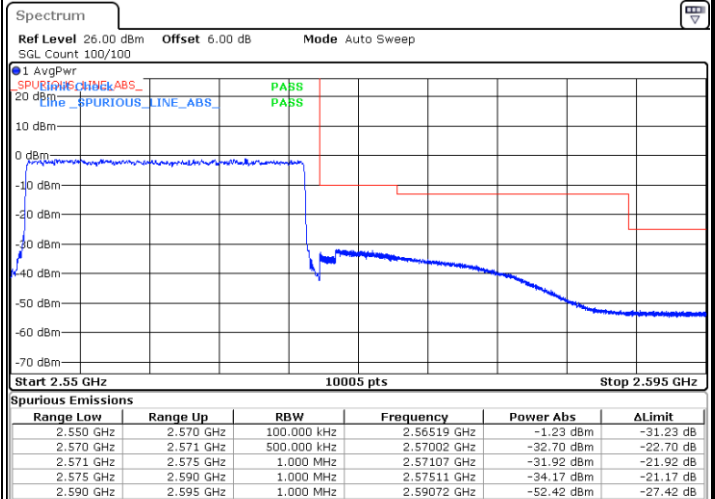

Date: 26.DEC.2021 01:05:48



Conducted Spurious Emission





LTE Band 7 / 10MHz

Lowest Channel / QPSK

Middle Channel / QPSK

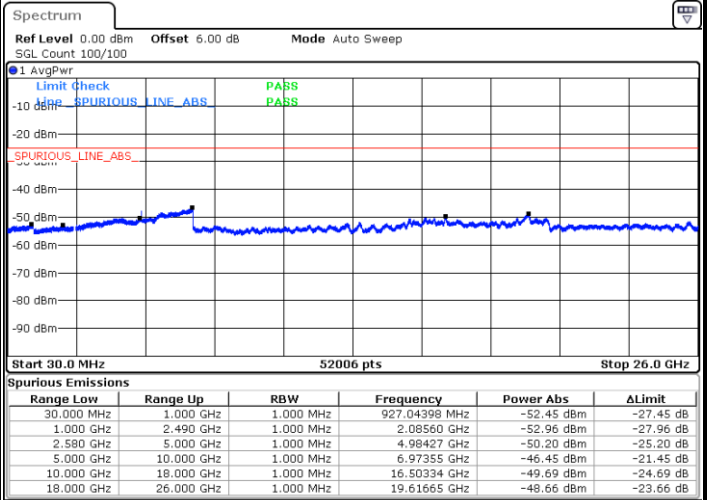
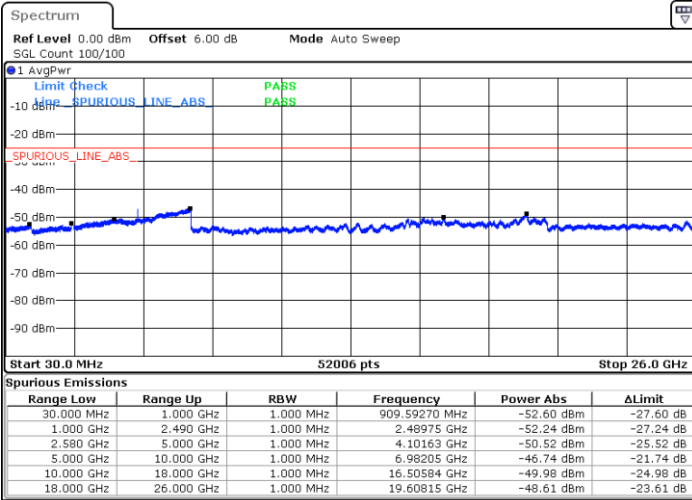

Date: 26.DEC.2021 01:28:28

Date: 26.DEC.2021 01:30:56

Highest Channel / QPSK

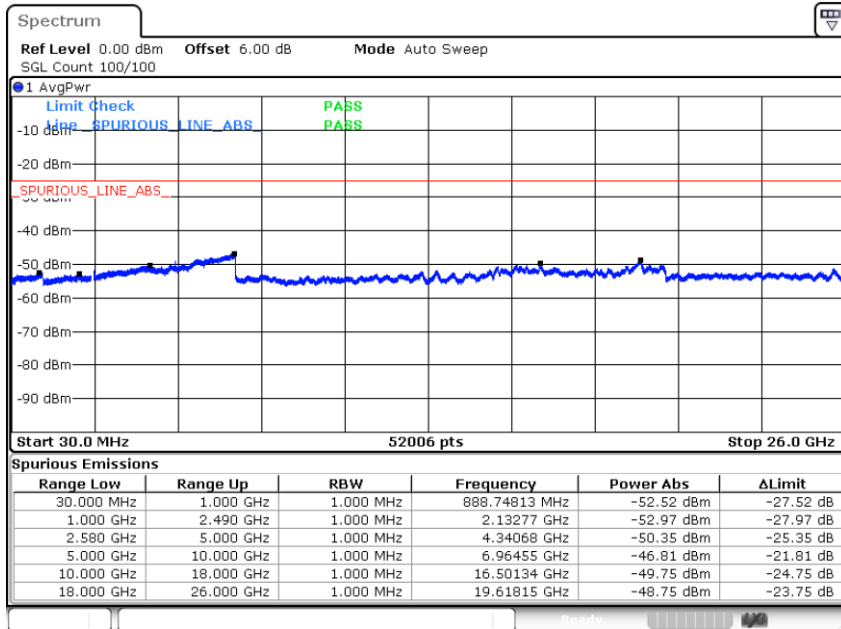

Date: 26.DEC.2021 01:33:23



LTE Band 7 / 15MHz

Lowest Channel / QPSK

Middle Channel / QPSK

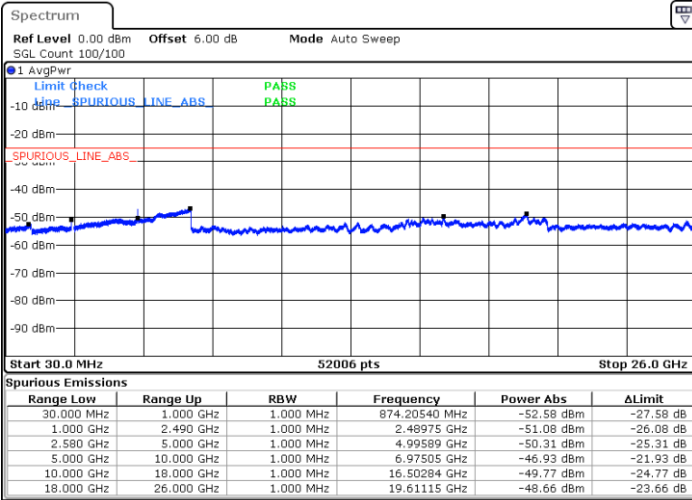

Date: 26.DEC.2021 01:21:02

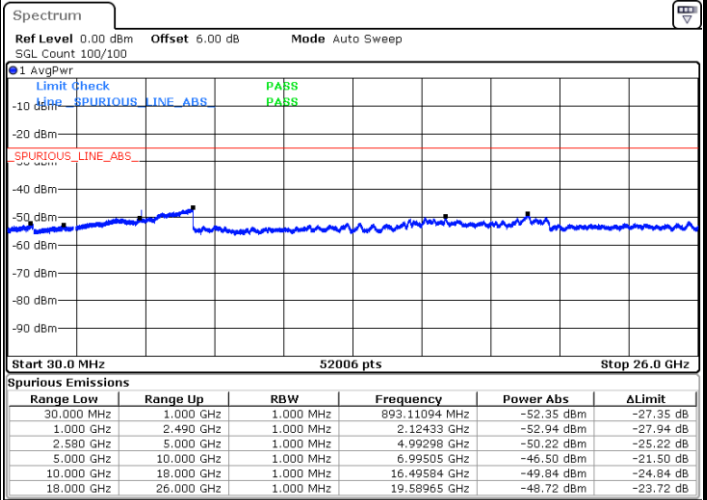

Date: 26.DEC.2021 01:23:33

Highest Channel / QPSK

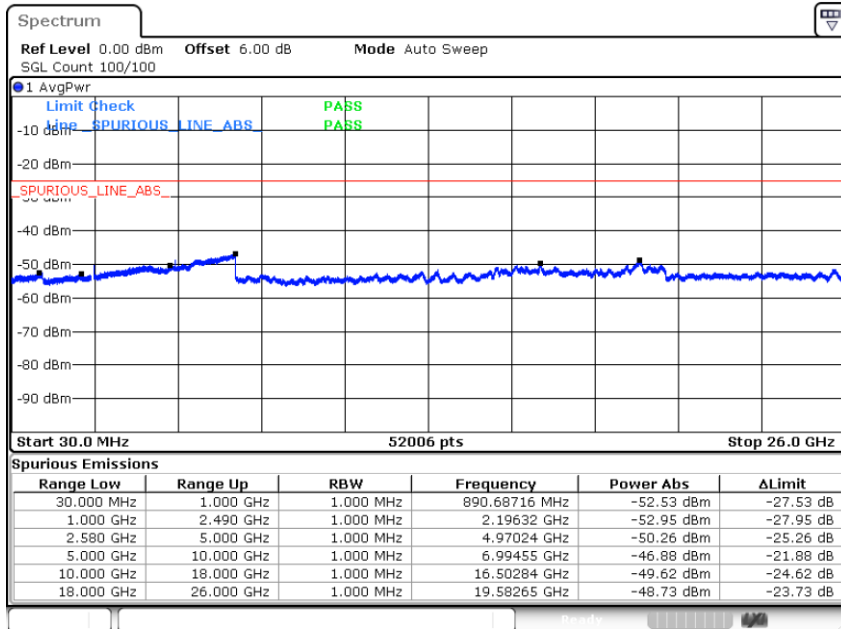

Date: 26.DEC.2021 01:26:00



LTE Band 7 / 20MHz

Lowest Channel / QPSK

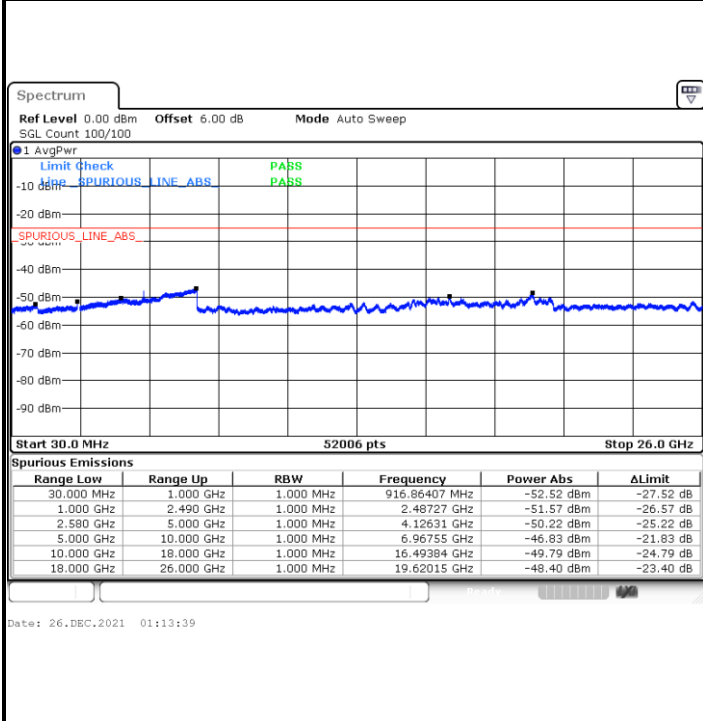

Middle Channel / QPSK

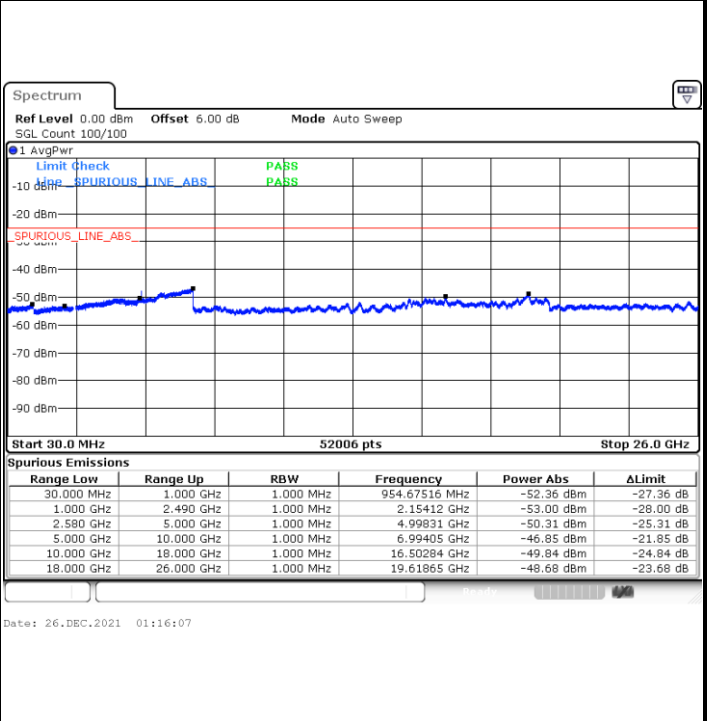

Highest Channel / QPSK

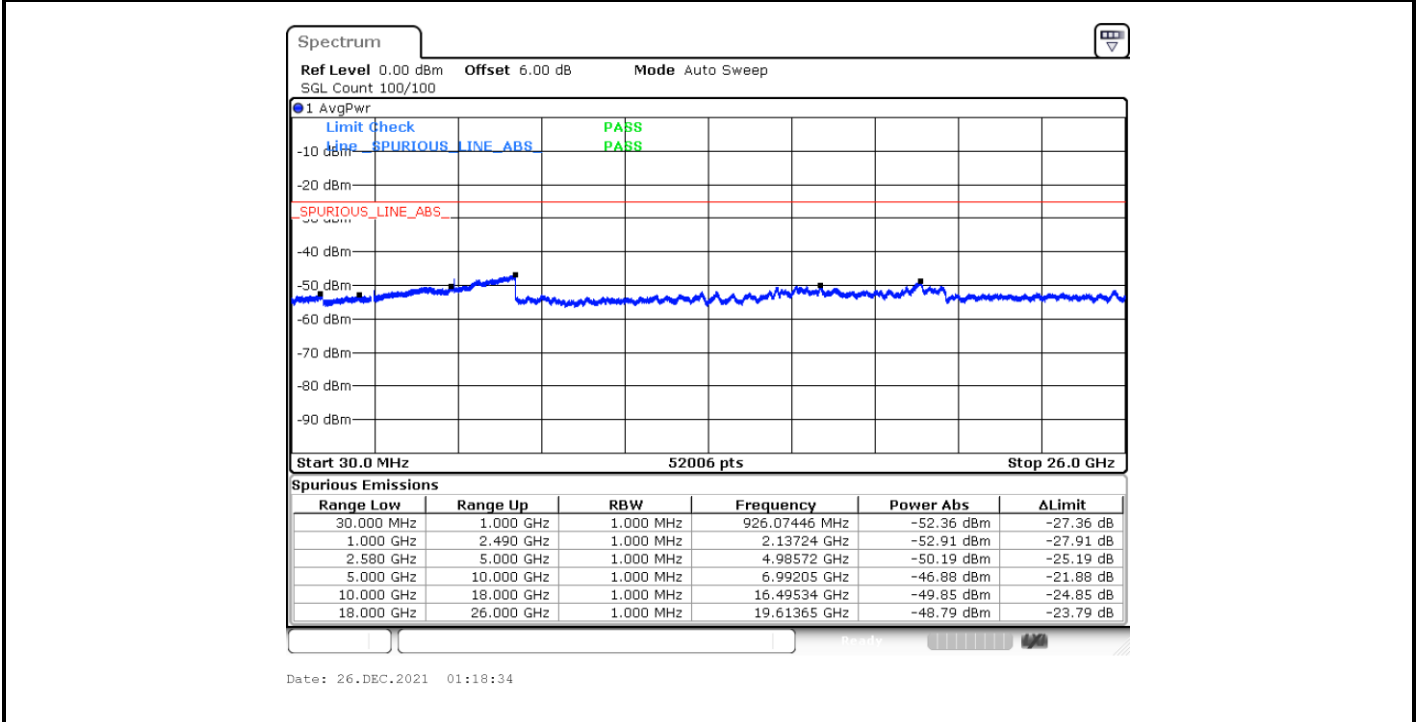



Frequency Stability

| Test Conditions | | LTE Band 7 (QPSK) / Middle Channel | Limit |
|------------------|-------------------|------------------------------------|---------|
| Temperature (°C) | Voltage (Volt) | BW 10MHz | Note 2. |
| | | Deviation (ppm) | Result |
| 50 | Normal Voltage | 0.0012 | PASS |
| 40 | Normal Voltage | 0.0034 | |
| 30 | Normal Voltage | 0.0006 | |
| 20(Ref.) | Normal Voltage | 0.0000 | |
| 10 | Normal Voltage | 0.0045 | |
| 0 | Normal Voltage | 0.0003 | |
| -10 | Normal Voltage | 0.0012 | |
| -20 | Normal Voltage | 0.0031 | |
| -30 | Normal Voltage | 0.0005 | |
| 20 | Maximum Voltage | 0.0012 | |
| 20 | Normal Voltage | 0.0033 | |
| 20 | Battery End Point | 0.0028 | |

Note:

1. Normal Voltage =3.8V. ; Battery End Point (BEP) = 3.6V. ; Maximum Voltage =4.4 V.
2. Note: The frequency fundamental emissions stay within the authorized frequency block.



LTE Band 12

Peak-to-Average Ratio

| Mode | LTE Band 12 / 10MHz | | | |
|-----------|---------------------|---------|---------|-------------|
| Mod. | QPSK | 16QAM | 64QAM | Limit: 13dB |
| RB Size | Full RB | Full RB | Full RB | Result |
| Middle CH | 5.48 | 6.38 | 6.75 | PASS |



LTE Band 12 / 10MHz

Middle Channel / Full RB/ QPSK

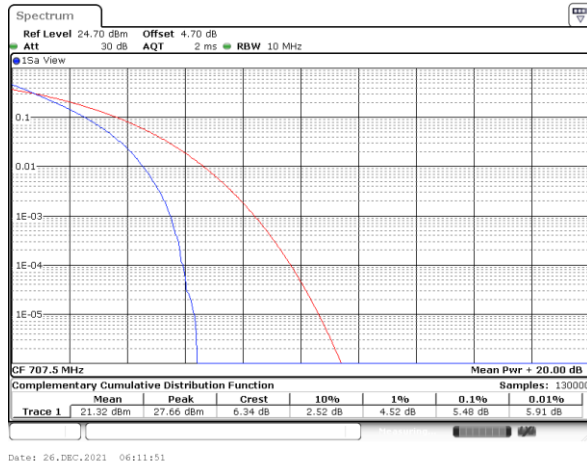

Date: 26.DEC.2021 06:11:51

Middle Channel / Full RB/ 16QAM

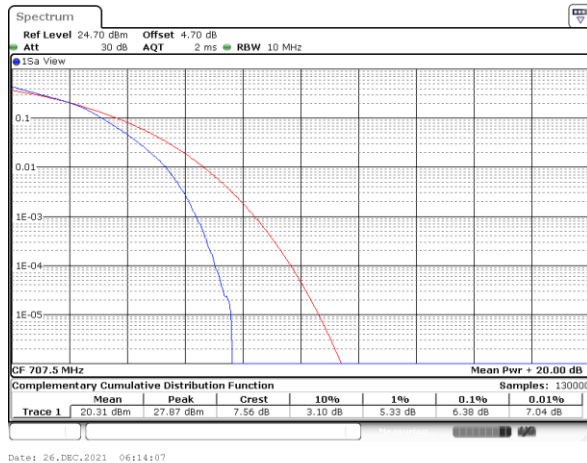

Date: 26.DEC.2021 06:14:07

Middle Channel / Full RB/ 64QAM

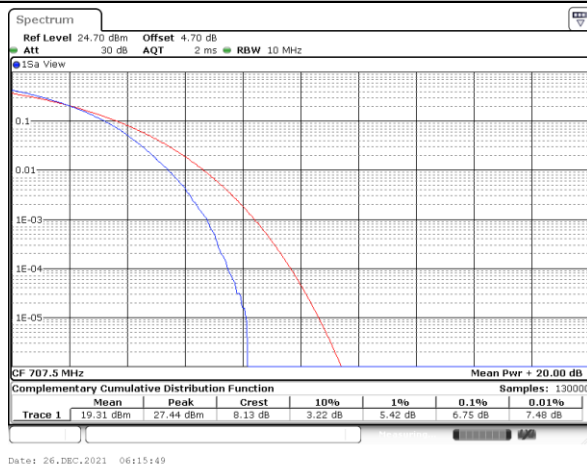

Date: 26.DEC.2021 06:15:49



26dB Bandwidth

| | | |
|-----------|----------------------------|-------|
| Mode | LTE Band 12 : 26dB BW(MHz) | |
| BW | 10MHz | |
| Mod. | QPSK | 16QAM |
| Middle CH | 9.73 | 9.75 |

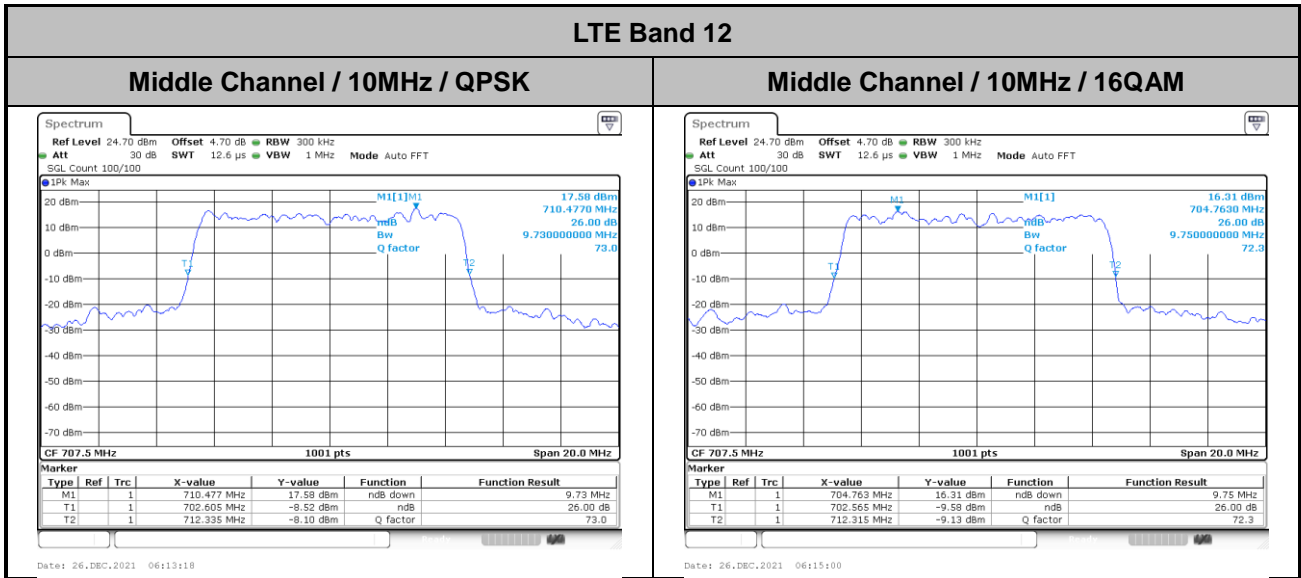



Occupied Bandwidth

| | | |
|------------------|----------------------------------|--------------|
| Mode | LTE Band 12 : 99%OBW(MHz) | |
| BW | 10MHz | |
| Mod. | QPSK | 16QAM |
| Middle CH | 9.05 | 9.01 |

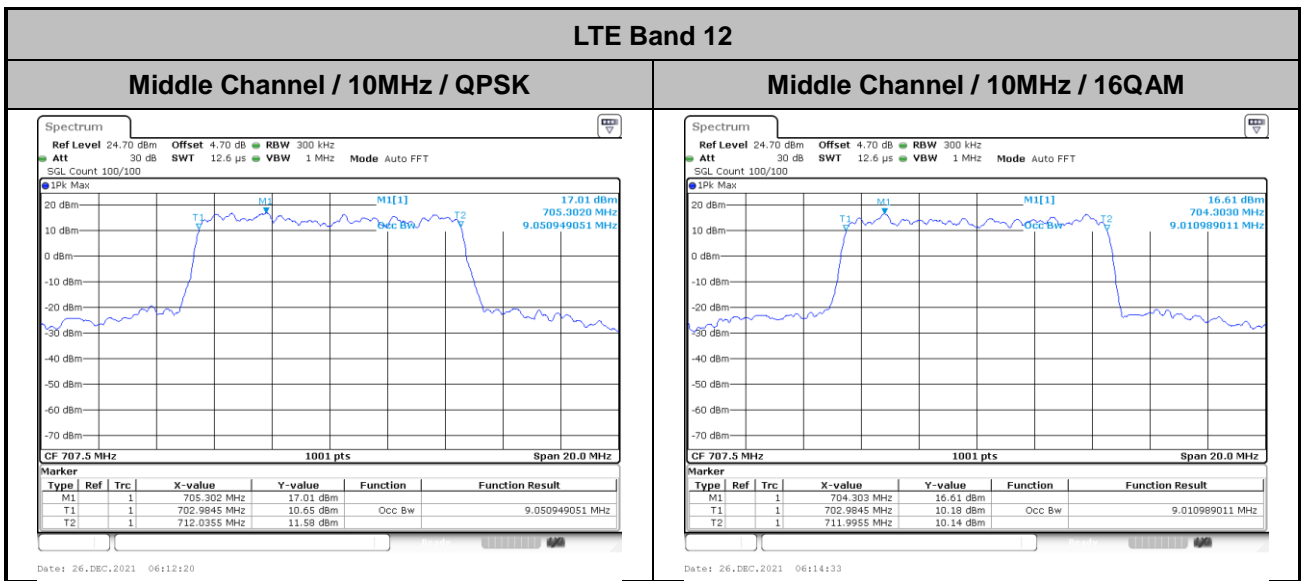



Conducted Band Edge

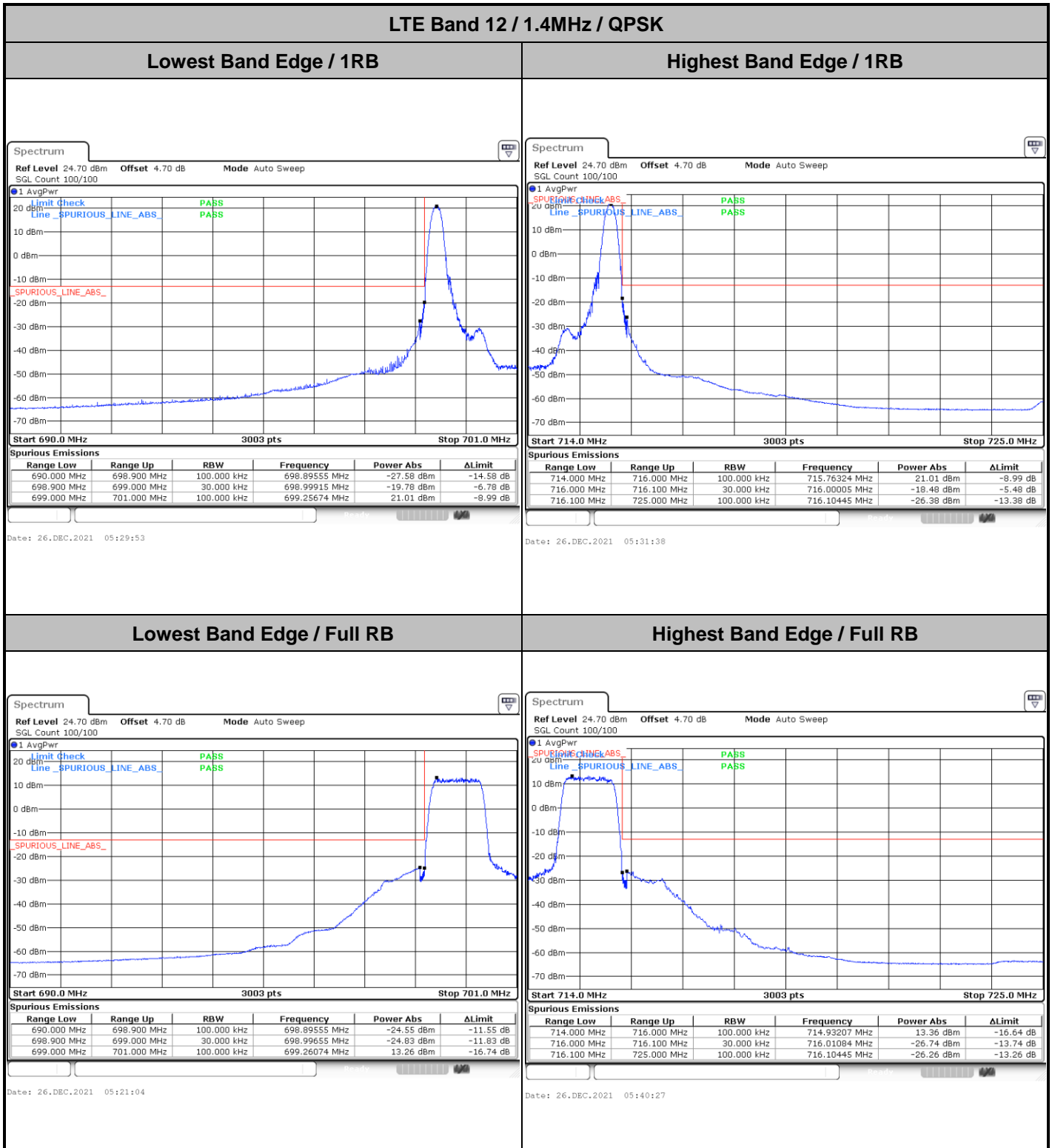



LTE Band 12 / 1.4MHz / 16QAM

Lowest Band Edge / 1 RB

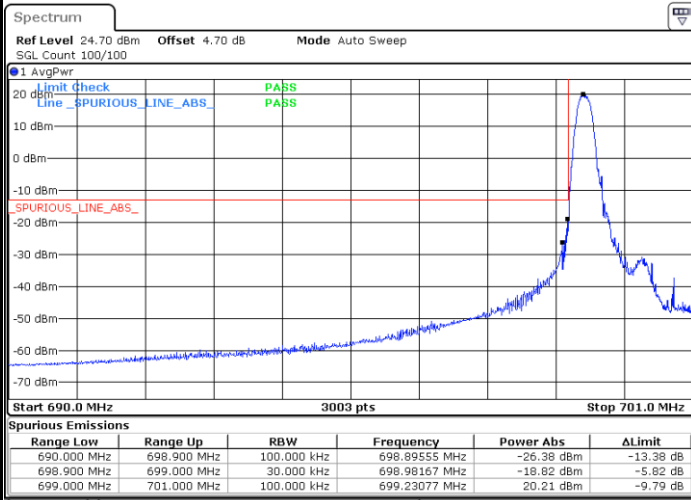

Date: 26.DEC.2021 05:28:07

Highest Band Edge / 1 RB



Date: 26.DEC.2021 05:33:24

Lowest Band Edge / Full RB

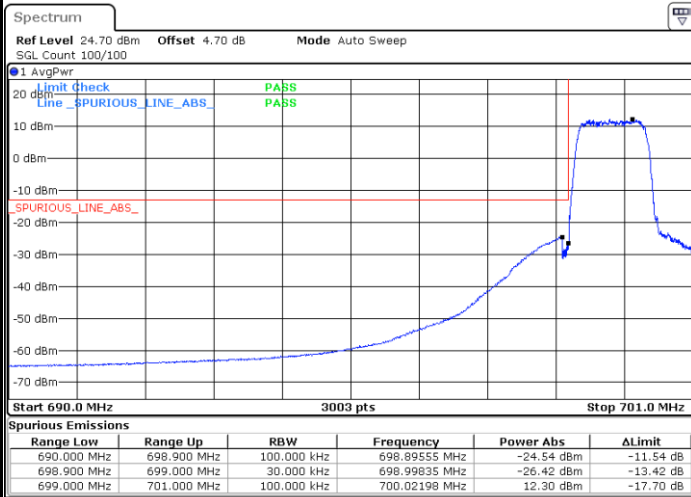

Date: 26.DEC.2021 05:22:50

Highest Band Edge / Full RB

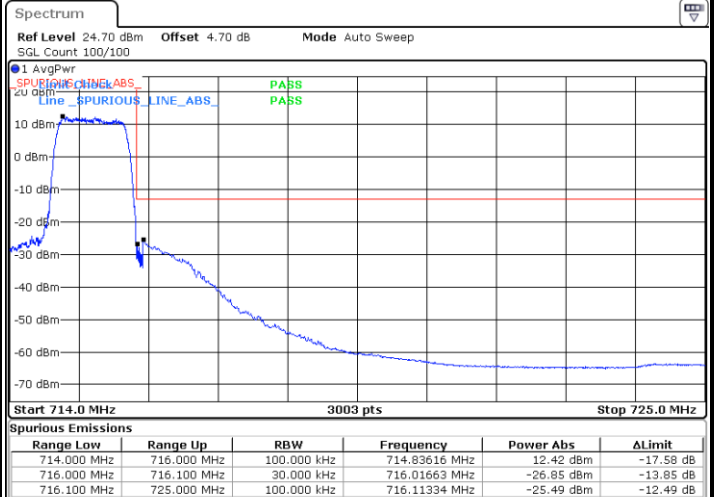

Date: 26.DEC.2021 05:38:42



LTE Band 12 / 1.4MHz / 64QAM

Lowest Band Edge / 1 RB

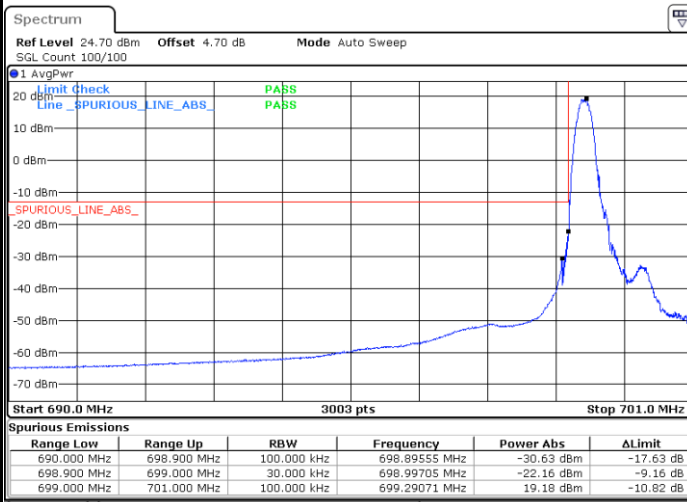

Date: 26.DEC.2021 05:26:21

Highest Band Edge / 1 RB

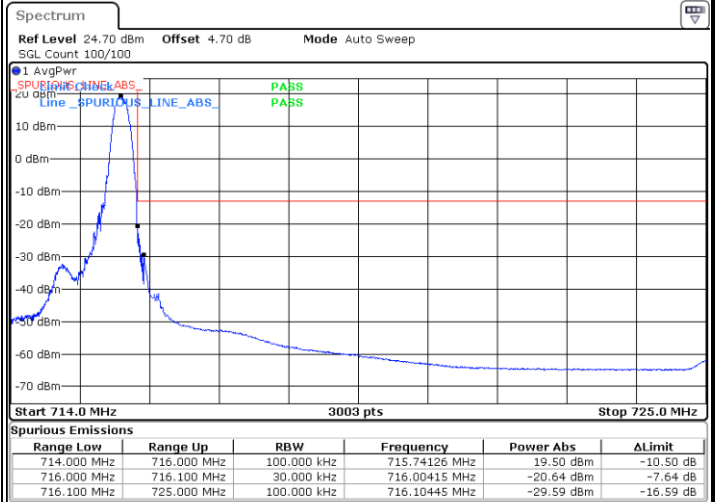

Date: 26.DEC.2021 05:35:10

Lowest Band Edge / Full RB

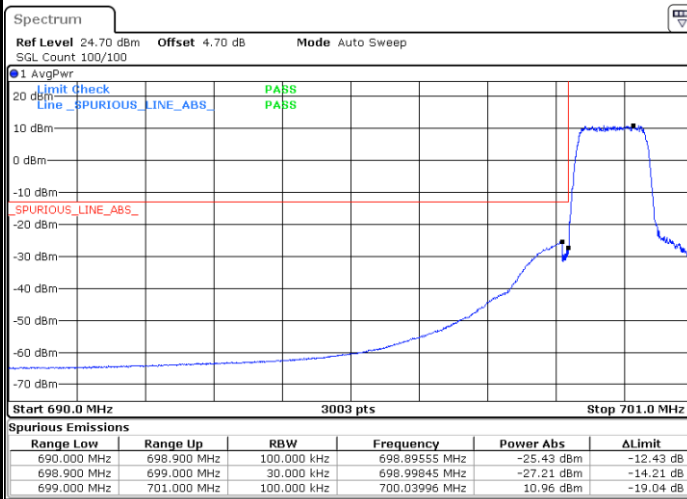

Date: 26.DEC.2021 05:24:35

Highest Band Edge / Full RB

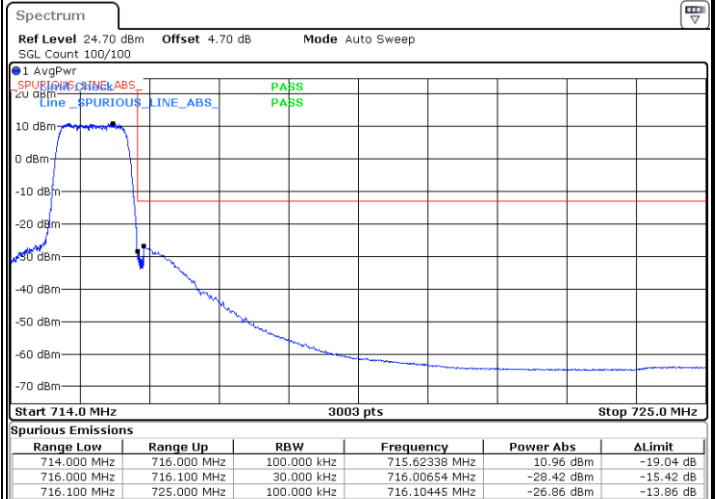

Date: 26.DEC.2021 05:36:56