



HEARING AID COMPATIBILITY RF EMISSIONS TEST REPORT

FCC ID : IHDT56AA3
Equipment : Mobile Cellular Phone
Brand Name : Motorola
Model Name : XT2213-1, XT2213DL, XT2213-2, XT2213-3
M-Rating : M3
Applicant : Motorola Mobility LLC
222 W, Merchandise Mart Plaza, Chicago IL 60654 USA
Manufacturer : Motorola Mobility LLC
222 W, Merchandise Mart Plaza, Chicago IL 60654 USA
Standard : FCC 47 CFR §20.19
ANSI C63.19-2011

We, Sporton International Inc. (Kunshan), would like to declare that the tested sample has been evaluated in accordance with the test procedures and has been in compliance with the applicable technical standards.

The test results in this report apply exclusively to the tested model / sample. Without written approval of Sporton International Inc. (Kunshan), the test report shall not be reproduced except in full.

Tony Zhang

Reviewed by: Tony Zhang / Supervisor

Kat Yin

Approved by: Kat Yin / Manager



Sporton International Inc. (Kunshan)

**No. 1098, Pengxi North Road, Kunshan Economic Development Zone Jiangsu Province 215300
People's Republic of China**



Table of Contents

1. General Information4

2. Testing Location.....5

3. Applied Standards5

4. RF Audio Interference Level5

5. Air Interface and Operating Mode6

6. Measurement System Specification7

 6.1 E-Field Probe System7

 6.2 Data Storage and Evaluation.....8

7. RF Emissions Test Procedure9

8. Test Equipment List12

9. Measurement System Validation13

10. Modulation Interference Factor14

11. Low-power Exemption.....15

12. Conducted RF Output Power (Unit: dBm).....18

13. HAC RF Emission Test Results19

14. Uncertainty Assessment.....20

15. References.....22

Appendix A. Plots of System Performance Check

Appendix B. Plots of RF Emission Measurement

Appendix C. DASYS Calibration Certificate

Appendix D. Test Setup Photos



History of this test report

Report No.	Version	Description	Issued Date
HA1D1722A	Rev. 01	Initial issue of report	Feb. 10, 2022



1. General Information

Product Feature & Specification	
Applicant Name	Motorola Mobility LLC
Equipment Name	Mobile Cellular Phone
Brand Name	Motorola
Model Name	XT2213-1, XT2213DL, XT2213-2, XT2213-3
IMEI Code	353739480012497
FCC ID	IHDT56AA3
HW	DVT2
SW	S1SA32.27
EUT Stage	Identical Prototype
Date Tested	2022/1/6 ~ 2022/1/9
Frequency Band	GSM850: 824 MHz ~ 849 MHz GSM1900: 1850 MHz ~ 1910 MHz WCDMA Band II: 1850 MHz ~ 1910 MHz WCDMA Band IV: 1710 MHz ~ 1755 MHz WCDMA Band V: 824 MHz ~ 849 MHz LTE Band 2: 1850 MHz ~ 1910 MHz LTE Band 4: 1710 MHz ~ 1755 MHz LTE Band 5: 824 MHz ~ 849 MHz LTE Band 7: 2500 MHz ~ 2570 MHz LTE Band 12: 699 MHz ~ 716 MHz LTE Band 13: 777 MHz ~ 787 MHz LTE Band 14: 788 MHz ~ 798 MHz LTE Band 17: 704 MHz ~ 716 MHz LTE Band 25: 1850 MHz ~ 1915 MHz LTE Band 26: 814 MHz ~ 849 MHz LTE Band 30: 2305 MHz ~ 2315 MHz LTE Band 38: 2570 MHz ~ 2620 MHz LTE Band 41: 2496 MHz ~ 2690 MHz LTE Band 48: 3550 MHz ~ 3700 MHz LTE Band 66: 1710 MHz ~ 1780 MHz LTE Band 71: 663 MHz ~ 698 MHz 5G NR n2: 1850 MHz ~ 1910 MHz 5G NR n5: 824 MHz ~ 849 MHz 5G NR n12: 699 MHz ~ 716 MHz 5G NR n14: 788 MHz ~ 798 MHz 5G NR n25: 1850 MHz ~ 1915 MHz 5G NR n26: 814 MHz ~ 849 MHz 5G NR n30: 2305 MHz ~ 2315 MHz 5G NR n41: 2496 MHz ~ 2690 MHz 5G NR n66: 1710 MHz ~ 1780 MHz 5G NR n70: 1695 MHz ~ 1710 MHz 5G NR n71: 663 MHz ~ 698 MHz 5G NR n77: 3450 MHz ~ 3550 MHz, 3700 MHz ~ 3980 MHz 5G NR n78: 3450 MHz ~ 3550 MHz, 3700 MHz ~ 3800 MHz WLAN 2.4GHz Band: 2412 MHz ~ 2462 MHz WLAN 5.2GHz Band: 5180 MHz ~ 5240 MHz WLAN 5.3GHz Band: 5260 MHz ~ 5320 MHz WLAN 5.5GHz Band: 5500 MHz ~ 5700 MHz WLAN 5.8GHz Band: 5745 MHz ~ 5825 MHz Bluetooth: 2402 MHz ~ 2480 MHz
Mode	GSM/GPRS/EGPRS RMC/AMR 12.2Kbps HSDPA HSUPA DC-HSDPA HSPA+(16QAM uplink is supported) LTE: QPSK, 16QAM, 64QAM, 256QAM (Downlink only) 5G NR : CP-OFDM / DFT-s-OFDM, PI/2 BPSK, QPSK, 16QAM, 64QAM, 256QAM WLAN 2.4GHz 802.11b/g/n HT20/HT40 WLAN 5GHz 802.11a/n HT20/HT40 WLAN 5GHz 802.11ac VHT20/VHT40/VHT80 Bluetooth BR/EDR/LE



2. Testing Location

Sporton International Inc. (Kunshan) is accredited to ISO/IEC 17025:2017 by American Association for Laboratory Accreditation with Certificate Number 5145.02.

Table with 4 columns: Test Firm, Test Site Location, Test Site No., and sub-columns for Sporton Site No., FCC Designation No., and FCC Test Firm Registration No.

3. Applied Standards

- FCC CFR47 Part 20.19
ANSI C63.19-2011
FCC KDB 285076 D01 HAC Guidance v05r01
FCC KDB 285076 D03 HAC FAQ v01r04

4. RF Audio Interference Level

FCC wireless hearing aid compatibility rules ensure that consumers with hearing loss are able to access wireless communications services through a wide selection of handsets without experiencing disabling radio frequency (RF) interference or other technical obstacles.

To define and measure the hearing aid compatibility of handsets, in CFR47 part 20.19 ANSI C63.19 is referenced. A handset is considered hearing aid-compatible for acoustic coupling if it meets a rating of at least M3 under ANSI C63.19, and A handset is considered hearing aid compatible for inductive coupling if it meets a rating of at least T3. According to ANSI C63.19 2011 version, for acoustic coupling, the RF electric field emissions of wireless communication devices should be measured and rated according to the emission level as below.

Table 4.1: Telephone near-field categories in linear units. Columns include Emission Categories (M1-M4) and E-field emissions (<960Mhz, >960Mhz).

Table 4.1 Telephone near-field categories in linear units



5. Air Interface and Operating Mode

Air Interface	Band MHz	Type	C63.19 Tested	Simultaneous Transmitter	Name of Voice Service	Power Reduction
GSM	GSM850	VO	Yes	WLAN, BT	CMRS Voice	No
	GSM1900			WLAN, BT		No
	EDGE850	VD	Yes	WLAN, BT	Google Duo	No
	EDGE1900			WLAN, BT		No
WCDMA	Band II	VO	No ⁽¹⁾	WLAN, BT	CMRS Voice	No
	Band IV			WLAN, BT		No
	Band V			WLAN, BT		No
	HSPA	VD	No ⁽¹⁾	WLAN, BT	Google Duo	No
LTE (FDD)	Band 2	VD	No ⁽¹⁾	5G NR, WLAN, BT	VoLTE / Google Duo	No
	Band 4			5G NR, WLAN, BT		No
	Band 5			5G NR, WLAN, BT		No
	Band 7			5G NR, WLAN, BT		No
	Band 12			5G NR, WLAN, BT		No
	Band 13			5G NR, WLAN, BT		No
	Band 14			5G NR, WLAN, BT		No
	Band 17			5G NR, WLAN, BT		No
	Band 25			5G NR, WLAN, BT		No
	Band 26			5G NR, WLAN, BT		No
	Band 30			5G NR, WLAN, BT		No
	Band 66			5G NR, WLAN, BT		No
	Band 71			5G NR, WLAN, BT		No
LTE (TDD)	Band 38	VD	Yes	5G NR, WLAN, BT	VoLTE / Google Duo	No
	Band 41			5G NR, WLAN, BT		No
	Band 48			5G NR, WLAN, BT		No
5G NR (FDD)	n2	VD	No ⁽¹⁾	LTE, WLAN, BT	VoNR / Google Duo	No
	n5			LTE, WLAN, BT		No
	n12			LTE, WLAN, BT		No
	n14			LTE, WLAN, BT		No
	n25			LTE, WLAN, BT		No
	n26			LTE, WLAN, BT		No
	n30			LTE, WLAN, BT		No
	n66			LTE, WLAN, BT		No
	n70			LTE, WLAN, BT		No
n71	LTE, WLAN, BT	No				
5G NR (TDD)	n41	VD	No ⁽¹⁾	LTE, WLAN, BT	VoNR / Google Duo	No
	n77			LTE, WLAN, BT		No
	n78			LTE, WLAN, BT		No
Wi-Fi	2450	VD	No ⁽¹⁾	GSM,WCDMA,LTE,5G NR	VoWiFi / Google Duo	No
	5200			GSM,WCDMA,LTE,5G NR		No
	5300			GSM,WCDMA,LTE,5G NR		No
	5500			GSM,WCDMA,LTE,5G NR		No
	5800			GSM,WCDMA,LTE,5G NR		No
BT	2450	DT	No	GSM,WCDMA,LTE,5G NR	NA	No

Type Transport:
 VO= Voice only
 DT= Digital Transport only (no voice)
 VD= CMRS and IP Voice Service over Digital Transport

Remark:
 1. The air interface is exempted from testing by low power exemption that its average antenna input power plus its MIF is ≤17 dBm, and is rated as M4.

6. Measurement System Specification



Fig 5.1 System Configurations

6.1 E-Field Probe System

E-Field Probe Specification

<EF3DV3>

Construction	One dipole parallel, two dipoles normal to probe axis Built-in shielding against static charges
Calibration	In air from 30 MHz to 6.0 GHz (absolute accuracy $\pm 6.0\%$, $k=2$)
Frequency	30 MHz to 6 GHz; Linearity: ± 2.0 dB (100 MHz to 3 GHz)
Directivity	± 0.2 dB in air (rotation around probe axis) ± 0.4 dB in air (rotation normal to probe axis)
Dynamic Range	2 V/m to 1000 V/m (M3 or better device readings fall well below diode compression point)
Linearity	± 0.2 dB
Dimensions	Overall length: 337 mm (Tip: 20 mm) Tip diameter: 4 mm (Body: 12 mm) Distance from probe tip to dipole centers: 1.5 mm



Photo of E-field Probe

Probe Tip Description:

HAC field measurements take place in the close near field with high gradients. Increasing the measuring distance from the source will generally decrease the measured field values (in case of the validation dipole approx. 10 % per mm).

6.2 Data Storage and Evaluation

The DASYS software stores the assessed data from the data acquisition electronics as raw data (in microvolt readings from the probe sensors), together with all the necessary software parameters for the data evaluation (probe calibration data, and device frequency and modulation data) in measurement files.

Probe parameters :	- Sensitivity	Norm _i , a _{i0} , a _{i1} , a _{i2}
	- Conversion factor	ConvF _i
	- Diode compression point	dcp _i
Device parameters :	- Frequency	f
	- Crest factor	cf
Media parameters :	- Conductivity	σ
	- Density	ρ

The formula for each channel can be given as :

$$V_i = U_i + U_i^2 \cdot \frac{cf}{dcp_i}$$

with V_i = compensated signal of channel i, (i = x, y, z)
 U_i = input signal of channel i, (i = x, y, z)
 cf = crest factor of exciting field (DASY parameter)
 dcp_i = diode compression point (DASY parameter)

From the compensated input signals, the primary field data for each channel can be evaluated :

$$\text{E-field Probes : } E_i = \sqrt{\frac{V_i}{\text{Norm}_i \cdot \text{ConvF}}}$$

with V_i = compensated signal of channel i, (i = x, y, z)
 Norm_i = sensor sensitivity of channel i, (i = x, y, z), μV/(V/m)² for E-field Probes
 ConvF = sensitivity enhancement in solution
 f = carrier frequency [GHz]
 E_i = electric field strength of channel i in V/m

The RSS value of the field components gives the total field strength (Hermitian magnitude) :

$$E_{\text{tot}} = \sqrt{E_x^2 + E_y^2 + E_z^2}$$

The primary field data are used to calculate the derived field units.



7. RF Emissions Test Procedure

Referenced from ANSI C63.19 -2011 section 5.5.1

- a. Confirm the proper operation of the field probe, probe measurement system, and other instrumentation and the positioning system.
- b. Position the WD in its intended test position.
- c. Set the WD to transmit a fixed and repeatable combination of signal power and modulation characteristic that is representative of the worst case (highest interference potential) encountered in normal use. Transiently occurring start-up, changeover, or termination conditions, or other operations likely to occur less than 1% of the time during normal operation, may be excluded from consideration.
- d. The center sub-grid shall be centered on the T-Coil mode perpendicular measurement point or the acoustic output, as appropriate. Locate the field probe at the initial test position in the 50 mm by 50 mm grid, which is contained in the measurement plane, refer to illustrated in Figure 8.2. If the field alignment method is used, align the probe for maximum field reception.
- e. Record the reading at the output of the measurement system.
- f. Scan the entire 50 mm by 50 mm region in equality spaced increments and record the reading at each measurement point, The distance between measurement points shall be sufficient to assure the identification of the maximum reading.
- g. Identify the five contiguous sub-grids around the center sub-grid whose maximum reading is the lowest of all available choices. This eliminates the three sub-grids with the maximum readings. Thus, the six areas to be used to determine the WD's highest emissions are identified.
- h. Identify the maximum reading within the non-excluded sub-grids identified in step g).
- i. Indirect measurement method
- j. The RF audio interference level in dB (V/m) is obtained by adding the MIF (in dB) to the maximum steady-state rms field-strength reading, in dB (V/m)
- k. Compare this RF audio interference level with the categories in ANSI C63.19-2011 clause 8 and record the resulting WD category rating.
- l. For the T-Coil perpendicular measurement location is ≥ 5.0 mm from the center of the acoustic output, then two different 50 mm by 50 mm areas may need to be scanned, the first for the microphone mode assessment and the second for the T-Coil assessment.
- m. The second for the T-Coil assessment, with the grid shifted so that it is centered on the perpendicular measurement point. Record the WD category rating.

Test Instructions

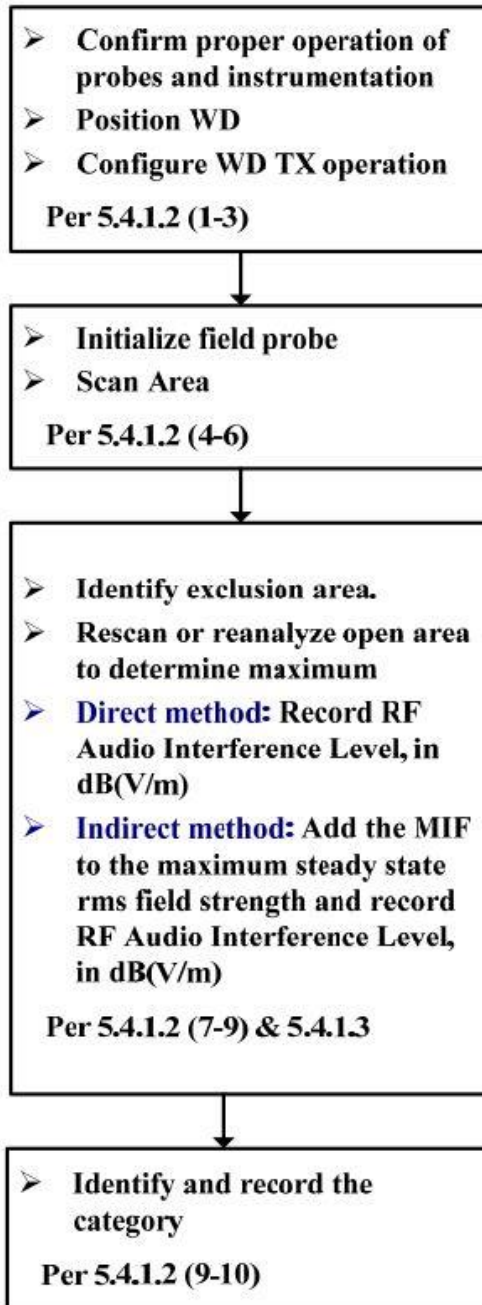

Figure 8.1 RF Emissions Flow Chart

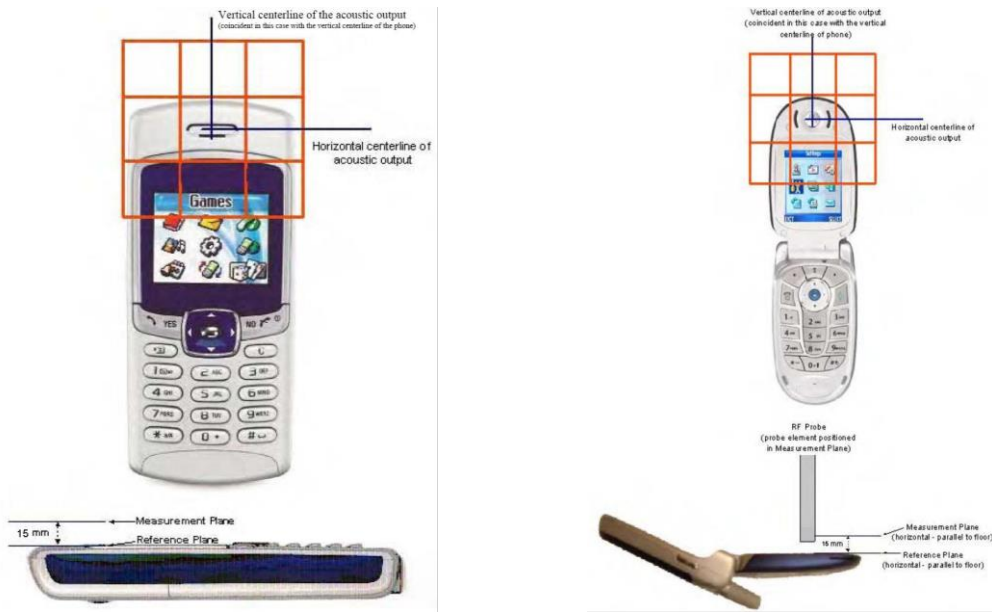

Fig 8.2 EUT reference and plane for HAC RF emission measurements

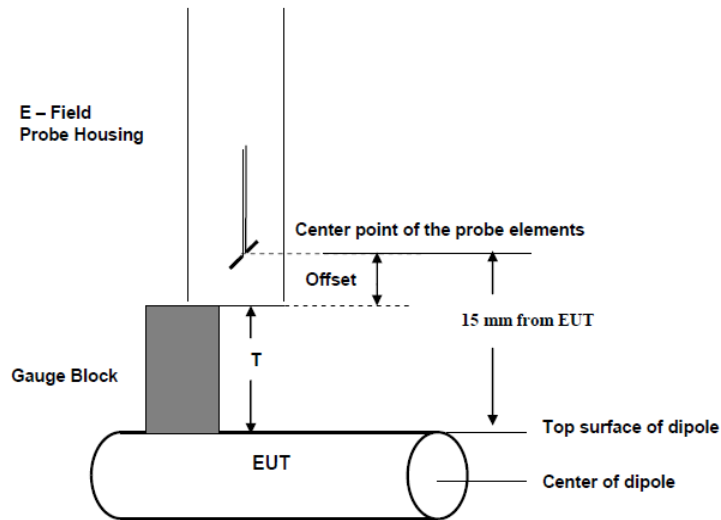

Fig. 8.3 Gauge block with E-field probe

**8. Test Equipment List**

Manufacturer	Name of Equipment	Type/Model	Serial Number	Calibration	
				Last Cal.	Due Date
SPEAG	835MHz Calibration Dipole	CD835V3	1045	2021/9/27	2022/9/26
SPEAG	1880MHz Calibration Dipole	CD1880V3	1038	2021/9/27	2022/9/26
SPEAG	2600Mhz Calibration Dipole	CD2600V3	1010	2019/3/14	2022/3/11
SPEAG	3500Mhz Calibration Dipole	CD3500V3	1009	2019/2/18	2022/2/15
SPEAG	Data Acquisition Electronics	DAE4	1649	2021/2/3	2022/2/2
SPEAG	Isotropic E-Field Probe	EF3DV3	4050	2021/1/25	2022/1/24
R&S	Base Station	CMW500	143030	2021/7/30	2022/7/29
Anritsu	Vector Signal Generator	MG3710A	6201502524	2021/10/24	2022/10/23
BONN	POWER AMPLIFIER	BLMA 0830-3	087193A	2021/8/12	2022/8/11
BONN	POWER AMPLIFIER	BLMA 2060-2	087193B	2021/7/31	2022/7/30
Agilent	Dual Directional Coupler	778D	20500	2021/8/12	2022/8/11
Agilent	Dual Directional Coupler	11691D	MY48151020	2021/8/12	2022/8/11
Rohde & Schwarz	Power Meter	NRVD	102081	2021/8/12	2022/8/11
Rohde & Schwarz	Power Sensor	NRV-Z5	100538	2021/8/12	2022/8/11
Rohde & Schwarz	Power Sensor	NRV-Z5	100539	2021/8/12	2022/8/11
MCL	Attenuation1	BW-S10W5+	N/A	NA	NA
MCL	Attenuation2	BW-S10W5+	N/A	NA	NA
MCL	Attenuation3	BW-S10W5+	N/A	NA	NA
EXA	Spectrum Analyzer	FSV7	101631	2021/10/14	2022/10/13
Testo	Thermo-Hygrometer	608-H1	1241332126	2022/1/6	2023/1/5

Note:

1. NCR: "No-Calibration Required"
2. Referring to KDB 865664 D01v01r04, the dipole calibration interval can be extended to 3 years with justification. The dipoles are also not physically damaged, or repaired during the interval.
3. The justification data of dipole can be found in appendix C. The return loss is < -20dB, within 20% of prior calibration, the impedance is within 5 ohm of prior calibration.

9. Measurement System Validation

Each DASY system is equipped with one or more system validation kits. These units, together with the predefined measurement procedures within the DASY software, enable the user to conduct the system performance check and system validation. System validation kit includes a dipole, tripod holder to fix it underneath the test Arch and a corresponding distance holder.

The system performance check verifies that the system operates within its specifications. System and operator errors can be detected and corrected. It is recommended that the system performance check be performed prior to any usage of the system in order to guarantee reproducible results. The system performance check uses normal HAC measurements in a simplified setup with a well characterized source. This setup was selected to give a high sensitivity to all parameters that might fail or vary over time. The system check does not intend to replace the calibration of the components, but indicates situations where the system uncertainty is exceeded due to drift or failure.

<Test Setup>

1. In the simplified setup for system evaluation, the EUT is replaced by a calibrated dipole and the power source is replaced by a continuous wave which comes from a signal generator.
2. The center point of the probe element(s) is 15mm from the closest surface of the dipole elements.
3. The calibrated dipole must be placed beneath the arch phantom. The equipment setup is shown below:
4. The output power on dipole port must be calibrated to 20dBm (100mW) before dipole is connected.

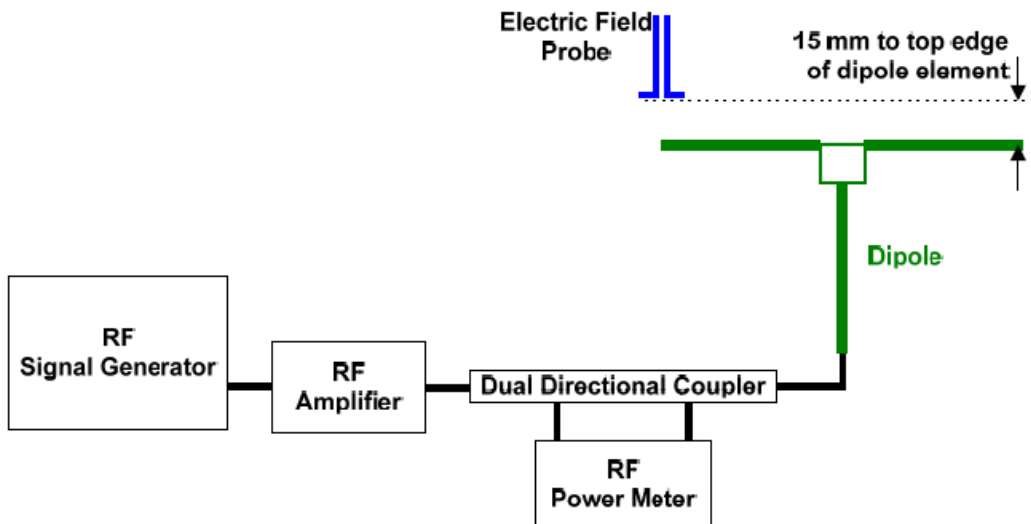

Fig. 7.1 Setup Diagram

<Validation Results>

Comparing to the original E-field value provided by SPEAG, the verification data should be within its specification of 18 %. Table 6.1 shows the target value and measured value. The table below indicates the system performance check can meet the variation criterion and the plots can be referred to appendix A of this report.

$$\text{Deviation} = ((\text{Average E-field Value}) - (\text{Target value})) / (\text{Target value}) * 100\%$$

Frequency (MHz)	Input Power (dBm)	Target Value (V/m)	E-Field 1 (V/m)	E-Field 2 (V/m)	Average Value (V/m)	Deviation (%)	Date
835	20	106.8	118.4	97.02	107.71	0.85	2022/1/6
1880	20	85.5	98.21	96.38	97.295	13.80	2022/1/7
2600	20	84.5	86.73	88.45	87.59	3.66	2022/1/8
3500	20	84.6	88.87	87.96	88.415	4.51	2022/1/9



10. Modulation Interference Factor

The HAC Standard ANSI C63.19-2011 defines a new scaling using the Modulation Interference Factor (MIF). For any specific fixed and repeatable modulated signal, a modulation interference factor (MIF, expressed in dB) may be developed that relates its interference potential to its steady-state rms signal level or average power level. This factor is a function only of the audio-frequency amplitude modulation characteristics of the signal and is the same for field-strength and conducted power measurements. It is important to emphasize that the MIF is valid only for a specific repeatable audio-frequency amplitude modulation characteristic. Any change in modulation characteristic requires determination and application of a new MIF

The Modulation Interference factor (MIF, in dB) is added to the measured average E-field (in dBV/m) and converts it to the RF Audio Interference level (in dBV/m). This level considers the audible amplitude modulation components in the RF E-field. CW fields without amplitude modulation are assumed to not interfere with the hearing aid electronics. Modulations without time slots and low fluctuations at low frequencies have low MIF values, TDMA modulations with narrow transmission and repetition rates of few 100 Hz have high MIF values and give similar classifications as ANSI C63.19-2011.

ER3D, EF3D and EU2D E-field probes have a bandwidth <10 kHz and can therefore not evaluate the RF envelope in the full audio band. DASY52 is therefore using the indirect measurement method according to ANSI C63.19-2011 which is the primary method. These near field probes read the averaged E-field measurement. Especially for the new high peak-to-average (PAR) signal types, the probes shall be linearized by PMR calibration in order to not overestimate the field reading. Probe Modulation Response (PMR) calibration linearizes the probe response over its dynamic range for specific modulations which are characterized by their UID and result in an uncertainty specified in the probe calibration certificate. The MIF is characteristic for a given waveform envelope and can be used as a constant conversion factor if the probe has been PMR calibrated.

The evaluation method for the MIF is defined in ANSI C63.19-2011 section D.7. An RMS demodulated RF signal is fed to a spectral filter (similar to an A weighting filter) and forwarded to a temporal filter acting as a quasi-peak detector. The averaged output of these filtering is scaled to a 1 kHz 80% AM signal as reference. MIF measurement requires additional instrumentation and is not well suited for evaluation by the end user with reasonable uncertainty. It may alternatively be determined through analysis and simulation, because it is constant and characteristic for a communication signal. DASY52 uses well-defined signals for PMR calibration. The MIF of these signals has been determined by simulation and it is automatically applied.

The MIF measurement uncertainty is estimated as follows, declared by HAC equipment provider SPEAG, for modulation frequencies from slotted waveforms with fundamental frequency and at least 2 harmonics within 10 kHz:

- 1. 0.2 dB for MIF: -7 to +5 dB
2. 0.5 dB for MIF: -13 to +11 dB
3. 1 dB for MIF: > -20 dB

MIF values applied in this test report were provided by the HAC equipment provider of SPEAG, and the worst values for all air interface are listed below to be determine the Low-power Exemption.

Table with 3 columns: UID, Communication System Name, MIF(dB). Rows include GSM-FDD, EDGE-FDD, UMTS-FDD, LTE-FDD, LTE-TDD, 5G NR, and various IEEE WiFi standards.



11. Low-power Exemption

<Max Tune-up Limit>

<Ant0>

Frequency Band		Average Power (dBm)
GSM	GSM850	33.50
	EDGE850	27.50
	GSM1900	30.50
	EDGE1900	26.50
WCDMA	Band V	24.00
	Band II	24.00
	Band IV	24.00
	HSPA	23.00
LTE FDD	Band 2	24.00
	Band 4	24.00
	Band 5	24.00
	Band 7	24.00
	Band 12	24.00
	Band 13	24.00
	Band 14	24.00
	Band 17	24.00
	Band 25	24.00
	Band 26	24.00
	Band 30	24.00
	Band 71	24.00
LTE TDD	Band 66	24.00
	Band 38	24.00
	Band 41	24.00
5G NR FDD	Band 41-PC2	27.00
	n2	24.00
	n5	24.00
	n12	24.00
	n14	24.00
	n25	24.00
	n26	24.00
	n30	24.00
	n66	24.00
	n70	24.00
n71	24.00	
5G NR TDD	n41-PC2	27.00



<Ant1>

Frequency Band		Average Power (dBm)
LTE FDD	Band 2	19.50
	Band 4	20.00
	Band 5	22.50
	Band 7	16.50
	Band 12	23.50
	Band 13	24.00
	Band 14	21.00
	Band 25	19.50
	Band 26	22.50
	Band 71	24.00
5G NR FDD	Band 66	20.00
	n2	17.00
	n5	21.50
	n12	24.00
	n25	17.00
	n30	16.00
	n70	24.00
n71	24.00	
5G NR TDD	n66	17.50
	n41-PC3	18.00
	n41-PC2	18.00

<Ant2>

Frequency Band		Average Power (dBm)
LTE TDD	Band 48	21.50
5G NR TDD	n77-PC3	18.50
	n77-PC2	18.50
	n78-PC3	18.50
	n78-PC2	18.50

<WLAN ANT>

Frequency Band		Average Power (dBm)
2.4GHz WLAN	802.11b	14.50
	802.11g	14.50
	802.11n-HT20	14.50
	802.11n-HT40	14.50
5GHz WLAN	802.11a	18.50
	802.11n-HT20	18.50
	802.11n-HT40	18.50
	802.11ac-VHT20	18.50
	802.11ac-VHT40	18.50
	802.11ac-VHT80	18.50



<Low Power Exemption>

<Ant0>

Air Interface	Max Average Antenna Input Power (dBm)	Worst Case MIF (dB)	Power + MIF(dB)	C63.19 test required
GSM850	33.50	3.63	37.13	Yes
EDGE850	27.50	3.75	31.25	No ⁽¹⁾
GSM1900	30.50	3.63	34.13	Yes
EDGE1900	26.50	3.75	30.25	No ⁽¹⁾
WCDMA	24.00	-25.43	-1.43	No
WCDMA - HSPA	24.00	-20.39	3.61	No
LTE - FDD	24.00	-9.76	14.24	No
LTE – TDD	27.00	-1.44	25.56	Yes
5G FR1 - FDD	24.00	-12.08	11.92	No
5G NR - TDD	27.00	-12.08	14.92	No

<Ant1>

Air Interface	Max Average Antenna Input Power (dBm)	Worst Case MIF (dB)	Power + MIF(dB)	C63.19 test required
LTE - FDD	24.00	-9.76	14.24	No
5G FR1 - FDD	24.00	-12.08	11.92	No
5G NR - TDD	18.00	-12.08	5.92	No

<Ant2>

Air Interface	Max Average Antenna Input Power (dBm)	Worst Case MIF (dB)	Power + MIF(dB)	C63.19 test required
LTE – TDD	21.50	-1.44	20.06	Yes
5G NR - TDD	18.50	-12.08	6.42	No

<WLAN ANT>

Air Interface	Max Average Antenna Input Power (dBm)	Worst Case MIF (dB)	Power + MIF(dB)	C63.19 test required
802.11b	14.50	-2.02	12.48	No
802.11g	14.50	0.12	14.62	No
802.11n-HT20	14.50	-13.44	1.06	No
802.11n-HT40	14.50	-13.44	1.06	No
802.11a	18.50	-3.15	15.35	No
802.11n-HT20	18.50	-13.44	5.06	No
802.11n-HT40	18.50	-13.44	5.06	No
802.11ac-VHT20	18.50	-5.57	12.93	No
802.11ac-VHT40	18.50	-5.57	12.93	No
802.11ac-VHT80	18.50	-5.57	12.93	No

General Note:

- EDGE data modes is not necessary due the GSM Voice mode is the worst case.
- LTE Band 41 non-HPUE data modes is not necessary due the LTE Band 41 HPUE mode is the worst case.
- According to ANSI C63.19 2011-version, for the air interface technology of a device is exempt from testing when its average antenna input power plus its MIF is ≤ 17 dBm for any of its operating modes.
- HAC RF rating is M4 for the air interface which meets the low power exemption.



12. Conducted RF Output Power (Unit: dBm)

<GSM>

Average Antenna Input Power(dBm)						
Band	GSM850 ant0			GSM1900 ant0		
Channel	128	189	251	512	661	810
Frequency (MHz)	824.2	836.4	848.8	1850.2	1880.0	1909.8
GSM (GMSK, 1 Tx slot)	32.23	32.40	32.31	29.25	29.36	29.30

<LTE ant0>

Band 38						
BW [MHz]	Modulation	RB Size	RB Offset	Power Low Ch. / Freq.	Power Middle Ch. / Freq.	Power High Ch. / Freq.
Channel				37850	38000	38150
Frequency (MHz)				2580	2595	2610
20	QPSK	1	0	22.62	22.64	22.58

Band 41								
BW [MHz]	Modulation	RB Size	RB Offset	Power Low Ch. / Freq.	Power Low Middle Ch. / Freq.	Power Middle Ch. / Freq.	Power High Middle Ch. / Freq.	Power High Ch. / Freq.
Channel				39750	40185	40620	41055	41490
Frequency (MHz)				2506	2549.5	2593	2636.5	2680
20	QPSK	1	0	22.56	22.63	22.74	22.71	22.67

Band 41 HPUE								
BW [MHz]	Modulation	RB Size	RB Offset	Power Low Ch. / Freq.	Power Low Middle Ch. / Freq.	Power Middle Ch. / Freq.	Power High Middle Ch. / Freq.	Power High Ch. / Freq.
Channel				39750	40185	40620	41055	41490
Frequency (MHz)				2506	2549.5	2593	2636.5	2680
20	QPSK	1	0	25.27	25.57	25.66	25.64	25.62

<LTE ant2>

Band 48							
BW [MHz]	Modulation	RB Size	RB Offset	Power Low Ch. / Freq.	Power Low Middle Ch. / Freq.	Power High Middle Ch. / Freq.	Power High Ch. / Freq.
Channel				55340	55830	56150	56640
Frequency (MHz)				3560	3609	3641	3690
20	QPSK	1	0	20.16	20.19	20.27	20.09



13. HAC RF Emission Test Results

Table with 10 columns: Plot No., Air Interface, Modulation / Mode, Channel, Transmit Ant., Average Antenna Input Power (dBm), MIF, E-Field (dBV/m), Margin to FCC M3 limit (dB), E-Field M Rating. Rows 1-18 show test results for GSM850, GSM1900, and LTE bands.

Remark:

- 1. The HAC measurement system applies MIF value onto the measured RMS E-field, which is indirect method in ANSIC63.19 2011 version, and reports the RF audio interference level.
2. Phone Condition: Mute on; Backlight off; Max Volume

Test Engineer : Bruce Li, Martin Li, Ricky Gu.



14. Uncertainty Assessment

The component of uncertainty may generally be categorized according to the methods used to evaluate them. The evaluation of uncertainty by the statistical analysis of a series of observations is termed a Type A evaluation of uncertainty. The evaluation of uncertainty by means other than the statistical analysis of a series of observation is termed a Type B evaluation of uncertainty. Each component of uncertainty, however evaluated, is represented by an estimated standard deviation, termed standard uncertainty, which is determined by the positive square root of the estimated variance.

The combined standard uncertainty of the measurement result represents the estimated standard deviation of the result. It is obtained by combining the individual standard uncertainties of both Type A and Type B evaluation using the usual “root-sum-squares” (RSS) methods of combining standard deviations by taking the positive square root of the estimated variances. Expanded uncertainty is a measure of uncertainty that defines an interval about the measurement result within which the measured value is confidently believed to lie. It is obtained by multiplying the combined standard uncertainty by a coverage factor. For purpose of this document, a coverage factor two is used, which corresponds to confidence interval of about 95 %. The DASY uncertainty Budget is showed in Table 14.1.

The judgment of conformity in the report is based on the measurement results excluding the measurement uncertainty.



Error Description	Uncertainty Value (±%)	Probability	Divisor	(Ci) E	(Ci) H	Standard Uncertainty (E) (±%)
Measurement System						
Probe Calibration	5.1	N	1	1	1	5.1
Axial Isotropy	4.7	R	1.732	1	1	2.7
Sensor Displacement	16.5	R	1.732	1	0.145	9.5
Boundary Effects	2.4	R	1.732	1	1	1.4
Phantom Boundary Effect	7.2	R	1.732	1	0	4.2
Linearity	4.7	R	1.732	1	1	2.7
Scaling with PMR calibration	10.0	R	1.732	1	1	5.8
System Detection Limit	1.0	R	1.732	1	1	0.6
Readout Electronics	0.3	N	1	1	1	0.3
Response Time	2.6	R	1.732	1	1	1.5
Integration Time	2.6	R	1.732	1	1	1.5
RF Ambient Conditions	3.0	R	1.732	1	1	1.7
RF Reflections	12.0	R	1.732	1	1	6.9
Probe Positioner	1.2	R	1.732	1	0.67	0.7
Probe Positioning	4.7	R	1.732	1	0.67	2.7
Extrap. and Interpolation	1.0	R	1.732	1	1	0.6
Test Sample Related						
Device Positioning Vertical	4.7	R	1.732	1	0.67	2.7
Device Positioning Lateral	1.0	R	1.732	1	1	0.6
Device Holder and Phantom	2.4	R	1.732	1	1	1.4
Power Drift	5.0	R	1.732	1	1	2.9
Phantom and Setup Related						
Phantom Thickness	2.4	R	1.732	1	0.67	1.4
Combined Std. Uncertainty						16.4%
Coverage Factor for 95 %						K=2
Expanded STD Uncertainty						32.7%

Table 14.1 Uncertainty Budget of HAC free field assessment



15. References

- [1] ANSI C63.19-2011, "American National Standard for Methods of Measurement of Compatibility between Wireless Communications Devices and Hearing Aids", 27 May 2011.
- [2] FCC KDB 285076 D01v05r01, "Equipment Authorization Guidance for Hearing Aid Compatibility", Apr 06, 2020
- [3] FCC KDB 285076 D03v01r04, "Hearing aid compatibility frequently asked questions", Apr 20, 2021.
- [4] SPEAG DASY System Handbook

-----THE END-----



Appendix A. Plots of System Performance Check

The plots are shown as follows.

HAC_E_Dipole_835

DUT: HAC-Dipole 835 MHz

Communication System: UID 0, CW; Frequency: 835 MHz; Duty Cycle: 1:1

Medium: Air Medium parameters used: $\sigma = 0$ S/m, $\epsilon_r = 1$; $\rho = 0$ kg/m³

Ambient Temperature : 23.3 °C;

DASY5 Configuration:

- Probe: EF3DV3 - SN4050; ConvF(1, 1, 1); Calibrated: 2021.1.25
- Electronics: DAE4 Sn1649; Calibrated: 2021.2.3
- Phantom: HAC Test Arch with AMCC; Type: SD HAC P01 BA;
- Measurement SW: DASY52, Version 52.10 (4); SEMCAD X Version 14.6.14 (7483)

E Scan - measurement distance from the probe sensor center to CD835 = 15mm/Hearing Aid Compatibility Test at 15mm distance (41x361x1): Interpolated grid:

dx=0.5000 mm, dy=0.5000 mm

Device Reference Point: 0, 0, -6.3 mm

Reference Value = 118.0 V/m; Power Drift = 0.08 dB

PMR not calibrated. PMF = 1.000 is applied.

E-field emissions = 118.4 V/m

Average value of Total=(118.4+97.02)/2=107.71 V/m

PMF scaled E-field

Grid 1 M4 116.6 V/m	Grid 2 M4 118.4 V/m	Grid 3 M4 116.7 V/m
Grid 4 M4 57.33 V/m	Grid 5 M4 59.22 V/m	Grid 6 M4 58.54 V/m
Grid 7 M4 94.39 V/m	Grid 8 M4 97.02 V/m	Grid 9 M4 94.43 V/m

Total = 118.4 V/m

E Category: M4

Location: 0, -74.5, 9.7 mm

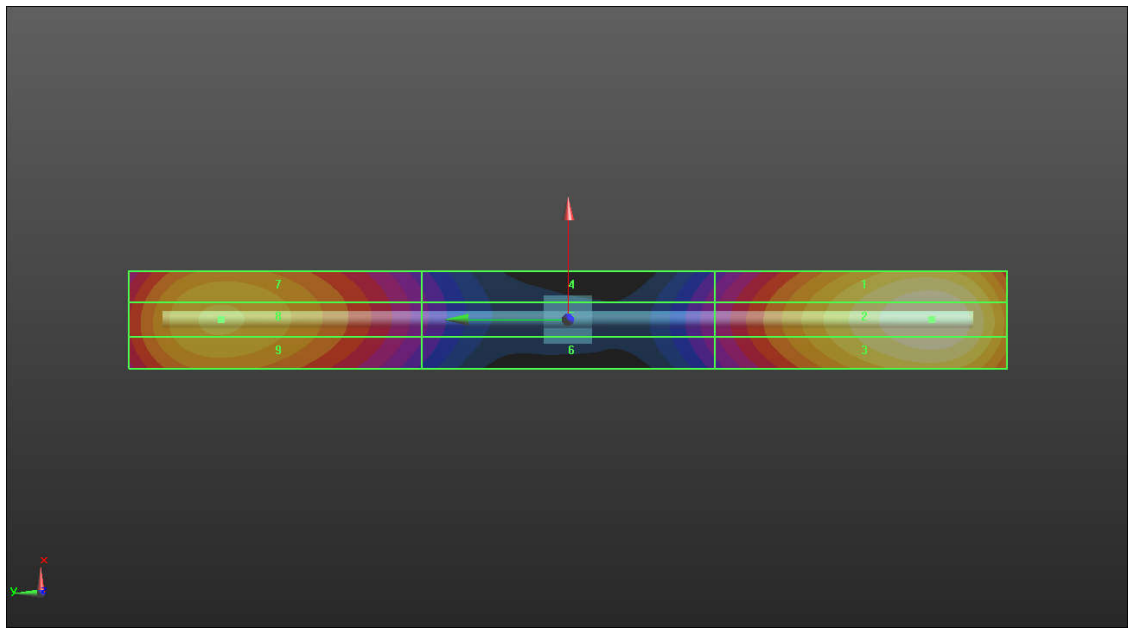
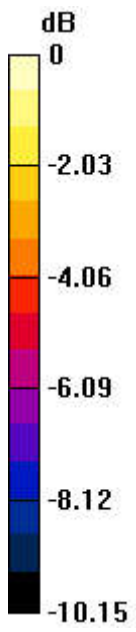

0 dB = 119.6 V/m = 41.55 dBV/m

HAC_E_Dipole_1880

DUT: HAC Dipole 1880 MHz

Communication System: UID 0, CW; Frequency: 1880 MHz; Duty Cycle: 1:1

Medium: Air Medium parameters used: $\sigma = 0$ S/m, $\epsilon_r = 1$; $\rho = 0$ kg/m³

Ambient Temperature : 23.3 °C;

DASY5 Configuration:

- Probe: EF3DV3 - SN4050; ConvF(1, 1, 1); Calibrated: 2021.1.25
- Electronics: DAE4 Sn1649; Calibrated: 2021.2.3
- Phantom: HAC Test Arch with AMCC; Type: SD HAC P01 BA;
- Measurement SW: DASY52, Version 52.10 (4); SEMCAD X Version 14.6.14 (7483)

E Scan - measurement distance from the probe sensor center to CD1880 = 15mm/Hearing Aid Compatibility Test at 15mm distance (41x181x1): Interpolated grid:

dx=0.5000 mm, dy=0.5000 mm

Device Reference Point: 0, 0, -6.3 mm

Reference Value = 156.2 V/m; Power Drift = 0.04 dB

PMR not calibrated. PMF = 1.000 is applied.

E-field emissions = 98.21 V/m

Average value of Total=(98.21+96.38)/2=97.295 V/m

PMF scaled E-field

Grid 1 M3 97.21 V/m	Grid 2 M3 98.21 V/m	Grid 3 M3 98.14 V/m
Grid 4 M3 65.05 V/m	Grid 5 M3 66.15 V/m	Grid 6 M3 65.58 V/m
Grid 7 M3 91.46 V/m	Grid 8 M3 96.38 V/m	Grid 9 M3 92.21 V/m

Total = 98.21 V/m

E Category: M3

Location: -0.5, -34, 8.7 mm

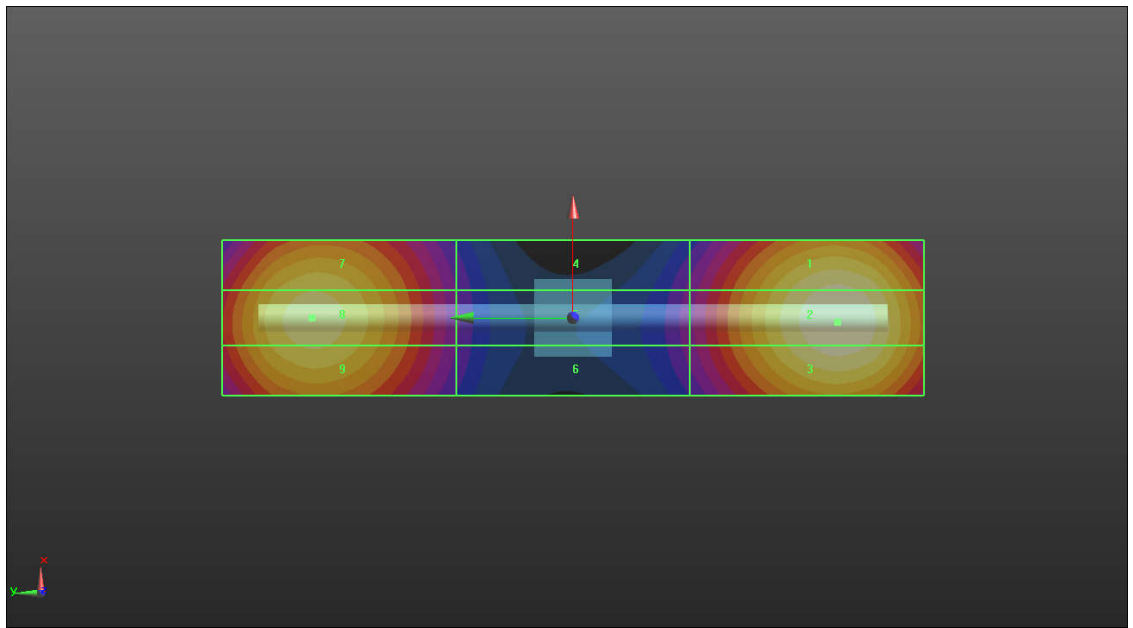
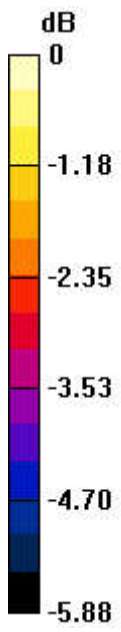

0 dB = 98.21 V/m = 40.02 dBV/m

HAC_E_Dipole_2600

DUT: HAC Dipole 2600 MHz

Communication System: UID 0, CW (0); Frequency: 2600 MHz; Duty Cycle: 1:1

Medium: Air Medium parameters used: $\sigma = 0$ S/m, $\epsilon_r = 1$; $\rho = 0$ kg/m³

Ambient Temperature : 23.3 °C;

DASY5 Configuration:

- Probe: EF3DV3 - SN4050; ConvF(1, 1, 1); Calibrated: 2021.1.25
- Electronics: DAE4 Sn1649; Calibrated: 2021.2.3
- Phantom: HAC Test Arch with AMCC; Type: SD HAC P01 BA;
- Measurement SW: DASY52, Version 52.10 (4); SEMCAD X Version 14.6.14 (7483)

E Scan - measurement distance from the probe sensor center to CD2600 = 15mm/Hearing Aid Compatibility Test at 15mm distance (41x181x1): Interpolated grid:

dx=0.5000 mm, dy=0.5000 mm

Device Reference Point: 0, 0, -6.3 mm

Reference Value = 73.73 V/m; Power Drift = 0.02 dB

PMR not calibrated. PMF = 1.000 is applied.

E-field emissions = 88.45 V/m

Average value of Total=(86.73+88.45)/2=87.59 V/m

PMF scaled E-field

Grid 1 M3 86.02 V/m	Grid 2 M3 86.73 V/m	Grid 3 M3 84.51 V/m
Grid 4 M3 80.85 V/m	Grid 5 M3 81.45 V/m	Grid 6 M3 79.78 V/m
Grid 7 M3 87.77 V/m	Grid 8 M3 88.45 V/m	Grid 9 M3 85.73 V/m

Total = 88.45 V/m

E Category: M3

Location: 1, 23.5, 9.7 mm

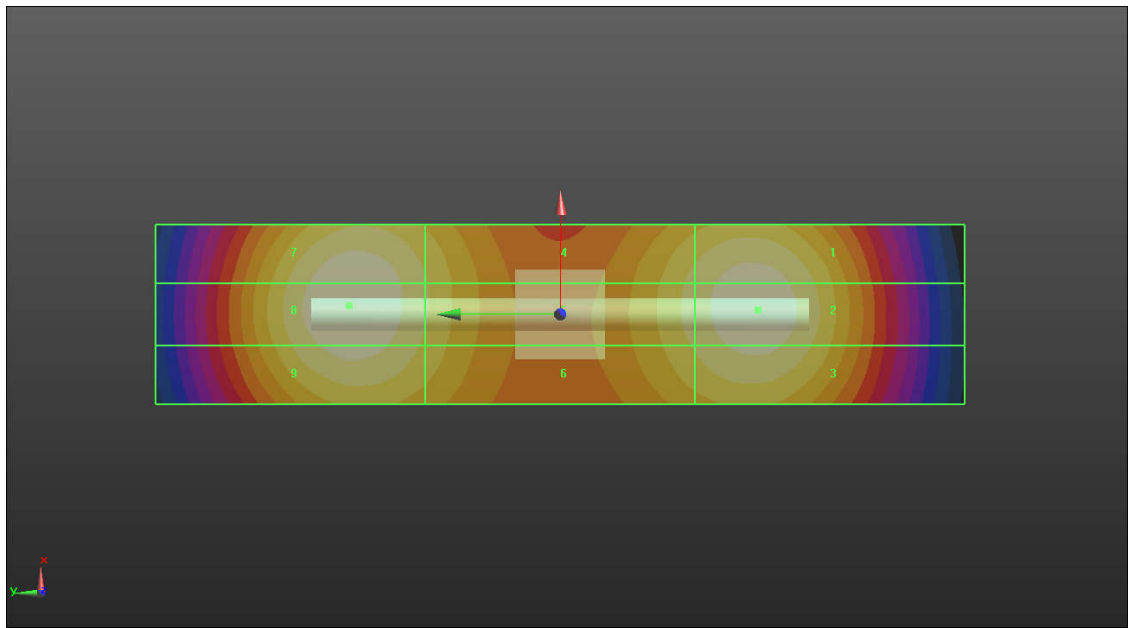
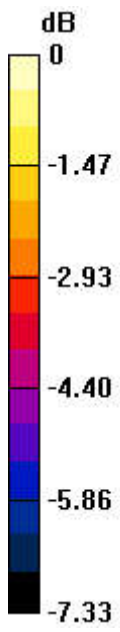

0 dB = 88.55 V/m = 38.94 dBV/m

HAC_E_Dipole_3500

DUT: HAC Dipole 3500 MHz

Communication System: UID 0, CW (0); Frequency: 3500 MHz; Duty Cycle: 1:1

Medium: Air Medium parameters used: $\sigma = 0$ S/m, $\epsilon_r = 1$; $\rho = 0$ kg/m³

Ambient Temperature : 23.3 °C

DASY5 Configuration:

- Probe: EF3DV3 - SN4050; ConvF(1, 1, 1); Calibrated: 2021.1.25
- Electronics: DAE4 Sn1649; Calibrated: 2021.2.3
- Phantom: HAC Test Arch with AMCC; Type: SD HAC P01 BA;
- Measurement SW: DASY52, Version 52.10 (4); SEMCAD X Version 14.6.14 (7483)

E Scan - measurement distance from the probe sensor center to CD3500 = 15mm/Hearing Aid Compatibility Test at 15mm distance (41x121x1): Interpolated grid:

dx=0.5000 mm, dy=0.5000 mm

Device Reference Point: 0, 0, -6.3 mm

Reference Value = 38.61 V/m; Power Drift = 0.02 dB

PMR not calibrated. PMF = 1.000 is applied.

E-field emissions = 88.87 V/m

Average value of Total=(88.87+87.96)/2=88.415 V/m

PMF scaled E-field

Grid 1 M3 87.56 V/m	Grid 2 M3 88.87 V/m	Grid 3 M3 86.34 V/m
Grid 4 M3 85.06 V/m	Grid 5 M3 85.94 V/m	Grid 6 M3 84.81 V/m
Grid 7 M3 87.57 V/m	Grid 8 M3 87.96 V/m	Grid 9 M3 86.62 V/m

Total = 88.87 V/m

E Category: M3

Location: 0, -14.5, 9.7 mm

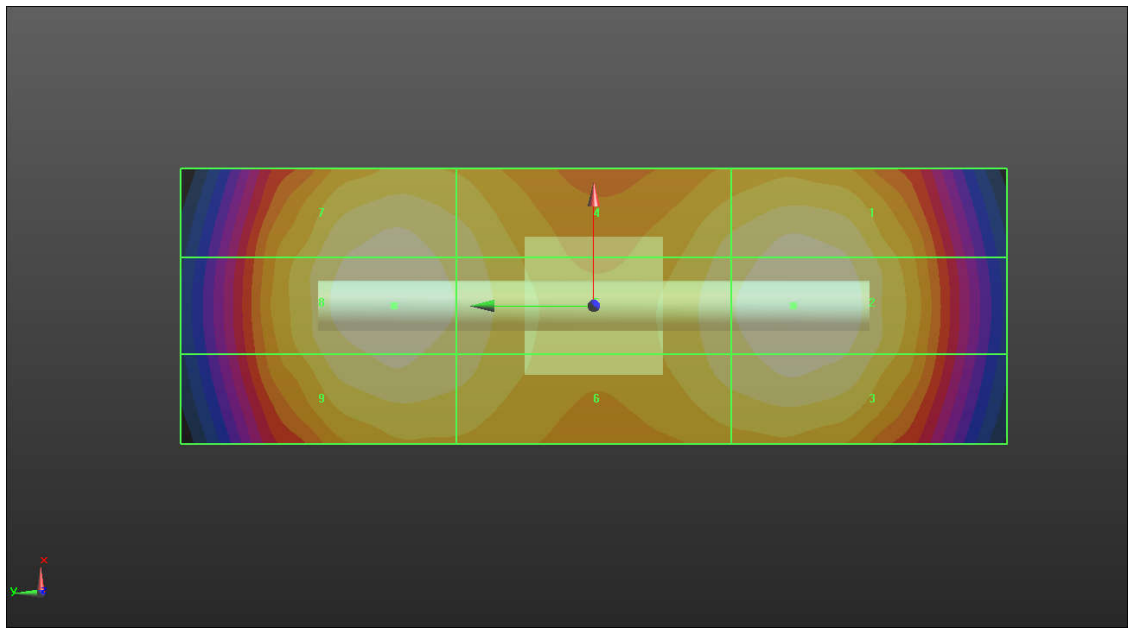
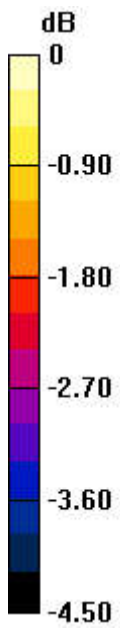

0 dB = 89.01 V/m = 38.99 dBV/m



Appendix B. Plots of RF Emission Measurement

The plots are shown as follows.

1_HAC RF GSM850_ANT0_Voice_Ch128

Communication System: UID 10021 - DAC, GSM-FDD (TDMA, GMSK); Frequency: 824.2 MHz; Duty Cycle: 1:8.69961

Medium: Air Medium parameters used: $\sigma = 0$ S/m, $\epsilon_r = 1$; $\rho = 0$ kg/m³

Ambient Temperature : 23.3 °C;

DASY5 Configuration:

- Probe: EF3DV3 - SN4050; ConvF(1, 1, 1); Calibrated: 2021.1.25
- Sensor-Surface: (Fix Surface)
- Electronics: DAE4 Sn1649; Calibrated: 2021.2.3
- Phantom: HAC Test Arch with AMCC; Type: SD HAC P01 BA;
- Measurement SW: DASY52, Version 52.10 (4); SEMCAD X Version 14.6.14 (7483)

Ch128/Hearing Aid Compatibility Test (101x101x1): Interpolated grid: dx=0.5000 mm, dy=0.5000 mm

Device Reference Point: 0, 0, -6.3 mm

Reference Value = 50.30 V/m; Power Drift = 0.05 dB

Applied MIF = 3.63 dB

RF audio interference level = 35.50 dBV/m

MIF scaled E-field

Grid 1 M4 34.06 dBV/m	Grid 2 M4 35.5 dBV/m	Grid 3 M4 35.4 dBV/m
Grid 4 M4 33.94 dBV/m	Grid 5 M4 35.26 dBV/m	Grid 6 M4 35.2 dBV/m
Grid 7 M4 33.86 dBV/m	Grid 8 M4 34.61 dBV/m	Grid 9 M4 34.43 dBV/m

Total = 35.50 dBV/m

E Category: M4

Location: -5.5, -21, 8.7 mm

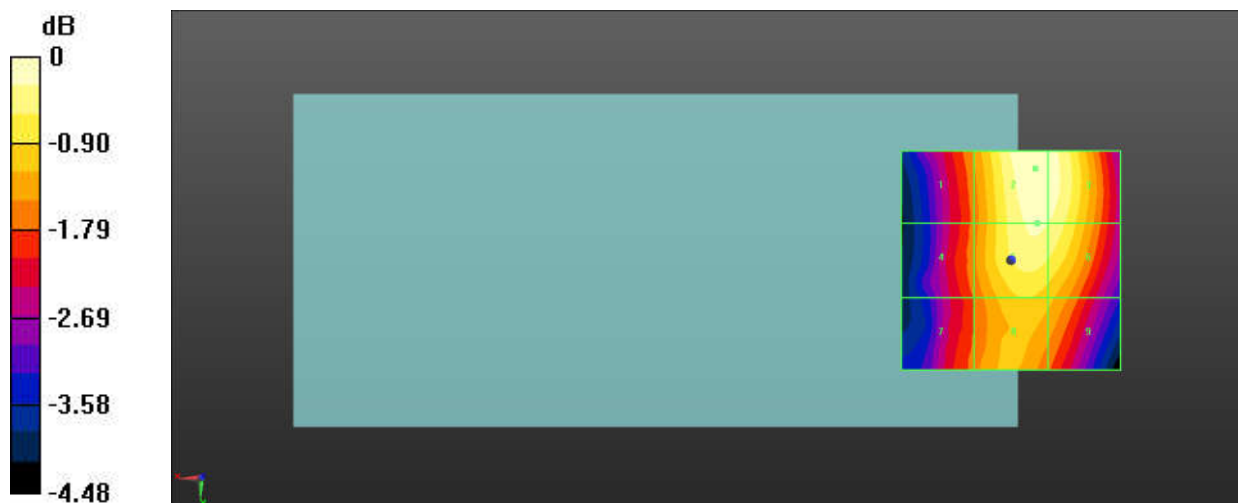

0 dB = 59.55 V/m = 35.50 dBV/m

2_HAC RF GSM850_ANT0_Voice_Ch189

Communication System: UID 10021 - DAC, GSM-FDD (TDMA, GMSK); Frequency: 836.6 MHz; Duty Cycle: 1:8.69961

Medium: Air Medium parameters used: $\sigma = 0$ S/m, $\epsilon_r = 1$; $\rho = 0$ kg/m³

Ambient Temperature : 23.3 °C;

DASY5 Configuration:

- Probe: EF3DV3 - SN4050; ConvF(1, 1, 1); Calibrated: 2021.1.25
- Sensor-Surface: (Fix Surface)
- Electronics: DAE4 Sn1649; Calibrated: 2021.2.3
- Phantom: HAC Test Arch with AMCC; Type: SD HAC P01 BA;
- Measurement SW: DASY52, Version 52.10 (4); SEMCAD X Version 14.6.14 (7483)

Ch189/Hearing Aid Compatibility Test (101x101x1): Interpolated grid: dx=0.5000 mm, dy=0.5000 mm

Device Reference Point: 0, 0, -6.3 mm

Reference Value = 48.58 V/m; Power Drift = 0.08 dB

Applied MIF = 3.63 dB

RF audio interference level = 34.77 dBV/m

MIF scaled E-field

Grid 1 M4 33.55 dBV/m	Grid 2 M4 34.77 dBV/m	Grid 3 M4 34.74 dBV/m
Grid 4 M4 33.96 dBV/m	Grid 5 M4 34.55 dBV/m	Grid 6 M4 34.44 dBV/m
Grid 7 M4 34.67 dBV/m	Grid 8 M4 34.77 dBV/m	Grid 9 M4 33.96 dBV/m

Total = 34.77 dBV/m

E Category: M4

Location: 2, 25, 8.7 mm

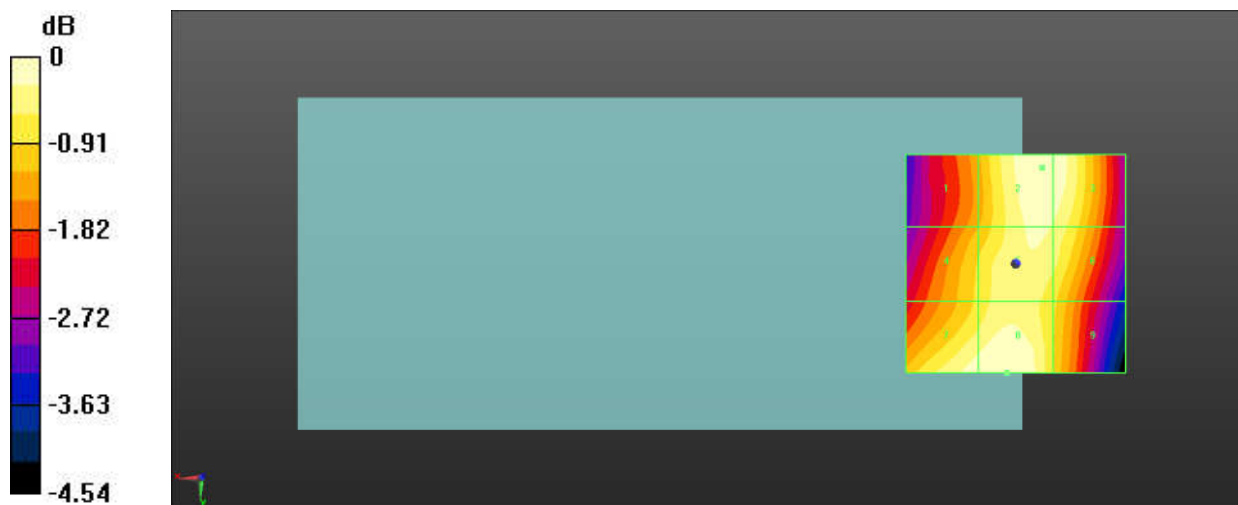

0 dB = 54.78 V/m = 34.77 dBV/m

3_HAC RF GSM850_ANT0_Voice_Ch251

Communication System: UID 10021 - DAC, GSM-FDD (TDMA, GMSK); Frequency: 848.6 MHz; Duty Cycle: 1:8.69961

Medium: Air Medium parameters used: $\sigma = 0$ S/m, $\epsilon_r = 1$; $\rho = 0$ kg/m³

Ambient Temperature : 23.3 °C;

DASY5 Configuration:

- Probe: EF3DV3 - SN4050; ConvF(1, 1, 1); Calibrated: 2021.1.25
- Sensor-Surface: (Fix Surface)
- Electronics: DAE4 Sn1649; Calibrated: 2021.2.3
- Phantom: HAC Test Arch with AMCC; Type: SD HAC P01 BA;
- Measurement SW: DASY52, Version 52.10 (4); SEMCAD X Version 14.6.14 (7483)

Ch251/Hearing Aid Compatibility Test (101x101x1): Interpolated grid: dx=0.5000 mm, dy=0.5000 mm

Device Reference Point: 0, 0, -6.3 mm

Reference Value = 54.75 V/m; Power Drift = 0.05 dB

Applied MIF = 3.63 dB

RF audio interference level = 36.18 dBV/m

MIF scaled E-field

Grid 1 M4 34.79 dBV/m	Grid 2 M4 36.18 dBV/m	Grid 3 M4 36.11 dBV/m
Grid 4 M4 34.88 dBV/m	Grid 5 M4 35.99 dBV/m	Grid 6 M4 35.91 dBV/m
Grid 7 M4 34.95 dBV/m	Grid 8 M4 35.47 dBV/m	Grid 9 M4 35.25 dBV/m

Total = 36.18 dBV/m

E Category: M4

Location: -5.5, -21, 8.7 mm

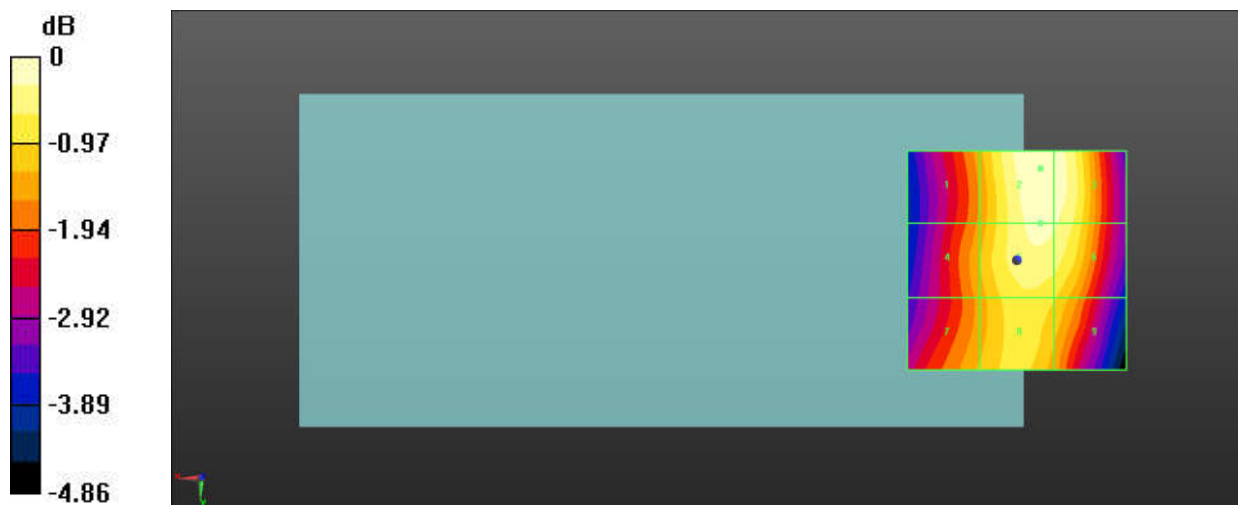

0 dB = 64.41 V/m = 36.18 dBV/m

4_HAC RF GSM1900_ANT0_Voice_Ch512

Communication System: UID 10021 - DAC, GSM-FDD (TDMA, GMSK); Frequency: 1850.2 MHz; Duty Cycle: 1:8.69961

Medium: Air Medium parameters used: $\sigma = 0$ S/m, $\epsilon_r = 1$; $\rho = 0$ kg/m³

Ambient Temperature : 23.3 °C;

DASY5 Configuration:

- Probe: EF3DV3 - SN4050; ConvF(1, 1, 1); Calibrated: 2021.1.25
- Sensor-Surface: (Fix Surface)
- Electronics: DAE4 Sn1649; Calibrated: 2021.2.3
- Phantom: HAC Test Arch with AMCC; Type: SD HAC P01 BA;
- Measurement SW: DASY52, Version 52.10 (4); SEMCAD X Version 14.6.14 (7483)

Ch512/Hearing Aid Compatibility Test (101x101x1): Interpolated grid: dx=0.5000 mm, dy=0.5000 mm

Device Reference Point: 0, 0, -6.3 mm

Reference Value = 16.93 V/m; Power Drift = -0.03 dB

Applied MIF = 3.63 dB

RF audio interference level = 30.21 dBV/m

MIF scaled E-field

Grid 1 M4 26.97 dBV/m	Grid 2 M4 26.96 dBV/m	Grid 3 M4 24.82 dBV/m
Grid 4 M4 25.84 dBV/m	Grid 5 M4 27.92 dBV/m	Grid 6 M4 27.92 dBV/m
Grid 7 M4 29.48 dBV/m	Grid 8 M3 30.21 dBV/m	Grid 9 M4 29.59 dBV/m

Total = 30.21 dBV/m

E Category: M3

Location: 0, 25, 8.7 mm

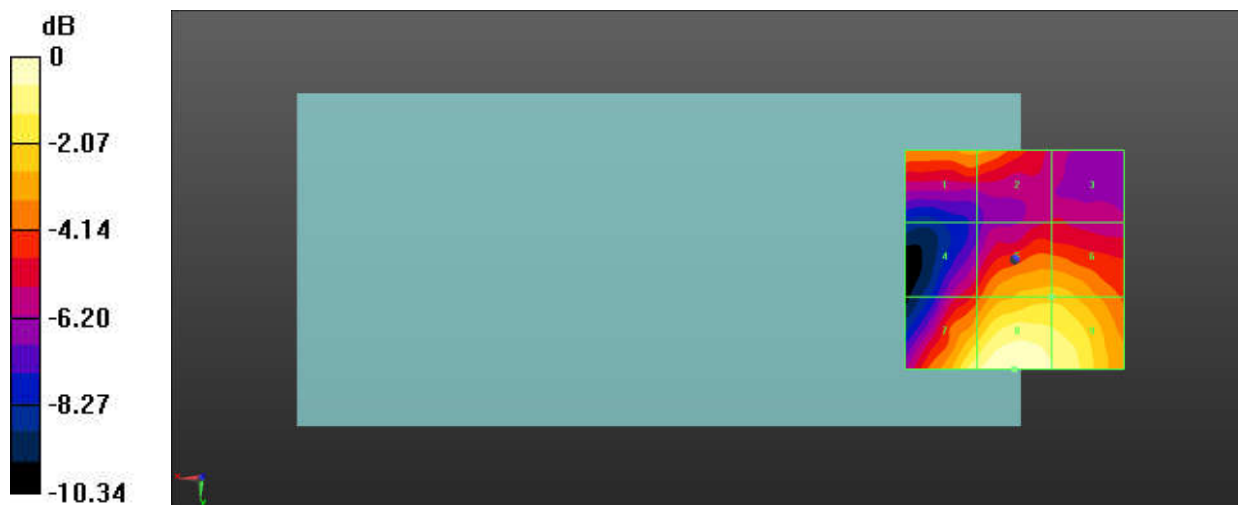

0 dB = 32.40 V/m = 30.21 dBV/m

5_HAC RF GSM1900_ANT0_Voice_Ch661

Communication System: UID 10021 - DAC, GSM-FDD (TDMA, GMSK); Frequency: 1880 MHz;Duty Cycle: 1:8.69961

Medium: Air Medium parameters used: $\sigma = 0$ S/m, $\epsilon_r = 1$; $\rho = 0$ kg/m³

Ambient Temperature : 23.3 °C;

DASY5 Configuration:

- Probe: EF3DV3 - SN4050; ConvF(1, 1, 1); Calibrated: 2021.1.25
- Sensor-Surface: (Fix Surface)
- Electronics: DAE4 Sn1649; Calibrated: 2021.2.3
- Phantom: HAC Test Arch with AMCC; Type: SD HAC P01 BA;
- Measurement SW: DASY52, Version 52.10 (4); SEMCAD X Version 14.6.14 (7483)

Ch661/Hearing Aid Compatibility Test (101x101x1): Interpolated grid: dx=0.5000 mm, dy=0.5000 mm

Device Reference Point: 0, 0, -6.3 mm

Reference Value = 17.58 V/m; Power Drift = -0.02 dB

Applied MIF = 3.63 dB

RF audio interference level = 30.02 dBV/m

MIF scaled E-field

Grid 1 M4 28.2 dBV/m	Grid 2 M4 28.2 dBV/m	Grid 3 M4 26.16 dBV/m
Grid 4 M4 25.96 dBV/m	Grid 5 M4 28.05 dBV/m	Grid 6 M4 27.72 dBV/m
Grid 7 M4 28.87 dBV/m	Grid 8 M3 30.02 dBV/m	Grid 9 M4 29.63 dBV/m

Total = 30.02 dBV/m

E Category: M3

Location: -3.5, 25, 8.7 mm

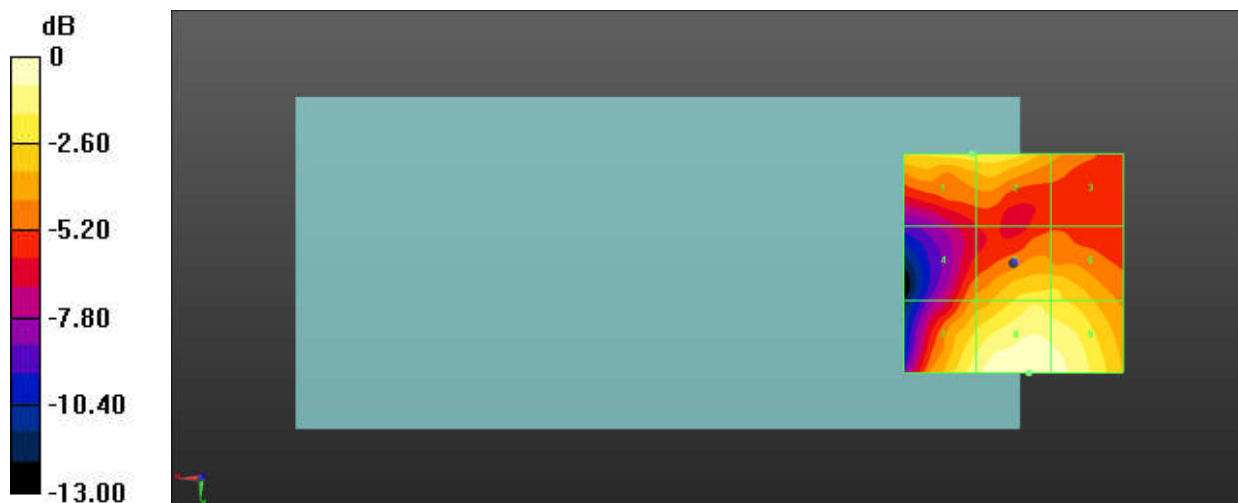

0 dB = 31.70 V/m = 30.02 dBV/m

6_HAC RF GSM1900_ANT0_Voice_Ch810

Communication System: UID 10021 - DAB, GSM-FDD (TDMA, GMSK); Frequency: 1909.8 MHz; Duty Cycle: 1:8.6896

Medium: Air Medium parameters used: $\sigma = 0$ S/m, $\epsilon_r = 1$; $\rho = 0$ kg/m³

Ambient Temperature : 23.3 °C;

DASY5 Configuration:

- Probe: EF3DV3 - SN4050; ConvF(1, 1, 1); Calibrated: 2021.1.25
- Sensor-Surface: (Fix Surface)
- Electronics: DAE4 Sn1649; Calibrated: 2021.2.3
- Phantom: HAC Test Arch with AMCC; Type: SD HAC P01 BA;
- Measurement SW: DASY52, Version 52.10 (4); SEMCAD X Version 14.6.14 (7483)

Ch810/Hearing Aid Compatibility Test (101x101x1): Interpolated grid: dx=0.5000 mm, dy=0.5000 mm

Device Reference Point: 0, 0, -6.3 mm

Reference Value = 20.26 V/m; Power Drift = -0.06 dB

Applied MIF = 3.63 dB

RF audio interference level = 30.47 dBV/m

MIF scaled E-field

Grid 1 M4 27.81 dBV/m	Grid 2 M4 27.88 dBV/m	Grid 3 M4 27 dBV/m
Grid 4 M4 26.53 dBV/m	Grid 5 M4 28.7 dBV/m	Grid 6 M4 28.67 dBV/m
Grid 7 M4 28.83 dBV/m	Grid 8 M3 30.47 dBV/m	Grid 9 M3 30.25 dBV/m

Total = 30.47 dBV/m

E Category: M3

Location: -3.5, 25, 8.7 mm

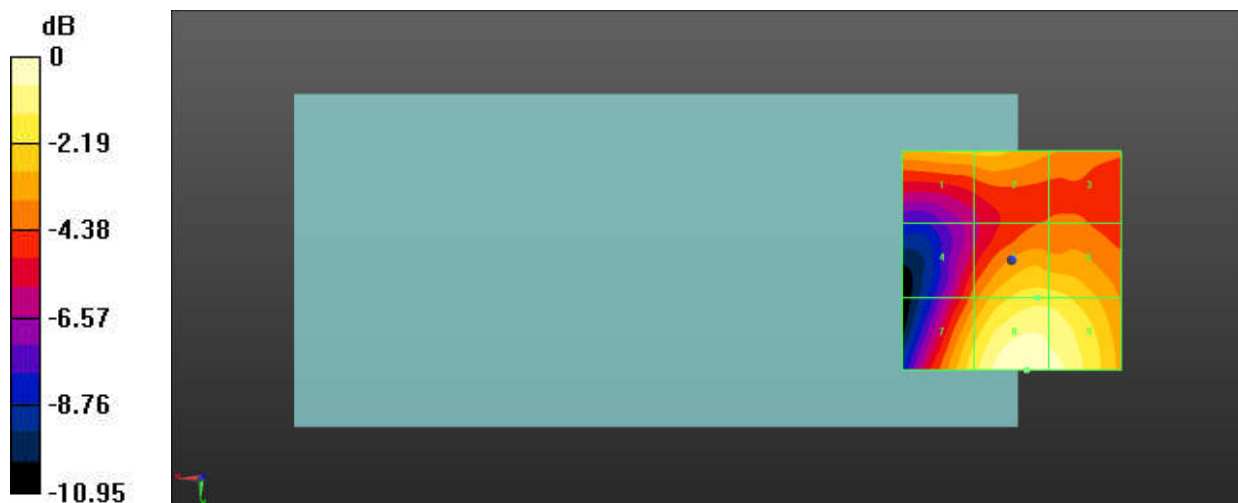

0 dB = 33.40 V/m = 30.47 dBV/m

7_HAC RF LTE B38_Ant 0_QPSK_1_0_Ch37850

Communication System: UID 10173 - CAG, LTE-TDD (SC-FDMA, 1 RB, 20 MHz, 16-QAM);
 Frequency: 2580 MHz;Duty Cycle: 1:8.8736

Medium: Air Medium parameters used: $\sigma = 0$ S/m, $\epsilon_r = 1$; $\rho = 0$ kg/m³

Ambient Temperature : 23.3 °C;

DASY5 Configuration:

- Probe: EF3DV3 - SN4050; ConvF(1, 1, 1); Calibrated: 2021.1.25
- Sensor-Surface: (Fix Surface)
- Electronics: DAE4 Sn1649; Calibrated: 2021.2.3
- Phantom: HAC Test Arch with AMCC; Type: SD HAC P01 BA;
- Measurement SW: DASY52, Version 52.10 (4); SEMCAD X Version 14.6.14 (7483)

Ch37850/Hearing Aid Compatibility Test (101x101x1): Interpolated grid: dx=0.5000 mm, dy=0.5000 mm

Device Reference Point: 0, 0, -6.3 mm

Reference Value = 26.92 V/m; Power Drift = -0.03 dB

Applied MIF = -1.44 dB

RF audio interference level = 25.06 dBV/m

MIF scaled E-field

Grid 1 M4 24.2 dBV/m	Grid 2 M4 25 dBV/m	Grid 3 M4 24.84 dBV/m
Grid 4 M4 21.65 dBV/m	Grid 5 M4 25.06 dBV/m	Grid 6 M4 25.01 dBV/m
Grid 7 M4 21.64 dBV/m	Grid 8 M4 24.83 dBV/m	Grid 9 M4 24.82 dBV/m

Total = 25.06 dBV/m

E Category: M4

Location: -6, -4.5, 8.7 mm

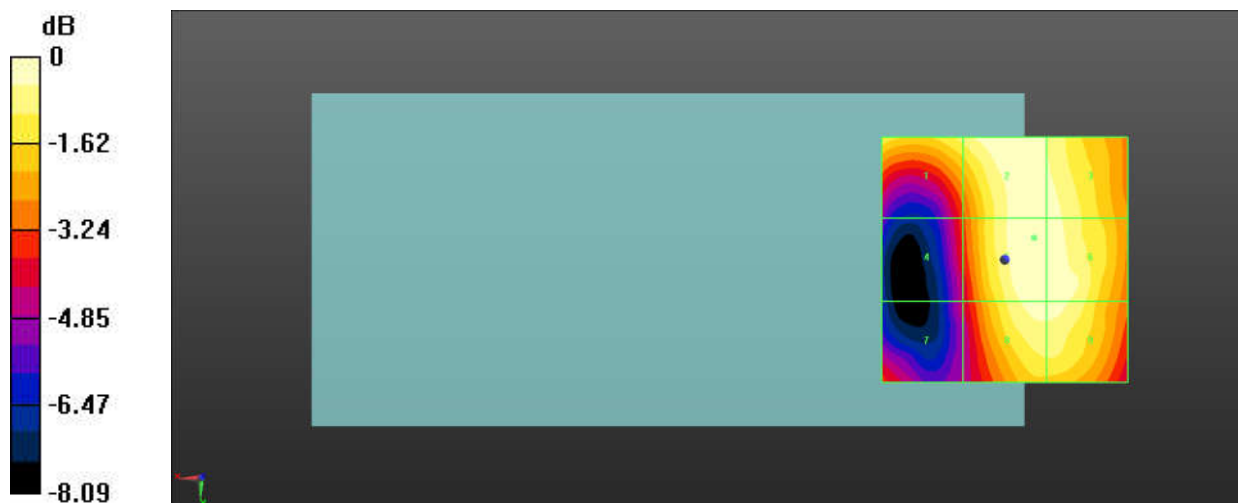

0 dB = 17.90 V/m = 25.06 dBV/m

8_HAC RF LTE B38_Ant 0_QPSK_1_0_Ch38000

Communication System: UID 10173 - CAG, LTE-TDD (SC-FDMA, 1 RB, 20 MHz, 16-QAM);
 Frequency: 2595 MHz; Duty Cycle: 1:8.8736

Medium: Air Medium parameters used: $\sigma = 0$ S/m, $\epsilon_r = 1$; $\rho = 0$ kg/m³

Ambient Temperature : 23.3 °C;

DASY5 Configuration:

- Probe: EF3DV3 - SN4050; ConvF(1, 1, 1); Calibrated: 2021.1.25
- Sensor-Surface: (Fix Surface)
- Electronics: DAE4 Sn1649; Calibrated: 2021.2.3
- Phantom: HAC Test Arch with AMCC; Type: SD HAC P01 BA;
- Measurement SW: DASY52, Version 52.10 (4); SEMCAD X Version 14.6.14 (7483)

Ch38000/Hearing Aid Compatibility Test (101x101x1): Interpolated grid: dx=0.5000 mm, dy=0.5000 mm

Device Reference Point: 0, 0, -6.3 mm

Reference Value = 26.63 V/m; Power Drift = -0.14 dB

Applied MIF = -1.44 dB

RF audio interference level = 25.50 dBV/m

MIF scaled E-field

Grid 1 M4 24.37 dBV/m	Grid 2 M4 25.24 dBV/m	Grid 3 M4 25.21 dBV/m
Grid 4 M4 21.66 dBV/m	Grid 5 M4 25.5 dBV/m	Grid 6 M4 25.48 dBV/m
Grid 7 M4 22.37 dBV/m	Grid 8 M4 25.24 dBV/m	Grid 9 M4 25.25 dBV/m

Total = 25.50 dBV/m

E Category: M4

Location: -7, 0, 8.7 mm

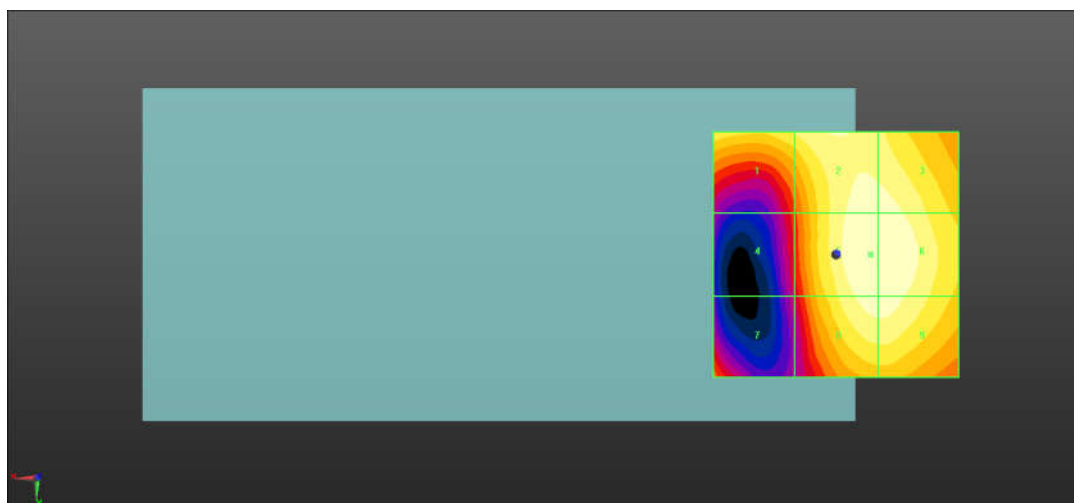
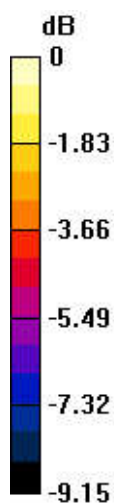

0 dB = 18.85 V/m = 25.51 dBV/m

9_HAC RF LTE B38_Ant 0_QPSK_1_0_Ch38150

Communication System: UID 10173 - CAG, LTE-TDD (SC-FDMA, 1 RB, 20 MHz, 16-QAM);
 Frequency: 2610 MHz; Duty Cycle: 1:8.8736

Medium: Air Medium parameters used: $\sigma = 0$ S/m, $\epsilon_r = 1$; $\rho = 0$ kg/m³

Ambient Temperature : 23.3 °C;

DASY5 Configuration:

- Probe: EF3DV3 - SN4050; ConvF(1, 1, 1); Calibrated: 2021.1.25
- Sensor-Surface: (Fix Surface)
- Electronics: DAE4 Sn1649; Calibrated: 2021.2.3
- Phantom: HAC Test Arch with AMCC; Type: SD HAC P01 BA;
- Measurement SW: DASY52, Version 52.10 (4); SEMCAD X Version 14.6.14 (7483)

Ch38150/Hearing Aid Compatibility Test (101x101x1): Interpolated grid: dx=0.5000 mm, dy=0.5000 mm

Device Reference Point: 0, 0, -6.3 mm

Reference Value = 25.63 V/m; Power Drift = -0.07 dB

Applied MIF = -1.44 dB

RF audio interference level = 26.42 dBV/m

MIF scaled E-field

Grid 1 M4 25.8 dBV/m	Grid 2 M4 26.42 dBV/m	Grid 3 M4 25.58 dBV/m
Grid 4 M4 22.5 dBV/m	Grid 5 M4 25.49 dBV/m	Grid 6 M4 25.39 dBV/m
Grid 7 M4 22.82 dBV/m	Grid 8 M4 24.83 dBV/m	Grid 9 M4 24.81 dBV/m

Total = 26.42 dBV/m

E Category: M4

Location: 1, -25, 8.7 mm

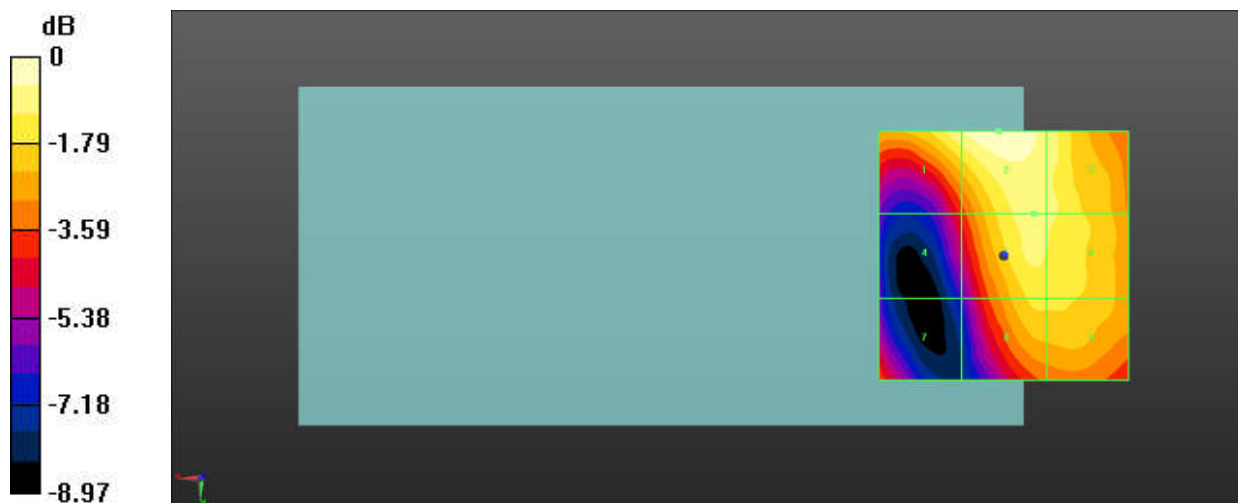

0 dB = 20.94 V/m = 26.42 dBV/m

10_HAC RF LTE B41_Ant 0_QPSK_1_0_HPUE_Ch39750

Communication System: UID 10173 - CAG, LTE-TDD (SC-FDMA, 1 RB, 20 MHz, 16-QAM);
 Frequency: 2506 MHz; Duty Cycle: 1:8.8736

Medium: Air Medium parameters used: $\sigma = 0$ S/m, $\epsilon_r = 1$; $\rho = 0$ kg/m³

Ambient Temperature : 23.3 °C;

DASY5 Configuration:

- Probe: EF3DV3 - SN4050; ConvF(1, 1, 1); Calibrated: 2021.1.25
- Sensor-Surface: (Fix Surface)
- Electronics: DAE4 Sn1649; Calibrated: 2021.2.3
- Phantom: HAC Test Arch with AMCC; Type: SD HAC P01 BA;
- Measurement SW: DASY52, Version 52.10 (4); SEMCAD X Version 14.6.14 (7483)

Ch39750/Hearing Aid Compatibility Test (101x101x1): Interpolated grid: dx=0.5000 mm, dy=0.5000 mm

Device Reference Point: 0, 0, -6.3 mm

Reference Value = 24.02 V/m; Power Drift = -0.09 dB

Applied MIF = -1.44 dB

RF audio interference level = 24.86 dBV/m

MIF scaled E-field

Grid 1 M4 23.66 dBV/m	Grid 2 M4 24.86 dBV/m	Grid 3 M4 24.54 dBV/m
Grid 4 M4 21.8 dBV/m	Grid 5 M4 24.65 dBV/m	Grid 6 M4 24.52 dBV/m
Grid 7 M4 21.62 dBV/m	Grid 8 M4 23.82 dBV/m	Grid 9 M4 23.81 dBV/m

Total = 24.86 dBV/m

E Category: M4

Location: -1.5, -25, 8.7 mm

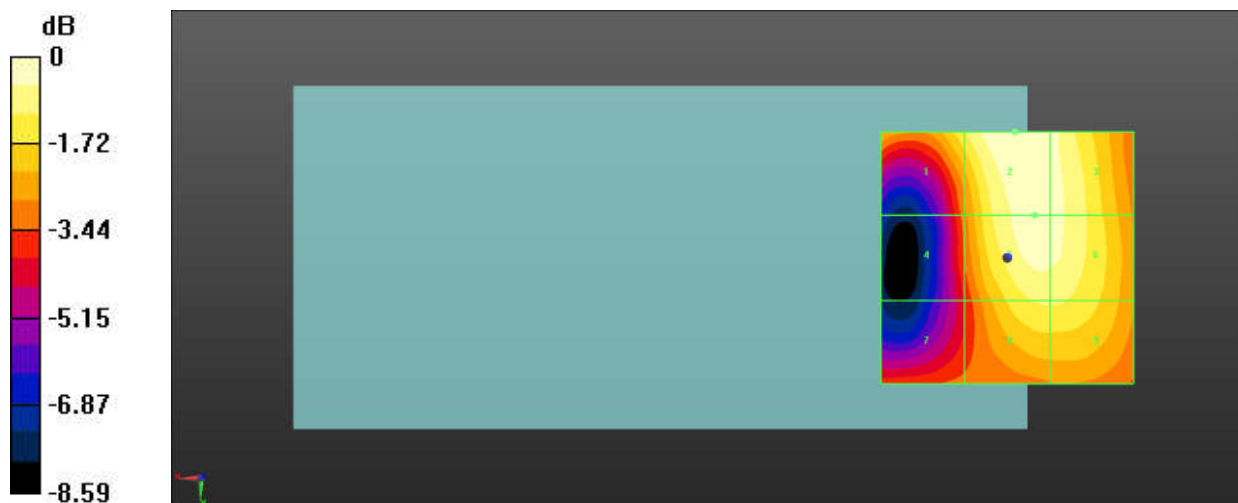

0 dB = 17.50 V/m = 24.86 dBV/m

11_HAC RF LTE B41_Ant 0_QPSK_1_0_HPUE_Ch40185

Communication System: UID 10173 - CAG, LTE-TDD (SC-FDMA, 1 RB, 20 MHz, 16-QAM);
 Frequency: 2549.5 MHz; Duty Cycle: 1:8.8736

Medium: Air Medium parameters used: $\sigma = 0$ S/m, $\epsilon_r = 1$; $\rho = 0$ kg/m³

Ambient Temperature : 23.3 °C;

DASY5 Configuration:

- Probe: EF3DV3 - SN4050; ConvF(1, 1, 1); Calibrated: 2021.1.25
- Sensor-Surface: (Fix Surface)
- Electronics: DAE4 Sn1649; Calibrated: 2021.2.3
- Phantom: HAC Test Arch with AMCC; Type: SD HAC P01 BA;
- Measurement SW: DASY52, Version 52.10 (4); SEMCAD X Version 14.6.14 (7483)

Ch40185/Hearing Aid Compatibility Test (101x101x1): Interpolated grid: dx=0.5000 mm, dy=0.5000 mm

Device Reference Point: 0, 0, -6.3 mm

Reference Value = 24.64 V/m; Power Drift = -0.05 dB

Applied MIF = -1.44 dB

RF audio interference level = 25.29 dBV/m

MIF scaled E-field

Grid 1 M4 24.26 dBV/m	Grid 2 M4 25.27 dBV/m	Grid 3 M4 25.24 dBV/m
Grid 4 M4 22.3 dBV/m	Grid 5 M4 25.29 dBV/m	Grid 6 M4 25.26 dBV/m
Grid 7 M4 21.96 dBV/m	Grid 8 M4 24.49 dBV/m	Grid 9 M4 24.49 dBV/m

Total = 25.29 dBV/m

E Category: M4

Location: -6.5, -6, 8.7 mm

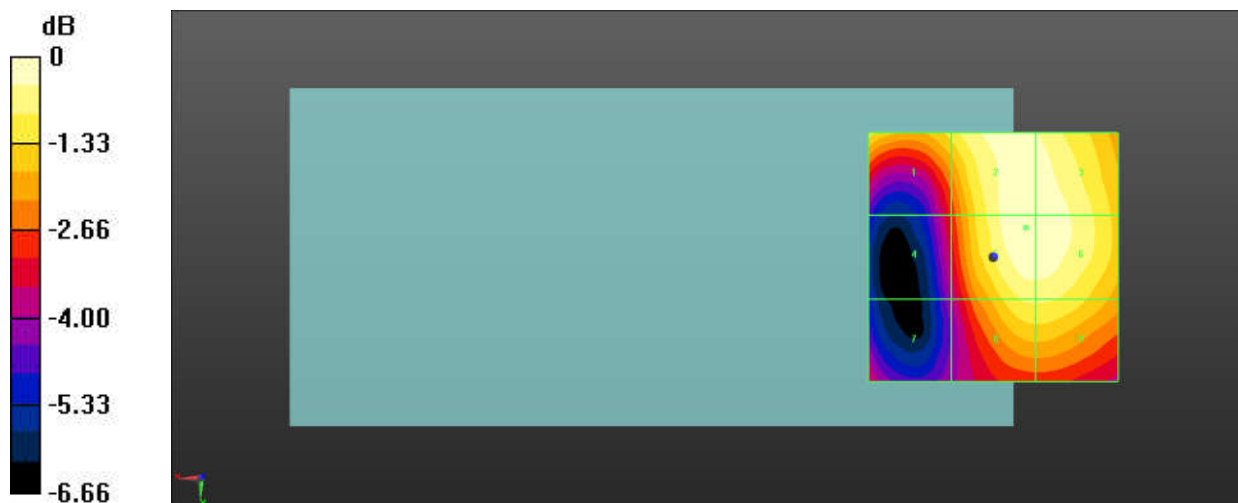

0 dB = 18.39 V/m = 25.29 dBV/m

12_HAC RF LTE B41_Ant 0_QPSK_1_0_HPUE_Ch40620

Communication System: UID 10173 - CAG, LTE-TDD (SC-FDMA, 1 RB, 20 MHz, 16-QAM);
 Frequency: 2593 MHz; Duty Cycle: 1:8.8736

Medium: Air Medium parameters used: $\sigma = 0$ S/m, $\epsilon_r = 1$; $\rho = 0$ kg/m³

Ambient Temperature : 23.3 °C;

DASY5 Configuration:

- Probe: EF3DV3 - SN4050; ConvF(1, 1, 1); Calibrated: 2021.1.25
- Sensor-Surface: (Fix Surface)
- Electronics: DAE4 Sn1649; Calibrated: 2021.2.3
- Phantom: HAC Test Arch with AMCC; Type: SD HAC P01 BA;
- Measurement SW: DASY52, Version 52.10 (4); SEMCAD X Version 14.6.14 (7483)

Ch40620/Hearing Aid Compatibility Test (101x101x1): Interpolated grid: dx=0.5000 mm, dy=0.5000 mm

Device Reference Point: 0, 0, -6.3 mm

Reference Value = 24.87 V/m; Power Drift = -0.03 dB

Applied MIF = -1.44 dB

RF audio interference level = 24.79 dBV/m

MIF scaled E-field

Grid 1 M4 23.44 dBV/m	Grid 2 M4 24.66 dBV/m	Grid 3 M4 24.65 dBV/m
Grid 4 M4 20.61 dBV/m	Grid 5 M4 24.79 dBV/m	Grid 6 M4 24.79 dBV/m
Grid 7 M4 22.03 dBV/m	Grid 8 M4 24.39 dBV/m	Grid 9 M4 24.43 dBV/m

Total = 24.79 dBV/m

E Category: M4

Location: -9, -1.5, 8.7 mm

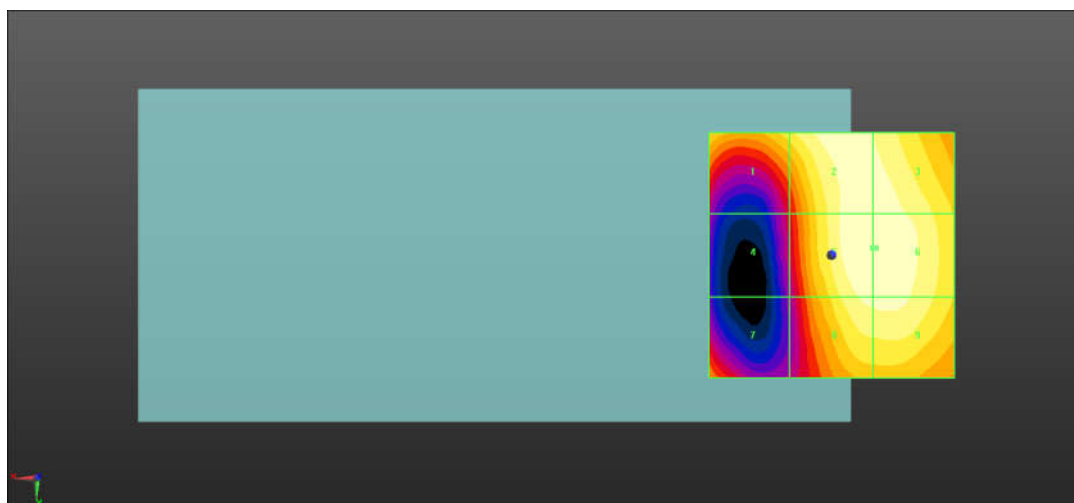
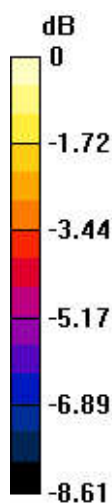

0 dB = 17.35 V/m = 24.79 dBV/m

13_HAC RF LTE B41_Ant 0_QPSK_1_0_HPUE_Ch41055

Communication System: UID 10173 - CAG, LTE-TDD (SC-FDMA, 1 RB, 20 MHz, 16-QAM);
 Frequency: 2636.5 MHz; Duty Cycle: 1:8.8736

Medium: Air Medium parameters used: $\sigma = 0$ S/m, $\epsilon_r = 1$; $\rho = 0$ kg/m³

Ambient Temperature : 23.3 °C;

DASY5 Configuration:

- Probe: EF3DV3 - SN4050; ConvF(1, 1, 1); Calibrated: 2021.1.25
- Sensor-Surface: (Fix Surface)
- Electronics: DAE4 Sn1649; Calibrated: 2021.2.3
- Phantom: HAC Test Arch with AMCC; Type: SD HAC P01 BA;
- Measurement SW: DASY52, Version 52.10 (4); SEMCAD X Version 14.6.14 (7483)

Ch41055/Hearing Aid Compatibility Test (101x101x1): Interpolated grid: dx=0.5000 mm, dy=0.5000 mm

Device Reference Point: 0, 0, -6.3 mm

Reference Value = 20.14 V/m; Power Drift = 0.03 dB

Applied MIF = -1.44 dB

RF audio interference level = 25.70 dBV/m

MIF scaled E-field

Grid 1 M4 24.6 dBV/m	Grid 2 M4 25.7 dBV/m	Grid 3 M4 25.4 dBV/m
Grid 4 M4 21.11 dBV/m	Grid 5 M4 24.83 dBV/m	Grid 6 M4 24.83 dBV/m
Grid 7 M4 23.23 dBV/m	Grid 8 M4 23.48 dBV/m	Grid 9 M4 23.67 dBV/m

Total = 25.70 dBV/m

E Category: M4

Location: -2, -25, 8.7 mm

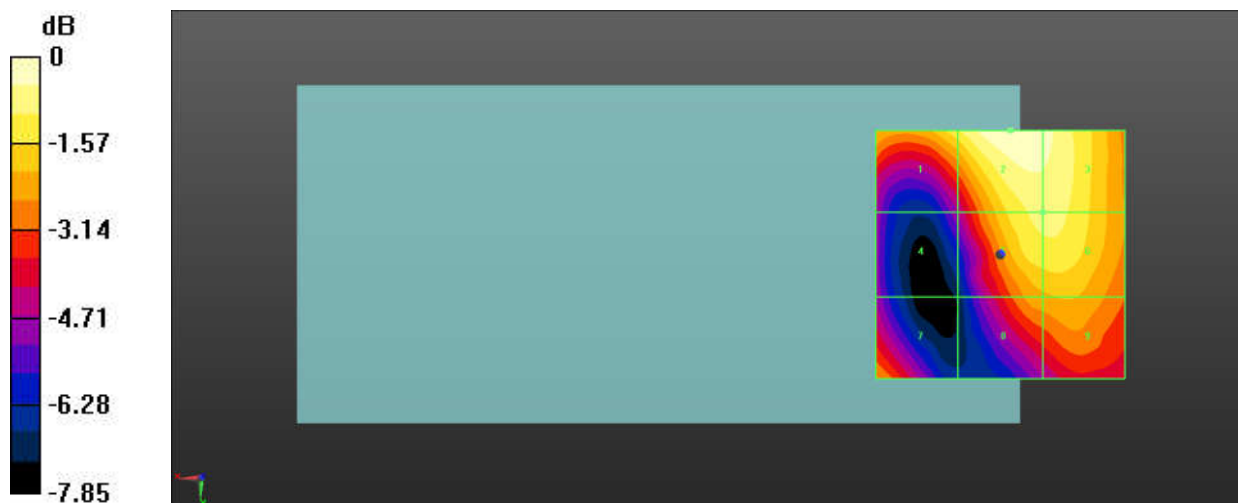

0 dB = 19.28 V/m = 25.70 dBV/m

14_HAC RF LTE B41_Ant 0_QPSK_1_0_HPUE_Ch41490

Communication System: UID 10173 - CAG, LTE-TDD (SC-FDMA, 1 RB, 20 MHz, 16-QAM);
 Frequency: 2680 MHz; Duty Cycle: 1:8.8736

Medium: Air Medium parameters used: $\sigma = 0$ S/m, $\epsilon_r = 1$; $\rho = 0$ kg/m³

Ambient Temperature : 23.3 °C;

DASY5 Configuration:

- Probe: EF3DV3 - SN4050; ConvF(1, 1, 1); Calibrated: 2021.1.25
- Sensor-Surface: (Fix Surface)
- Electronics: DAE4 Sn1649; Calibrated: 2021.2.3
- Phantom: HAC Test Arch with AMCC; Type: SD HAC P01 BA;
- Measurement SW: DASY52, Version 52.10 (4); SEMCAD X Version 14.6.14 (7483)

Ch41490/Hearing Aid Compatibility Test (101x101x1): Interpolated grid: dx=0.5000 mm, dy=0.5000 mm

Device Reference Point: 0, 0, -6.3 mm

Reference Value = 24.32 V/m; Power Drift = 0.01 dB

Applied MIF = -1.44 dB

RF audio interference level = 26.07 dBV/m

MIF scaled E-field

Grid 1 M4 24.67 dBV/m	Grid 2 M4 26.07 dBV/m	Grid 3 M4 25.6 dBV/m
Grid 4 M4 21.83 dBV/m	Grid 5 M4 25.18 dBV/m	Grid 6 M4 25.13 dBV/m
Grid 7 M4 21.71 dBV/m	Grid 8 M4 24.05 dBV/m	Grid 9 M4 24.06 dBV/m

Total = 26.07 dBV/m

E Category: M4

Location: -1.5, -25, 8.7 mm

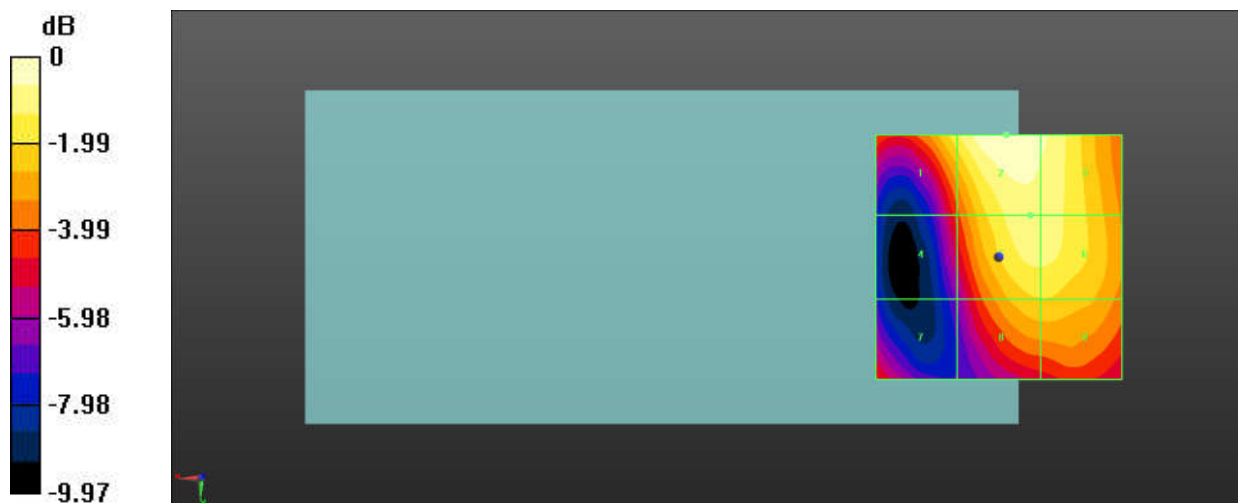

0 dB = 20.10 V/m = 26.06 dBV/m

15_HAC RF LTE B48_Ant 2_QPSK_1_0_Ch55340

Communication System: UID 10173 - CAG, LTE-TDD (SC-FDMA, 1 RB, 20 MHz, 16-QAM);
 Frequency: 3560 MHz; Duty Cycle: 1:8.8736

Medium: Air Medium parameters used: $\sigma = 0$ S/m, $\epsilon_r = 1$; $\rho = 0$ kg/m³

Ambient Temperature : 23.3 °C;

DASY5 Configuration:

- Probe: EF3DV3 - SN4050; ConvF(1, 1, 1); Calibrated: 2021.1.25
- Sensor-Surface: (Fix Surface)
- Electronics: DAE4 Sn1649; Calibrated: 2021.2.3
- Phantom: HAC Test Arch with AMCC; Type: SD HAC P01 BA;
- Measurement SW: DASY52, Version 52.10 (4); SEMCAD X Version 14.6.14 (7483)

Ch55340/Hearing Aid Compatibility Test (101x101x1): Interpolated grid: dx=0.5000 mm, dy=0.5000 mm

Device Reference Point: 0, 0, -6.3 mm

Reference Value = 51.20 V/m; Power Drift = -0.04 dB

Applied MIF = -1.44 dB

RF audio interference level = 30.58 dBV/m

MIF scaled E-field

Grid 1 M4 26.91 dBV/m	Grid 2 M4 29.41 dBV/m	Grid 3 M4 29.27 dBV/m
Grid 4 M4 27.63 dBV/m	Grid 5 M3 30.18 dBV/m	Grid 6 M3 30.17 dBV/m
Grid 7 M4 28.13 dBV/m	Grid 8 M3 30.58 dBV/m	Grid 9 M3 30.57 dBV/m

Total = 30.58 dBV/m

E Category: M3

Location: -7.5, 22.5, 8.7 mm

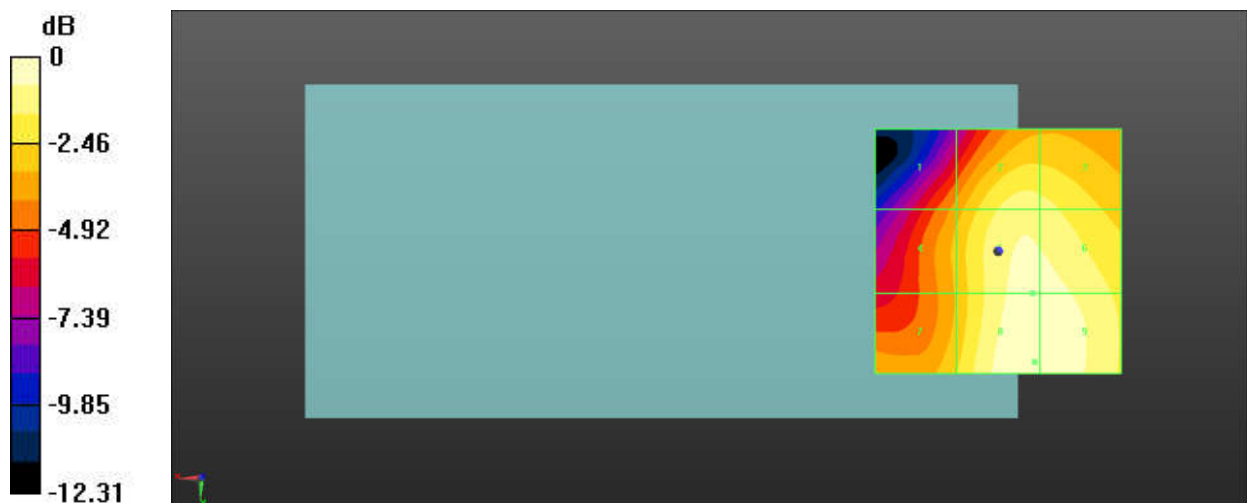

0 dB = 33.82 V/m = 30.58 dBV/m

16_HAC RF LTE B48_Ant 2_QPSK_1_0_Ch55830

Communication System: UID 10173 - CAG, LTE-TDD (SC-FDMA, 1 RB, 20 MHz, 16-QAM);
 Frequency: 3609 MHz; Duty Cycle: 1:8.8736

Medium: Air Medium parameters used: $\sigma = 0$ S/m, $\epsilon_r = 1$; $\rho = 0$ kg/m³

Ambient Temperature : 23.3 °C;

DASY5 Configuration:

- Probe: EF3DV3 - SN4050; ConvF(1, 1, 1); Calibrated: 2021.1.25
- Sensor-Surface: (Fix Surface)
- Electronics: DAE4 Sn1649; Calibrated: 2021.2.3
- Phantom: HAC Test Arch with AMCC; Type: SD HAC P01 BA;
- Measurement SW: DASY52, Version 52.10 (4); SEMCAD X Version 14.6.14 (7483)

Ch55830/Hearing Aid Compatibility Test (101x101x1): Interpolated grid: dx=0.5000 mm, dy=0.5000 mm

Device Reference Point: 0, 0, -6.3 mm

Reference Value = 48.18 V/m; Power Drift = 0.01 dB

Applied MIF = -1.44 dB

RF audio interference level = 31.27 dBV/m

MIF scaled E-field

Grid 1 M4 27.21 dBV/m	Grid 2 M4 29.72 dBV/m	Grid 3 M4 29.63 dBV/m
Grid 4 M4 27.38 dBV/m	Grid 5 M3 30.41 dBV/m	Grid 6 M3 30.41 dBV/m
Grid 7 M4 28.64 dBV/m	Grid 8 M3 31.27 dBV/m	Grid 9 M3 31.25 dBV/m

Total = 31.27 dBV/m

E Category: M3

Location: -7.5, 25, 8.7 mm

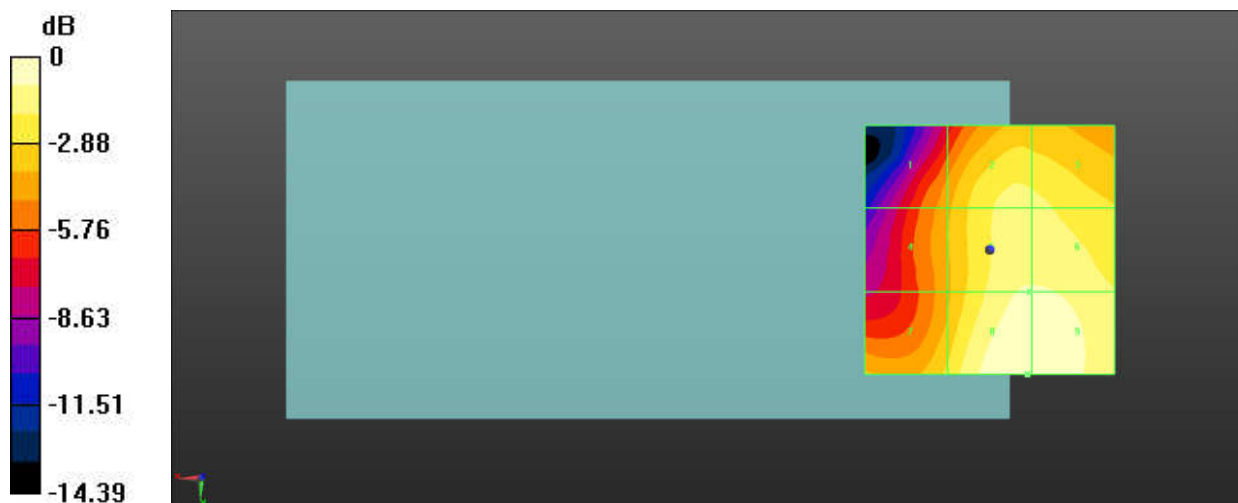

0 dB = 36.59 V/m = 31.27 dBV/m

17_HAC RF LTE B48_Ant 2_QPSK_1_0_Ch56150

Communication System: UID 10173 - CAG, LTE-TDD (SC-FDMA, 1 RB, 20 MHz, 16-QAM);
 Frequency: 3641 MHz; Duty Cycle: 1:8.8736

Medium: Air Medium parameters used: $\sigma = 0$ S/m, $\epsilon_r = 1$; $\rho = 0$ kg/m³

Ambient Temperature : 23.3 °C;

DASY5 Configuration:

- Probe: EF3DV3 - SN4050; ConvF(1, 1, 1); Calibrated: 2021.1.25
- Sensor-Surface: (Fix Surface)
- Electronics: DAE4 Sn1649; Calibrated: 2021.2.3
- Phantom: HAC Test Arch with AMCC; Type: SD HAC P01 BA;
- Measurement SW: DASY52, Version 52.10 (4); SEMCAD X Version 14.6.14 (7483)

Ch56150/Hearing Aid Compatibility Test (101x101x1): Interpolated grid: dx=0.5000 mm, dy=0.5000 mm

Device Reference Point: 0, 0, -6.3 mm

Reference Value = 49.52 V/m; Power Drift = -0.12 dB

Applied MIF = -1.44 dB

RF audio interference level = 31.32 dBV/m

MIF scaled E-field

Grid 1 M4 26.73 dBV/m	Grid 2 M4 29.65 dBV/m	Grid 3 M4 29.59 dBV/m
Grid 4 M4 27.05 dBV/m	Grid 5 M3 30.55 dBV/m	Grid 6 M3 30.61 dBV/m
Grid 7 M4 29.25 dBV/m	Grid 8 M3 31.32 dBV/m	Grid 9 M3 31.29 dBV/m

Total = 31.32 dBV/m

E Category: M3

Location: -6.5, 25, 8.7 mm

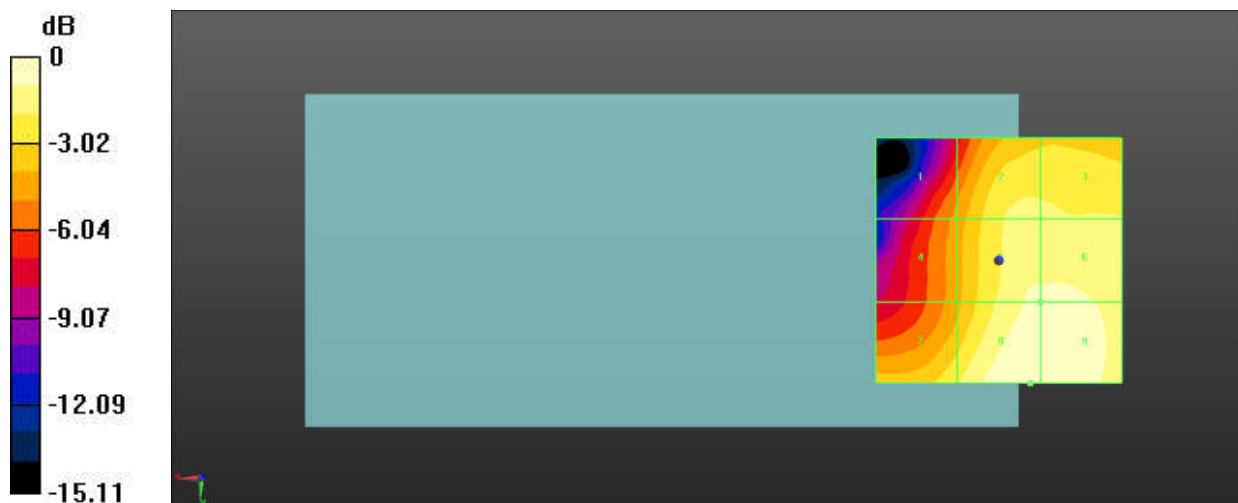

0 dB = 36.82 V/m = 31.32 dBV/m

18_HAC RF LTE B48_Ant 2_QPSK_1_0_Ch56640

Communication System: UID 10173 - CAG, LTE-TDD (SC-FDMA, 1 RB, 20 MHz, 16-QAM);
 Frequency: 3690 MHz; Duty Cycle: 1:8.8736

Medium: Air Medium parameters used: $\sigma = 0$ S/m, $\epsilon_r = 1$; $\rho = 0$ kg/m³

Ambient Temperature : 23.3 °C;

DASY5 Configuration:

- Probe: EF3DV3 - SN4050; ConvF(1, 1, 1); Calibrated: 2021.1.25
- Sensor-Surface: (Fix Surface)
- Electronics: DAE4 Sn1649; Calibrated: 2021.2.3
- Phantom: HAC Test Arch with AMCC; Type: SD HAC P01 BA;
- Measurement SW: DASY52, Version 52.10 (4); SEMCAD X Version 14.6.14 (7483)

Ch56640/Hearing Aid Compatibility Test (101x101x1): Interpolated grid: dx=0.5000 mm, dy=0.5000 mm

Device Reference Point: 0, 0, -6.3 mm

Reference Value = 49.27 V/m; Power Drift = -0.02 dB

Applied MIF = -1.44 dB

RF audio interference level = 31.96 dBV/m

MIF scaled E-field

Grid 1 M4 27.01 dBV/m	Grid 2 M3 30.07 dBV/m	Grid 3 M3 30.07 dBV/m
Grid 4 M4 27.54 dBV/m	Grid 5 M3 30.86 dBV/m	Grid 6 M3 30.89 dBV/m
Grid 7 M4 29.91 dBV/m	Grid 8 M3 31.96 dBV/m	Grid 9 M3 31.91 dBV/m

Total = 31.96 dBV/m

E Category: M3

Location: -6.5, 25, 8.7 mm

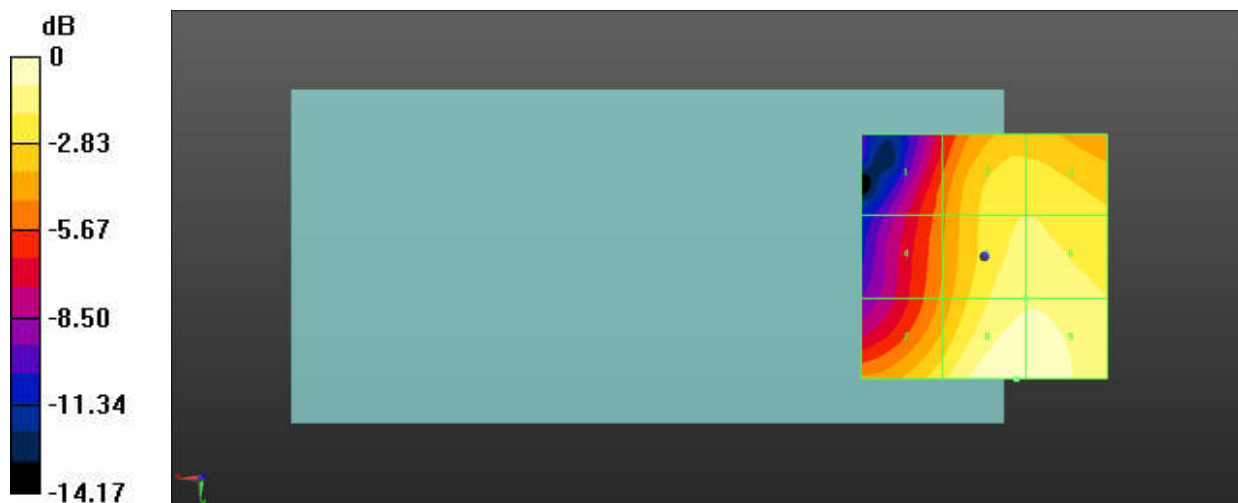

0 dB = 39.64 V/m = 31.96 dBV/m



Appendix C. DASY Calibration Certificate

The DASY calibration certificates are shown as follows.



Accredited by the Swiss Accreditation Service (SAS)
The Swiss Accreditation Service is one of the signatories to the EA
Multilateral Agreement for the recognition of calibration certificates

Accreditation No.: **SCS 0108**

Client **Sporton**

Certificate No: **CD835V3-1045_Sep21**

CALIBRATION CERTIFICATE

Object **CD835V3 - SN: 1045**

Calibration procedure(s) **QA CAL-20.v7
Calibration Procedure for Validation Sources in air**

Calibration date: **September 27, 2021**

This calibration certificate documents the traceability to national standards, which realize the physical units of measurements (SI).
The measurements and the uncertainties with confidence probability are given on the following pages and are part of the certificate.

All calibrations have been conducted in the closed laboratory facility: environment temperature (22 ± 3)°C and humidity < 70%.

Calibration Equipment used (M&TE critical for calibration)

Primary Standards	ID #	Cal Date (Certificate No.)	Scheduled Calibration
Power meter NRP	SN: 104778	09-Apr-21 (No. 217-03291/03292)	Apr-22
Power sensor NRP-Z91	SN: 103244	09-Apr-21 (No. 217-03291)	Apr-22
Power sensor NRP-Z91	SN: 103245	09-Apr-21 (No. 217-03292)	Apr-22
Reference 20 dB Attenuator	SN: BH9394 (20k)	09-Apr-21 (No. 217-03343)	Apr-22
Type-N mismatch combination	SN: 310982 / 06327	09-Apr-21 (No. 217-03344)	Apr-22
Probe EF3DV3	SN: 4013	28-Dec-20 (No. EF3-4013_Dec20)	Dec-21
DAE4	SN: 781	23-Dec-20 (No. DAE4-781_Dec20)	Dec-21

Secondary Standards	ID #	Check Date (in house)	Scheduled Check
Power meter Agilent 4419B	SN: GB42420191	09-Oct-09 (in house check Oct-20)	In house check: Oct-23
Power sensor HP E4412A	SN: US38485102	05-Jan-10 (in house check Oct-20)	In house check: Oct-23
Power sensor HP 8482A	SN: US37295597	09-Oct-09 (in house check Oct-20)	In house check: Oct-23
RF generator R&S SMT-06	SN: 837633/005	10-Jan-19 (in house check Oct-20)	In house check: Oct-23
Network Analyzer Agilent E8358A	SN: US41080477	31-Mar-14 (in house check Oct-20)	In house check: Oct-21

	Name	Function	Signature
Calibrated by:	Jeton Kastrati	Laboratory Technician	
Approved by:	Katja Pokovic	Technical Manager	

Issued: September 27, 2021

This calibration certificate shall not be reproduced except in full without written approval of the laboratory.



Accredited by the Swiss Accreditation Service (SAS)

The Swiss Accreditation Service is one of the signatories to the EA
Multilateral Agreement for the recognition of calibration certificates

Accreditation No.: **SCS 0108**

References

- [1] ANSI-C63.19-2019 (ANSI-C63.19-2011)
American National Standard, Methods of Measurement of Compatibility between Wireless Communications Devices and Hearing Aids.

Methods Applied and Interpretation of Parameters:

- *Coordinate System:* y-axis is in the direction of the dipole arms. z-axis is from the basis of the antenna (mounted on the table) towards its feed point between the two dipole arms. x-axis is normal to the other axes. In coincidence with the standards [1], the measurement planes (probe sensor center) are selected to be at a distance of 15 mm above the top metal edge of the dipole arms.
- *Measurement Conditions:* Further details are available from the hardcopies at the end of the certificate. All figures stated in the certificate are valid at the frequency indicated. The forward power to the dipole connector is set with a calibrated power meter connected and monitored with an auxiliary power meter connected to a directional coupler. While the dipole under test is connected, the forward power is adjusted to the same level.
- *Antenna Positioning:* The dipole is mounted on a HAC Test Arch phantom using the matching dipole positioner with the arms horizontal and the feeding cable coming from the floor. The measurements are performed in a shielded room with absorbers around the setup to reduce the reflections. It is verified before the mounting of the dipole under the Test Arch phantom, that its arms are perfectly in a line. It is installed on the HAC dipole positioner with its arms parallel below the dielectric reference wire and able to move elastically in vertical direction without changing its relative position to the top center of the Test Arch phantom. The vertical distance to the probe is adjusted after dipole mounting with a DASY5 Surface Check job. Before the measurement, the distance between phantom surface and probe tip is verified. The proper measurement distance is selected by choosing the matching section of the HAC Test Arch phantom with the proper device reference point (upper surface of the dipole) and the matching grid reference point (tip of the probe) considering the probe sensor offset. The vertical distance to the probe is essential for the accuracy.
- *Feed Point Impedance and Return Loss:* These parameters are measured using a Vector Network Analyzer. The impedance is specified at the SMA connector of the dipole. The influence of reflections was eliminated by applying the averaging function while moving the dipole in the air, at least 70cm away from any obstacles.
- *E-field distribution:* E field is measured in the x-y-plane with an isotropic E-field probe with 100 mW forward power to the antenna feed point. In accordance with [1], the scan area is 20mm wide, its length exceeds the dipole arm length (180 or 90mm). The sensor center is 15 mm (in z) above the metal top of the dipole arms. Two 3D maxima are available near the end of the dipole arms. Assuming the dipole arms are perfectly in one line, the average of these two maxima (in subgrid 2 and subgrid 8) is determined to compensate for any non-parallelity to the measurement plane as well as the sensor displacement. The E-field value stated as calibration value represents the maximum of the interpolated 3D-E-field, in the plane above the dipole surface.

The reported uncertainty of measurement is stated as the standard uncertainty of measurement multiplied by the coverage factor $k=2$, which for a normal distribution corresponds to a coverage probability of approximately 95%.

Measurement Conditions

DASY system configuration, as far as not given on page 1.

DASY Version	DASY5	V52.10.4
Phantom	HAC Test Arch	
Distance Dipole Top - Probe Center	15 mm	
Scan resolution	dx, dy = 5 mm	
Frequency	835 MHz \pm 1 MHz	
Input power drift	< 0.05 dB	

Maximum Field values at 835 MHz

E-field 15 mm above dipole surface	condition	Interpolated maximum
Maximum measured above high end	100 mW input power	108.2 V/m = 40.68 dBV/m
Maximum measured above low end	100 mW input power	105.4 V/m = 40.46 dBV/m
Averaged maximum above arm	100 mW input power	106.8 V/m \pm 12.8 % (k=2)

Appendix (Additional assessments outside the scope of SCS 0108)

Antenna Parameters

Frequency	Return Loss	Impedance
800 MHz	15.7 dB	39.6 Ω - 10.5 j Ω
835 MHz	31.8 dB	49.3 Ω + 2.5 j Ω
880 MHz	19.0 dB	56.2 Ω - 10.2 j Ω
900 MHz	18.4 dB	49.6 Ω - 12.0 j Ω
945 MHz	20.4 dB	48.2 Ω + 9.2 j Ω

3.2 Antenna Design and Handling

The calibration dipole has a symmetric geometry with a built-in two stub matching network, which leads to the enhanced bandwidth.

The dipole is built of standard semirigid coaxial cable. The internal matching line is open ended. The antenna is therefore open for DC signals.

Do not apply force to dipole arms, as they are liable to bend. The soldered connections near the feedpoint may be damaged. After excessive mechanical stress or overheating, check the impedance characteristics to ensure that the internal matching network is not affected.

After long term use with 40W radiated power, only a slight warming of the dipole near the feedpoint can be measured.

Impedance Measurement Plot

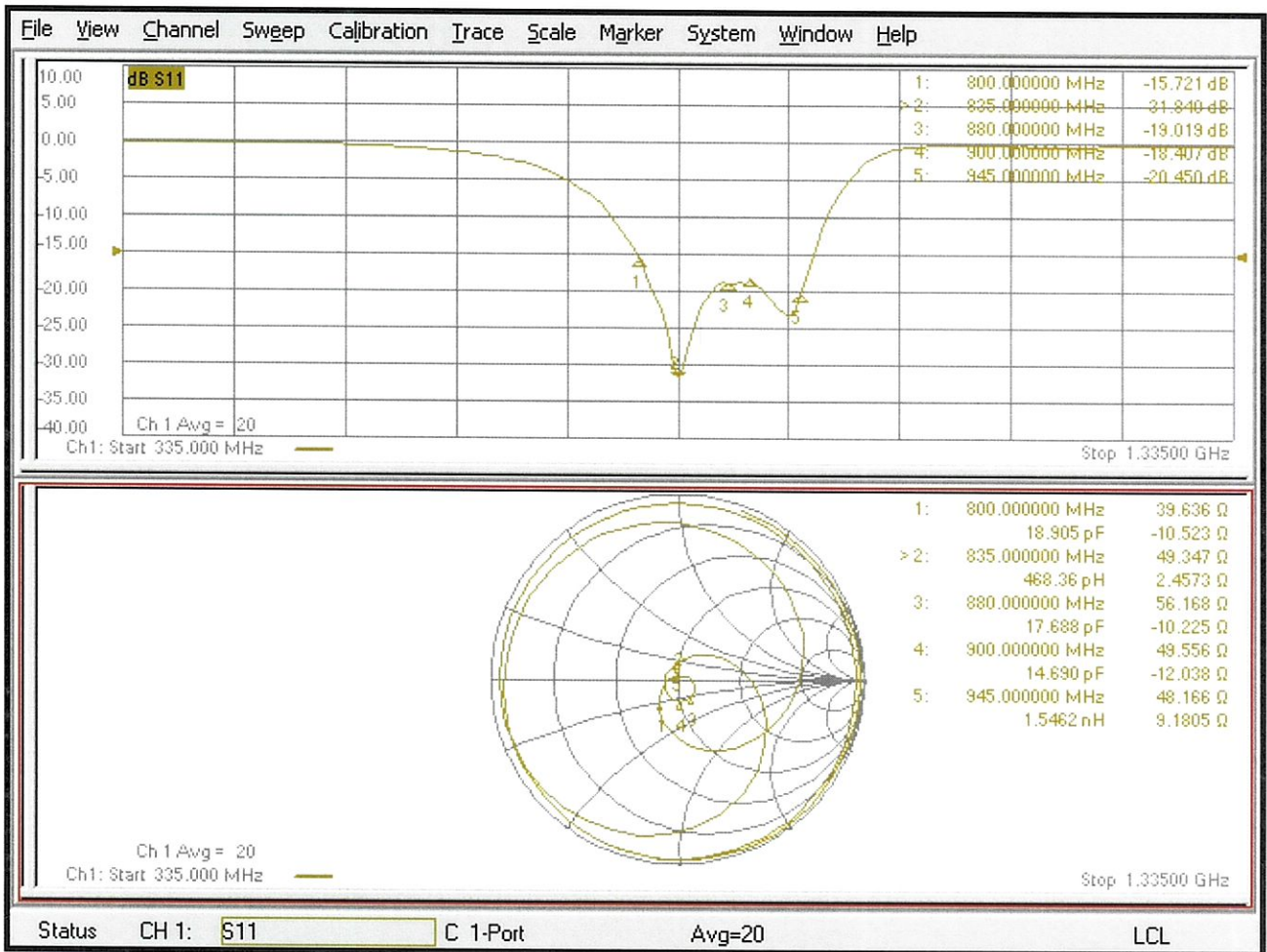

DASY5 E-field Result

Date: 27.09.2021

Test Laboratory: SPEAG Lab2

DUT: HAC-Dipole 835 MHz; Type: CD835V3; Serial: CD835V3 - SN: 1045

Communication System: UID 0 - CW ; Frequency: 835 MHz

Medium parameters used: $\sigma = 0$ S/m, $\epsilon_r = 1$; $\rho = 0$ kg/m³

Phantom section: RF Section

Measurement Standard: DASY5 (IEEE/IEC/ANSI C63.19-2011)

DASY52 Configuration:

- Probe: EF3DV3 - SN4013; ConvF(1, 1, 1) @ 835 MHz; Calibrated: 28.12.2020
- Sensor-Surface: (Fix Surface)
- Electronics: DAE4 Sn781; Calibrated: 23.12.2020
- Phantom: HAC Test Arch with AMCC; Type: SD HAC P01 BA; Serial: 1070
- DASY52 52.10.4(1535); SEMCAD X 14.6.14(7501)

Dipole E-Field measurement @ 835MHz/E-Scan - 835MHz d=15mm/Hearing Aid Compatibility Test (41x361x1):

Interpolated grid: dx=0.5000 mm, dy=0.5000 mm

Device Reference Point: 0, 0, -6.3 mm

Reference Value = 127.6 V/m; Power Drift = 0.01 dB

Applied MIF = 0.00 dB

RF audio interference level = 40.69 dBV/m

Emission category: M3

MIF scaled E-field

Grid 1 M3 40.39 dBV/m	Grid 2 M3 40.46 dBV/m	Grid 3 M3 40.17 dBV/m
Grid 4 M4 35.69 dBV/m	Grid 5 M4 35.69 dBV/m	Grid 6 M4 35.38 dBV/m
Grid 7 M3 40.64 dBV/m	Grid 8 M3 40.68 dBV/m	Grid 9 M3 40.31 dBV/m

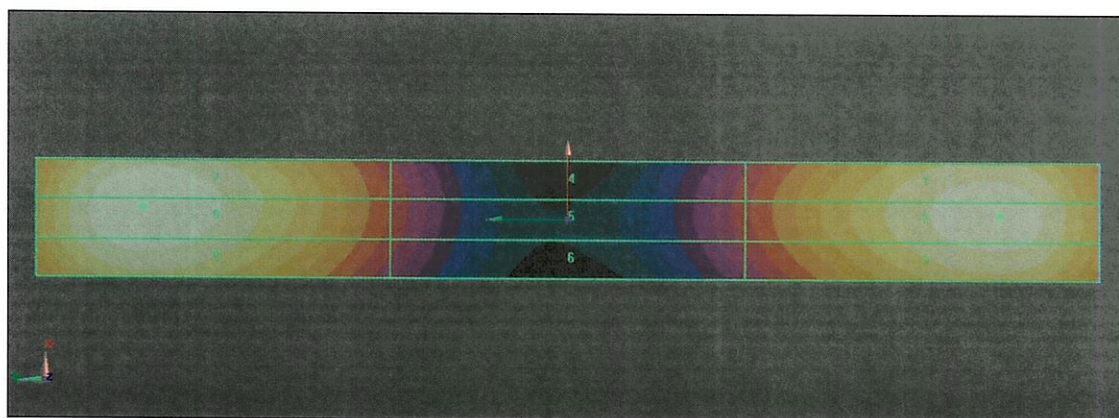
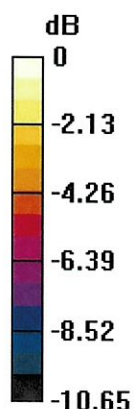

0 dB = 108.2 V/m = 40.68 dBV/m