



FCC RF Test Report

APPLICANT : Motorola Mobility LLC
EQUIPMENT : Mobile Cellular Phone
BRAND NAME : Motorola
MODEL NAME : XT2213-1, XT2213DL, XT2213-2, XT2213-3
FCC ID : IHDT56AA3
STANDARD : 47 CFR Part 2, 22(H), 24(E), 27(L)
CLASSIFICATION : PCS Licensed Transmitter Held to Ear (PCE)
TEST DATE(S) : Dec. 24, 2021 ~ Jan. 19, 2022

We, Sporton International Inc. (Kunshan), would like to declare that the tested sample has been evaluated in accordance with the procedures given in ANSI C63.26-2015 and shown compliance with the applicable technical standards.

The test results in this report apply exclusively to the tested model / sample. Without written approval of Sporton International Inc. (Kunshan), the test report shall not be reproduced except in full.

Jason Jia

Reviewed by: Jason Jia / Supervisor

Alex Wang

Approved by: Alex Wang / Manager



Sporton International Inc. (Kunshan)

**No. 1098, Pengxi North Road, Kunshan Economic Development Zone Jiangsu Province 215300
People's Republic of China**



TABLE OF CONTENTS

REVISION HISTORY... 3
SUMMARY OF TEST RESULT ... 4
1 GENERAL DESCRIPTION ... 5
1.1 Applicant ... 5
1.2 Manufacturer ... 5
1.3 Product Feature of Equipment Under Test ... 5
1.4 Product Specification of Equipment Under Test ... 6
1.5 Modification of EUT ... 7
1.6 Maximum ERP/EIRP Power and Emission Designator ... 7
1.7 Testing Location ... 8
1.8 Test Software ... 9
1.9 Applicable Standards ... 9
1.10 Specification of Accessory ... 9
2 TEST CONFIGURATION OF EQUIPMENT UNDER TEST ... 10
2.1 Test Mode ... 10
2.2 Connection Diagram of Test System ... 13
2.3 Support Unit used in test configuration and system ... 13
2.4 Measurement Results Explanation Example ... 13
2.5 Frequency List of Low/Middle/High Channels ... 14
3 CONDUCTED TEST ITEMS ... 20
3.1 Measuring Instruments ... 20
3.2 Test Setup ... 20
3.3 Test Result of Conducted Test ... 20
3.4 Conducted Output Power and ERP/EIRP ... 21
3.5 Peak-to-Average Ratio ... 22
3.6 Occupied Bandwidth ... 23
3.7 Conducted Band Edge ... 24
3.8 Conducted Spurious Emission ... 26
3.9 Frequency Stability ... 27
4 RADIATED TEST ITEMS ... 28
4.1 Measuring Instruments ... 28
4.2 Test Setup ... 28
4.3 Test Result of Radiated Test ... 29
4.4 Radiated Spurious Emission ... 30
5 LIST OF MEASURING EQUIPMENT ... 31
6 UNCERTAINTY OF EVALUATION ... 32
APPENDIX A. TEST RESULTS OF CONDUCTED TEST
APPENDIX B. TEST RESULTS OF RADIATED TEST
APPENDIX C. TEST SETUP PHOTOGRAPHS



REVISION HISTORY

REPORT NO.	VERSION	DESCRIPTION	ISSUED DATE
FG1D1722B	Rev. 01	Initial issue of report	Feb. 08, 2022



SUMMARY OF TEST RESULT

Report Section	FCC Rule	Description	Limit	Result	Remark
3.4	§2.1046	Conducted Output Power	-	Report Only	-
	§22.913(a)(5)	Effective Radiated Power (Band 5) (Band 26)	ERP < 7 Watt	PASS	-
	§24.232(c) §27.50(h)(2)	Equivalent Isotropic Radiated Power (Band 2) (Band 25)	EIRP < 2Watt		-
	§27.50(d)(4)	Equivalent Isotropic Radiated Power (Band 4) (Band 66)	EIRP < 1Watt		-
3.5	§24.232(d)	Peak-to-Average Ratio	<13 dB	PASS	-
3.6	§2.1049	Occupied Bandwidth	-	Report Only	-
3.7	§2.1051 §22.917(a) §24.238(a) §27.53(h)	Conducted Band Edge Measurement (Band 2) (Band 4) (Band 5) (Band 25) (Band 26) (Band 66)	< 43+10log ₁₀ (P[Watts])	PASS	-
3.8	§2.1051 §22.917(a) §24.238(a) §27.53(h)	Conducted Spurious Emission (Band 2) (Band 4) (Band 5) (Band 25) (Band 26) (Band 66)	< 43+10log ₁₀ (P[Watts])	PASS	-
3.9	§2.1055 §22.355	Frequency Stability Temperature & Voltage	< 2.5 ppm for Part 22	PASS	-
	§2.1055 §24.235 §27.54		Within Authorized Band		
4.4	§2.1053 §22.917(a) §24.238(a) §27.53(h)	Radiated Spurious Emission (Band 2) (Band 4) (Band 5) (Band 25) (Band 26) (Band 66)	< 43+10log ₁₀ (P[Watts])	PASS	Under limit 39.91 dB at 6960.000 MHz

Declaration of Conformity:

The test results with all measurement uncertainty excluded are presented in accordance with the regulation limits or requirements declared by manufacturers.

Comments and Explanations:

The declared of product specification for EUT presented in the report are provided by the manufacturer, and the manufacturer takes all the responsibilities for the accuracy of product specification.



1 General Description

1.1 Applicant

Motorola Mobility LLC
222 W,Merchandise Mart Plaza, Chicago IL 60654 USA

1.2 Manufacturer

Motorola Mobility LLC
222 W,Merchandise Mart Plaza, Chicago IL 60654 USA

1.3 Product Feature of Equipment Under Test

Product Feature	
Equipment	Mobile Cellular Phone
Brand Name	Motorola
Model Name	XT2213-1, XT2213DL, XT2213-2, XT2213-3
FCC ID	IHDT56AA3
IMEI Code	Conducted: 353739480009600 Radiation: 353739480012232
HW Version	DVT2
SW Version	S1SA32.27
EUT Stage	Identical Prototype

Remark:

1. The above EUT's information was declared by manufacturer. Please refer to the specifications or user's manual for more detailed description.
2. The four models XT2213-1, XT2213DL, XT2213-2 and XT2213-3 are only for market differentiation, all the others are the same.



1.4 Product Specification of Equipment Under Test

Standards-related Product Specification	
Tx Frequency	LTE Band 2 : 1850 MHz ~ 1910 MHz LTE Band 4 : 1710 MHz ~ 1755 MHz LTE Band 5 : 824 MHz ~ 849 MHz LTE Band 25 : 1850 MHz ~ 1915 MHz LTE Band 26 : 824 MHz ~ 849 MHz LTE Band 66 : 1710 MHz ~ 1780 MHz
Rx Frequency	LTE Band 2 : 1930 MHz ~ 1990 MHz LTE Band 4 : 2110 MHz ~ 2155 MHz LTE Band 5 : 869 MHz ~ 894 MHz LTE Band 25 : 1930 MHz ~ 1995 MHz LTE Band 26 : 869 MHz ~ 894 MHz LTE Band 66 : 2110 MHz~ 2200 MHz
Bandwidth	LTE Band 2 : 1.4MHz / 3MHz / 5MHz / 10MHz / 15MHz / 20MHz LTE Band 4 : 1.4MHz / 3MHz / 5MHz / 10MHz / 15MHz / 20MHz LTE Band 5 : 1.4MHz / 3MHz / 5MHz / 10MHz LTE Band 25 : 1.4MHz / 3MHz / 5MHz / 10MHz / 15MHz / 20MHz LTE Band 26 : 1.4MHz / 3MHz / 5MHz / 10MHz / 15MHz LTE Band 66 : 1.4MHz / 3MHz / 5MHz / 10MHz / 15MHz / 20MHz
Maximum Output Power to Antenna	<Ant. 0> LTE Band 2 : 22.62 dBm LTE Band 4 : 22.71 dBm LTE Band 5 : 22.83 dBm; LTE Band 5B : 22.73 dBm LTE Band 25 : 22.67 dBm LTE Band 26 : 22.89 dBm LTE Band 66 : 22.77 dBm; LTE Band 66B : 22.44 dBm LTE Band 66C : 22.61 dBm <Ant. 1> LTE Band 2 : 22.91 dBm LTE Band 4 : 23.21 dBm LTE Band 5 : 22.88 dBm; LTE Band 25 : 22.94 dBm LTE Band 26 : 23.17 dBm LTE Band 66 : 23.25 dBm;
Antenna Gain	<Ant. 0> LTE Band 2 : 2.9 dBi LTE Band 4 : 0.5 dBi LTE Band 5 : -2.2 dBi LTE Band 25 : 2.9 dBi LTE Band 26 : -2.2 dBi LTE Band 66 : 0.5 dBi <Ant. 1> LTE Band 2 : 1.52 dBi LTE Band 4 : 0.32 dBi LTE Band 5 : -3.25 dBi LTE Band 25 : 1.52 dBi LTE Band 26 : -3.25 dBi LTE Band 66 : 0.32 dBi
Type of Modulation	QPSK / 16QAM / 64QAM / 256QAM (Downlink only)

Remark:



The maximum ERP/EIRP is calculated from max output power and max antenna gain, so only the maximum ERP/EIRP of Antenna 0 for LTE Band2/5/5B/25/26/66B/66C and Antenna 1 for LTE Band 4/66 are shown in the report.

1.5 Modification of EUT

No modifications are made to the EUT during all test items.

1.6 Maximum ERP/EIRP Power and Emission Designator

LTE Band 2		QPSK		16QAM/64QAM	
BW (MHz)	Frequency Range (MHz)	Maximum EIRP(W)	Emission Designator (99%OBW)	Maximum EIRP(W)	Emission Designator (99%OBW)
20	1860.0 ~ 1900.0	0.3565	17M9G7D	0.2931	17M8W7D
LTE Band 25		QPSK		16QAM/64QAM	
BW (MHz)	Frequency Range (MHz)	Maximum EIRP(W)	Emission Designator (99%OBW)	Maximum EIRP(W)	Emission Designator (99%OBW)
20	1860.0 ~ 1905.0	0.3606	17M9G7D	0.3006	17M8W7D
LTE Band 4		QPSK		16QAM/64QAM	
BW (MHz)	Frequency Range (MHz)	Maximum EIRP(W)	Emission Designator (99%OBW)	Maximum EIRP(W)	Emission Designator (99%OBW)
20	1720.0 ~ 1745.0	0.2254	17M7G7D	0.1816	17M9W7D
LTE Band 5		QPSK		16QAM/64QAM	
BW (MHz)	Frequency Range (MHz)	Maximum ERP(W)	Emission Designator (99%OBW)	Maximum ERP(W)	Emission Designator (99%OBW)
10	829.0 ~ 844.0	0.0705	8M99G7D	0.0581	9M05W7D
LTE Band 26		QPSK		16QAM/64QAM	
BW (MHz)	Frequency Range (MHz)	Maximum ERP(W)	Emission Designator (99%OBW)	Maximum ERP(W)	Emission Designator (99%OBW)
15	831.5 ~ 841.5	0.0714	13M5G7D	0.0590	13M5W7D
CH26765	821.5	0.0708	13M5G7D	0.0586	13M5W7D
LTE Band 66		QPSK		16QAM/64QAM	
BW (MHz)	Frequency Range (MHz)	Maximum EIRP(W)	Emission Designator (99%OBW)	Maximum EIRP(W)	Emission Designator (99%OBW)
20	1720.0 ~ 1770.0	0.2275	17M7G7D	0.1820	17M9W7D



LTE Band CA_5B	QPSK		16QAM/64QAM	
BW (MHz)	Maximum ERP(W)	Emission Designator (99%OBW)	Maximum ERP(W)	Emission Designator (99%OBW)
10MHz+10MHz	0.0689	18M7G7D	0.0535	18M7W7D
LTE Band CA_66B	QPSK		16QAM/64QAM	
BW (MHz)	Maximum EIRP(W)	Emission Designator (99%OBW)	Maximum EIRP(W)	Emission Designator (99%OBW)
10MHz+10MHz	0.1968	18M8G7D	0.1542	18M7W7D
LTE Band CA_66C	QPSK		16QAM/64QAM	
BW (MHz)	Maximum EIRP(W)	Emission Designator (99%OBW)	Maximum EIRP(W)	Emission Designator (99%OBW)
20MHz+20MHz	0.2046	37M7G7D	0.1633	37M7W7D

Note:

1. LTE Band 26 overlaps the entire frequency range of LTE Band 5. Therefore, the test results provided in this report covers Band 5 and the portion of Band 26 subject to Part 22.
2. LTE Band 66 overlaps the entire frequency range of LTE Band 4. Therefore, the test results provided in this report covers Band 66 as well as Band 4.
3. LTE Band 25 overlaps the entire frequency range of LTE Band 2. Therefore, the test results provided in this report covers Band 25 as well as Band 2.

1.7 Testing Location

Sporton International Inc. (Kunshan) is accredited to ISO/IEC 17025:2017 by American Association for Laboratory Accreditation with Certificate Number 5145.02.

Test Firm	Sporton International Inc. (Kunshan)		
Test Site Location	No. 1098, Pengxi North Road, Kunshan Economic Development Zone Jiangsu Province 215300 People's Republic of China TEL : +86-512-57900158 FAX : +86-512-57900958		
Test Site No.	Sporton Site No.	FCC Designation No.	FCC Test Firm Registration No.
	03CH04-KS 03CH05-KS TH01-KS	CN1257	314309



1.8 Test Software

Item	Site	Manufacture	Name	Version
1.	03CH04-KS	AUDIX	E3	6.2009-8-24a
2.	03CH05-KS	AUDIX	E3	6.2009-8-24al

1.9 Applicable Standards

According to the specifications of the manufacturer, the EUT must comply with the requirements of the following standards:

- ♦ 47 CFR Part 2, 22(H), 24(E), 27(L)
- ♦ ANSI C63.26-2015
- ♦ FCC KDB 971168 D01 Power Meas License Digital Systems v03r01
- ♦ FCC KDB 412172 D01 Determining ERP and EIRP v01r01

Remark:

1. All test items were verified and recorded according to the standards and without any deviation during the test.
2. This EUT has also been tested and complied with the requirements of FCC Part 15, Subpart B, recorded in a separate test report.

1.10 Specification of Accessory

Specification of Accessory				
AC Adapter 1	Brand Name	Motorola(Salcomp)	Model Name	MC-101
AC Adapter 2	Brand Name	Motorola(AOHAI)	Model Name	MC-101
AC Adapter 3	Brand Name	Motorola(Chenyang)	Model Name	MC-101
Battery 1	Brand Name	Motorola(SCUD)	Model Name	JK50
Battery 2	Brand Name	Motorola(ATL)	Model Name	JK50
USB Cable 1	Brand Name	Motorola(Saibao)	Model Name	SC18D22297
USB Cable 2	Brand Name	Motorola(Cabletech)	Model Name	SC18D22298
USB Cable 3	Brand Name	Motorola(Luxshare)	Model Name	SC18D22299



2 Test Configuration of Equipment Under Test

2.1 Test Mode

Antenna port conducted and radiated test items listed below are performed according to KDB 971168 D01 Power Meas License Digital Systems v03r01 with maximum output power.

Radiated measurements are performed by rotating the EUT in three different orthogonal test planes to find the maximum emission(Y plane).

Test Items	Band	Bandwidth (MHz)						Modulation			RB #			Test Channel			
		1.4	3	5	10	15	20	QPSK	16QAM	64QAM	1	Half	Full	L	M	H	
Max. Output Power	2	v	v	v	v	v	v	v	v	v	v	v	v	v	v	v	
	4	v	v	v	v	v	v	v	v	v	v	v	v	v	v	v	
	5	v	v	v	v	-	-	v	v	v	v	v	v	v	v	v	
	25	v	v	v	v	v	v	v	v	v	v	v	v	v	v	v	
	26	v	v	v	v	v	-	v	v	v	v	v	v	v	v	v	
	66	v	v	v	v	v	v	v	v	v	v	v	v	v	v	v	
Peak-to-Average Ratio	25						v	v	v	v	v		v		v		
	26				v		-	v	v	v	v		v		v		
	66						v	v	v	v	v		v		v		
26dB and 99% Bandwidth	25						v	v	v	v			v		v		
	26					v	-	v	v	v			v		v		
	66						v	v	v	v			v		v		
Conducted Band Edge	25	v	v	v	v	v	v	v	v	v	v		v	v		v	
	26	v	v	v	v	v	-	v	v	v	v		v	v		v	
	66	v	v	v	v	v	v	v	v	v	v		v	v		v	
Conducted Spurious Emission	25	v	v	v	v	v	v	v				v			v	v	v
	26	v	v	v	v	v	-	v				v			v	v	v
	66	v	v	v	v	v	v	v				v			v	v	v
Frequency Stability	25				v			v						v		v	
	26				v		-	v						v		v	
	66				v			v						v		v	



Test Items	Band	Bandwidth (MHz)						Modulation			RB #			Test Channel		
		1.4	3	5	10	15	20	QPSK	16QAM	64QAM	1	Half	Full	L	M	H
E.R.P / E.I.R.P	2	v	v	v	v	v	v	v	v	v	v			v	v	v
	4	v	v	v	v	v	v	v	v	v	v			v	v	v
	5	v	v	v	v	-	-	v	v	v	v			v	v	v
	25	v	v	v	v	v	v	v	v	v	v			v	v	v
	26	v	v	v	v	v	-	v	v	v	v			v	v	v
	66	v	v	v	v	v	v	v	v	v	v			v	v	v
Radiated Spurious Emission	25	Worst Case												v		
	26	Worst Case												v		
	66	Worst Case												v		
Note	<ol style="list-style-type: none"> The mark "v " means that this configuration is chosen for testing The mark "- " means that this bandwidth is not supported. The device is investigated from 30MHz to 10 times of fundamental signal for radiated spurious emission test under different RB size/offset and modulations in exploratory test. Subsequently, only the worst case emissions are reported. LTE Band 26 overlaps the entire frequency range of LTE Band 5. Therefore, the test results provided in this report covers Band 5 and the portion of Band 26 subject to Part 22. LTE Band 66 overlaps the entire frequency range of LTE Band 4. Therefore, the test results provided in this report covers Band 66 as well as Band 4. LTE Band 25 overlaps the entire frequency range of LTE Band 2. Therefore, the test results provided in this report covers Band 25 as well as Band 2. 															



Test Items	Band	Bandwidth (MHz)								Modulation				RB #			Test Channel				
		10+10	15+5	5+15	10+5	5+10	5+5	5+3	3+5	QPSK	16QAM	64QAM		1	Half	Full	L	M	H		
Max. Output Power	5B_CA	v	-	-	v	v	-	v	v	v	v	v	v		v			v	v	v	
	66B_CA	v	v	v	v	v	v	-	-	v	v	v		v			v	v	v		
26dB and 99% Bandwidth	5B_CA	v	-	-			-			v	v						v		v		
	66B_CA	v						-	-	v	v						v		v		
Conducted Band Edge	5B_CA	v	-	-	v	v	-	v	v	v	v	v			v		v		v		
	66B_CA	v	v	v	v	v	v	-	-	v	v	v			v		v		v		
Conducted Spurious Emission	5B_CA	v	-	-	v	v	-	v	v	v					v			v	v	v	
	66B_CA	v	v	v	v	v	v	-	-	v					v			v	v	v	
E.I.R.P.	5B_CA	v	-	-	v	v	-	v	v	v	v	v			v			v	v	v	
	66B_CA	v	v	v	v	v	v	-	-	v	v	v			v			v	v	v	
Radiated Spurious Emission	5B_CA	Worst Case																			v
	66B_CA	Worst Case																			v
Note	<ol style="list-style-type: none"> The mark "v" means that this configuration is chosen for testing The mark "-" means that this bandwidth is not supported. The device is investigated from 30MHz to 10 times of fundamental signal for radiated spurious emission test under different RB size/offset and modulations in exploratory test. Subsequently, only the worst case emissions are reported. All test items are based on engineering evaluation. 																				

Test Items	Band	Bandwidth (MHz)										Modulation				RB #			Test Channel			
		20+20	20+15	20+10	20+5	15+20	15+15	15+10	10+20	10+15	5+20	QPSK	16QAM	64QAM		1	Half	Full	L	M	H	
Max. Output Power	66C_CA	v	v	v	v	v	v	v	v	v	v	v	v	v		v			v	v	v	
26dB and 99% Bandwidth	66C_CA	v													v	v					v	
Conducted Band Edge	66C_CA	v	v	v	v	v	v	v	v	v	v	v	v			v		v	v		v	
Conducted Spurious Emission	66C_CA	v	v	v	v	v	v	v	v	v	v	v					v			v	v	v
E.I.R.P.	66C_CA	v	v	v	v	v	v	v	v	v	v	v	v	v		v			v	v	v	
Radiated Spurious Emission	66C_CA	Worst Case																			v	
Note	<ol style="list-style-type: none"> The mark "v" means that this configuration is chosen for testing The device is investigated from 30MHz to 10 times of fundamental signal for radiated spurious emission test under different RB size/offset and modulations in exploratory test. Subsequently, only the worst case emissions are reported. All test items are based on engineering evaluation. 																					

2.2 Connection Diagram of Test System

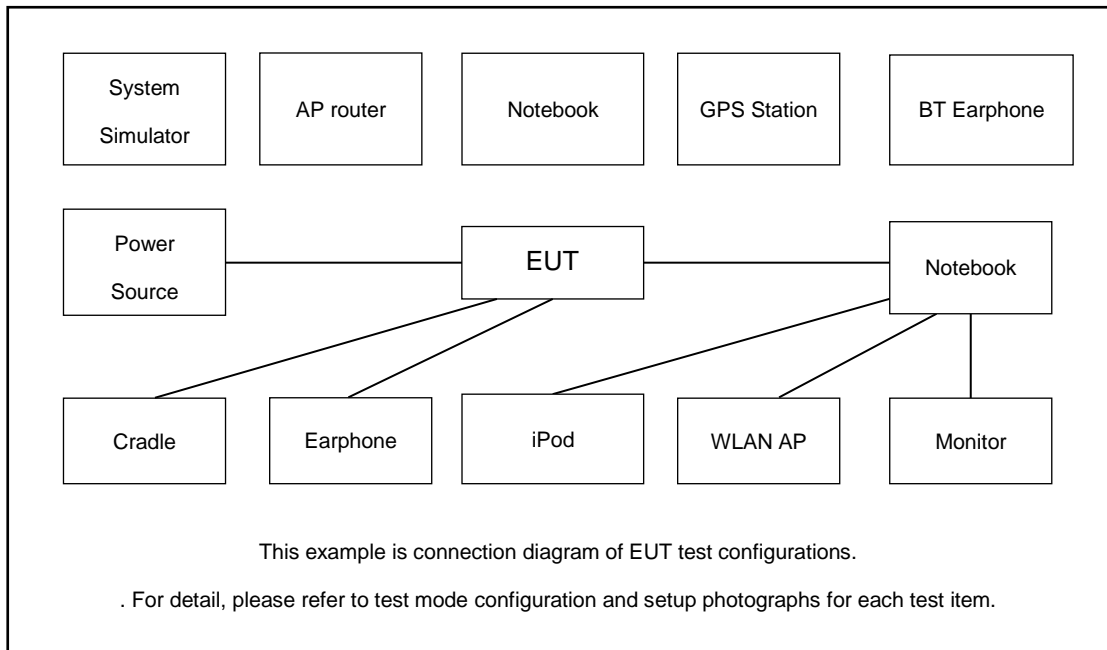

2.3 Support Unit used in test configuration and system

Item	Equipment	Trade Name	Model No.	FCC ID	Data Cable	Power Cord
1.	Power Supply	GWINSTEK	PSS-2002	N/A	N/A	Unshielded, 1.8 m
2.	LTE Base Station	Anritsu	MT8820C	N/A	N/A	Unshielded, 1.8 m
3.	Earphone	N/A	N/A	N/A	N/A	N/A

2.4 Measurement Results Explanation Example

For all conducted test items:

The offset level is set in the spectrum analyzer to compensate the RF cable loss between EUT conducted output port and spectrum analyzer. With the offset compensation, the spectrum analyzer reading level is exactly the EUT RF output level.

The spectrum analyzer offset is derived from RF cable loss.

$Offset = RF\ cable\ loss.$

Following shows an offset computation example with cable loss 5.5 dB.

Example :

$Offset(dB) = RF\ cable\ loss(dB).$
 $=5.5\ (dB)$



2.5 Frequency List of Low/Middle/High Channels

LTE Band 2 Channel and Frequency List				
BW [MHz]	Channel/Frequency(MHz)	Lowest	Middle	Highest
20	Channel	18700	18900	19100
	Frequency	1860	1880	1900
15	Channel	18675	18900	19125
	Frequency	1857.5	1880	1902.5
10	Channel	18650	18900	19150
	Frequency	1855	1880	1905
5	Channel	18625	18900	19175
	Frequency	1852.5	1880	1907.5
3	Channel	18615	18900	19185
	Frequency	1851.5	1880	1908.5
1.4	Channel	18607	18900	19193
	Frequency	1850.7	1880	1909.3

LTE Band 4 Channel and Frequency List				
BW [MHz]	Channel/Frequency(MHz)	Lowest	Middle	Highest
20	Channel	20050	20175	20300
	Frequency	1720	1732.5	1745
15	Channel	20025	20175	20325
	Frequency	1717.5	1732.5	1747.5
10	Channel	20000	20175	20350
	Frequency	1715	1732.5	1750
5	Channel	19975	20175	20375
	Frequency	1712.5	1732.5	1752.5
3	Channel	19965	20175	20385
	Frequency	1711.5	1732.5	1753.5
1.4	Channel	19957	20175	20393
	Frequency	1710.7	1732.5	1754.3



LTE Band 5 Channel and Frequency List				
BW [MHz]	Channel/Frequency(MHz)	Lowest	Middle	Highest
10	Channel	20450	20525	20600
	Frequency	829	836.5	844
5	Channel	20425	20525	20625
	Frequency	826.5	836.5	846.5
3	Channel	20415	20525	20635
	Frequency	825.5	836.5	847.5
1.4	Channel	20407	20525	20643
	Frequency	824.7	836.5	848.3

LTE Band 25 Channel and Frequency List				
BW [MHz]	Channel/Frequency(MHz)	Lowest	Middle	Highest
20	Channel	26140	26340	26590
	Frequency	1860	1880	1905
15	Channel	26115	26340	26615
	Frequency	1857.5	1880	1907.5
10	Channel	26090	26340	26640
	Frequency	1855	1880	1910
5	Channel	26065	26340	26665
	Frequency	1852.5	1880	1912.5
3	Channel	26055	26340	26675
	Frequency	1851.5	1880	1913.5
1.4	Channel	26047	26340	26683
	Frequency	1850.7	1880	1914.3



LTE Band 26 Channel and Frequency List				
BW [MHz]	Channel/Frequency(MHz)	Lowest	Middle	Highest
15	Channel	26865	26915	26965
	Frequency	831.5	836.5	841.5
10	Channel	26840	26915	26990
	Frequency	829	836.5	844
5	Channel	26815	26915	27015
	Frequency	826.5	836.5	846.5
3	Channel	26805	26915	27025
	Frequency	825.5	836.5	847.5
1.4	Channel	26797	26915	27033
	Frequency	824.7	836.5	848.3

LTE Band 66 Channel and Frequency List				
BW [MHz]	Channel/Frequency(MHz)	Lowest	Middle	Highest
20	Channel	132072	132322	132572
	Frequency	1720	1745	1770
15	Channel	132047	132322	132597
	Frequency	1717.5	1745	1772.5
10	Channel	132022	132322	132622
	Frequency	1715	1745	1775
5	Channel	131997	132322	132647
	Frequency	1712.5	1745	1777.5
3	Channel	131987	132322	132657
	Frequency	1711.5	1745	1778.5
1.4	Channel	131979	132322	132665
	Frequency	1710.7	1745	1779.3



LTE Band 5B_CA Channel and Frequency List					
BW [MHz]	Channel/Frequency(MHz)		Lowest	Middle	Highest
3 + 5	PCC	Channel	20416	20501	20586
		Frequency	825.6	834.1	842.6
	SCC	Channel	20455	20540	20625
		Frequency	829.5	838.0	846.5
5 + 3	PCC	Channel	20425	20510	20595
		Frequency	826.5	835.0	843.5
	SCC	Channel	20464	20549	20634
		Frequency	830.4	838.9	847.4
5 + 10	PCC	Channel	20428	20478	20528
		Frequency	826.8	831.8	836.8
	SCC	Channel	20500	20550	20600
		Frequency	834	839	844
10 + 5	PCC	Channel	20450	20500	20550
		Frequency	829	834	839
	SCC	Channel	20522	20572	20622
		Frequency	836.2	841.2	846.2
10 + 10	PCC	Channel	20450	20476	20501
		Frequency	829	831.6	834.1
	SCC	Channel	20549	20575	20600
		Frequency	838.9	841.5	844



LTE Band 66C_CA Channel and Frequency List					
BW [MHz]	Channel/Frequency(MHz)		Lowest	Middle	Highest
10 + 15	PCC	Channel	132025	132351	132477
		Frequency	1715.3	1747.9	1760.5
	SCC	Channel	132145	132471	132597
		Frequency	1727.3	1759.9	1772.5
15 + 10	PCC	Channel	132047	132373	132499
		Frequency	1717.5	1750.1	1762.7
	SCC	Channel	132167	132493	132619
		Frequency	1729.5	1762.1	1774.7
10 + 20	PCC	Channel	132027	132328	132428
		Frequency	1715.5	1745.6	1755.6
	SCC	Channel	132171	132472	132572
		Frequency	1729.9	1760	1770
20 + 10	PCC	Channel	132072	132373	132473
		Frequency	1720	1750.1	1760.1
	SCC	Channel	132216	132517	132617
		Frequency	1734.4	1764.5	1774.5
15 + 15	PCC	Channel	132047	132347	132447
		Frequency	1717.5	1747.5	1757.5
	SCC	Channel	132197	132497	132597
		Frequency	1732.5	1762.5	1772.5
15 + 20	PCC	Channel	132050	132325	132401
		Frequency	1717.8	1745.3	1752.9
	SCC	Channel	132221	132496	132572
		Frequency	1734.9	1762.4	1770
20 + 15	PCC	Channel	132072	132348	132423
		Frequency	1720	1747.6	1755.1
	SCC	Channel	132243	132519	132594
		Frequency	1737.1	1764.7	1772.2
20 + 5	PCC	Channel	132072	132397	132522
		Frequency	1720	1752.5	1765
	SCC	Channel	132189	132514	132639
		Frequency	1731.7	1764.2	1776.7
5 + 20	PCC	Channel	132005	132330	132455



	SCC	Frequency	1713.3	1745.8	1758.3
		Channel	132122	132447	132572
20 + 20	PCC	Frequency	1725	1757.5	1770
		Channel	132072	132323	132374
	SCC	Frequency	1720	1745.1	1750.2
		Channel	132270	132521	132572
	SCC	Frequency	1739.8	1764.9	1770
		Channel			

LTE Band 66B_CA Channel and Frequency List					
BW [MHz]	Channel/Frequency(MHz)		Lowest	Middle	Highest
5 + 5	PCC	Channel	131997	132398	132599
		Frequency	1712.5	1752.6	1772.7
	SCC	Channel	132045	132446	132647
		Frequency	1717.3	1757.4	1777.5
5 + 10	PCC	Channel	132000	132375	132550
		Frequency	1712.8	1750.3	1767.8
	SCC	Channel	132072	132447	132622
		Frequency	1720	1757.5	1775
10 + 5	PCC	Channel	132022	132397	132572
		Frequency	1715	1752.5	1770
	SCC	Channel	132094	132469	132644
		Frequency	1722.2	1759.7	1777.2
5 + 15	PCC	Channel	132002	132353	132504
		Frequency	1713	1748.1	1763.2
	SCC	Channel	132095	132446	132597
		Frequency	1722.3	1757.4	1772.5
15 + 5	PCC	Channel	132047	132398	132549
		Frequency	1717.5	1752.6	1767.7
	SCC	Channel	132140	132491	132642
		Frequency	1726.8	1761.9	1777
10 + 10	PCC	Channel	132022	132373	132523
		Frequency	1715	1750.1	1765.1
	SCC	Channel	132121	132472	132622
		Frequency	1724.9	1760	1775

3 Conducted Test Items

3.1 Measuring Instruments

See list of measuring instruments of this test report.

3.2 Test Setup

3.2.1 Conducted Output Power



3.2.2 Peak-to-Average Ratio, Occupied Bandwidth ,Conducted Band-Edge and Conducted Spurious Emission

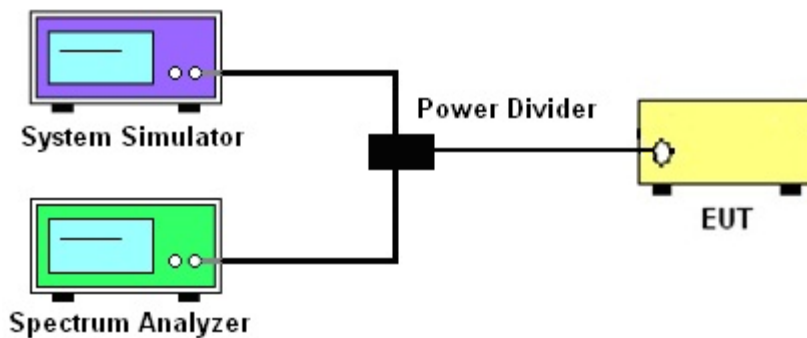

3.2.3 Frequency Stability

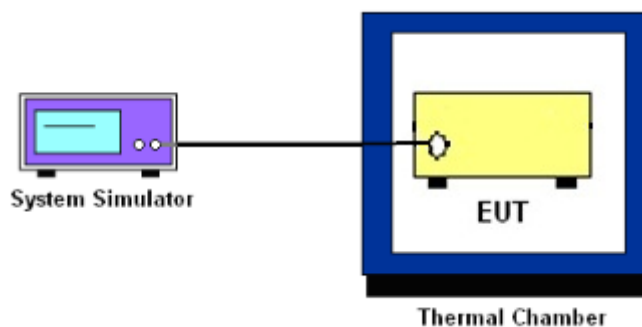

3.3 Test Result of Conducted Test

Please refer to Appendix A.



3.4 Conducted Output Power and ERP/EIRP

3.4.1 Description of the Conducted Output Power Measurement and ERP/EIRP Measurement

A system simulator was used to establish communication with the EUT. Its parameters were set to force the EUT transmitting at maximum output power. The measured power in the radio frequency on the transmitter output terminals shall be reported.

The ERP of mobile transmitters must not exceed 7 Watts for LTE Band 5 and Band 26.

The EIRP of mobile transmitters must not exceed 2 Watts for LTE Band 2 and Band 25.

The EIRP of mobile transmitters must not exceed 1 Watts for LTE Band 4 and Band 66.

According to KDB 412172 D01 Power Approach,

$EIRP = P_T + G_T - L_C$, $ERP = EIRP - 2.15$, where

P_T = transmitter output power in dBm

G_T = gain of the transmitting antenna in dBi

L_C = signal attenuation in the connecting cable between the transmitter and antenna in dB

3.4.2 Test Procedures

1. The testing follows ANSI C63.26 Section 5.2
2. The transmitter output port was connected to the system simulator.
3. Set EUT at maximum power through the system simulator.
4. Select lowest, middle, and highest channels for each band and different modulation.
5. Measure and record the power level from the system simulator.



3.5 Peak-to-Average Ratio

3.5.1 Description of the PAR Measurement

Power Complementary Cumulative Distribution Function (CCDF) curves provide a means for characterizing the power peaks of a digitally modulated signal on a statistical basis. A CCDF curve depicts the probability of the peak signal amplitude exceeding the average power level. Most contemporary measurement instrumentation include the capability to produce CCDF curves for an input signal provided that the instrument's resolution bandwidth can be set wide enough to accommodate the entire input signal bandwidth. In measuring transmissions in this band using an average power technique, the peak-to-average ratio (PAR) of the transmission may not exceed 13 dB.

3.5.2 Test Procedures

1. The testing follows ANSI C63.26 Section 5.2.3.4 (CCDF).
2. The EUT was connected to spectrum and system simulator via a power divider.
3. Set the CCDF (Complementary Cumulative Distribution Function) option in spectrum analyzer.
4. The highest RF powers were measured and recorded the maximum PAPR level associated with a probability of 0.1 %.
5. Record the deviation as Peak to Average Ratio.



3.6 Occupied Bandwidth

3.6.1 Description of Occupied Bandwidth Measurement

The occupied bandwidth is the width of a frequency band such that, below the lower and above the upper frequency limits, the mean powers emitted are each equal to a specified percentage 0.5% of the total mean transmitted power.

The 26 dB emission bandwidth is defined as the frequency range between two points, one above and one below the carrier frequency, at which the spectral density of the emission is attenuated 26 dB below the maximum in-band spectral density of the modulated signal. Spectral density (power per unit bandwidth) is to be measured with a detector of resolution bandwidth equal to approximately 1.0% of the emission bandwidth.

3.6.2 Test Procedures

1. The testing follows ANSI C63.26 Section 5.4
2. The EUT was connected to spectrum analyzer and system simulator via a power divider.
3. The spectrum analyzer center frequency is set to the nominal EUT channel center frequency. The span range for the spectrum analyzer shall be between two and five times the anticipated OBW.
4. The nominal resolution bandwidth (RBW) shall be in the range of 1 to 5 % of the anticipated OBW, and the VBW shall be at least 3 times the RBW.
5. Set the detection mode to peak, and the trace mode to max hold.
6. Determine the reference value: Set the EUT to transmit a modulated signal. Allow the trace to stabilize. Set the spectrum analyzer marker to the highest level of the displayed trace.
(this is the reference value)
7. Determine the “-26 dB down amplitude” as equal to (Reference Value – X).
8. Place two markers, one at the lowest and the other at the highest frequency of the envelope of the spectral display such that each marker is at or slightly below the “-X dB down amplitude” determined in step 6. If a marker is below this “-X dB down amplitude” value it shall be placed as close as possible to this value. The OBW is the positive frequency difference between the two markers.
9. Use the 99 % power bandwidth function of the spectrum analyzer and report the measured bandwidth.



3.7 Conducted Band Edge

3.7.1 Description of Conducted Band Edge Measurement

22.917(a)

For operations in the 824 – 849 MHz band, the FCC limit is $43 + 10\log_{10}(P[\text{Watts}])$ dB below the transmitter power $P(\text{Watts})$ in a 100kHz bandwidth. However, in the 1MHz bands immediately outside and adjacent to the licensee's frequency block, a resolution bandwidth of at least one percent of the emission bandwidth of the fundamental emission of the transmitter may be employed.

24.238 (a)

For operations in the 1850-1910 and 1930-1990 MHz band, the FCC limit is $43 + 10\log_{10}(P[\text{Watts}])$ dB below the transmitter power $P(\text{Watts})$ in a 1MHz bandwidth. However, in the 1 MHz bands immediately outside and adjacent to the frequency block a resolution bandwidth of at least one percent of the emission bandwidth of the fundamental emission of the transmitter may be employed.

27.53 (h)

For operations in the 1710 – 1755 MHz band, the FCC limit is $43 + 10\log_{10}(P[\text{Watts}])$ dB below the transmitter power $P(\text{Watts})$ in a 1 MHz bandwidth. However, in the 1MHz bands immediately outside and adjacent to the licensee's frequency block, a resolution bandwidth of at least one percent of the emission bandwidth of the fundamental emission of the transmitter may be employed.



3.7.2 Test Procedures

1. The testing follows ANSI C63.26 section 5.7
2. The EUT was connected to spectrum analyzer and system simulator via a power divider.
3. The band edges of low and high channels for the highest RF powers were measured.
4. Set RBW \geq 1% EBW in the 1MHz band immediately outside and adjacent to the band edge.
5. Beyond the 1 MHz band from the band edge, RBW=1MHz was used or a narrower RBW was used and the measured power was integrated over the full required measurement bandwidth of 1 MHz.
6. Set spectrum analyzer with RMS detector.
7. The RF fundamental frequency should be excluded against the limit line in the operating frequency band.
8. Checked that all the results comply with the emission limit line.

Example:

The limit line is derived from $43 + 10\log(P)$ dB below the transmitter power P(Watts)

$$= P(W) - [43 + 10\log(P)] \text{ (dB)}$$

$$= [30 + 10\log(P)] \text{ (dBm)} - [43 + 10\log(P)] \text{ (dB)} = -13\text{dBm}.$$

9. When using the integration method, the starting frequency of the integration shall be centered at one-half of the RBW away from the band edge.



3.8 Conducted Spurious Emission

3.8.1 Description of Conducted Spurious Emission Measurement

The power of any emission outside of the authorized operating frequency ranges must be lower than the transmitter power (P) by a factor of at least $43 + 10 \log (P)$ dB.

It is measured by means of a calibrated spectrum analyzer and scanned from 30 MHz up to a frequency including its 10th harmonic.

3.8.2 Test Procedures

1. The testing follows ANSI C63.26 section 5.7
2. The EUT was connected to spectrum analyzer and system simulator via a power divider.
3. The RF output of EUT was connected to the spectrum analyzer by RF cable and attenuator. The path loss was compensated to the results for each measurement.
4. The middle channel for the highest RF power within the transmitting frequency was measured.
5. The conducted spurious emission for the whole frequency range was taken.
6. Make the measurement with the spectrum analyzer's RBW = 1MHz, VBW = 3MHz.
7. Set spectrum analyzer with RMS detector.
8. Taking the record of maximum spurious emission.
9. The RF fundamental frequency should be excluded against the limit line in the operating frequency band.
10. The limit line is derived from $43 + 10\log(P)$ dB below the transmitter power P(Watts)
= P(W)- [43 + 10log(P)] (dB)
= [30 + 10log(P)] (dBm) - [43 + 10log(P)] (dB)
= -13dBm.



3.9 Frequency Stability

3.9.1 Description of Frequency Stability Measurement

The frequency stability shall be measured by variation of ambient temperature and variation of primary supply voltage to ensure that the fundamental emission stays within the authorized frequency block. The frequency stability of the transmitter shall be maintained within $\pm 0.00025\%$ ($\pm 2.5\text{ppm}$) of the center frequency.

3.9.2 Test Procedures for Temperature Variation

1. The testing follows ANSI C63.26 section 5.6.4
2. The EUT was set up in the thermal chamber and connected with the system simulator.
3. With power OFF, the temperature was decreased to -30°C and the EUT was stabilized before testing. Power was applied and the maximum change in frequency was recorded within one minute.
4. With power OFF, the temperature was raised in 10°C step up to 50°C . The EUT was stabilized at each step for at least half an hour. Power was applied and the maximum frequency change was recorded within one minute.

3.9.3 Test Procedures for Voltage Variation

1. The testing follows ANSI C63.26 section 5.6.5
2. The EUT was placed in a temperature chamber at $20\pm 5^{\circ}\text{C}$ and connected with the system simulator.
3. The power supply voltage to the EUT was varied from 85% to 115% of the nominal value for other than hand carried battery equipment.
4. For hand carried, battery powered equipment, reduce the primary ac or dc supply voltage to the battery operating end point, which shall be specified by the manufacturer.
5. The variation in frequency was measured for the worst case.

4 Radiated Test Items

4.1 Measuring Instruments

See list of measuring instruments of this test report.

4.2 Test Setup

4.2.1 For radiated test below 30MHz

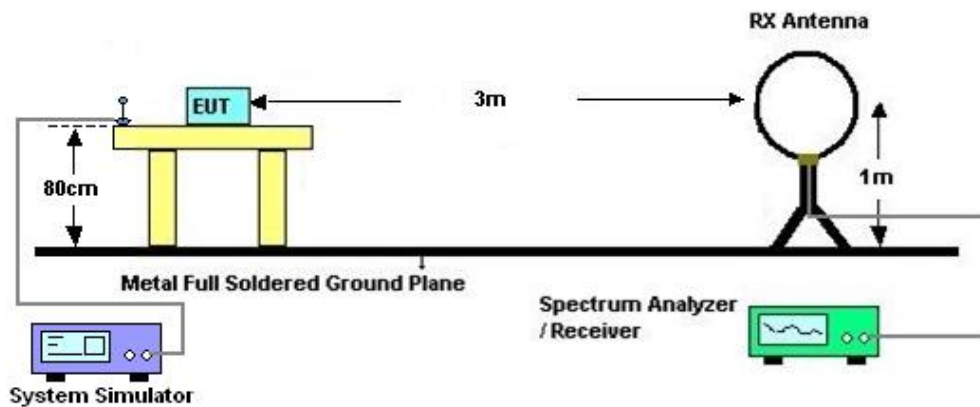

4.2.2 For radiated test from 30MHz to 1GHz

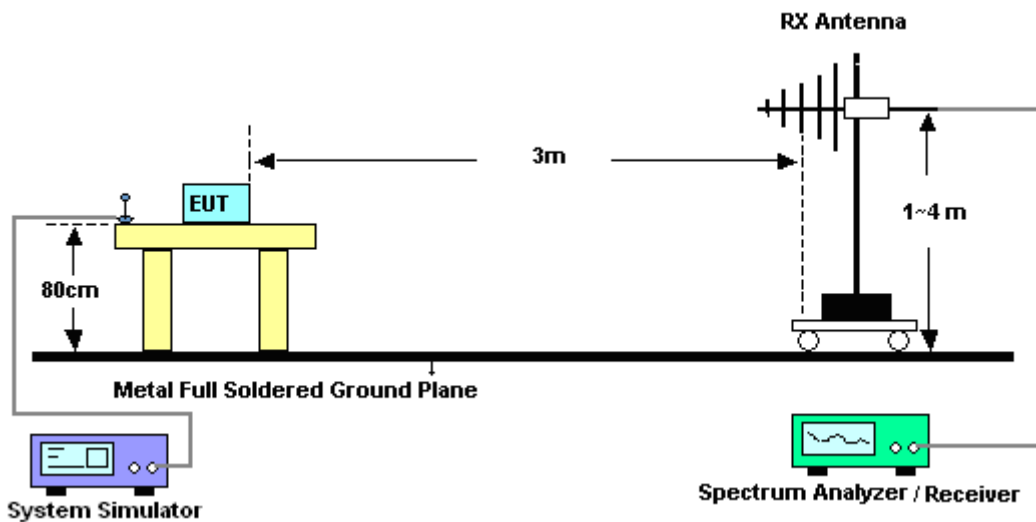

4.2.3 For radiated test above 1GHz

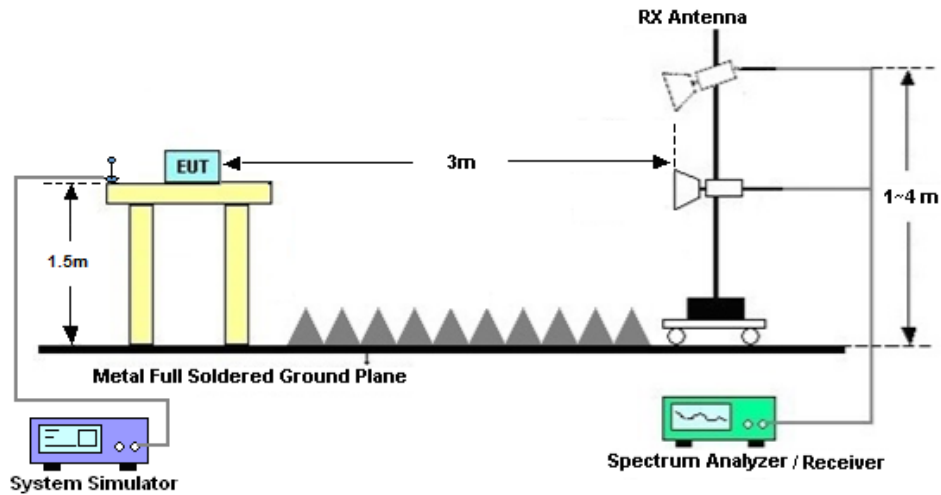

4.3 Test Result of Radiated Test

The low frequency, which started from 9 kHz to 30MHz, was pre-scanned and the result which was 20dB lower than the limit line was not reported.

Please refer to Appendix B.



4.4 Radiated Spurious Emission

4.4.1 Description of Radiated Spurious Emission

The radiated spurious emission was measured by substitution method according to ANSI C63.26. The power of any emission outside of the authorized operating frequency ranges must be attenuated below the transmitter power (P) by a factor of at least $43 + 10 \log (P)$ dB.

The spectrum is scanned from 30 MHz up to a frequency including its 10th harmonic.

4.4.2 Test Procedures

1. The testing follows ANSI C63.26 Section 5.5
2. The EUT was placed on a turntable with 0.8 meter height for frequency below 1GHz and 1.5 meter height for frequency above 1GHz respectively above ground.
3. The EUT was set 3 meters from the receiving antenna mounted on the antenna tower.
4. The table was rotated 360 degrees to determine the position of the highest spurious emission.
5. The height of the receiving antenna is varied between 1m to 4m to search the maximum spurious emission for both horizontal and vertical polarizations.
6. During the measurement, the system simulator parameters were set to force the EUT transmitting at maximum output power.
7. Make the measurement with the spectrum analyzer's RBW = 1MHz, VBW = 3MHz, taking the record of maximum spurious emission.
8. A horn antenna was substituted in place of the EUT and was driven by a signal generator.
9. Tune the output power of signal generator to the same emission level with EUT maximum spurious emission.
10. $EIRP (dBm) = S.G. Power - Tx Cable Loss + Tx Antenna Gain$
11. $ERP (dBm) = EIRP - 2.15$
12. The RF fundamental frequency should be excluded against the limit line in the operating frequency band.

The limit line is derived from $43 + 10\log(P)$ dB below the transmitter power P(Watts)
= $P(W) - [43 + 10\log(P)] (dB)$
= $[30 + 10\log(P)] (dBm) - [43 + 10\log(P)] (dB)$
= -13dBm.



5 List of Measuring Equipment

Instrument	Manufacturer	Model No.	Serial No.	Characteristics	Calibration Date	Test Date	Due Date	Remark
Spectrum Analyzer	R&S	FSV40	101040	10Hz~40GHz	Oct. 14, 2021	Dec. 24, 2021~ Dec. 30, 2021	Oct. 13, 2022	Conducted (TH01-KS)
Power divider	STI	STI08-0055	-	0.5~40GHz	Aug. 26, 2021	Dec. 24, 2021~ Dec. 30, 2021	Aug. 25, 2022	Conducted (TH01-KS)
Temperature & humidity chamber	Hongzhan	LP-150U	H2014011440	-40~+150°C 20%~95%RH	Jul. 12, 2021	Dec. 24, 2021~ Dec. 30, 2021	Jul. 11, 2022	Conducted (TH01-KS)
EXA Spectrum Analyzer	Keysight	N9010A	MY55150244	10Hz-44G,MAX 30dB	Apr. 13, 2021	Jan. 19, 2022	Apr. 12, 2022	Radiation (03CH04-KS)
Bilog Antenna	TeseQ	CBL6111D	49922	30MHz-1GHz	May. 30, 2021	Jan. 19, 2022	May. 29, 2022	Radiation (03CH04-KS)
Horn Antenna	Schwarzbeck	BBHA9120D	1356	1GHz~18GHz	Apr. 18, 2021	Jan. 19, 2022	Apr. 17, 2022	Radiation (03CH04-KS)
SHF-EHF Horn	Com-power	AH-840	101070	18GHz~40GHz	Jan 05, 2022	Jan. 19, 2022	Jan. 04 2023	Radiation (03CH04-KS)
Amplifier	SONOMA	310N	187289	9KHz-1GHz	Jan 05, 2022	Jan. 19, 2022	Jan. 04 2023	Radiation (03CH04-KS)
Amplifier	MITEQ	EM18G40GG A	060728	18~40GHz	Jan 05, 2022	Jan. 19, 2022	Jan. 04 2023	Radiation (03CH04-KS)
high gain Amplifier	MITEQ	AMF-7D-0010 1800-30-10P	2025788	1Ghz-18Ghz	Jul. 30, 2021	Jan. 19, 2022	Jul. 29, 2022	Radiation (03CH04-KS)
Amplifier	Keysight	83017A	MY57280106	500MHz~26.5GHz	Oct. 13, 2021	Jan. 19, 2022	Oct. 12, 2022	Radiation (03CH04-KS)
AC Power Source	Chroma	61601	F104090004	N/A	NCR	Jan. 19, 2022	NCR	Radiation (03CH04-KS)
Turn Table	ChamPro	EM 1000-T	060762-T	0~360 degree	NCR	Jan. 19, 2022	NCR	Radiation (03CH04-KS)
Antenna Mast	ChamPro	EM 1000-A	060762-A	1 m~4 m	NCR	Jan. 19, 2022	NCR	Radiation (03CH04-KS)
EXA Spectrum Analyzer	Keysight	N9010A	MY55150244	10Hz-44G,MAX 30dB	Apr. 13, 2021	Jan. 19, 2022	Apr. 12, 2022	Radiation (03CH05-KS)
Loop Antenna	R&S	HFH2-Z2	100321	9kHz~30MHz	Oct. 30, 2021	Jan. 19, 2022	Oct. 29, 2022	Radiation (03CH05-KS)
Bilog Antenna	TeseQ	CBL6111D	49922	30MHz-1GHz	Jun. 04 ,2021	Jan. 19, 2022	Jun. 03, 2022	Radiation (03CH05-KS)
Double Ridge Horn Antenna	ETS-Lindgren	3117	00218652	1GHz~18GHz	Apr. 24, 2021	Jan. 19, 2022	Apr. 23, 2022	Radiation (03CH05-KS)
SHF-EHF Horn	Com-power	AH-840	101070	18GHz~40GHz	Jan. 05, 2022	Jan. 19, 2022	Jan. 04, 2023	Radiation (03CH05-KS)
Amplifier	SONOMA	310N	187289	9KHz-1GHz	Apr. 12, 2021	Jan. 19, 2022	Apr. 11, 2022	Radiation (03CH05-KS)
Amplifier	MITEQ	EM18G40GG A	060728	18~40GHz	Jan. 05, 2022	Jan. 19, 2022	Jan. 04, 2023	Radiation (03CH05-KS)
high gain Amplifier	MITEQ	AMF-7D-0010 1800-30-10P	2012228	1Ghz-18Ghz	Oct. 16, 2021	Jan. 19, 2022	Oct. 15, 2022	Radiation (03CH05-KS)
Amplifier	Keysight	83017A	MY53270316	500MHz~26.5GHz	Oct. 16, 2021	Jan. 19, 2022	Oct. 15, 2022	Radiation (03CH05-KS)
AC Power Source	Chroma	61601	F104090004	N/A	NCR	Jan. 19, 2022	NCR	Radiation (03CH05-KS)
Turn Table	ChamPro	EM 1000-T	060762-T	0~360 degree	NCR	Jan. 19, 2022	NCR	Radiation (03CH05-KS)
Antenna Mast	ChamPro	EM 1000-A	060762-A	1 m~4 m	NCR	Jan. 19, 2022	NCR	Radiation (03CH05-KS)



6 Uncertainty of Evaluation

The measurement uncertainties shown below were calculated in accordance with the requirements of ANSI 63.26-2015. All the measurement uncertainty value were shown with a coverage K=2 to indicate 95% level of confidence. The measurement data show herein meets or exceeds the CISPR measurement uncertainty values specified in CISPR 16-4-2 and can be compared directly to specified limit to determine compliance.

Uncertainty of Radiated Emission Measurement (30 MHz ~ 1000 MHz) (03CH04-KS)

Measuring Uncertainty for a Level of Confidence of 95% (U = 2Uc(y))	3.3dB
---	-------

Uncertainty of Radiated Emission Measurement (1GHz ~ 40GHz) (03CH04-KS)

Measuring Uncertainty for a Level of Confidence of 95% (U = 2Uc(y))	2.8dB
---	-------

Uncertainty of Radiated Emission Measurement (30 MHz ~ 1000 MHz) (03CH05-KS)

Measuring Uncertainty for a Level of Confidence of 95% (U = 2Uc(y))	2.5dB
---	-------

Uncertainty of Radiated Emission Measurement (1GHz ~ 40GHz) (03CH05-KS)

Measuring Uncertainty for a Level of Confidence of 95% (U = 2Uc(y))	2.1dB
---	-------



Appendix A. Test Results of Conducted Test

Test Engineer :	Simle Wang	Temperature :	22~23°C
		Relative Humidity :	40~42%

Conducted Output Power(Average power)and ERP/EIRP

LTE Band 2 for Ant 0									
BW [MHz]	Modulation	RB Size	RB Offset	Power Low Ch. / Freq.	Power Middle Ch. / Freq.	Power High Ch. / Freq.	EIRP(W)		
Channel				18700	18900	19100			
Frequency (MHz)				1860	1880	1900	L	M	H
20	QPSK	1	0	22.48	22.62	22.47	0.3451	0.3565	0.3443
20	QPSK	1	99	22.34	22.51	22.39	0.3342	0.3475	0.3381
20	QPSK	100	0	21.55	21.61	21.52	0.2786	0.2825	0.2767
20	16QAM	1	0	21.64	21.77	21.64	0.2844	0.2931	0.2844
20	64QAM	1	0	20.59	20.65	20.61	0.2234	0.2265	0.2244
Channel				18675	18900	19125	EIRP(W)		
Frequency (MHz)				1857.5	1880	1902.5	L	M	H
15	QPSK	1	0	22.45	22.56	22.44	0.3428	0.3516	0.3420
15	16QAM	1	0	21.62	21.71	21.54	0.2831	0.2891	0.2780
Channel				18650	18900	19150	EIRP(W)		
Frequency (MHz)				1855	1880	1905	L	M	H
10	QPSK	1	0	22.45	22.52	22.34	0.3428	0.3483	0.3342
10	16QAM	1	0	21.54	21.75	21.52	0.2780	0.2917	0.2767
Channel				18625	18900	19175	EIRP(W)		
Frequency (MHz)				1852.5	1880	1907.5	L	M	H
5	QPSK	1	0	22.41	22.50	22.41	0.3396	0.3467	0.3396
5	16QAM	1	0	21.53	21.67	21.59	0.2773	0.2864	0.2812
Channel				18615	18900	19185	EIRP(W)		
Frequency (MHz)				1851.5	1880	1908.5	L	M	H
3	QPSK	1	0	22.34	22.52	22.42	0.3342	0.3483	0.3404
3	16QAM	1	0	21.58	21.71	21.53	0.2805	0.2891	0.2773
Channel				18607	18900	19193	EIRP(W)		
Frequency (MHz)				1850.7	1880	1909.3	L	M	H
1.4	QPSK	1	0	22.33	22.48	22.38	0.3334	0.3451	0.3373
1.4	16QAM	1	0	21.59	21.67	21.53	0.2812	0.2864	0.2773



LTE Band 4 for Ant 1									
BW [MHz]	Modulation	RB Size	RB Offset	Power Low Ch. / Freq.	Power Middle Ch. / Freq.	Power High Ch. / Freq.	EIRP(W)		
Channel				20050	20175	20300			
Frequency (MHz)				1720	1732.5	1745	L	M	H
20	QPSK	1	0	23.10	23.21	23.15	0.2198	0.2254	0.2223
20	QPSK	1	99	22.94	23.02	22.90	0.2118	0.2158	0.2099
20	QPSK	100	0	22.04	22.16	22.13	0.1722	0.1770	0.1758
20	16QAM	1	0	22.22	22.27	22.22	0.1795	0.1816	0.1795
20	64QAM	1	0	21.22	21.25	21.22	0.1426	0.1435	0.1426
Channel				20025	20175	20325	EIRP(W)		
Frequency (MHz)				1717.5	1732.5	1747.5	L	M	H
15	QPSK	1	0	22.99	23.17	23.02	0.2143	0.2234	0.2158
15	16QAM	1	0	22.13	22.14	22.19	0.1758	0.1762	0.1782
Channel				20000	20175	20350	EIRP(W)		
Frequency (MHz)				1715	1732.5	1750	L	M	H
10	QPSK	1	0	23.00	23.10	23.02	0.2148	0.2198	0.2158
10	16QAM	1	0	22.17	22.13	22.05	0.1774	0.1758	0.1726
Channel				19975	20175	20375	EIRP(W)		
Frequency (MHz)				1712.5	1732.5	1752.5	L	M	H
5	QPSK	1	0	23.00	23.09	23.09	0.2148	0.2193	0.2193
5	16QAM	1	0	22.13	22.12	22.08	0.1758	0.1754	0.1738
Channel				19965	20175	20385	EIRP(W)		
Frequency (MHz)				1711.5	1732.5	1753.5	L	M	H
3	QPSK	1	0	23.06	23.06	22.98	0.2178	0.2178	0.2138
3	16QAM	1	0	22.12	22.09	22.13	0.1754	0.1742	0.1758
Channel				19950	20175	20393	EIRP(W)		
Frequency (MHz)				1710	1732.5	1754.3	L	M	H
1.4	QPSK	1	0	22.96	23.05	23.12	0.2128	0.2173	0.2208
1.4	16QAM	1	0	22.16	22.20	22.11	0.1770	0.1786	0.1750



LTE Band 5 for Ant 0									
BW [MHz]	Modulation	RB Size	RB Offset	Power Low Ch. / Freq.	Power Middle Ch. / Freq.	Power High Ch. / Freq.	ERP(W)		
Channel				20450	20525	20600			
Frequency (MHz)				829	836.5	844	L	M	H
10	QPSK	1	0	22.79	22.83	22.69	0.0698	0.0705	0.0682
10	QPSK	1	49	22.64	22.68	22.63	0.0675	0.0681	0.0673
10	QPSK	50	0	21.69	21.78	21.62	0.0542	0.0553	0.0533
10	16QAM	1	0	21.93	21.99	21.88	0.0573	0.0581	0.0566
10	64QAM	1	0	20.81	20.93	20.83	0.0443	0.0455	0.0445
Channel				20425	20525	20625	ERP(W)		
Frequency (MHz)				826.5	836.5	846.5	L	M	H
5	QPSK	1	0	22.62	22.81	22.65	0.0671	0.0701	0.0676
5	16QAM	1	0	21.83	21.90	21.67	0.0560	0.0569	0.0540
Channel				20415	20525	20635	ERP(W)		
Frequency (MHz)				825.5	836.5	847.5	L	M	H
3	QPSK	1	0	22.76	22.74	22.61	0.0693	0.0690	0.0670
3	16QAM	1	0	21.82	21.89	21.72	0.0558	0.0568	0.0546
Channel				20407	20525	20643	ERP(W)		
Frequency (MHz)				824.7	836.5	848.3	L	M	H
1.4	QPSK	1	0	22.65	22.67	22.63	0.0676	0.0679	0.0673
1.4	16QAM	1	0	21.80	21.84	21.76	0.0556	0.0561	0.0551



LTE Band 25 for Ant 0									
BW [MHz]	Modulation	RB Size	RB Offset	Power Low Ch. / Freq.	Power Middle Ch. / Freq.	Power High Ch. / Freq.	EIRP(W)		
Channel				26140	26340	26590			
Frequency (MHz)				1860	1880	1905	L	M	H
20	QPSK	1	0	22.58	22.67	22.56	0.3532	0.3606	0.3516
20	QPSK	1	99	22.54	22.57	22.48	0.3499	0.3524	0.3451
20	QPSK	100	0	21.63	21.71	21.56	0.2838	0.2891	0.2793
20	16QAM	1	0	21.79	21.88	21.84	0.2944	0.3006	0.2979
20	64QAM	1	0	20.64	20.77	20.64	0.2259	0.2328	0.2259
Channel				26115	26340	26615	EIRP(W)		
Frequency (MHz)				1857.5	1880	1907.5	L	M	H
15	QPSK	1	0	22.55	22.62	22.44	0.3508	0.3565	0.3420
15	16QAM	1	0	21.73	21.75	21.66	0.2904	0.2917	0.2858
Channel				26090	26340	26640	EIRP(W)		
Frequency (MHz)				1855	1880	1910	L	M	H
10	QPSK	1	0	22.54	22.58	22.47	0.3499	0.3532	0.3443
10	16QAM	1	0	21.71	21.76	21.69	0.2891	0.2924	0.2877
Channel				26065	26340	26665	EIRP(W)		
Frequency (MHz)				1852.5	1880	1912.5	L	M	H
5	QPSK	1	0	22.44	22.55	22.48	0.3420	0.3508	0.3451
5	16QAM	1	0	21.72	21.82	21.69	0.2897	0.2965	0.2877
Channel				26055	26340	26675	EIRP(W)		
Frequency (MHz)				1851.5	1880	1913.5	L	M	H
3	QPSK	1	0	22.40	22.52	22.41	0.3388	0.3483	0.3396
3	16QAM	1	0	21.68	21.81	21.66	0.2871	0.2958	0.2858
Channel				26047	26340	26683	EIRP(W)		
Frequency (MHz)				1850.7	1880	1914.3	L	M	H
1.4	QPSK	1	0	22.62	22.61	22.50	0.3565	0.3556	0.3467
1.4	16QAM	1	0	21.70	21.86	21.67	0.2884	0.2992	0.2864



LTE Band 26 for Ant 0											
BW [MHz]	Modulation	RB Size	RB Offset	Power Low Ch. / Freq.	Power Low Ch. / Freq.	Power Middle Ch. / Freq.	Power High Ch. / Freq.	ERP(W)			
Channel				26765	26865	26915	26965				
Frequency (MHz)				821.5	831.5	836.5	841.5	L	M	H	
15	QPSK	1	0	22.85	22.89	22.81	22.80	0.0708	0.0714	0.0701	0.0700
15	QPSK	1	74	22.66	22.72	22.63	22.63	0.0678	0.0687	0.0673	0.0673
15	QPSK	75	0	21.82	21.88	21.82	21.78	0.0558	0.0566	0.0558	0.0553
15	16QAM	1	0	22.03	22.06	22.01	22.04	0.0586	0.0590	0.0583	0.0587
15	64QAM	1	0	20.85	20.96	20.93	20.91	0.0447	0.0458	0.0455	0.0453
Channel					26840	26915	26990	ERP(W)			
Frequency (MHz)					829	836.5	844	L	M	H	
10	QPSK	1	0	22.71	22.83	22.70		0.0685	0.0705	0.0684	
10	16QAM	1	0	21.97	21.91	21.88		0.0578	0.0570	0.0566	
Channel					26815	26915	27015	ERP(W)			
Frequency (MHz)					826.5	836.5	846.5	L	M	H	
5	QPSK	1	0	22.61	22.83	22.72		0.0670	0.0705	0.0687	
5	16QAM	1	0	21.96	21.92	21.82		0.0577	0.0571	0.0558	
Channel					26815	26915	27025	ERP(W)			
Frequency (MHz)					825.5	836.5	847.5	L	M	H	
3	QPSK	1	0	22.81	22.74	22.72		0.0701	0.0690	0.0687	
3	16QAM	1	0	21.96	22.03	21.79		0.0577	0.0586	0.0555	
Channel					26797	26915	27033	ERP(W)			
Frequency (MHz)					824.7	836.5	848.3	L	M	H	
1.4	QPSK	1	0	22.54	22.66	22.76		0.0659	0.0678	0.0693	
1.4	16QAM	1	0	21.90	21.88	21.97		0.0569	0.0566	0.0578	



LTE Band 66 for Ant 1									
BW [MHz]	Modulation	RB Size	RB Offset	Power Low Ch. / Freq.	Power Middle Ch. / Freq.	Power High Ch. / Freq.	EIRP(W)		
Channel				132072	132322	132572	EIRP(W)		
Frequency (MHz)				1720	1745	1770	L	M	H
20	QPSK	1	0	23.16	23.25	23.07	0.2228	0.2275	0.2183
20	QPSK	1	99	22.97	23.06	22.95	0.2133	0.2178	0.2123
20	QPSK	100	0	22.19	22.27	22.23	0.1782	0.1816	0.1799
20	16QAM	1	0	22.23	22.28	22.18	0.1799	0.1820	0.1778
20	64QAM	1	0	21.19	21.21	21.18	0.1416	0.1422	0.1413
Channel				132047	132322	132597	EIRP(W)		
Frequency (MHz)				1717.5	1745	1772.5	L	M	H
15	QPSK	1	0	23.05	23.18	23.00	0.2173	0.2239	0.2148
15	16QAM	1	0	22.11	22.18	22.10	0.1750	0.1778	0.1746
Channel				132022	132322	132622	EIRP(W)		
Frequency (MHz)				1715	1745	1775	L	M	H
10	QPSK	1	0	23.08	23.16	22.99	0.2188	0.2228	0.2143
10	16QAM	1	0	22.15	22.21	22.05	0.1766	0.1791	0.1726
Channel				131997	132322	132647	EIRP(W)		
Frequency (MHz)				1712.5	1745	1777.5	L	M	H
5	QPSK	1	0	23.08	23.14	22.95	0.2188	0.2218	0.2123
5	16QAM	1	0	22.10	22.17	22.06	0.1746	0.1774	0.1730
Channel				131987	132322	132657	EIRP(W)		
Frequency (MHz)				1711.5	1745	1778.5	L	M	H
3	QPSK	1	0	23.02	23.12	22.93	0.2158	0.2208	0.2113
3	16QAM	1	0	22.12	22.16	22.07	0.1754	0.1770	0.1734
Channel				131979	132322	132665	EIRP(W)		
Frequency (MHz)				1710.7	1745	1779.3	L	M	H
1.4	QPSK	1	0	23.07	23.08	22.92	0.2183	0.2188	0.2109
1.4	16QAM	1	0	22.12	22.16	22.06	0.1754	0.1770	0.1730



LTE Band 5B for Ant 0							
Combination 10MHz+10MHz (50RB+50RB)							
Channel	Modulation	PCC		SCC		Measured Power	ERP(W)
		RB Size	RB offset	RB Size	RB offset		
L	QPSK	1	Max	1	0	22.71	0.0685
M	QPSK	1	Max	1	0	22.73	0.0689
H	QPSK	1	Max	1	0	22.65	0.0676
L	16QAM	1	Max	1	0	21.59	0.0530
M	16QAM	1	Max	1	0	21.63	0.0535
H	16QAM	1	Max	1	0	21.47	0.0515
L	64QAM	1	Max	1	0	19.54	0.0330
M	64QAM	1	Max	1	0	19.69	0.0342
H	64QAM	1	Max	1	0	19.35	0.0316
Combination 10MHz+5MHz (50RB+25RB)							
Channel	Modulation	PCC		SCC		Measured Power	ERP(W)
		RB Size	RB offset	RB Size	RB offset		
M	QPSK	1	Max	1	0	22.68	0.0681
M	16QAM	1	Max	1	0	21.35	0.0501
Combination 5MHz+10MHz (25RB+50RB)							
Channel	Modulation	PCC		SCC		Measured Power	ERP(W)
		RB Size	RB offset	RB Size	RB offset		
M	QPSK	1	Max	1	0	22.43	0.0643
M	16QAM	1	Max	1	0	21.04	0.0467
Combination 5MHz+3MHz (25RB+15RB)							
Channel	Modulation	PCC		SCC		Measured Power	ERP(W)
		RB Size	RB offset	RB Size	RB offset		
M	QPSK	1	Max	1	0	22.49	0.0652
M	16QAM	1	Max	1	0	21.13	0.0476
Combination 3MHz+5MHz (15RB+25RB)							
Channel	Modulation	PCC		SCC		Measured Power	ERP(W)
		RB Size	RB offset	RB Size	RB offset		
M	QPSK	1	Max	1	0	22.64	0.0675
M	16QAM	1	Max	1	0	21.31	0.0497



LTE Band 66B for Ant 0							
Combination 10MHz+10MHz (50RB+50RB)							
Channel	Modulation	PCC		SCC		Measured Power	EIRP(W)
		RB Size	RB offset	RB Size	RB offset		
L	QPSK	1	Max	1	0	22.37	0.1936
M	QPSK	1	Max	1	0	22.44	0.1968
H	QPSK	1	Max	1	0	22.32	0.1914
L	16QAM	1	Max	1	0	21.25	0.1496
M	16QAM	1	Max	1	0	21.38	0.1542
H	16QAM	1	Max	1	0	21.12	0.1452
L	64QAM	1	Max	1	0	19.19	0.0931
M	64QAM	1	Max	1	0	19.25	0.0944
H	64QAM	1	Max	1	0	19.14	0.0920
Combination 15MHz+5MHz (75RB+25RB)							
Channel	Modulation	PCC		SCC		Measured Power	EIRP(W)
		RB Size	RB offset	RB Size	RB offset		
M	QPSK	1	Max	1	0	22.16	0.1845
M	16QAM	1	Max	1	0	21.01	0.1416
Combination 5MHz+15MHz (25RB+75RB)							
Channel	Modulation	PCC		SCC		Measured Power	EIRP(W)
		RB Size	RB offset	RB Size	RB offset		
M	QPSK	1	Max	1	0	22.31	0.1910
M	16QAM	1	Max	1	0	21.21	0.1483
Combination 10MHz+5MHz (50RB+25RB)							
Channel	Modulation	PCC		SCC		Measured Power	EIRP(W)
		RB Size	RB offset	RB Size	RB offset		
M	QPSK	1	Max	1	0	22.15	0.1841
M	16QAM	1	Max	1	0	21.03	0.1422
Combination 5MHz+10MHz (25RB+50RB)							
Channel	Modulation	PCC		SCC		Measured Power	EIRP(W)
		RB Size	RB offset	RB Size	RB offset		
M	QPSK	1	Max	1	0	22.39	0.1945
M	16QAM	1	Max	1	0	21.18	0.1472
Combination 5MHz+5MHz (25RB+25RB)							
Channel	Modulation	PCC		SCC		Measured Power	EIRP(W)
		RB Size	RB offset	RB Size	RB offset		
M	QPSK	1	Max	1	0	22.27	0.1892
M	16QAM	1	Max	1	0	21.11	0.1449

LTE Band 66C for Ant 0							
Combination 20MHz+20MHz (100RB+100RB)							



Channel	Modulation	PCC		SCC		Measured Power	EIRP(W)
		RB Size	RB offset	RB Size	RB offset		
L	QPSK	1	Max	1	0	22.58	0.2032
M	QPSK	1	Max	1	0	22.61	0.2046
H	QPSK	1	Max	1	0	22.46	0.1977
L	16QAM	1	Max	1	0	21.36	0.1535
M	16QAM	1	Max	1	0	21.63	0.1633
H	16QAM	1	Max	1	0	21.13	0.1455
L	64QAM	1	Max	1	0	19.65	0.1035
M	64QAM	1	Max	1	0	19.87	0.1089
H	64QAM	1	Max	1	0	19.59	0.1021
Combination 20MHz+15MHz (100RB+75RB)							
Channel	Modulation	PCC		SCC		Measured Power	EIRP(W)
		RB Size	RB offset	RB Size	RB offset		
M	QPSK	1	Max	1	0	22.34	0.1923
M	16QAM	1	Max	1	0	21.03	0.1422
Combination 15MHz+20MHz (75RB+100RB)							
Channel	Modulation	PCC		SCC		Measured Power	EIRP(W)
		RB Size	RB offset	RB Size	RB offset		
M	QPSK	1	Max	1	0	22.45	0.1972
M	16QAM	1	Max	1	0	21.19	0.1476
Combination 15MHz+15MHz (75RB+75RB)							
Channel	Modulation	PCC		SCC		Measured Power	EIRP(W)
		RB Size	RB offset	RB Size	RB offset		
M	QPSK	1	Max	1	0	22.38	0.1941
M	16QAM	1	Max	1	0	21.29	0.1510
Combination 20MHz+10MHz (100RB+50RB)							
Channel	Modulation	PCC		SCC		Measured Power	EIRP(W)
		RB Size	RB offset	RB Size	RB offset		
M	QPSK	1	Max	1	0	22.49	0.1991
M	16QAM	1	Max	1	0	21.06	0.1432
Combination 10MHz+20MHz (50RB+100RB)							
Channel	Modulation	PCC		SCC		Measured Power	EIRP(W)
		RB Size	RB offset	RB Size	RB offset		
M	QPSK	1	Max	1	0	22.42	0.1959
M	16QAM	1	Max	1	0	21.03	0.1422
Combination 15MHz+10MHz (75RB+50RB)							
Channel	Modulation	PCC		SCC		Measured	EIRP(W)



		RB Size	RB offset	RB Size	RB offset		
M	QPSK	1	Max	1	0	22.19	0.1858
M	16QAM	1	Max	1	0	21.01	0.1416
Combination 10MHz+15MHz (50RB+75RB)							
Channel	Modulation	PCC		SCC		Measured Power	EIRP(W)
		RB Size	RB offset	RB Size	RB offset		
M	QPSK	1	Max	1	0	22.57	0.2028
M	16QAM	1	Max	1	0	21.35	0.1531
Combination 20MHz+5MHz (100RB+25RB)							
Channel	Modulation	PCC		SCC		Measured Power	EIRP(W)
		RB Size	RB offset	RB Size	RB offset		
M	QPSK	1	Max	1	0	22.31	0.1910
M	16QAM	1	Max	1	0	21.02	0.1419
Combination 5MHz+20MHz (25RB+100RB)							
Channel	Modulation	PCC		SCC		Measured Power	EIRP(W)
		RB Size	RB offset	RB Size	RB offset		
M	QPSK	1	Max	1	0	22.41	0.1954
M	16QAM	1	Max	1	0	21.30	0.1514



LTE Band 25

Peak-to-Average Ratio

Mode	LTE Band 25 / 20MHz			
Mod.	QPSK	16QAM	64QAM	Limit: 13dB
RB Size	Full RB	Full RB	Full RB	Result
Middle CH	5.33	6.14	6.55	PASS

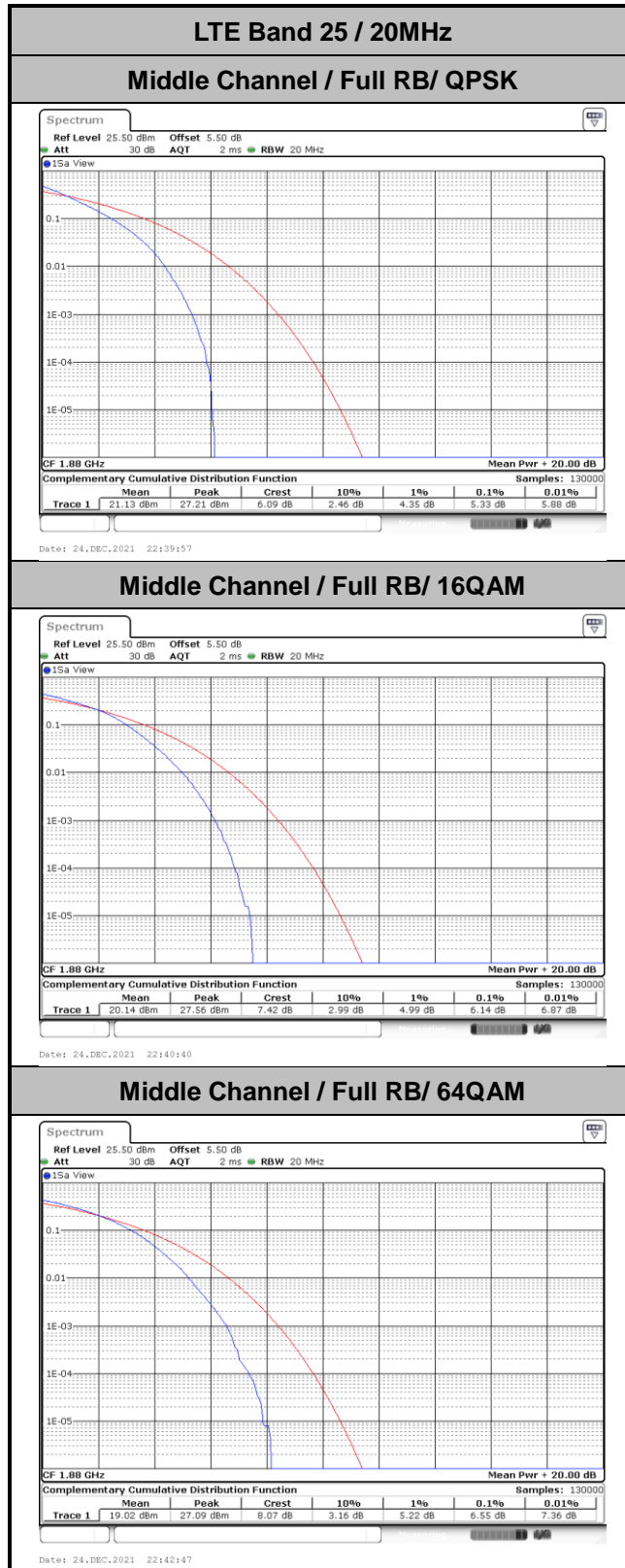



26dB Bandwidth

Mode	LTE Band 25 : 26dB BW(MHz)	
BW	20MHz	
Mod.	QPSK	16QAM
Middle CH	18.74	18.98

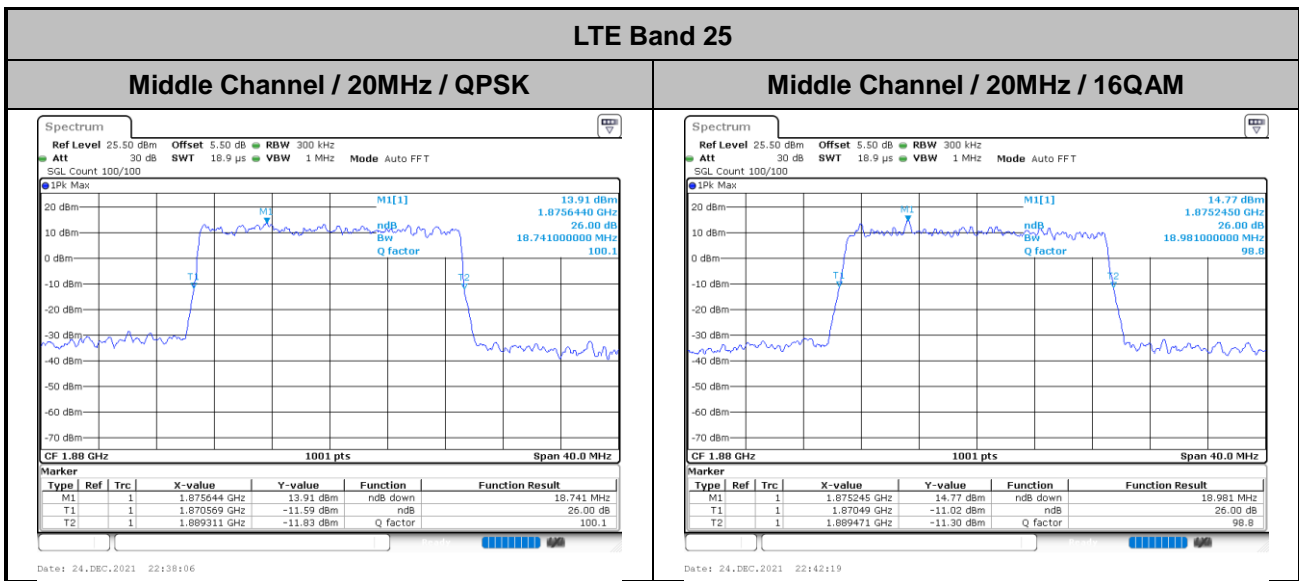



Occupied Bandwidth

Mode	LTE Band 25 : 99%OBW(MHz)	
BW	20MHz	
Mod.	QPSK	16QAM
Middle CH	17.86	17.82

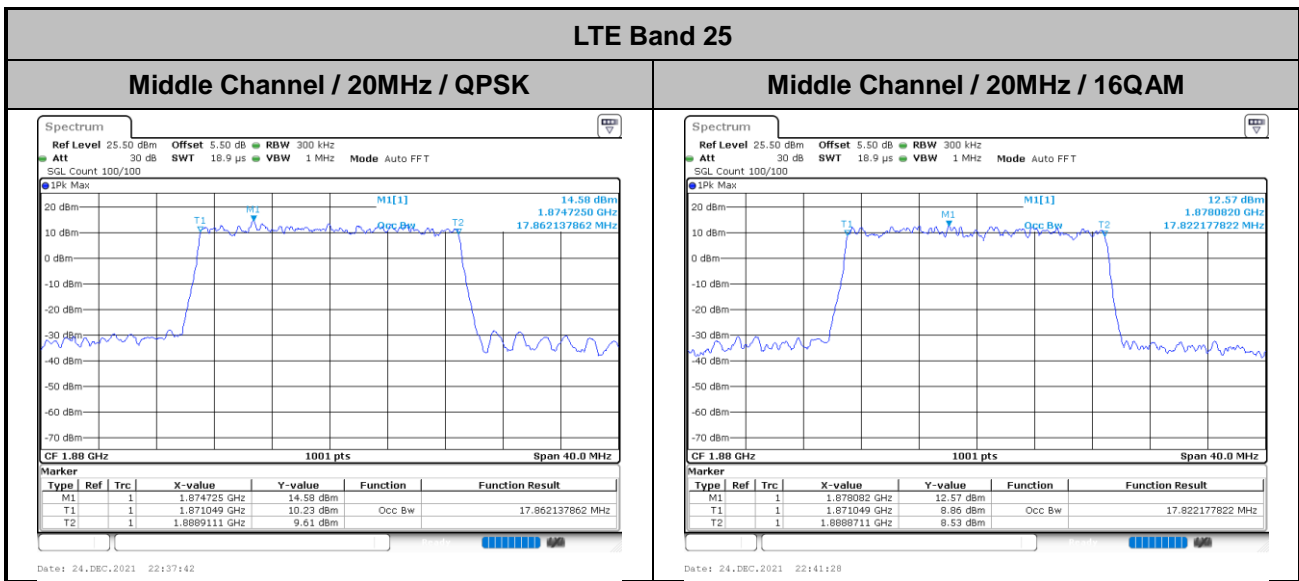



Conducted Band Edge

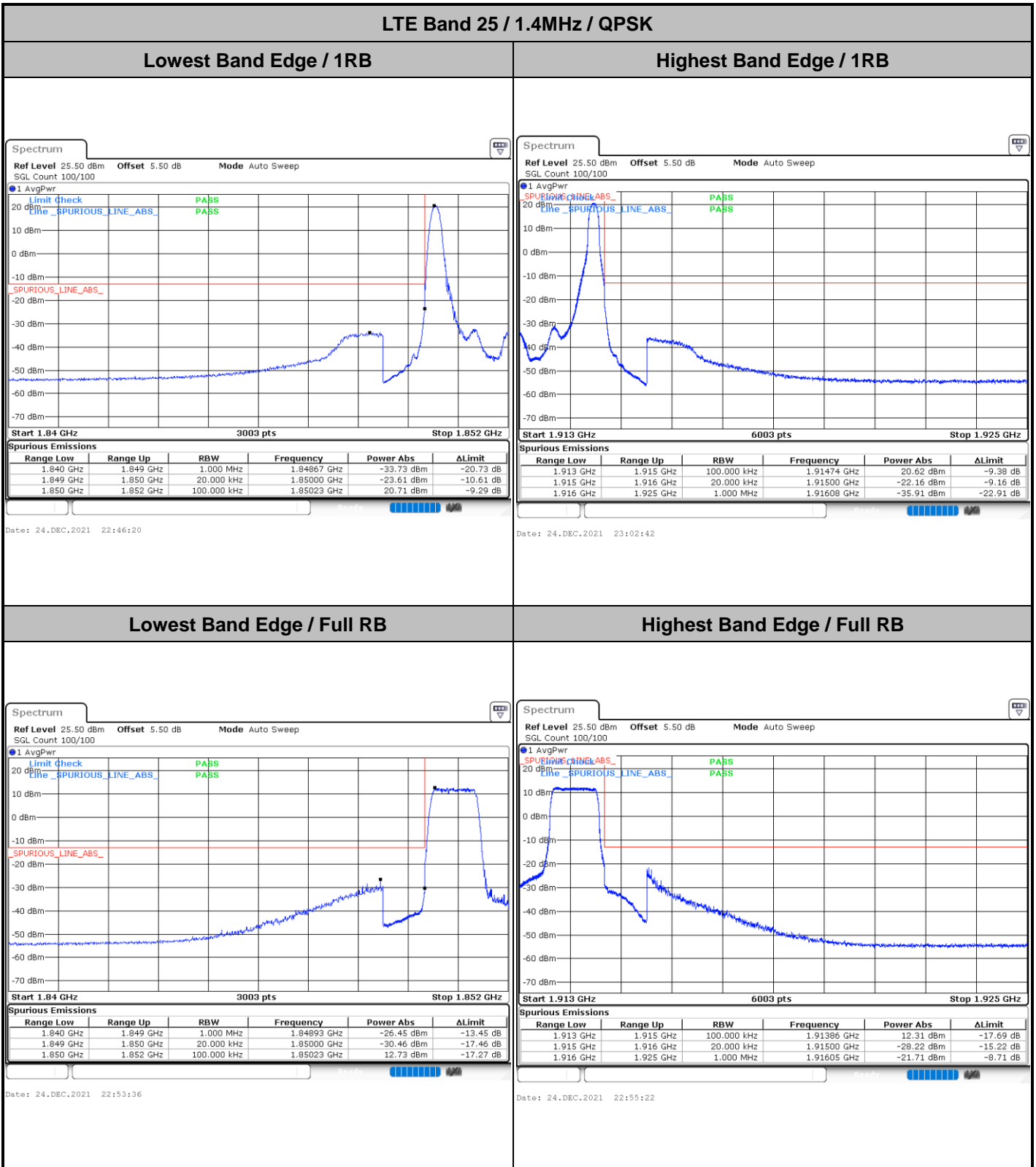



LTE Band 25 / 1.4MHz / 16QAM

Lowest Band Edge / 1 RB

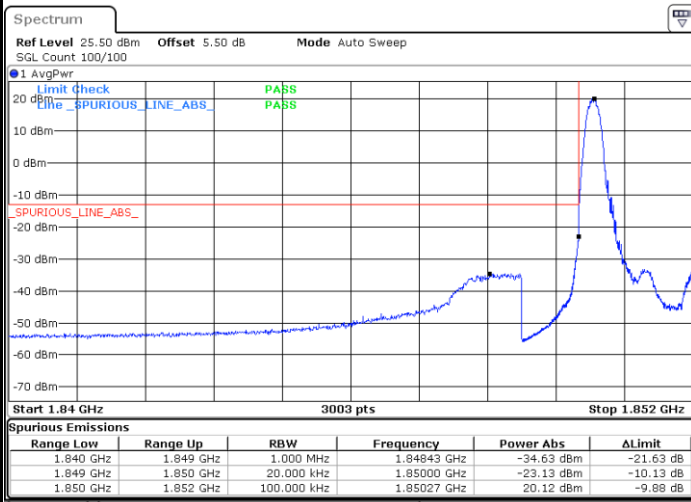

Date: 24.DEC.2021 22:47:45

Highest Band Edge / 1 RB

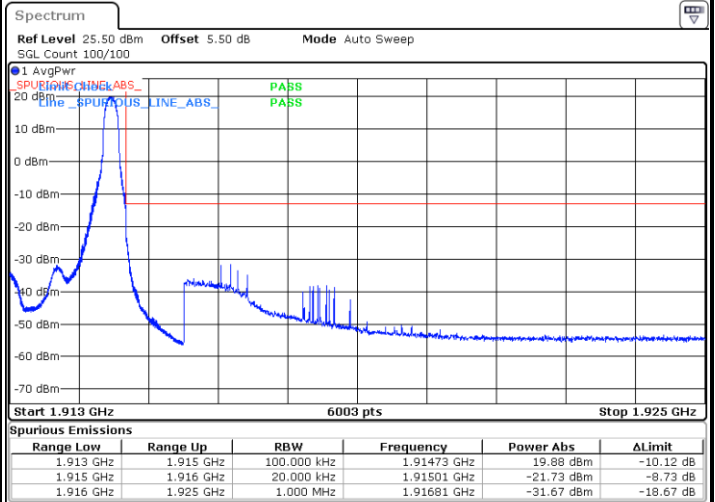

Date: 24.DEC.2021 23:01:16

Lowest Band Edge / Full RB

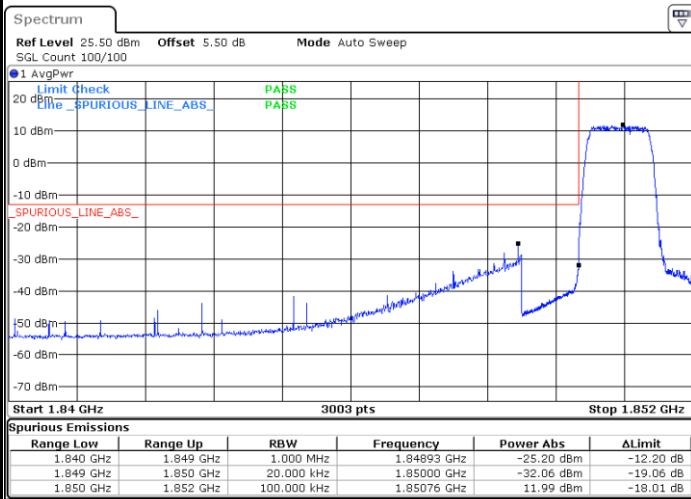

Date: 24.DEC.2021 22:51:59

Highest Band Edge / Full RB

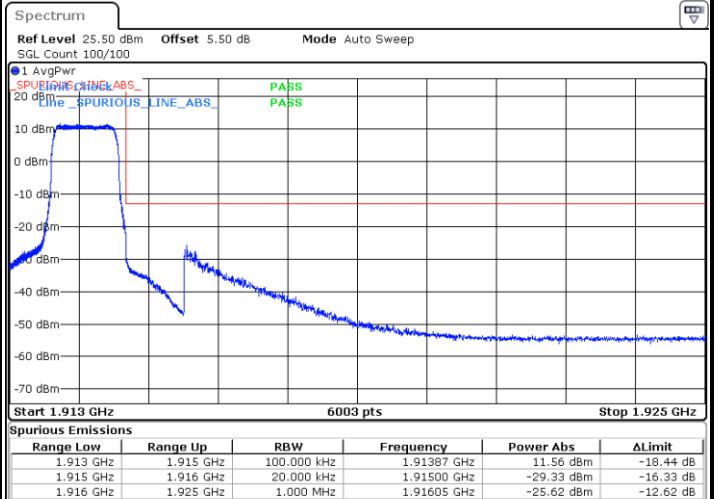

Date: 24.DEC.2021 22:56:49



LTE Band 25 / 1.4MHz / 64QAM

Lowest Band Edge / 1 RB

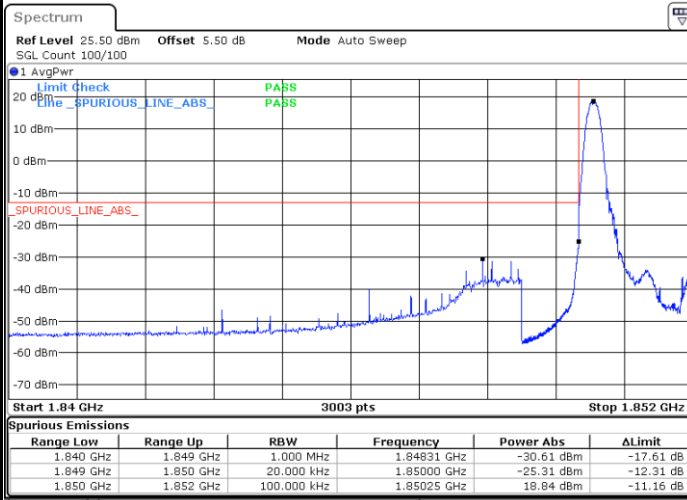

Date: 24.DEC.2021 22:49:09

Highest Band Edge / 1 RB

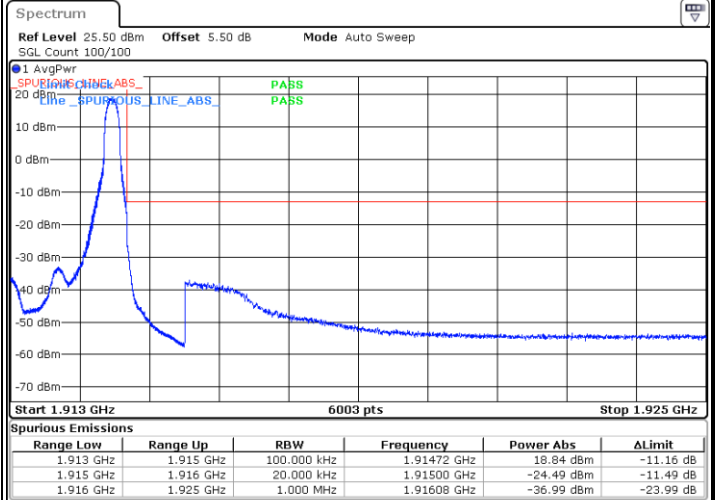

Date: 24.DEC.2021 22:59:47

Lowest Band Edge / Full RB

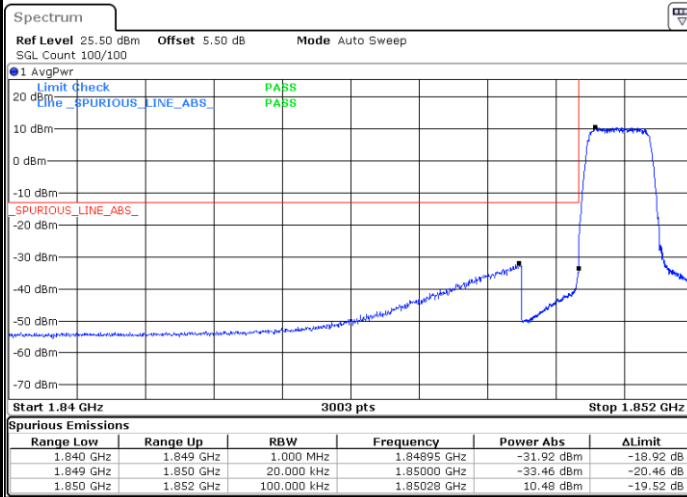

Date: 24.DEC.2021 22:50:37

Highest Band Edge / Full RB

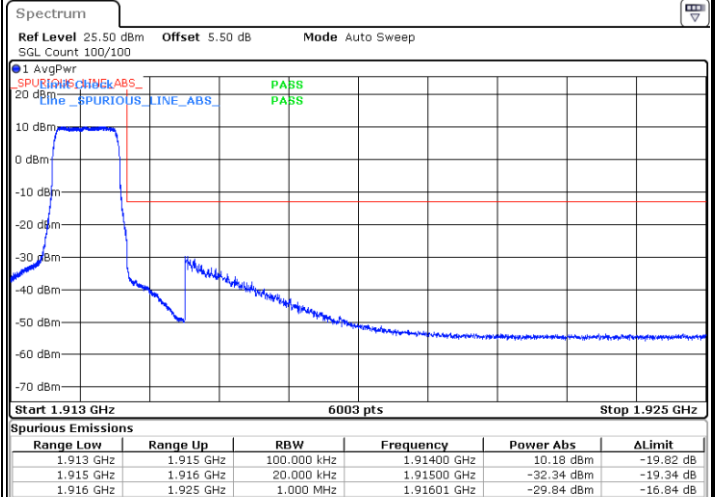

Date: 24.DEC.2021 22:58:20



LTE Band 25 / 3MHz / QPSK

Lowest Band Edge / 1RB

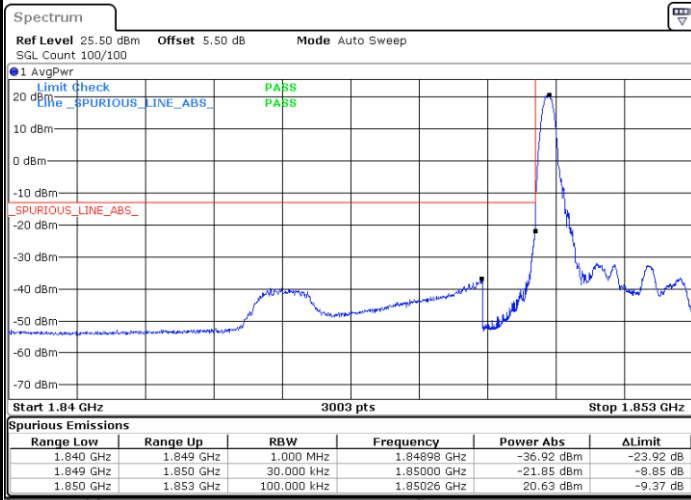

Date: 24.DEC.2021 22:06:43

Highest Band Edge / 1 RB

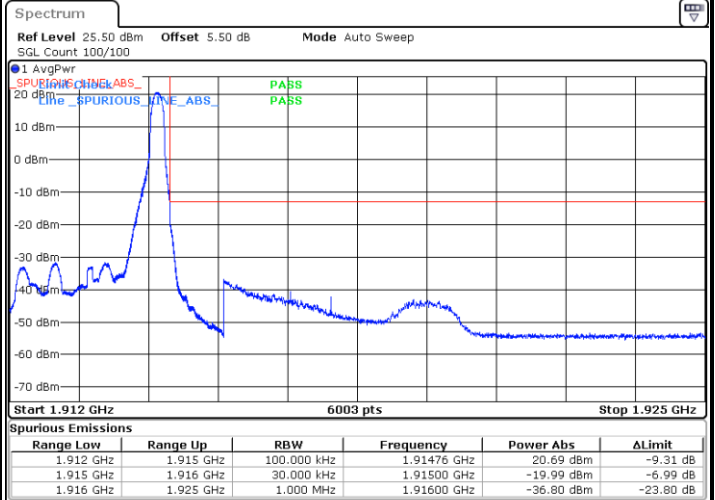

Date: 24.DEC.2021 22:13:04

Lowest Band Edge / Full RB

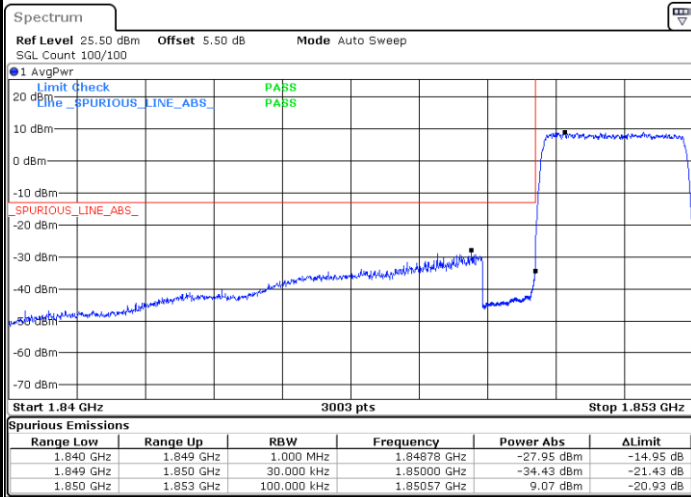

Date: 24.DEC.2021 22:08:31

Highest Band Edge / Full RB

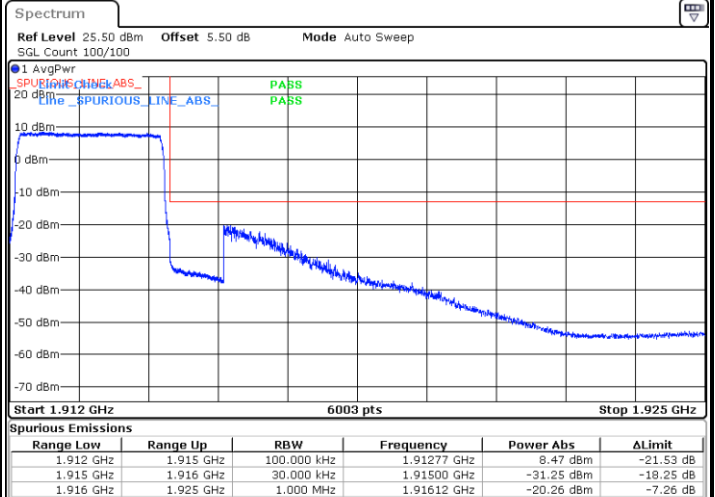

Date: 24.DEC.2021 22:10:19



LTE Band 25 / 3MHz / 16QAM

Lowest Band Edge / 1 RB

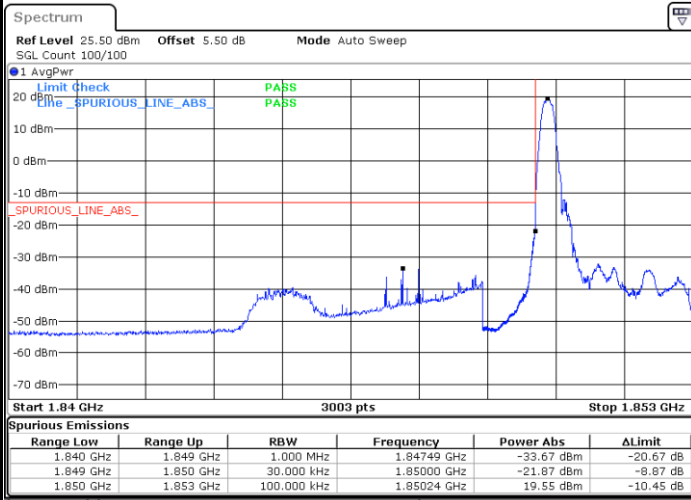

Date: 24.DEC.2021 22:07:37

Highest Band Edge / 1 RB

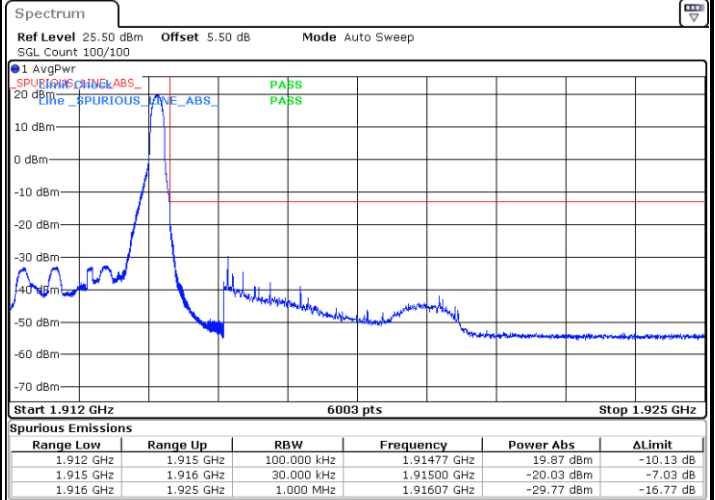

Date: 24.DEC.2021 22:12:09

Lowest Band Edge / Full RB

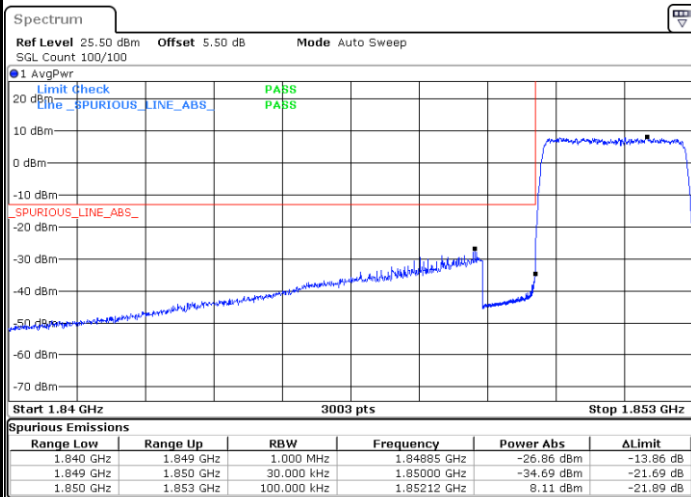

Date: 24.DEC.2021 22:09:25

Highest Band Edge / Full RB

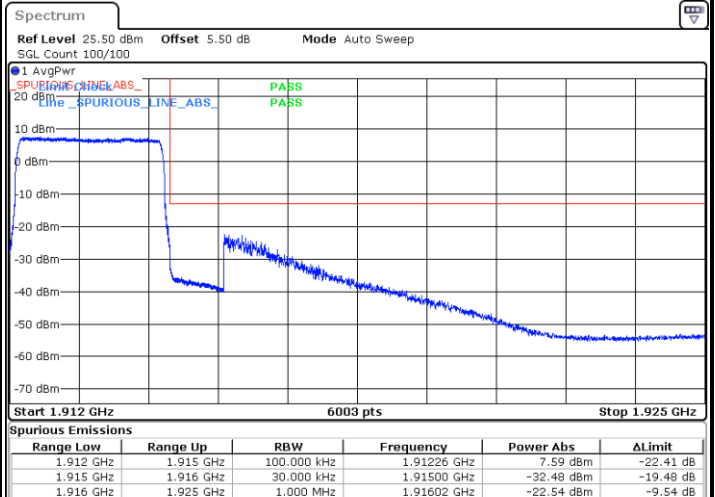

Date: 24.DEC.2021 22:11:14



LTE Band 25 / 3MHz / 64QAM

Lowest Band Edge / 1 RB

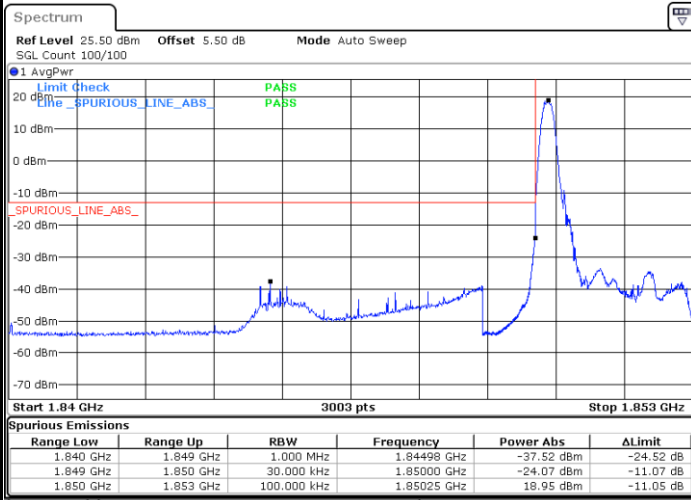

Date: 24.DEC.2021 22:17:52

Highest Band Edge / 1 RB

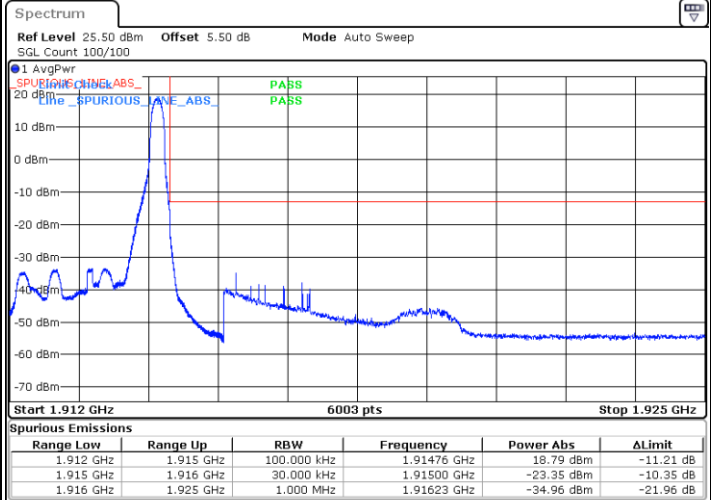

Date: 24.DEC.2021 22:14:50

Lowest Band Edge / Full RB

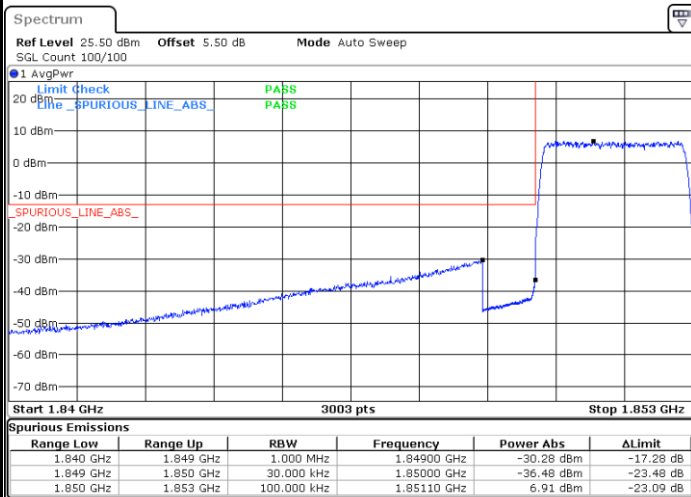

Date: 24.DEC.2021 22:16:51

Highest Band Edge / Full RB

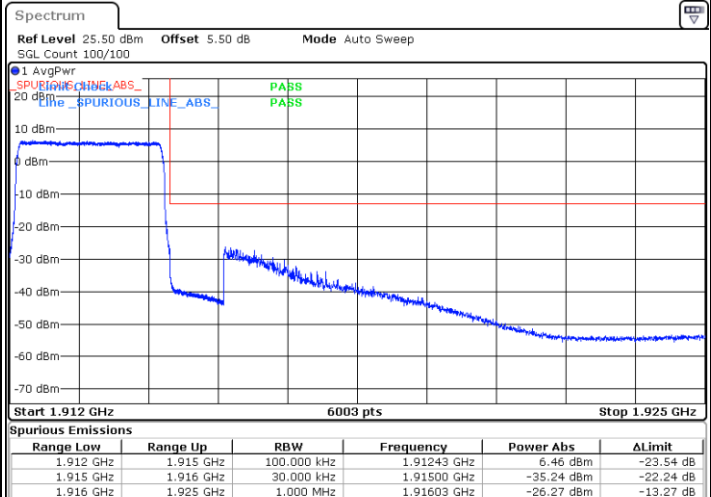

Date: 24.DEC.2021 22:15:53



LTE Band 25 / 5MHz / QPSK

Lowest Band Edge / 1 RB

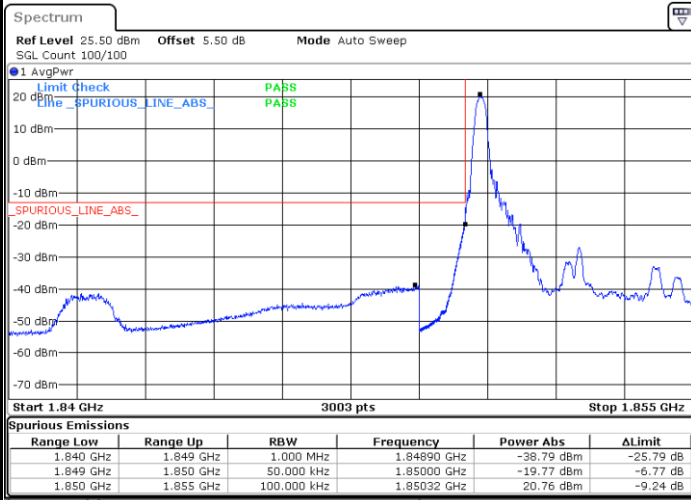

Date: 24.DEC.2021 21:04:30

Highest Band Edge / 1 RB

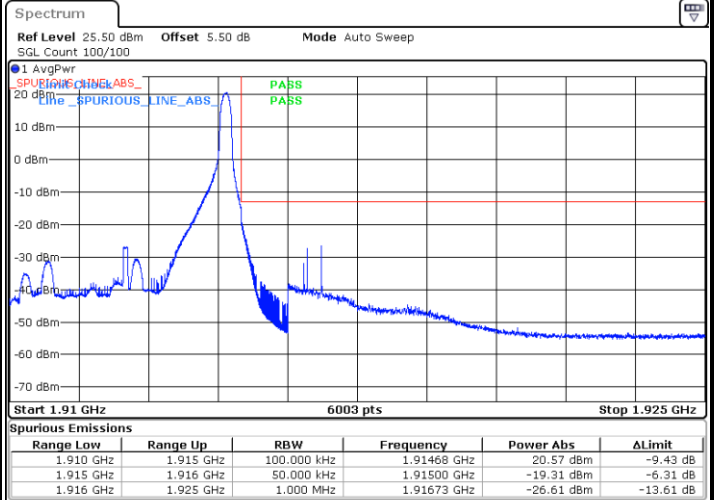

Date: 24.DEC.2021 21:10:49

Lowest Band Edge / Full RB

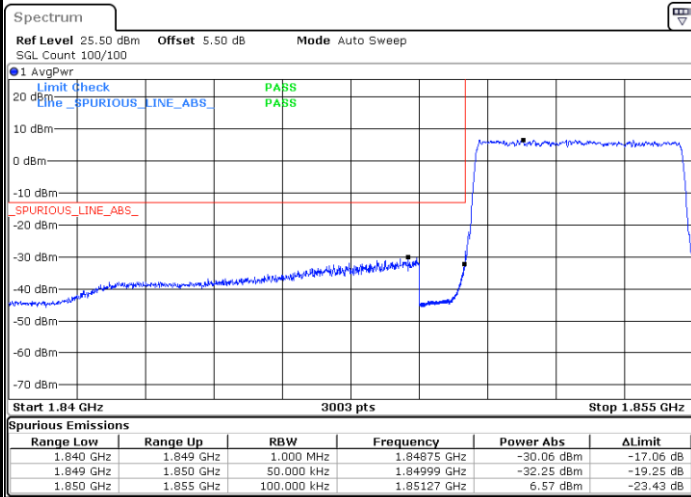

Date: 24.DEC.2021 21:06:18

Highest Band Edge / Full RB

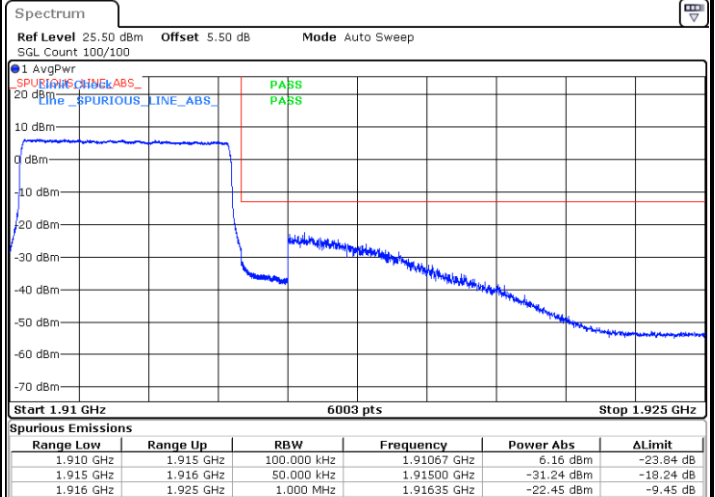

Date: 24.DEC.2021 21:08:07



LTE Band 25 / 5MHz / 16QAM

Lowest Band Edge / 1RB

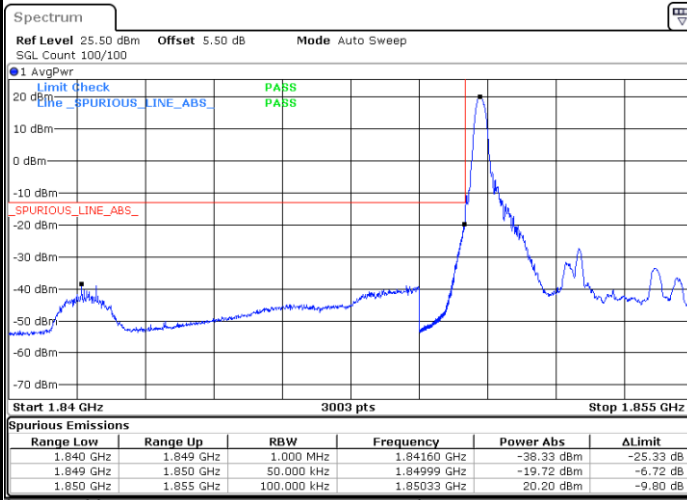

Date: 24.DEC.2021 21:05:24

Highest Band Edge / 1 RB

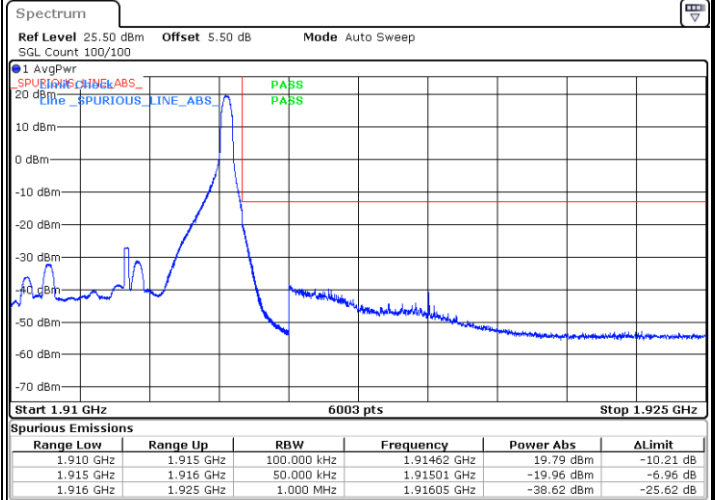

Date: 24.DEC.2021 21:09:55

Lowest Band Edge / Full RB

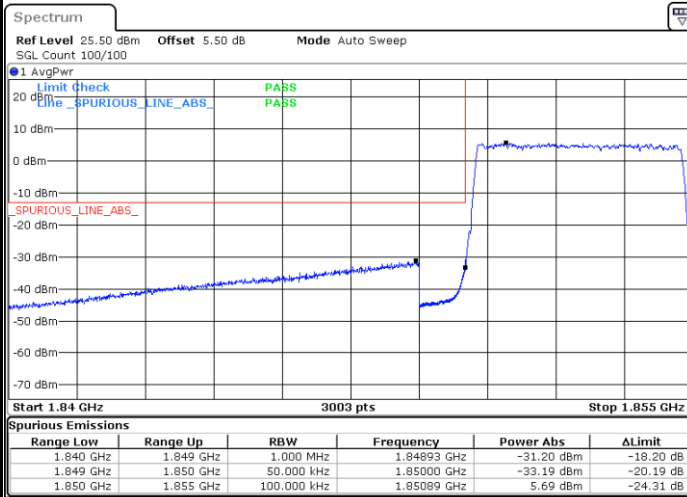

Date: 24.DEC.2021 21:07:12

Highest Band Edge / Full RB

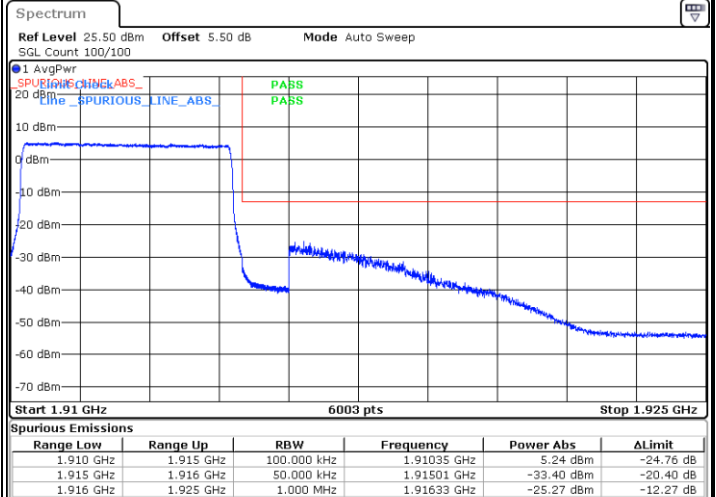

Date: 24.DEC.2021 21:09:01



LTE Band 25 / 5MHz / 64QAM

Lowest Band Edge / 1RB

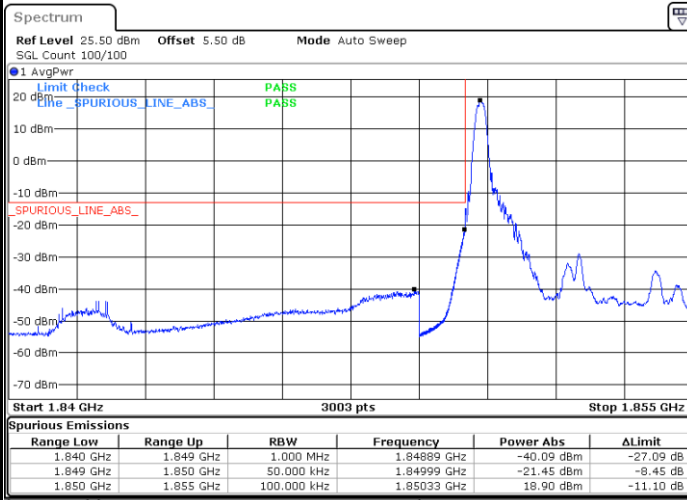

Date: 24.DEC.2021 21:11:43

Highest Band Edge / 1 RB

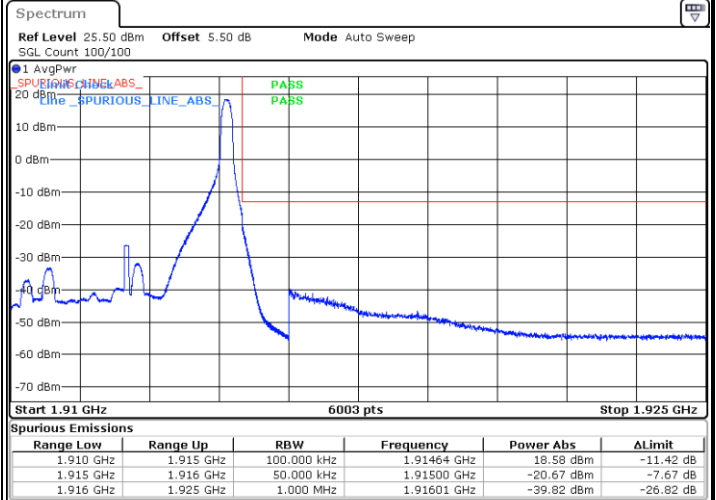

Date: 24.DEC.2021 21:14:25

Lowest Band Edge / Full RB

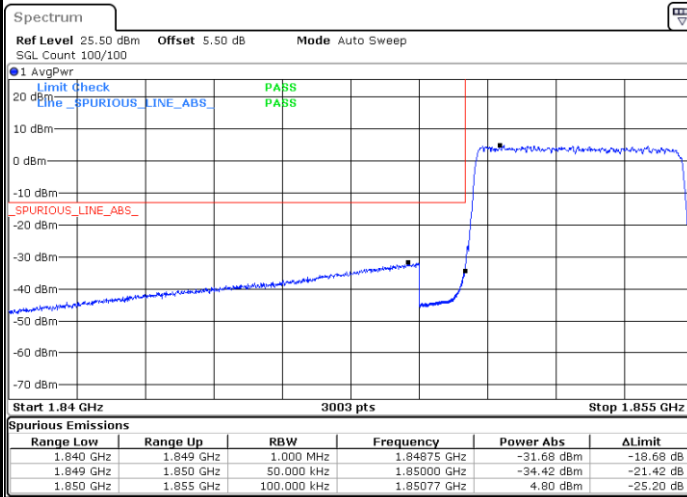

Date: 24.DEC.2021 21:12:37

Highest Band Edge / Full RB

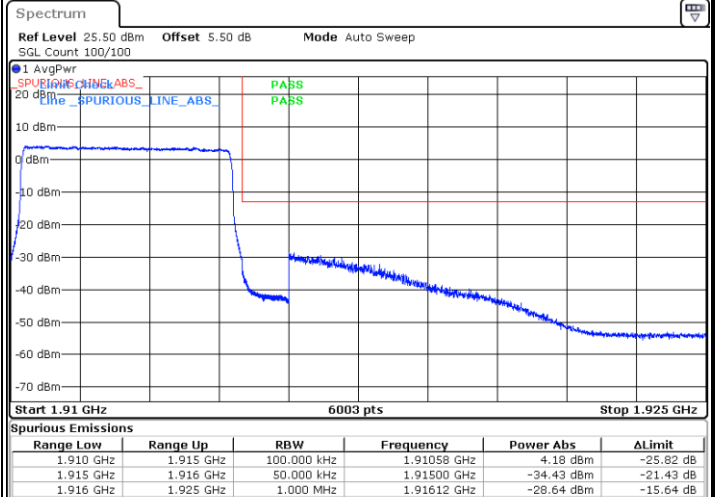

Date: 24.DEC.2021 21:13:31



LTE Band 25 / 10MHz / QPSK

Lowest Band Edge / 1 RB

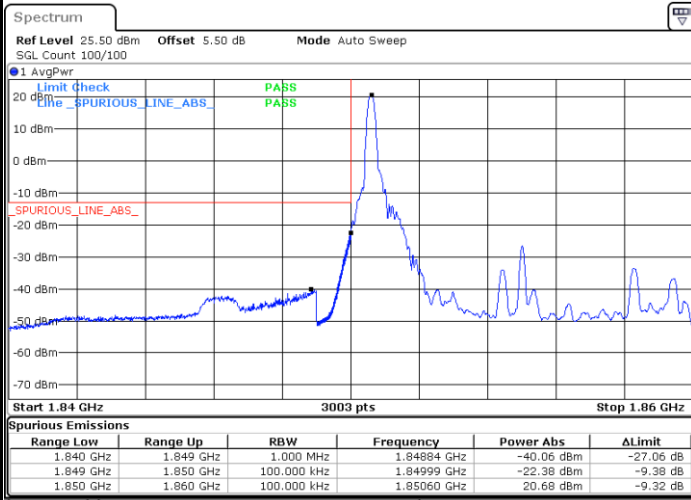

Date: 24.DEC.2021 21:15:19

Highest Band Edge / 1 RB

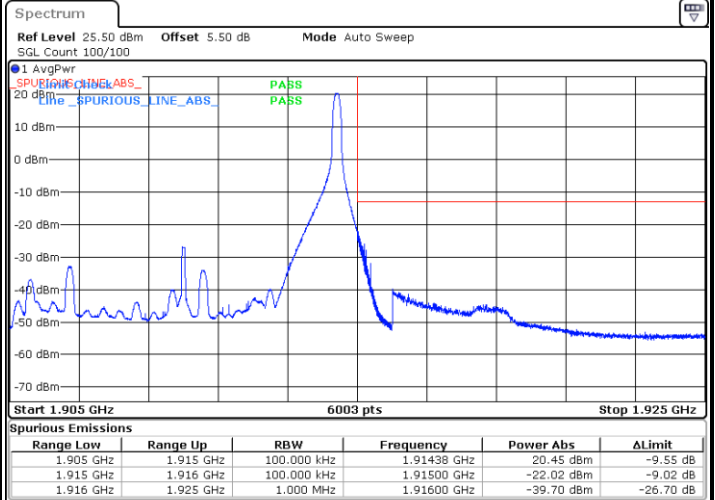

Date: 24.DEC.2021 21:21:37

Lowest Band Edge / Full RB

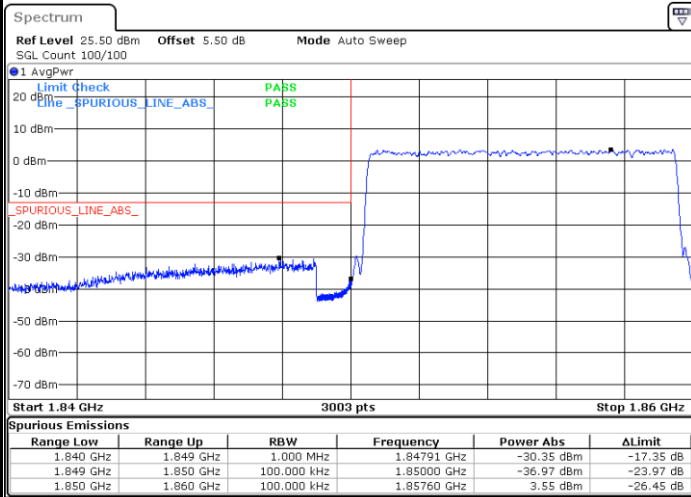

Date: 24.DEC.2021 21:17:07

Highest Band Edge / Full RB

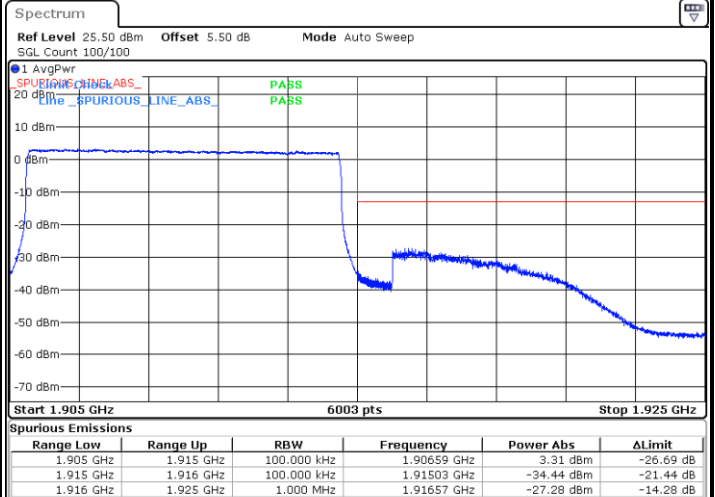

Date: 24.DEC.2021 21:18:55



LTE Band 25 / 10MHz / 16QAM

Lowest Band Edge / 1 RB

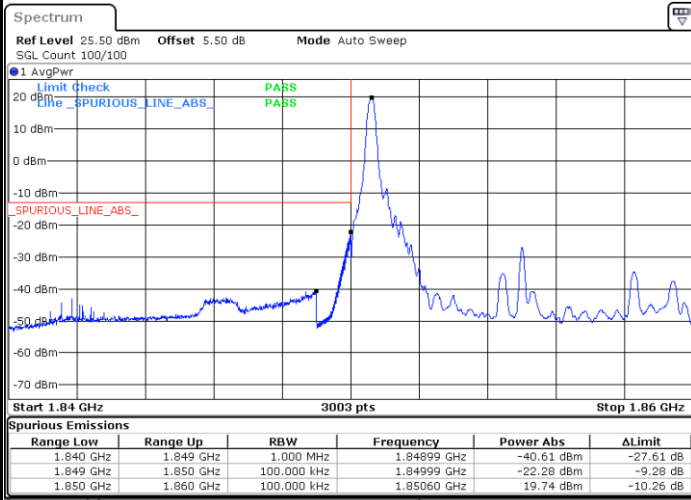

Date: 24.DEC.2021 21:16:13

Highest Band Edge / 1 RB

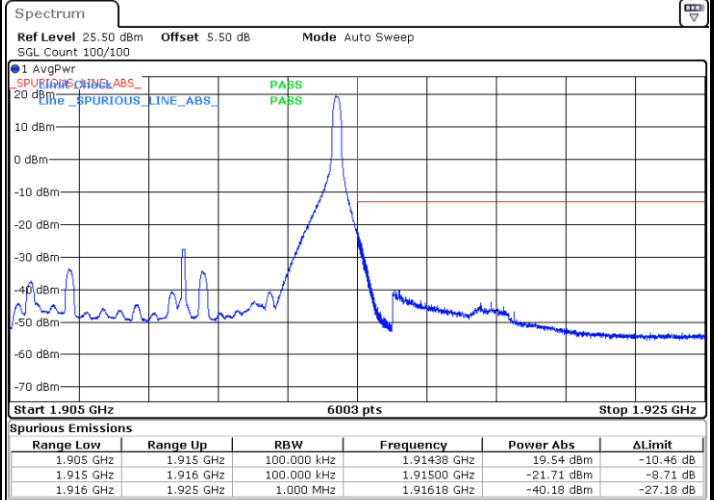

Date: 24.DEC.2021 21:20:44

Lowest Band Edge / Full RB

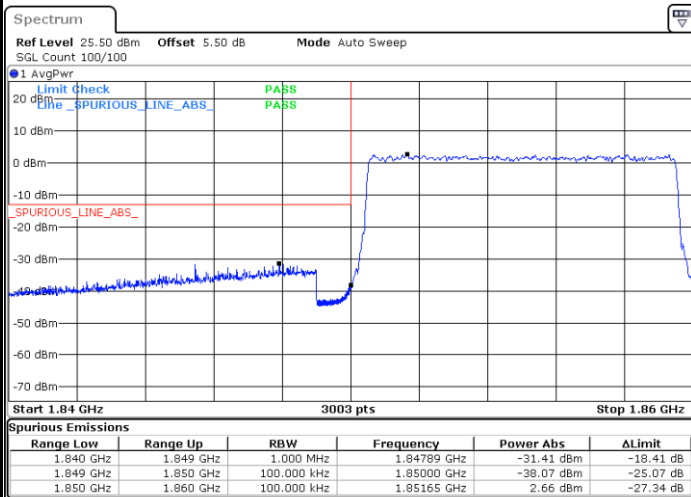

Date: 24.DEC.2021 21:18:01

Highest Band Edge / Full RB

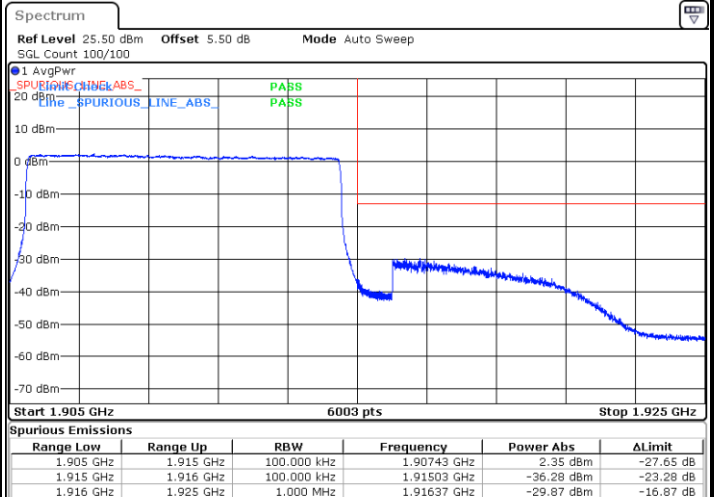

Date: 24.DEC.2021 21:19:50



LTE Band 25 / 10MHz / 64QAM

Lowest Band Edge / 1 RB

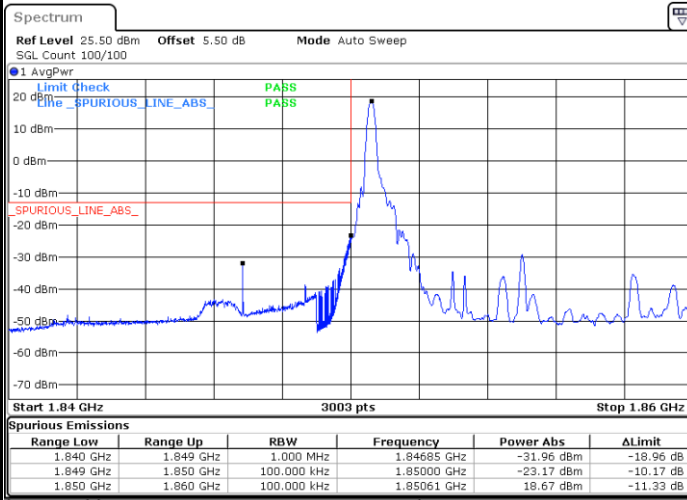

Date: 24.DEC.2021 21:22:31

Highest Band Edge / 1 RB

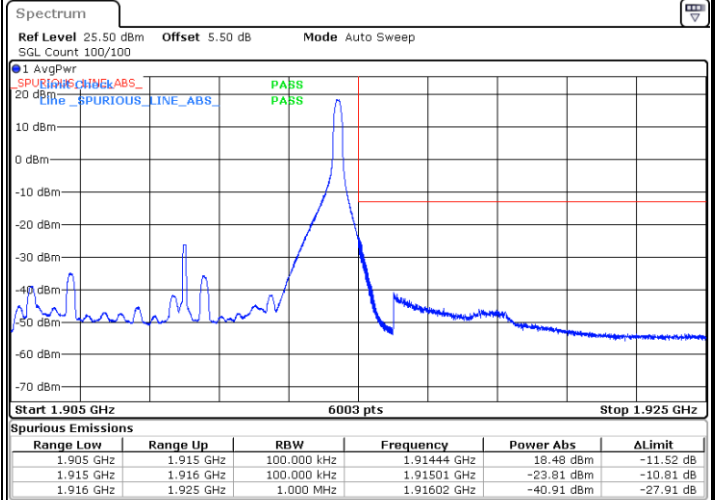

Date: 24.DEC.2021 21:25:13

Lowest Band Edge / Full RB

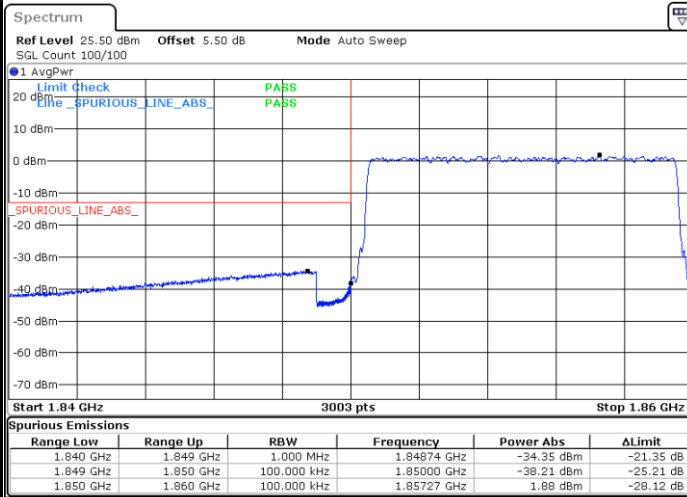

Date: 24.DEC.2021 21:23:25

Highest Band Edge / Full RB

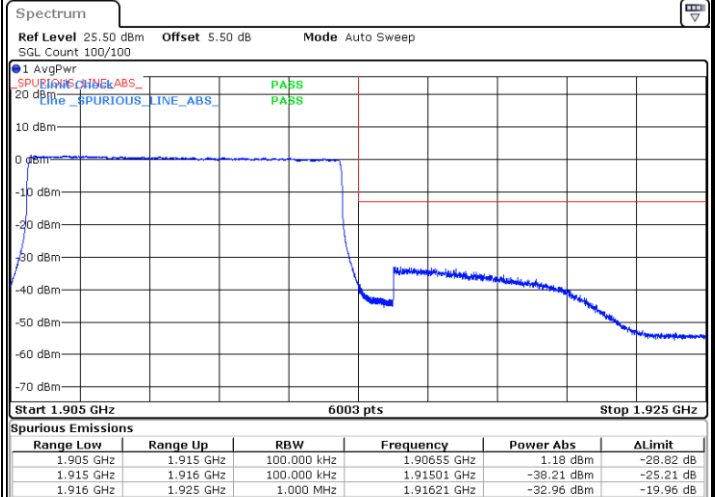

Date: 24.DEC.2021 21:24:19



LTE Band 25 / 15MHz / QPSK

Lowest Band Edge / 1 RB

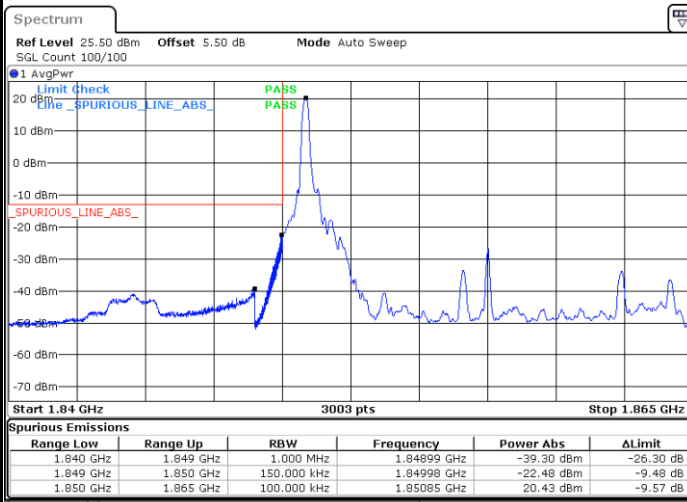

Date: 24.DEC.2021 21:29:51

Highest Band Edge / 1 RB

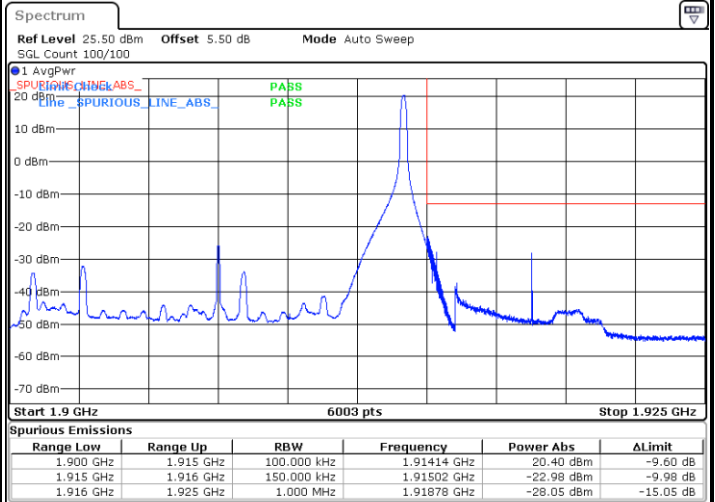

Date: 24.DEC.2021 21:36:24

Lowest Band Edge / Full RB

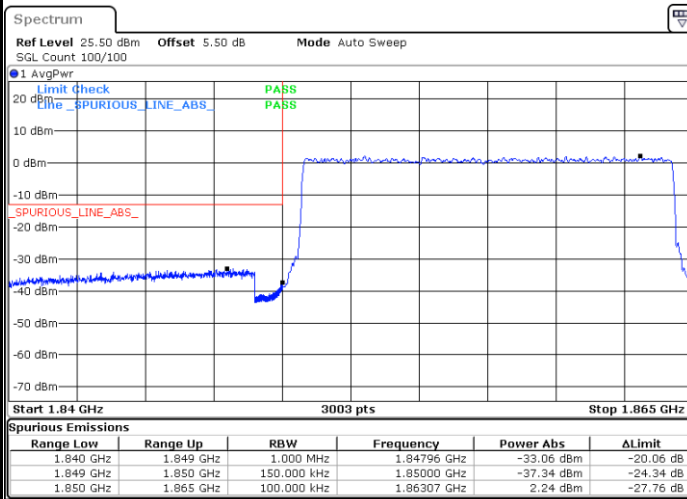

Date: 24.DEC.2021 21:31:39

Highest Band Edge / Full RB

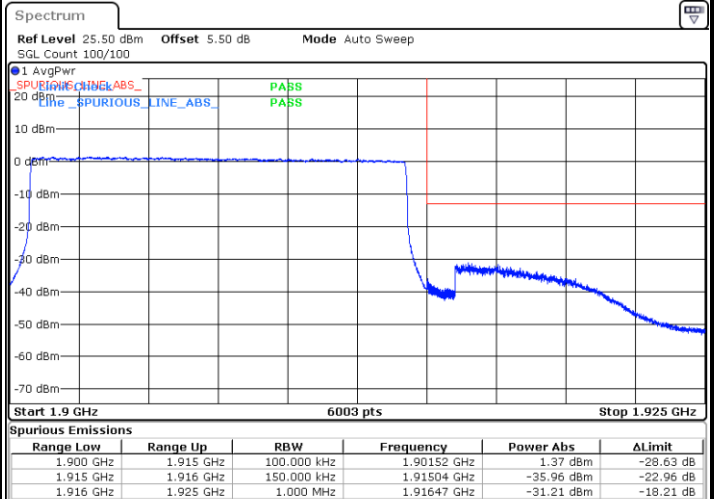

Date: 24.DEC.2021 21:33:31



LTE Band 25 / 15MHz / 16QAM

Lowest Band Edge / 1 RB

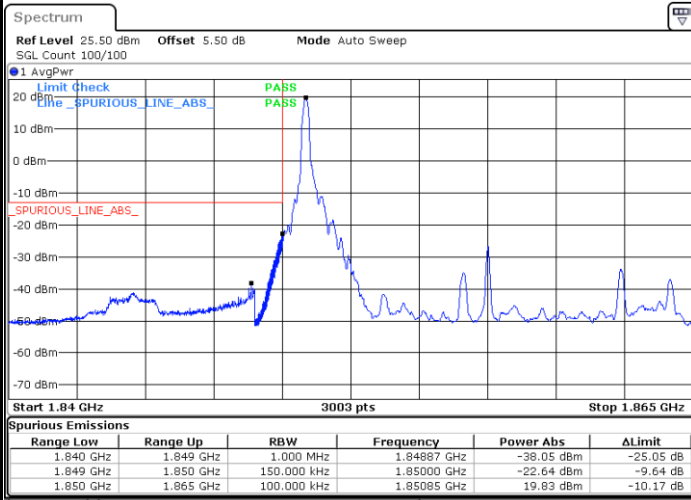

Date: 24.DEC.2021 21:30:45

Highest Band Edge / 1 RB

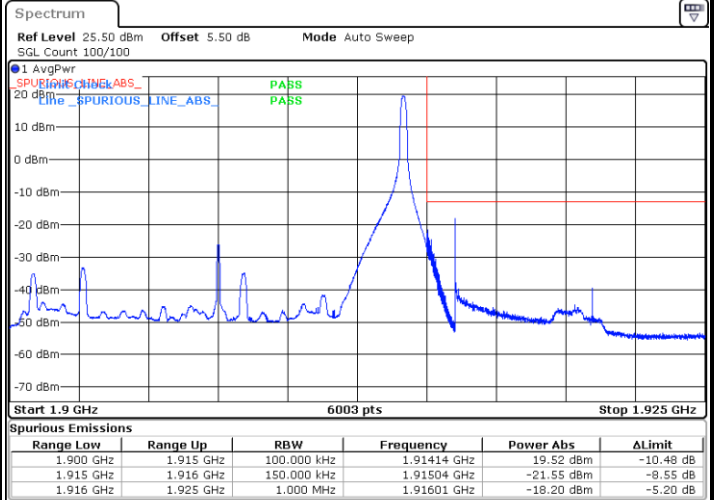

Date: 24.DEC.2021 21:35:27

Lowest Band Edge / Full RB

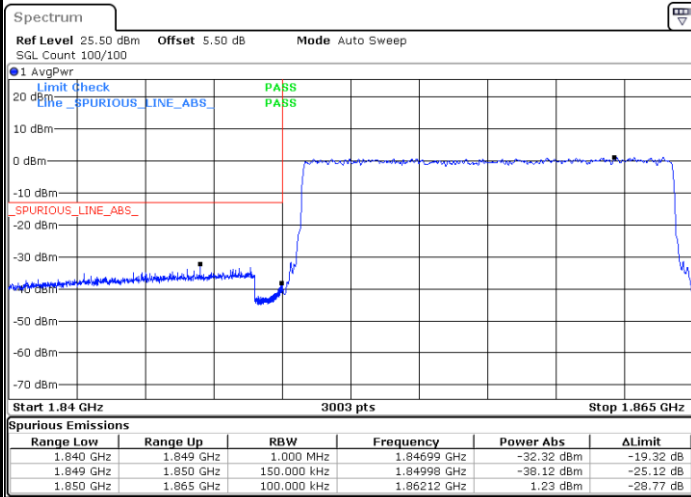

Date: 24.DEC.2021 21:32:33

Highest Band Edge / Full RB

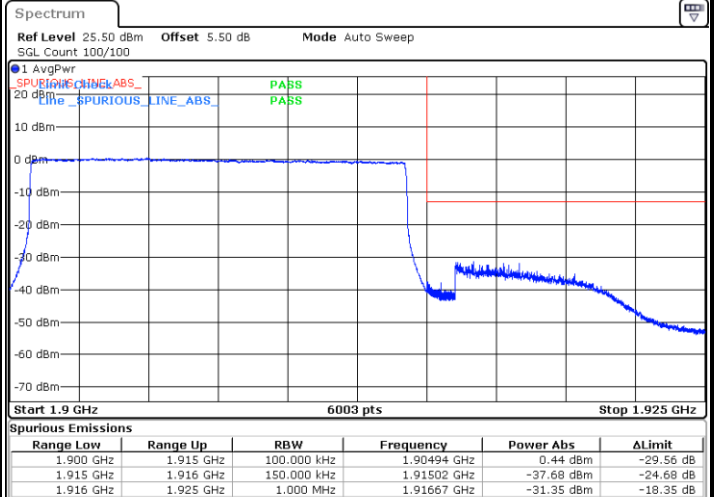

Date: 24.DEC.2021 21:34:29



LTE Band 25 / 15MHz / 64QAM

Lowest Band Edge / 1 RB

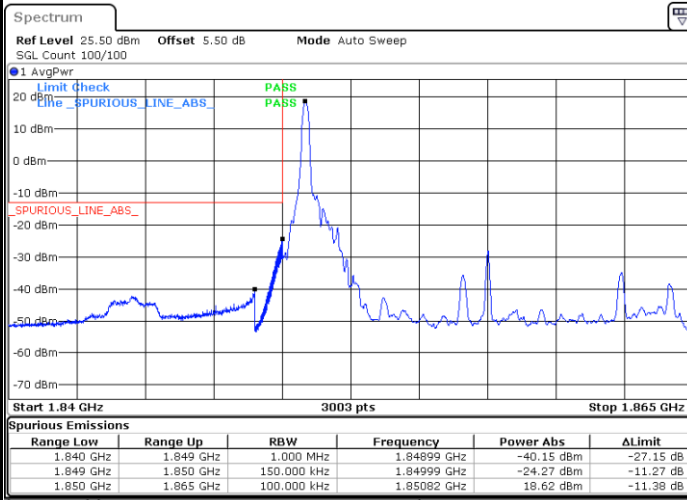

Date: 24.DEC.2021 21:26:08

Highest Band Edge / 1 RB

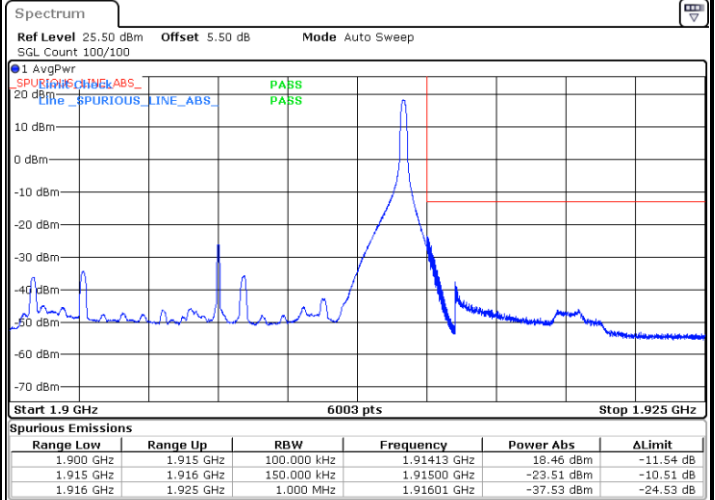

Date: 24.DEC.2021 21:28:57

Lowest Band Edge / Full RB

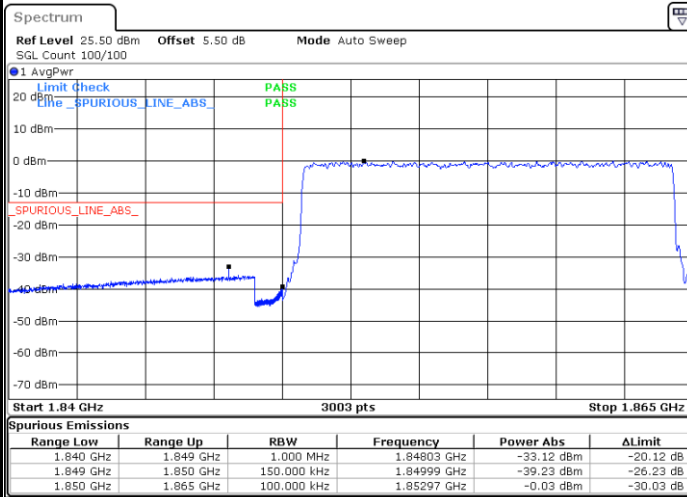

Date: 24.DEC.2021 21:27:02

Highest Band Edge / Full RB

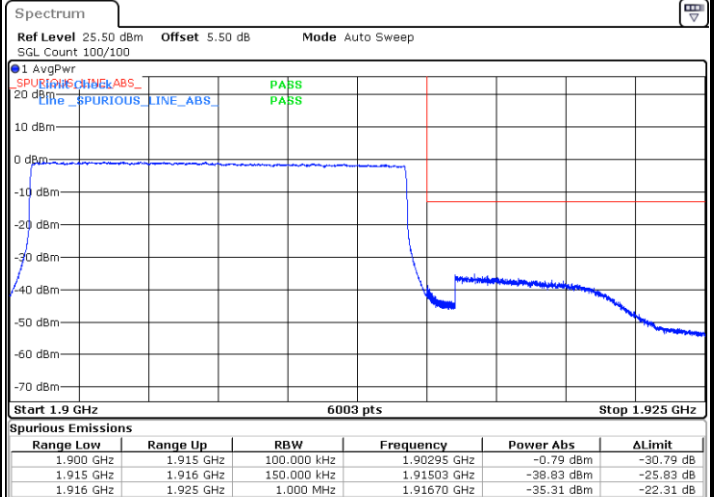

Date: 24.DEC.2021 21:27:59



LTE Band 25 / 20MHz / QPSK

Lowest Band Edge / 1 RB

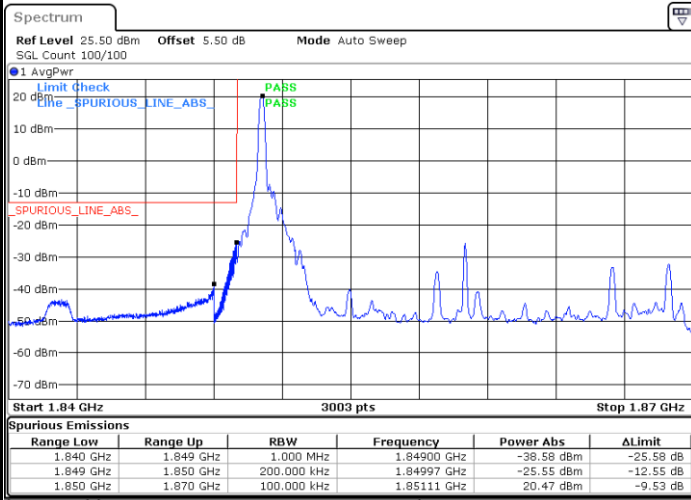

Date: 24.DEC.2021 21:37:19

Highest Band Edge / 1 RB

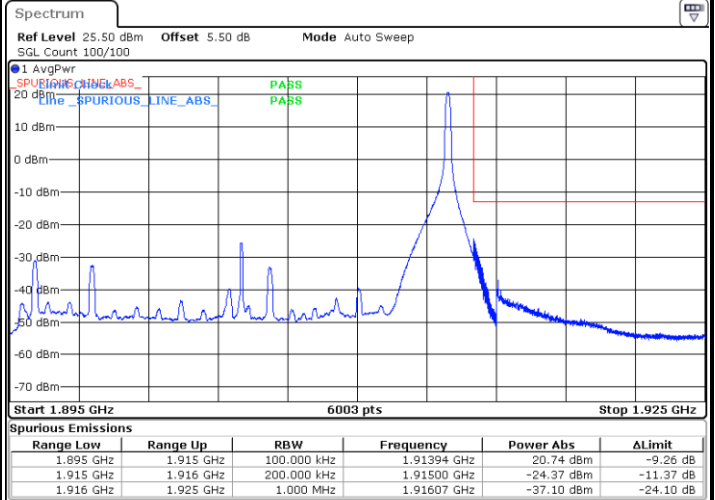

Date: 26.DEC.2021 06:26:09

Lowest Band Edge / Full RB

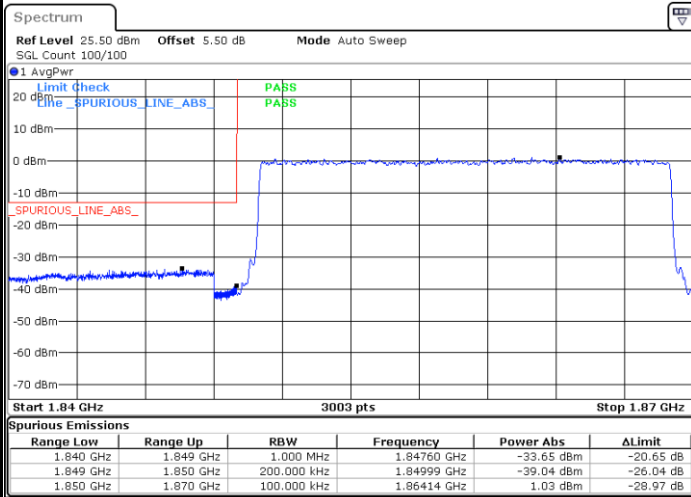

Date: 24.DEC.2021 21:39:07

Highest Band Edge / Full RB



Date: 26.DEC.2021 06:24:40



LTE Band 25 / 20MHz / 16QAM

Lowest Band Edge / 1 RB

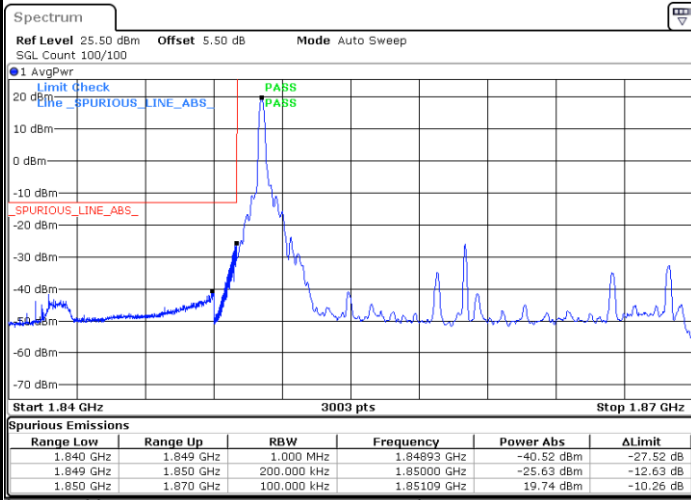

Date: 24.DEC.2021 21:38:13

Highest Band Edge / 1 RB

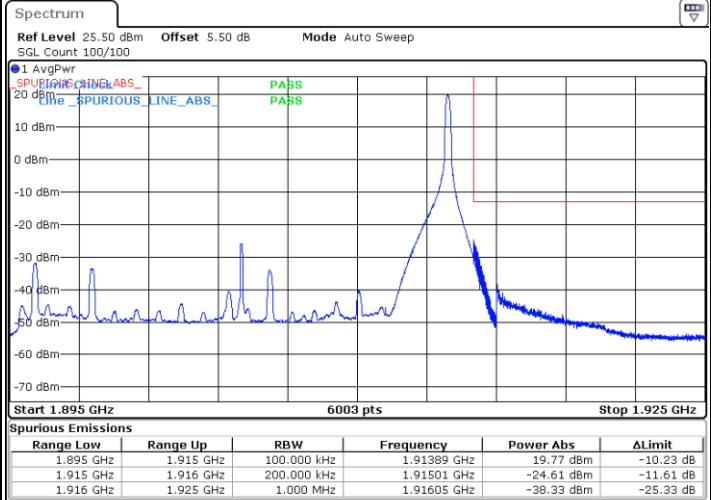

Date: 26.DEC.2021 06:27:39

Lowest Band Edge / Full RB

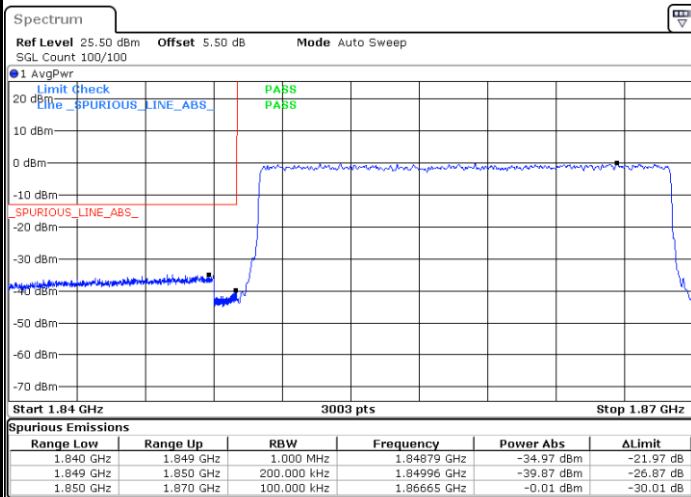

Date: 24.DEC.2021 21:40:01

Highest Band Edge / Full RB

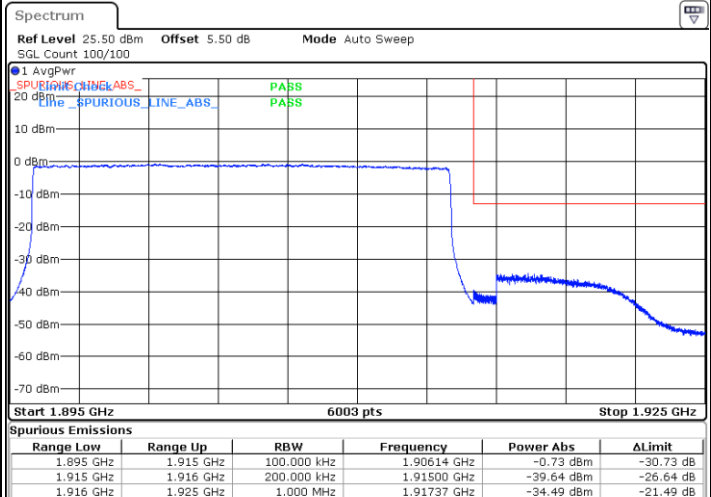

Date: 26.DEC.2021 06:23:09



LTE Band 25 / 20MHz / 64QAM

Lowest Band Edge / 1 RB

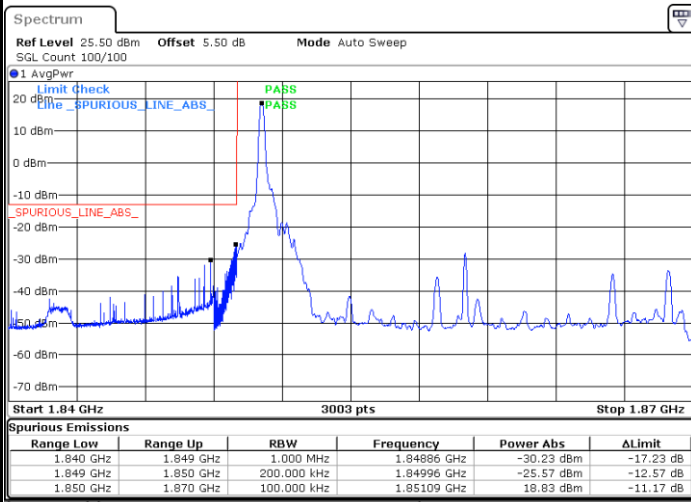

Date: 24.DEC.2021 21:45:24

Highest Band Edge / 1 RB

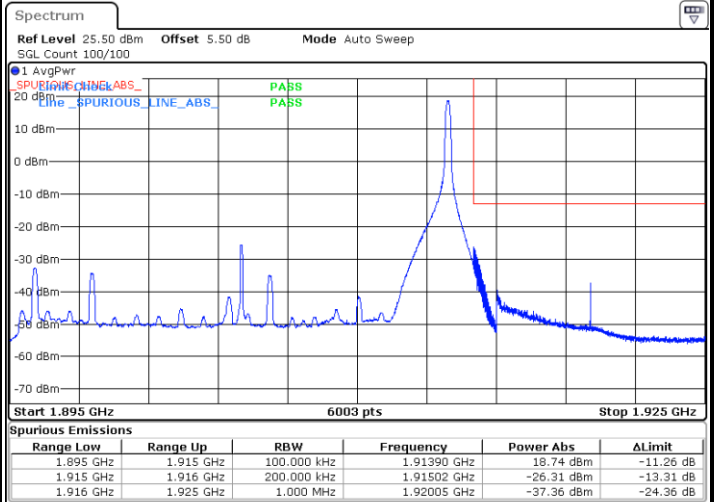

Date: 26.DEC.2021 06:29:01

Lowest Band Edge / Full RB

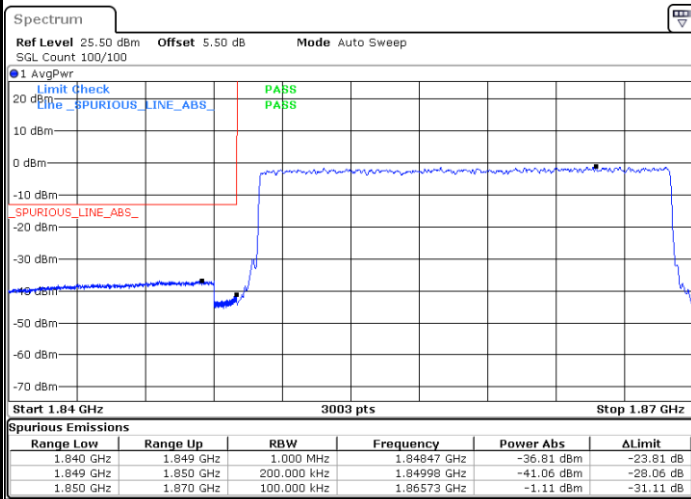

Date: 24.DEC.2021 21:46:18

Highest Band Edge / Full RB

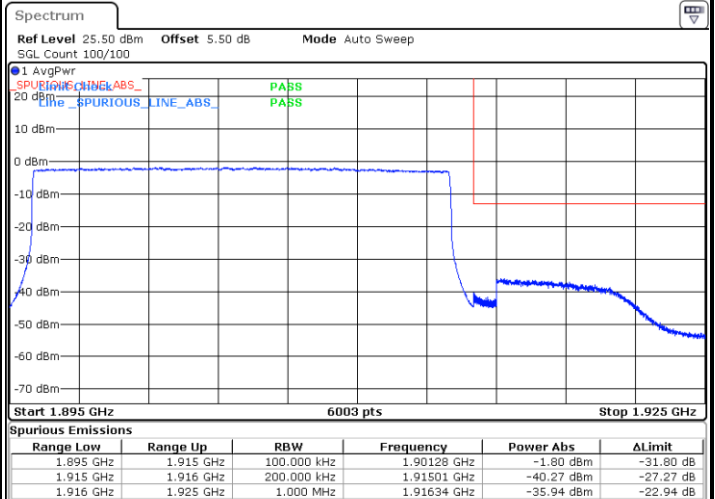

Date: 26.DEC.2021 06:21:45



Conducted Spurious Emission

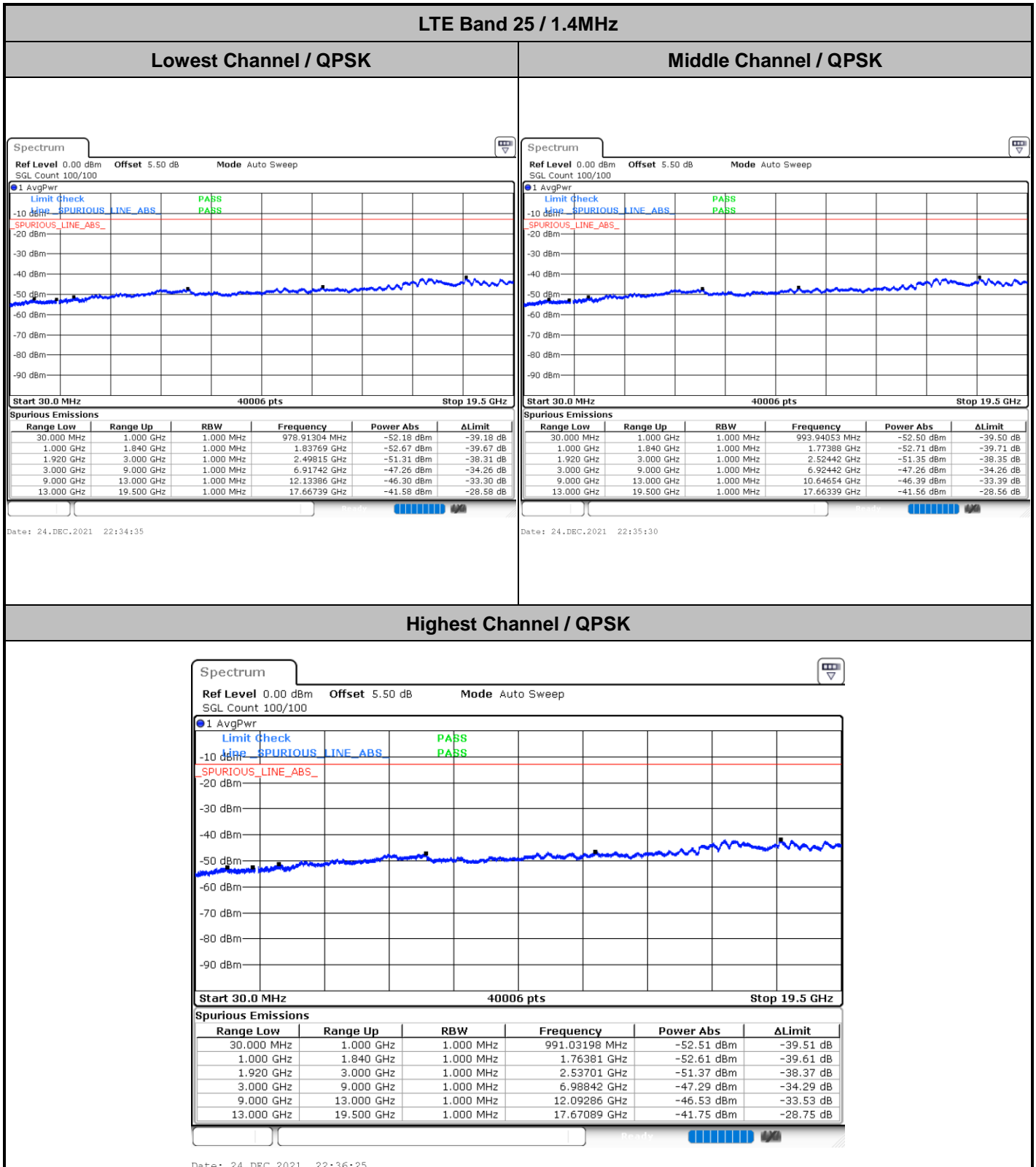



LTE Band 25 / 3MHz

Lowest Channel / QPSK

Middle Channel / QPSK

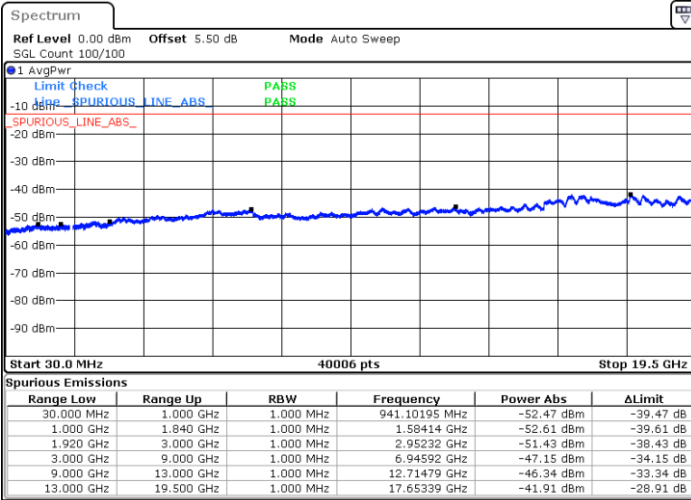

Date: 24.DEC.2021 22:20:51

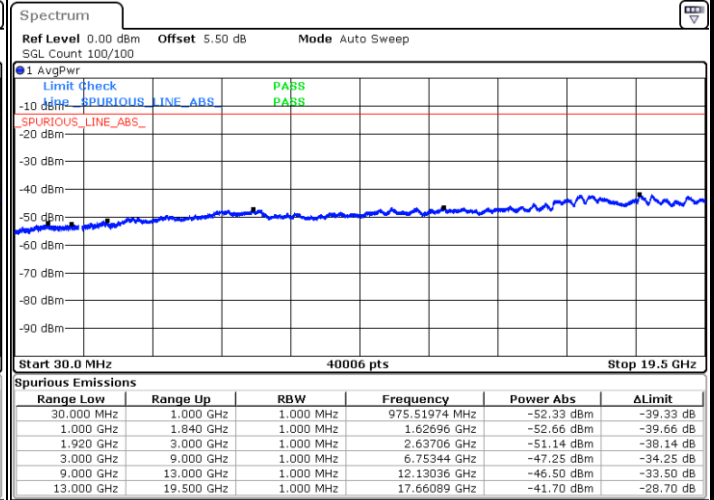

Date: 24.DEC.2021 22:21:46

Highest Channel / QPSK

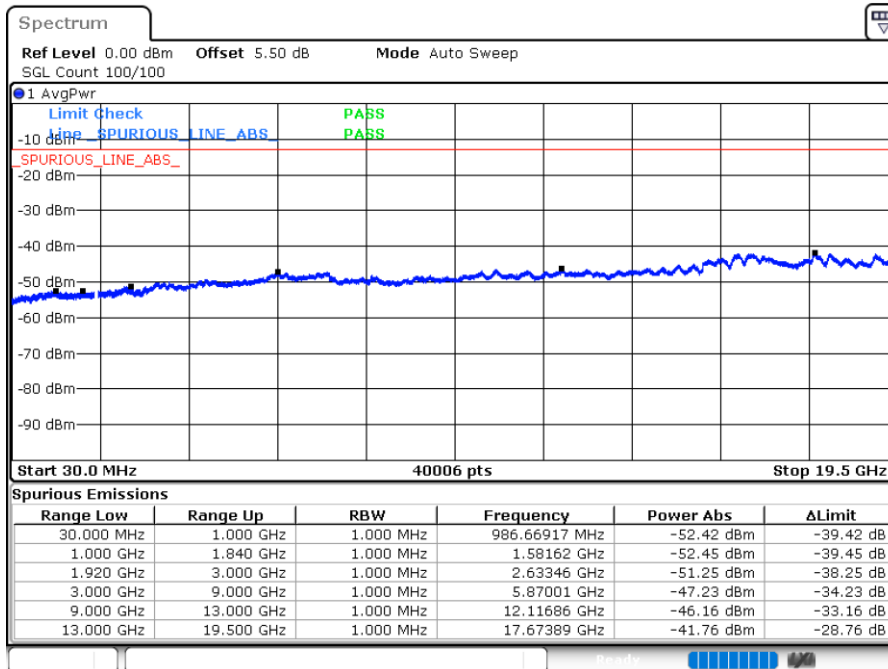

Date: 24.DEC.2021 22:22:41



LTE Band 25 / 5MHz

Lowest Channel / QPSK

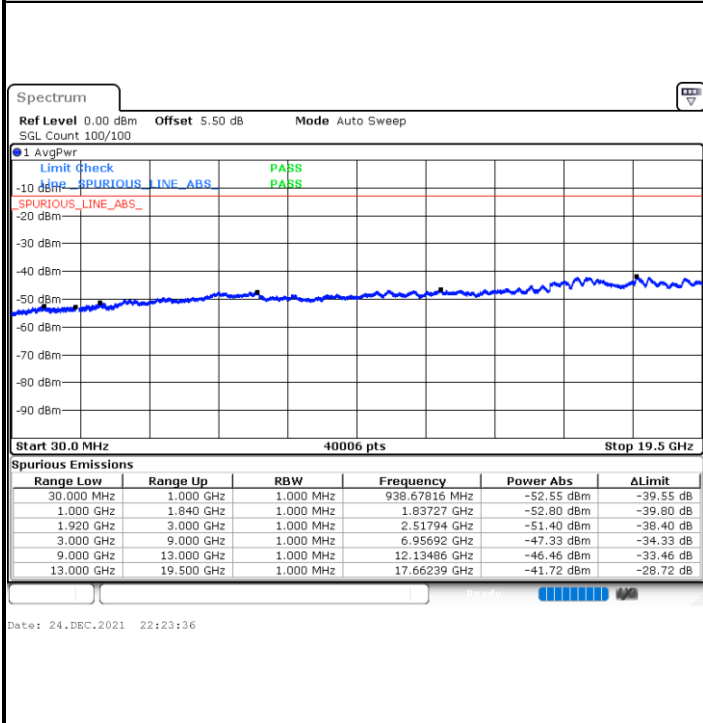

Middle Channel / QPSK

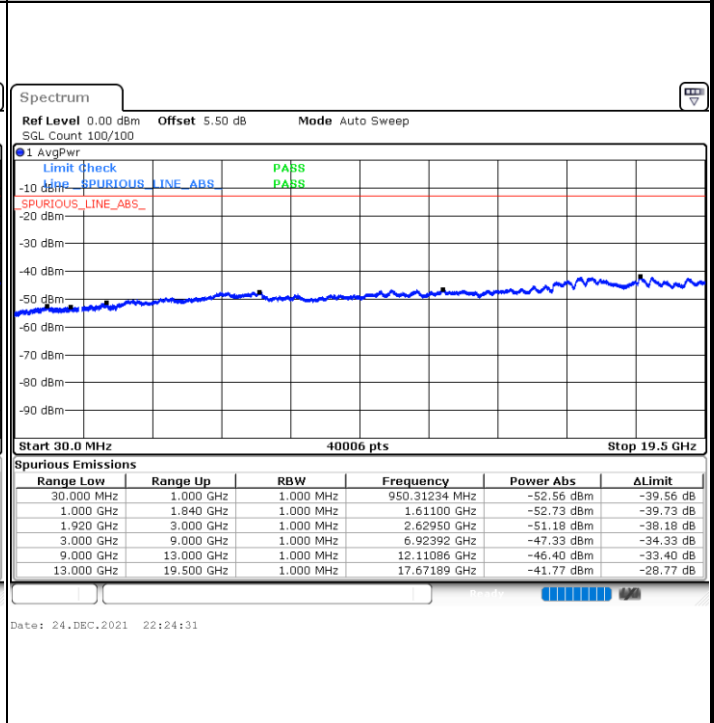

Highest Channel / QPSK

