



# FCC RF Test Report

**APPLICANT** : Motorola Mobility LLC  
**EQUIPMENT** : Mobile Cellular Phone  
**BRAND NAME** : Motorola  
**MODEL NAME** : XT2213-1, XT2213DL, XT2213-2, XT2213-3  
**FCC ID** : IHDT56AA3  
**STANDARD** : 47 CFR Part 2, 96  
**CLASSIFICATION** : Citizens Band End User Devices (CBE)  
**EQUIPMENT TYPE** : End User Equipment  
**TEST DATE(S)** : Dec. 28, 2021 ~ Feb. 11, 2022

We, Sporton International Inc. (Kunshan), would like to declare that the tested sample has been evaluated in accordance with the procedures given in ANSI C63.26 and shown compliance with the applicable technical standards.

The test results in this report apply exclusively to the tested model / sample. Without written approval of Sporton International Inc. (Kunshan), the test report shall not be reproduced except in full.

Reviewed by: Jason Jia / Supervisor

Approved by: Alex Wang / Manager



**Sporton International Inc. (Kunshan)**

**No. 1098, Pengxi North Road, Kunshan Economic Development Zone Jiangsu Province 215300  
People's Republic of China**



# Table of Contents

History of this test report..... 3

Summary of Test Result..... 4

**1 General Description ..... 5**

    1.1 Applicant..... 5

    1.2 Manufacturer ..... 5

    1.3 Feature of Equipment Under Test..... 5

    1.4 Maximum EIRP Power and Emission Designator ..... 6

    1.5 Testing Site..... 6

    1.6 Test Software ..... 7

    1.7 Applied Standards ..... 7

    1.8 Specification of Accessory ..... 7

**2 Test Configuration of Equipment Under Test ..... 8**

    2.1 Test Mode..... 8

    2.2 Connection Diagram of Test System ..... 10

    2.3 Support Unit used in test configuration ..... 10

    2.4 Measurement Results Explanation Example ..... 10

    2.5 Frequency List of Low/Middle/High Channels..... 11

**3 Conducted Test Items ..... 13**

    3.1 Measuring Instruments..... 13

    3.2 Conducted Output Power ..... 14

    3.3 Peak-to-Average Ratio ..... 15

    3.4 EIRP ..... 16

    3.5 Occupied Bandwidth ..... 17

    3.6 Conducted Band Edge ..... 18

    3.7 Conducted Spurious Emission ..... 19

    3.8 Frequency Stability..... 20

**4 Radiated Test Items ..... 21**

    4.1 Measuring Instruments..... 21

    4.2 Test Setup ..... 21

    4.3 Test Result of Radiated Test..... 22

    4.4 Radiated Spurious Emission ..... 23

**5 List of Measuring Equipment..... 24**

**6 Uncertainty of Evaluation ..... 25**

Appendix A. Test Results of Conducted Test

Appendix B. Test Results of Radiated Test

Appendix C. Test Setup Photographs



### History of this test report

Report No.	Version	Description	Issued Date
FG1D1722G	01	Initial issue of report	Feb. 08, 2022



### Summary of Test Result

Report Clause	Ref Std. Clause	Test Items	Result (PASS/FAIL)	Remark
3.2	§2.1046	Conducted Output Power	Reporting only	-
3.3	§96.41	Peak-to-Average Ratio	Pass	Not applicable for End User Devices
3.4	§96.41	Maximum E.I.R.P	Pass	-
		Maximum Power Spectral Density	Pass	Not applicable for End User Devices
3.5	§2.1049 §96.41	Occupied Bandwidth	Reporting only	-
3.6	§2.1051 §96.41	Conducted Band Edge Measurement Adjacent Channel Leakage Ratio	Pass	-
3.7	§2.1051 §96.41	Conducted Spurious Emission	Pass	
3.8	§2.1055	Frequency Stability for Temperature & Voltage	Pass	-
4.4	§2.1051 §96.41	Radiated Spurious Emission	Pass	Under limit 4.27 dB at 7272.000 MHz

**Declaration of Conformity:**  
The test results with all measurement uncertainty excluded are presented in accordance with the regulation limits or requirements declared by manufacturers.

**Comments and Explanations:**  
The declared of product specification for EUT presented in the report are provided by the manufacturer, and the manufacturer takes all the responsibilities for the accuracy of product specification.



# 1 General Description

## 1.1 Applicant

Motorola Mobility LLC  
222 W, Merchandise Mart Plaza, Chicago IL 60654 USA

## 1.2 Manufacturer

Motorola Mobility LLC  
222 W, Merchandise Mart Plaza, Chicago IL 60654 USA

## 1.3 Feature of Equipment Under Test

Product Feature	
Equipment	Mobile Cellular Phone
Brand Name	Motorola
Model Name	XT2213-1, XT2213DL, XT2213-2, XT2213-3
FCC ID	IHDT56AA3
Tx Frequency	LTE Band 48: 3550 MHz ~ 3700 MHz
Rx Frequency	LTE Band 48: 3550 MHz ~ 3700 MHz
Bandwidth	5MHz / 10MHz / 15MHz / 20MHz
Antenna Gain	-3.5 dBi
Type of Modulation	QPSK / 16QAM / 64QAM / 256QAM (Downlink only)
IMEI Code	Conducted: 353739480009600 Radiation: N/A
HW Version	DVT2
SW Version	S1SA32.27
EUT Stage	Identical Prototype

**Remark:**

1. The above EUT's information was declared by manufacturer. Please refer to the specifications or user's manual for more detailed description.
2. The four models XT2213-1, XT2213DL, XT2213-2 and XT2213-3 are only for market differentiation, all the others are the same.



### 1.4 Maximum EIRP Power and Emission Designator

LTE Band 48		QPSK		16QAM/64QAM	
BW (MHz)	Frequency Range (MHz)	Maximum EIRP(W)	Emission Designator (99%OBW)	Maximum EIRP(W)	Emission Designator (99%OBW)
5	3552.5~3697.5	0.0849	4M48G7D	0.0690	4M52W7D
20	3560~3690	0.0826	17M9G7D	0.0681	17M9W7D

LTE Band 48C_CA		QPSK		16QAM/64QAM	
BW (MHz) Frequency (MHz)		Maximum EIRP(W)	Emission Designator (99%OBW)	Maximum EIRP(W)	Emission Designator (99%OBW)
5MHz+20MHz (3553.3 ~ 3690 MHz)		0.0309	23M2G7D	0.0256	23M4W7D
20MHz+20MHz (3560 ~ 3690 MHz)		0.0183	37M9G7D	0.0156	37M5W7D

LTE Band 48B_CA		QPSK		16QAM/64QAM	
BW (MHz) Frequency (MHz)		Maximum EIRP(W)	Emission Designator (99%OBW)	Maximum EIRP(W)	Emission Designator (99%OBW)
10MHz+10MHz (3555 ~ 3695 MHz)		0.0782	18M8G7D	0.0755	18M8W7D

**Note:** According to engineering evaluation, only the maximum bandwidth and the worst test results of PSK & QAM are shown in the report.

### 1.5 Testing Site

Sporton International Inc. (Kunshan) is accredited to ISO/IEC 17025:2017 by American Association for Laboratory Accreditation with Certificate Number 5145.02.

<b>Test Firm</b>	Sporton International Inc. (Kunshan)		
<b>Test Site Location</b>	No. 1098, Pengxi North Road, Kunshan Economic Development Zone Jiangsu Province 215300 People's Republic of China TEL : +86-512-57900158 FAX : +86-512-57900958		
<b>Test Site No.</b>	<b>Sporton Site No.</b>	<b>FCC Designation No.</b>	<b>FCC Test Firm Registration No.</b>
	03CH04-KS TH01-KS	CN1257	314309

## 1.6 Test Software

Item	Site	Manufacturer	Name	Version
1.	03CH04-KS	AUDIX	E3	6.2009-8-24a

## 1.7 Applied Standards

According to the specifications of the manufacturer, the EUT must comply with the requirements of the following standards:

- ♦ ANSI C63.26-2015
- ♦ ANSI / TIA-603-E
- ♦ 47 CFR Part 2, 96
- ♦ FCC KDB 971168 D01 Power Meas. License Digital Systems v03r01
- ♦ FCC KDB 940660 D01 Part 96 CBRS v03
- ♦ FCC KDB 412172 D01 Determining ERP and EIRP v01r01

**Remark:**

1. All test items were verified and recorded according to the standards and without any deviation during the test.
2. This EUT has also been tested and complied with the requirements of FCC Part 15, Subpart B, recorded in a separate test report.

## 1.8 Specification of Accessory

Specification of Accessory				
AC Adapter 1	Brand Name	Motorola(Salcomp)	Model Name	MC-101
AC Adapter 2	Brand Name	Motorola(AOHAI)	Model Name	MC-101
AC Adapter 3	Brand Name	Motorola(Chenyang)	Model Name	MC-101
Battery 1	Brand Name	Motorola(SCUD)	Model Name	JK50
Battery 2	Brand Name	Motorola(ATL)	Model Name	JK50
USB Cable 1	Brand Name	Motorola(Saibao)	Model Name	SC18D22297
USB Cable 2	Brand Name	Motorola(Cabletech)	Model Name	SC18D22298
USB Cable 3	Brand Name	Motorola(Luxshare)	Model Name	SC18D22299



## 2 Test Configuration of Equipment Under Test

### 2.1 Test Mode

Antenna port conducted and radiated test items listed below are performed according to KDB 971168 D01 Power Meas. License Digital Systems v03r01 with maximum output power.

For radiated measurement, pre-scanned in three orthogonal panels, X, Y, Z. The worst cases (Y plane) were recorded in this report.

Test Items	Band	Bandwidth (MHz)						Modulation				RB #			Test Channel		
		1.4	3	5	10	15	20	QPSK	16QAM	64QAM	256QAM	1	Half	Full	L	M	H
Max. Output Power	48	-	-	v	v	v	v	v	v	v	-	v	v	v	v	v	v
Adjacent Channel Leakage Ratio	48	-	-	v	v	v	v	v	v	v	-	v	v	v	v	v	v
26dB and 99% Bandwidth	48	-	-				v	v	v		-			v		v	
Conducted Band Edge	48	-	-	v	v	v	v	v	v	v	-	v	v	v	v	v	v
Conducted Spurious Emission	48	-	-	v	v	v	v	v			-	v			v	v	v
E.R.P / E.I.R.P	48	-	-	v	v	v	v	v	v	v	-	v	v	v	v	v	v
Frequency Stability	48	-	-				v	v			-	v				v	
Radiated Spurious Emission	48	Worst Case														v	





Test Items	Band	Bandwidth (MHz)								Modulation				RB #			Test Channel		
		20+20	20+15	15+20	20+10	10+20	10+10	20+5	5+20	QPSK	16QAM	64QAM	256QAM	1	Half	Full	L	M	H
Max. Output Power	48C	v	v	v	v	v		v	v	v	v	v	-	v		v	v	v	v
	48B						v			v	v	v	-	v		v	v	v	v
26dB and 99% Bandwidth	48C	v								v	v		-			v		v	
	48B						v			v	v		-			v		v	
Conducted Band Edge	48C	v	v	v	v	v		v	v	v	v	v	-	v		v	v	v	v
	48B						v			v	v	v	-	v		v	v	v	v
Conducted Spurious Emission	48C	v	v	v	v	v		v	v	v			-	v			v	v	v
	48B						v			v			-	v			v	v	v
Adjacent Channel Leakage Ratio	48C	v	v	v	v	v		v	v	v	v	v	-	v		v	v	v	v
	48B						v			v	v	v	-	v		v	v	v	v
E.R.P / E.I.R.P	48C	v	v	v	v	v		v	v	v	v	v	-	v		v	v	v	v
	48B						v			v	v	v	-	v		v	v	v	v
Radiated Spurious Emission	48C	Worst Case																v	
	48B	Worst Case																v	
Note	<ol style="list-style-type: none"> <li>The mark "v" means that this configuration is chosen for testing</li> <li>The mark "-" means that this bandwidth is not supported.</li> <li>The device is investigated from 30MHz to 10 times of fundamental signal for radiated spurious emission test under different RB size/offset and modulations in exploratory test. Subsequently, only the worst case emissions are reported.</li> <li>Frequency stability only shows the worst case of LTE Band 48.</li> <li>All test items are based on engineering evaluation.</li> <li>All the radiated test cases were performed with Adapter.</li> <li>The OBW test item assess the worst case of maximum BW, RSE with good margin&gt;6dB thus only test Middle CH.</li> </ol>																		

## 2.2 Connection Diagram of Test System

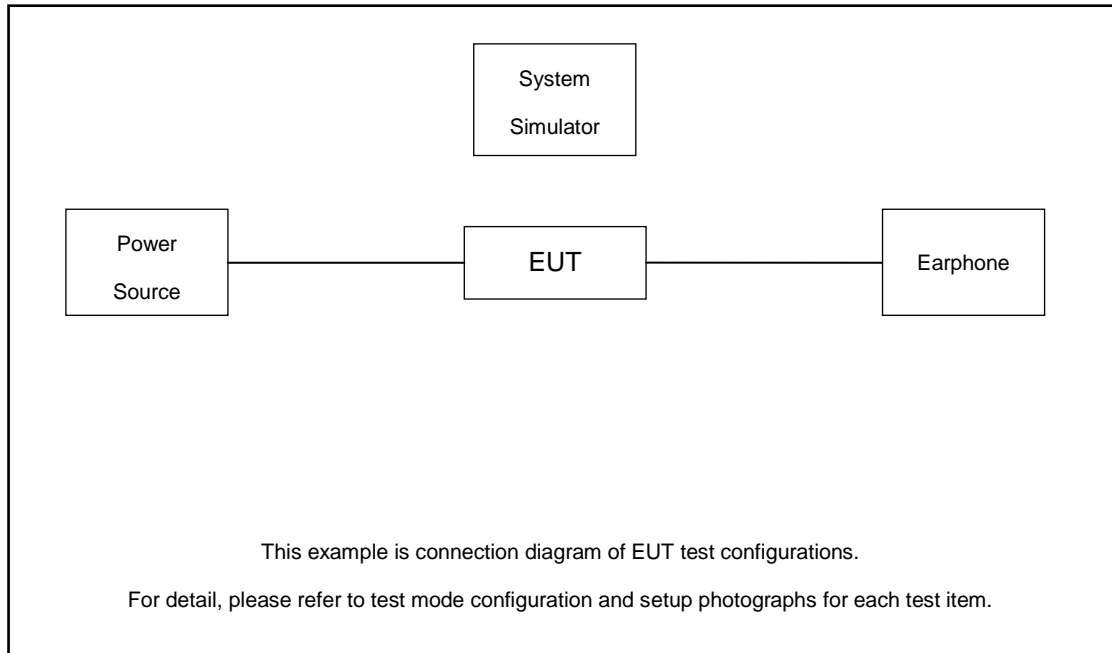

## 2.3 Support Unit used in test configuration

Item	Equipment	Trade Name	Model No.	FCC ID	Data Cable	Power Cord
1.	Power Supply	GWINSTEK	PSS-2002	N/A	N/A	Unshielded, 1.8 m
2.	LTE Base Station	Anritsu	MT8821C	N/A	N/A	Unshielded, 1.8 m
3.	Earphone	N/A	N/A	N/A	N/A	N/A

## 2.4 Measurement Results Explanation Example

### For all conducted test items:

The offset level is set in the spectrum analyzer to compensate the RF cable loss between EUT conducted output port and spectrum analyzer. With the offset compensation, the spectrum analyzer reading level is exactly the EUT RF output level.

The spectrum analyzer offset is derived from RF cable loss.

*Offset = RF cable loss.*

Following shows an offset computation example with cable loss 8.22 dB.

Example :

$$\begin{aligned} \text{Offset(dB)} &= \text{RF cable loss(dB)}. \\ &= 8.22 \text{ (dB)} \end{aligned}$$



### 2.5 Frequency List of Low/Middle/High Channels

LTE Band 48 Channel and Frequency List				
BW [MHz]	Channel/Frequency(MHz)	Lowest	Middle	Highest
20	Channel	55340	55990	56640
	Frequency	3560.0	3625.0	3690.0
15	Channel	55315	55990	56665
	Frequency	3557.5	3625.0	3692.5
10	Channel	55290	55990	56690
	Frequency	3555.0	3625.0	3695.0
5	Channel	55265	55990	56715
	Frequency	3552.5	3625.0	3697.5

LTE Band 48B_CA Channel and Frequency List					
BW [MHz]	Channel/Frequency(MHz)	Lowest	Middle	Highest	
10 + 10	PCC	Channel	55290	56165	56591
		Frequency	3555	3642.5	3685.1
	SCC	Channel	55389	56264	56690
		Frequency	3564.9	3652.4	3695



LTE Band 48C_CA Channel and Frequency List					
BW [MHz]	Channel/Frequency(MHz)		Lowest	Middle	Highest
5 + 20	PCC	Channel	55273	55898	56523
		Frequency	3553.3	3615.8	3678.3
	SCC	Channel	55390	56015	56640
		Frequency	3565	3627.5	3690
20 + 5	PCC	Channel	55340	55965	56590
		Frequency	3560	3622.5	3685
	SCC	Channel	55457	56082	56707
		Frequency	3571.7	3634.2	3696.7
10 + 20	PCC	Channel	55295	55896	56496
		Frequency	3555.5	3615.6	3675.6
	SCC	Channel	55439	56040	56640
		Frequency	3569.9	3630	3690
20 + 10	PCC	Channel	55340	55941	56541
		Frequency	3560	3620.1	3680.1
	SCC	Channel	55484	56085	56685
		Frequency	3574.4	3634.5	3694.5
15 + 20	PCC	Channel	55318	55893	56469
		Frequency	3557.8	3615.3	3672.9
	SCC	Channel	55489	56064	56640
		Frequency	3574.9	3632.4	3690
20 + 15	PCC	Channel	55340	55916	56491
		Frequency	3560	3617.6	3675.1
	SCC	Channel	55511	56087	56662
		Frequency	3577.1	3634.7	3692.2
20 + 20	PCC	Channel	55340	55891	56442
		Frequency	3560	3615.1	3670.2
	SCC	Channel	55538	56089	56640
		Frequency	3579.8	3634.9	3690

### 3 Conducted Test Items

#### 3.1 Measuring Instruments

See list of measuring instruments of this test report.

##### 3.1.1 Test Setup

##### 3.1.2 Conducted Output Power



##### 3.1.3 PSD, Peak-to-Average Ratio, Occupied Bandwidth, Conducted Band-Edge and Conducted Spurious Emission

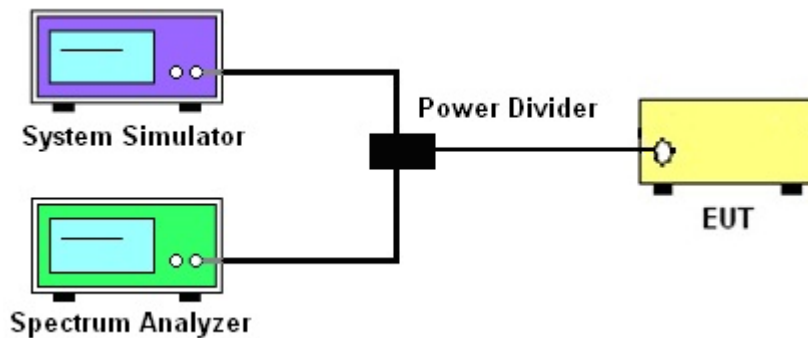

##### 3.1.4 Frequency Stability

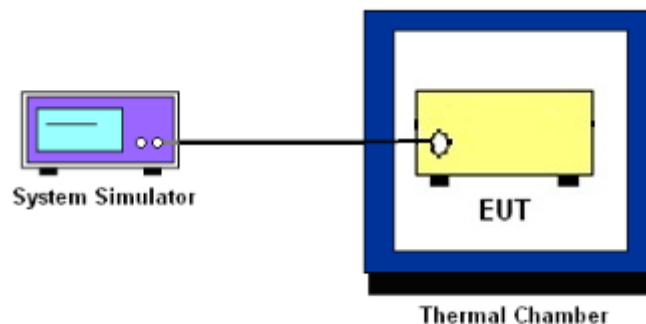

##### 3.1.5 Test Result of Conducted Test

Please refer to Appendix A.



## **3.2 Conducted Output Power**

### **3.2.1 Description of the Conducted Output Power Measurement**

A system simulator was used to establish communication with the EUT. Its parameters were set to force the EUT transmitting at maximum output power. The measured power in the radio frequency on the transmitter output terminals shall be reported.

### **3.2.2 Test Procedures**

1. The transmitter output port was connected to the system simulator.
2. Set EUT at maximum power through the system simulator.
3. Select lowest, middle, and highest channels for each band and different modulation.
4. Measure and record the power level from the system simulator.



### 3.3 Peak-to-Average Ratio

#### 3.3.1 Description of the PAR Measurement

Power Complementary Cumulative Distribution Function (CCDF) curves provide a means for characterizing the power peaks of a digitally modulated signal on a statistical basis. A CCDF curve depicts the probability of the peak signal amplitude exceeding the average power level. Most contemporary measurement instrumentation include the capability to produce CCDF curves for an input signal provided that the instrument's resolution bandwidth can be set wide enough to accommodate the entire input signal bandwidth. In measuring transmissions in this band using an average power technique, the peak-to-average ratio (PAR) of the transmission may not exceed 13 dB.

#### 3.3.2 Test Procedures

The testing follows ANSI C63.26-2015 Section 5.2.6

1. The EUT was connected to spectrum and system simulator via a power divider.
2. Set the CCDF (Complementary Cumulative Distribution Function) option in spectrum analyzer.
3. The highest RF powers were measured and recorded the maximum PAPR level associated with a probability of 0.1 %.
4. Record the deviation as Peak to Average Ratio

### 3.4 EIRP

#### 3.4.1 Description of the EIRP Measurement

EIRP limits for CBRS equipment as below table:

Device		Maximum EIRP (dBm/10 MHz)	Maximum PSD (dBm/MHz)
Applied	End User Device	23	N/A
<input type="checkbox"/>	Category A CBSD	30	20
<input type="checkbox"/>	Category B CBSD	47	37

**Remark:** The worst case EIRP shown in this section is found with LTE operating only using 1RB. As such, the EIRP/10MHz and full channel EIRP values will be identical since 1RB is fully contained within all available channel bandwidths for LTE Band 48 (i.e. 5, 10, 15, 20MHz)

#### 3.4.2 Test Procedures for EIRP

1. Establishing a communications link with the call box (Base station) to measure the Maximum conducted power, the parameters were set to force the EUT transmitting at maximum output power level. Use the average power measurement function to measure total channel power of each channel bandwidth (per ANSI C63.26-2015 Section 5.2.1)
2. Determining ERP and/or EIRP from conducted RF output power measurements (Per ANSI C63.26-2015 Section 5.2.5.5)
  - EIRP =  $P_T + G_T - L_C$ , ERP = EIRP - 2.15, where
  - $P_T$  = transmitter output power in dBm
  - $G_T$  = gain of the transmitting antenna in dBi
  - $L_C$  = signal attenuation in the connecting cable between the transmitter and antenna in dB





### 3.5 Occupied Bandwidth

#### 3.5.1 Description of Occupied Bandwidth Measurement

The occupied bandwidth is the width of a frequency band such that, below the lower and above the upper frequency limits, the mean powers emitted are each equal to a specified percentage 0.5% of the total mean transmitted power.

The 26 dB emission bandwidth is defined as the frequency range between two points, one above and one below the carrier frequency, at which the spectral density of the emission is attenuated 26 dB below the maximum in-band spectral density of the modulated signal. Spectral density (power per unit bandwidth) is to be measured with a detector of resolution bandwidth equal to approximately 1.0% of the emission bandwidth.

#### 3.5.2 Test Procedures

The testing follows ANSI C63.26-2015 Section 5.4.3 (26dB) and Section 5.4.4 (99OB)

1. The EUT was connected to spectrum analyzer and system simulator via a power divider.
2. The spectrum analyzer center frequency is set to the nominal EUT channel center frequency. The span range for the spectrum analyzer shall be between two and five times the anticipated OBW.
3. The nominal resolution bandwidth (RBW) shall be in the range of 1 to 5 % of the anticipated OBW, and the VBW shall be at least 3 times the RBW.
4. Set the detection mode to peak, and the trace mode to max hold.
5. Determine the reference value: Set the EUT to transmit a modulated signal. Allow the trace to stabilize. Set the spectrum analyzer marker to the highest level of the displayed trace.  
(this is the reference value)
6. Determine the “-26 dB down amplitude” as equal to (Reference Value – X).
7. Place two markers, one at the lowest and the other at the highest frequency of the envelope of the spectral display such that each marker is at or slightly below the “-X dB down amplitude” determined in step 6. If a marker is below this “-X dB down amplitude” value it shall be placed as close as possible to this value. The OBW is the positive frequency difference between the two markers.
8. Use the 99 % power bandwidth function of the spectrum analyzer and report the measured bandwidth.

## 3.6 Conducted Band Edge

### 3.6.1 Description of Conducted Band Edge Measurement

Part 96.41 (e) (1) (i)

For CBSD the emission limits outside the fundamental are as follows:

Within 0 MHz to 10 MHz above and below the assigned channel  $\leq -13$  dBm/MHz

Greater than 10 MHz above and below the assigned channel  $\leq -25$  dBm/MHz

Part 96.41 (e) (1) (ii)

For End User Devices the emission limits outside the fundamental are as follows:

Within 0 MHz to B MHz above and below the assigned channel  $\leq -13$  dBm/MHz

Greater than B MHz above and below the assigned channel  $\leq -25$  dBm/MHz

where B is the bandwidth in megahertz of the assigned channel or multiple contiguous channels of the End User Device.

Notwithstanding the emission limits in this paragraph, the Adjacent Channel Leakage Ratio for End User Devices shall be at least 30 dB.

Part 96.41 (e) (2)

For CBSDs and End User Devices, the conducted power of emissions below 3540 MHz or above 3710 MHz shall not exceed  $-25$  dBm/MHz, and the conducted power of emissions below 3530 MHz or above 3720 MHz shall not exceed  $-40$ dBm/MHz

### 3.6.2 Test Procedures

The testing follows FCC KDB 971168 D01 v03r01 Section 6.1.

1. The EUT was connected to spectrum analyzer and system simulator via a power divider.
2. The band edges of low and high channels for the highest RF powers were measured.
3. Set RBW  $\geq 1\%$  EBW in the 1MHz band immediately outside and adjacent to the band edge.
4. Beyond the 1 MHz band from the band edge, RBW=1MHz was used
5. Offset has included the duty factor for LTE Band 48. Duty factor  $=10 \log (1/x)$ , where x is the measured duty cycle.
6. Set spectrum analyzer with RMS detector.
7. The RF fundamental frequency should be excluded against the limit line in the operating frequency band.



### 3.7 Conducted Spurious Emission

#### 3.7.1 Description of Conducted Spurious Emission Measurement

96.41 (e)(2)

The conducted power of any emissions below 3530 MHz or above 3720 MHz shall not exceed -40dBm/MHz.

#### 3.7.2 Test Procedures

The testing follows FCC KDB 971168 D01 v03r01 Section 6.1.

1. The EUT was connected to spectrum analyzer and system simulator via a power divider.
2. The RF output of EUT was connected to the spectrum analyzer by RF cable and attenuator. The path loss was compensated to the results for each measurement.
3. The middle channel for the highest RF power within the transmitting frequency was measured.
4. The conducted spurious emission for the whole frequency range was taken.
5. Make the measurement with the spectrum analyzer's RBW = 1MHz, VBW = 3MHz.
6. Set spectrum analyzer with RMS detector.
7. Taking the record of maximum spurious emission.
8. The RF fundamental frequency should be excluded against the limit line in the operating frequency band.
9. The limit line is -40dBm/MHz.



### 3.8 Frequency Stability

#### 3.8.1 Description of Frequency Stability Measurement

The frequency stability shall be measured by variation of ambient temperature and variation of primary supply voltage to ensure that the fundamental emission stays within the authorized frequency block. The frequency stability of the transmitter shall be maintained within  $\pm 0.00025\%$  ( $\pm 2.5\text{ppm}$ ) of the center frequency

#### 3.8.2 Test Procedures for Temperature Variation

The testing follows FCC KDB 971168 D01 v03r01 Section 9.0.

1. The EUT was set up in the thermal chamber and connected with the system simulator.
2. With power OFF, the temperature was decreased to  $-30^{\circ}\text{C}$  and the EUT was stabilized before testing. Power was applied and the maximum change in frequency was recorded within one minute.
3. With power OFF, the temperature was raised in  $10^{\circ}\text{C}$  step up to  $50^{\circ}\text{C}$ . The EUT was stabilized at each step for at least half an hour. Power was applied and the maximum frequency change was recorded within one minute.

#### 3.8.3 Test Procedures for Voltage Variation

The testing follows FCC KDB 971168 D01 v03r01 Section 9.0.

1. The EUT was placed in a temperature chamber at  $25\pm 5^{\circ}\text{C}$  and connected with the system simulator.
2. The power supply voltage to the EUT was varied from 85% to 115% of the nominal value measured at the input to the EUT.
3. The variation in frequency was measured for the worst case.

## 4 Radiated Test Items

### 4.1 Measuring Instruments

See list of measuring instruments of this test report.

### 4.2 Test Setup

#### 4.2.1 For radiated test below 30MHz

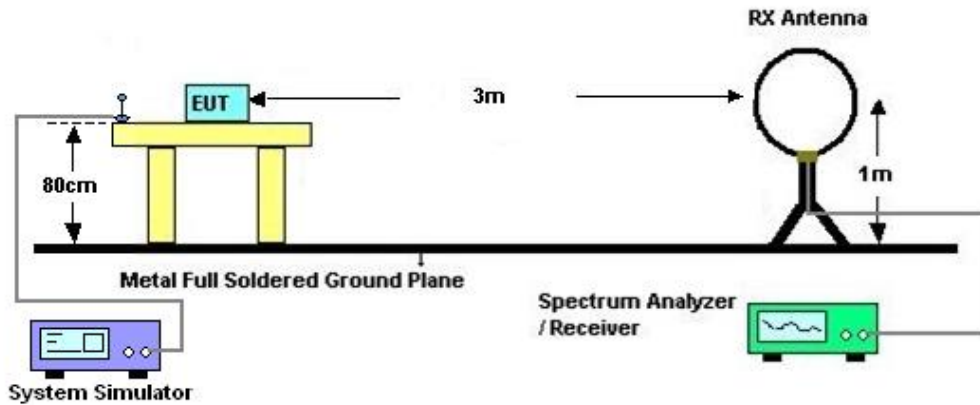

#### 4.2.2 For radiated test from 30MHz to 1GHz

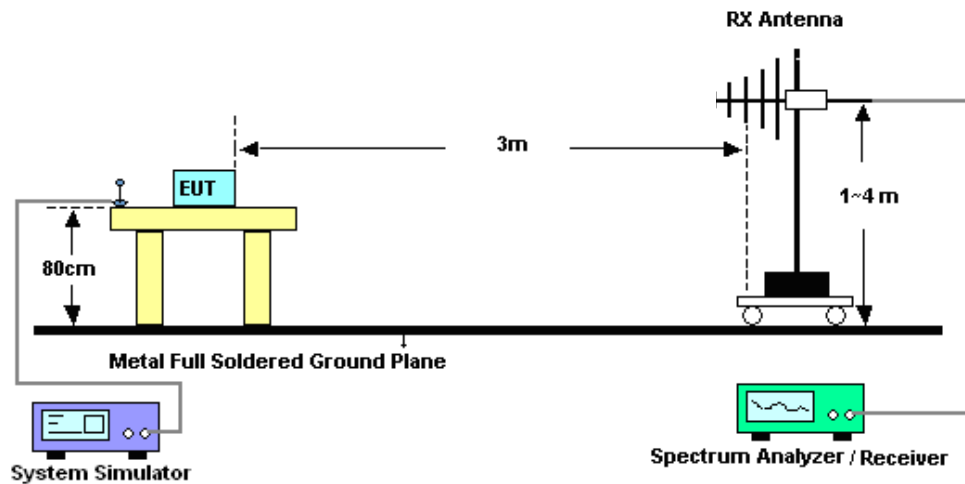

### 4.2.3 For radiated test above 1GHz

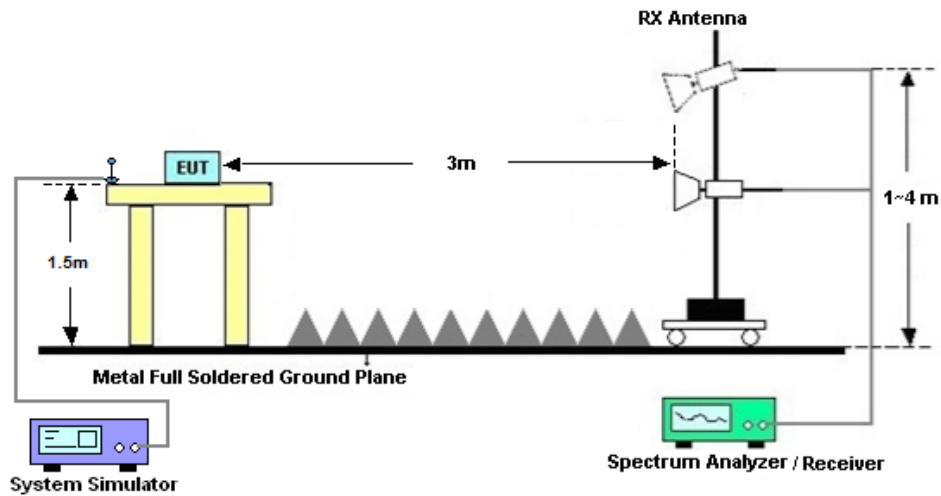

### 4.3 Test Result of Radiated Test

The low frequency, which started from 9 kHz to 30MHz, was pre-scanned and the result which was 20dB lower than the limit line was not reported.

Please refer to Appendix B.



## 4.4 Radiated Spurious Emission

### 4.4.1 Description of Radiated Spurious Emission Measurement

The radiated spurious emission was measured by substitution method according to ANSI / TIA-603-E. The power of any emission outside of the authorized operating frequency ranges must be attenuated below the transmitter power (P) by a factor of at least -40dBm / MHz. The spectrum is scanned from 30 MHz up to a frequency including its 10th harmonic.

### 4.4.2 Test Procedures

1. The EUT was placed on a turntable with 0.8 meter height for frequency below 1GHz and 1.5 meter height for frequency above 1GHz respectively above ground.
2. The EUT was set 3 meters from the receiving antenna mounted on the antenna tower.
3. The table was rotated 360 degrees to determine the position of the highest spurious emission.
4. The height of the receiving antenna is varied between 1m to 4m to search the maximum spurious emission for both horizontal and vertical polarizations.
5. During the measurement, the system simulator parameters were set to force the EUT transmitting at maximum output power.
6. Make the measurement with the spectrum analyzer's RBW = 1MHz, VBW = 3MHz, taking the record of maximum spurious emission.
7. A horn antenna was substituted in place of the EUT and was driven by a signal generator. Tune the output power of signal generator to the same emission level with EUT maximum spurious emission.  
$$\text{EIRP (dBm)} = \text{S.G. Power} - \text{Tx Cable Loss} + \text{Tx Antenna Gain}$$
$$\text{ERP (dBm)} = \text{EIRP} - 2.15$$
8. The RF fundamental frequency should be excluded against the limit line in the operating frequency band.  
The limit line is -40dBm/MHz



## 5 List of Measuring Equipment

Instrument	Manufacturer	Model No.	Serial No.	Characteristics	Calibration Date	Test Date	Due Date	Remark
Spectrum Analyzer	R&S	FSV40	101040	10Hz~40GHz	Oct. 14, 2021	Dec. 28, 2021~ Feb. 11, 2022	Oct. 13, 2022	Conducted (TH01-KS)
Power divider	STI	STI08-0055	-	0.5~40GHz	Aug. 26, 2021	Dec. 28, 2021~ Feb. 11, 2022	Aug. 25, 2022	Conducted (TH01-KS)
Temperature & humidity chamber	Hongzhan	LP-150U	H2014011440	-40~+150°C 20%~95%RH	Jul. 12, 2021	Dec. 28, 2021~ Feb. 11, 2022	Jul. 11, 2022	Conducted (TH01-KS)
EXA Spectrum Analyzer	Keysight	N9010A	MY55150244	10Hz-44G,MAX 30dB	Apr. 13, 2021	Jan. 20, 2022~ Jan. 23, 2022	Apr. 12, 2022	Radiation (03CH04-KS)
Loop Antenna	R&S	HFH2-Z2	100321	9kHz~30MHz	Oct. 30, 2021	Jan. 20, 2022~ Jan. 23, 2022	Oct. 29, 2022	Radiation (03CH04-KS)
Bilog Antenna	TeseQ	CBL6111D	49922	30MHz-1GHz	May 30, 2021	Jan. 20, 2022~ Jan. 23, 2022	May 29, 2022	Radiation (03CH04-KS)
Horn Antenna	Schwarzbeck	BBHA9120D	1356	1GHz~18GHz	Apr. 18, 2021	Jan. 20, 2022~ Jan. 23, 2022	Apr. 17, 2022	Radiation (03CH04-KS)
SHF-EHF Horn	Com-power	AH-840	101115	18GHz~40GHz	Jan. 05, 2022	Jan. 20, 2022~ Jan. 23, 2022	Jan. 04, 2023	Radiation (03CH04-KS)
Amplifier	SONOMA	310N	187289	9KHz-1GHz	Jan. 05, 2022	Jan. 20, 2022~ Jan. 23, 2022	Jan. 04, 2023	Radiation (03CH04-KS)
high gain Amplifier	MITEQ	AMF-7D-0010 1800-30-10P	2025788	1Ghz-18Ghz	Jul. 30, 2021	Jan. 20, 2022~ Jan. 23, 2022	Jul. 29, 2022	Radiation (03CH04-KS)
Amplifier	Keysight	83017A	MY57280106	500MHz~26.5G Hz	Oct. 13, 2021	Jan. 20, 2022~ Jan. 23, 2022	Oct. 12, 2022	Radiation (03CH04-KS)
Amplifier	MITEQ	EM18G40GG A	060728	18~40GHz	Jan. 05, 2022	Jan. 20, 2022~ Jan. 23, 2022	Jan. 04, 2023	Radiation (03CH04-KS)
AC Power Source	Chroma	61601	F1040900 04	N/A	NCR	Jan. 20, 2022~ Jan. 23, 2022	NCR	Radiation (03CH04-KS)
Turn Table	ChamPro	EM 1000-T	060762-T	0~360 degree	NCR	Jan. 20, 2022~ Jan. 23, 2022	NCR	Radiation (03CH04-KS)
Antenna Mast	ChamPro	EM 1000-A	060762-A	1 m~4 m	NCR	Jan. 20, 2022~ Jan. 23, 2022	NCR	Radiation (03CH04-KS)

NCR: No Calibration Required





## 6 Uncertainty of Evaluation

### Uncertainty of Radiated Emission Measurement (30 MHz ~ 1000 MHz)

Measuring Uncertainty for a Level of Confidence of 95% (U = 2Uc(y))	3.3dB
---	-------

### Uncertainty of Radiated Emission Measurement (1 GHz ~ 18 GHz)

Measuring Uncertainty for a Level of Confidence of 95% (U = 2Uc(y))	2.8dB
---	-------

### Uncertainty of Radiated Emission Measurement (18 GHz ~ 40 GHz)

Measuring Uncertainty for a Level of Confidence of 95% (U = 2Uc(y))	2.8dB
---	-------

----- THE END -----



## Appendix A. Test Results of Conducted Test

Test Engineer :	Simle Wang	Temperature :	22~23°C
		Relative Humidity :	40~42%

### Conducted Output Power(Average power) and EIRP

LTE Band 48:

Mode	LTE Band 48 : EIRP (dBm/10MHz)							
BW	5MHz 1RB0				10MHz 1RB0			
Mod.	QPSK	16QAM	64QPSK		QPSK	16QAM	64QPSK	
Lowest CH	18.88	18.28	17.33		18.94	18.06	17.38	
Middle CH	19.28	18.39	17.38		19.20	18.28	17.17	
Highest CH	19.08	18.39	17.31		19.20	18.34	17.39	
BW	15MHz 1RB0				20MHz1RB0			
Mod.	QPSK	16QAM	64QAM		QPSK	16QAM	64QAM	
Lowest CH	18.77	18.03	17.06		18.67	18.02	16.72	
Middle CH	19.17	18.20	16.97		19.17	18.05	16.88	
Highest CH	19.10	18.22	17.41		19.12	18.13	16.88	
Limit	23dBm /10MHz							
Result	Pass							

Mode	LTE Band 48 : EIRP (dBm/10MHz)							
BW	5MHz 1RB MAX				10MHz 1RB MAX			
Mod.	QPSK	16QAM	64QPSK		QPSK	16QAM	64QPSK	
Lowest CH	19.28	18.08	17.00		19.04	18.20	17.01	
Middle CH	19.06	18.15	17.40		19.22	18.14	17.32	
Highest CH	19.29	18.38	17.33		19.24	18.30	17.26	
BW	15MHz 1RB MAX				20MHz1RB MAX			
Mod.	QPSK	16QAM	64QAM		QPSK	16QAM	64QAM	
Lowest CH	19.13	18.16	17.09		18.92	17.97	17.44	
Middle CH	18.97	17.96	17.07		18.98	18.19	17.15	
Highest CH	19.12	18.20	17.41		18.97	18.33	16.76	
Limit	23dBm /10MHz							
Result	Pass							



Mode	LTE Band 48 : EIRP (dBm/10MHz)							
BW	5MHz Full RB				10MHz Full RB			
Mod.	QPSK	16QAM	64QPSK		QPSK	16QAM	64QPSK	
Lowest CH	17.71	16.98	15.93		17.15	15.99	15.22	
Middle CH	17.83	16.74	16.07		17.22	16.22	15.41	
Highest CH	17.97	16.87	15.81		17.22	16.23	15.20	
BW	15MHz Full RB				20MHz Full RB			
Mod.	QPSK	16QAM	64QAM		QPSK	16QAM	64QAM	
Lowest CH	16.21	15.14	14.23		15.56	14.17	13.24	
Middle CH	16.19	15.60	14.40		15.36	14.44	13.44	
Highest CH	16.22	15.52	14.66		15.59	14.78	13.76	
Limit	23dBm /10MHz							
Result	Pass							



LTE Band 48C:

LTE Band 48C : EIRP (dBm/10MHz) Full RB0									
BW	5MHz+20MHz			10M+20M			15M+20M		
Mod.	QPSK	16QAM	64QAM	QPSK	16QAM	64QAM	QPSK	16QAM	64QAM
Lowest CH	14.33	13.08	12.98	7.85	6.99	6.79	7.03	6.00	6.09
Middle CH	14.27	13.44	13.07	8.00	7.02	7.14	6.95	5.81	6.17
Highest CH	14.90	14.08	14.01	8.35	7.26	7.4	7.36	6.16	6.33
Limit	23dBm /10MHz								
Result	Pass								
LTE Band 48C : EIRP (dBm/10MHz) Full RB0									
BW	20M+5M			20M+10M			20M+15M		
Mod.	QPSK	16QAM	64QAM	QPSK	16QAM	64QAM	QPSK	16QAM	64QAM
Lowest CH	13.73	12.79	12.86	6.40	5.54	5.44	6.37	4.96	4.90
Middle CH	13.41	12.74	12.71	6.79	5.70	5.85	5.95	5.14	5.30
Highest CH	13.63	12.69	12.41	6.47	5.82	5.62	6.58	5.31	5.41
Limit	23dBm /10MHz								
Result	Pass								
LTE Band 48C : EIRP (dBm/10MHz) Full RB0									
BW	20M+20M								
Mod.	QPSK	16QAM	64QAM						
Lowest CH	11.84	10.73	11.04						
Middle CH	12.19	11.06	10.97						
Highest CH	12.30	11.23	11.09						
Limit	23dBm /10MHz								
Result	Pass								

LTE Band 48C : EIRP (dBm/10MHz) 1RB MAX 1RB0									
BW	5MHz+20MHz			10M+20M			15M+20M		
Mod.	QPSK	16QAM	64QAM	QPSK	16QAM	64QAM	QPSK	16QAM	64QAM
Lowest CH	12.32	11.41	9.22	12.07	11.60	9.60	12.26	11.69	9.95
Middle CH	12.33	11.61	9.70	12.65	11.77	10.14	12.27	11.90	9.82
Highest CH	12.26	11.81	10.12	12.10	11.75	9.53	12.69	11.85	9.82
Limit	23dBm /10MHz								
Result	Pass								
LTE Band 48C : EIRP (dBm/10MHz) 1RB MAX 1RB0									
BW	20M+5M			20M+10M			20M+15M		
Mod.	QPSK	16QAM	64QAM	QPSK	16QAM	64QAM	QPSK	16QAM	64QAM
Lowest CH	12.36	11.64	9.34	12.46	11.74	9.47	12.39	11.81	9.94



Middle CH	12.29	11.54	9.68	12.65	11.67	9.80	12.38	11.91	9.54
Highest CH	12.30	11.47	10.01	12.82	11.92	9.81	12.78	11.89	9.87
Limit	23dBm /10MHz								
Result	Pass								
Mode	LTE Band 48C : EIRP (dBm/10MHz) 1RB MAX 1RB0								
BW	20M+20M								
Mod.	QPSK	16QAM	64QAM						
Lowest CH	12.53	11.59	9.16						
Middle CH	12.26	11.42	10.08						
Highest CH	12.63	11.94	9.51						
Limit	23dBm /10MHz								
Result	Pass								

Mode	LTE Band 48C : EIRP (dBm/10MHz) 1RB0 1RB MAX								
BW	5MHz+20MHz			10M+20M			15M+20M		
Mod.	QPSK	16QAM	64QAM	QPSK	16QAM	64QAM	QPSK	16QAM	64QAM
Lowest CH	0.74	0.93	0.80	1.48	1.84	1.97	1.73	1.72	1.78
Middle CH	1.57	2.17	1.63	1.34	2.21	2.10	1.82	2.36	2.23
Highest CH	1.80	1.98	1.75	2.16	2.34	2.09	2.32	2.62	2.15
Limit	23dBm /10MHz								
Result	Pass								

Mode	LTE Band 48C : EIRP (dBm/10MHz) 1RB0 1RB MAX								
BW	20M+5M			20M+10M			20M+15M		
Mod.	QPSK	16QAM	64QAM	QPSK	16QAM	64QAM	QPSK	16QAM	64QAM
Lowest CH	1.51	1.83	1.84	1.77	1.86	1.82	1.26	1.68	1.59
Middle CH	1.39	1.66	1.35	1.68	2.24	2.29	1.66	1.92	1.73
Highest CH	1.53	2.34	2.29	2.03	2.20	2.11	1.97	2.21	2.13
Limit	23dBm /10MHz								
Result	Pass								

Mode	LTE Band 48C : EIRP (dBm/10MHz) 1RB0 1RB MAX								
BW	20M+20M								
Mod.	QPSK	16QAM	64QAM						
Lowest CH	1.06	1.12	1.64						
Middle CH	1.47	2.10	1.75						
Highest CH	1.95	2.07	2.14						
Limit	23dBm /10MHz								
Result	Pass								



LTE Band 48B:

Mode	LTE Band 48B : EIRP (dBm/10MHz)							
BW	10M+10M Full RB0				10M+10M 1RB MAX 1RB0			
Mod.	QPSK	16QAM	64QPSK		QPSK	16QAM	64QPSK	
Lowest CH	14.58	13.65	13.82		18.93	17.98	15.94	
Middle CH	14.32	13.28	13.40		18.41	18.78	15.74	
Highest CH	14.85	13.72	13.01		18.72	17.86	15.72	
BW	10M+10M 1RB0 1RB MAX							
Mod.	QPSK	16QAM	64QAM					
Lowest CH	7.65	8.19	7.97					
Middle CH	7.87	8.05	7.72					
Highest CH	7.77	8.25	7.87					
Limit	23dBm /10MHz							
Result	Pass							



# LTE Band 48

## ACLR

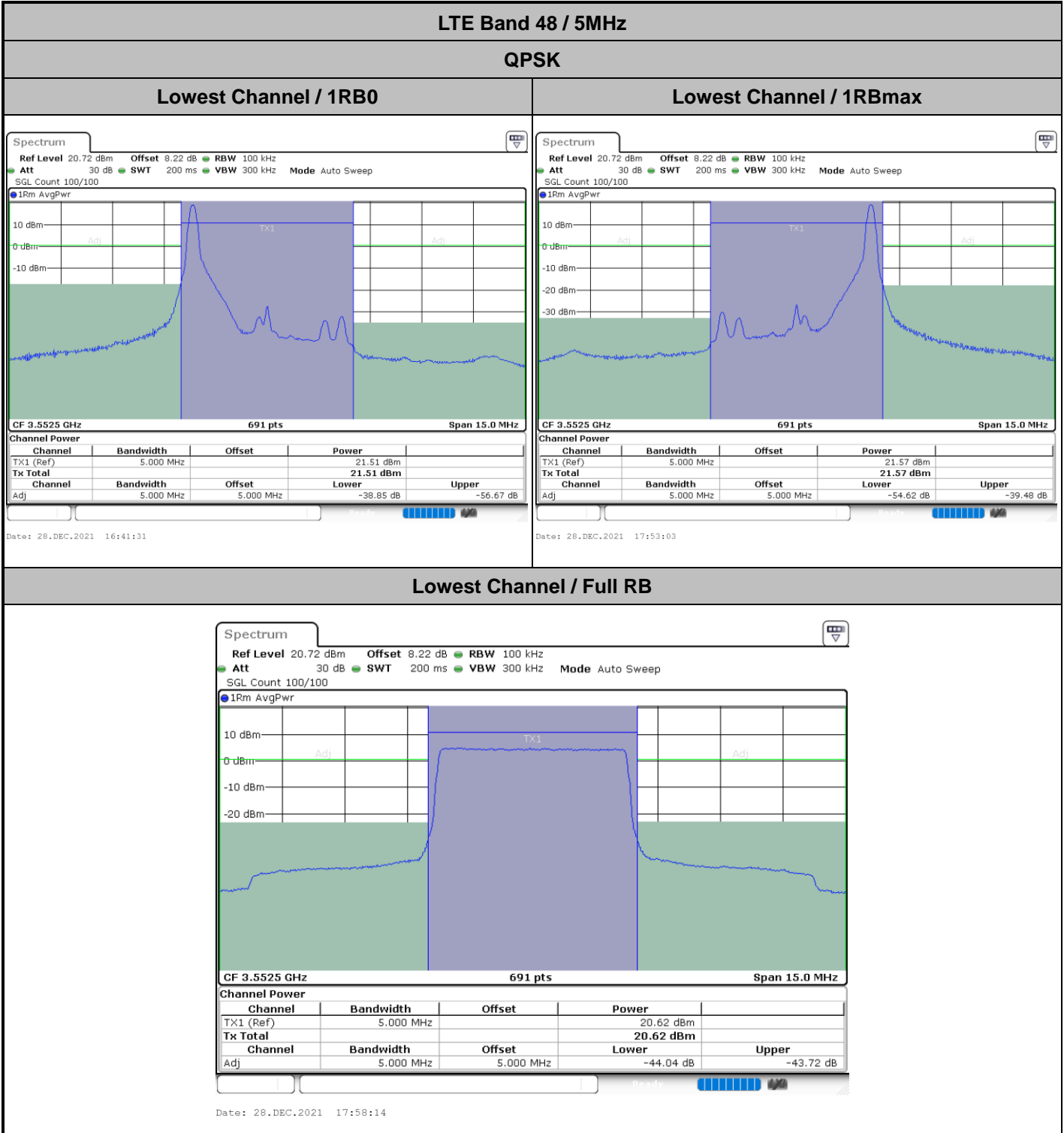



**LTE Band 48 / 5MHz**

**QPSK**

**Middle Channel / 1RB0**

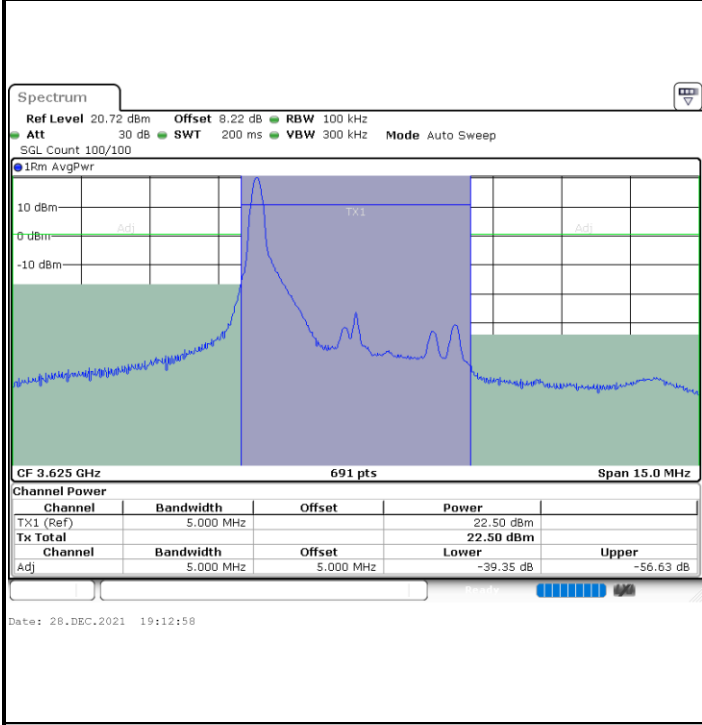

**Middle Channel / 1RBmax**

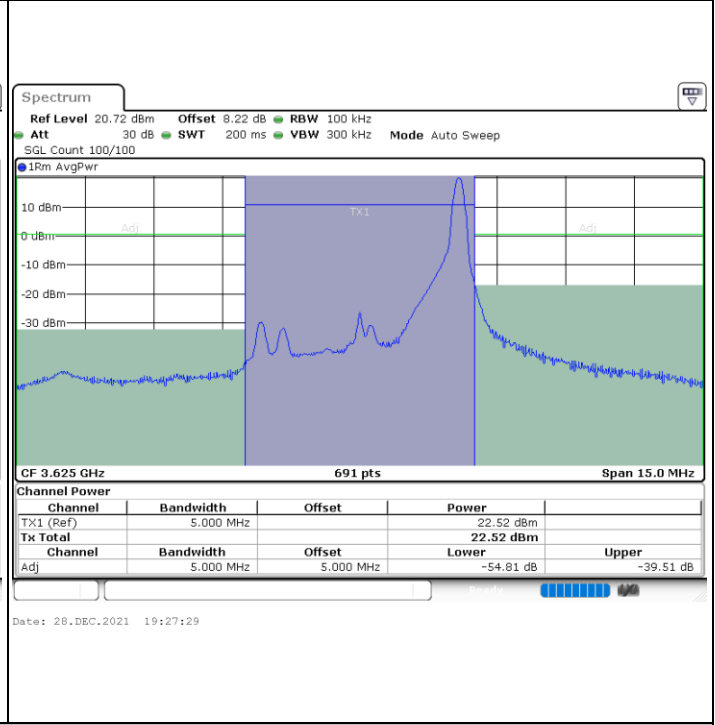

**Middle Channel / FullRB**

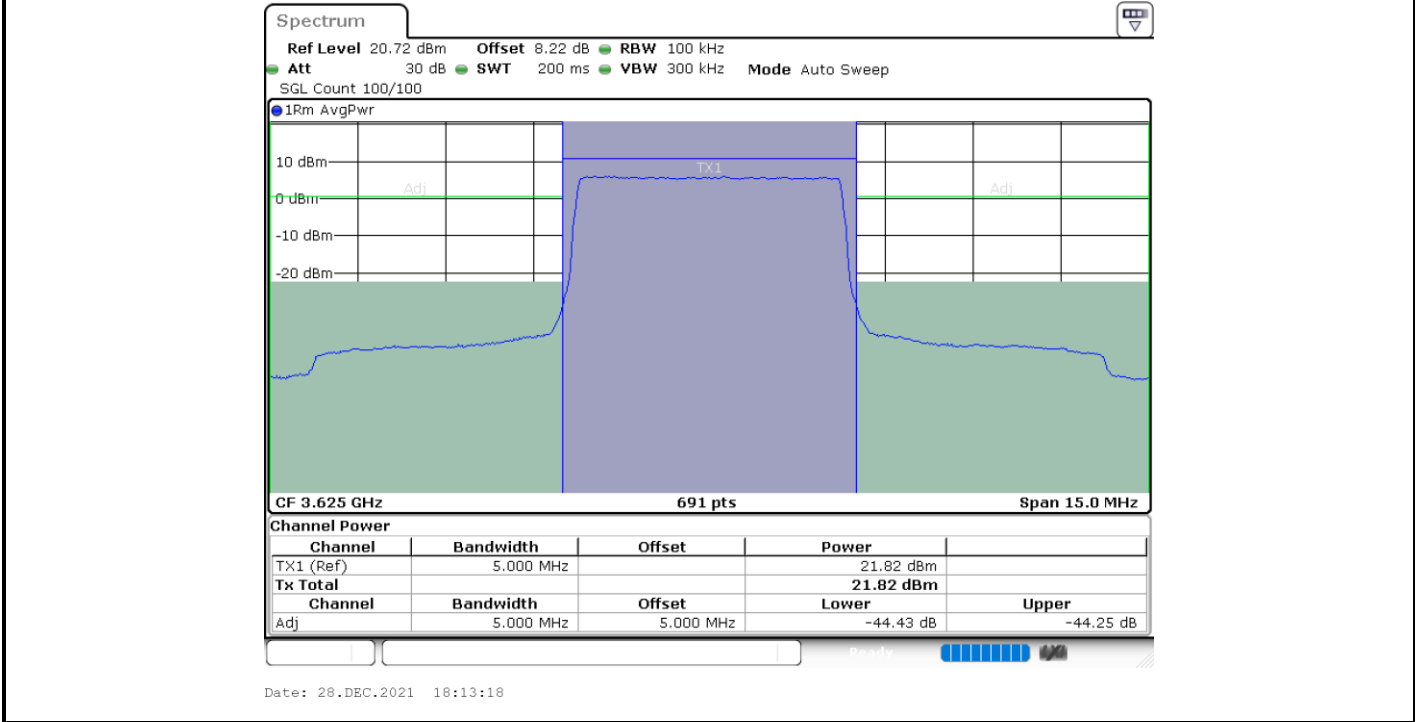





LTE Band 48 / 5MHz

QPSK

Highest Channel / 1RB0

Highest Channel / 1RBmax

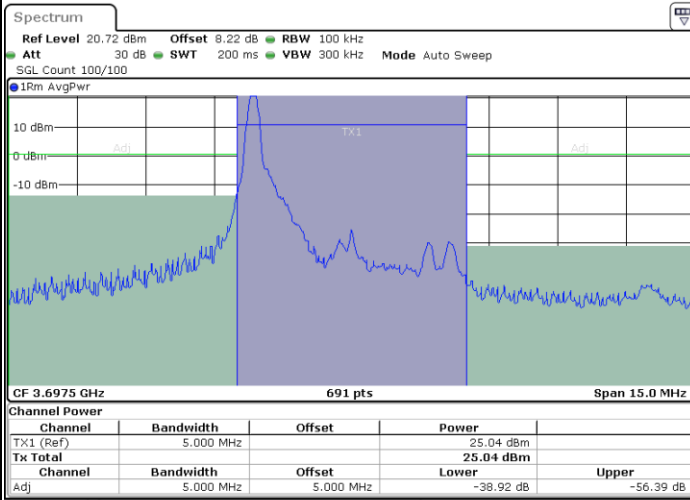

Date: 28.DEC.2021 20:23:57

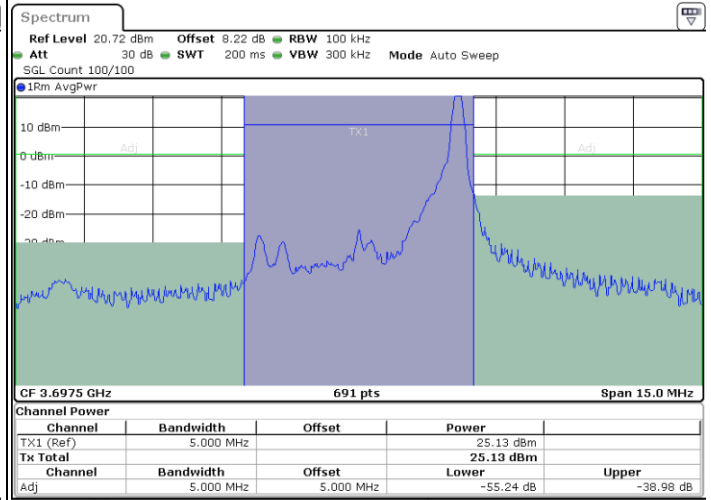

Date: 28.DEC.2021 20:49:13

Highest Channel / FullRB

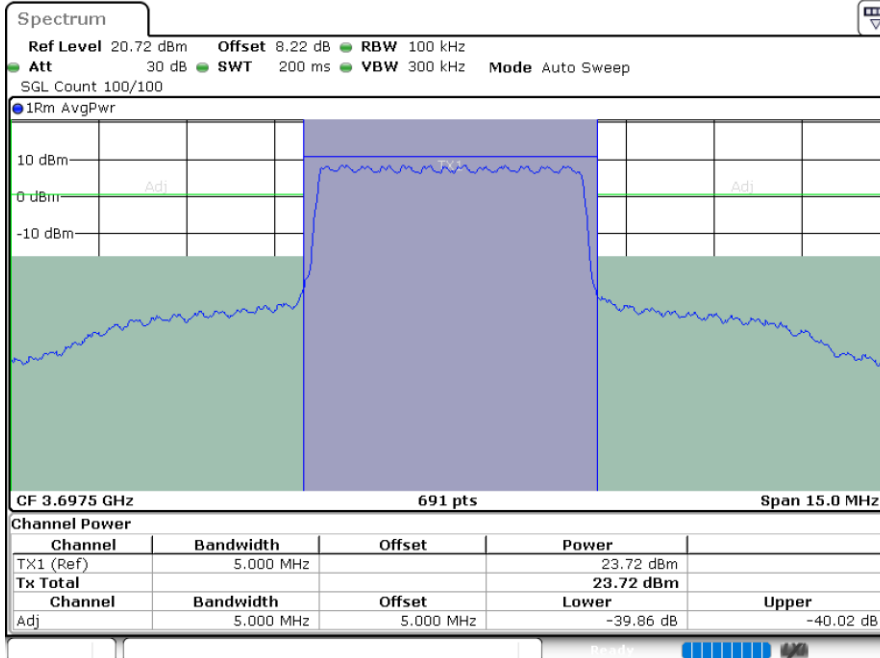

Date: 28.DEC.2021 20:54:14



**LTE Band 48 / 10MHz**

**QPSK**

**Lowest Channel / 1RB0**

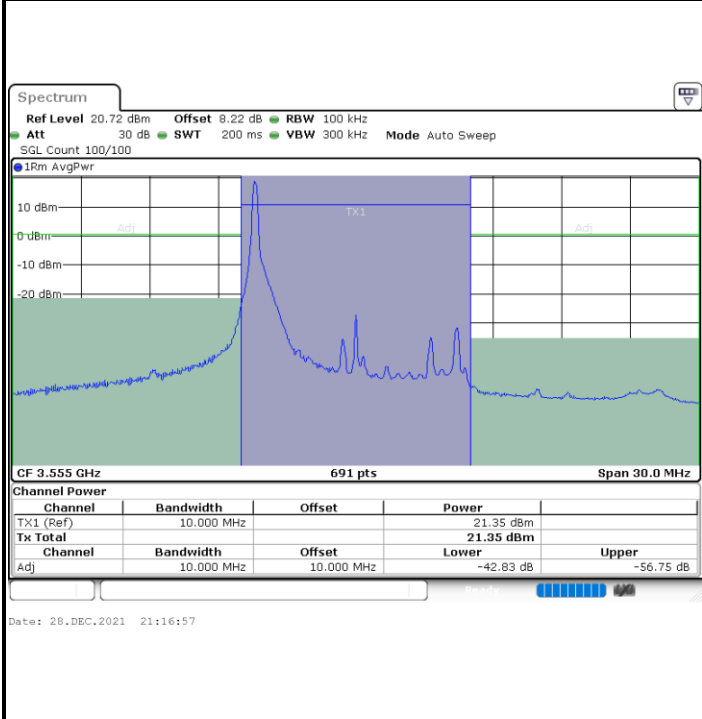

**Lowest Channel / 1RBmax**

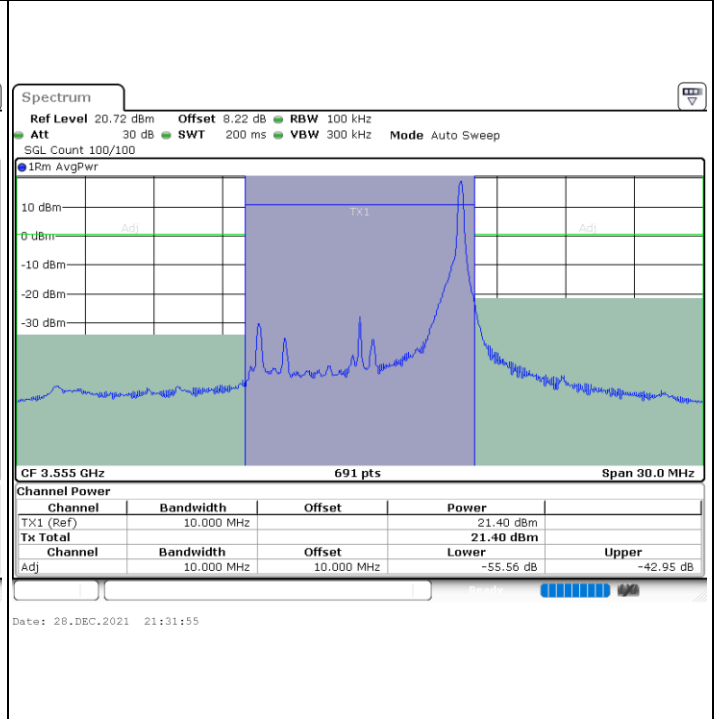

**Lowest Channel / FullIRB**

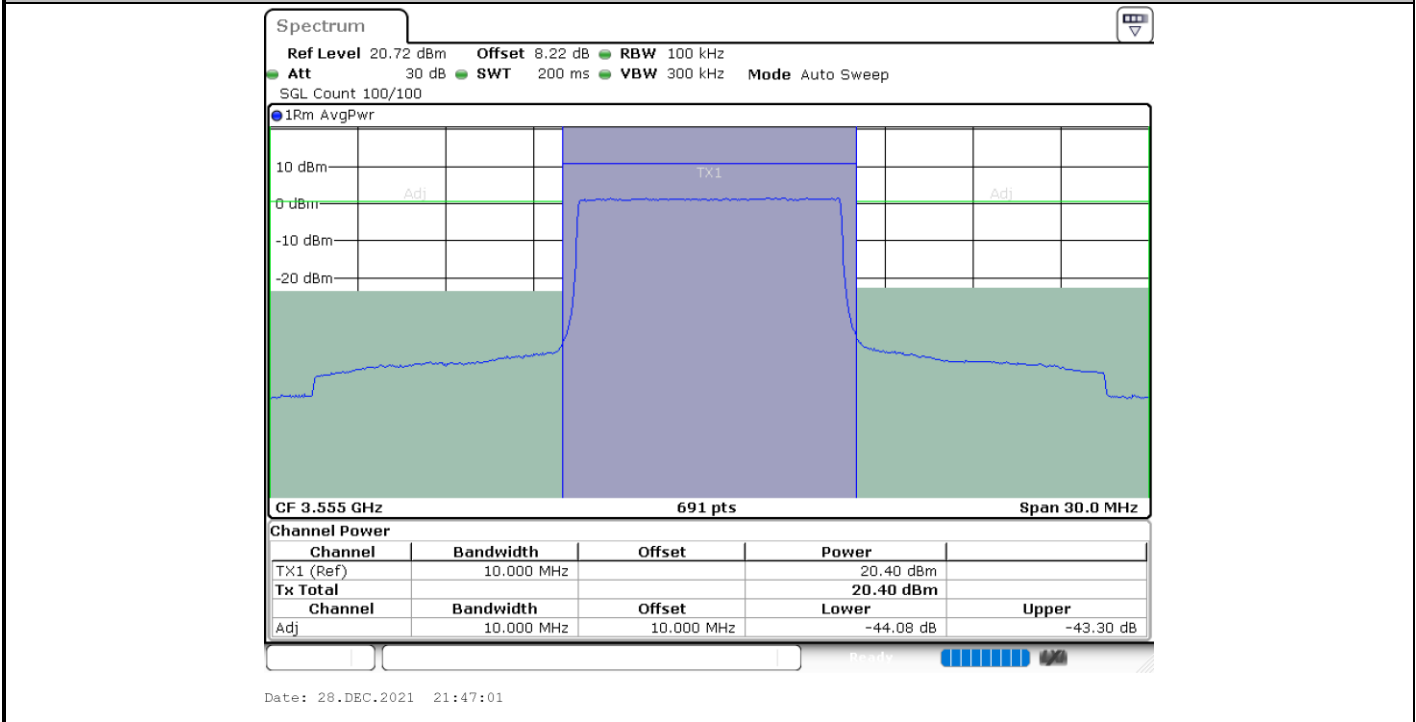



**LTE Band 48 / 10MHz**

**QPSK**

**MiddleChannel / 1RB0**

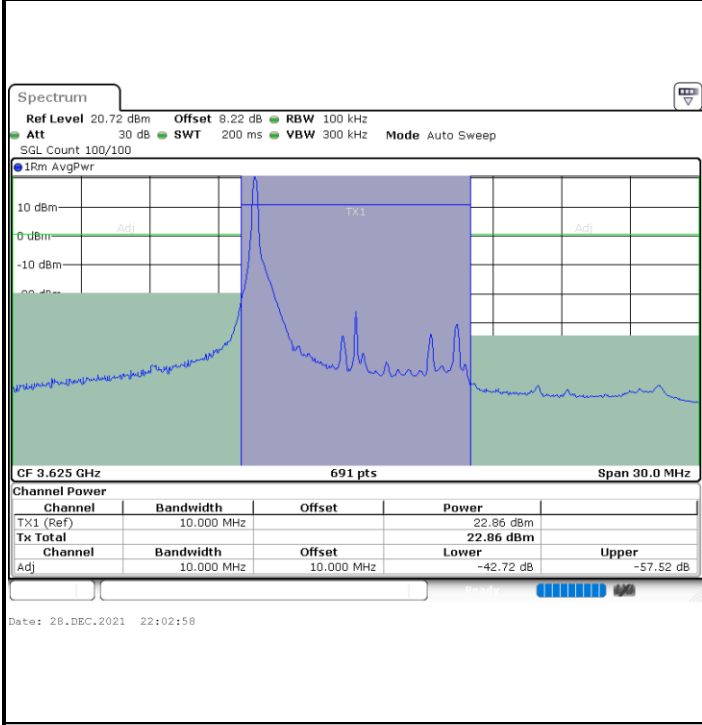

**Middle Channel / 1RBmax**

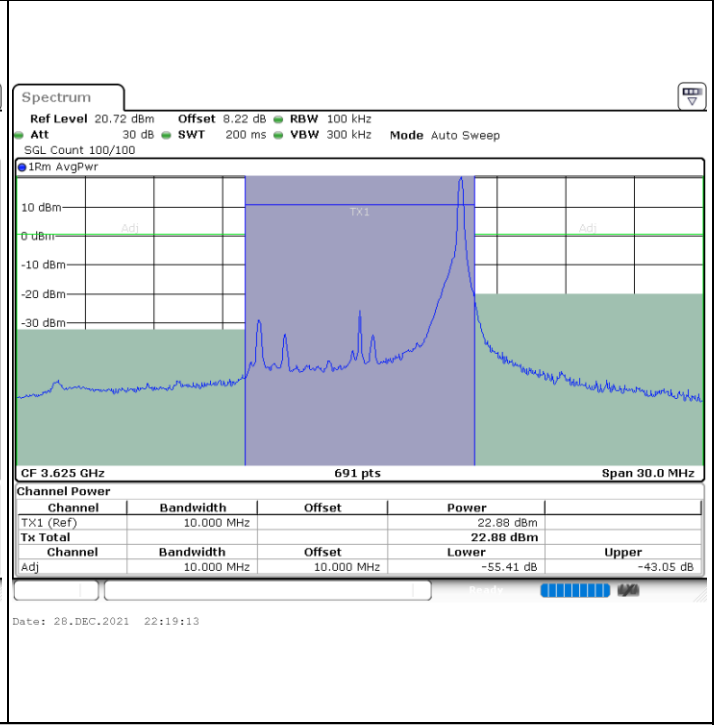

**Middle Channel / FullRB**

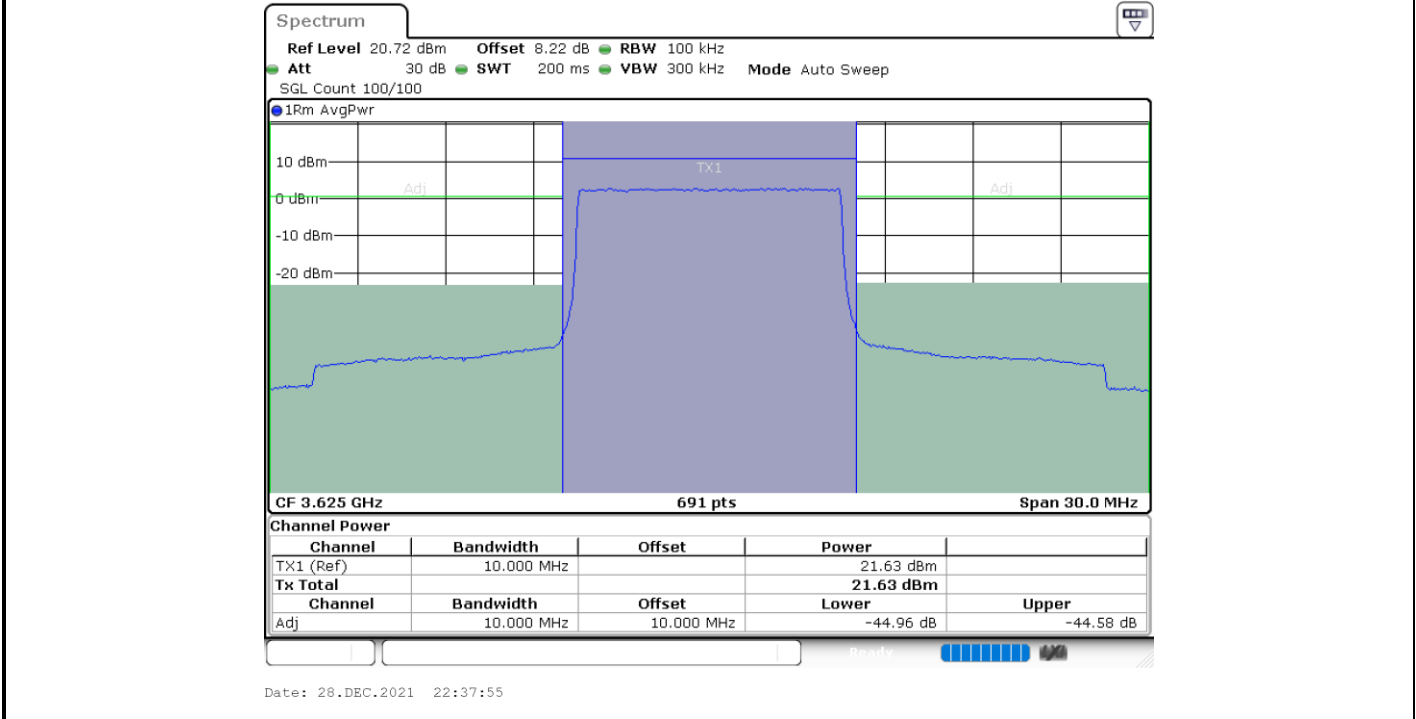



LTE Band 48 / 10MHz

QPSK

Highest Channel / 1RB0

Highest Channel / 1RBmax

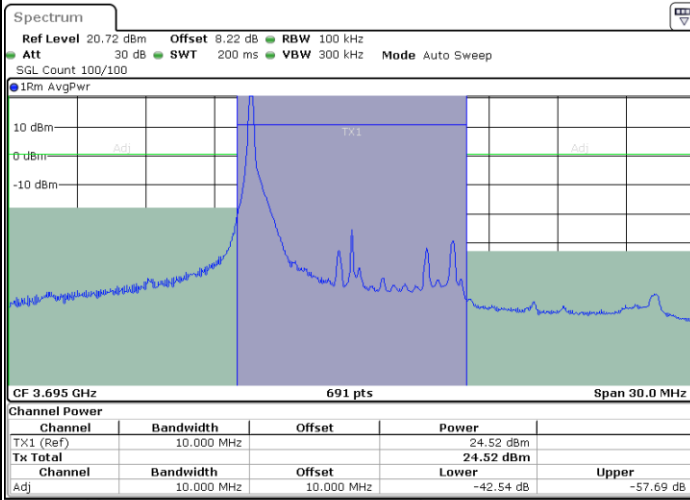

Date: 28.DEC.2021 22:57:28

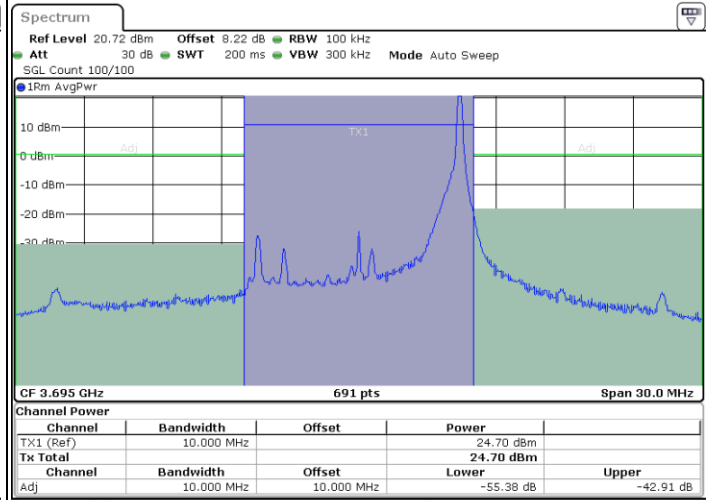

Date: 28.DEC.2021 23:39:19

Highest Channel / FullRB

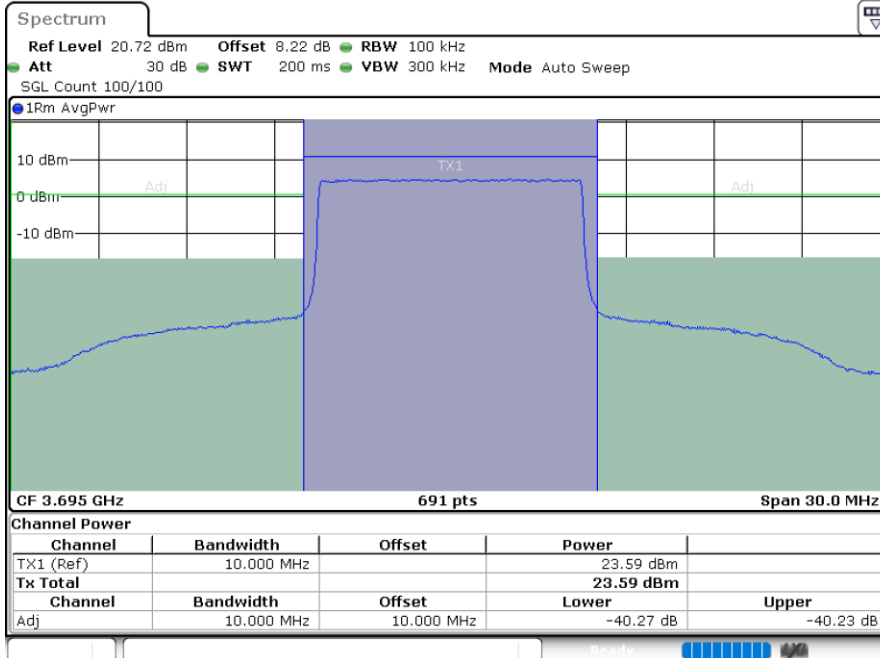

Date: 28.DEC.2021 23:45:57



LTE Band 48 / 15MHz

QPSK

Lowest Channel / 1RB0

Lowest Channel / 1RBmax

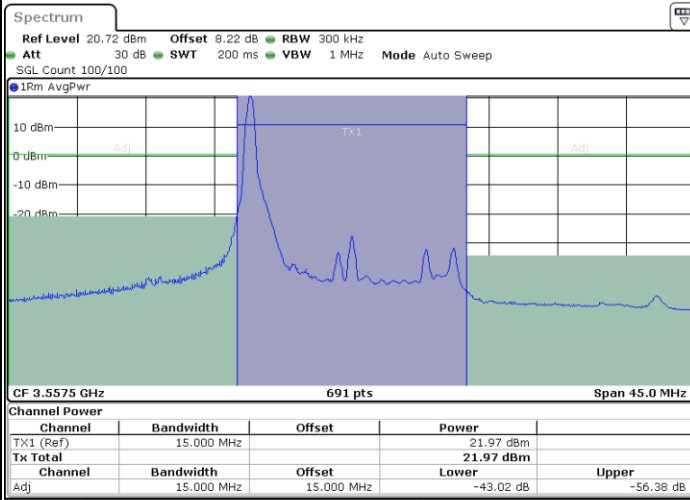

Date: 29.DEC.2021 19:28:46

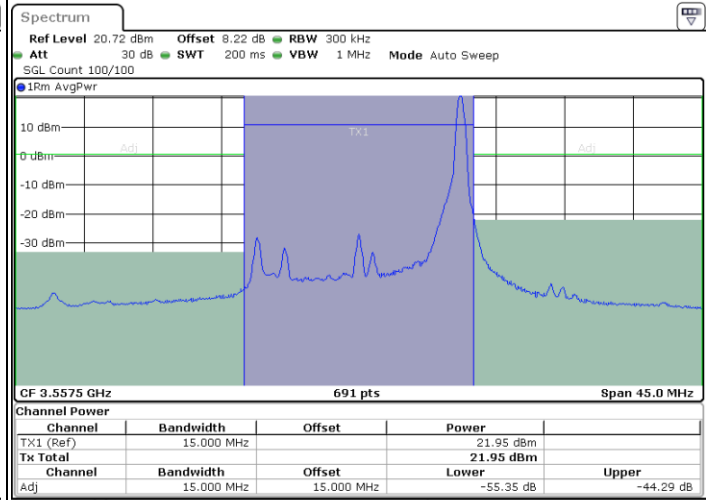

Date: 29.DEC.2021 19:50:09

Lowest Channel / FullRB

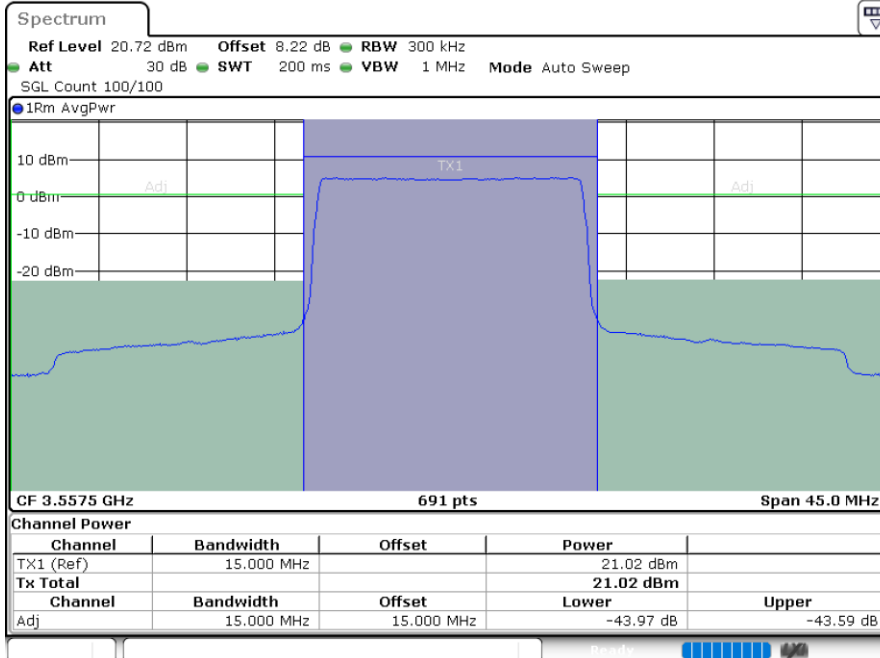

Date: 29.DEC.2021 19:20:21



**LTE Band 48 / 15MHz**

**QPSK**

**Middle Channel / 1RB0**

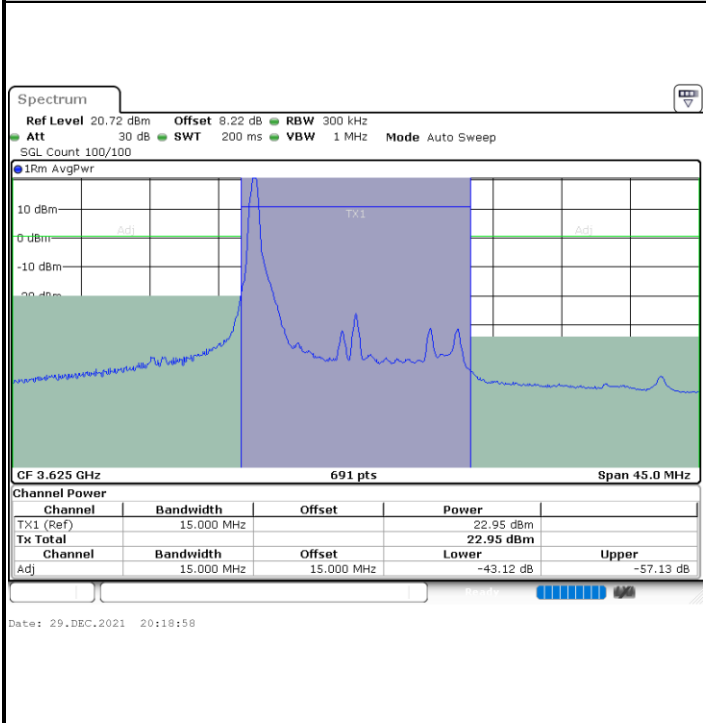

**Middle Channel / 1RBmax**

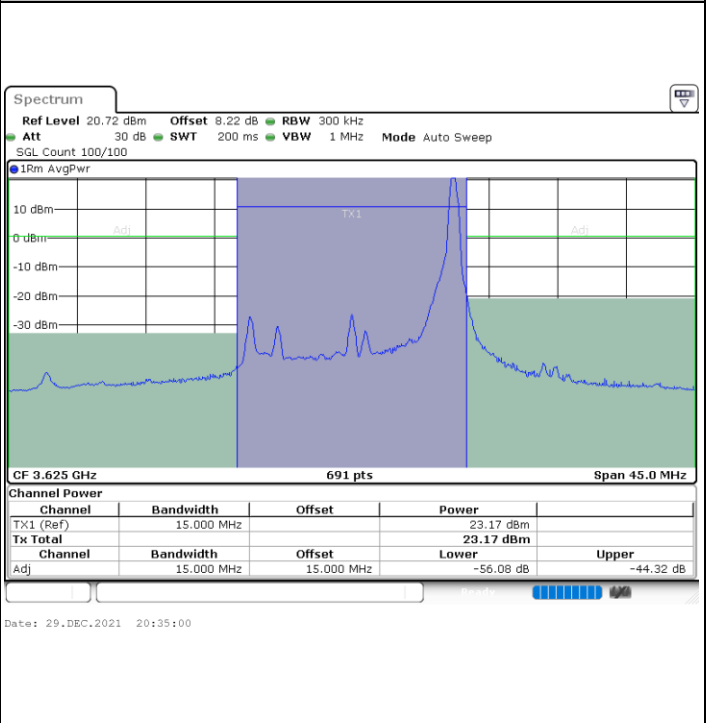

**Middle Channel / FullRB**

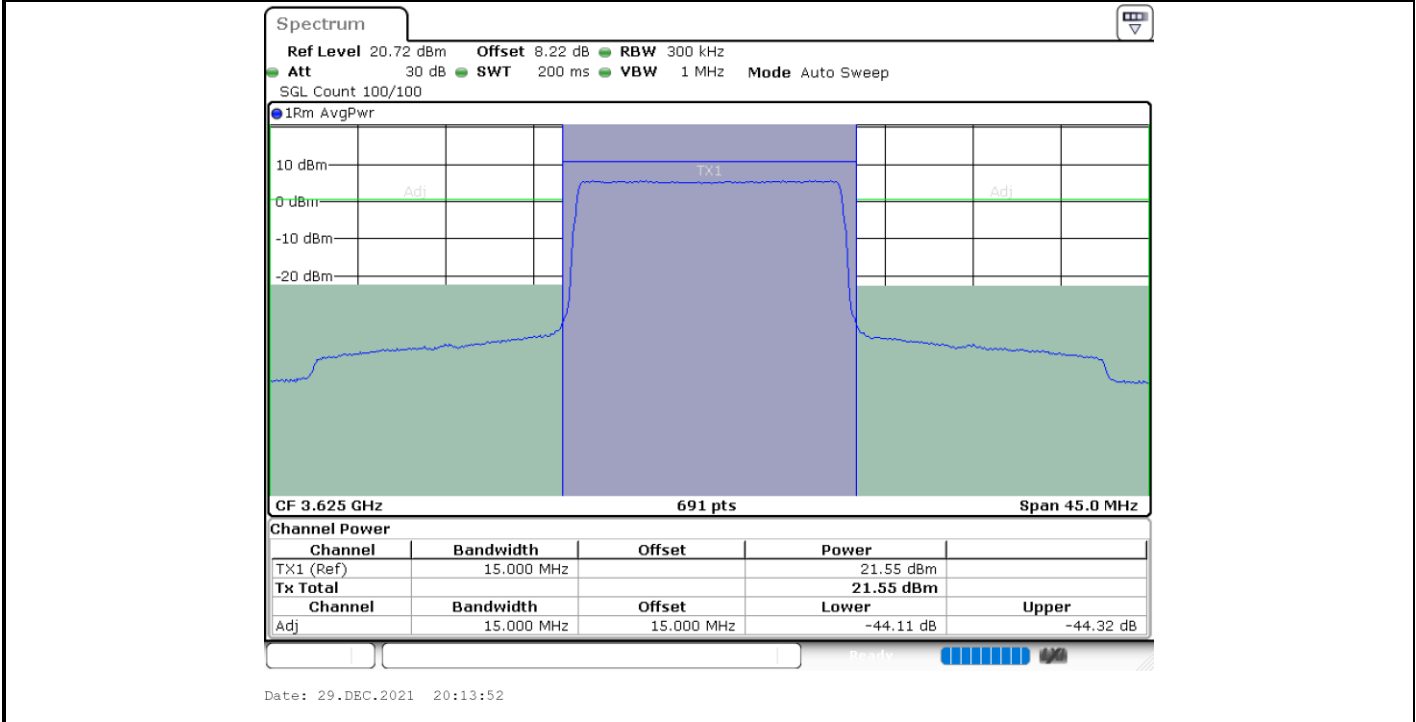



LTE Band 48 / 15MHz

QPSK

Highest Channel / 1RB0

Highest Channel / 1RBmax

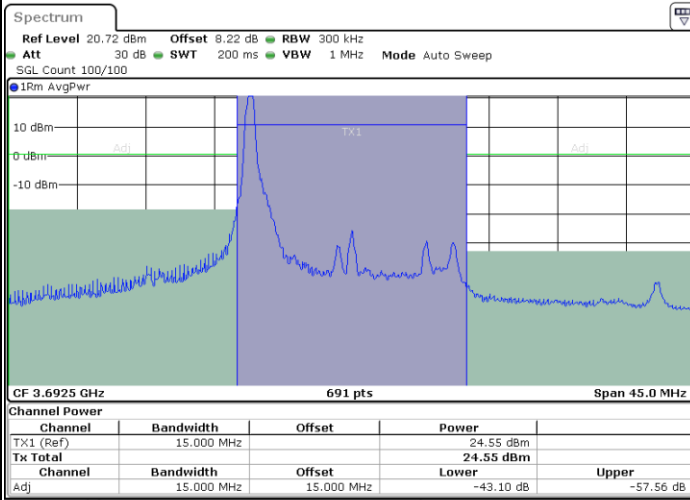

Date: 29.DEC.2021 20:54:35

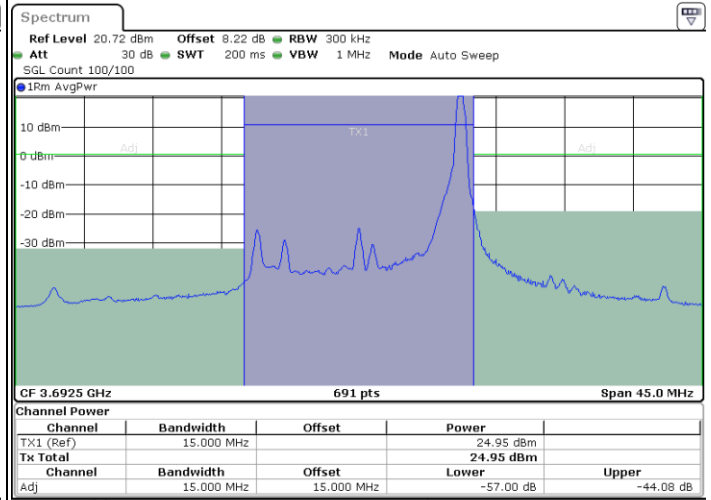

Date: 29.DEC.2021 21:19:10

Highest Channel / FullRB

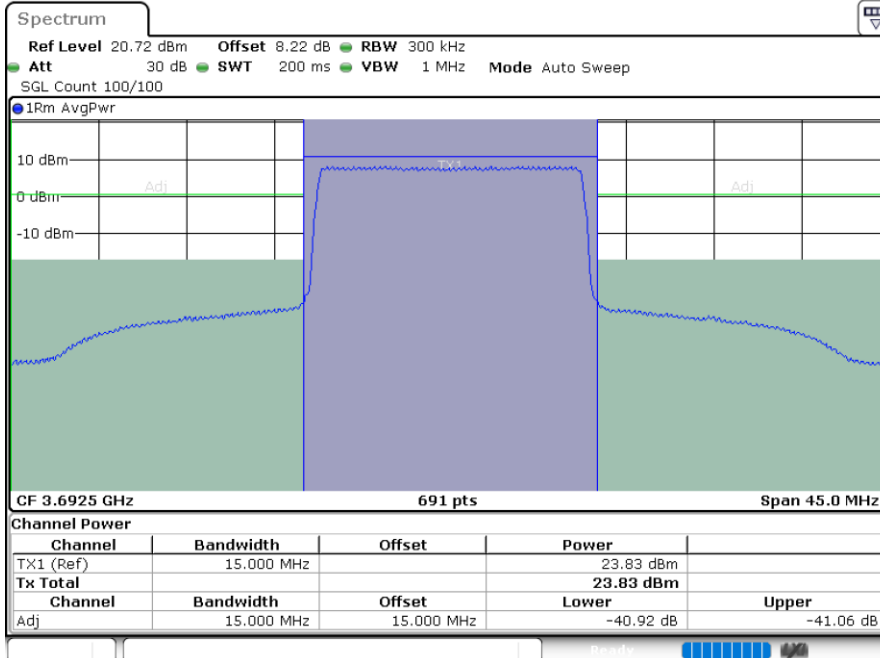

Date: 29.DEC.2021 20:53:33



**LTE Band 48 / 20MHz**

**QPSK**

**Lowest Channel / 1RB0**

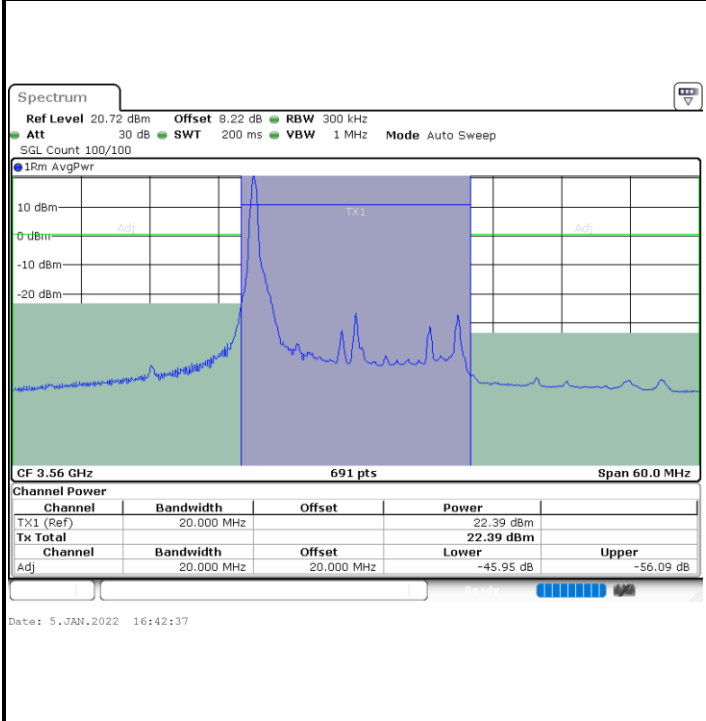

**Lowest Channel / 1RBmax**

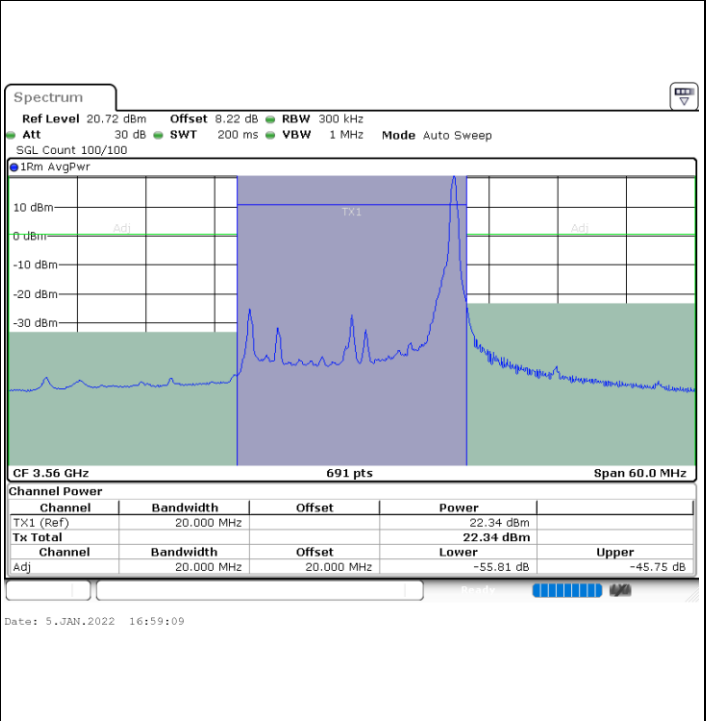

**Lowest Channel / FullIRB**

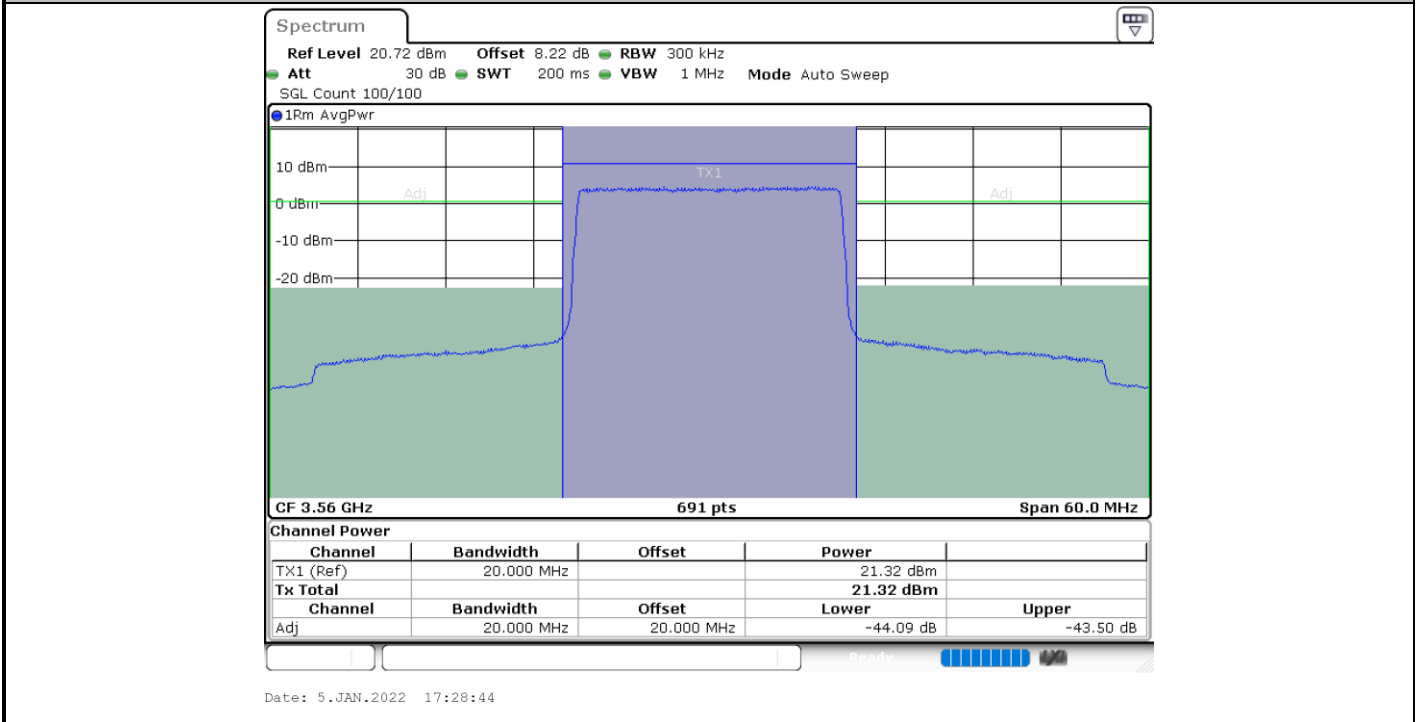





**LTE Band 48 / 20MHz**

**QPSK**

**Middle Channel / 1RB0**

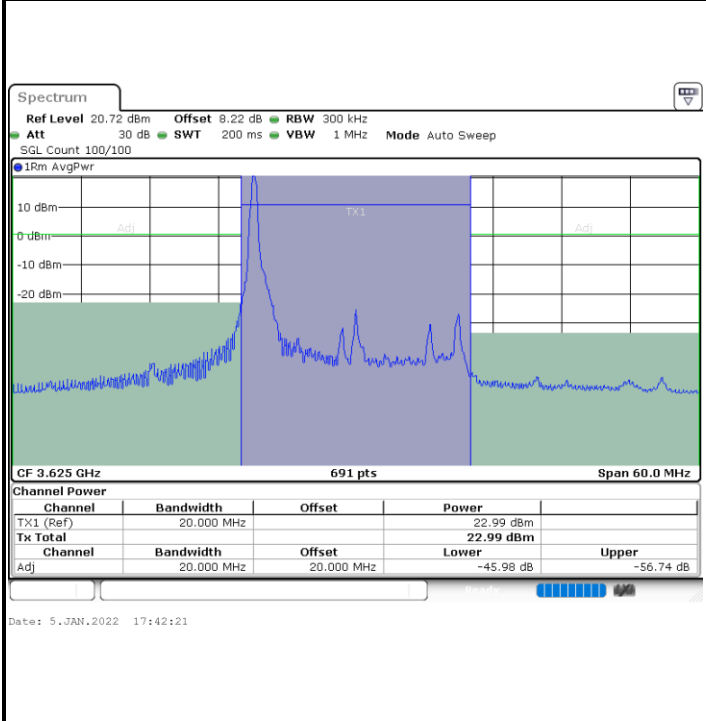

**Middle Channel / 1RBmax**

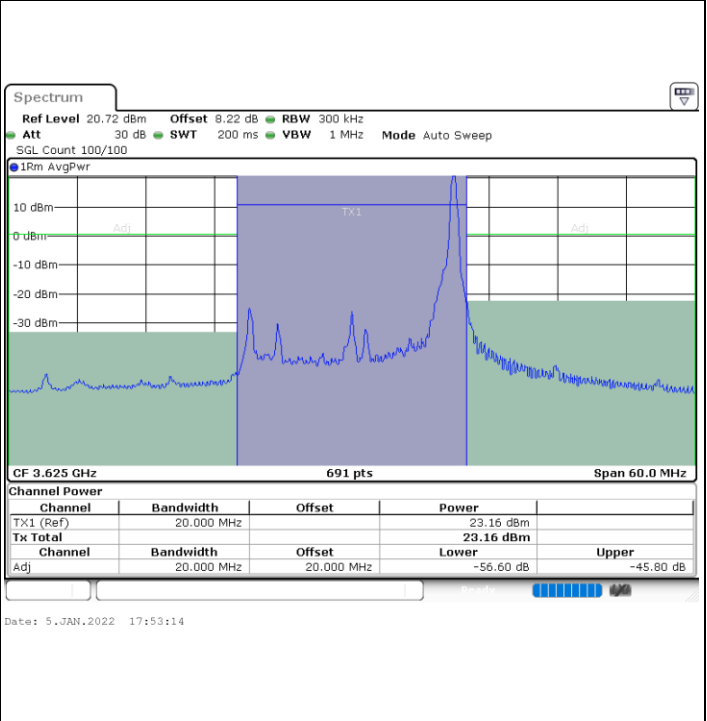

**Middle Channel / FullRB**

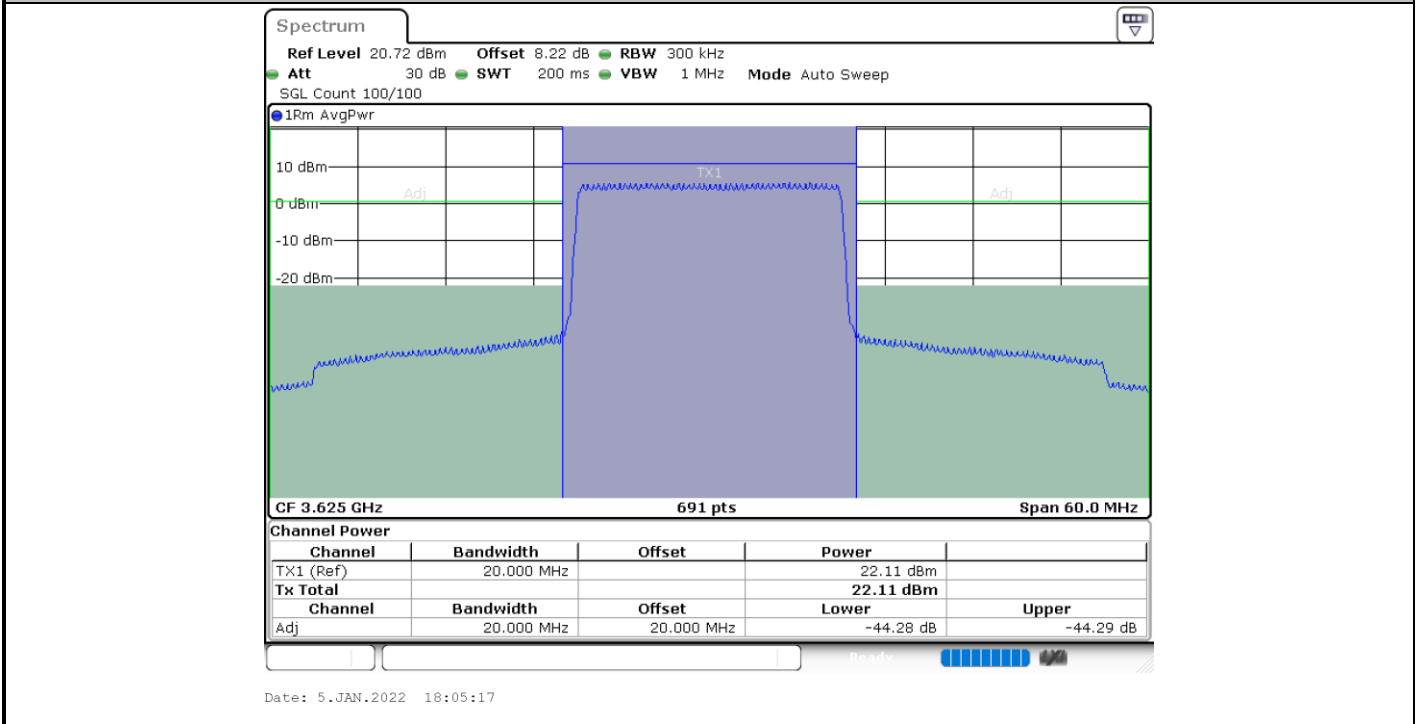



**LTE Band 48 / 20MHz**

**QPSK**

**Highest Channel / 1RB0**

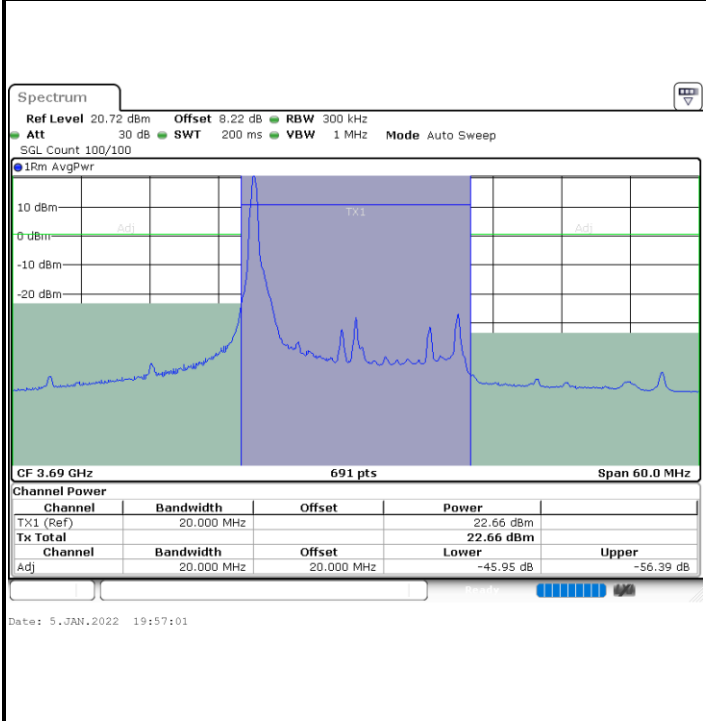

**Highest Channel / 1RBmax**

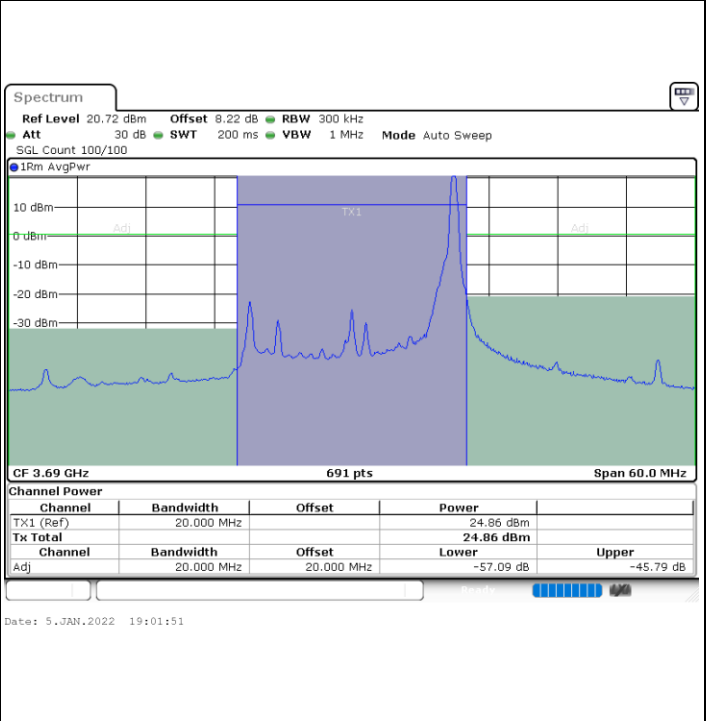

**Highest Channel / FullRB**

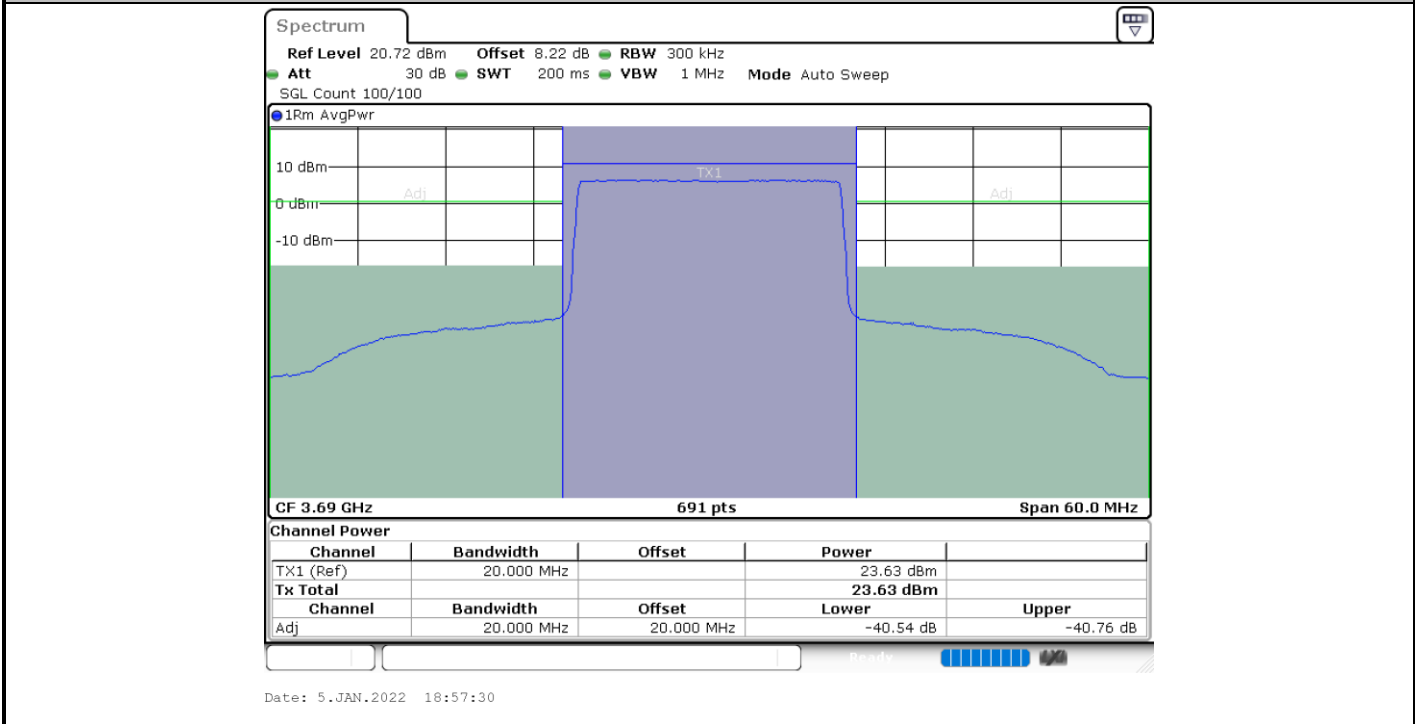



LTE Band 48 / 5MHz

16QAM

Lowest Channel / 1RB0

Lowest Channel / 1RBmax

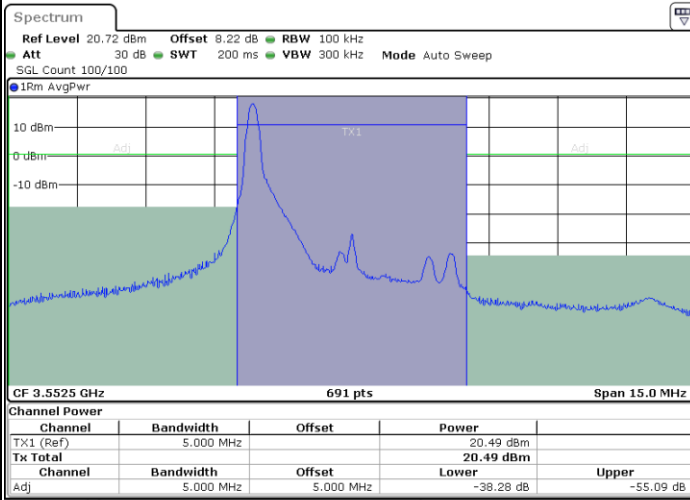

Date: 28.DEC.2021 16:45:09

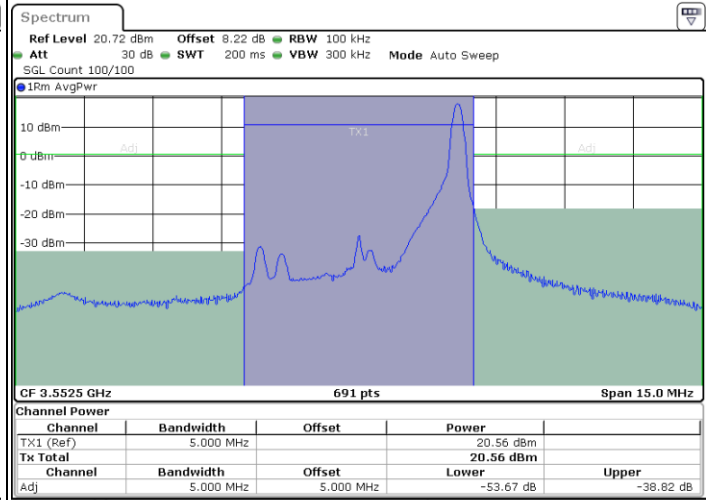

Date: 28.DEC.2021 17:45:37

Lowest Channel / FullRB

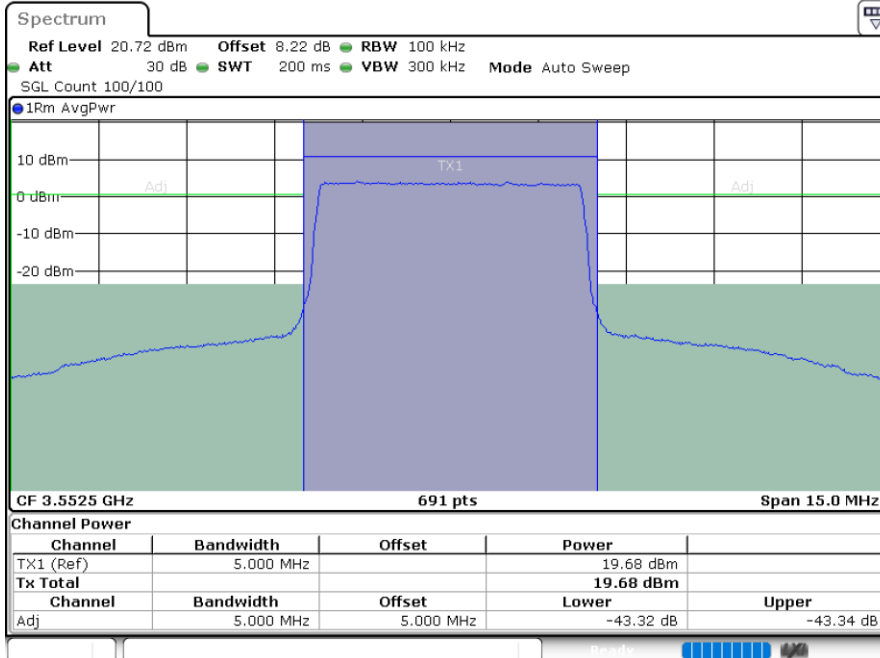

Date: 28.DEC.2021 18:03:21



LTE Band 48 / 5MHz

16QAM

Middle Channel / 1RB0

Middle Channel / 1RBmax

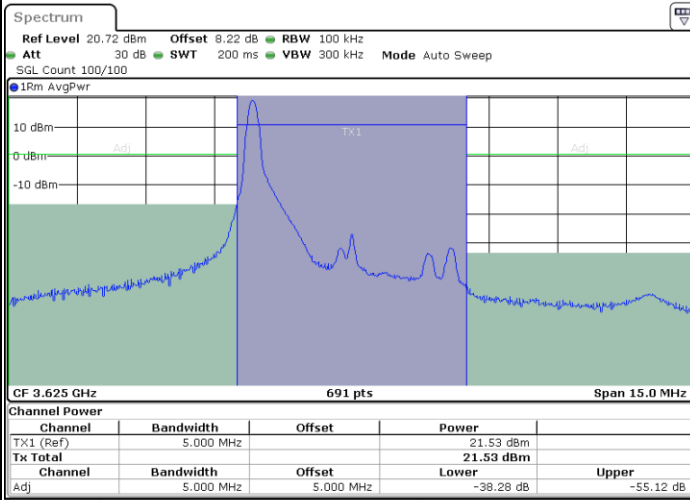

Date: 28.DEC.2021 18:47:11

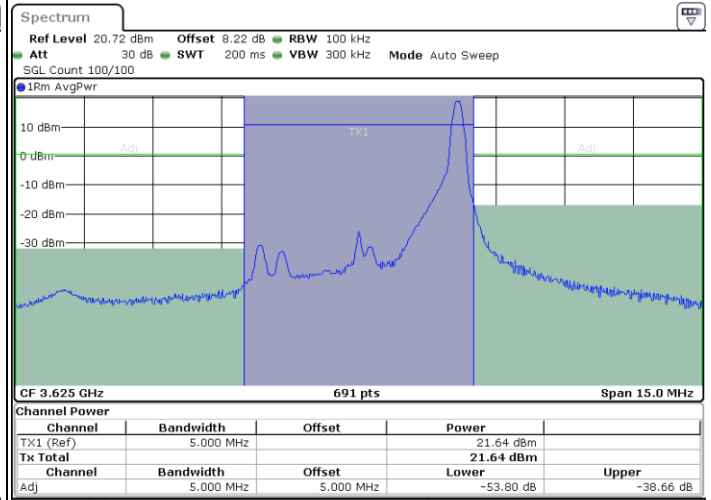

Date: 28.DEC.2021 20:08:01

Middle Channel / FullRB

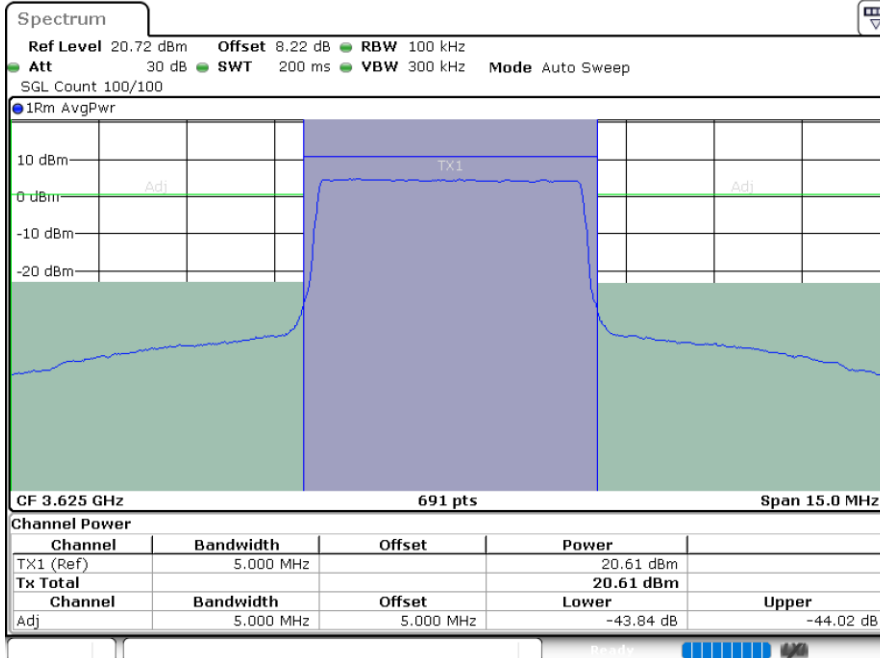

Date: 28.DEC.2021 18:24:03



LTE Band 48 / 5MHz

16QAM

Highest Channel / 1RB0

Highest Channel / 1RBmax

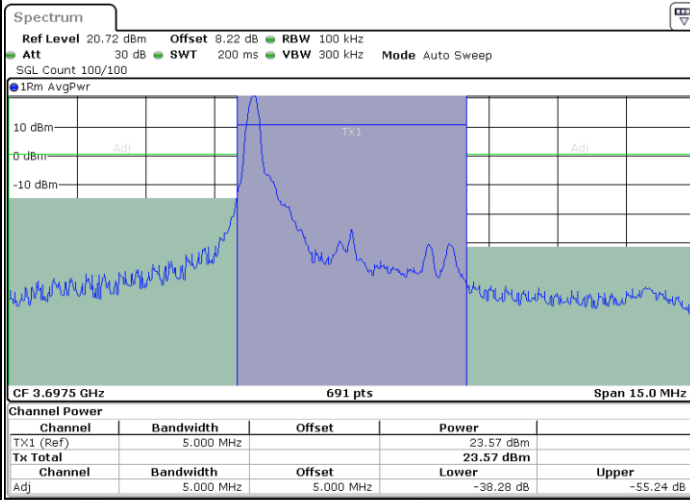

Date: 28.DEC.2021 20:28:11

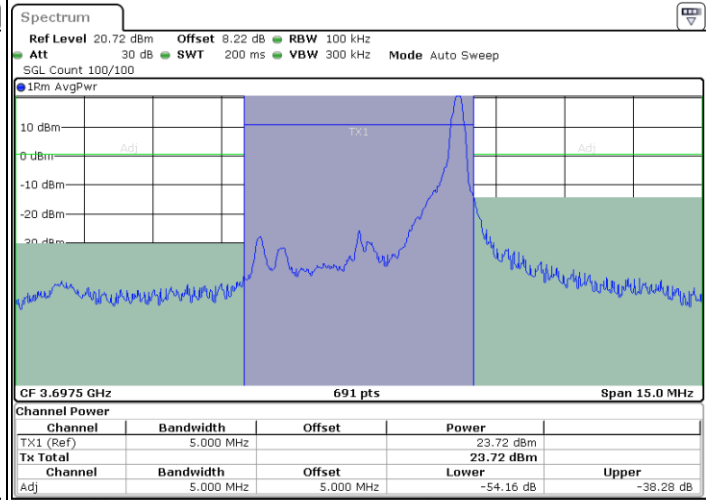

Date: 28.DEC.2021 20:42:16

Highest Channel / FullRB

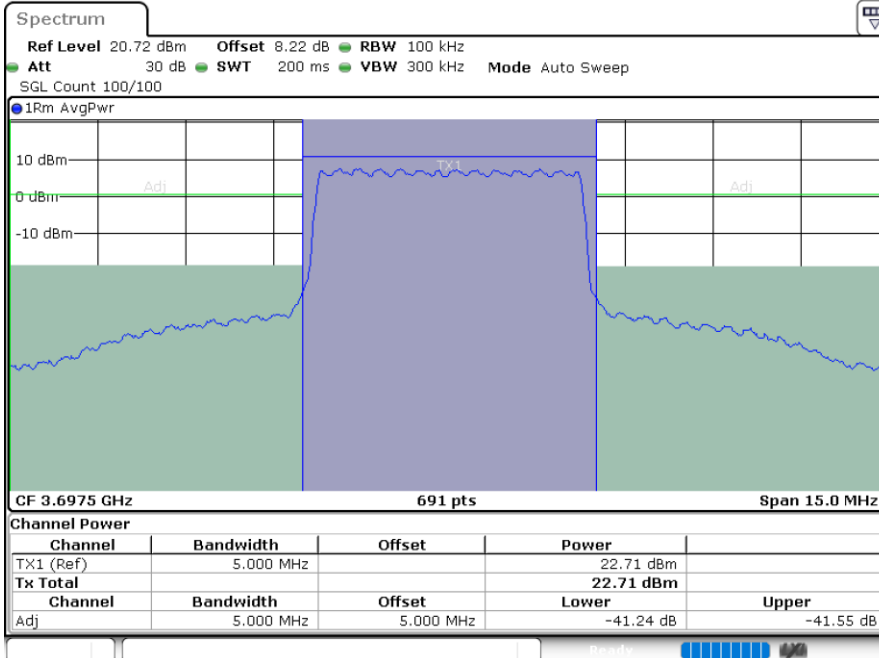

Date: 28.DEC.2021 20:59:47



LTE Band 48 / 10MHz

16QAM

Lowest Channel / 1RB0

Lowest Channel / 1RBmax

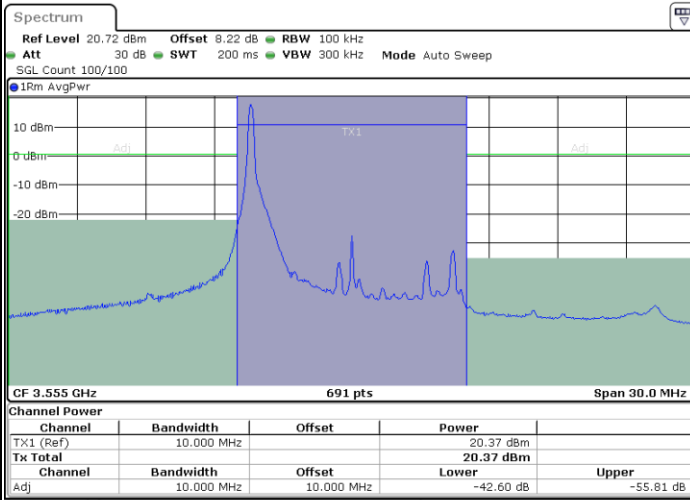

Date: 28.DEC.2021 21:20:27

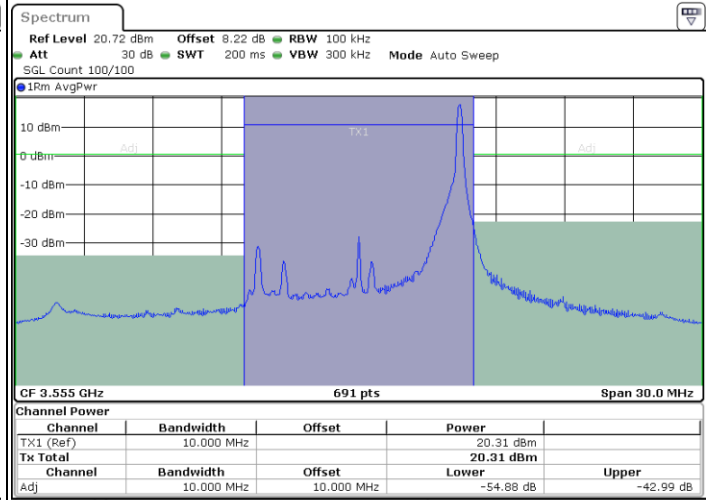

Date: 28.DEC.2021 21:34:47

Lowest Channel / FullIRB

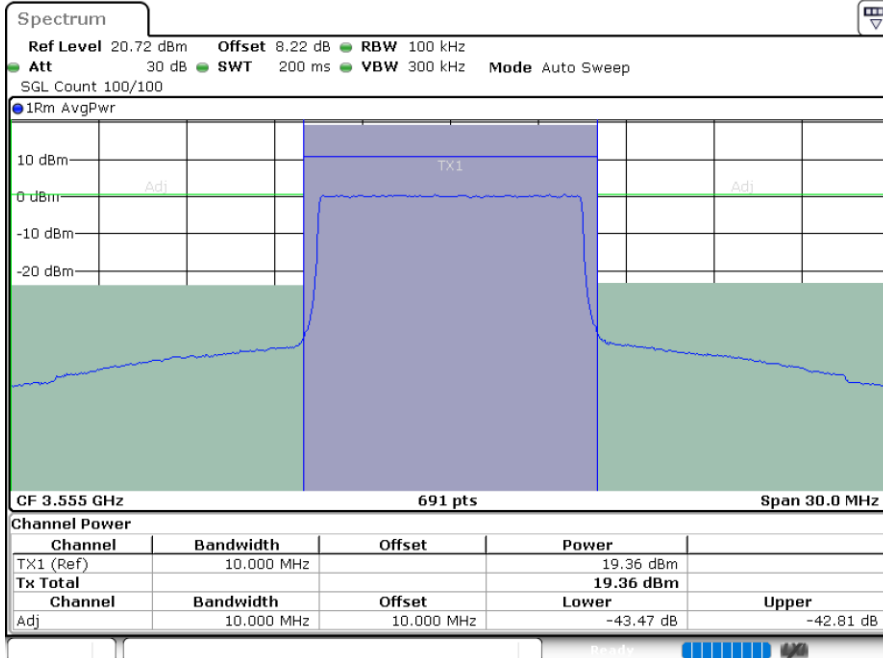

Date: 28.DEC.2021 21:44:04



LTE Band 48 / 10MHz

16QAM

MiddleChannel / 1RB0

Middle Channel / 1RBmax

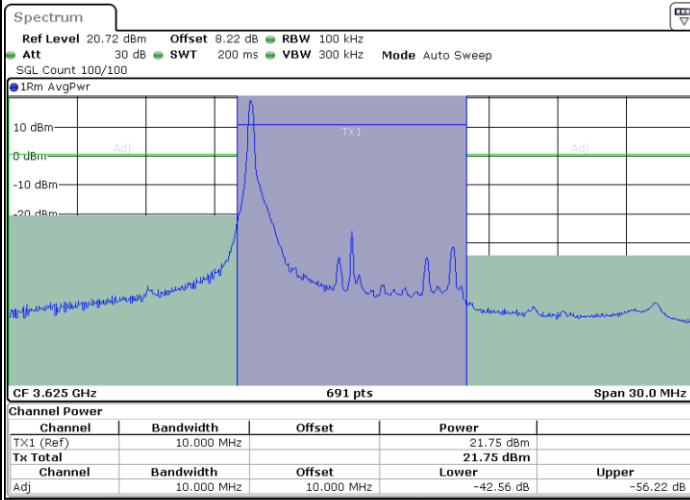

Date: 28.DEC.2021 22:06:32

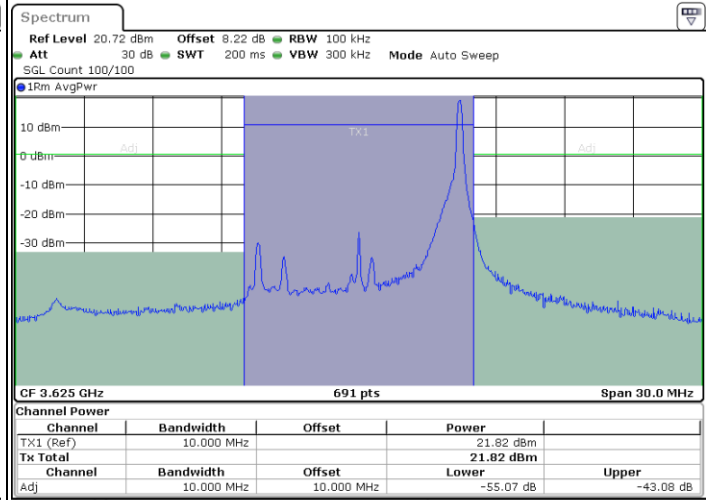

Date: 28.DEC.2021 22:23:26

Middle Channel / FullRB

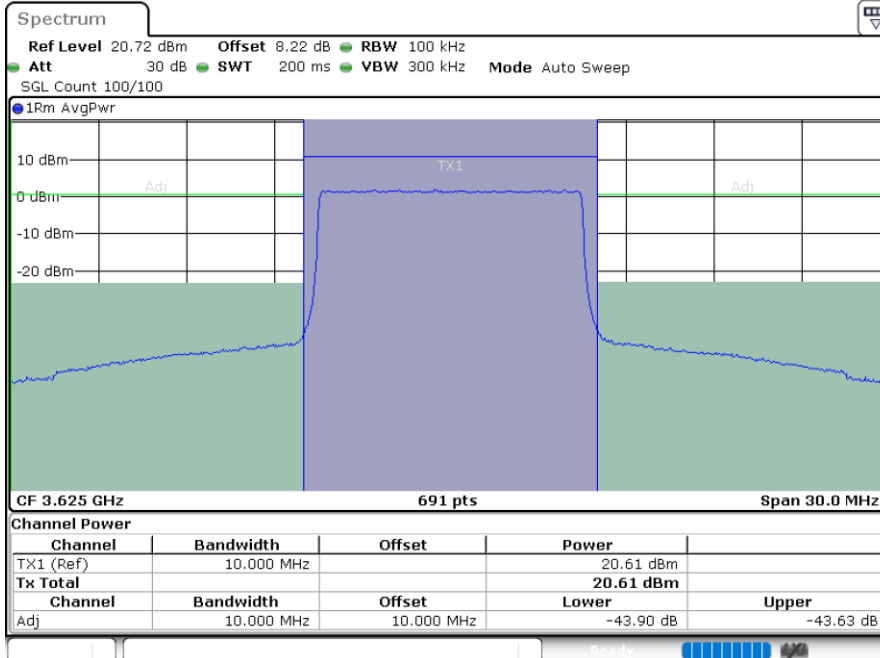

Date: 28.DEC.2021 22:35:21



LTE Band 48 / 10MHz

16QAM

Highest Channel / 1RB0

Highest Channel / 1RBmax

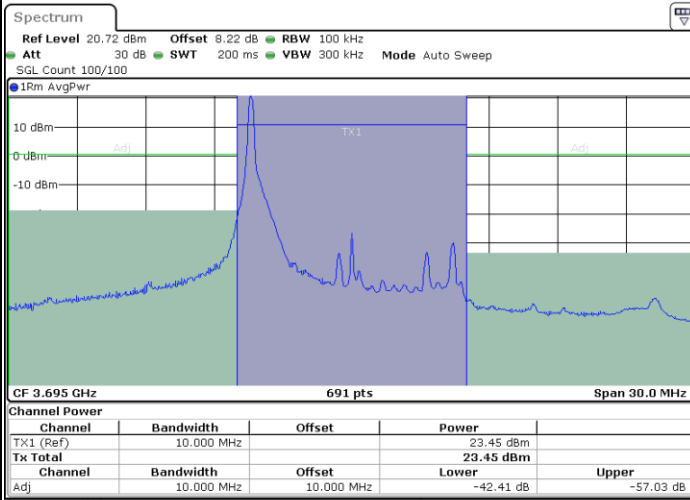

Date: 28.DEC.2021 23:02:09

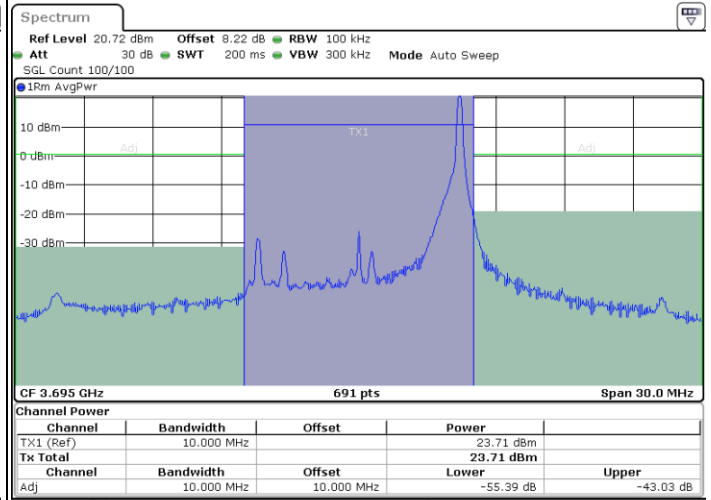

Date: 28.DEC.2021 23:17:21

Highest Channel / FullRB

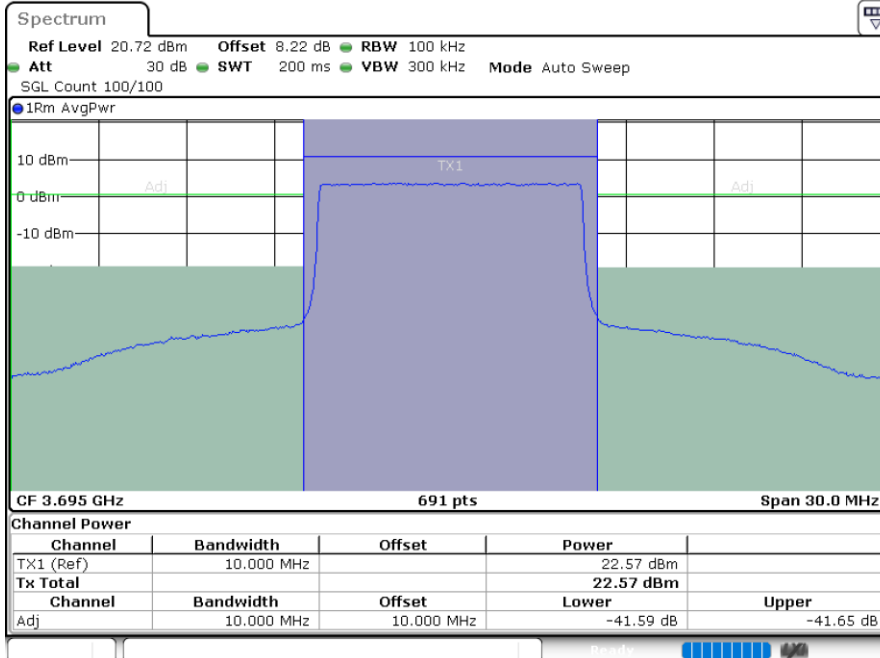

Date: 28.DEC.2021 23:49:13





LTE Band 48 / 15MHz

16QAM

Lowest Channel / 1RB0

Lowest Channel / 1RBmax

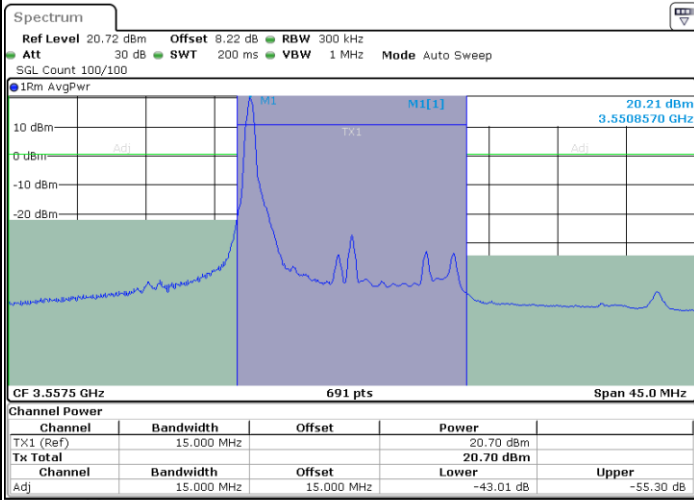

Date: 29.DEC.2021 19:39:32

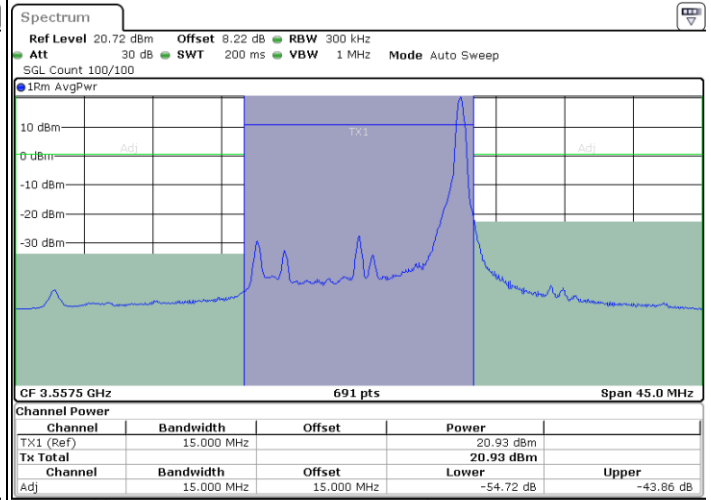

Date: 29.DEC.2021 19:47:26

Lowest Channel / FullRB

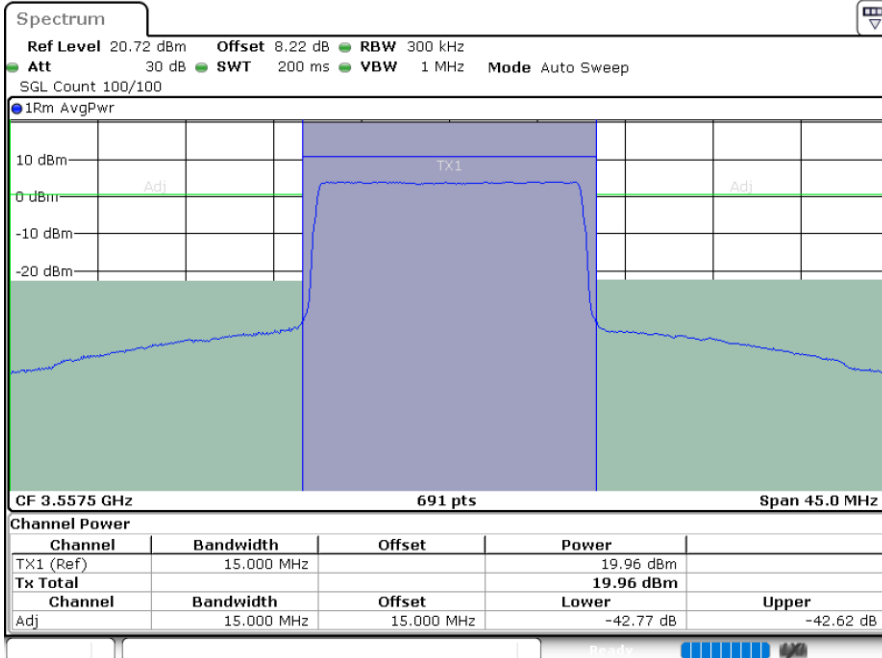

Date: 29.DEC.2021 19:18:55



LTE Band 48 / 15MHz

16QAM

Middle Channel / 1RB0

Middle Channel / 1RBmax

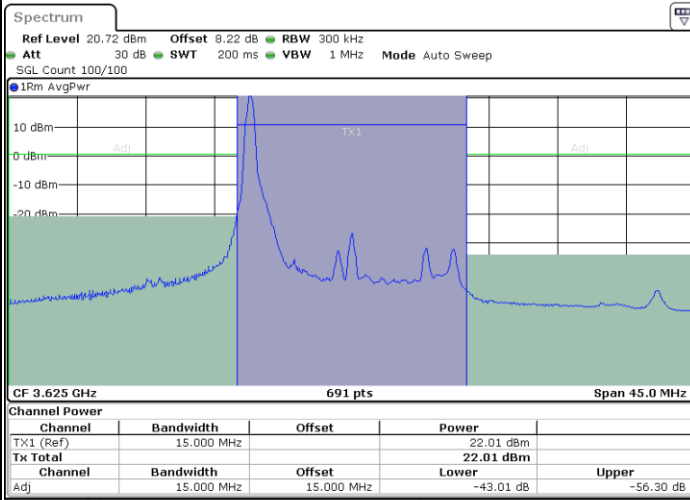

Date: 29.DEC.2021 20:22:32

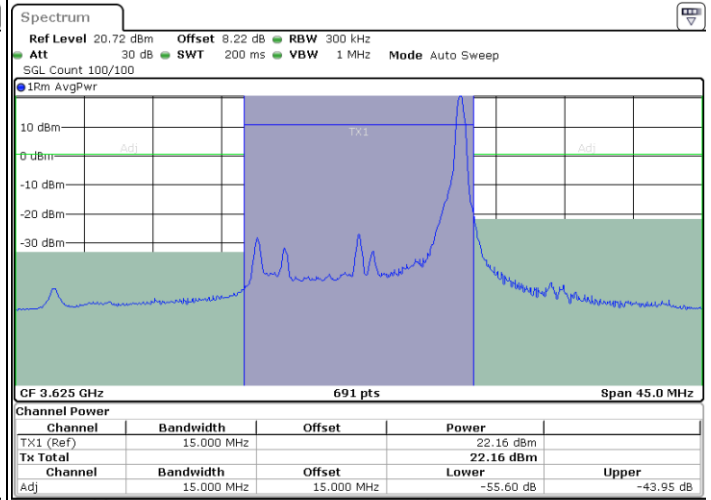

Date: 29.DEC.2021 20:30:55

Middle Channel / FullRB

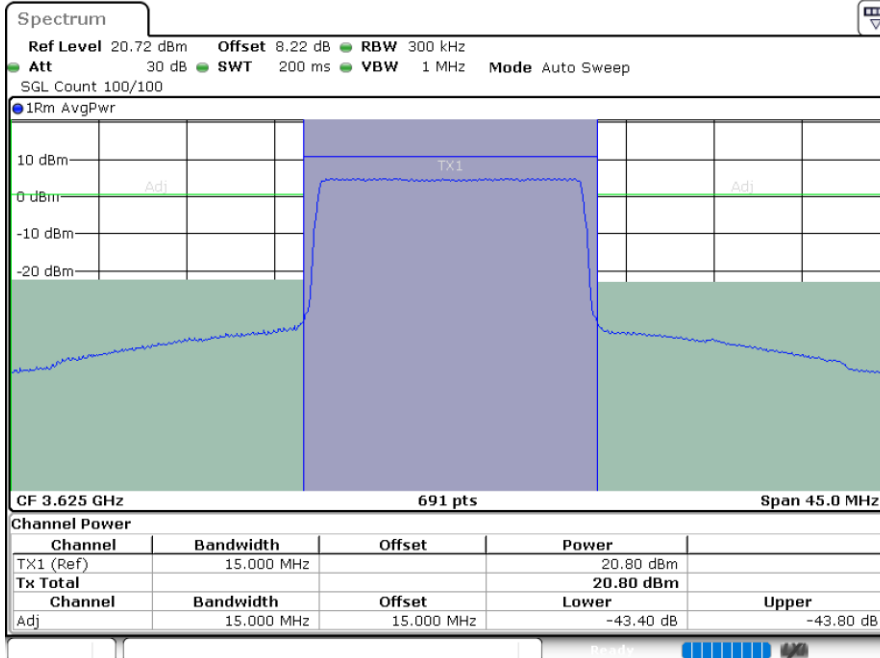

Date: 29.DEC.2021 20:07:17



LTE Band 48 / 15MHz

16QAM

Highest Channel / 1RB0

Highest Channel / 1RBmax

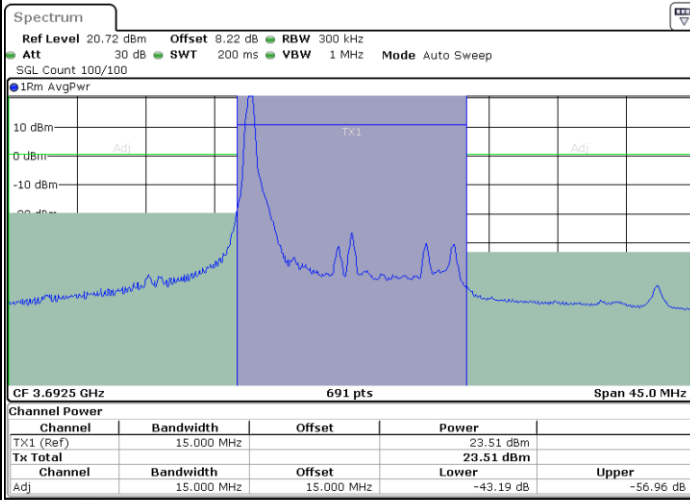

Date: 29.DEC.2021 21:02:08

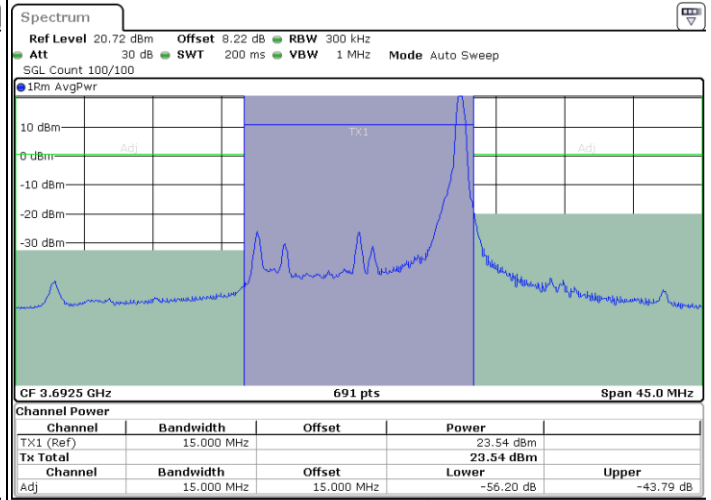

Date: 29.DEC.2021 21:22:31

Highest Channel / FullRB

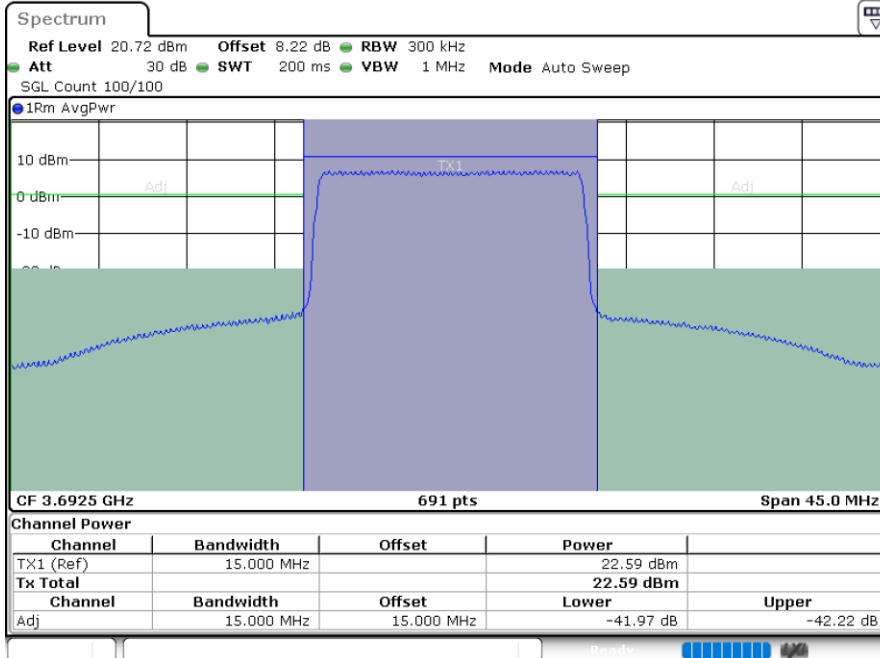

Date: 29.DEC.2021 21:09:22



**LTE Band 48 / 20MHz**

**16QAM**

**Lowest Channel / 1RB0**

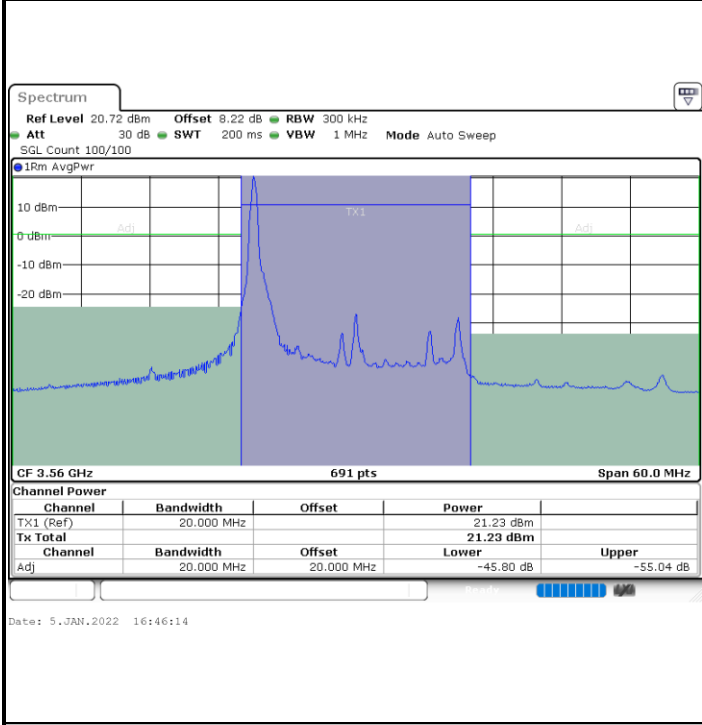

**Lowest Channel / 1RBmax**

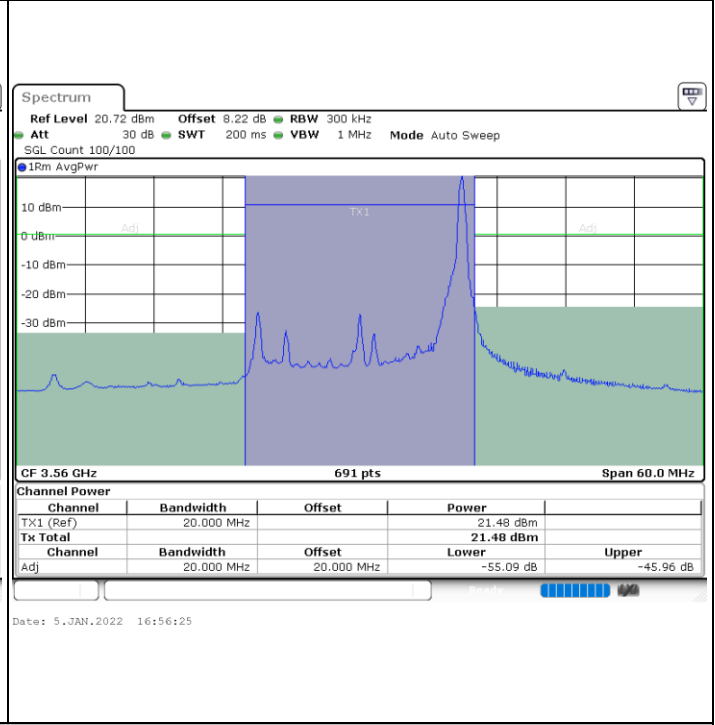

**Lowest Channel / FullIRB**

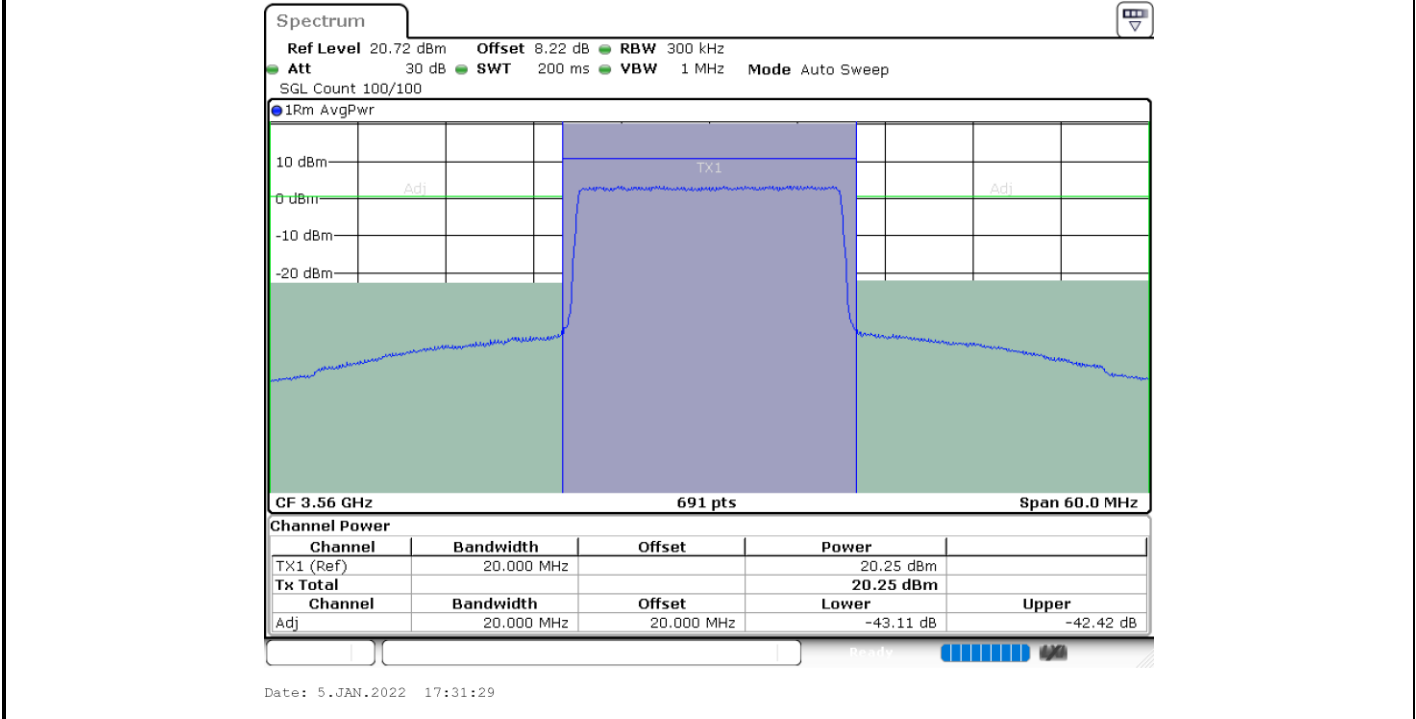



LTE Band 48 / 20MHz

16QAM

Middle Channel / 1RB0

Middle Channel / 1RBmax

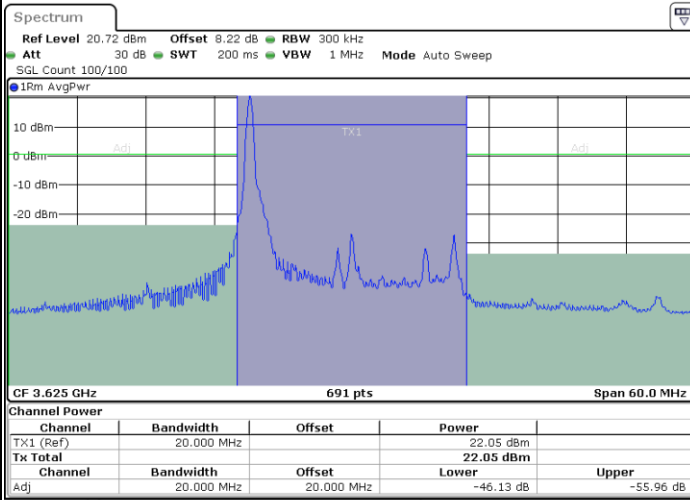

Date: 5.JAN.2022 17:45:01

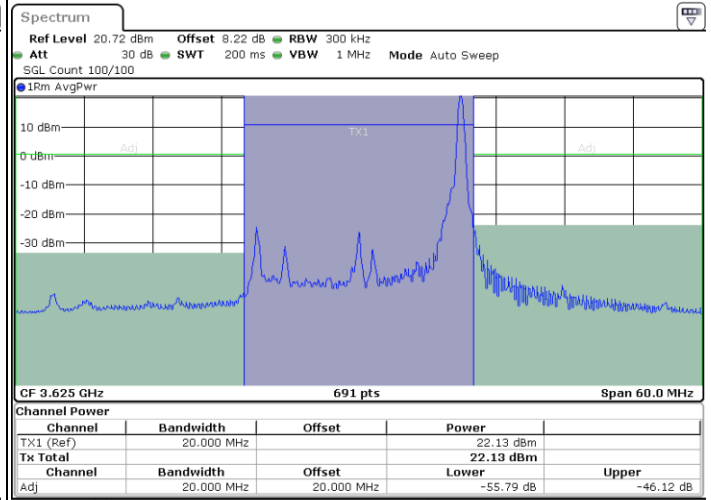

Date: 5.JAN.2022 17:56:12

Middle Channel / FullRB

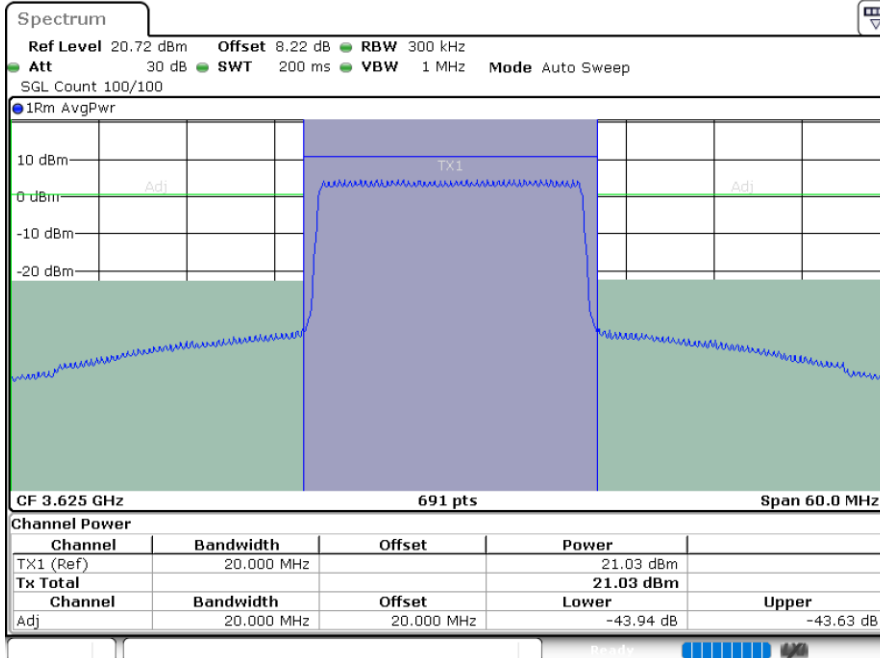

Date: 5.JAN.2022 18:41:10



**LTE Band 48 / 20MHz**

**16QAM**

**Highest Channel / 1RB0**

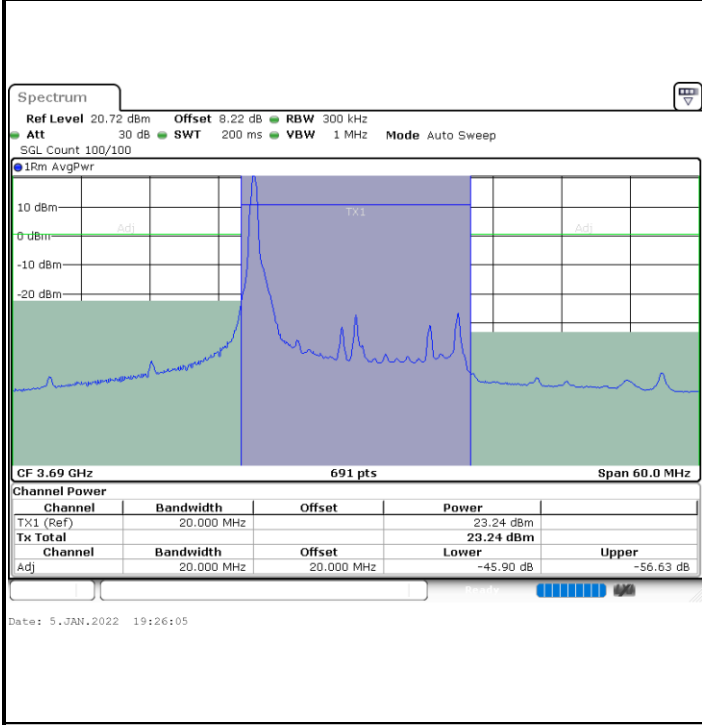

**Highest Channel / 1RBmax**

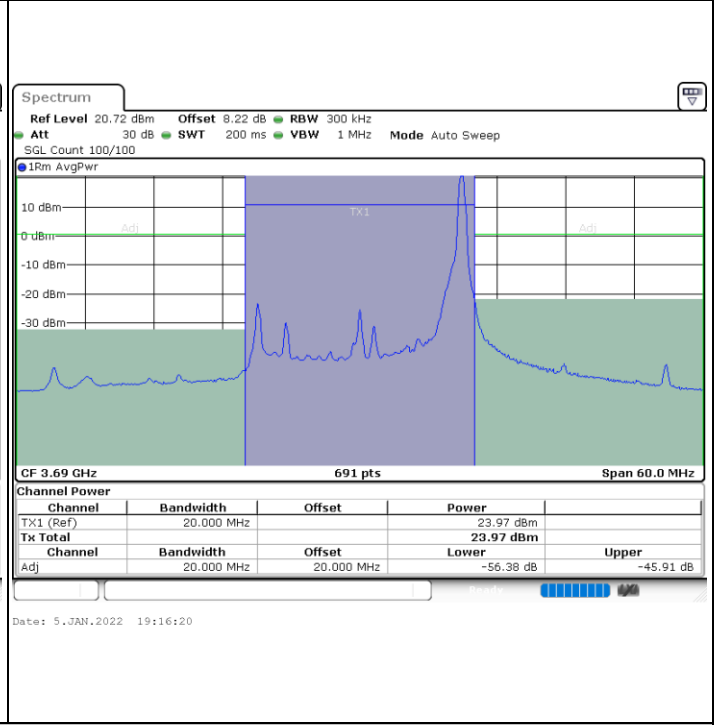

**Highest Channel / FullRB**

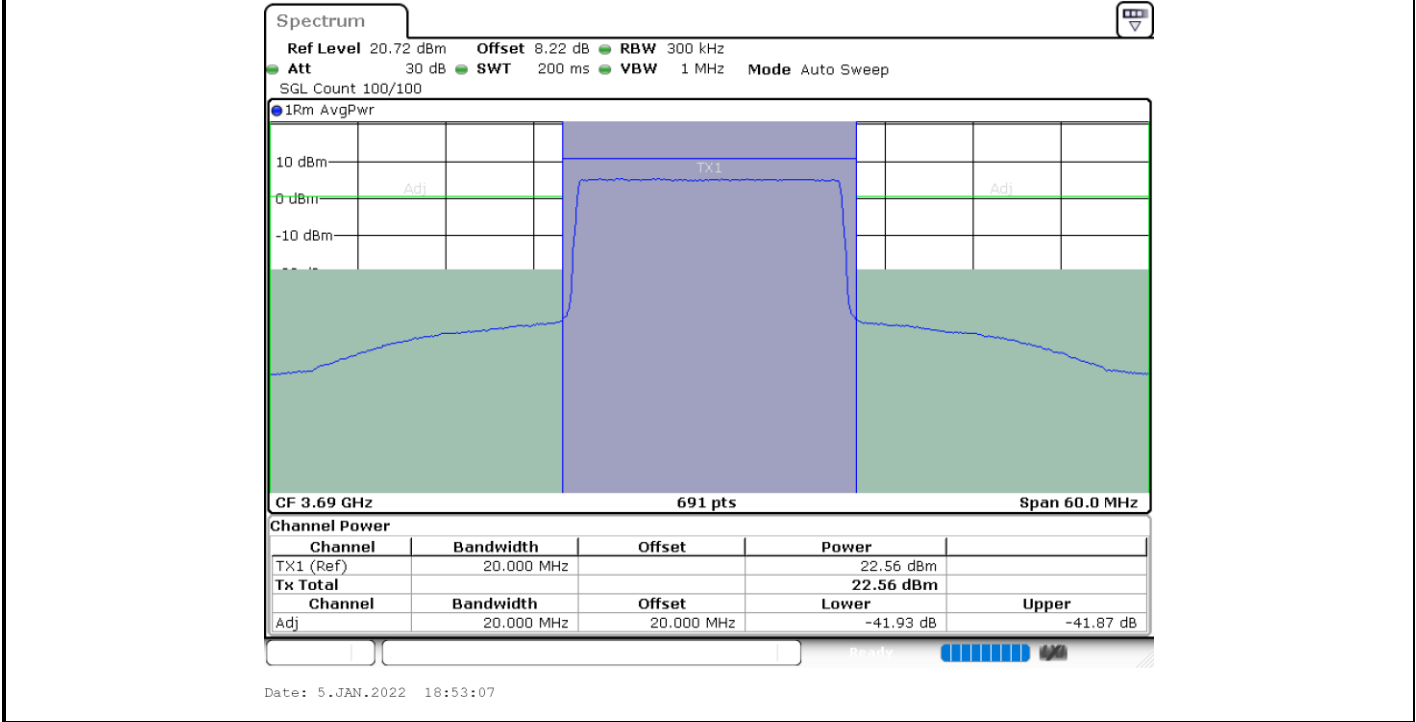



LTE Band 48 / 5MHz

64QAM

Lowest Channel / 1RB0

Lowest Channel / 1RBmax

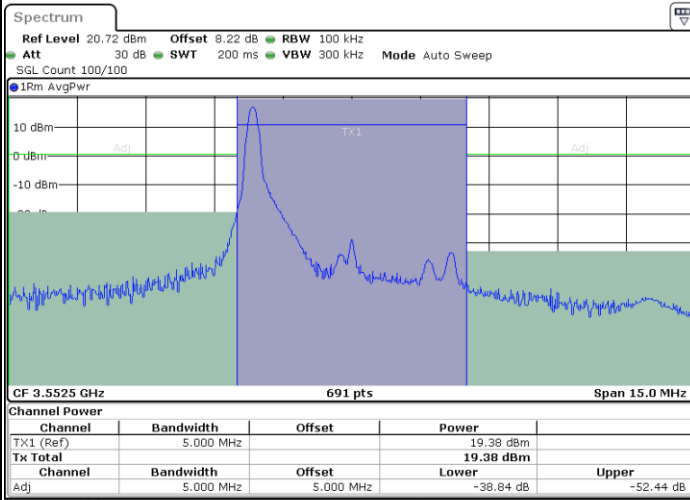

Date: 28.DEC.2021 16:48:38

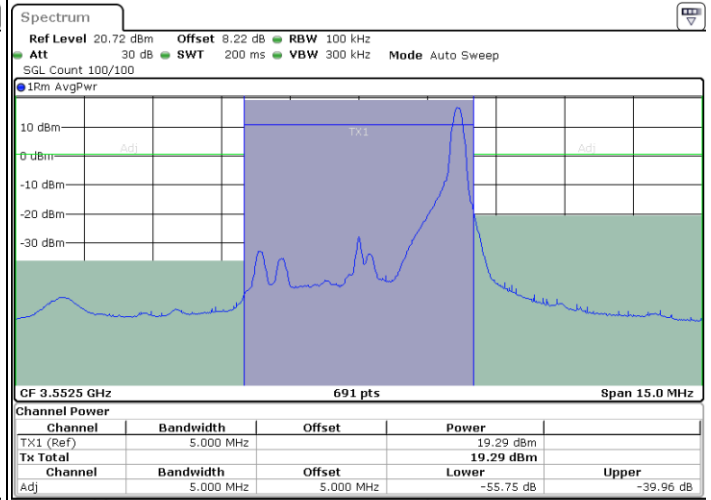

Date: 28.DEC.2021 16:54:20

Lowest Channel / FullRB

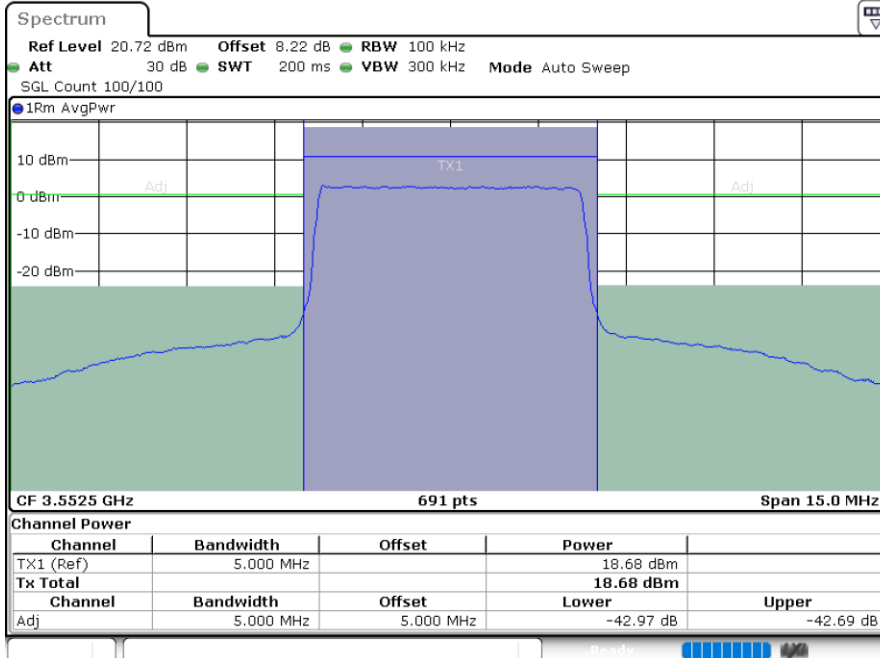

Date: 28.DEC.2021 18:06:39



LTE Band 48 / 5MHz

64QAM

Middle Channel / 1RB0

Middle Channel / 1RBmax

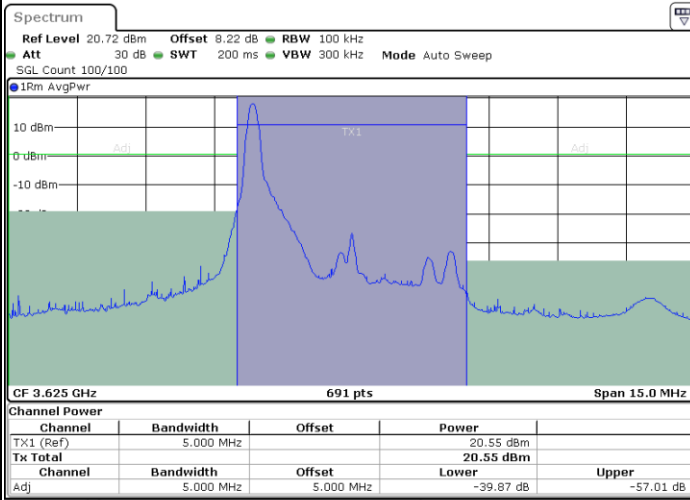

Date: 28.DEC.2021 18:38:10

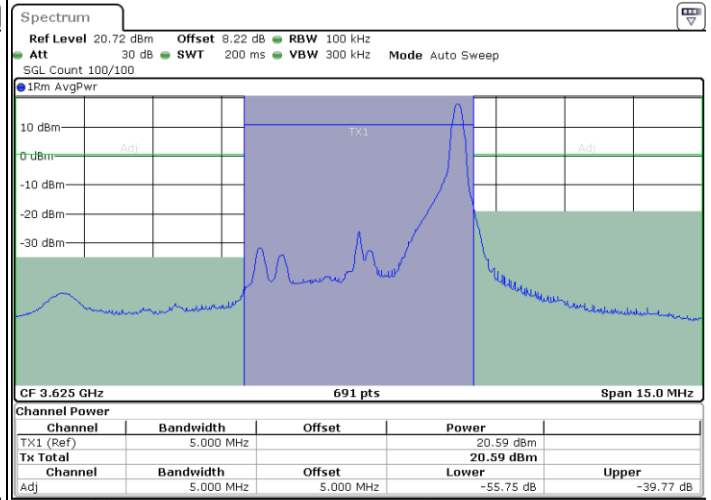

Date: 28.DEC.2021 20:16:19

Middle Channel / FullRB

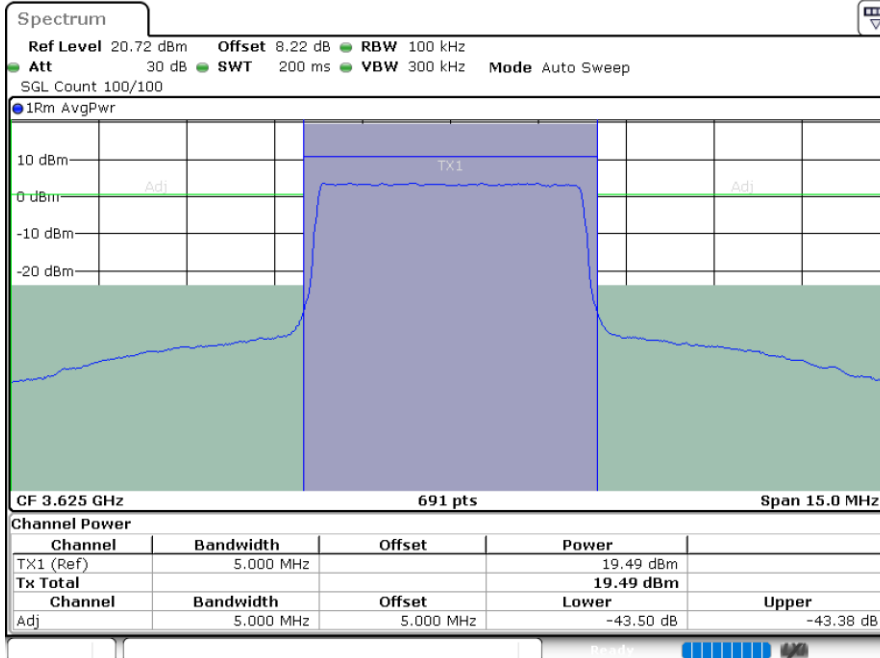

Date: 28.DEC.2021 18:30:27





**LTE Band 48 / 5MHz**

**64QAM**

**Highest Channel / 1RB0**

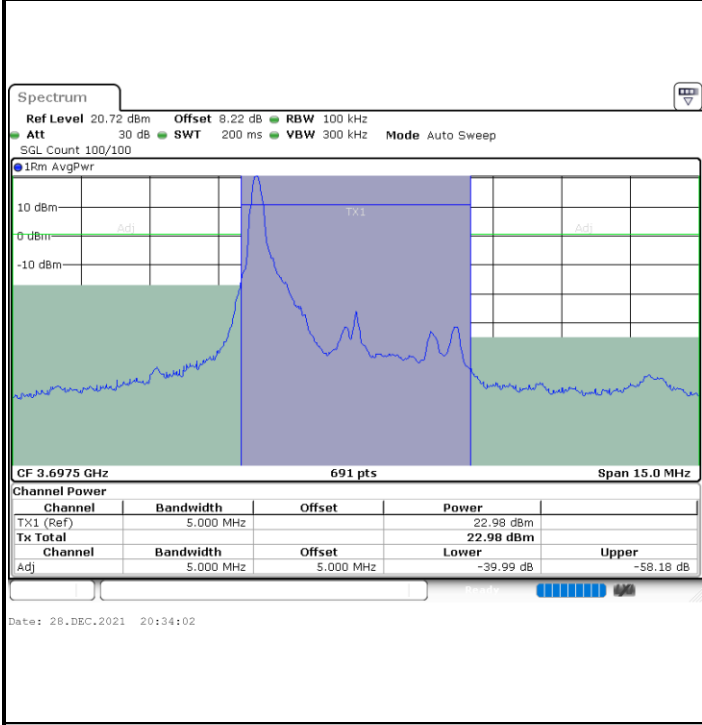

**Highest Channel / 1RBmax**

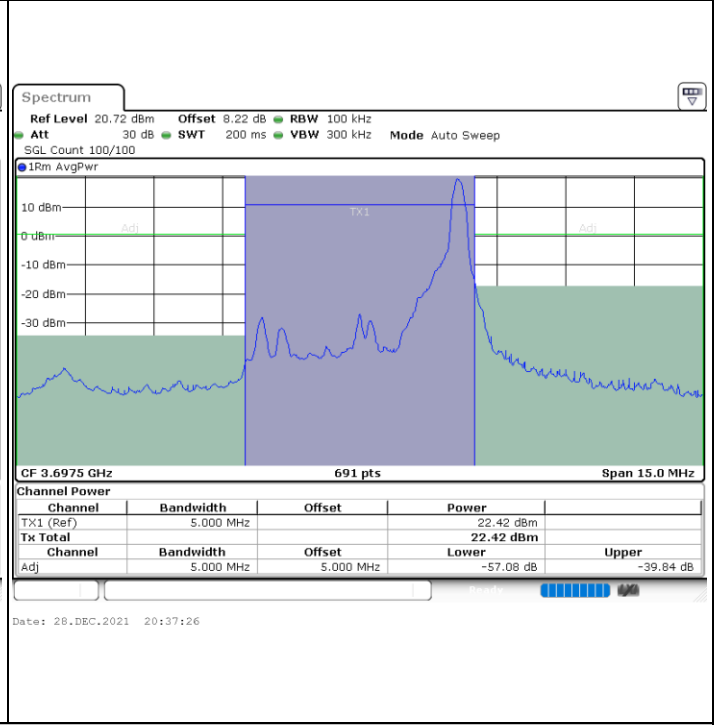

**Highest Channel / FullRB**

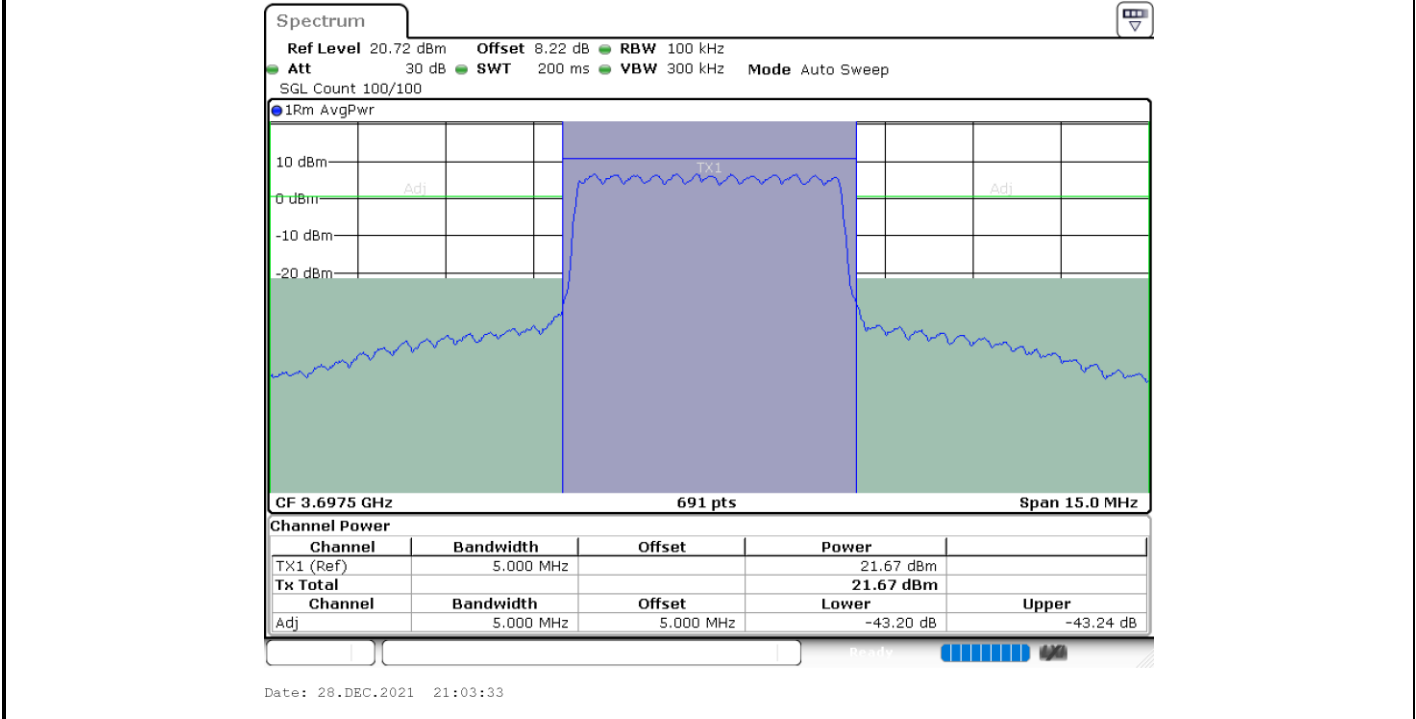



LTE Band 48 / 10MHz

64QAM

Lowest Channel / 1RB0

Lowest Channel / 1RBmax

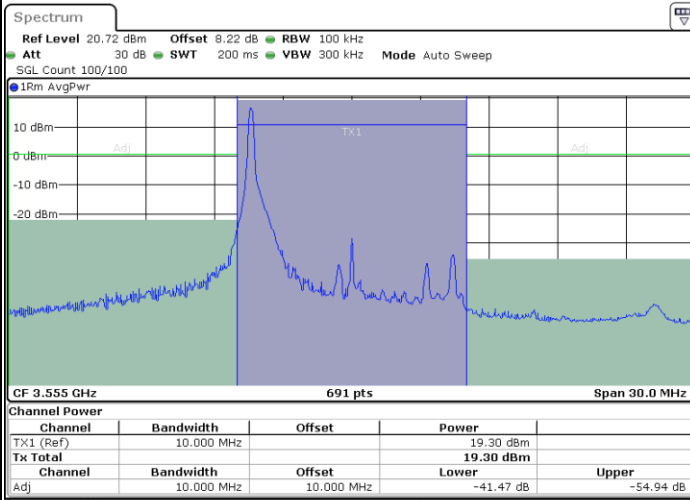

Date: 28.DEC.2021 21:23:40

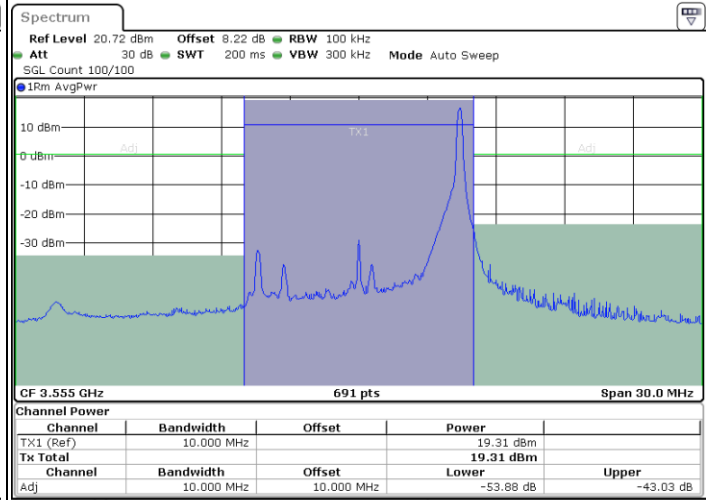

Date: 28.DEC.2021 21:37:57

Lowest Channel / FullIRB

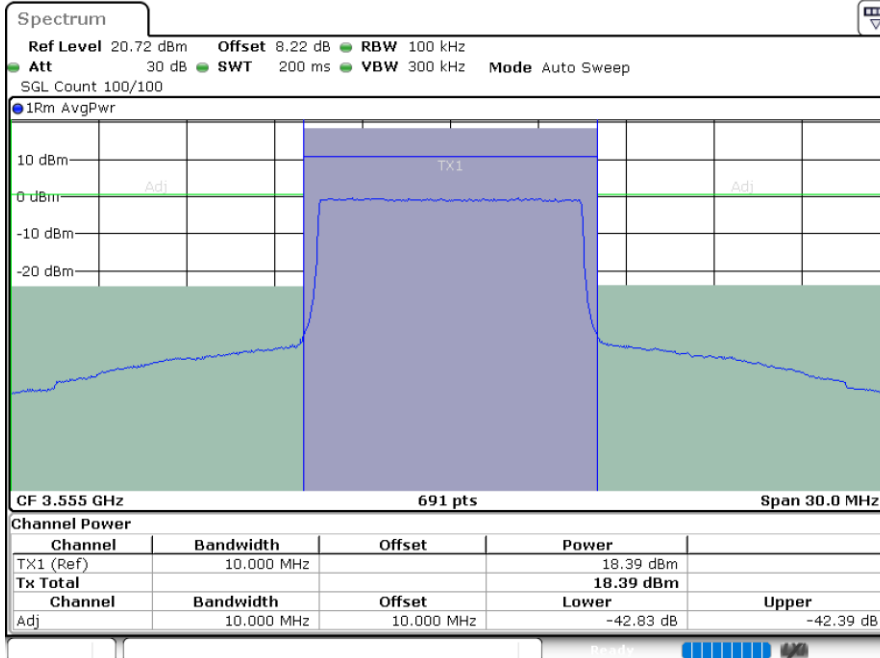

Date: 28.DEC.2021 21:41:09



LTE Band 48 / 10MHz

64QAM

MiddleChannel / 1RB0

Middle Channel / 1RBmax

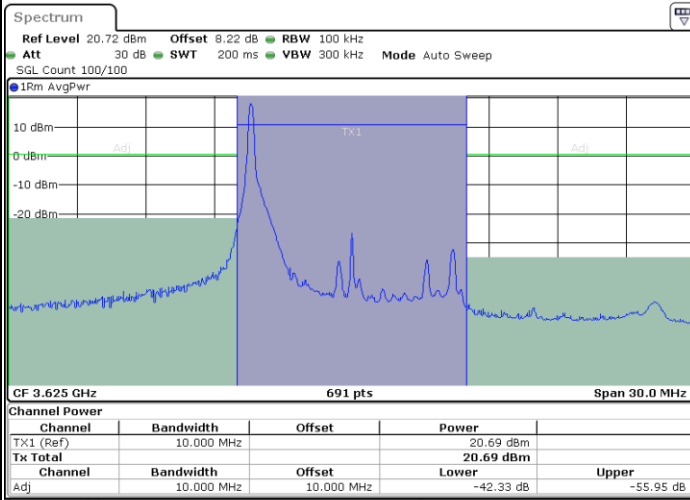

Date: 28.DEC.2021 22:09:30

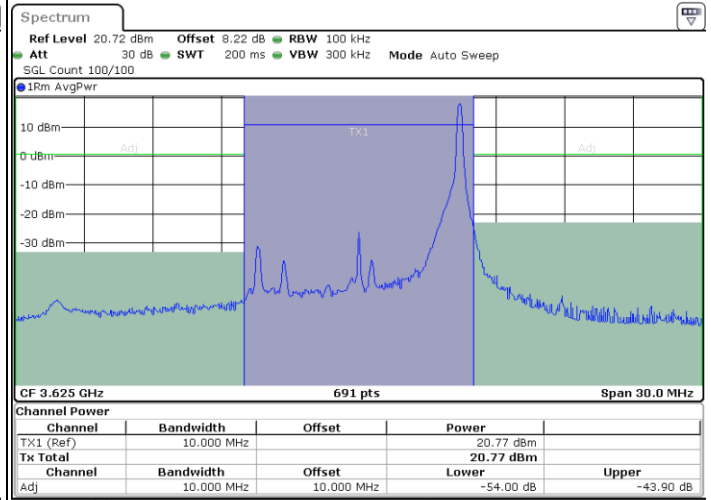

Date: 28.DEC.2021 22:27:21

Middle Channel / FullRB

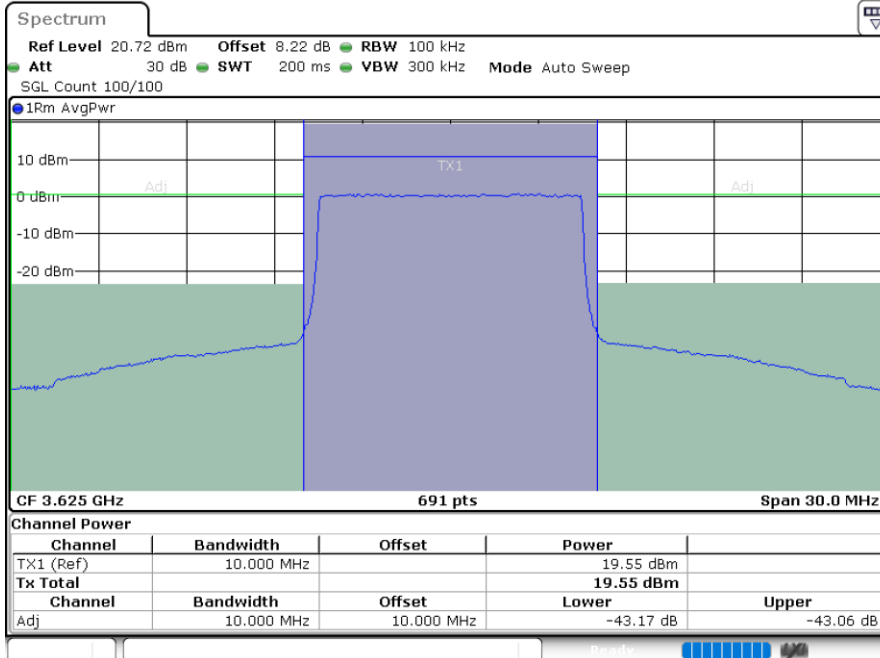

Date: 28.DEC.2021 22:31:43



LTE Band 48 / 10MHz

64QAM

Highest Channel / 1RB0

Highest Channel / 1RBmax

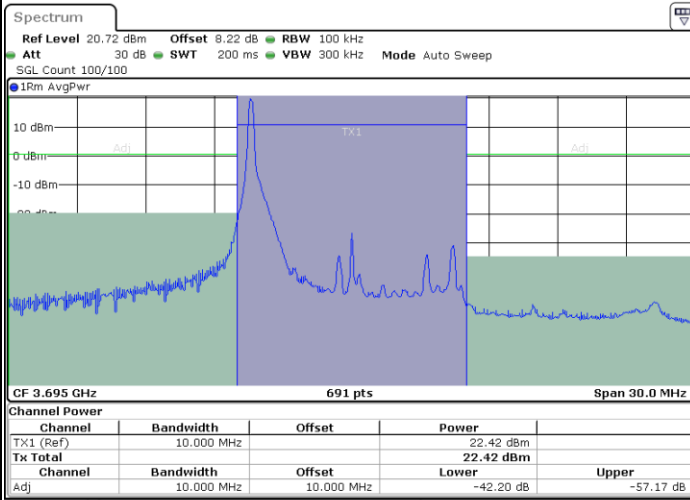

Date: 28.DEC.2021 23:07:34

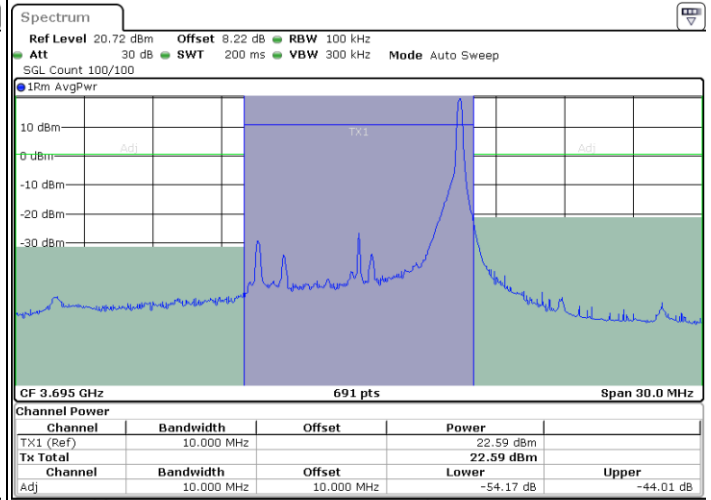

Date: 28.DEC.2021 23:24:42

Highest Channel / FullRB

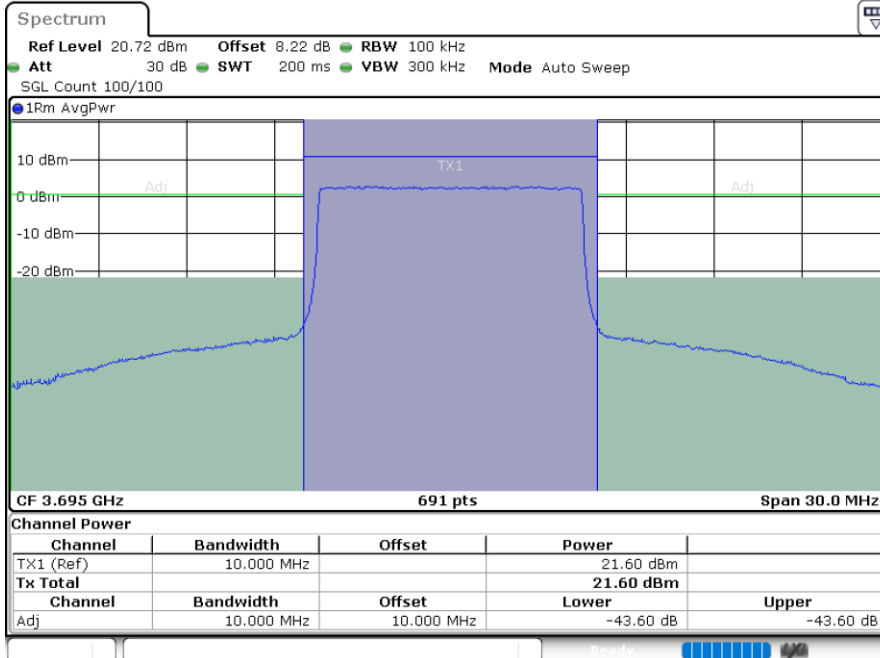

Date: 28.DEC.2021 23:52:13