

FCC Test Report

EQUIPMENT : Attila 2.5G without WiFi
Brand Name : Moto A3000
MODEL NAME : A3000
FCC ID : IHDP56JH3
STANDARD : FCC Part 15 Subpart C §15.247
CLASSIFICATION : Digital Spread Spectrum (DSS)
Applicant : Motorola Inc.
600 N. US Highway 45, Libertyville, IL 60048

The product sample received on Sep. 24, 2008 and completely tested on Oct. 25, 2008. We, SPORTON, would like to declare that the tested sample has been evaluated in accordance with the procedures given in ANSI C63.4-2003 and shown compliance with the applicable technical standards.

The test results in this report apply exclusively to the tested model / sample. Without written approval of SPORTON INTERNATIONAL INC., the test report shall not be reproduced except in full.

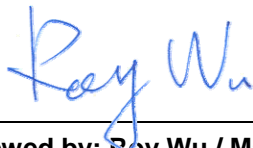

Reviewed by: Roy Wu / Manager



SPORTON INTERNATIONAL INC.

No. 52, Hwa Ya 1st Rd., Hwa Ya Technology Park, Kwei-Shan Hsiang, Tao Yuan Hsien, Taiwan, R.O.C.



TABLE OF CONTENTS

SUMMARY OF TEST RESULT 3

REVISION HISTORY..... 4

1 GENERAL DESCRIPTION..... 5

 1.1 Applicant 5

 1.2 Manufacturer..... 5

 1.3 Feature of Equipment Under Test 5

 1.4 Testing Site 7

 1.5 Applied Standards 7

 1.6 Ancillary Equipment List 7

2 TEST CONFIGURATION OF EQUIPMENT UNDER TEST..... 8

 2.1 Pre-Scanned RF Power 8

 2.2 Test Mode 9

 2.3 Connection Diagram of Test System..... 10

 2.4 RF Utility 10

3 TEST RESULT 11

 3.1 Number of Channel Measurement 11

 3.2 20dB Bandwidth Measurement 13

 3.3 Hopping Channel Separation Measurement 20

 3.4 Dwell Time Measurement..... 23

 3.5 Peak Output Power Measurement 25

 3.6 Band Edges Measurement..... 28

 3.7 AC Conducted Emission Measurement..... 35

 3.8 Radiated Emission Measurement..... 39

 3.9 Antenna Requirements 53

4 LIST OF MEASURING EQUIPMENTS 54

5 UNCERTAINTY OF EVALUATION..... 55

6 CERTIFICATION OF TAF ACCREDITATION 57

APPENDIX A. PHOTOGRAPHS OF EUT

APPENDIX B. SETUP PHOTOGRAPHS

**SUMMARY OF TEST RESULT**

Report Section	FCC Rule	IC Rule	Description	Limit	Result	Remark
3.1	15.247(b)(1)	A8.4(2)	Number of Channels	≥ 15Chs	Pass	
3.2	15.247(a)(1)	A8.1(a)	20dB Bandwidth	NA	Pass	-
3.3	15.247(a)(1)	A8.1(b)	Channel Separation	≥ 2/3 of 20dB BW	Pass	-
3.4	15.247(a)(1)	A8.1(d)	Dwell Time of Each Channel	≤ 0.4sec in 31.6sec period	Pass	-
3.5	15.247(a)(1)	A8.1(b)	Peak Output Power	≤ 0.125W	Pass	-
3.6	15.247(d)	A8.5	Frequency Band Edges	≤ 20dBc	Pass	-
3.7	15.207	Gen 7.2.2	AC Conducted Emission	15.207(a)	Pass	Under limit 8.6 dB at 0.398 MHz
3.8	15.247(d)	A8.5	Transmitter Radiated Emission	15.209(a) & 15.247(d)	Pass	Under limit 12.39 dB at 8865 MHz
3.9	15.203 & 15.247(b)	A8.4	Antenna Requirement	N/A	Pass	-



1 General Description

1.1 Applicant

Motorola Inc.
600 N. US Highway 45, Libertyville, IL 60048

1.2 Manufacturer

Motorola Inc.
600 N. US Highway 45, Libertyville, IL 60048

1.3 Feature of Equipment Under Test

Product Feature & Specification	
Equipment	Attila 2.5G without WiFi
Brand Name	Moto A3000
Model Name	A3000
Tx/Rx Frequency Range	2400 MHz ~ 2483.5 MHz
Number of Channels	79
Carrier Frequency of Each Channel	2402+n*1 MHz; n=0~78
Channel Spacing	1 MHz
Maximum Output Power to Antenna	Bluetooth : 3.39 dBm (1Mbps) Bluetooth EDR : -0.02dBm (2Mbps) / 0.43dBm (3Mbps)
Antenna Type	PIFA Antenna with gain -3 dBi
Antenna Connector Type	N/A
HW Version	0C
SW Version	1.03
Type of Modulation	Bluetooth (1Mbps) : GFSK Bluetooth EDR (2Mbps) : $\pi/4$ -DQPSK Bluetooth EDR (3Mbps) : 8-DPSK
EUT Stage	Production Unit

Accessories List:

Component Model		
AC Adapter	Brand Name	Motorola
	Model Name	FMP5202C
	Product Number	SPN5328B
	Power Rating	I/P: 100-240Vac, 50-60Hz, 120mA; O/P: 5Vdc, 850mA
	AC Power Cord Type	1.95 meter non-shielded cable without ferrite core
Battery	Brand Name	Motorola
	Model Name	BT60
	Power Rating	3.7Vdc, 1130mAh
	Type	Li-ion
Earphone	Brand Name	Motorola
	Model Name	SYN1302A
	Signal Line Type	1.2 meter non-shielded cable without ferrite core
USB Cable	Brand Name	Motorola
	Model Name	CUNC004B-T71-EF
	Signal Line Type	1.5 meter shielded cable without ferrite core
LCD Panel	Brand Name	Topoly
	Model Name	99000343

Remark:

1. The above EUT's information was declared by manufacturer. Please refer to the specifications or user's manual for more detailed description.
2. For accessories equipped with this EUT, please refer to the appendix of the external photo.

1.4 Testing Site

Test Site	SPORTON INTERNATIONAL INC.		
Test Site Location	No. 52, Hwa Ya 1 st Rd., Hwa Ya Technology Park, Kwei-Shan Hsiang, Tao Yuan Hsien, Taiwan, R.O.C TEL: +886-3-3273456 / FAX: +886-3-3284978		
Test Site No.	Sporton Site No.		FCC/IC Registration No.
	CO05-HY	03CH06-HY	TW1022/4086B-1

1.5 Applied Standards

According to the specifications of the manufacturer, the EUT must comply with the requirements of the following standards:

- ♦ FCC Part 15 Subpart C §15.247
- ♦ FCC Public Notice DA 00-705
- ♦ ANSI C63.4-2003
- ♦ IC RSS-210 Issue 7

Remark:

1. All test items were verified and recorded according to the standards and without any deviation during the test.
2. This EUT has also been tested and complied with the requirements of FCC Part 15, Subpart B (DoC) which recorded in a separate test report.

1.6 Ancillary Equipment List

Item	Equipment	Trade Name	Model Name	FCC ID	Data Cable	Power Cord
1.	Base Station	R&S	CMU 200	N/A	N/A	Unshielded, 1.8 m
2.	BT Base Station	Anritus	8852B	N/A	N/A	Unshielded, 1.8 m
3.	Notebook	DELL	D400	E2K24GBRL	N/A	AC I/P: Unshielded, 1.2 m DC O/P: Shielded, 1.8 m
4.	Bluetooth Earphone	Samsung	WEP410	A3LWEP410	N/A	N/A
5.	RS-232 Mouse	State	MS-303	DoC	Unshielded, 1.2 m	N/A
6.	i-pod	Apple	A1199	N/A	Unshielded, 1.2 m	N/A

2 Test Configuration of Equipment Under Test

2.1 Pre-Scanned RF Power

Preliminary tests were performed in different data rate and recorded the RF output power in the following table:

RF Output Power				
Channel	Frequency	Data Rate / Modulation		
		GFSK	$\pi/4$ -DQPSK	8-DPSK
		1Mbps	2Mbps	3Mbps
Ch00	2402MHz	2.18 dBm	-0.51 dBm	-0.06 dBm
Ch39	2441MHz	2.71 dBm	-0.53 dBm	-0.14 dBm
Ch78	2480MHz	3.39 dBm	-0.02 dBm	0.43 dBm

Remark:

1. The data rate 1Mbps was set for all the test cases, due to the highest RF output power.
2. The EUT is programmed to transmit signal continuously for all testing.

2.2 Test Mode

The EUT has been associated with peripherals pursuant to ANSI C63.4-2003 and configuration operated in a manner tended to maximize its emission characteristics in a typical application. Frequency range investigated: conduction (150 kHz to 30 MHz), radiation (9 kHz to the 10th harmonic of the highest fundamental frequency or to 40 GHz, whichever is lower). Pre-scanned tests were conducted to determine the final configuration from all possible combinations. The following tables are showing the test modes as the worst cases and recorded in this report.

Test Cases			
Test Item	Modulation		
	Bluetooth 1Mbps GFSK	Bluetooth EDR 2Mbps $\pi/4$ -DQPSK	Bluetooth EDR 3Mbps 8-DPSK
Conducted TCs	<ul style="list-style-type: none"> ■ Mode 1: CH00_2402 MHz ■ Mode 2: CH39_2441 MHz ■ Mode 3: CH78_2480 MHz 	<ul style="list-style-type: none"> ■ Mode 4: CH00_2402 MHz ■ Mode 5: CH39_2441 MHz ■ Mode 6: CH78_2480 MHz 	<ul style="list-style-type: none"> ■ Mode 7: CH00_2402 MHz ■ Mode 8: CH39_2441 MHz ■ Mode 9: CH78_2480 MHz
Radiated TCs	<ul style="list-style-type: none"> ■ Mode 1: CH00_2402 MHz ■ Mode 2: CH39_2441 MHz ■ Mode 3: CH78_2480 MHz 	N/A	N/A
AC Conducted Emission	Mode 1 : GSM850 Idle + BT link + Earphone + Adapter		
Remark: <ol style="list-style-type: none"> 1. The worst case of conducted TCs is Bluetooth 1Mbps, only the test data of these modes was reported. 2. The worst cases of Radiated emission were Bluetooth 1Mbps link modes; only the test data of these modes were reported. 			

2.3 Connection Diagram of Test System

<Conducted Emission>

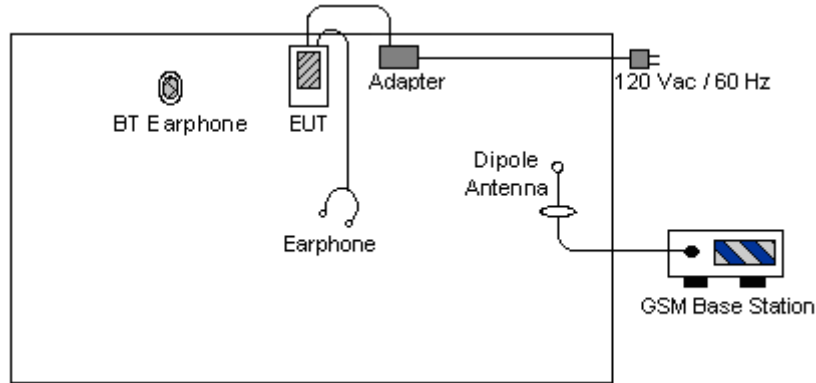

<Radiated Emission>

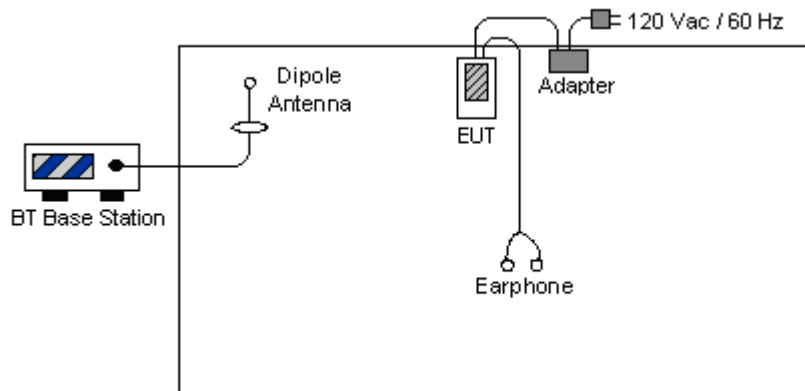

2.4 RF Utility

For Bluetooth function, the RF Utility, "BT_Test Mode" was installed in EUT which was programmed in order to make the EUT into the engineering modes to contact with BT base station for continuous transmitting and receiving signals.

3 Test Result

3.1 Number of Channel Measurement

3.1.1 Limits of Number of Hopping Frequency

Frequency hopping systems in the 2400-2483.5 MHz band shall use at least 15 channels.

3.1.2 Measuring Instruments

See list of measuring instruments of this test report.

3.1.3 Test Procedure

1. The testing follows FCC Public Notice DA 00-705 Measurement Guidelines.
2. The RF output of EUT was connected to the spectrum analyzer by a low loss cable.
3. The modulation types of EUT are irrelevant to number of hopping channels deviation.
4. The EUT must have its hopping function enabled. Use the following spectrum analyzer settings:
Span = the frequency band of operation; RBW \geq 1% of the span; VBW \geq RBW; Sweep = auto;
Detector function = peak; Trace = max hold.
5. The number of hopping frequency used is defined as the device has the numbers of total channel.

3.1.4 Test Setup

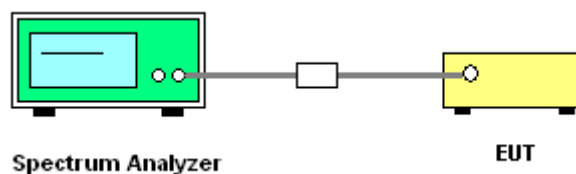

3.1.5 Test Result of Number of Hopping Frequency

Test Mode :	Mode 1~9	Temperature :	24~25°C
Test Engineer :	Jack Jeng	Relative Humidity :	48~49%
Number of Hopping Channels (Channel)		Limits (Channel)	
79		> 15	
		Pass/Fail	
		Pass	

Number of Hopping Channel Plot on Channel 00 - 78

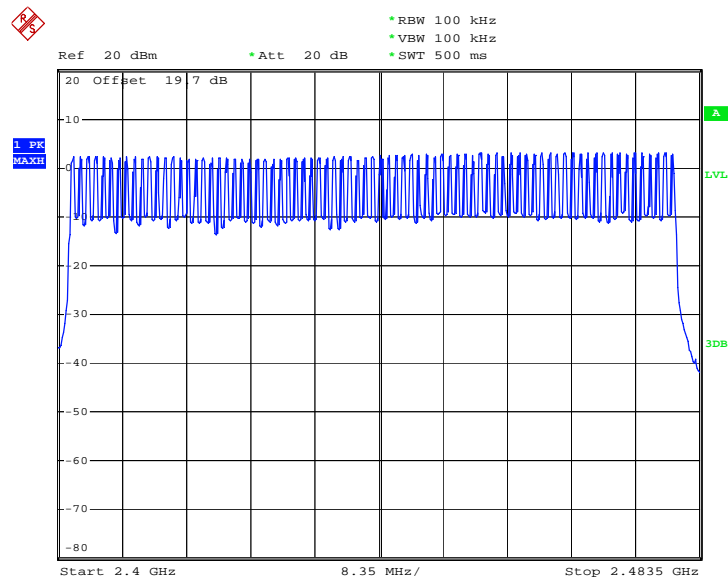

Date: 23.OCT.2008 22:43:44

3.2 20dB Bandwidth Measurement

3.2.1 Limit of 20dB Bandwidth

N/A

3.2.2 Measuring Instruments

See list of measuring instruments of this test report.

3.2.3 Test Procedures

1. The testing follows FCC Public Notice DA 00-705 Measurement Guidelines.
2. The RF output of EUT was connected to the spectrum analyzer by a low loss cable.
3. The EUT should be transmitting at its maximum data rate as the worst cases.
4. Use the following spectrum analyzer settings:
Span = approximately 2 to 3 times the 20 dB bandwidth, centered on a hopping channel;
RBW \geq 1% of the 20 dB bandwidth; VBW \geq RBW; Sweep = auto; Detector function = peak;
Trace = max hold.
5. The marker-delta reading at this point is the 20 dB bandwidth of the emission.

3.2.4 Test Setup

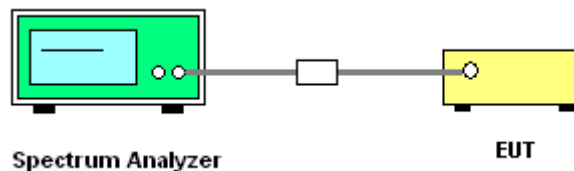



3.2.5 Test Result of 20dB Bandwidth

Test Mode :	Mode 1, 2, 3	Temperature :	24~25°C
Test Engineer :	Jack Jeng	Relative Humidity :	48~49%

Channel	Frequency (MHz)	20dB Bandwidth (MHz)
00	2402	1.026
39	2441	0.987
78	2480	0.963

20 dB Bandwidth Plot on Channel 00

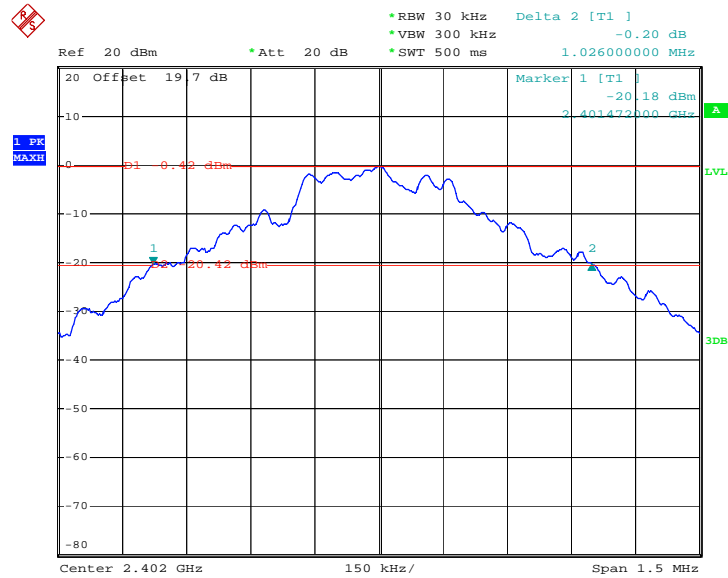

Date: 23.OCT.2008 22:23:45



20 dB Bandwidth Plot on Channel 39

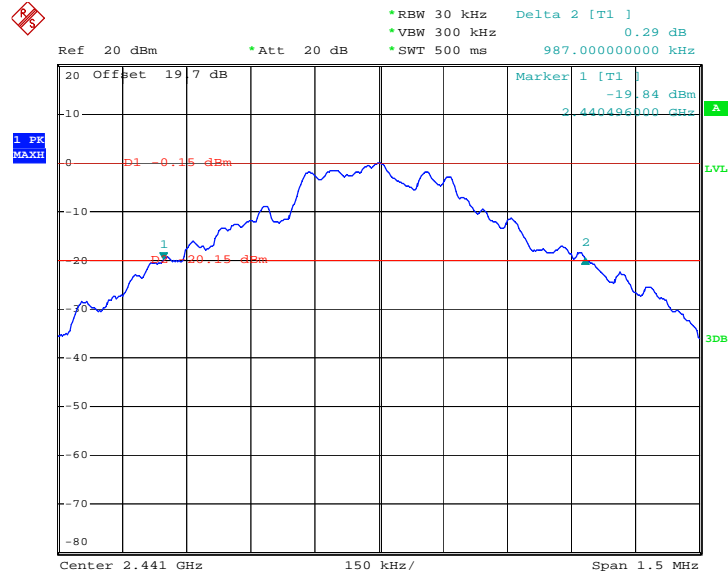

Date: 23.OCT.2008 22:24:25

20 dB Bandwidth Plot on Channel 78

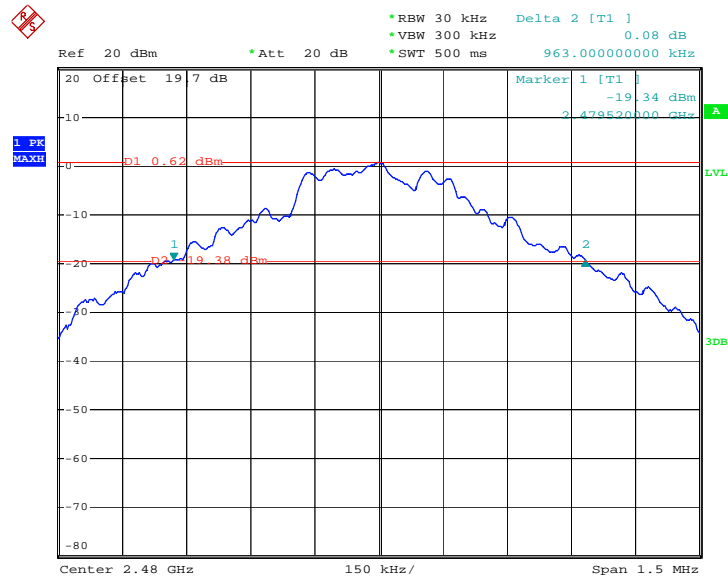

Date: 23.OCT.2008 22:25:56



Test Mode :	Mode 4, 5, 6	Temperature :	24~25°C
Test Engineer :	Jack Jeng	Relative Humidity :	48~49%

Channel	Frequency (MHz)	20dB Bandwidth (MHz)
00	2402	1.292
39	2441	1.312
78	2480	1.296

20 dB Bandwidth Plot on Channel 00

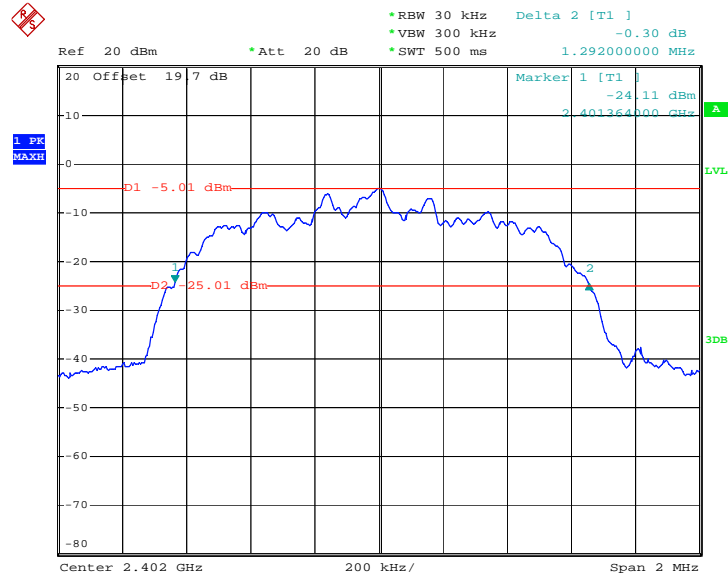

Date: 23.OCT.2008 23:04:57



20 dB Bandwidth Plot on Channel 39

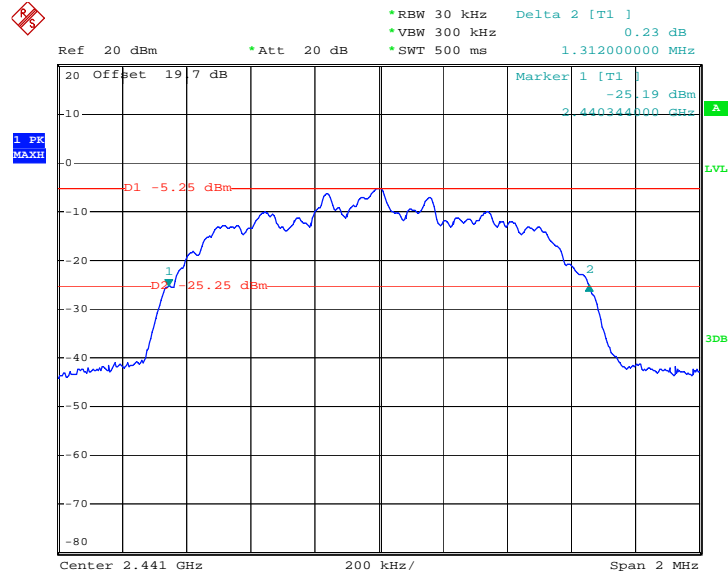

Date: 23.OCT.2008 23:07:23

20 dB Bandwidth Plot on Channel 78

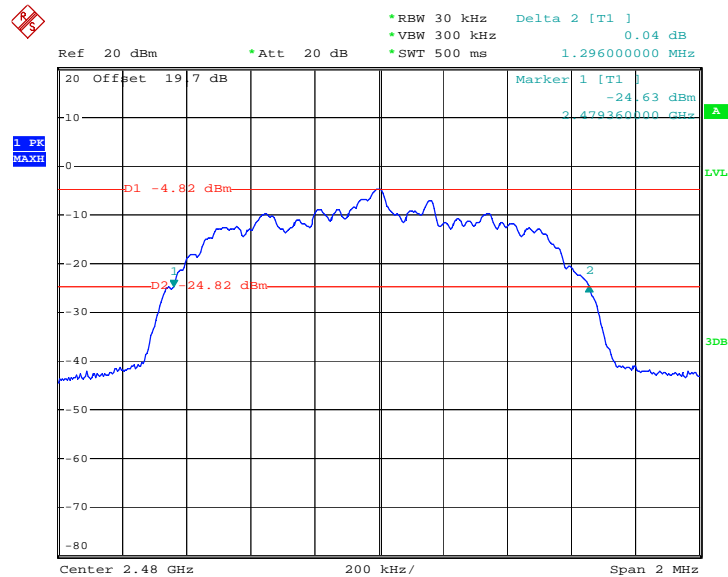

Date: 23.OCT.2008 23:08:35



Test Mode :	Mode 7, 8, 9	Temperature :	24~25°C
Test Engineer :	Jack Jeng	Relative Humidity :	48~49%

Channel	Frequency (MHz)	20dB Bandwidth (MHz)
00	2402	1.304
39	2441	1.300
78	2480	1.300

20 dB Bandwidth Plot on Channel 00

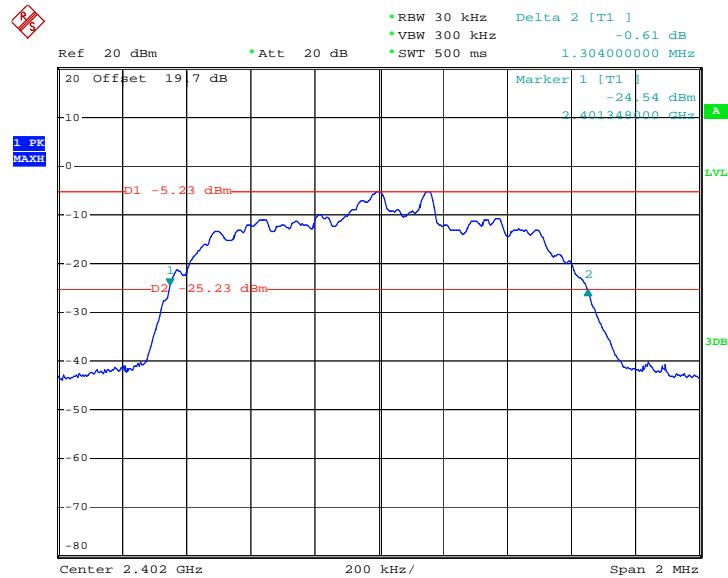

Date: 23.OCT.2008 23:17:49



20 dB Bandwidth Plot on Channel 39

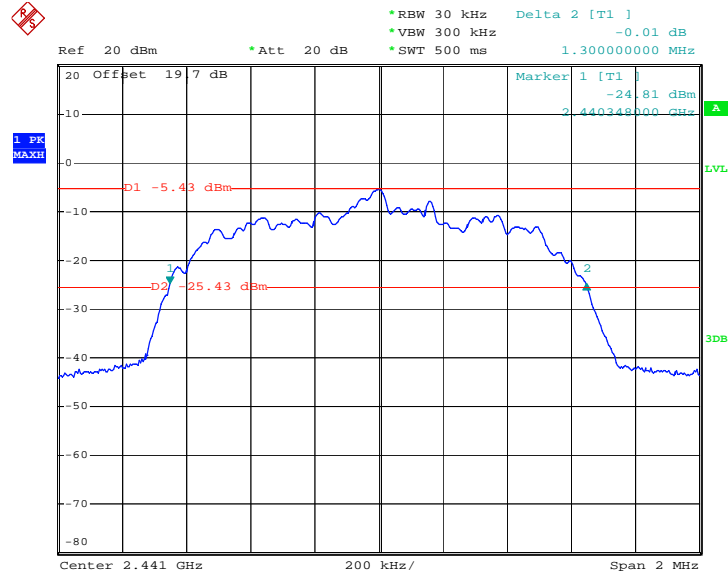

Date: 23.OCT.2008 23:15:53

20 dB Bandwidth Plot on Channel 78

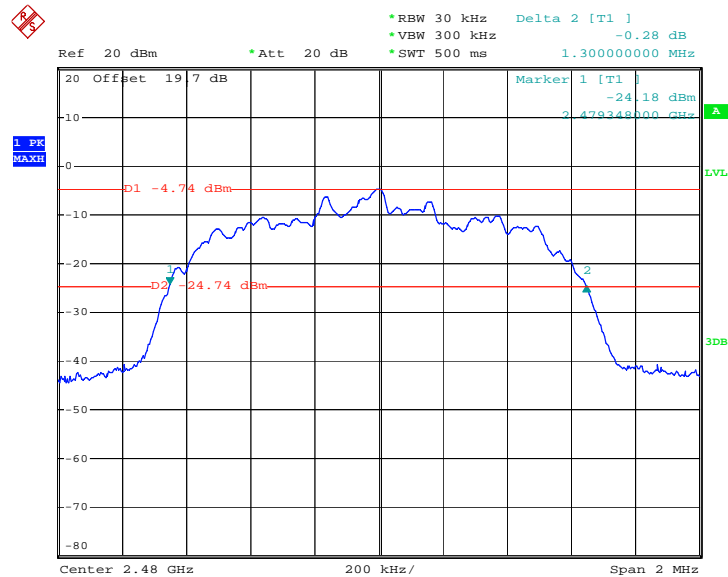

Date: 23.OCT.2008 23:13:36

3.3 Hopping Channel Separation Measurement

3.3.1 Limit of Hopping Channel Separation

Frequency hopping systems operating in the 2400-2483.5 MHz band may have hopping channel carrier frequencies that are separated by 25 kHz or two-thirds of the 20 dB bandwidth of the hopping channel, whichever is greater, provided the systems operate with an output power no greater than 125 mW.

3.3.2 Measuring Instruments

See list of measuring instruments of this test report.

3.3.3 Test Procedures

1. Please refer FCC Public Notice DA 00-705 Measurement Guidelines.
2. The RF output of EUT was connected to the spectrum analyzer by a low loss cable.
3. The EUT should be transmitting at its maximum data rate as the worst cases.
4. Use the following spectrum analyzer settings:
Span = wide enough to capture the peaks of two adjacent channels; $RBW \geq 1\%$ of the span;
 $VBW \geq RBW$; Sweep = auto; Detector function = peak; Trace = max hold.
5. Use the marker-delta function to determine the separation between the peaks of the adjacent channels.

3.3.4 Test Setup

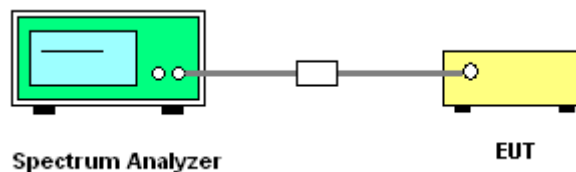



3.3.5 Test Result of Hopping Channel Separation

Test Mode :	Mode 1, 2, 3	Temperature :	24~25°C
Test Engineer :	Jack Jeng	Relative Humidity :	48~49%

Channel	Frequency (MHz)	Frequency Separation (MHz)	(2/3 of 20dB BW) Limits (MHz)	Pass/Fail
00	2402	1.000	0.684	Pass
39	2441	1.000	0.658	Pass
78	2480	1.000	0.642	Pass

Channel Separation Plot on Channel 00 - 01

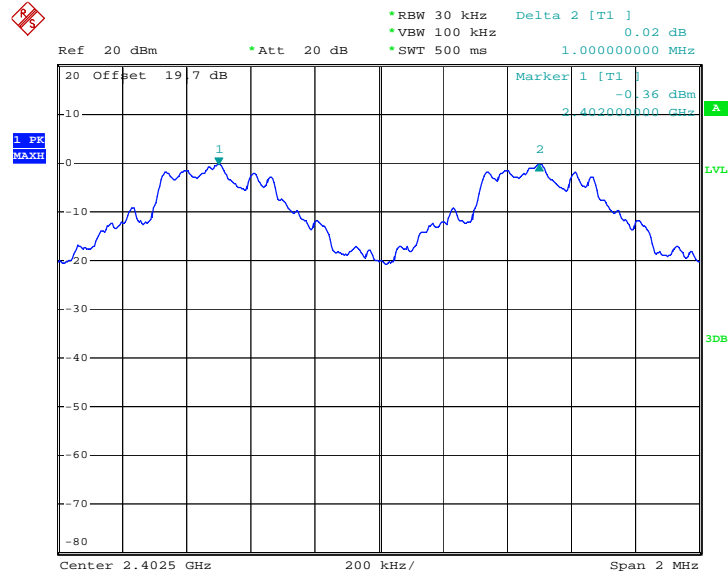

Date : 23.OCT.2008 22:28:52



Channel Separation Plot on Channel 39 - 40

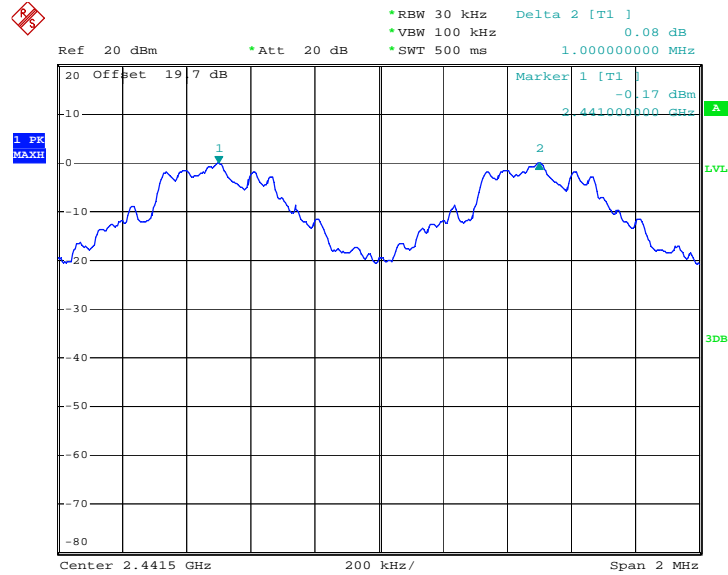

Date: 23.OCT.2008 22:29:15

Channel Separation Plot on Channel 77 - 78

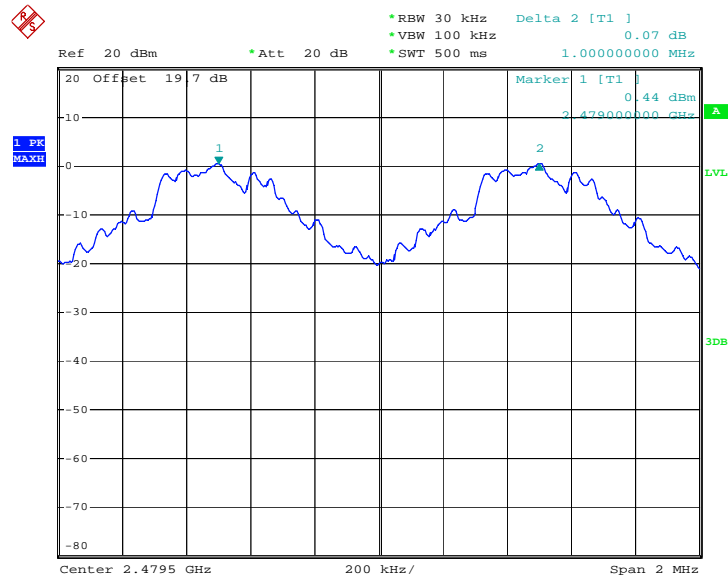

Date: 23.OCT.2008 22:29:50

3.4 Dwell Time Measurement

3.4.1 Limit of Dwell Time

The average time of occupancy on any channel shall not be greater than 0.4 seconds within a period of 0.4 seconds multiplied by the number of hopping channels employed.

3.4.2 Measuring Instruments

See list of measuring instruments of this test report.

3.4.3 Test Procedures

1. The testing follows FCC Public Notice DA 00-705 Measurement Guidelines.
2. The RF output of EUT was connected to the spectrum analyzer by a low loss cable.
3. The EUT should be transmitting at its maximum data rate as the worst cases.
4. The EUT must have its hopping function enabled. Use the following spectrum analyzer settings:
Span = zero span, centered on a hopping channel; RBW = 1 MHz; VBW ≥ RBW; Sweep = as necessary to capture the entire dwell time per hopping channel; Detector function = peak; Trace = max hold.
5. Use the marker-delta function to calculate the dwell time.

3.4.4 Test Setup

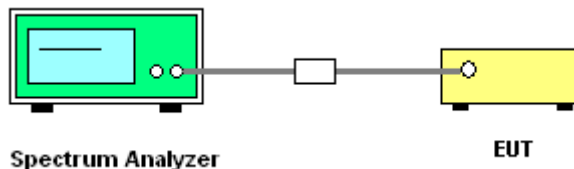

3.4.5 Test Result of Dwell Time

Test Mode :	Mode 2	Temperature :	24~25°C
Test Engineer :	Jack Jeng	Relative Humidity :	48~49%

Package Mode	Average Hopping Channel	Package Transfer Time (usec)	Dwell Time (sec)	Limits (sec)	Pass/Fail
DH5	3.70	3026.00	0.35	0.4	Pass

Remark:

1. Dwell Time=79(channels) x 0.4(s) x average hopping channel x package transfer time
2. 79 channels come from the Hopping Channel number.
3. Average Hopping Channel = hops/sweep time
4. t: Package Transfer Time(us)



DH5 Dwell Time (One Pulse) Plot on Channel 39

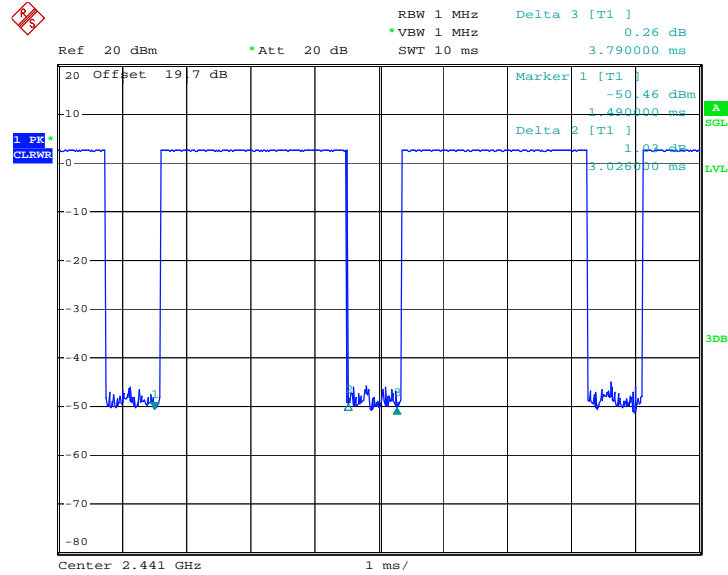

Date: 23.OCT.2008 22:33:50

DH5 Dwell Time (Count Pulses) Plot on Channel 39

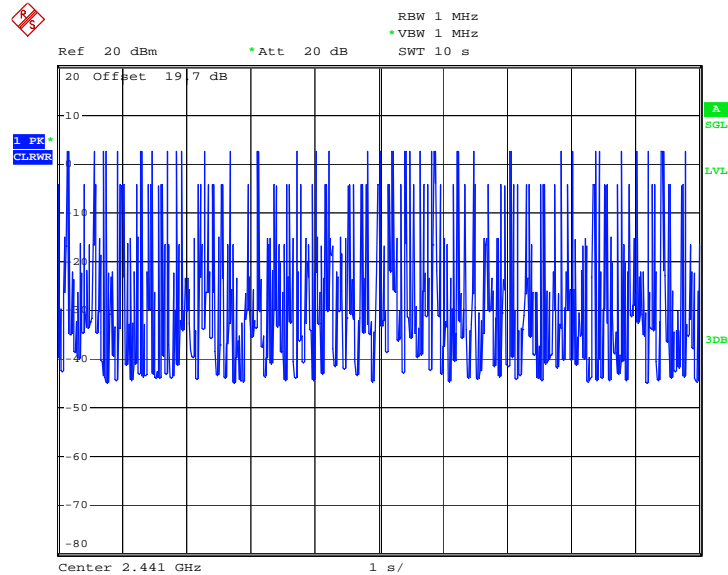

Date: 23.OCT.2008 22:38:39

3.5 Peak Output Power Measurement

3.5.1 Limit of Peak Output Power

Frequency hopping systems operating in the 2400-2483.5 MHz band may have hopping channel carrier frequencies that are separated by 25 kHz or two-thirds of the 20 dB bandwidth of the hopping channel, whichever is greater, provided the systems operate with an output power no greater than 1 W (30dBm).

3.5.2 Measuring Instruments

See list of measuring instruments of this test report.

3.5.3 Test Procedures

1. The testing follows FCC Public Notice DA 00-705 Measurement Guidelines.
2. The RF output of EUT was connected to the spectrum analyzer by a low loss cable.
3. Measure the power by spectrum analyzer.

3.5.4 Test Setup

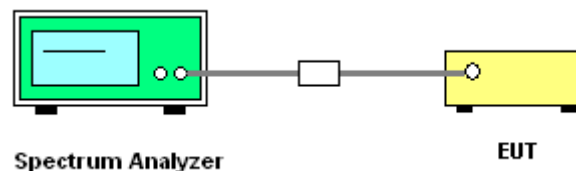



3.5.5 Test Result of Peak Output Power

Test Mode :	Mode 1, 2, 3	Temperature :	24~25°C
Test Engineer :	Jack Jeng	Relative Humidity :	48~49%

Channel	Frequency (MHz)	RF Power (dBm)		
		GFSK	Max. Limits (dBm)	Pass/Fail
		1 Mbps		
00	2402	2.18	30	Pass
39	2441	2.71	30	Pass
78	2480	3.39	30	Pass

Peak Output Power Plot on Channel 00

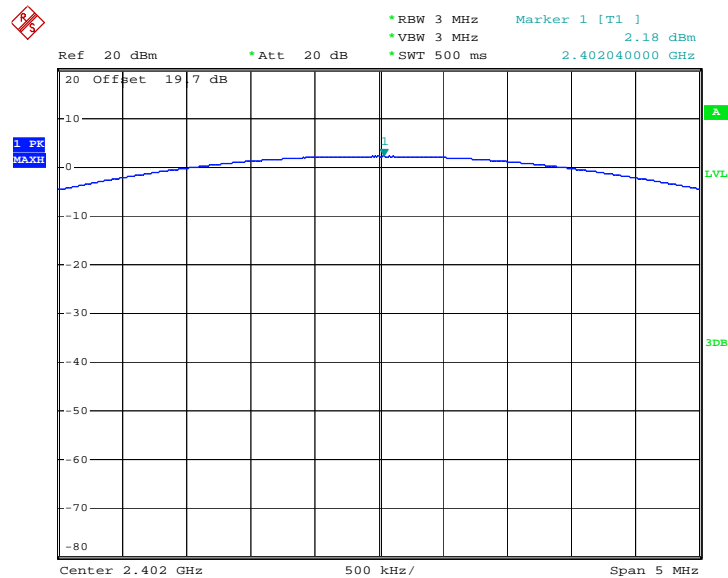

Date: 23.OCT.2008 21:42:49



Peak Output Power Plot on Channel 39

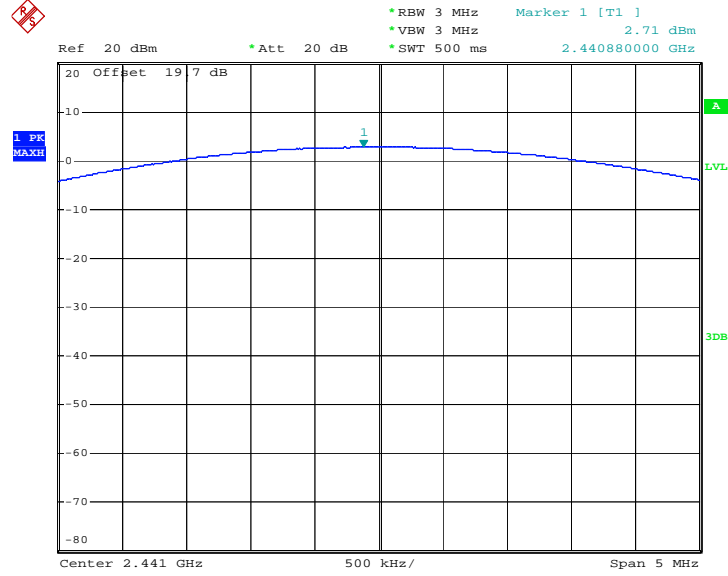

Date: 23.OCT.2008 21:48:17

Peak Output Power Plot on Channel 78

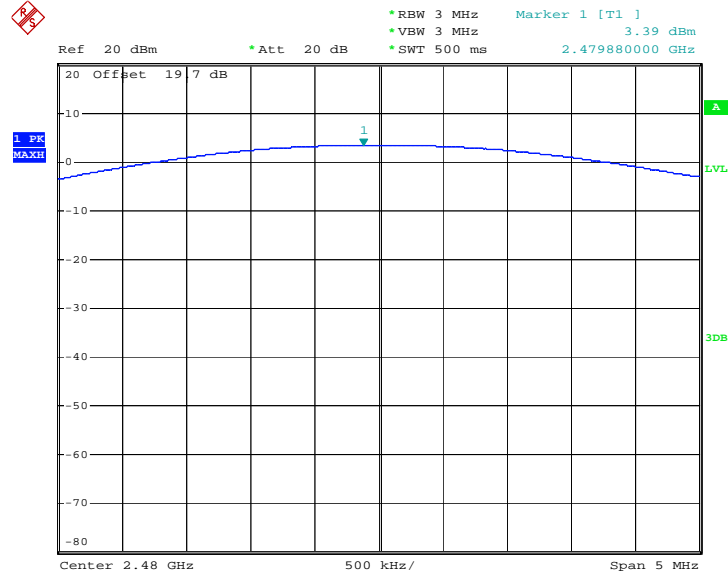

Date: 23.OCT.2008 21:48:37

3.6 Band Edges Measurement

3.6.1 Limit of Band Edges

In any 100 kHz bandwidth outside the intentional radiation frequency band, the radio frequency power shall be at least 20 dB below the highest level of the radiated power. In addition, radiated emissions which fall in the restricted bands must also comply with the radiated emission limits.

3.6.2 Measuring Instruments

See list of measuring instruments of this test report.

3.6.3 Test Procedures

1. The testing follows the guidelines in ANSI C63.4-2003 and FCC Public Notice DA 00-705 Measurement Guidelines.
2. RF antenna conducted test: Set RBW = 100 kHz, Video bandwidth (VBW) > RBW, scan up through 10th harmonic. Bandedge emissions must be at least 20 dB down from the highest emission level within the authorized band as measured with a 100 kHz RBW. Note: If the device complies with the use of power option 2 the attenuation under this paragraph shall be 30 dB instead of 20 dB.
3. Radiated emission test: Applies to bandedge emissions that fall in the restricted bands listed in FCC Section 15.205. The maximum permitted average field strength is listed in FCC Section 15.209. A pre-amp is necessary for this measurement. For measurements above 1 GHz, set RBW = 1MHz, VBW = 10 Hz, Sweep: Auto. If the emission is pulsed, modify the unit for continuous operation; use the settings shown above, then correct the reading by subtracting the peak-average correction factor, derived from the appropriate duty cycle calculation. See FCC Section 15.35(b) and (c).

3.6.4 Test Setup

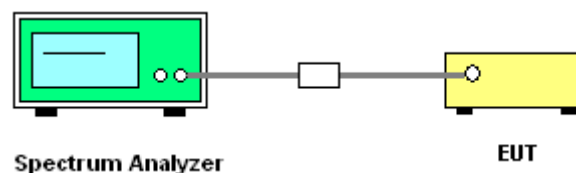



3.6.5 Test Result of Radiated Band Edges

Test Mode :	Mode 1	Temperature :	24~25°C
Test Channel :	00	Relative Humidity :	48~49%
Test Engineer :	Andrew Hsiao		

ANTENNA POLARITY : HORIZONTAL										
Frequency (MHz)	Level (dBuV/m)	Over Limit (dB)	Limit Line (dBuV/m)	Read Level (dBuV)	Antenna Factor (dB)	Cable Loss (dB)	Preamp Factor (dB)	Ant Pos (cm)	Table Pos (deg)	Remark
2385.62	19.31	-34.69	54.00	19.09	31.98	3.92	35.68	110	337	Average
2385.62	58.33	-15.67	74.00	58.11	31.98	3.92	35.68	100	0	Peak

Remark:

<Delta Marker>

Delta marker at 1% RBW of span = 40.05 dB

Peak band edge at 2385.62 MHz (RBW = VBW = 1MHz) = 98.38 dBuV/m – 40.05 dB = 58.33 dBuV/m

Duty factor = 20 log (Package Transfer Times x Avg Hopping Channel) = 20 log (0.0031 x 3.2) = -39.02

Average band edge = Peak band edge + Duty factor = 58.33 dBuV/m + (-39.02) = 19.31 dBuV/m

ANTENNA POLARITY : VERTICAL										
Frequency (MHz)	Level (dBuV/m)	Over Limit (dB)	Limit Line (dBuV/m)	Read Level (dBuV)	Antenna Factor (dB)	Cable Loss (dB)	Preamp Factor (dB)	Ant Pos (cm)	Table Pos (deg)	Remark
2384.86	13.09	-40.91	54.00	12.89	31.96	3.92	35.68	100	307	Average
2384.86	52.11	-21.89	74.00	51.91	31.96	3.92	35.68	100	0	Peak

Remark:

<Delta Marker>

Delta marker at 1% RBW of span = 40.05 dB

Peak band edge at 2384.86 MHz (RBW = VBW = 1MHz) = 92.16 dBuV/m – 40.05 dB = 52.11 dBuV/m

Duty factor = 20 log (Package Transfer Times x Avg Hopping Channel) = 20 log (0.0031 x 3.2) = -39.02

Average band edge = Peak band edge + Duty factor = 52.11 dBuV/m + (-39.02) = 13.09 dBuV/m



Test Mode :	Mode 3	Temperature :	24~25°C
Test Channel :	78	Relative Humidity :	48~49%
Test Engineer :	Andrew Hsiao		

ANTENNA POLARITY : HORIZONTAL										
Frequency (MHz)	Level (dBuV/m)	Over Limit (dB)	Limit Line (dBuV/m)	Read Level (dBuV)	Antenna Factor (dB)	Cable Loss (dB)	Preamp Factor (dB)	Ant Pos (cm)	Table Pos (deg)	Remark
2483.66	13.10	-40.90	54.00	12.67	32.08	4.05	35.70	102	354	Average
2483.66	52.12	-21.88	74.00	51.69	32.08	4.05	35.70	100	0	Peak

Remark:

<Delta Marker>

Delta marker at 1% RBW of span = 47.86 dB

Peak band edge at 2483.66 MHz (RBW = VBW = 1MHz) = 99.98 dBuV/m – 47.86 dB = 52.12 dBuV/m

Duty factor = 20 log (Package Transfer Times x Avg Hopping Channel) = 20 log (0.0031 x 3.2) = -39.02

Average band edge = Peak band edge + Duty factor = 52.12 dBuV/m + (-39.02) = 13.10 dBuV/m

ANTENNA POLARITY : VERTICAL										
Frequency (MHz)	Level (dBuV/m)	Over Limit (dB)	Limit Line (dBuV/m)	Read Level (dBuV)	Antenna Factor (dB)	Cable Loss (dB)	Preamp Factor (dB)	Ant Pos (cm)	Table Pos (deg)	Remark
2483.50	6.43	-47.57	54.00	6.00	32.08	4.05	35.70	117	291	Average
2483.50	45.45	-28.55	74.00	45.02	32.08	4.05	35.70	100	0	Peak

Remark:

<Delta Marker>

Delta marker at 1% RBW of span = 47.86 dB

Peak band edge at 2483.50 MHz (RBW = VBW = 1MHz) = 93.31 dBuV/m – 47.86 dB = 45.45 dBuV/m

Duty factor = 20 log (Package Transfer Times x Avg Hopping Channel) = 20 log (0.0031 x 3.2) = -39.02

Average band edge = Peak band edge + Duty factor = 45.45 dBuV/m + (-39.02) = 6.43 dBuV/m



Test Mode :	Mode 3	Temperature :	24~25°C
Test Channel :	78	Relative Humidity :	48~49%
Test Engineer :	Jack Jeng		

High Band Edge Plot on Channel 78

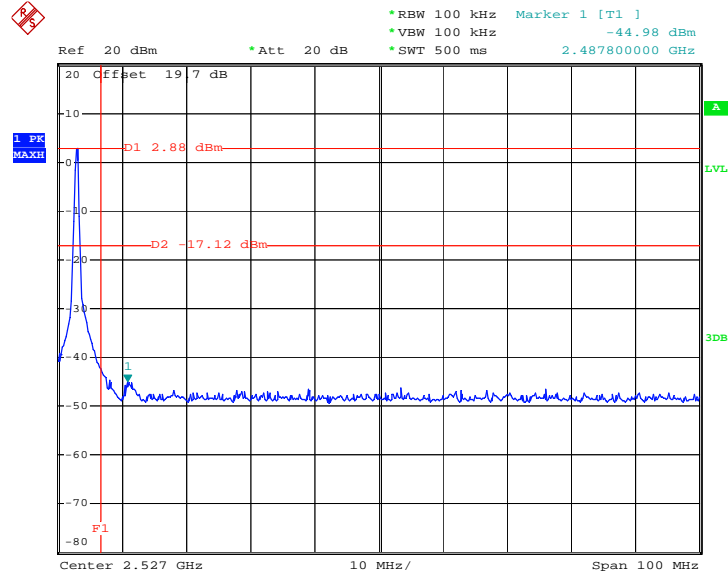

Date: 23.OCT.2008 22:26:52



Test Mode :	Mode 7	Temperature :	24~25°C
Test Channel :	00	Relative Humidity :	48~49%
Test Engineer :	Jack Jeng		

Low Band Edge Plot on Channel 00

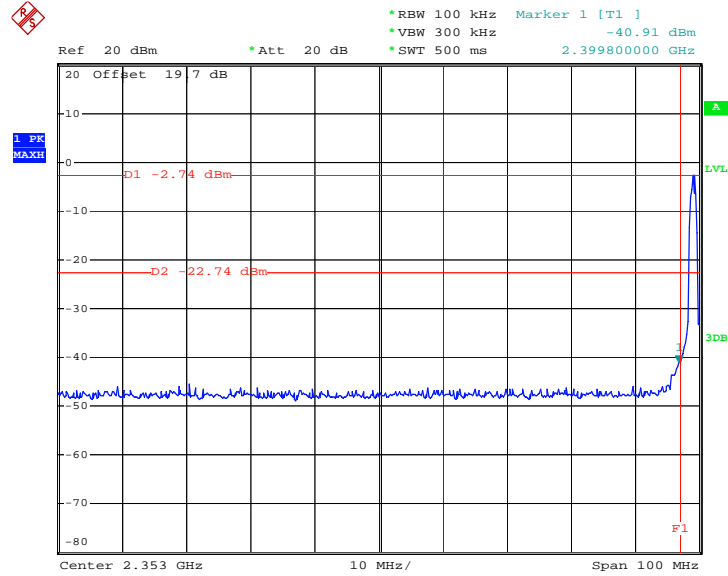

Date: 23.OCT.2008 23:19:01



Test Mode :	Mode 9	Temperature :	24~25°C
Test Channel :	78	Relative Humidity :	48~49%
Test Engineer :	Jack Jeng		

High Band Edge Plot on Channel 78

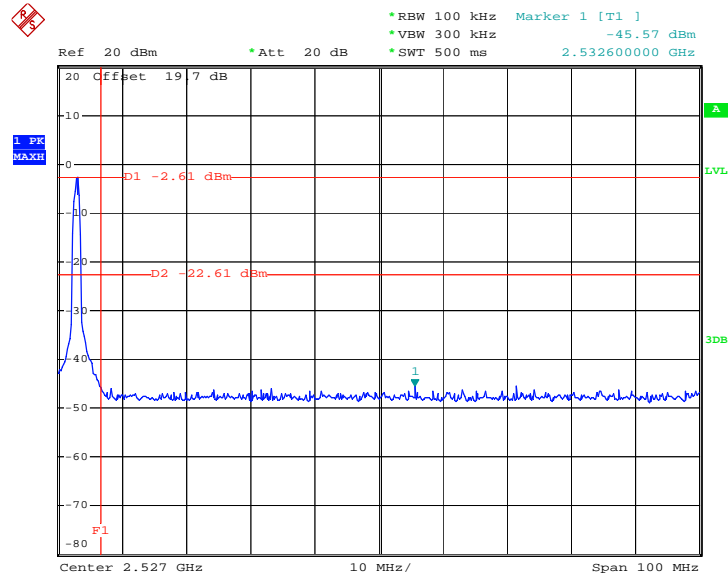

Date: 23.OCT.2008 23:20:09

3.7 AC Conducted Emission Measurement

3.7.1 Limit of AC Conducted Emission

For equipment that is designed to be connected to the public utility (AC) power line, the radio frequency voltage that is conducted back onto the AC power line on any frequency or frequencies within the band 150 kHz to 30 MHz shall not exceed the limits in the following table.

Frequency of emission (MHz)	Conducted limit (dBuV)	
	Quasi-peak	Average
0.15-0.5	66 to 56*	56 to 46*
0.5-5	56	46
5-30	60	50

*Decreases with the logarithm of the frequency.

3.7.2 Measuring Instruments

See list of measuring instruments of this test report.

3.7.3 Test Procedures

1. Please follow the guidelines in ANSI C63.4-2003.
2. The EUT was placed 0.4 meter from the conducting wall of the shielding room was kept at least 80 centimeters from any other grounded conducting surface.
3. Connect EUT to the power mains through a line impedance stabilization network (LISN).
4. All the support units are connecting to the other LISN.
5. The LISN provides 50 ohm coupling impedance for the measuring instrument.
6. The FCC states that a 50 ohm, 50 microhenry LISN should be used.
7. Both sides of AC line were checked for maximum conducted interference.
8. The frequency range from 150 kHz to 30 MHz was searched.
9. Set the test-receiver system to Peak Detect Function and specified bandwidth with Maximum Hold Mode.

3.7.4 Test Setup

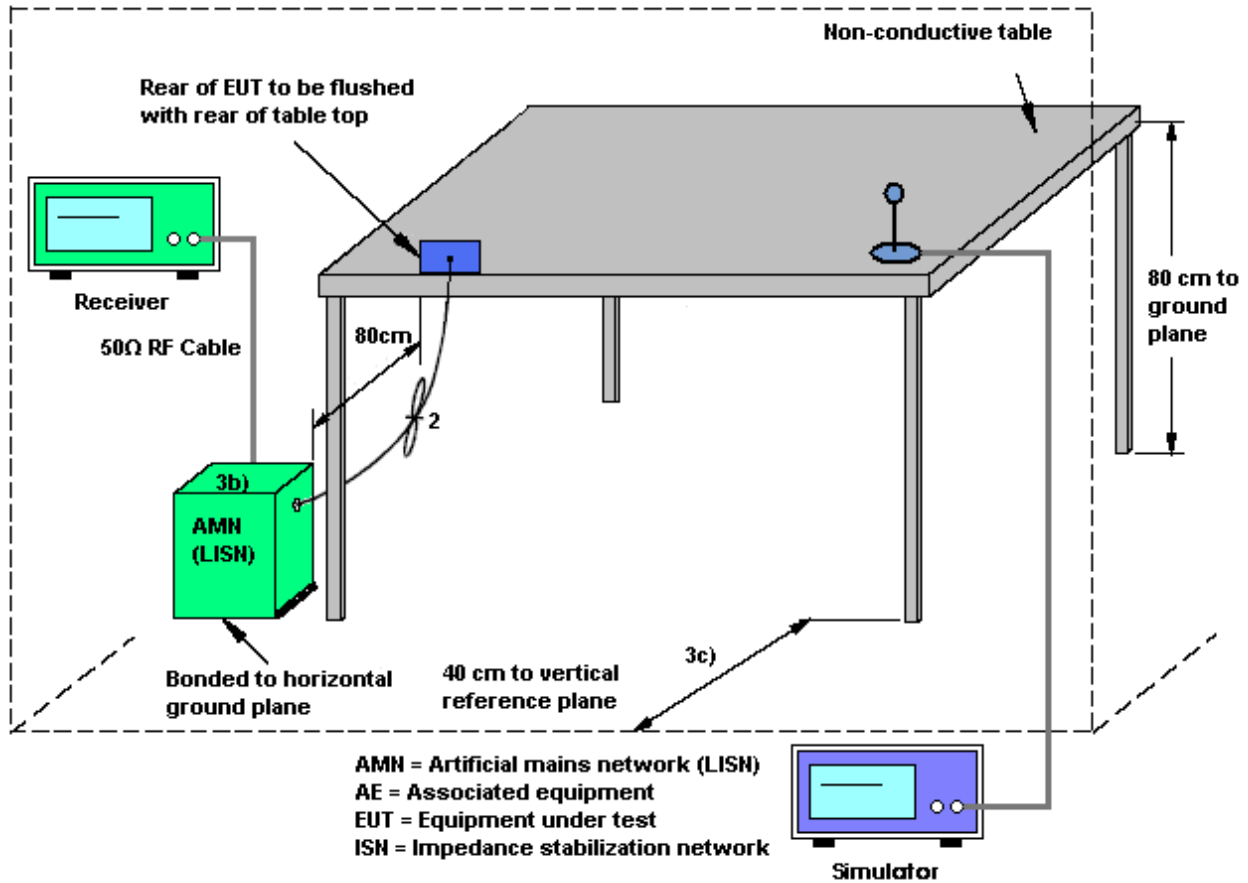

3.7.5 Test Result of AC Conducted Emission

Test Mode :	Mode 1	Temperature :	24~25°C
Test Engineer :	Cona Huang	Relative Humidity :	48~49%
		Phase :	Line
Function Type :	GSM850 Idle + BT link + Earphone + Adapter		
Remark :	All emissions not reported here are more than 10 dB below the prescribed limit.		

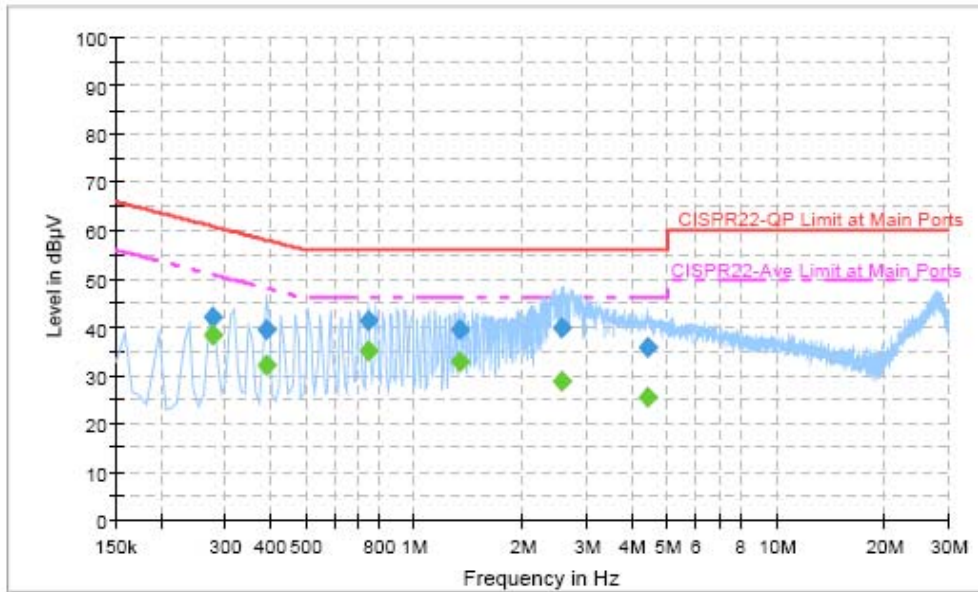

Final Result 1

Frequency (MHz)	QuasiPeak (dBµV)	Filter	Line	Corr. (dB)	Margin (dB)	Limit (dBµV)
0.278000	42.0	Off	L1	19.3	18.9	60.9
0.390000	39.4	Off	L1	19.4	18.7	58.1
0.750000	41.2	Off	L1	19.4	14.8	56.0
1.334000	39.5	Off	L1	19.4	16.5	56.0
2.558000	40.0	Off	L1	19.5	16.0	56.0
4.446000	36.0	Off	L1	19.5	20.0	56.0

Final Result 2

Frequency (MHz)	Average (dBµV)	Filter	Line	Corr. (dB)	Margin (dB)	Limit (dBµV)
0.278000	38.5	Off	L1	19.3	12.4	50.9
0.390000	32.3	Off	L1	19.4	15.8	48.1
0.750000	35.2	Off	L1	19.4	10.8	46.0
1.334000	32.8	Off	L1	19.4	13.2	46.0
2.558000	28.9	Off	L1	19.5	17.1	46.0
4.446000	25.6	Off	L1	19.5	20.4	46.0

Test Mode :	Mode 1	Temperature :	24~25°C
Test Engineer :	Cona Huang	Relative Humidity :	48~49%
		Phase :	Neutral
Function Type :	GSM850 Idle + BT link + Earphone + Adapter		
Remark :	All emissions not reported here are more than 10 dB below the prescribed limit.		

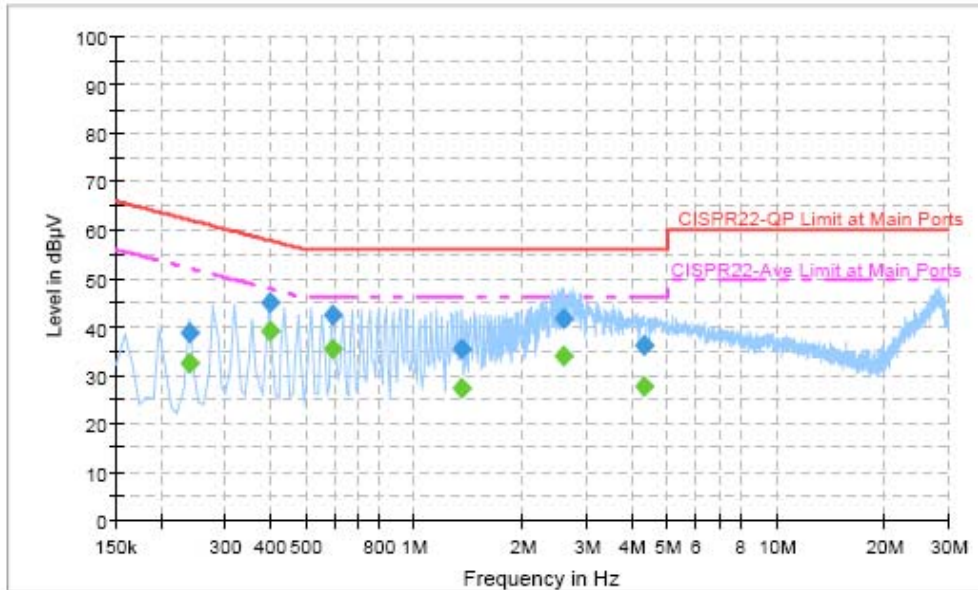

Final Result 1

Frequency (MHz)	QuasiPeak (dBµV)	Filter	Line	Corr. (dB)	Margin (dB)	Limit (dBµV)
0.238000	38.9	Off	N	19.4	23.3	62.2
0.398000	44.9	Off	N	19.4	13.0	57.9
0.598000	42.3	Off	N	19.4	13.7	56.0
1.350000	35.3	Off	N	19.5	20.7	56.0
2.590000	41.7	Off	N	19.5	14.3	56.0
4.310000	36.3	Off	N	19.5	19.7	56.0

Final Result 2

Frequency (MHz)	Average (dBµV)	Filter	Line	Corr. (dB)	Margin (dB)	Limit (dBµV)
0.238000	32.4	Off	N	19.4	19.8	52.2
0.398000	39.3	Off	N	19.4	8.6	47.9
0.598000	35.3	Off	N	19.4	10.7	46.0
1.350000	27.1	Off	N	19.5	18.9	46.0
2.590000	33.9	Off	N	19.5	12.1	46.0
4.310000	27.7	Off	N	19.5	18.3	46.0

3.8 Radiated Emission Measurement

3.8.1 Limit of Radiated Emission

In any 100 kHz bandwidth outside the intentional radiator frequency band, all harmonics/spurious must be at least 20 dB below the highest emission level within the authorized band. In addition, radiated emissions which fall in the restricted bands must also comply with the FCC section 15.209 limits as below.

Frequency (MHz)	Field Strength (microvolts/meter)	Measurement Distance (meters)
0.009 – 0.490	2400/F(kHz)	300
0.490 – 1.705	24000/F(kHz)	30
1.705 – 30.0	30	30
30 – 88	100	3
88 – 216	150	3
216 - 960	200	3
Above 960	500	3

3.8.2 Measuring Instruments

See list of measuring instruments of this test report.

3.8.3 Test Procedures

1. The testing follows the guidelines in FCC Public Notice DA 00-705 Measurement Guidelines.
2. Use the following spectrum analyzer settings:
Span = wide enough to fully capture the emission being measured; RBW = 1 MHz for $f \geq 1$ GHz, 100 kHz for $f < 1$ GHz; VBW \geq RBW; Sweep = auto; Detector function = peak; Trace = max hold.
3. Follow the guidelines in ANSI C63.4-2003 with respect to maximizing the emission by rotating the EUT, measuring the emission for three EUT orthogonal planes, and adjusting the measurement antenna height and polarization. A pre-amp and a high pass filter are used for this test in order to get the good signal level.

3.8.4 Test Setup

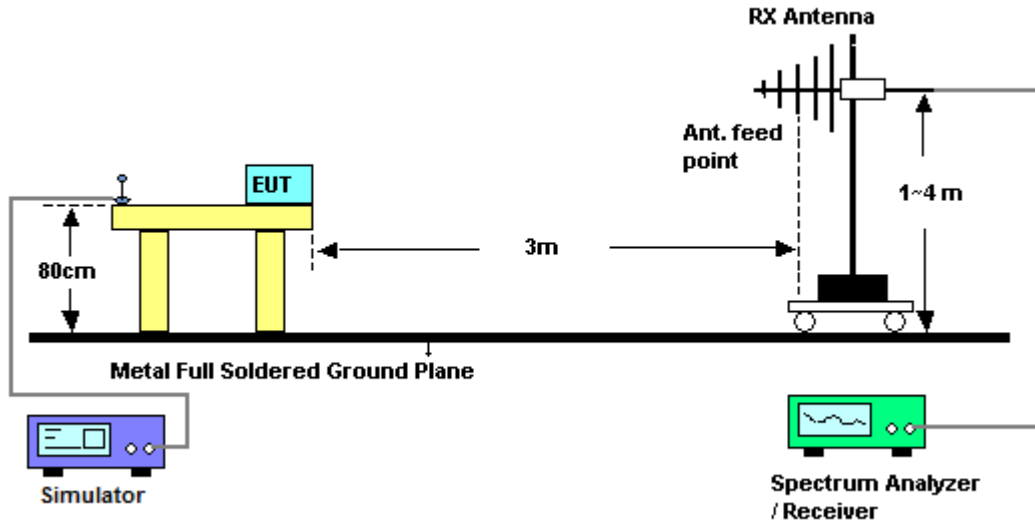



3.8.5 Test Result of Radiated Emission < 1GHz

Test Mode :	Mode 1	Temperature :	24~25°C
Test Channel :	00	Relative Humidity :	48~49%
Test Engineer :	Andrew Hsiao	Polarization :	Horizontal
Remark :			

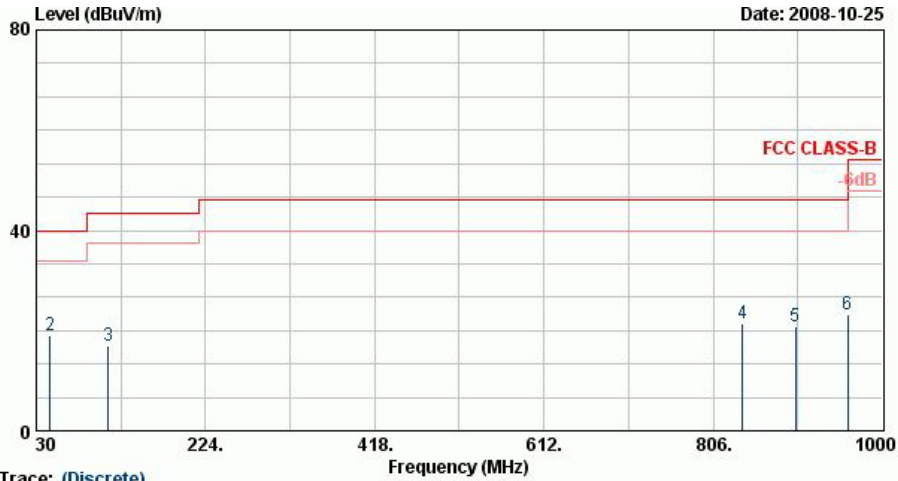

Trace: (Discrete)
 Site : 03CH06-RY
 Condition : FCC CLASS-B 3m LF-ANT(951121) HORIZONTAL
 Model : FR 892435
 Mode : Mode 1

	Freq	Level	Over	Limit	ReadAntenna	Cable	Preamp	Ant	Table	Remark
	MHz	dBuV/m	dB	dBuV/m	dBuV	dB	dB	cm	deg	
1	30.27	16.28	-23.72	40.00	27.88	19.66	0.30	31.56	---	Peak
2	45.93	18.97	-21.03	40.00	39.90	10.53	0.30	31.77	100	332 Peak
3	112.89	16.91	-26.59	43.50	36.26	11.97	0.50	31.82	---	Peak
4	839.70	21.48	-24.52	46.00	32.53	20.10	1.20	32.36	---	Peak
5	900.60	20.82	-25.18	46.00	30.65	20.54	1.30	31.67	---	Peak
6	960.10	23.13	-30.87	54.00	32.15	20.96	1.30	31.28	---	Peak



Test Mode :	Mode 1	Temperature :	24~25°C
Test Channel :	00	Relative Humidity :	48~49%
Test Engineer :	Andrew Hsiao	Polarization :	Vertical
Remark :			

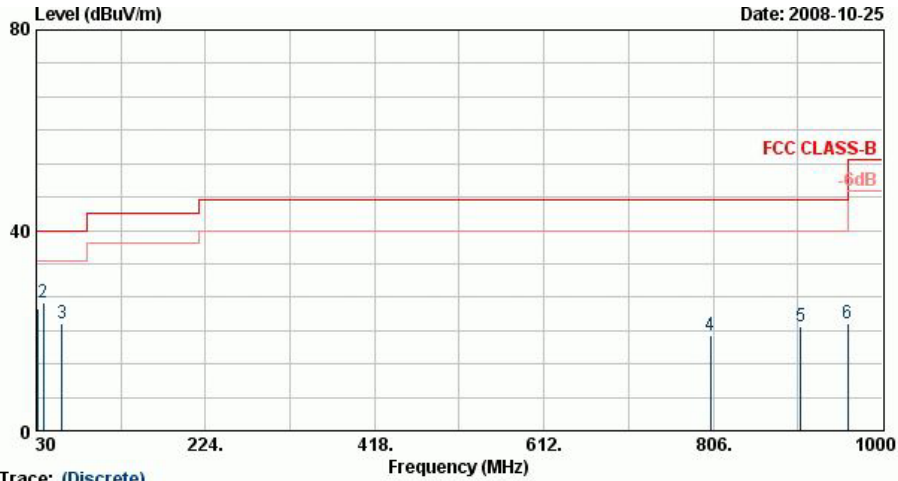

Trace: (Discrete)
 Site : 03CH06-HY
 Condition : FCC CLASS-B 3m LF-ANT(851121) VERTICAL
 Model : FR 892435
 Mode : Mode 1

	Freq	Level	Over	Limit	Read	Antenna	Cable	Preamp	Ant	Table	Remark
	MHz	dBuV/m	dB	dBuV/m	Level	Factor	Loss	Factor	Pos	Pos	
					dBuV	dB/m	dB	dB	cm	deg	
1	31.62	24.48	-15.52	40.00	37.60	18.25	0.30	31.67	---	---	Peak
2	38.10	25.48	-14.52	40.00	42.37	14.56	0.30	31.75	100	332	Peak
3	59.70	21.44	-18.56	40.00	46.47	6.62	0.40	32.05	---	---	Peak
4	802.60	19.11	-26.89	46.00	30.26	19.83	1.20	32.19	---	---	Peak
5	906.20	20.90	-25.10	46.00	30.67	20.57	1.30	31.64	---	---	Peak
6	960.10	21.33	-32.67	54.00	30.35	20.96	1.30	31.28	---	---	Peak



Test Mode :	Mode 2	Temperature :	24~25°C
Test Channel :	39	Relative Humidity :	48~49%
Test Engineer :	Andrew Hsiao	Polarization :	Horizontal
Remark :			

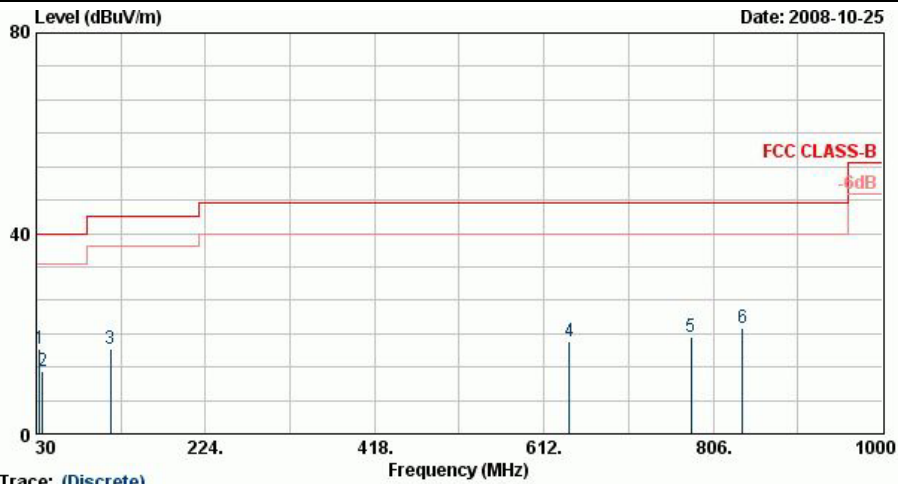

Site :
Condition :
Model :
Mode :

Trace: (Discrete)
: 03CH06-HV
: FCC CLASS-B 3m LF-ANT(051121) HORIZONTAL
: FR 892435
: Mode 2

	Freq	Level	Over	Limit	Read	Antenna	Cable	Preamp	Ant	Table	Remark
	MHz	dBuV/m	dB	dBuV/m	Level	Factor	Loss	Factor	Pos	Pos	
					dBuV	dB/m	dB	dB	cm	deg	
1	33.78	16.94	-23.06	40.00	31.58	16.84	0.30	31.78	100	219	Peak
2	37.29	12.54	-27.46	40.00	29.43	14.56	0.30	31.75	---	---	Peak
3	114.78	16.90	-26.60	43.50	36.07	12.13	0.50	31.80	---	---	Peak
4	640.90	18.48	-27.52	46.00	30.67	18.64	1.10	31.93	---	---	Peak
5	780.20	19.45	-26.55	46.00	30.75	19.63	1.20	32.13	---	---	Peak
6	839.70	21.06	-24.94	46.00	32.11	20.10	1.20	32.36	---	---	Peak



Test Mode :	Mode 2	Temperature :	24~25°C
Test Channel :	39	Relative Humidity :	48~49%
Test Engineer :	Andrew Hsiao	Polarization :	Vertical
Remark :			

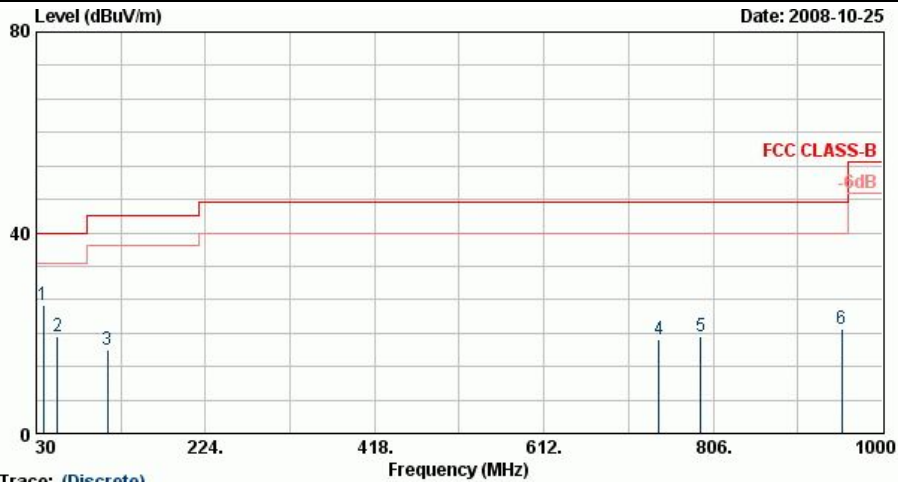

Site :
Condition :
Model :
Mode :

Trace: (Discrete)
: 03CH06-HY
: FCC CLASS-B 3m LF-ANT(051121) VERTICAL
: FR 892435
: Mode 2

	Freq	Level	Over	Limit	Read	Antenna	Cable	Preamp	Ant	Table	Remark
	MHz	dBuV/m	dB	dBuV/m	dBuV	dB/m	dB	dB	cm	deg	
1	38.10	25.49	-14.51	40.00	42.37	14.56	0.30	31.75	100	335	Peak
2	54.57	19.38	-20.62	40.00	43.43	7.50	0.38	31.92	---	---	Peak
3	111.81	16.70	-26.80	43.50	36.14	11.90	0.50	31.84	---	---	Peak
4	743.80	18.75	-27.25	46.00	30.46	19.30	1.10	32.11	---	---	Peak
5	792.10	19.42	-26.58	46.00	30.63	19.75	1.20	32.16	---	---	Peak
6	953.80	20.71	-25.29	46.00	29.94	20.91	1.24	31.38	---	---	Peak



Test Mode :	Mode 3	Temperature :	24~25°C
Test Channel :	78	Relative Humidity :	48~49%
Test Engineer :	Andrew Hsiao	Polarization :	Horizontal
Remark :			

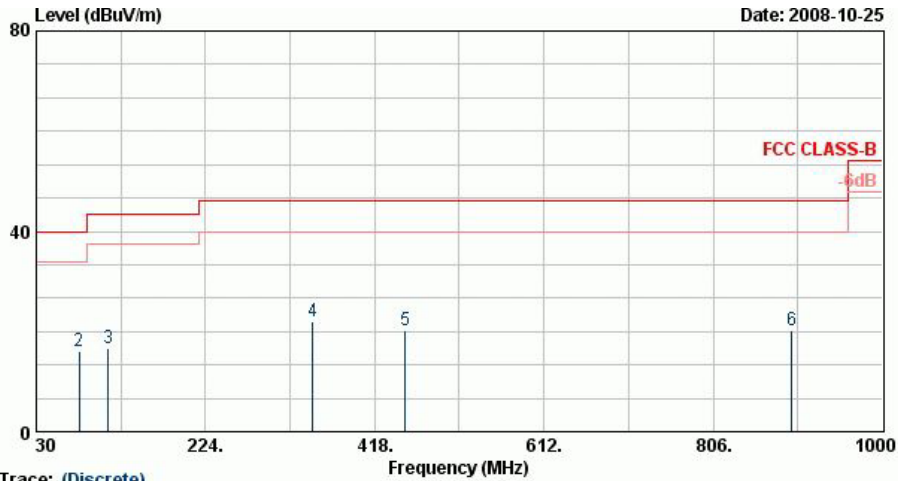

Site :
Condition :
Model :
Mode :

Trace: (Discrete)
: 03CH06-HY
: FCC CLASS-B 3m LF-ANT(051121) HORIZONTAL
: FR 892435
: Mode 3

	Freq	Level	Over	Limit	Read	Antenna	Cable	Preamp	Ant	Table	Remark
	MHz	dBuV/m	Limit	Line	Level	Factor	Loss	Factor	Pos	Pos	
			dB	dBuV/m	dBuV	dB/m	dB	dB	cm	deg	
1	30.81	16.63	-23.37	40.00	28.99	18.95	0.30	31.61	100	302	Peak
2	79.14	16.06	-23.94	40.00	40.11	7.46	0.48	31.99	---	---	Peak
3	112.62	16.63	-26.87	43.50	35.98	11.97	0.50	31.82	---	---	Peak
4	346.90	22.01	-23.99	46.00	38.50	14.42	0.80	31.72	---	---	Peak
5	453.30	20.24	-25.76	46.00	34.77	16.64	0.87	32.04	---	---	Peak
6	895.70	20.33	-25.67	46.00	30.28	20.50	1.30	31.74	---	---	Peak



Test Mode :	Mode 3	Temperature :	24~25°C
Test Channel :	78	Relative Humidity :	48~49%
Test Engineer :	Andrew Hsiao	Polarization :	Vertical
Remark :			

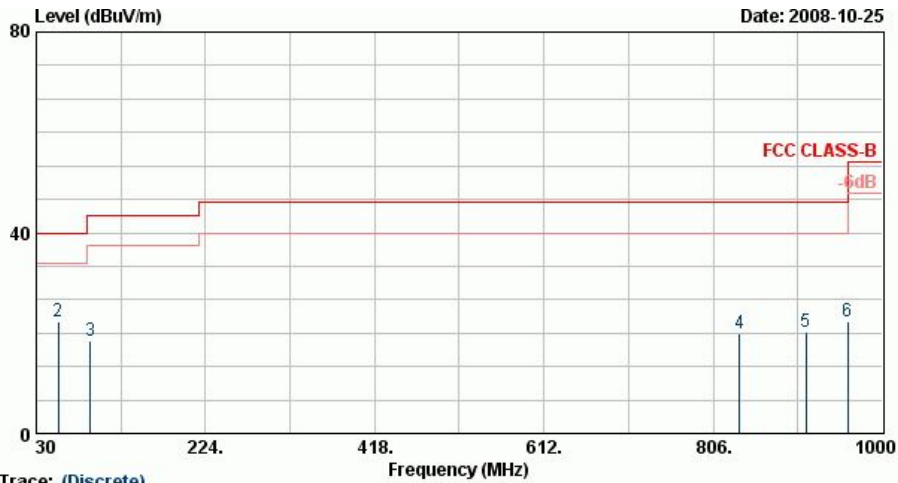

Trace: (Discrete)

Site : 03CH06-HY
 Condition : FCC CLASS-B 3m LP-ANT(851121) VERTICAL
 Model : FR 892435
 Mode : Mode 3

	Freq	Level	Over Limit	Limit Line	Read Level	Antenna Factor	Cable Loss	Preamp Factor	Ant Pos	Table Pos	Remark
	MHz	dBuV/m	dB	dBuV/m	dBuV	dB/m	dB	dB	cm	deg	
1	30.54	25.69	-14.31	40.00	38.05	18.95	0.30	31.61	100	305	Peak
2	55.65	22.28	-17.72	40.00	46.43	7.35	0.40	31.90	---	---	Peak
3	92.37	18.54	-24.96	43.50	40.72	9.42	0.50	32.10	---	---	Peak
4	836.20	19.82	-26.18	46.00	30.88	20.08	1.20	32.34	---	---	Peak
5	912.50	20.19	-25.81	46.00	29.91	20.62	1.27	31.61	---	---	Peak
6	960.10	22.29	-31.71	54.00	31.32	20.96	1.30	31.28	---	---	Peak



3.8.6 Test Result of Radiated Emission ≥ 1 GHz

Test Mode :	Mode 1	Temperature :	24~25°C
Test Channel :	00	Relative Humidity :	48~49%
Test Engineer :	Andrew Hsiao	Polarization :	Horizontal
Remark :	#3 and #4 are Fundamental Signals		

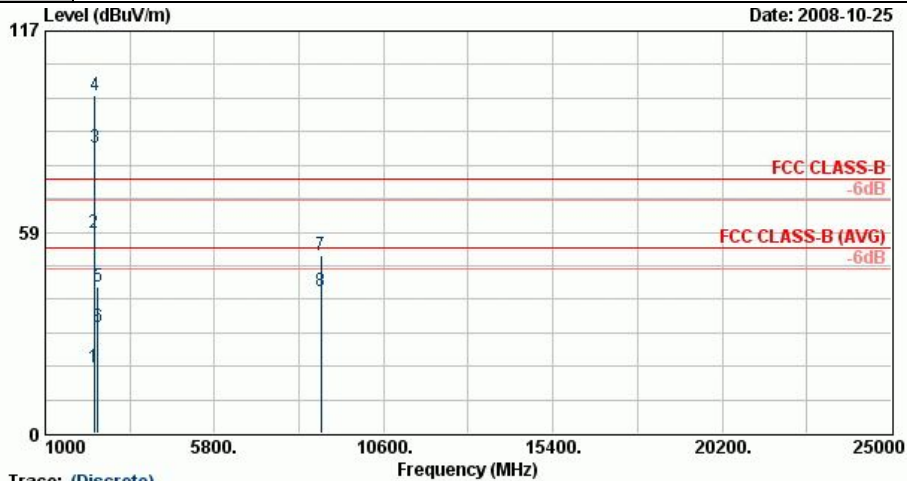

Trace: (Discrete)

Site : 03CH06-HY
 Condition : FCC CLASS-B 3m HF-ANT_060821 HORIZONTAL
 Model : FR 892435
 Mode : Mode 1

	Freq	Level	Over Limit	Limit Line	Read Level	Antenna Factor	Cable Loss	Preamp Factor	Ant Pos	Table Pos	Remark
	MHz	dBuV/m	dB	dBuV/m	dBuV	dB/m	dB	dB	cm	deg	
1	2385.62	19.31	-34.69	54.00	19.09	31.98	3.92	35.68	110	337	Average
2	2385.62	58.33	-15.67	74.00	58.11	31.98	3.92	35.68	100	0	Peak
3 @	2402.00	83.08			82.86	31.98	3.92	35.68	110	337	Average
4 @	2402.00	98.38			98.14	32.00	3.92	35.68	100	0	Peak
5	2500.00	42.79	-31.21	74.00	42.34	32.10	4.05	35.70	100	0	Peak
6	2500.00	30.89	-23.11	54.00	30.44	32.10	4.05	35.70	110	337	Average
7	8829.00	51.89	-22.11	74.00	44.75	36.03	7.59	36.50	100	0	Peak
8	8829.00	41.12	-12.88	54.00	33.99	36.03	7.59	36.50	100	156	Average



Test Mode :	Mode 1	Temperature :	24~25°C
Test Channel :	00	Relative Humidity :	48~49%
Test Engineer :	Andrew Hsiao	Polarization :	Vertical
Remark :	#3 and #4 are Fundamental Signals		

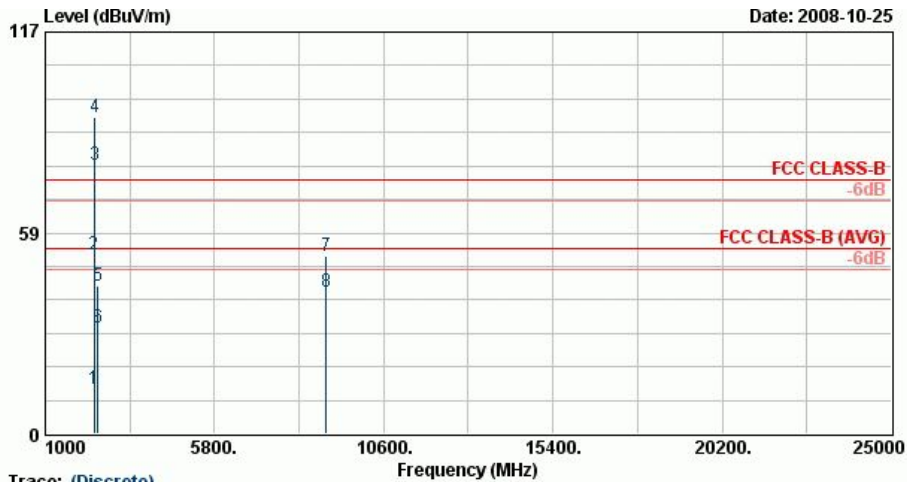

Trace: (Discrete)

Site : 03CH06-HY
 Condition : FCC CLASS-B 3m HF-ANT_060821 VERTICAL
 Model : FR 892435
 Mode : Mode 1

	Freq	Level	Over	Limit	Read	Antenna	Cable	Preamp	Ant	Table	Remark
	MHz	dBuV/m	dB	dBuV/m	dBuV	dB/m	dB	dB	cm	deg	
1	2384.86	13.09	-40.91	54.00	12.89	31.96	3.92	35.68	100	307	Average
2	2384.86	52.11	-21.89	74.00	51.91	31.96	3.92	35.68	100	0	Peak
3 @	2402.00	78.24			78.02	31.98	3.92	35.68	100	307	Average
4 X	2402.00	92.16			91.92	32.00	3.92	35.68	100	0	Peak
5	2494.00	42.88	-31.12	74.00	42.43	32.10	4.05	35.70	100	0	Peak
6	2494.00	30.73	-23.27	54.00	30.28	32.10	4.05	35.70	100	307	Average
7	8961.00	51.63	-22.37	74.00	44.28	36.15	7.77	36.57	100	0	Peak
8	8961.00	41.43	-12.57	54.00	34.08	36.15	7.77	36.57	100	88	Average



Test Mode :	Mode 2	Temperature :	24~25°C
Test Channel :	39	Relative Humidity :	48~49%
Test Engineer :	Andrew Hsiao	Polarization :	Horizontal
Remark :	#3 and #4 are Fundamental Signals		

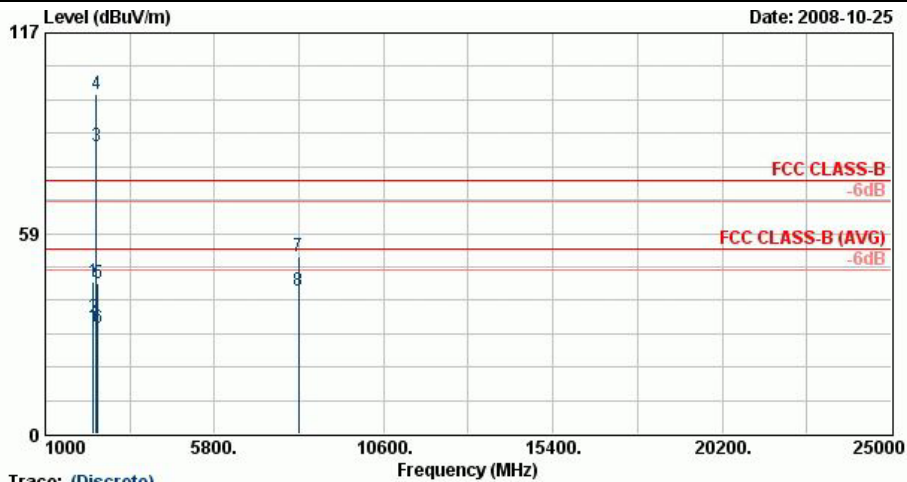

Trace: (Discrete)
 Site : 03CH06-HV
 Condition : FCC CLASS-B 3m HF-ANT_060821 HORIZONTAL
 Model : FR 892435
 Mode : Mode 2

	Freq	Level	Over	Limit	Read	Antenna	Cable	Preamp	Ant	Table	
	MHz	dBuV/m	Limit	Line	Level	Factor	Loss	Factor	Pos	Pos	Remark
			dB	dBuV/m	dBuV	dB/m	dB	dB	cm	deg	
1	2372.00	44.56	-29.44	74.00	44.39	31.96	3.89	35.68	100	0	Peak
2	2372.00	33.87	-20.13	54.00	33.70	31.96	3.89	35.68	104	357	Average
3 @	2441.00	83.98			83.65	32.04	3.99	35.69	104	357	Average
4 @	2441.00	99.11			98.77	32.04	3.99	35.69	100	0	Peak
5	2484.00	43.99	-30.01	74.00	43.55	32.08	4.05	35.70	100	0	Peak
6	2484.00	30.99	-23.01	54.00	30.56	32.08	4.05	35.70	104	357	Average
7	8181.00	51.92	-22.08	74.00	45.11	35.70	7.40	36.30	100	0	Peak
8	8181.00	41.56	-12.44	54.00	34.76	35.70	7.40	36.30	100	94	Average



Test Mode :	Mode 2	Temperature :	24~25°C
Test Channel :	39	Relative Humidity :	48~49%
Test Engineer :	Andrew Hsiao	Polarization :	Vertical
Remark :	#3 and #4 are Fundamental Signals		

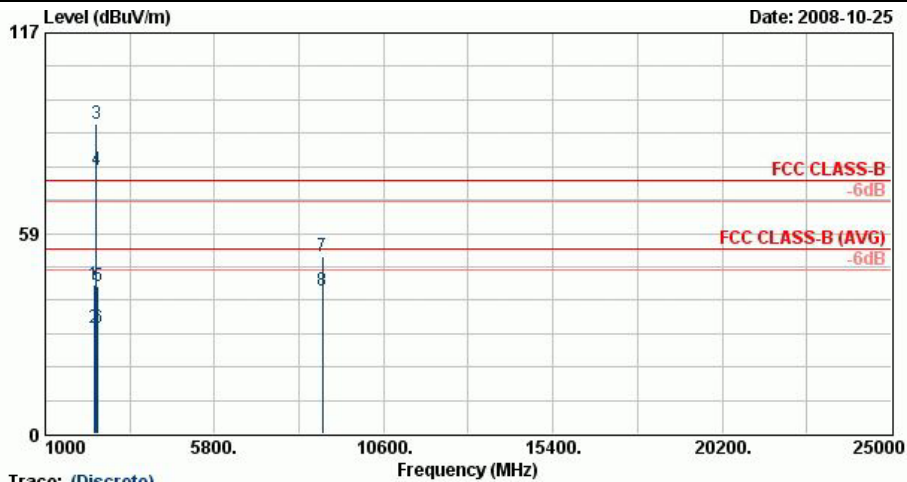

Trace: (Discrete)
 Site : 03CH06-HY
 Condition : FCC CLASS-B 3m HF-ANT_060821 VERTICAL
 Model : FR 892435
 Mode : Mode 2

	Freq	Level	Over	Limit	Read	Antenna	Cable	Preamp	Ant	Table	Remark
	MHz	dBuV/m	Limit	Line	Level	Factor	Loss	Factor	Pos	Pos	
			dB	dBuV/m	dBuV	dB/m	dB	dB	cm	deg	
1	2388.00	43.46	-30.54	74.00	43.24	31.98	3.92	35.68	100	0	Peak
2	2388.00	30.89	-23.11	54.00	30.67	31.98	3.92	35.68	125	261	Average
3 X	2441.00	90.45			90.11	32.04	3.99	35.69	100	0	Peak
4 @	2441.00	77.10			76.77	32.04	3.99	35.69	125	261	Average
5	2484.00	43.17	-30.83	74.00	42.74	32.08	4.05	35.70	100	0	Peak
6	2484.00	30.87	-23.13	54.00	30.44	32.08	4.05	35.70	125	261	Average
7	8865.00	51.62	-22.38	74.00	44.42	36.07	7.65	36.51	100	0	Peak
8	8865.00	41.61	-12.39	54.00	34.40	36.07	7.65	36.51	100	176	Average



Test Mode :	Mode 3	Temperature :	24~25°C
Test Channel :	78	Relative Humidity :	48~49%
Test Engineer :	Andrew Hsiao	Polarization :	Horizontal
Remark :	#3 and #4 are Fundamental Signals		

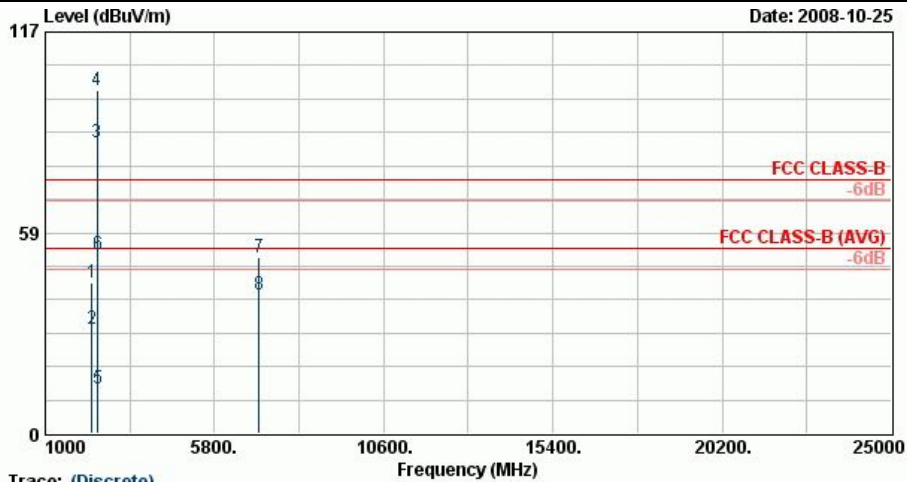

Trace: (Discrete)
 Site : 03CH06-HV
 Condition : FCC CLASS-B 3m HF-ANT_060821 HORIZONTAL
 Model : FR 892435
 Mode : Mode 3

	Freq	Level	Over	Limit	Read	Antenna	Cable	Preamp	Ant	Table	
	MHz	dBuV/m	Limit	Line	Level	Factor	Loss	Factor	Pos	Pos	Remark
			dB	dBuV/m	dBuV	dB/m	dB	dB	cm	deg	
1	2316.00	43.82	-30.18	74.00	43.79	31.87	3.82	35.67	100	0	Peak
2	2316.00	30.59	-23.41	54.00	30.56	31.87	3.82	35.67	102	354	Average
3 @	2480.00	84.96			84.53	32.08	4.05	35.70	102	354	Average
4 @	2480.00	99.98			99.55	32.08	4.05	35.70	100	0	Peak
5	2483.66	13.10	-40.90	54.00	12.67	32.08	4.05	35.70	102	354	Average
6	2483.66	52.12	-21.88	74.00	51.69	32.08	4.05	35.70	100	0	Peak
7	7065.00	51.34	-22.66	74.00	44.58	35.67	7.12	36.03	100	0	Peak
8	7065.00	40.43	-13.57	54.00	33.67	35.67	7.12	36.03	100	315	Average



Test Mode :	Mode 3	Temperature :	24~25°C
Test Channel :	78	Relative Humidity :	48~49%
Test Engineer :	Andrew Hsiao	Polarization :	Vertical
Remark :	#3 and #4 are Fundamental Signals		

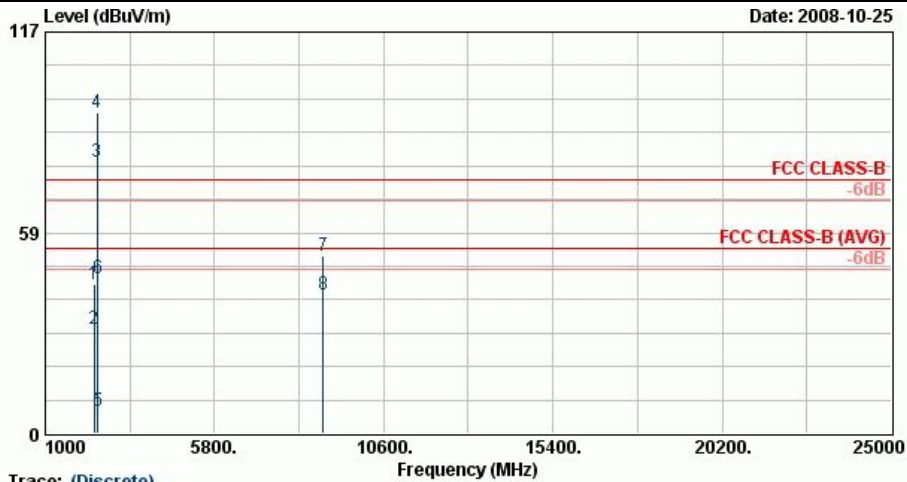

Trace: (Discrete)
 Site : 03CH06-HY
 Condition : FCC CLASS-B 3m HF-ANT_060821 VERTICAL
 Model : FR 892435
 Mode : Mode 3

	Freq	Level	Over	Limit	Read	Antenna	Cable	Preamp	Ant	Table	Remark
	MHz	dBuV/m	Limit	Line	Level	Factor	Loss	Factor	Pos	Pos	
			dB	dBuV/m	dBuV	dB/m	dB	dB	cm	deg	
1	2382.00	43.58	-30.42	74.00	43.38	31.96	3.92	35.68	100	0	Peak
2	2382.00	30.64	-23.36	54.00	30.44	31.96	3.92	35.68	117	291	Average
3 @	2480.00	79.16			78.73	32.08	4.05	35.70	117	291	Average
4 X	2480.00	93.31			92.88	32.08	4.05	35.70	100	0	Peak
5	2483.50	6.43	-47.57	54.00	6.00	32.08	4.05	35.70	117	291	Average
6	2483.50	45.45	-28.55	74.00	45.02	32.08	4.05	35.70	100	0	Peak
7	8877.00	51.57	-22.43	74.00	44.38	36.07	7.65	36.53	100	0	Peak
8	8877.00	40.61	-13.39	54.00	33.42	36.07	7.65	36.53	100	269	Average



3.9 Antenna Requirements

3.9.1 Standard Applicable

If directional gain of transmitting antennas is greater than 6dBi, the power shall be reduced by the same level in dB comparing to gain minus 6dBi.

The use of a permanently attached antenna or of an antenna that uses a unique coupling to the intentional radiator shall be considered sufficient to comply with the FCC rule.

3.9.2 Antenna Connected Construction

The antennas type used in this product is PIFA antenna without connector and it is considered to meet antenna requirement.

3.9.3 Antenna Gain

The antenna peak gain of EUT is less than 6 dBi. Therefore, it is not necessary to reduce maximum peak output power limit.

4 List of Measuring Equipments

Instrument	Manufacturer	Model No.	Serial No.	Characteristics	Calibration Date	Due Date	Remark
Spectrum Analyzer	R&S	FSP40	100055	9KHz~40GHz	Jun. 26, 2008	Jun. 25, 2009	Conducted (TH02-HY)
Power Meter	Agilent	E4416A	GB41292344	N/A	Feb. 21, 2008	Feb. 20, 2009	Conducted (TH02-HY)
Power Sensor	Agilent	E9327A	US40441548	N/A	Feb. 21, 2008	Feb. 20, 2009	Conducted (TH02-HY)
EMI Receiver	R&S	ESCS 30	100356	9kHz – 2.75GHz	Aug. 01, 2008	Jul. 31, 2009	Conduction (CO05-HY)
Two-LISN	R&S	ENV216	11-100081	9kHz – 30MHz	Dec. 06, 2007	Dec. 05, 2008	Conduction (CO05-HY)
Two-LISN	R&S	ENV216	11-100080	9kHz – 30MHz	Dec. 06, 2007	Dec. 05, 2008	Conduction (CO05-HY)
DC- LISN	R&S	ESH3-26	1000485	0.1MHz-200MHz	Feb. 04, 2008	Feb. 03, 2009	Conduction (CO05-HY)
DC- LISN	R&S	ESH3-26	1000484	0.1MHz-200MHz	Feb. 04, 2008	Feb. 03, 2009	Conduction (CO05-HY)
AC Power Source	APC	APC-1000W	N/A	N/A	N/A	N/A	Conduction (CO05-HY)
Spectrum Analyzer	Agilent	E4408B	MY44211030	9KHz-26.5GHz	Oct. 24, 2008	Oct. 23, 2009	Radiation (03CH06-HY)
Spectrum Analyzer	R&S	FSP40	100057	9KHz-40GHz	Oct. 16, 2008	Oct. 15, 2009	Radiation (03CH06-HY)
EMI Test Receiver	R&S	ESVS10	834468/003	20MHz-1000MHz	Apr. 24, 2008	Apr. 23, 2009	Radiation (03CH06-HY)
Bilog Antenna	SCHAFFNER	CBL6112B	2885	30MHz -2GHz	Dec. 01, 2007	Nov. 30, 2008	Radiation (03CH06-HY)
Double Ridge Horn Antenna	EMCO	3117	00066583	1G~18GHz	Aug. 18, 2008	Aug. 17, 2009	Radiation (03CH06-HY)
Double Ridge Horn Antenna	Training Research	AF-0801	95119	8G~18GHz	Jun. 26, 2008	Jun. 25, 2009	Radiation (03CH06-HY)
SHF-EHF Horn	SCHWARZBECK	BBHA 9170	9170-251	14G - 40GHz	Oct. 16, 2008	Oct. 15, 2009	Radiation (03CH06-HY)
Pre Amplifier	Agilent	8449B	3008A01917	1G - 26.5GHz	Nov. 22, 2007	Nov. 21, 2008	Radiation (03CH06-HY)
Pre Amplifier	Agilent	310N	186713	9KHz~1GHz	Apr. 21, 2008	Apr. 20, 2009	Radiation (03CH06-HY)
Base Station Simulator	R&S	CMU200	116456	Third-Band	Jun. 05, 2008	Jun. 04, 2009	Radiation (03CH06-HY)
BT Base Station	Anritsu	MT8852B	6K00005722	N/A	Oct. 23, 2007	Oct. 22, 2009	Radiation (03CH06-HY))

5 Uncertainty of Evaluation

Uncertainty of Conducted Emission Measurement (150kHz ~ 30MHz)

Contribution	Uncertainty of x_i		$u(x_i)$
	dB	Probability Distribution	
Receiver reading	0.10	Normal(k=2)	0.05
Cable loss	0.10	Normal(k=2)	0.05
AMN insertion loss	2.50	Rectangular	0.63
Receiver Spec	1.50	Rectangular	0.43
Site imperfection	1.39	Rectangular	0.80
Mismatch	+0.34/-0.35	U-shape	0.24
Combined standard uncertainty Uc(y)	1.13		
Measuring uncertainty for a level of confidence of 95% U=2Uc(y)	2.26		

Uncertainty of Radiated Emission Measurement (30MHz ~ 1000MHz)

Contribution	Uncertainty of x_i		$u(x_i)$
	dB	Probability Distribution	
Receiver reading	0.41	Normal(k=2)	0.21
Antenna factor calibration	0.83	Normal(k=2)	0.42
Cable loss calibration	0.25	Normal(k=2)	0.13
Pre Amplifier Gain calibration	0.27	Normal(k=2)	0.14
RCV/SPA specification	2.50	Rectangular	0.72
Antenna Factor Interpolation for Frequency	1.00	Rectangular	0.29
Site imperfection	1.43	Rectangular	0.83
Mismatch	+0.39/-0.41	U-shaped	0.28
Combined standard uncertainty Uc(y)	1.27		
Measuring uncertainty for a level of confidence of 95% U=2Uc(y)	2.54		

Uncertainty of Radiated Emission Measurement (1GHz ~ 40GHz)

Contribution	Uncertainty of x_i		$u(x_i)$	C_i	$C_i * u(x_i)$
	dB	Probability Distribution			
Receiver reading	±0.10	Normal(k=1)	0.10	1	0.10
Antenna factor calibration	±1.70	Normal(k=2)	0.85	1	0.85
Cable loss calibration	±0.50	Normal(k=2)	0.25	1	0.25
Receiver Correction	±2.00	Rectangular	1.15	1	1.15
Antenna Factor Directional	±1.50	Rectangular	0.87	1	0.87
Site imperfection	±2.80	Triangular	1.14	1	1.14
Mismatch Receiver VSWR $\Gamma_1 = 0.197$ Antenna VSWR $\Gamma_2 = 0.194$ Uncertainty = $20 \log(1 - \Gamma_1 * \Gamma_2)$	+0.34/-0.35	U-shaped	0.244	1	0.244
Combined standard uncertainty $U_c(y)$	2.36				
Measuring uncertainty for a level of confidence of 95% $U = 2U_c(y)$	4.72				

6 Certification of TAF Accreditation



Certificate No. : L1190-070110

財團法人全國認證基金會
Taiwan Accreditation Foundation

Certificate of Accreditation

This is to certify that

Sporton International Inc.
EMC & Wireless Communications Laboratory
No.52, Hwa Ya 1st Rd., Hwa Ya Technology Park, Kwei-Shan Hsiang, Tao Yuan Hsien,
Taiwan, R.O.C.

is accredited in respect of laboratory

Accreditation Criteria	: ISO/IEC 17025:2005
Accreditation Number	: 1190
Originally Accredited	: December 15, 2003
Effective Period	: January 10, 2007 to January 09, 2010
Accredited Scope	: Testing Field, see described in the Appendix Accreditation Program for Designated Testing Laboratory
Specific Accreditation Program	: for Commodities Inspection Accreditation Program for Telecommunication Equipment Testing Laboratory

Jay-San Chen
President, Taiwan Accreditation Foundation
Date : January 10, 2007

PI, total 9 pages

The Appendix forms an integral part of this Certificate, which shall be invalid when used without the Appendix.



Appendix A. Photographs of EUT

Please refer to Sporton report number EP892435 as below.