



MiniCard 8775 Partial Test Report

For

FCC Certification

IC: 2417C-MC8775
FCC ID: N7NMC8775

Prepared by
SIERRA WIRELESS INC.
13811 WIRELESS WAY
RICHMOND, BC V6V 3A4
CANADA

Test Date(s): July 6, 2006,
July 13, 2006

© 2006 Sierra Wireless, Inc.

This document contains information which is proprietary and confidential to Sierra Wireless, Inc. Disclosure to persons other than the officers, employees, agents, or subcontractors of the Company or licensee of this document without the prior written permission of Sierra Wireless, Inc. is strictly prohibited.

Table of Contents

1 Introduction and Purpose.....	3
2 Test Summary.....	3
3 Description of Equipment Under Test.....	4
4 RF Power Output.....	5
4.1 Test Procedure.....	5
4.2 Test Equipment.....	5
4.3 Test Results GSM/EDGE.....	6
4.4 Test Results UMTS.....	6
4.5 Test Settings for UMTS Mode on the CMU210.....	6
4.6 Test Setting Notes for GMSK and 8PSK Tests.....	7
5 Occupied Bandwidth.....	8
5.1 Test Procedure.....	8
5.2 Test Results.....	8
5.3 Test Plots.....	9
6 Out of Band Emissions at Antenna Terminals.....	18
6.1 Test Procedure.....	18
6.2 Test Equipment.....	18
6.3 Test Results.....	19
6.4 Test Plots.....	20
7 Block Edge Compliance.....	56
7.1 Test Procedure.....	56
7.2 Test Equipment.....	56
7.3 Test Results.....	56
7.4 Test Plots.....	57
8 Frequency Stability Versus Temperature.....	63
8.1 Summary of Results.....	63
8.2 Test Procedure.....	63
8.3 Test Equipment.....	63
8.4 Test Results.....	64
9 Frequency Stability Versus Voltage.....	69
9.1 Summary of Results.....	69
9.2 Test Procedure.....	69
9.3 Test Equipment.....	69
9.4 Test Results.....	70

SIERRA WIRELESS, INC.

FCC Part 22 & 24 Test Report	MC8775	July 13, 2006	Page 3 of 72
------------------------------	--------	---------------	--------------

1 Introduction and Purpose

This document provides the FCC test data for the MC8775 wireless modem. The tests included in this report are limited to all conducted tests required. The radiated tests were performed at an external test facility.

2 Test Summary

FCC RULE	DESCRIPTION OF TEST	RESULT	PAGE
2.1046	RF Power Output	Complies	6
2.1049	Occupied Bandwidth	Complies	8
2.1051, 22.901(d) 22.917, 24.238(a)	Out of Band Emissions at Antenna Terminals	Complies	19
FCC part 22H/24E	Block Edge Requirements	Complies	56
2.1053	Field Strength of Spurious Radiation	Complies	See CCS Report
2.1055	Frequency Stability versus Temperature	Complies	63
2.1055	Frequency Stability versus Voltage	Complies	69

The tests described in this report were performed by Mr. Philip Wright at:

Sierra Wireless, Inc.
13811 Wireless Way
Richmond, B.C. V6V 3A4
Canada

3 Description of Equipment Under Test

The Sierra Wireless Inc. model MiniCard MC8775 is a Seven-band wireless modem operating on the GSM/GPRS/EDGE/UMTS network. In the US and Canada, only cellular and PCS bands are used for GSM/GPRS/UMTS operation, so this test report only contains data for these two bands (850MHz and 1900MHz). The EUT was tested in both modes of operation: GMSK modulation, 8-PSK, and WCDMA modulation. The EUT is a production sample and the serial number is: X281866002510-0D

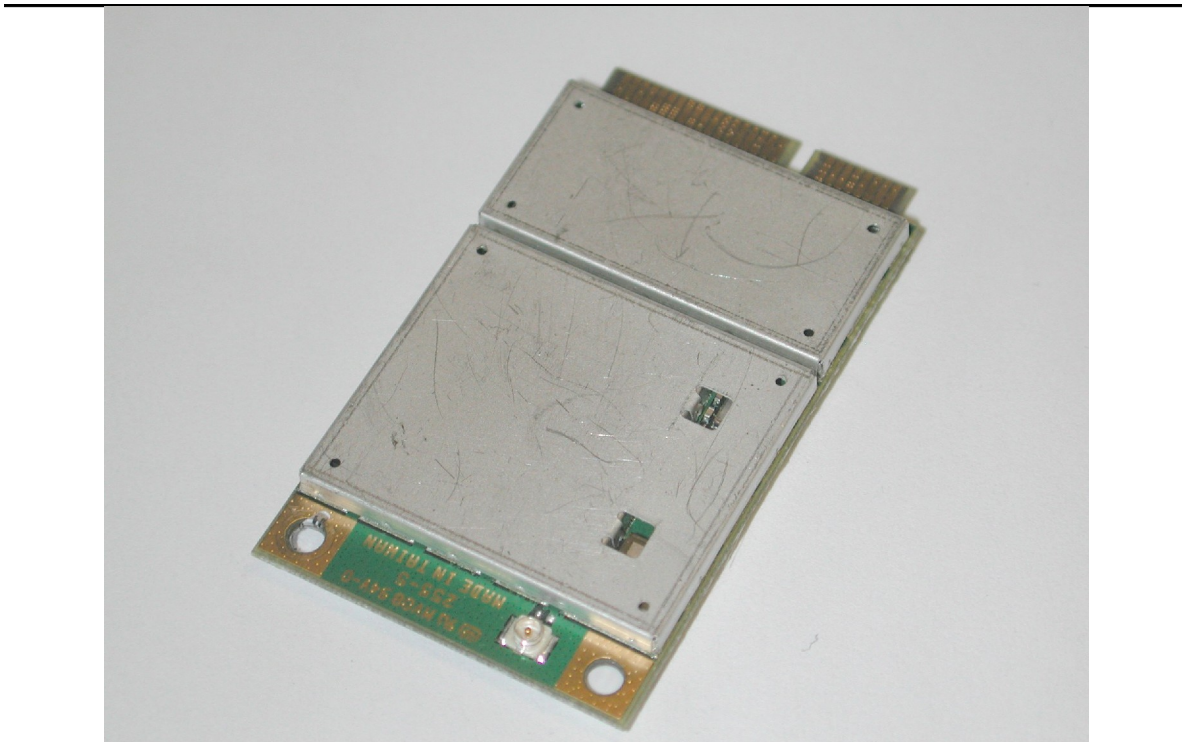

4 RF Power Output

FCC 2.1046

4.1 Test Procedure

The transmitter output was connected to a Rohde & Schwarz CMU200 Test Set and configured to operate at maximum power in a call. The power was measured using the spectrum analyzer at three equally spaced operating frequencies for each band. The RBW was set to 300 KHz for the GSM and EDGE measurements, and 5MHz for the WCDMA measurements. The spectrum analyzer was set to measure the RF output power with the cable and coupler losses accounted for.

Test Setup

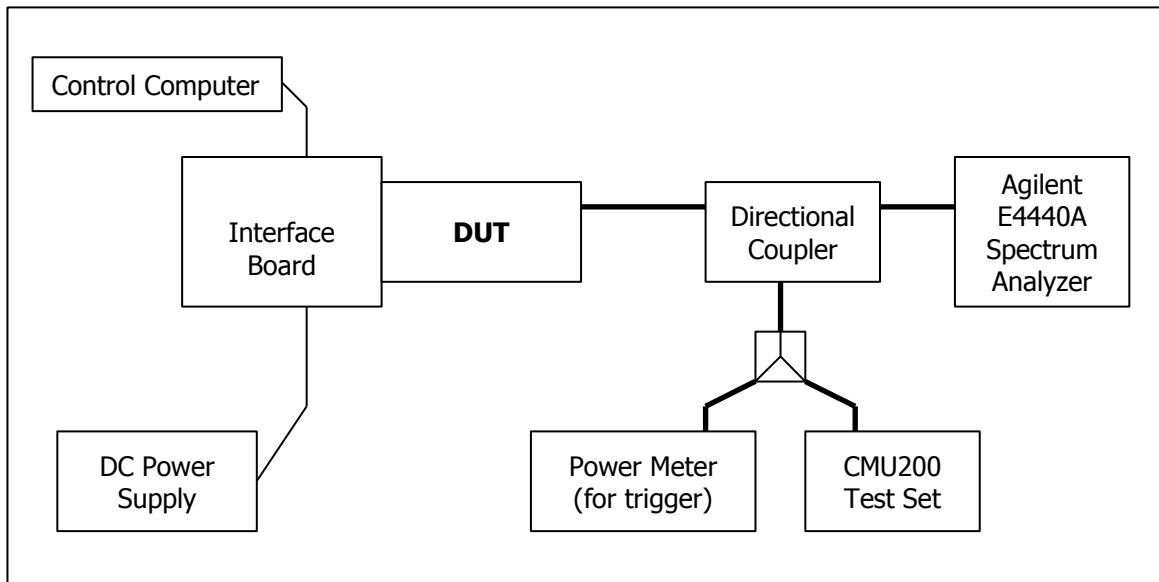

4.2 Test Equipment

Instrument List

EQUIPMENT	MANUFACTURER	MODEL NO.	SERIAL NO.	CAL. DATE
Control Computer	TC	Generic PC	100488	N/A
Wireless Test Set	Rohde & Schwarz	CMU200	836766/030	N/A
Spectrum Analyzer	Agilent	PSA E4440A	US41421268	Sept. 29, 2004
DC Power Supply	HP	6632A	3530A	N/A
Interface Board	Shop built	Minnow	N/A	N/A
Directional Coupler	Mini-Circuits	ZA3PD-2	N/A	N/A

SIERRA WIRELESS, INC.

4.3 Test Results GSM/EDGE

Frequency (MHz)	Channel	Power (dBm)	
		GMSK Mode	8-PSK Mode
824.2	128	31.76	26.9
836.6	190	32	27.1
848.8	251	31.96	27.1
1850.2	512	29.54	26.7
1880.0	661	29.32	25.6
1909.8	810	29.47	26.6

4.4 Test Results UMTS

Frequency (MHz)	Channel	Power (dBm)
826.4	4132	22.41
836.4	4182	22.89
846.6	4233	22.97
1852.4	9262	23.26
1880.0	9400	23.0
1907.5	9538	23.23

4.5 Test Settings for UMTS Mode on the CMU210

Node B Settings

Primary Scrambling Code = 9
Output Channel Power = -51.7 dBm
OCNS = Off
Total Output Power (I_{or}+I_{oc}) = -51.7 dBm

RMC Settings

Reference Channel Type: 12.2 kbps Downlink/Uplink DL DTCH Transport Format: 12.2 kbps DL Resources in Use: 100 % UL CRC (Sym. Loop Mode 2): Off Test Mode: Loop Mode 2 Channel Data Source DTCH: PRBS9

Voice Settings

Voice Source: Echo
Loopback Type: Off

Adaptive Multirate Settings

Active Code Set: Selection A
Codec Mode: 12.2 kbps

SIERRA WIRELESS, INC.

FCC Part 22 & 24 Test Report	MC8775	July 13, 2006	Page 7 of 72
------------------------------	--------	---------------	--------------

Signaling RAB Settings

SRB Cell DCH: 3.4 kbps

BS Down Link Physical Channels Settings

Ior = -51.7 dBm
P-CPICH = -3.3 dB
P-SCH = -8.3 dB
S-SCH = -8.3 dB
P-CCPCH = -5.3 dB
S-CCPCH = -5.3 dB
S-CCPCH Channel Code = 2
PICH = -8.3 dB
PICH Channel Code = 3
AICH = -8.3 dB
AICH Channel Code = 6
DPDCH = -10.3 dB
DPDCH Channel Code = 96
Power Offset (DPCCH/DPDCH) = 0.0 dB
DL DPCH Timing Offset = 0
Secondary Scrambling Code = 0
Secondary Scrambling Code (HSDPA) = 0
HSDPA Channels = Off

TPC Settings

Algorithm = 2
TPC Step Size = 1dB
TPC Pattern Setup = Set 1 (All 1, after linked to get maximum power)

UMTS presents the highest TX power, however HSDPA may back off the power for different gain factors. In terms of in band and out of band HSDPA is "quieter", and so in this test report, all results are for UMTS mode of operation.

4.6 Test Setting Notes for GMSK and 8PSK Tests

Both GMSK and 8PSK were tested and reported in this document. The device is multislots Class-12. The highest GMSK GSM/GPRS power is for one timeslot, increasing the number of timeslots the TX power is reduced accordingly. The output power for EDGE is the same for one to four timeslots. The relevant power levels are given in the results.

5 Occupied Bandwidth

FCC 2.1049

5.1 Test Procedure

The transmitter output was connected to a calibrated coaxial cable and coupler, the other end of which was connected to a spectrum analyzer. The occupied bandwidth (defined as the 99% Power Bandwidth) was measured with the spectrum analyzer at the 3 frequencies in each band. The -26dB bandwidth was also measured and recorded.

Test Setup

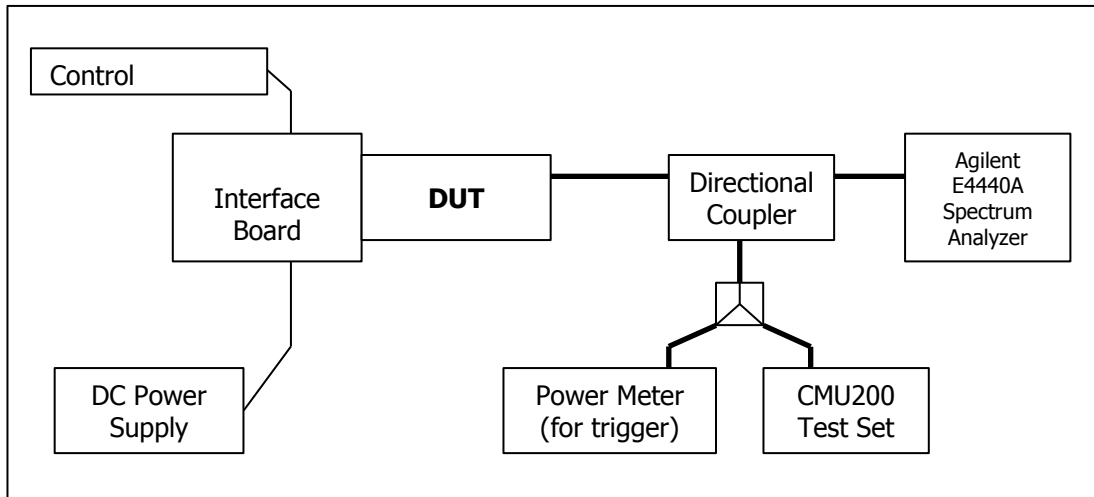

5.2 Test Results

The performance of the GSM 850 MHz cellular band is shown in plots 5.3.1 to 5.3.6.

Performance of the GSM 1900 MHz PCS band is shown in plots 5.3.7 to 5.3.12.

Performance of the UMTS 850 cellular band is shown in plots 5.3.13 to 5.3.15

Performance of the UMTS 1900 PCS band is shown in plots 5.3.16 to 5.3.18

Frequency (MHz)	Channel	99% Occupied Bandwidth (kHz)		-26dBc Occupied Bandwidth (kHz)	
		GMSK Mode	8-PSK Mode	GMSK Mode	8-PSK Mode
824.2	128	242.5	241	310.8	306
836.6	190	243.2	245.6	315.4	304.1
848.8	251	242.5	244.8	317.2	301.6
1850.2	512	243.8	242.2	314.5	298.3
1880.0	661	247.6	242.1	317.3	304.8
1909.8	810	246.2	242.6	321.4	290.9
Frequency (MHz)	Channel	99% Occupied Bandwidth (MHz)		-26dBc Occupied Bandwidth (MHz)	
826.4	4132	4.15		4.63	
836.4	4182	4.17		4.63	
846.6	4233	4.13		4.65	
1852.4	9262	4.15		4.62	
1880.0	9400	4.14		4.6	
1907.5	9538	4.13		4.61	

SIERRA WIRELESS, INC.

5.3 Test Plots

5.3.1) GSMK Occupied Bandwidth, Cellular Low channel, 824.2 MHz, 99% bandwidth

Agilent 17:03:03 Jul 6, 2006

L

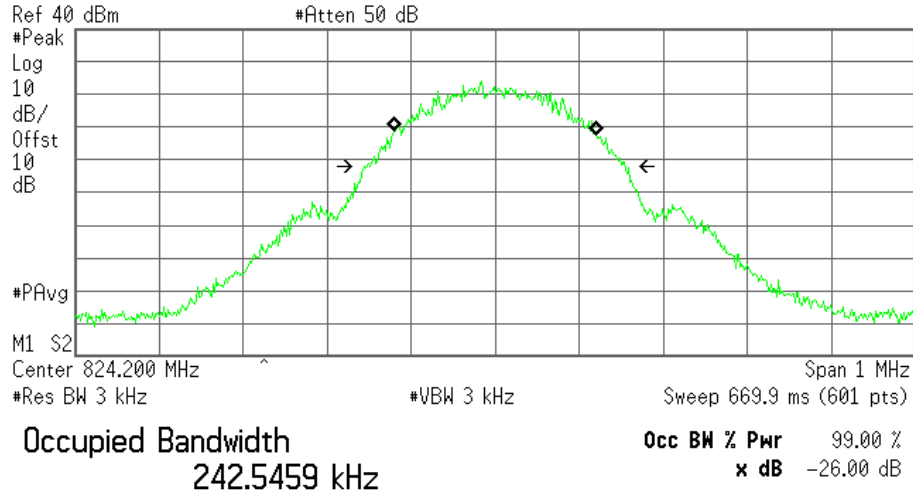

Transmit Freq Error 301.107 Hz
x dB Bandwidth 310.855 kHz

5.3.2) GSMK Occupied Bandwidth, Middle channel, 836.6 MHz, 99% bandwidth

Agilent 17:04:57 Jul 6, 2006

L

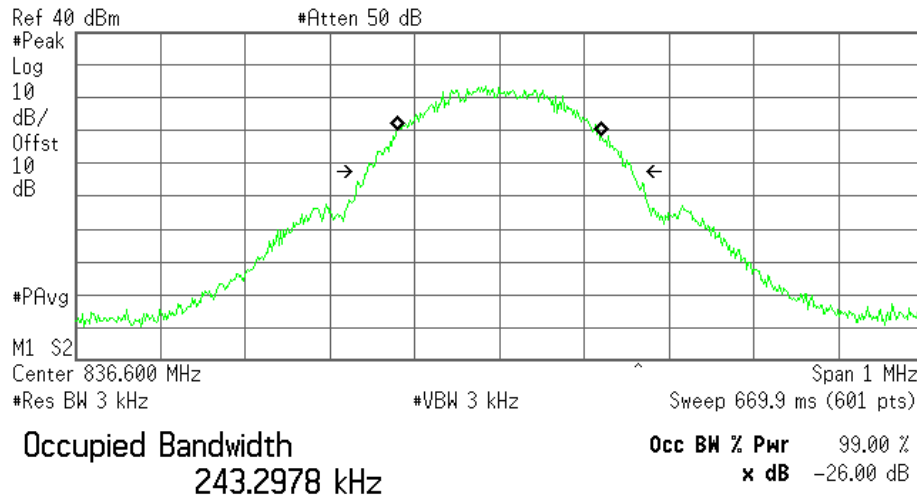

Transmit Freq Error -306.511 Hz
Occupied Bandwidth 315.374 kHz

SIERRA WIRELESS, INC.

5.3.3) GMSK Occupied Bandwidth, High channel, 848.8 MHz, 99% bandwidth

Agilent 17:05:57 Jul 6, 2006

R L

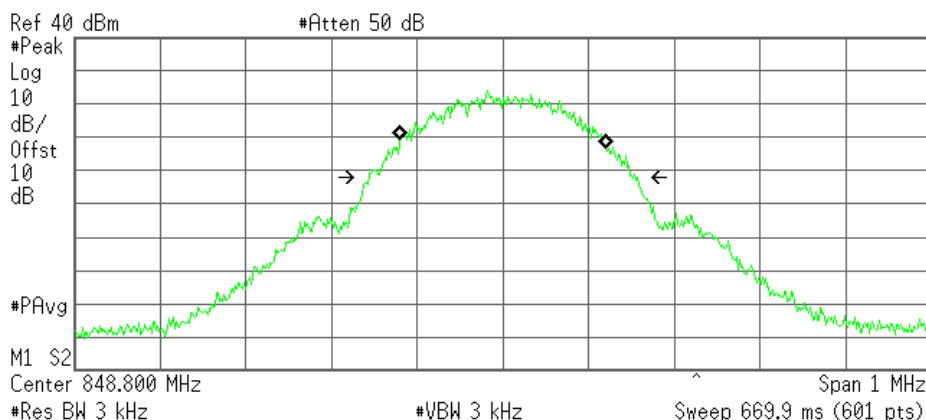

Occupied Bandwidth
242.5769 kHz

Occ BW % Pwr 99.00 %
x dB -26.00 dB

Transmit Freq Error 338.549 Hz
Occupied Bandwidth 317.200 kHz

5.3.4) 8-PSK Occupied Bandwidth, Cellular Low channel, 824.2 MHz, 99% bandwidth

Agilent 11:27:33 Jul 10, 2006

R L

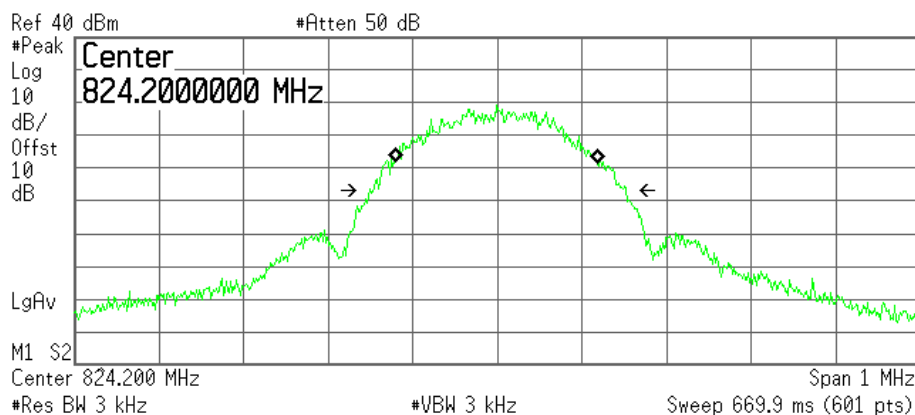

Occupied Bandwidth
241.0079 kHz

Occ BW % Pwr 99.00 %
x dB -26.00 dB

Transmit Freq Error -1.063 kHz
x dB Bandwidth 306.012 kHz

SIERRA WIRELESS, INC.

5.3.5) 8-PSK Occupied Bandwidth, Middle channel, 836.6 MHz, 99% bandwidth

Agilent 11:28:48 Jul 10, 2006

L

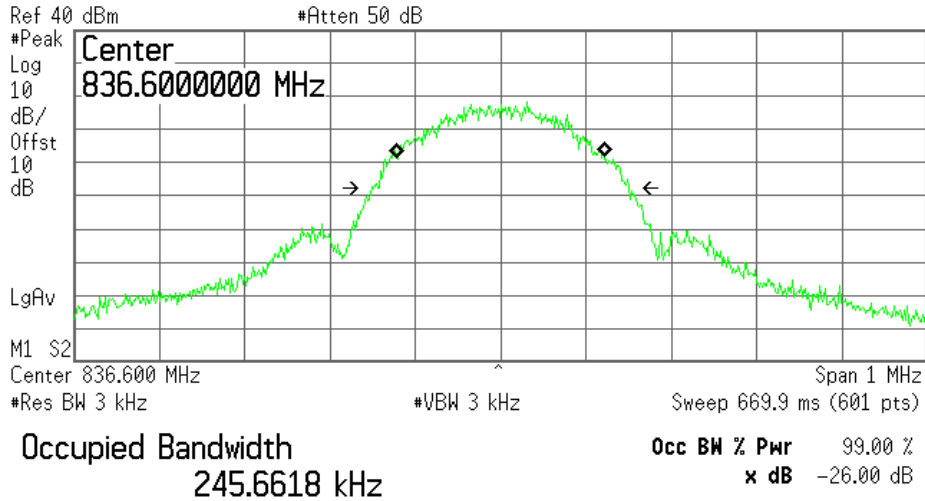

Transmit Freq Error -334.714 Hz
x dB Bandwidth 304.061 kHz

5.3.6) 8-PSK Occupied Bandwidth, High channel, 848.8 MHz, 99% bandwidth

Agilent 11:29:39 Jul 10, 2006

L

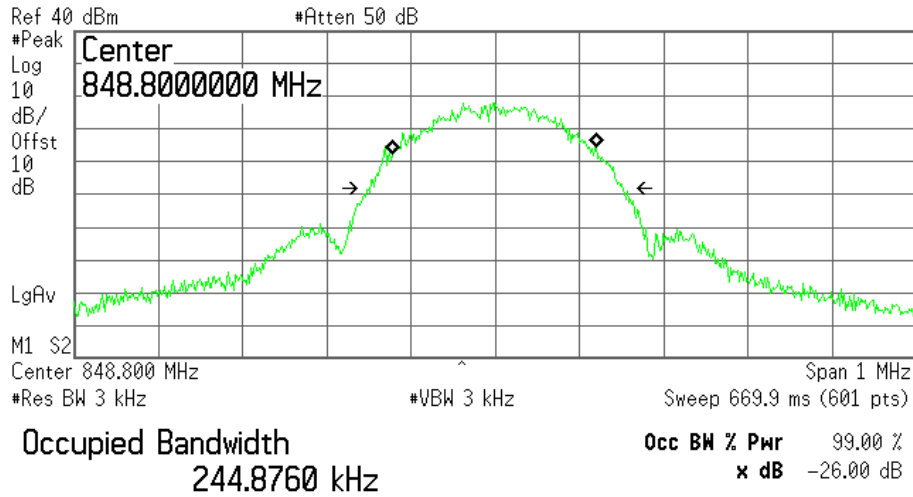

Transmit Freq Error -749.937 Hz
Occupied Bandwidth 301.652 kHz

SIERRA WIRELESS, INC.

5.3.7) GMSK Occupied Bandwidth, PCS Low channel, 1850.2 MHz, 99% bandwidth

Agilent 15:20:17 Jul 7, 2006

L

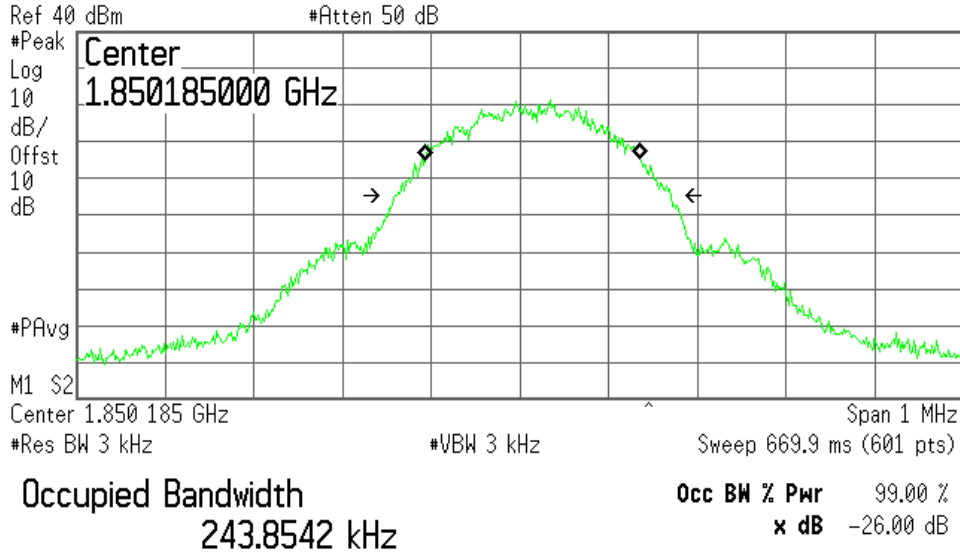

Transmit Freq Error 14.400 kHz
x dB Bandwidth 314.459 kHz

5.3.8) GMSK Occupied Bandwidth, PCS Middle channel, 1880.0 MHz, 99% bandwidth

Agilent 15:21:13 Jul 7, 2006

L

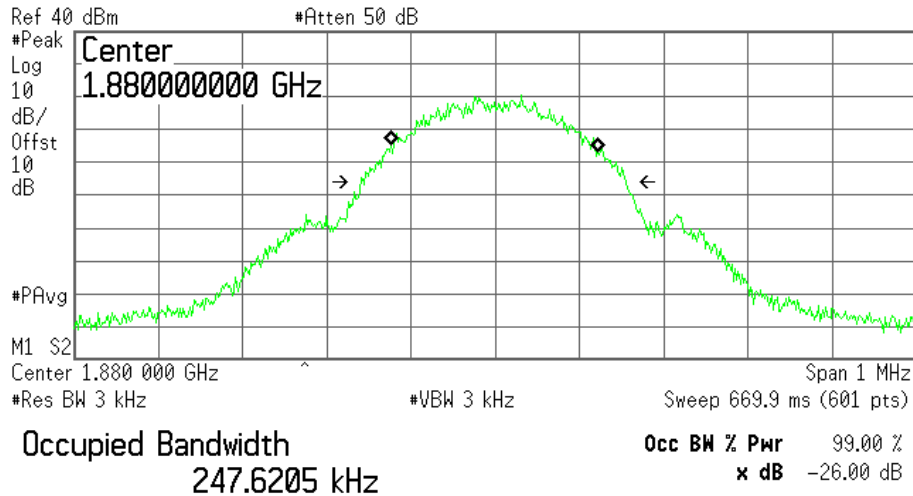

Transmit Freq Error -1.137 kHz
Occupied Bandwidth 317.304 kHz

SIERRA WIRELESS, INC.

5.3.9) GMSK Occupied Bandwidth, PCS High channel, 1909.8 MHz, 99% bandwidth

* Agilent 15:22:21 Jul 7, 2006

L

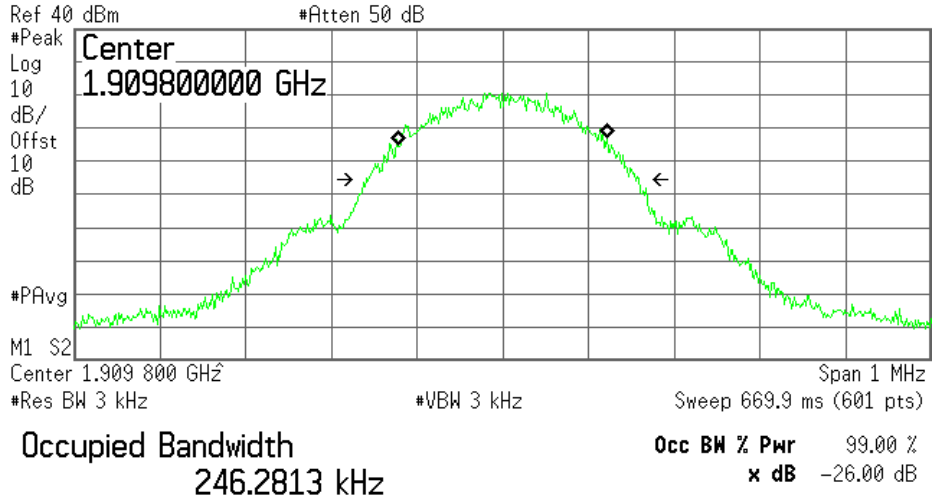

Transmit Freq Error -272.530 Hz
Occupied Bandwidth 321.402 kHz

5.3.10) 8-PSK Occupied Bandwidth, PCS Low channel, 1850.2 MHz, 99% bandwidth

* Agilent 16:24:23 Jul 7, 2006

L

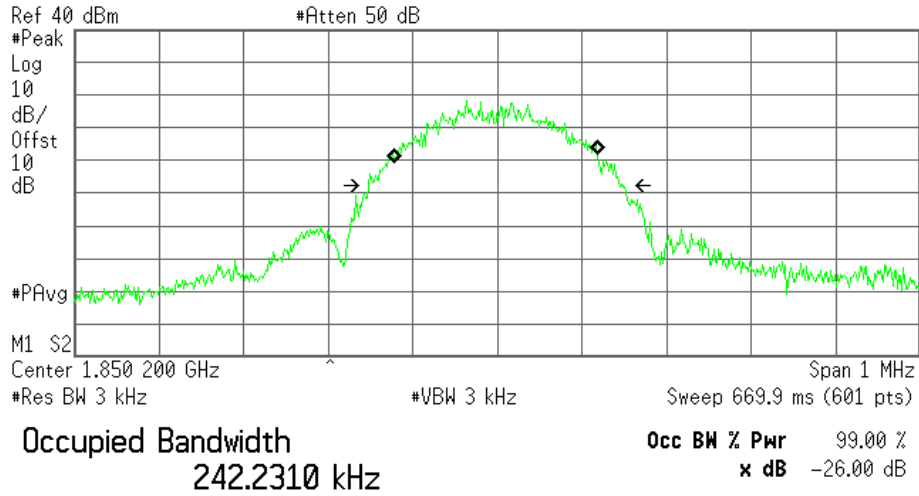

Transmit Freq Error -1.983 kHz
Occupied Bandwidth 298.313 kHz

SIERRA WIRELESS, INC.

5.3.11) 8-PSK Occupied Bandwidth, PCS Middle channel, 1880.0 MHz, 99% bandwidth

Agilent 16:19:58 Jul 7, 2006

L

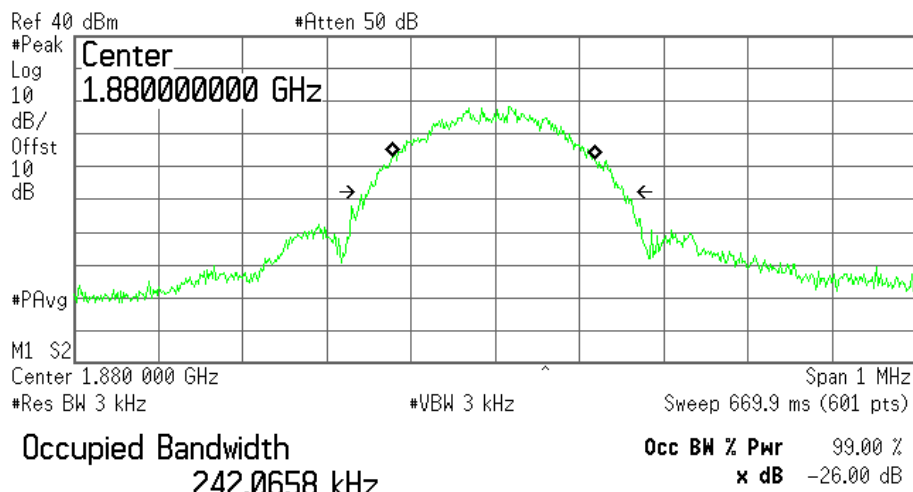

Transmit Freq Error -1.583 kHz
x dB Bandwidth 304.855 kHz

5.3.12) 8-PSK Occupied Bandwidth, PCS High channel, 1909.8 MHz, 99% bandwidth

Agilent 16:25:18 Jul 7, 2006

L

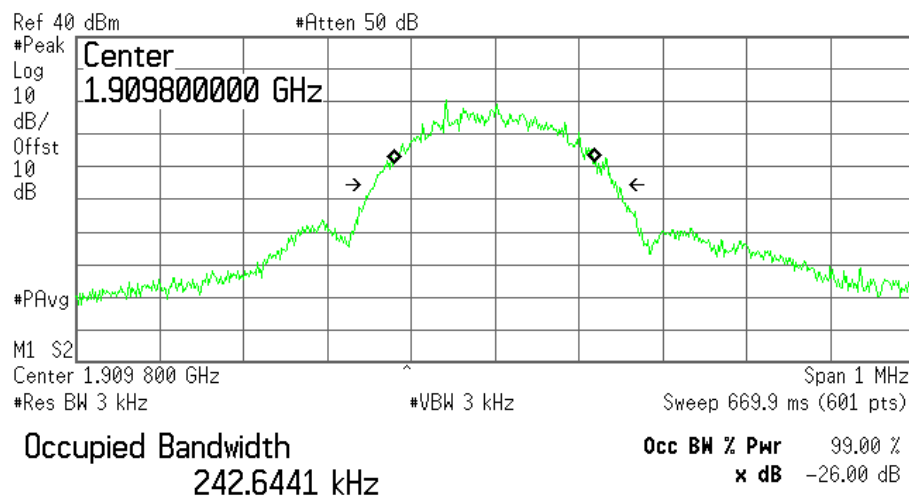

Transmit Freq Error -749.756 Hz
Occupied Bandwidth 290.950 kHz

SIERRA WIRELESS, INC.

5.3.13) WCDMA Occupied Bandwidth, Cellular Low channel, 826.4 MHz, 99% bandwidth

* Agilent 10:58:36 Jul 12, 2006

L

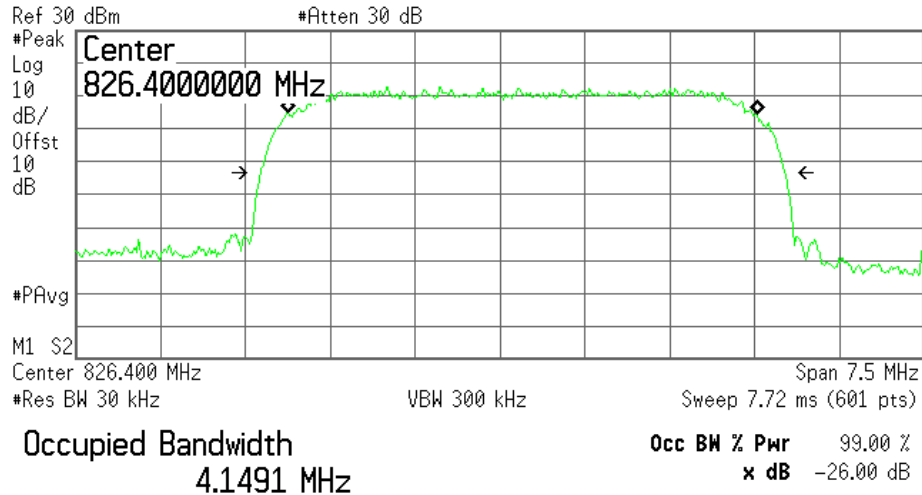

Transmit Freq Error 195.179 kHz

x dB Bandwidth 4.628 MHz

5.3.14) WCDMA Occupied Bandwidth, Cellular Middle channel, 836.4 MHz, 99% bandwidth

* Agilent 10:59:57 Jul 12, 2006

L

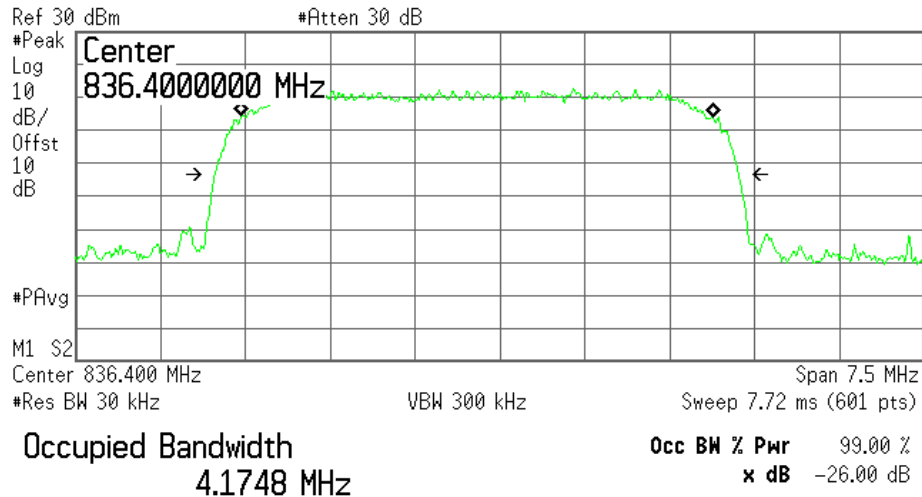

Transmit Freq Error -199.856 kHz

x dB Bandwidth 4.628 MHz

SIERRA WIRELESS, INC.

5.3.15) WCDMA Occupied Bandwidth, Cellular High channel, 846.6 MHz, 99% bandwidth

Agilent 11:01:14 Jul 12, 2006

L

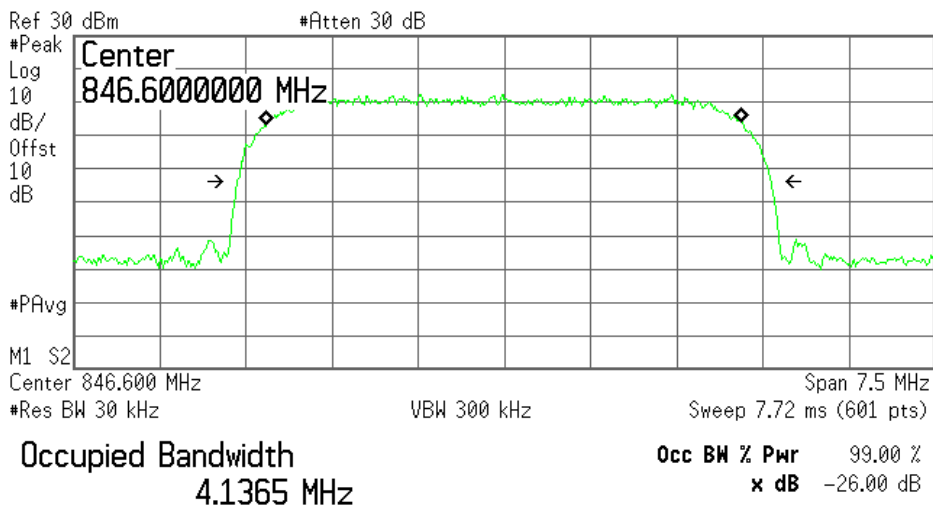

Transmit Freq Error -3.731 kHz
x dB Bandwidth 4.645 MHz

5.3.16) WCDMA Occupied Bandwidth, PCS Low channel, 1852.4 MHz, 99% bandwidth

Agilent 11:31:18 Jul 12, 2006

L

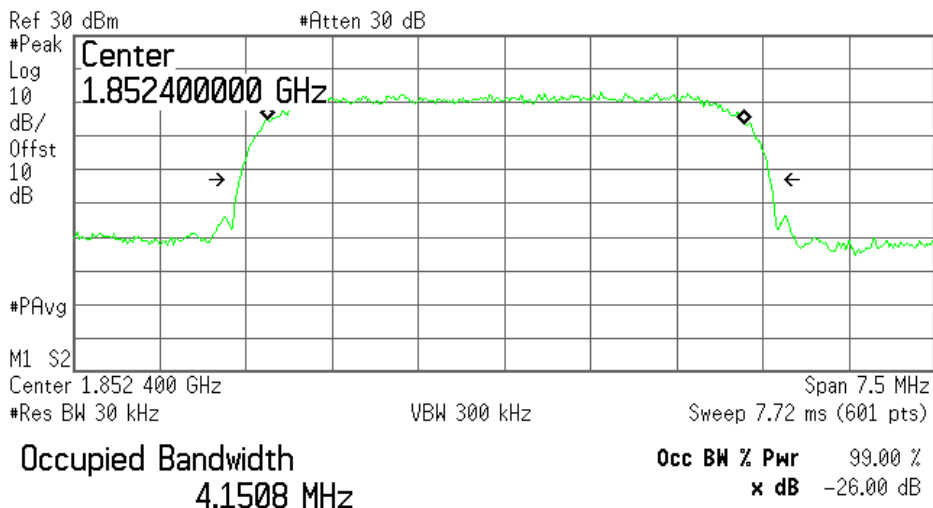

Transmit Freq Error 10.329 kHz
x dB Bandwidth 4.622 MHz

SIERRA WIRELESS, INC.

5.3.17) WCDMA Occupied Bandwidth, PCS Middle channel, 1880 MHz, 99% bandwidth

* Agilent 11:32:34 Jul 12, 2006

L

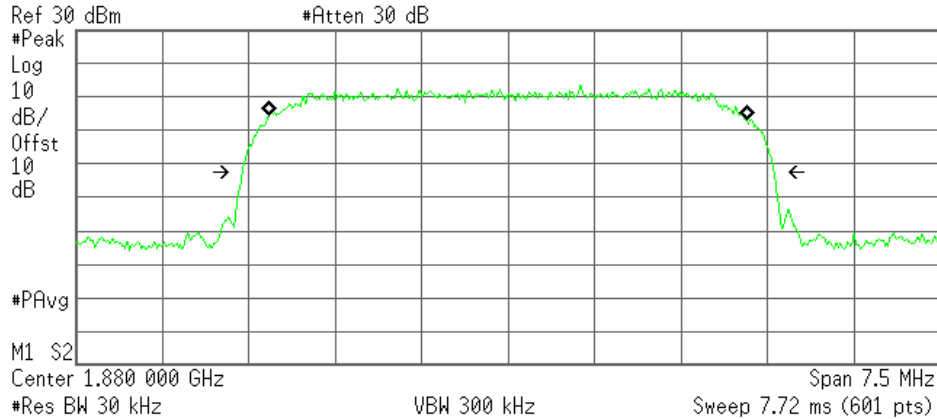

Occupied Bandwidth
4.1473 MHz

Occ BW % Pwr 99.00 %
x dB -26.00 dB

Transmit Freq Error 3.400 kHz
x dB Bandwidth 4.613 MHz

5.3.18) WCDMA Occupied Bandwidth, PCS High channel, 1907.6 MHz, 99% bandwidth

* Agilent 11:33:56 Jul 12, 2006

L

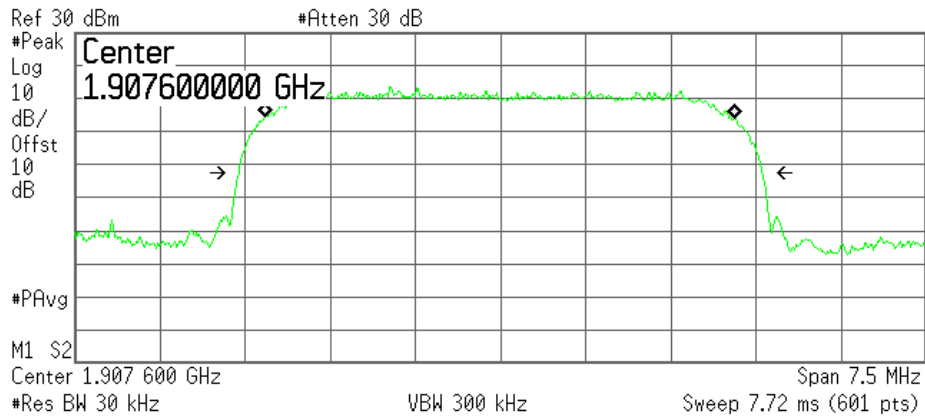

Occupied Bandwidth
4.1387 MHz

Occ BW % Pwr 99.00 %
x dB -26.00 dB

Transmit Freq Error -10.562 kHz
x dB Bandwidth 4.612 MHz

6 Out of Band Emissions at Antenna Terminals

FCC 22.901(d), 22.917, 24.238(a)

Out of Band Emissions:

The mean power of emissions must be attenuated below the mean power of the unmodulated carrier (P) on any frequency outside the frequency band by at least $(43 + 10 \log P)$ dB, in this case, -13dBm.

6.1 Test Procedure

The RF output of the transmitter was connected to a spectrum analyzer through a calibrated coaxial cable. Sufficient scans were taken to show the out-of-band Emissions, if any, up to 10th harmonic. The EUT was scanned for spurious emissions from 1MHz to 20GHz with sufficient bandwidth and video resolution. Data plots are included. The measurement cable path loss at 20GHz (including an attenuator) was 13dB (11dB at lower frequencies). The larger path loss of 13dB was used for all measurements to be conservative. Multiple sweeps were recorded in maximum hold mode using a peak detector to ensure that the worst-case emissions were caught.

Test Setup

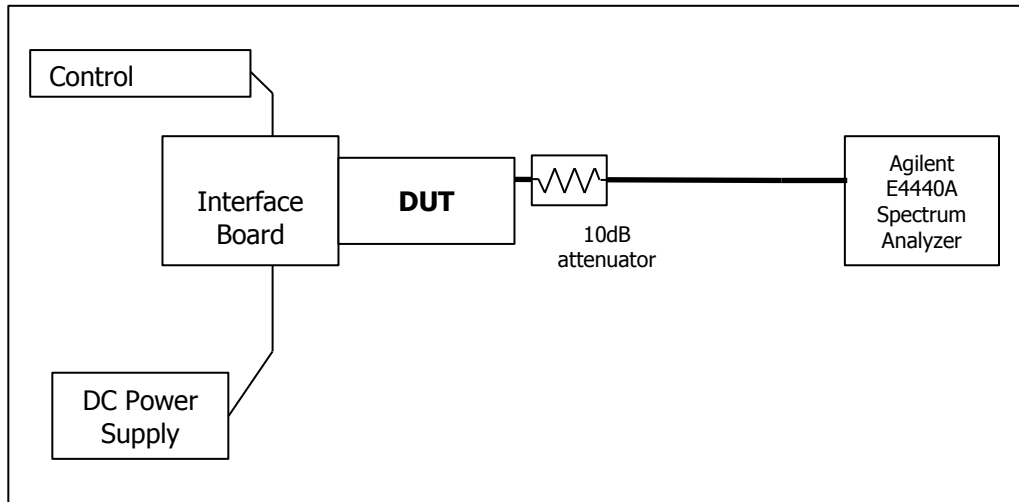

6.2 Test Equipment

EQUIPMENT	MANUFACTURER	MODEL NO.	SERIAL NO.	CAL. DATE
Control Computer	TC	Generic PC	100488	N/A
Wireless Test Set	Rohde & Schwarz	CMU200	836766/030	N/A
Spectrum Analyzer	Agilent	PSA E4440A	US41421268	Sept. 29, 2004
DC Power Supply	HP	6632A	3530A	N/A
Interface Board	Shop built	Minnow	N/A	N/A
Directional Coupler	Mini-Circuits	ZA3PD-2	N/A	N/A

SIERRA WIRELESS, INC.

6.3 Test Results

Refer to the following plots.

- **Cellular Band**

Plot Number	Description
6.4.1 – 6.4.3	GMSK Mode, Low channel, 824.20 MHz
6.4.4 – 6.4.6	GMSK Mode, Middle Channel, 836.6 MHz
6.4.7 – 6.4.9	GMSK Mode, High Channel, 848.8 MHz
6.4.10 – 6.4.12	8-PSK Mode, Low channel, 824.20 MHz
6.4.13 – 6.4.15	8-PSK Mode, Middle Channel, 836.6 MHz
6.4.16 – 6.4.18	8-PSK Mode, High Channel, 848.8 MHz

- **PCS Band**

Plot Number	Description
6.4.19 – 6.4.21	GMSK Mode, Low Channel, 1850.2 MHz
6.4.22 – 6.4.24	GMSK Mode, Middle Channel, 1880.0 MHz
6.4.25 – 6.4.27	GMSK Mode, High Channel, 1909.8 MHz
6.4.28 – 6.4.30	8-PSK, Mode, Low Channel, 1850.2 MHz
6.4.31 – 6.4.33	8-PSK Mode, Middle Channel, 1880.0 MHz
6.4.34 – 6.4.36	8-PSK Mode, High Channel, 1909.8 MHz

- **UMTS Cellular Band**

Plot Number	Description
6.4.37 – 6.4.39	WCDMA Mode, Low Channel, 826.4 MHz
6.4.40 – 6.4.42	WCDMA Mode, Middle Channel, 836.4 MHz
6.4.43 – 6.4.45	WCDMA Mode, High Channel, 846.6 MHz

- **UMTS PCS Band**

Plot Number	Description
6.4.46 – 6.4.48	WCDMA Mode, Low Channel, 1852.4 MHz
6.4.49 – 6.4.51	WCDMA Mode, Middle Channel, 1880.0 MHz
6.4.52 – 6.4.54	WCDMA Mode, High Channel, 1907.6 MHz

These plots show that the conducted emission limits requirements are met.

6.4 Test Plots

Plot 6.4.1) Out of Band Emissions at Antenna Terminals

GMSK, Low channel, 824.200 MHz, 1 MHz to 1 GHz

Agilent 12:00:47 Jul 10, 2006

L

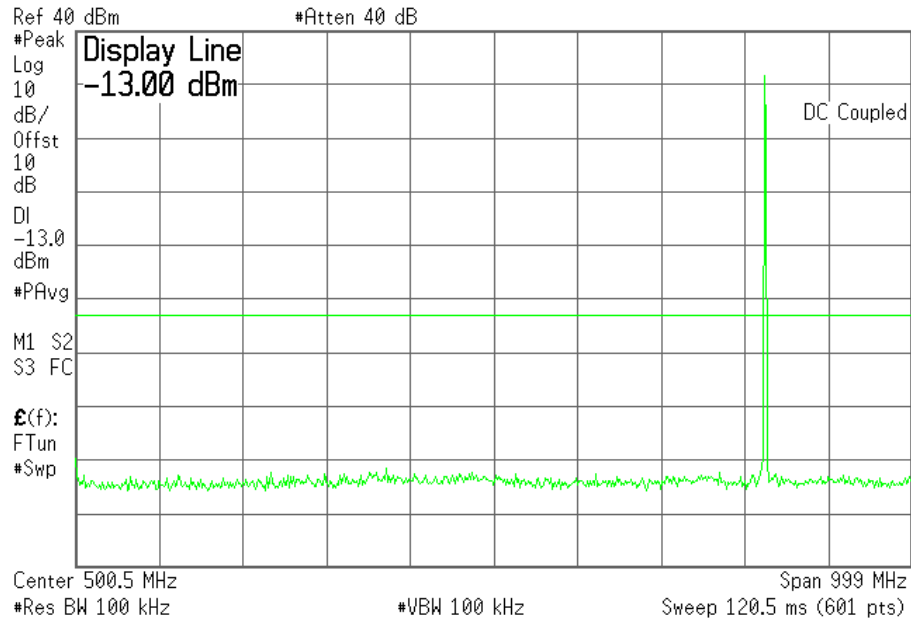

Plot 6.4.2) Out of Band Emissions at Antenna Terminals

GMSK, Low channel, 824.200 MHz, TX signal +/- 20 MHz

Agilent 12:14:03 Jul 10, 2006

L

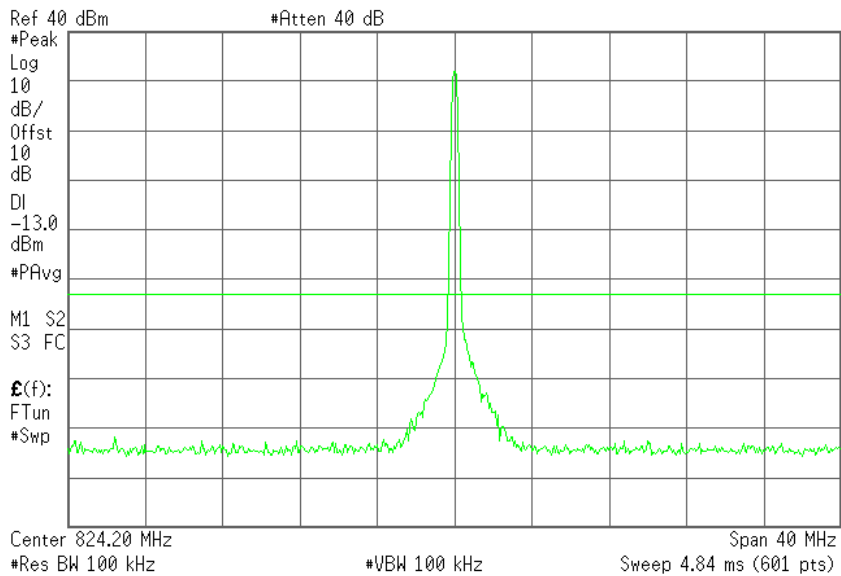

The strong emission shown in each case is the carrier signal.

Plot 6.4.3) Out of Band Emissions at Antenna Terminals

GMSK, Low channel, 824.200 MHz, 1 GHz to 20 GHz

Agilent 15:37:10 Jul 10, 2006

L

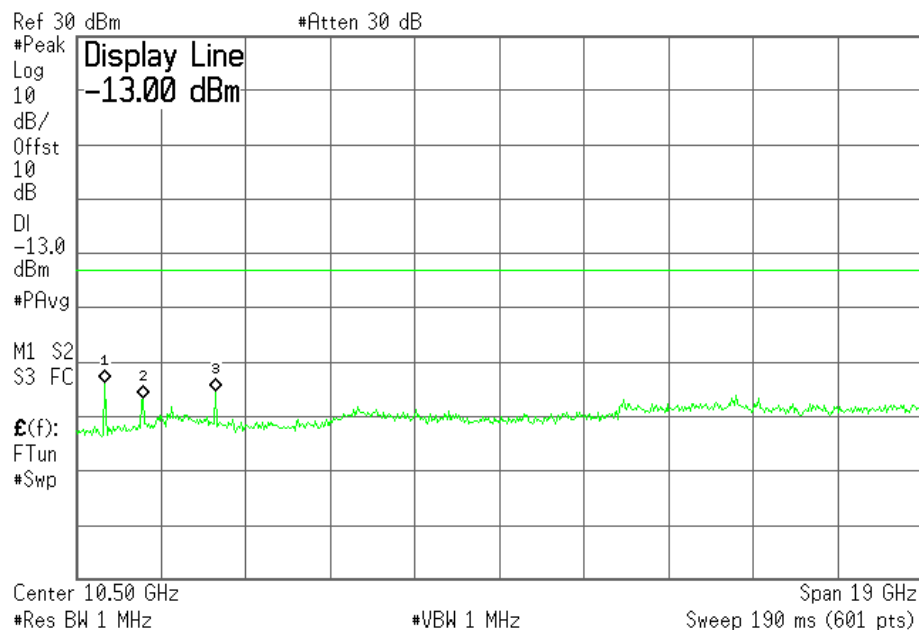

Cellular Harmonics for Ch. 128 (824.2 MHz)	Level (dBm)
Second	-33 dBm
Third	-37 dBm
All others	< -30dBm up to 20GHz

Plot 6.4.4) Out of Band Emissions at Antenna Terminals

GMSK, Mid Channel, 836.6 MHz, 1 MHz to 1 GHz

Agilent 12:01:10 Jul 10, 2006

L

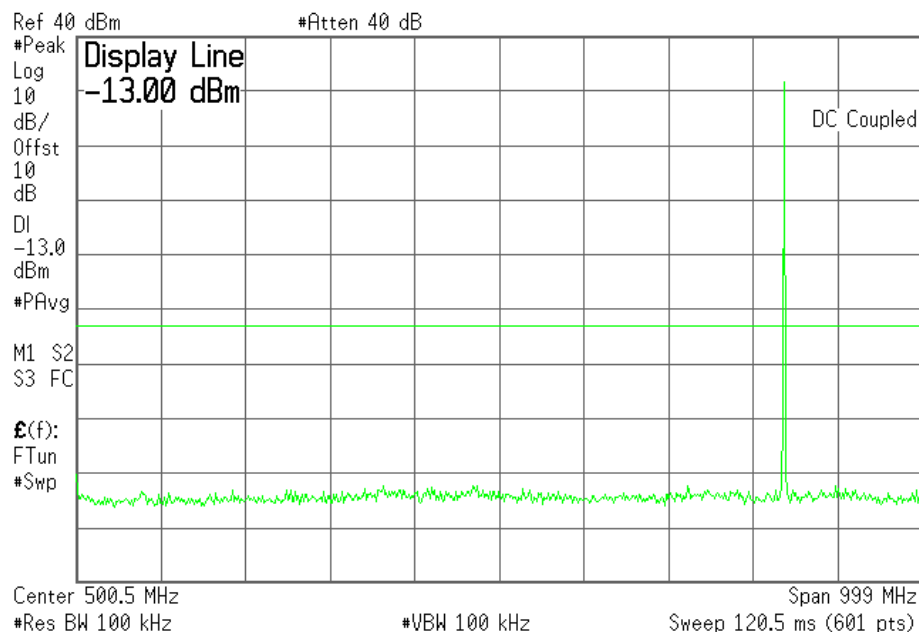

Plot 6.4.5) Out of Band Emissions at Antenna Terminals

GMSK, Mid Channel, 836.6 MHz, TX signal +/- 20 MHz

Agilent 12:15:45 Jul 10, 2006

L

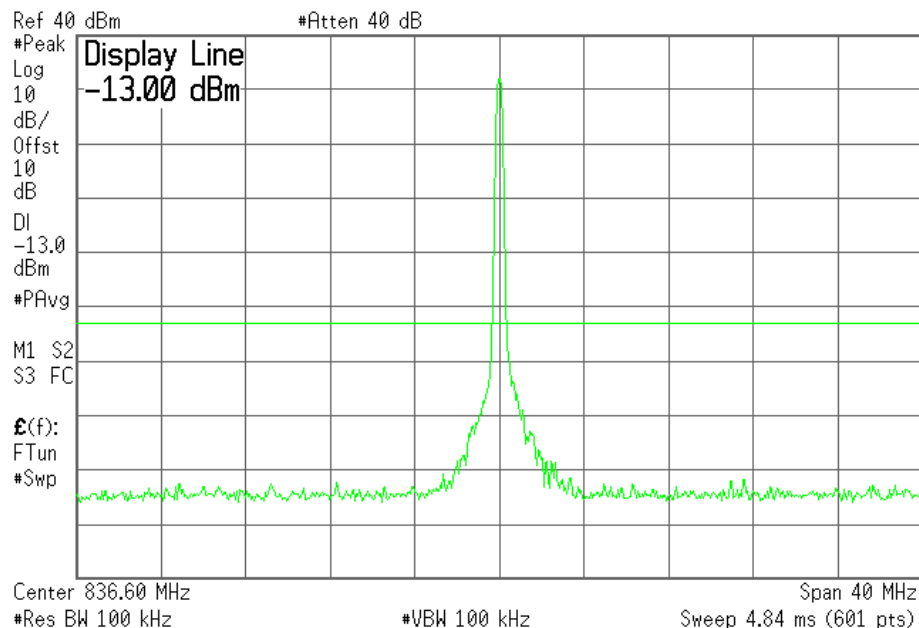

The strong emission shown in each case is the carrier signal.

Plot 6.4.6) Out of Band Emissions at Antenna Terminals

GMSK, Mid Channel, 836.6 MHz, 1 GHz to 20 GHz

Agilent 15:44:31 Jul 10, 2006

L

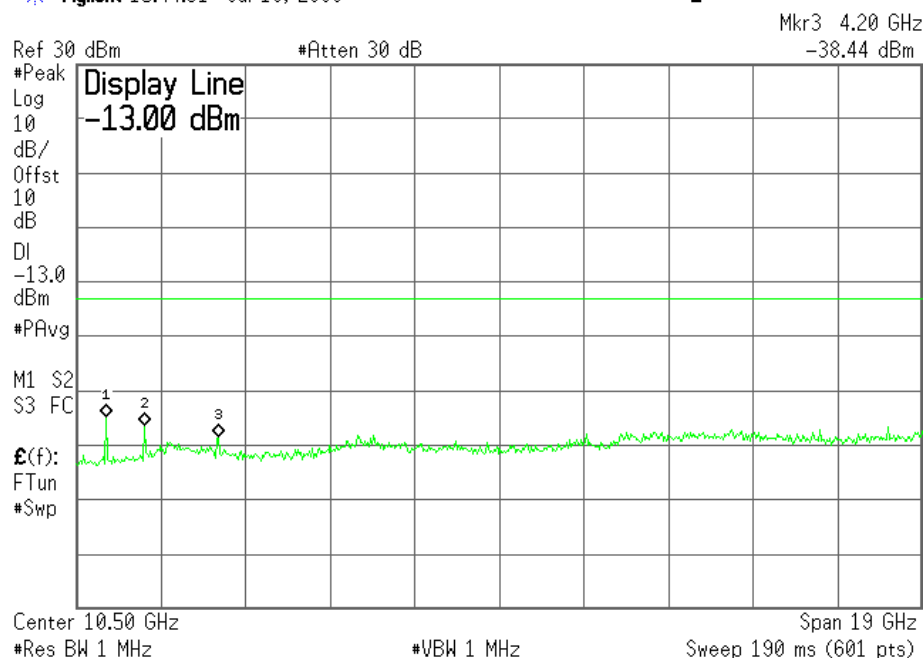

Cellular Harmonics for Ch. 190 (836.6 MHz)	Level (dBm)
Second	-34 dBm
Third	-35 dBm
All others	< -30dBm up to 20GHz

Plot 6.4.7) Out of Band Emissions at Antenna Terminals

GMSK, High Channel, 848.8 MHz, 1 MHz to 1 GHz

Agilent 12:01:52 Jul 10, 2006 L

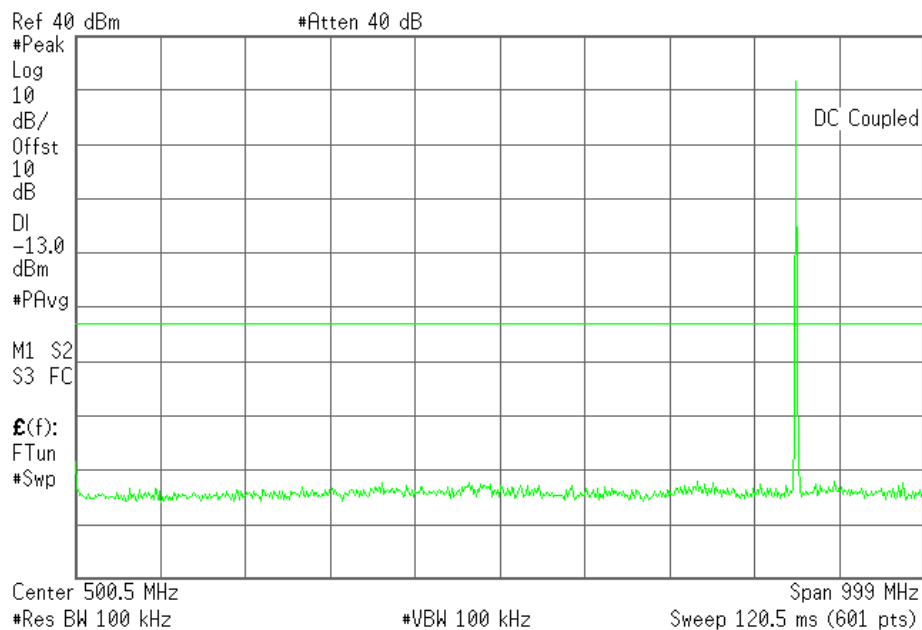

Plot 6.4.8) Out of Band Emissions at Antenna Terminals

GMSK, High Channel, 848.8 MHz, TX signal +/- 20 MHz

Agilent 12:16:33 Jul 10, 2006 R L

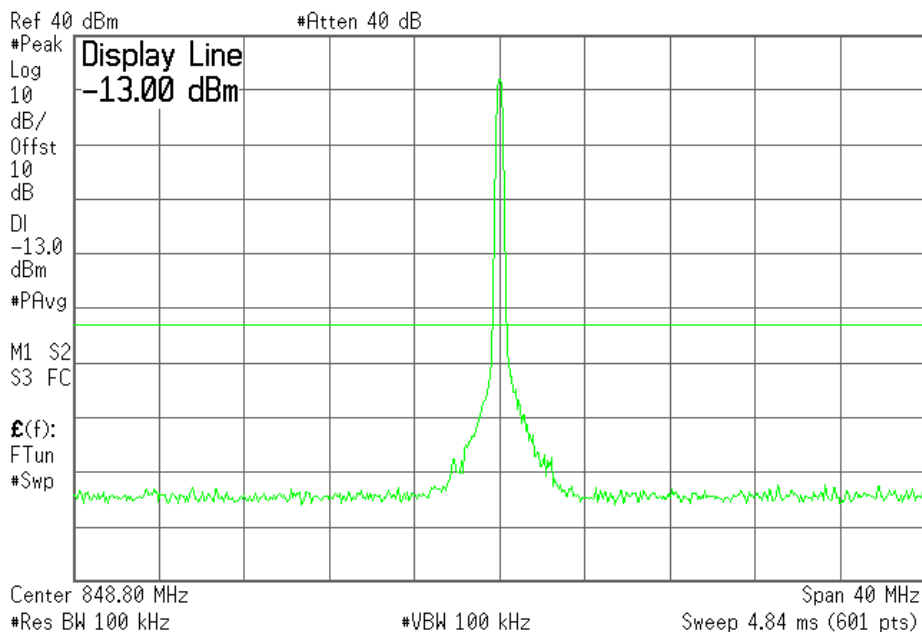

The strong emission shown in each case is the carrier signal.

Plot 6.4.9) Out of Band Emissions at Antenna Terminals

GMSK, High Channel, 848.8 MHz, 1 GHz to 20 GHz

Agilent 15:45:32 Jul 10, 2006

L

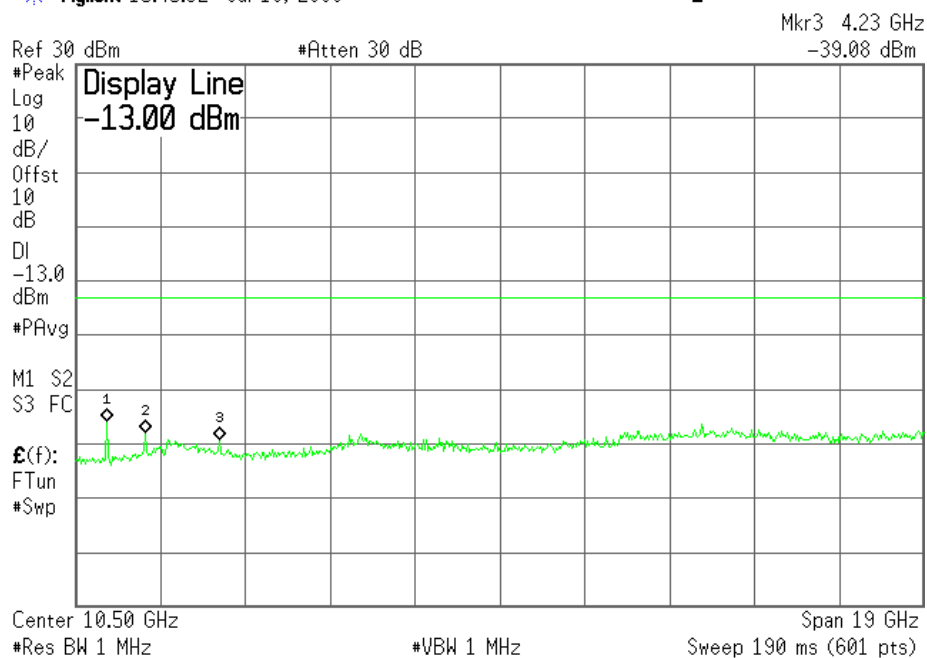

Cellular Harmonics for Ch. 251 (848.8 MHz)	Level (dBm)
Second	-36 dBm
Third	-37 dBm
All others	< -30dBm up to 20GHz

Plot 6.4.10) Out of Band Emissions at Antenna Terminals

8-PSK, Low channel, 824.200 MHz, 1 MHz to 1 GHz

Agilent 11:59:18 Jul 10, 2006 L

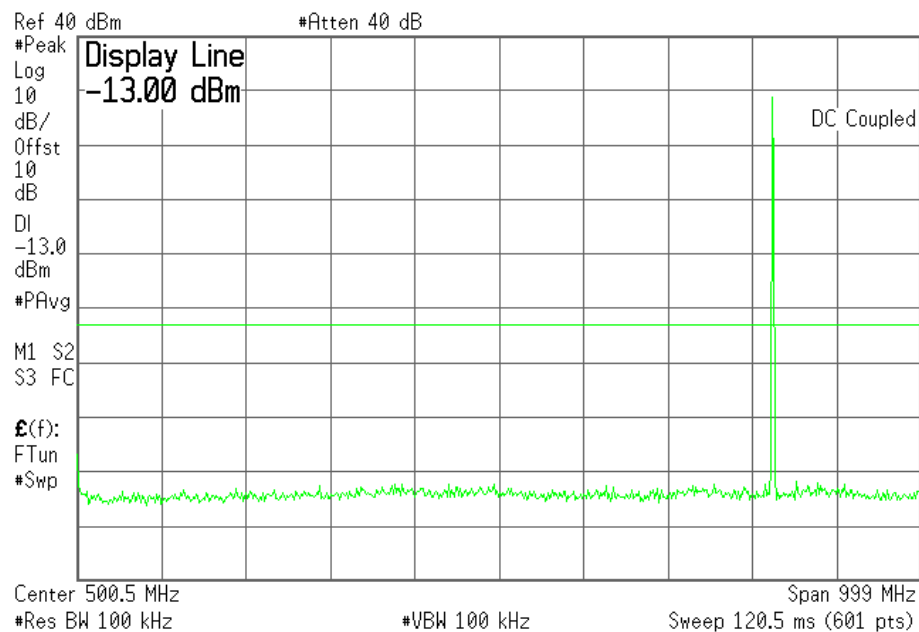

Plot 6.4.11) Out of Band Emissions at Antenna Terminals

8-PSK, Low channel, 824.200 MHz, TX signal +/- 20 MHz

Agilent 12:20:27 Jul 10, 2006 L

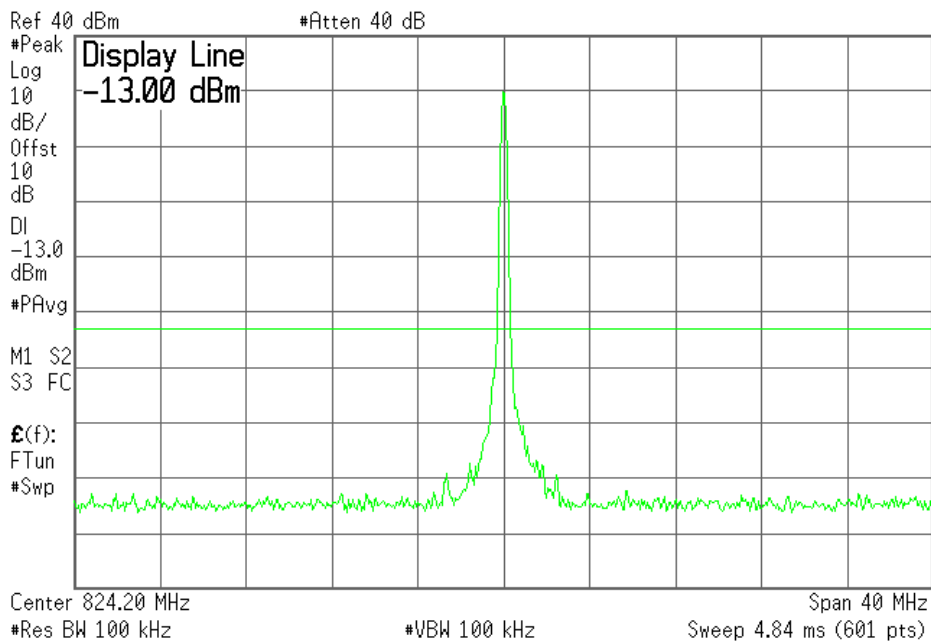

The strong emission shown in each case is the carrier signal.

SIERRA WIRELESS, INC.

Plot 6.4.12) Out of Band Emissions at Antenna Terminals

8-PSK, Low channel, 824.200 MHz, 1 GHz to 20 GHz

Agilent 15:39:54 Jul 10, 2006

L

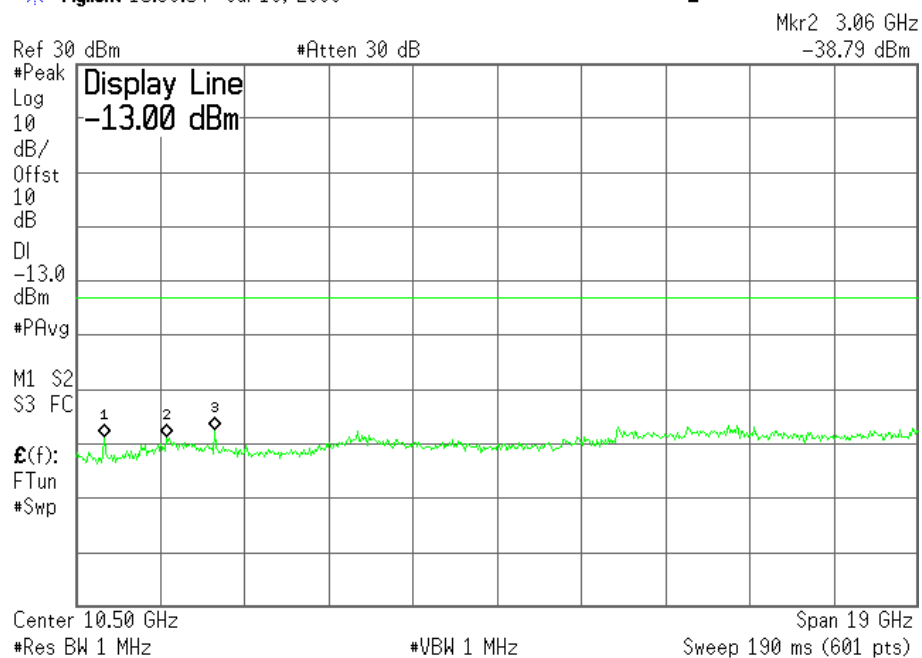

Cellular Harmonics for Ch. 128 (824.2 MHz)	Level (dBm)
Second	-38dBm
Third	-36dBm
All others	< -30dBm up to 20GHz

Plot 6.4.13) Out of Band Emissions at Antenna Terminals

8-PSK, Mid Channel, 836.6 MHz, 1 MHz to 1 GHz

Agilent 11:58:45 Jul 10, 2006 L

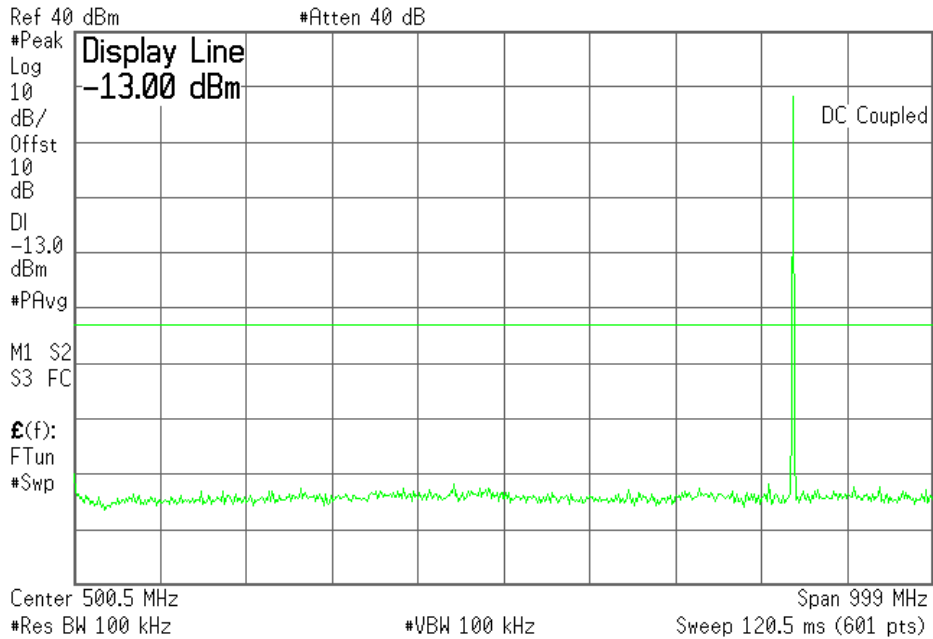

Plot 6.4.14) Out of Band Emissions at Antenna Terminals

8-PSK, Mid Channel, 836.6 MHz, TX signal +/- 20 MHz

Agilent 12:19:28 Jul 10, 2006 L

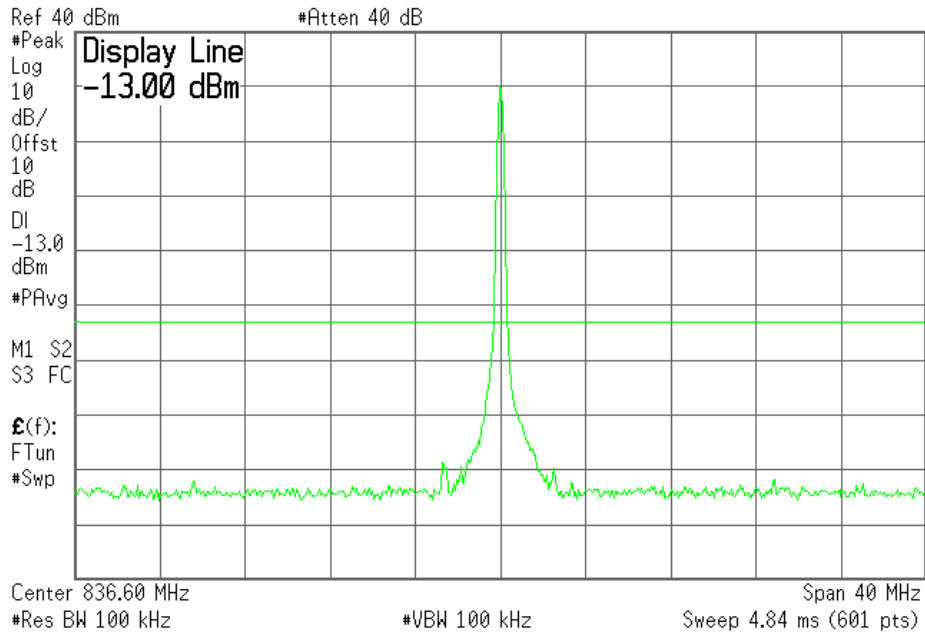

The strong emission shown in each case is the carrier signal.

SIERRA WIRELESS, INC.

Plot 6.4.15) Out of Band Emissions at Antenna Terminals

8-PSK, Mid Channel, 836.6 MHz, 1 GHz to 20 GHz

Agilent 15:41:10 Jul 10, 2006

L

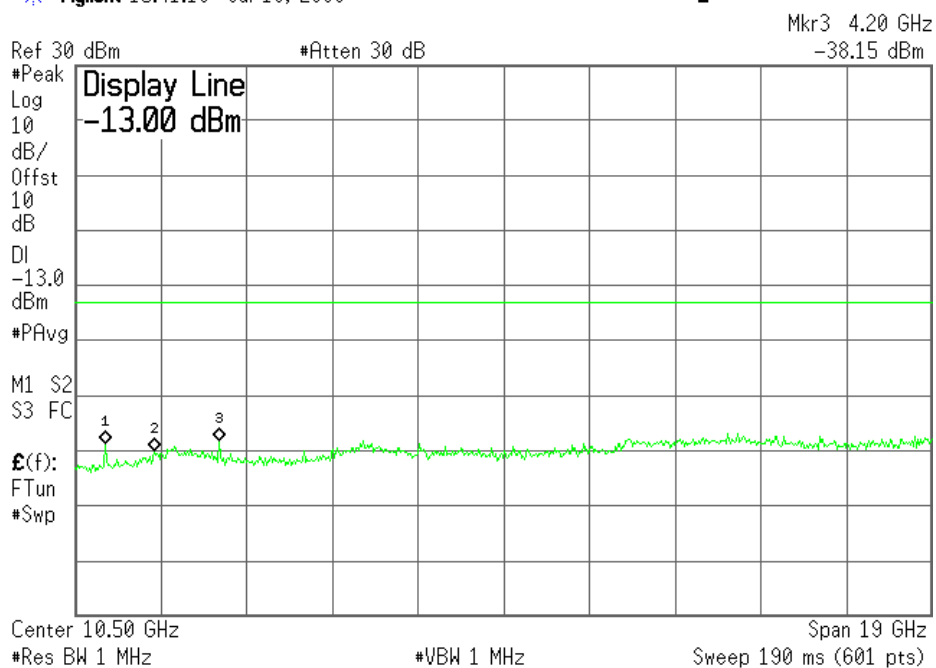

Cellular Harmonics for Ch. 190 (836.6 MHz)	Level (dBm)
Second	-39dBm
Third	-37dBm
All others	< -30dBm up to 20GHz

Plot 6.4.16) Out of Band Emissions at Antenna Terminals

8-PSK, High Channel, 848.8 MHz, 1 MHz to 1 GHz

Agilent 11:58:07 Jul 10, 2006

L

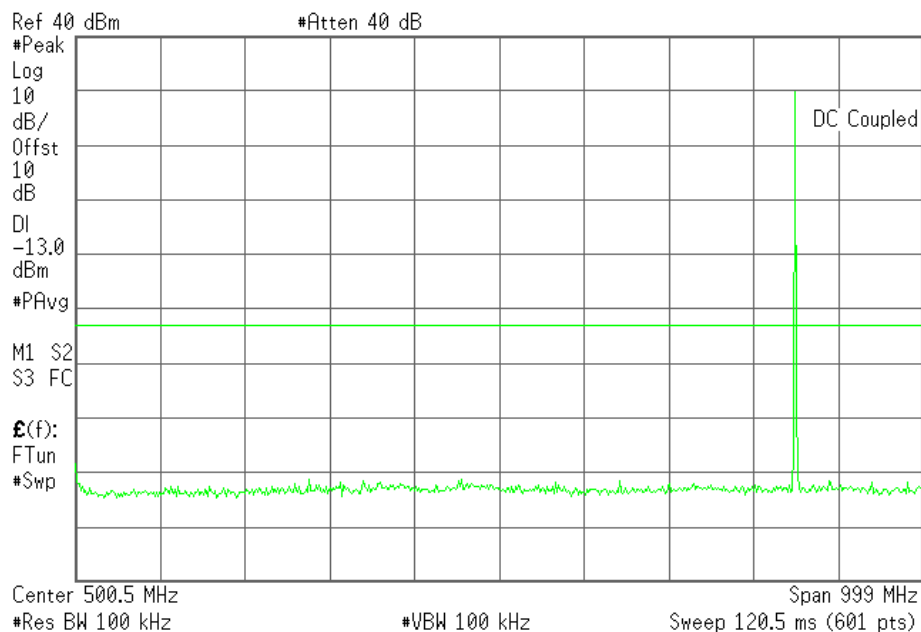

Plot 6.4.17) Out of Band Emissions at Antenna Terminals

8-PSK, High Channel, 848.8 MHz, TX signal +/- 20 MHz

Agilent 12:18:10 Jul 10, 2006

L

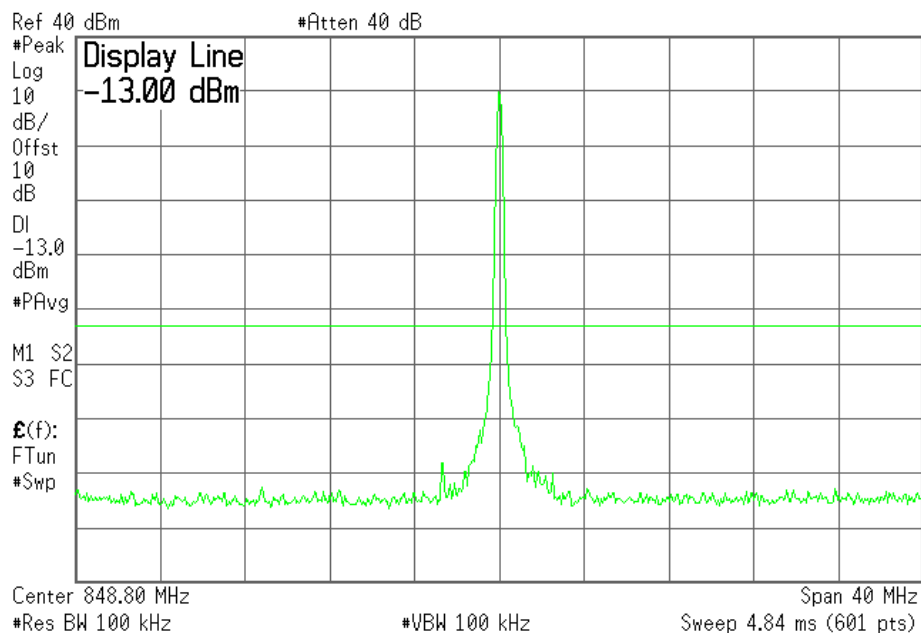

The strong emission shown in each case is the carrier signal.

SIERRA WIRELESS, INC.

Plot 6.4.18) Out of Band Emissions at Antenna Terminals

8-PSK, High Channel, 848.8 MHz, 1 GHz to 20 GHz

Agilent 15:42:37 Jul 10, 2006

L

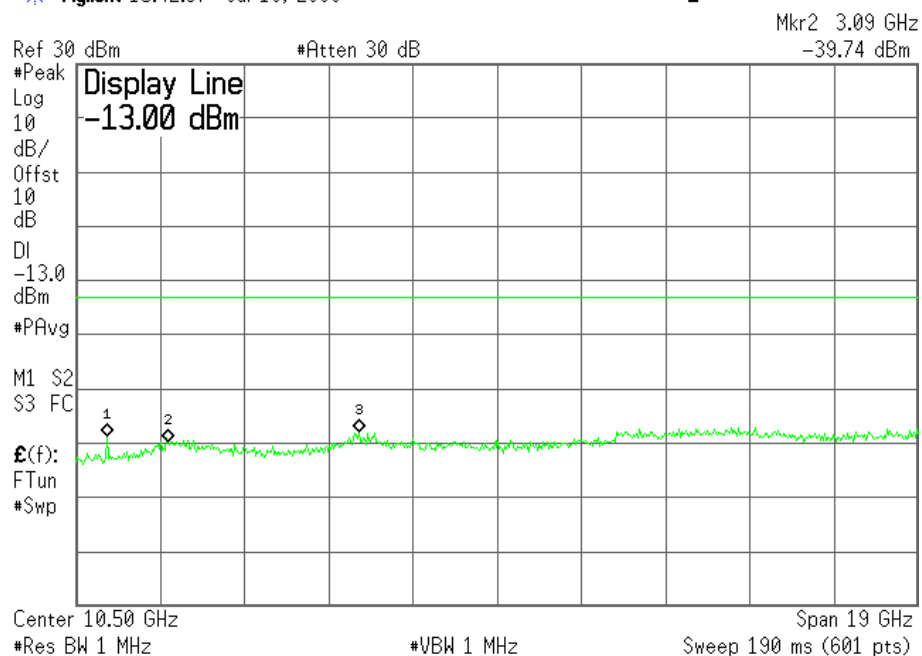

Cellular Harmonics for Ch. 251 (848.8 MHz)	Level (dBm)
Second	-38dBm
Third	-39dBm
All others	< -30dBm up to 20GHz

Plot 6.4.19) Out of Band Emissions at Antenna Terminals

GMSK, Low channel, 1850.2 MHz, 1 MHz to 1 GHz

Agilent 12:04:22 Jul 10, 2006

L

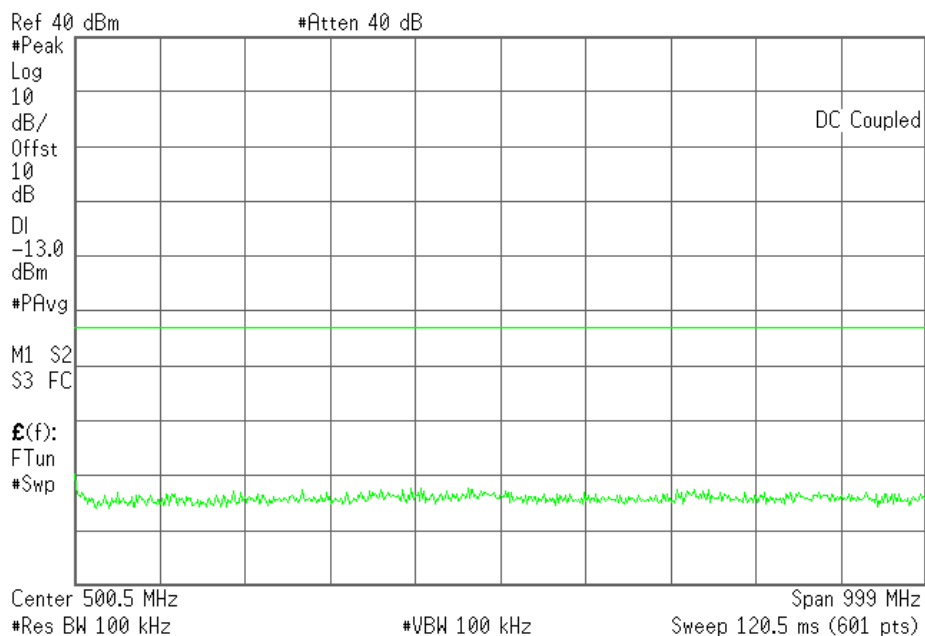

Plot 6.4.20) Out of Band Emissions at Antenna Terminals

GMSK, Low channel, 1850.2 MHz, TX signal +/- 20 MHz

Agilent 12:22:24 Jul 10, 2006

L

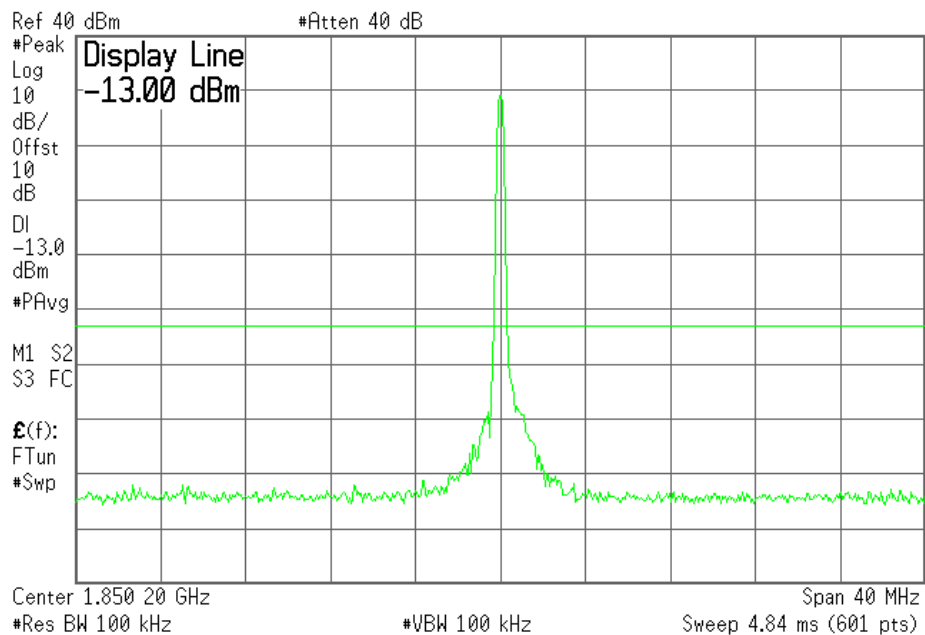

SIERRA WIRELESS, INC.

Plot 6.4.21) Out of Band Emissions at Antenna Terminals

GMSK, Low channel, 1850.2 MHz, 1 GHz to 20 GHz

Agilent 15:49:34 Jul 10, 2006

L

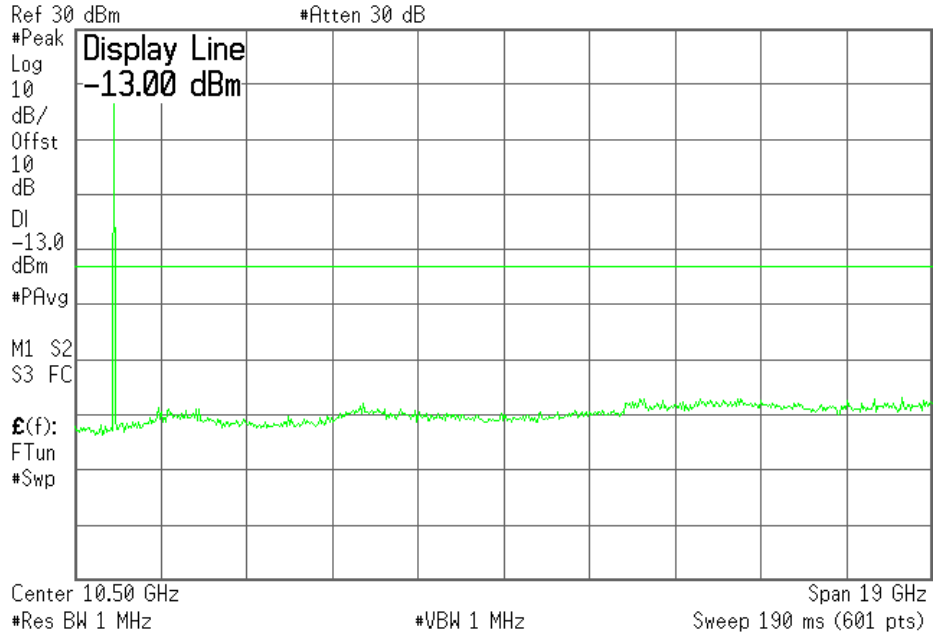

The strong emission shown is the carrier signal.

Plot 6.4.22) Out of Band Emissions at Antenna Terminals

GMSK, Middle channel, 1880.0 MHz, 1 MHz to 1 GHz

Agilent 12:05:56 Jul 10, 2006 L

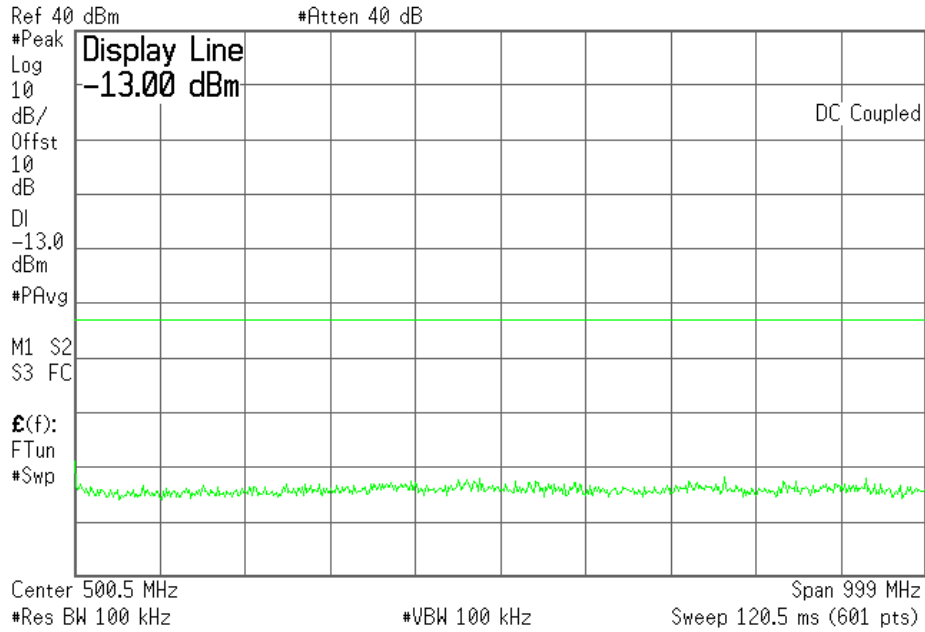

Plot 6.4.23) Out of Band Emissions at Antenna Terminals

GMSK, Middle channel, 1880.0 MHz, TX signal +/- 20 MHz

Agilent 12:23:10 Jul 10, 2006 L

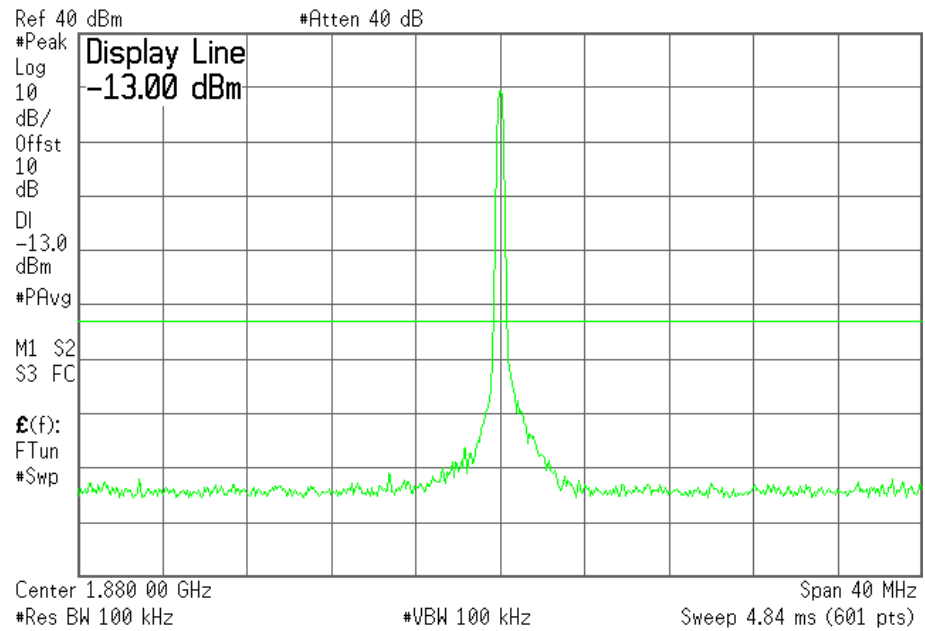

SIERRA WIRELESS, INC.

Plot 6.4.24) Out of Band Emissions at Antenna Terminals

GMSK, Middle channel, 1880.0 MHz, 1 GHz to 20 GHz

Agilent 15:50:28 Jul 10, 2006

L

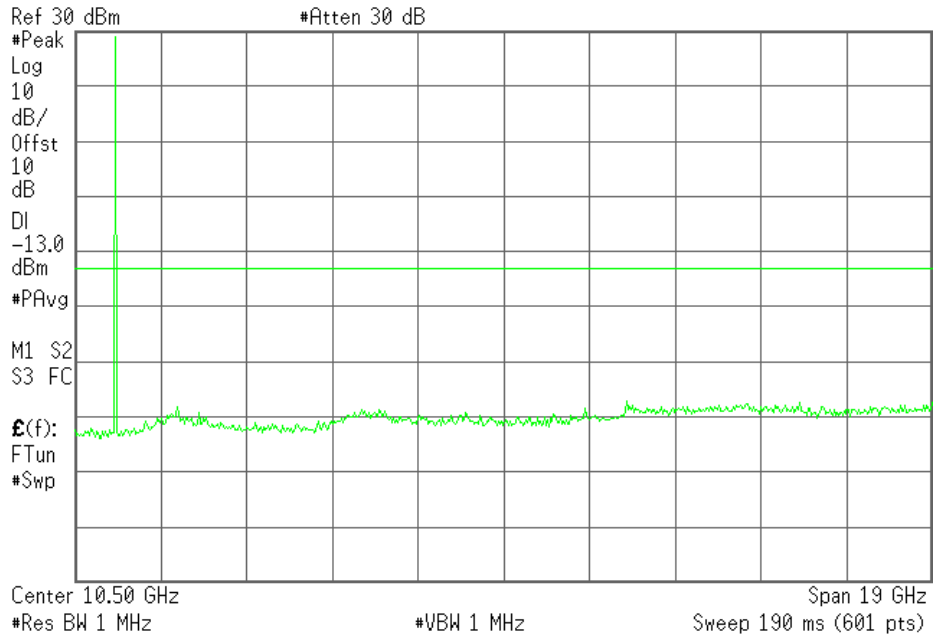

The strong emission shown is the carrier signal.

Plot 6.4.25) Out of Band Emissions at Antenna Terminals

GMSK, High channel, 1909.8 MHz, 1 MHz to 1 GHz

Agilent 12:06:35 Jul 10, 2006

L

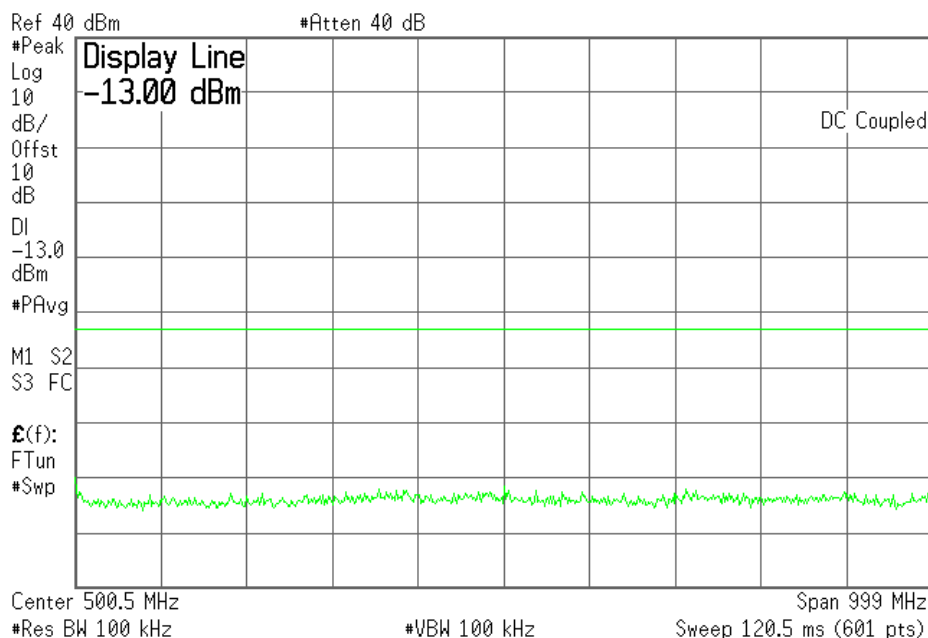

Plot 6.4.26) Out of Band Emissions at Antenna Terminals

GMSK, High channel, 1909.8 MHz, TX signal +/- 20 MHz

Agilent 12:23:43 Jul 10, 2006

L

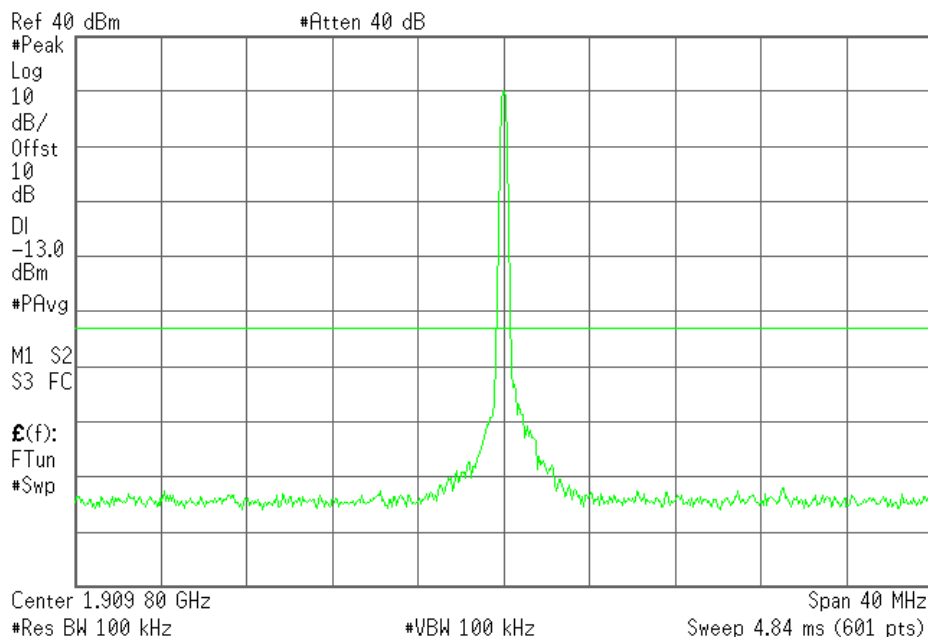

SIERRA WIRELESS, INC.

Plot 6.4.27) Out of Band Emissions at Antenna Terminals

GMSK, High channel, 1909.8 MHz, 1 GHz to 20 GHz

Agilent 15:51:17 Jul 10, 2006

L

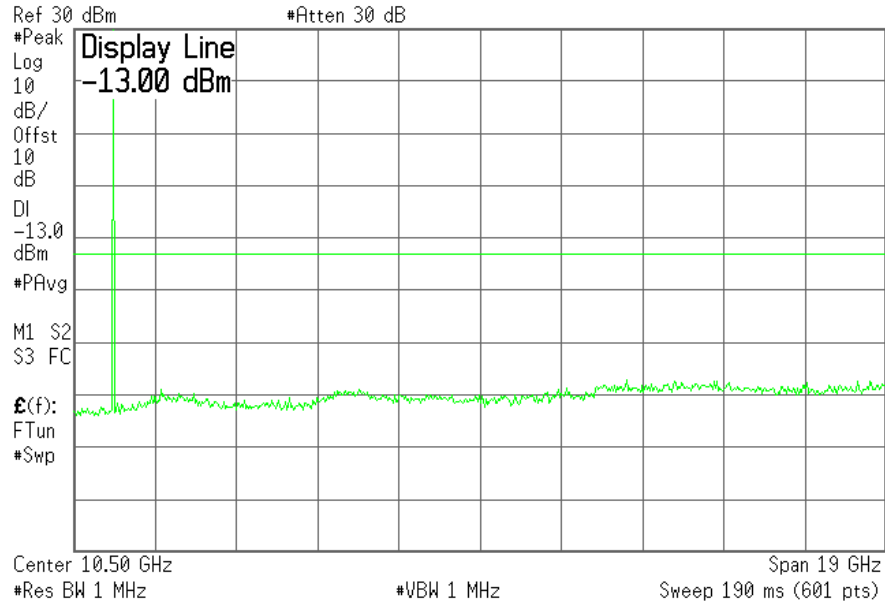

The strong emission shown is the carrier signal.

Plot 6.4.28) Out of Band Emissions at Antenna Terminals

8-PSK, Low channel, 1850.2 MHz, 1 MHz to 1 GHz

Agilent 12:07:39 Jul 10, 2006

L

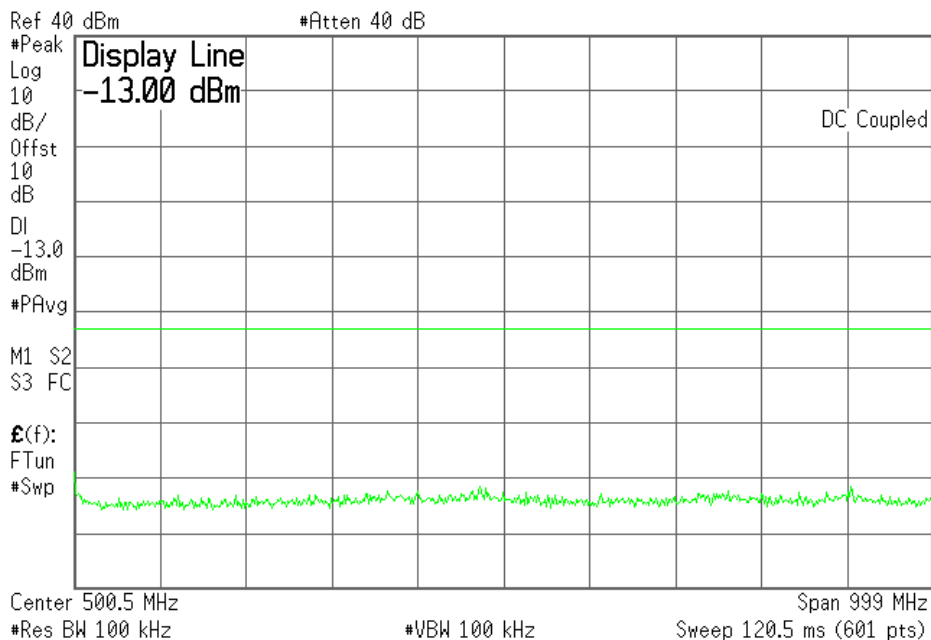

Plot 6.4.29) Out of Band Emissions at Antenna Terminals

8-PSK, Low channel, 1850.2 MHz, TX signal +/- 20 MHz

Agilent 12:28:32 Jul 10, 2006

R L

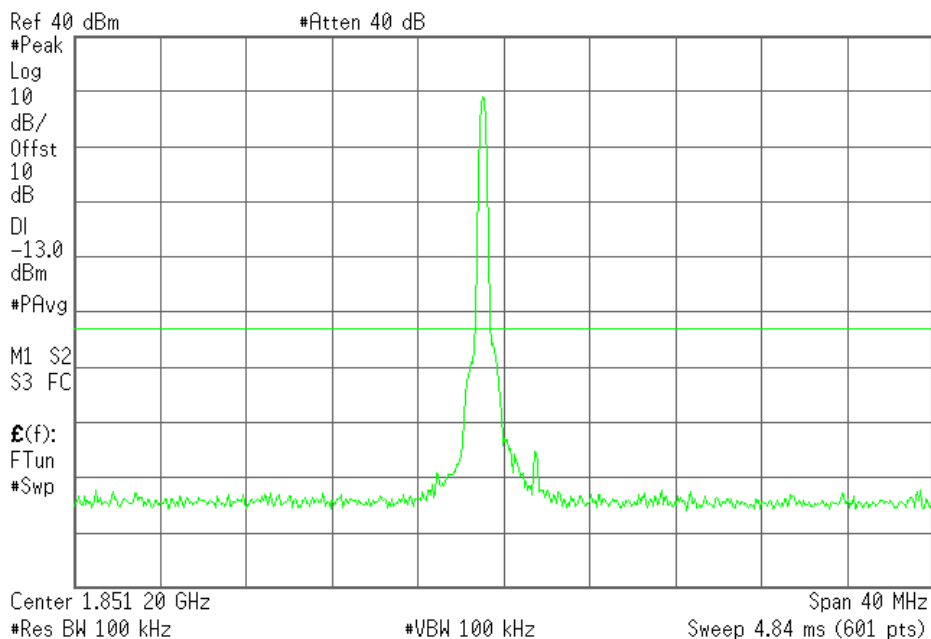

Plot 6.4.30) Out of Band Emissions at Antenna Terminals

8-PSK, Low channel, 1850.2 MHz, 1 GHz to 20 GHz

Agilent 15:52:30 Jul 10, 2006

L

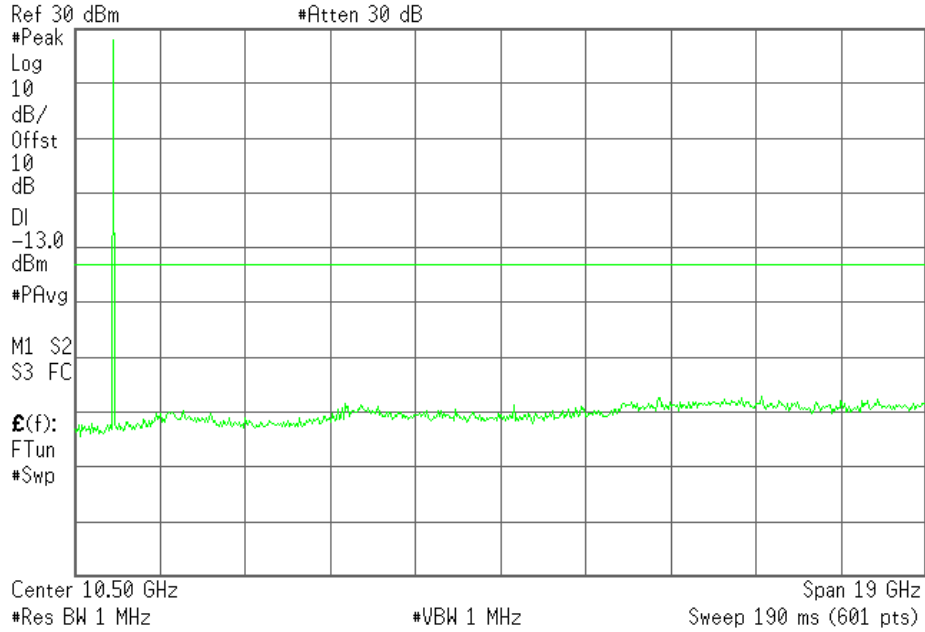

The strong emission shown is the carrier signal.

Plot 6.4.31) Out of Band Emissions at Antenna Terminals

8-PSK, Middle channel, 1880.0 MHz, 1 MHz to 1 GHz

Agilent 12:08:34 Jul 10, 2006 L

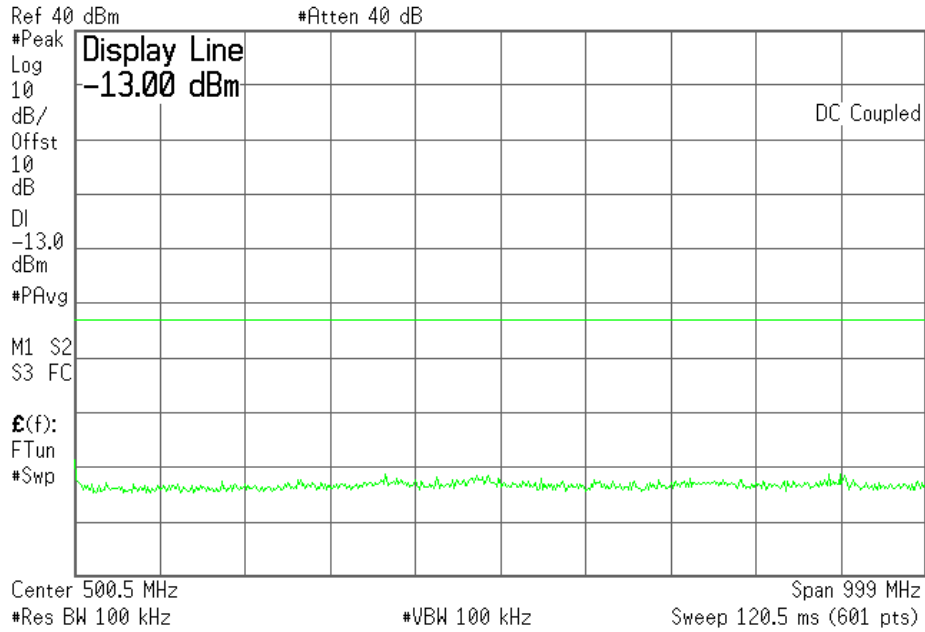

Plot 6.4.32) Out of Band Emissions at Antenna Terminals

8-PSK, Middle channel, 1880.0 MHz, TX signal +/- 20 MHz

Agilent 12:27:09 Jul 10, 2006 L

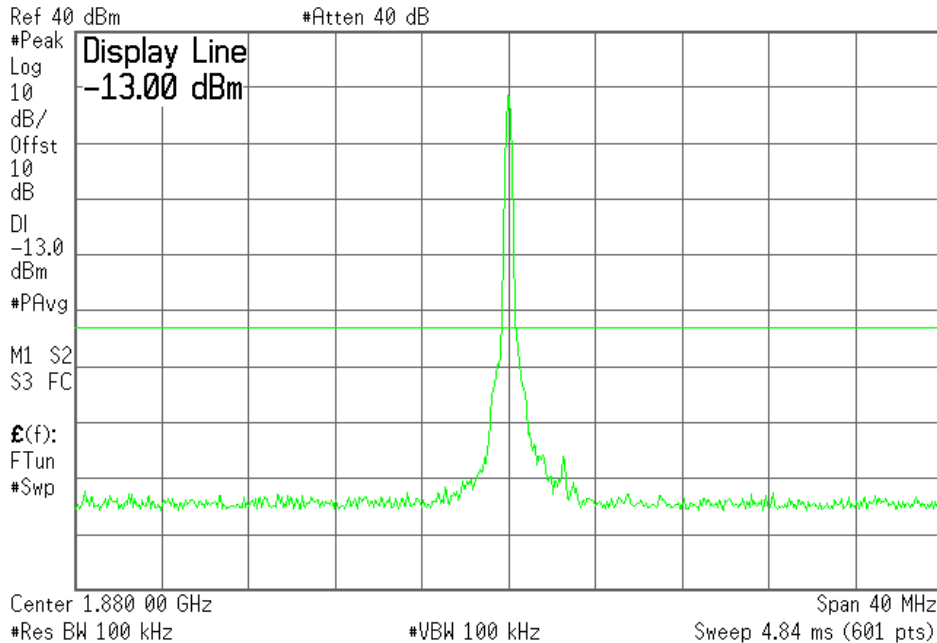

SIERRA WIRELESS, INC.

Plot 6.4.33) Out of Band Emissions at Antenna Terminals

8-PSK, Middle channel, 1880.0 MHz, 1 GHz to 20 GHz

* Agilent 15:53:40 Jul 10, 2006

L

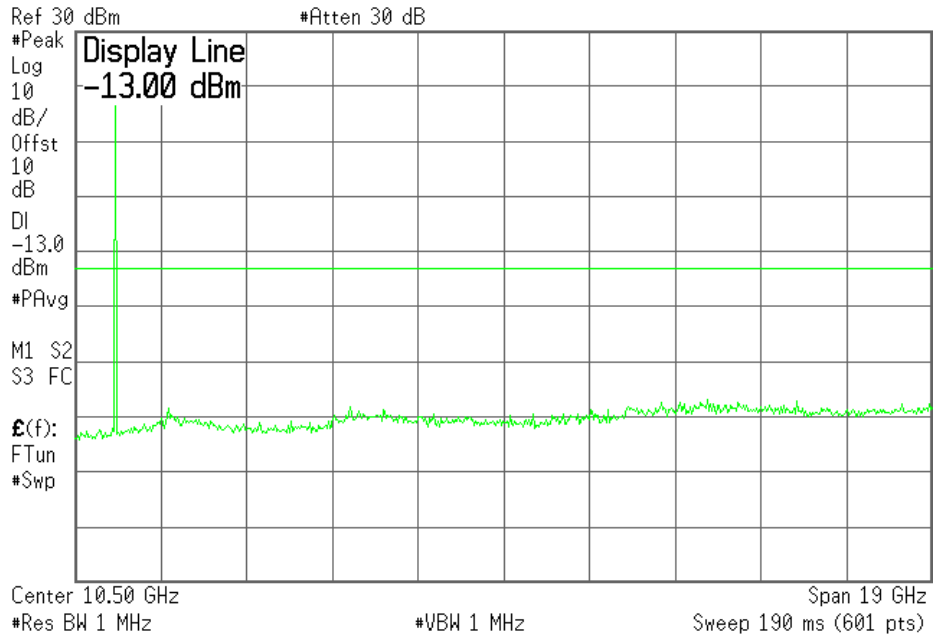

The strong emission shown is the carrier signal.

Plot 6.4.34) Out of Band Emissions at Antenna Terminals

8-PSK, High channel, 1909.8 MHz, 1 MHz to 1 GHz

Agilent 12:10:07 Jul 10, 2006 L

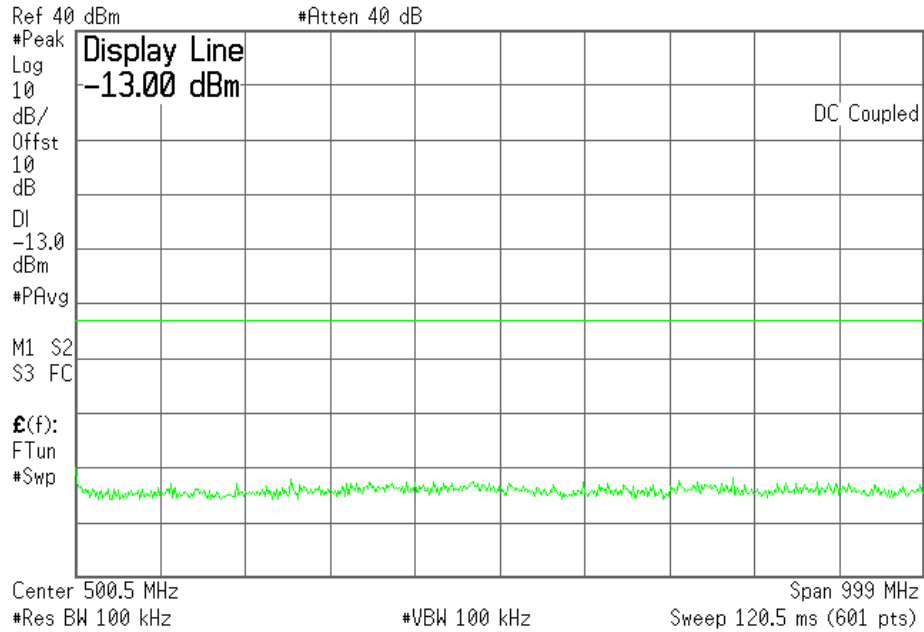

Plot 6.4.35) Out of Band Emissions at Antenna Terminals

8-PSK, High channel, 1909.8 MHz, TX signal +/- 20 MHz

Agilent 12:25:51 Jul 10, 2006 L

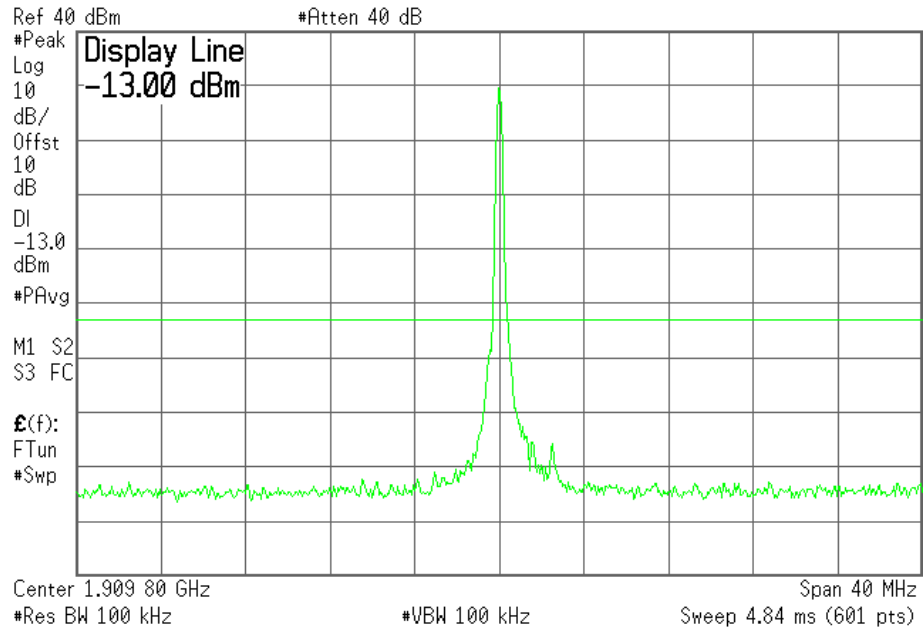

Plot 6.4.36) Out of Band Emissions at Antenna Terminals

8-PSK, High channel, 1909.8 MHz, 1 GHz to 20 GHz

Agilent 16:01:34 Jul 10, 2006

L

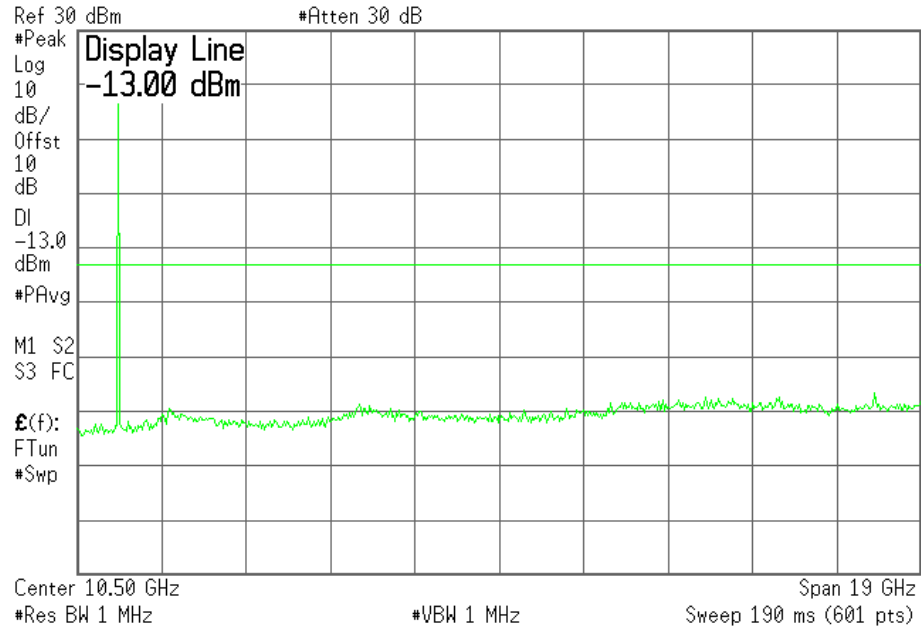

The strong emission shown is the carrier signal.

Plot 6.4.37) Out of Band Emissions at Antenna Terminals

WCDMA, Low channel, 826.4 MHz, 1 MHz to 1 GHz

Agilent 14:00:27 Jul 12, 2006

L

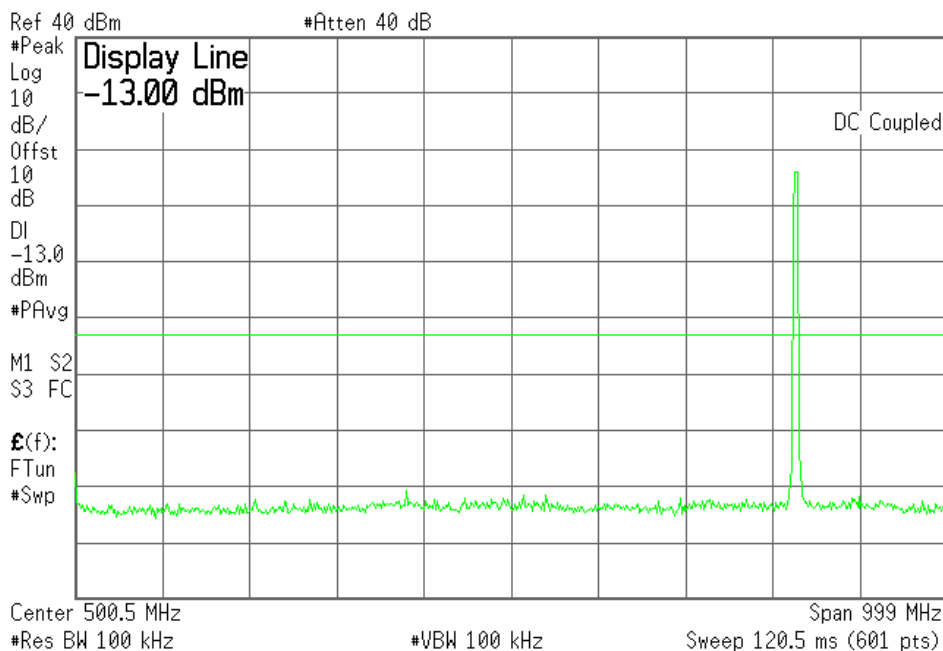

Plot 6.4.38) Out of Band Emissions at Antenna Terminals

WCDMA, Low channel, 826.4 MHz, TX signal +/- 20 MHz

Agilent 15:09:19 Jul 12, 2006

L

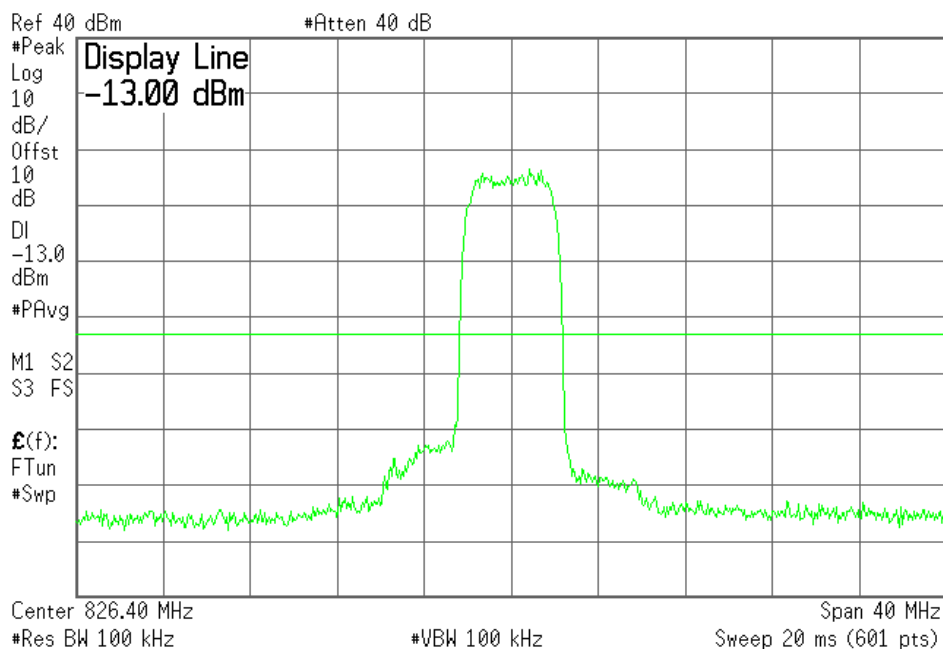

The strong emission shown in each case is the carrier signal.

SIERRA WIRELESS, INC.

Plot 6.4.39) Out of Band Emissions at Antenna Terminals

WCDMA, Low channel, 826.4 MHz, 1 GHz to 20 GHz

* Agilent 15:38:17 Jul 12, 2006

L

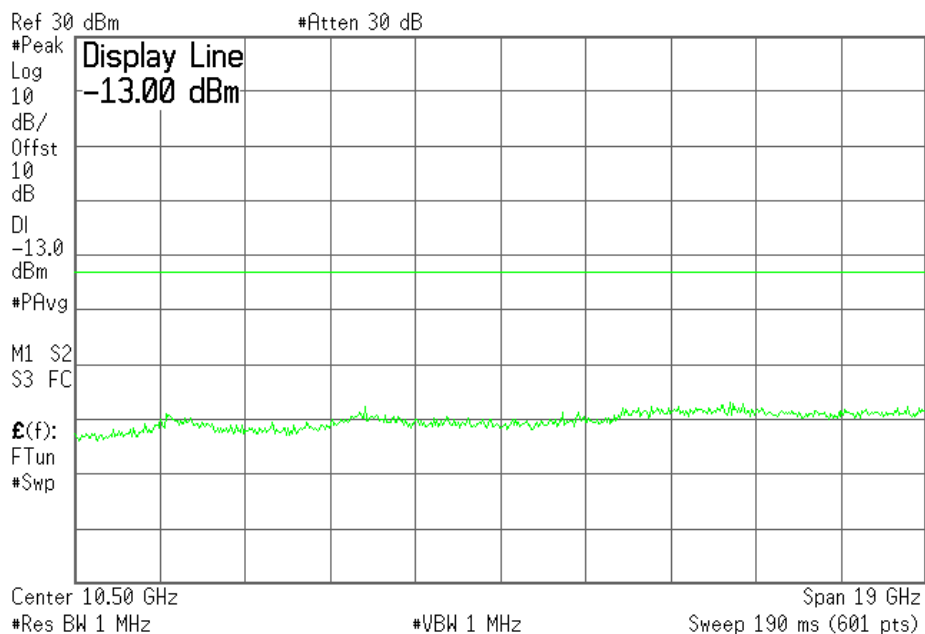

Cellular Harmonics for Ch. 128 (824.2 MHz)	Level (dBm)
Second	--
Third	--
All others	< -30dBm up to 20GHz

Plot 6.4.40) Out of Band Emissions at Antenna Terminals

WCDMA, Middle channel, 836.4 MHz, 1 MHz to 1 GHz

Agilent 14:02:34 Jul 12, 2006 L

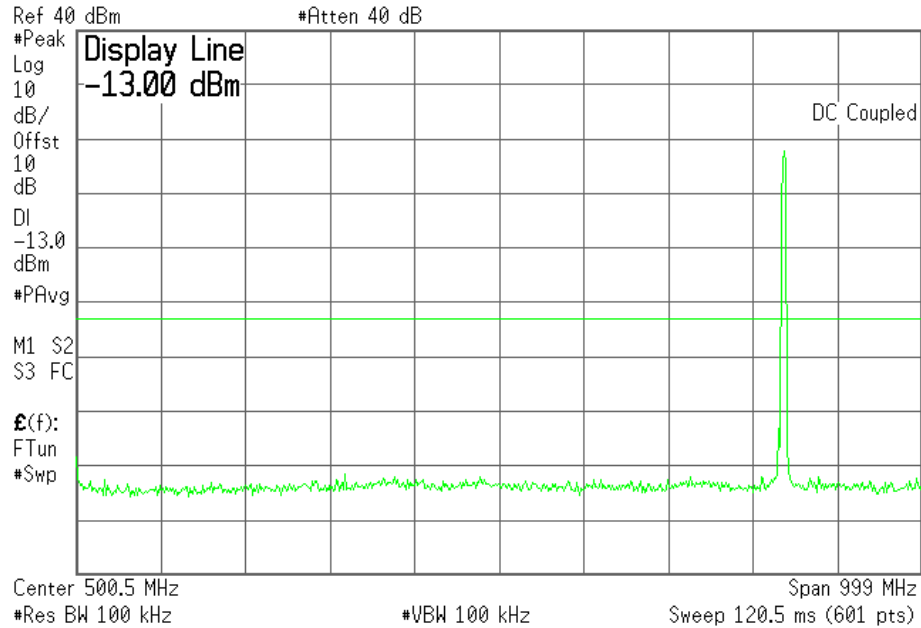

Plot 6.4.41) Out of Band Emissions at Antenna Terminals

WCDMA, Middle channel, 836.4 MHz, TX signal +/- 20 MHz

Agilent 15:07:47 Jul 12, 2006 L

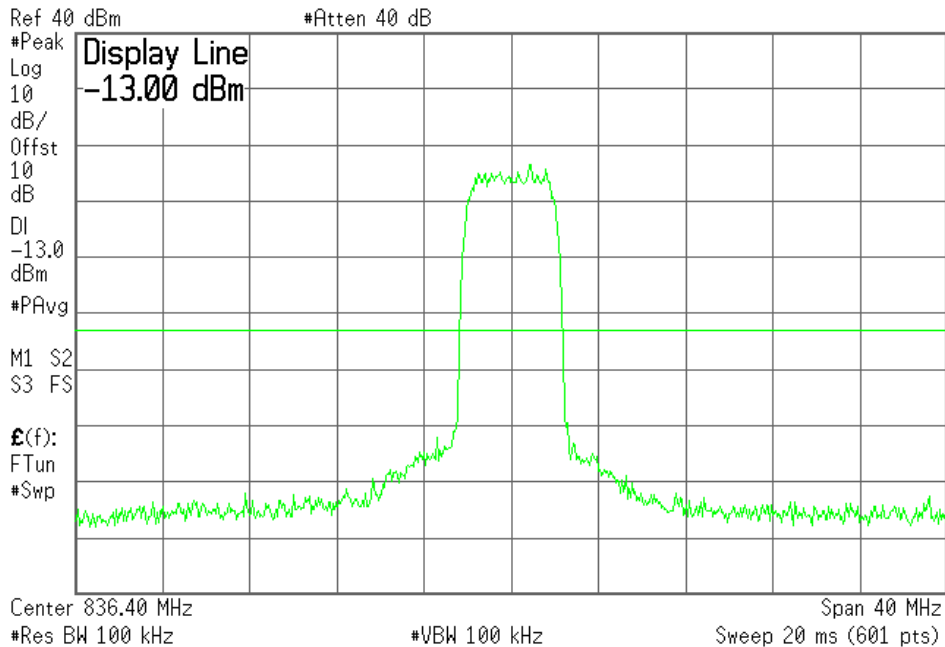

The strong emission shown in each case is the carrier signal.

SIERRA WIRELESS, INC.

Plot 6.4.42) Out of Band Emissions at Antenna Terminals

WCDMA, Middle channel, 836.4 MHz, 1 GHz to 20 GHz

Agilent 15:39:22 Jul 12, 2006

L

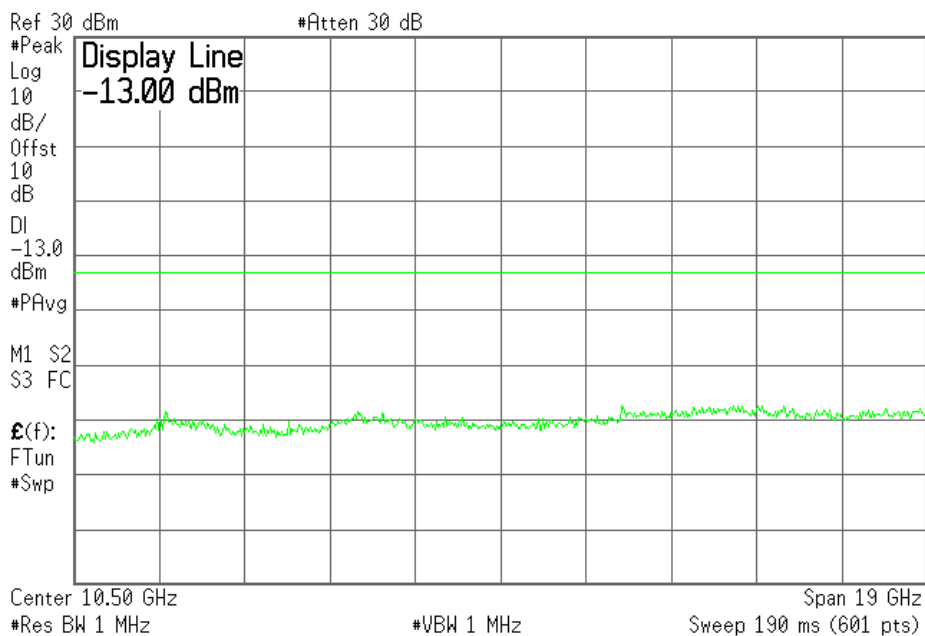

Cellular Harmonics for Ch. 190 (836.6 MHz)	Level (dBm)
Second	--
Third	--
All others	< -30dBm up to 20GHz

Plot 6.4.43) Out of Band Emissions at Antenna Terminals

WCDMA, High Channel, 846.6 MHz, 1 MHz to 1 GHz

Agilent 14:03:31 Jul 12, 2006

L

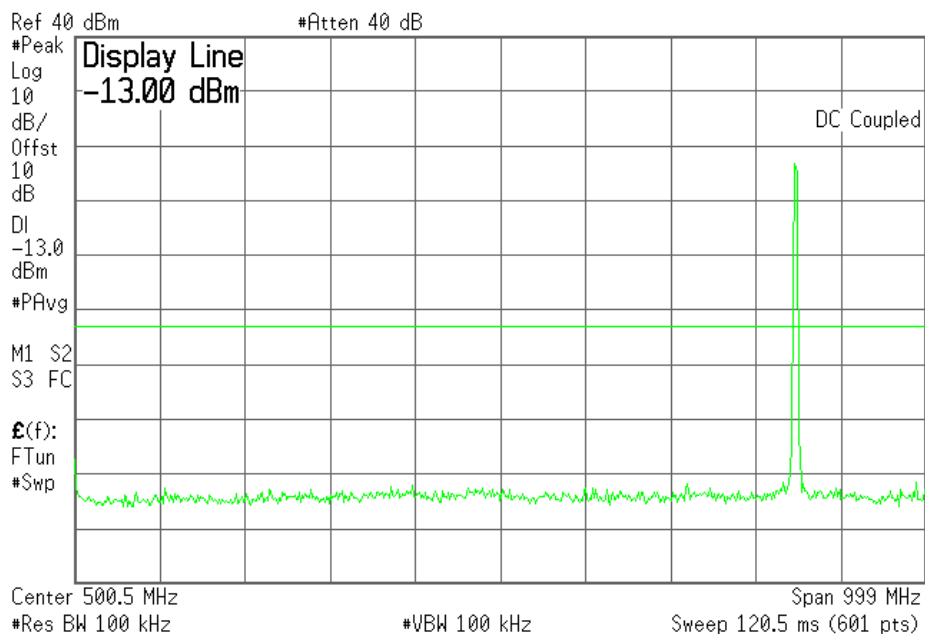

Plot 6.4.44) Out of Band Emissions at Antenna Terminals

WCDMA, High Channel, 846.6 MHz, TX signal +/- 20 MHz

Agilent 15:10:48 Jul 12, 2006

L

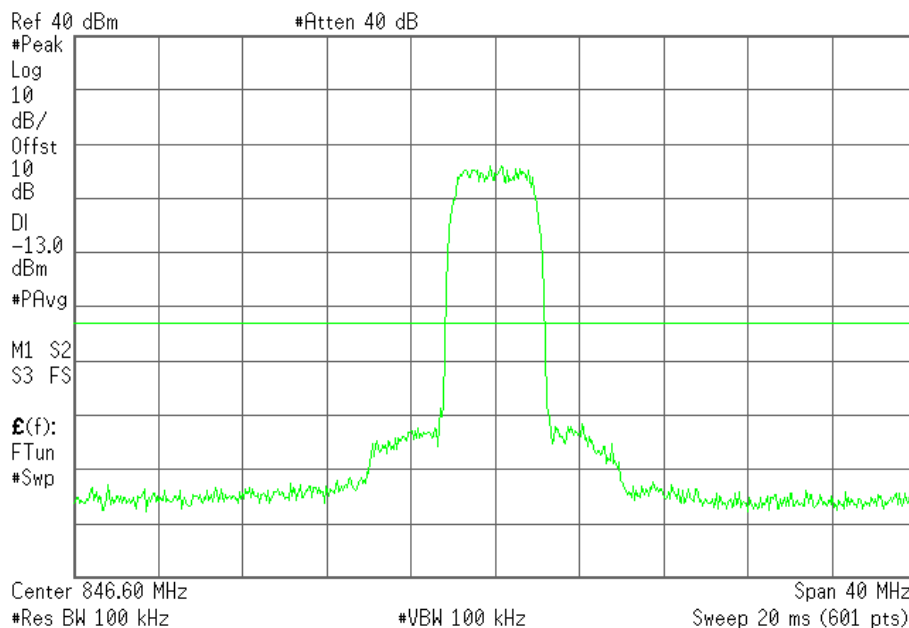

The strong emission shown in each case is the carrier signal.

SIERRA WIRELESS, INC.

Plot 6.4.45) Out of Band Emissions at Antenna Terminals

WCDMA, High Channel, 846.6 MHz, 1 GHz to 20 GHz

Agilent 15:40:08 Jul 12, 2006

L

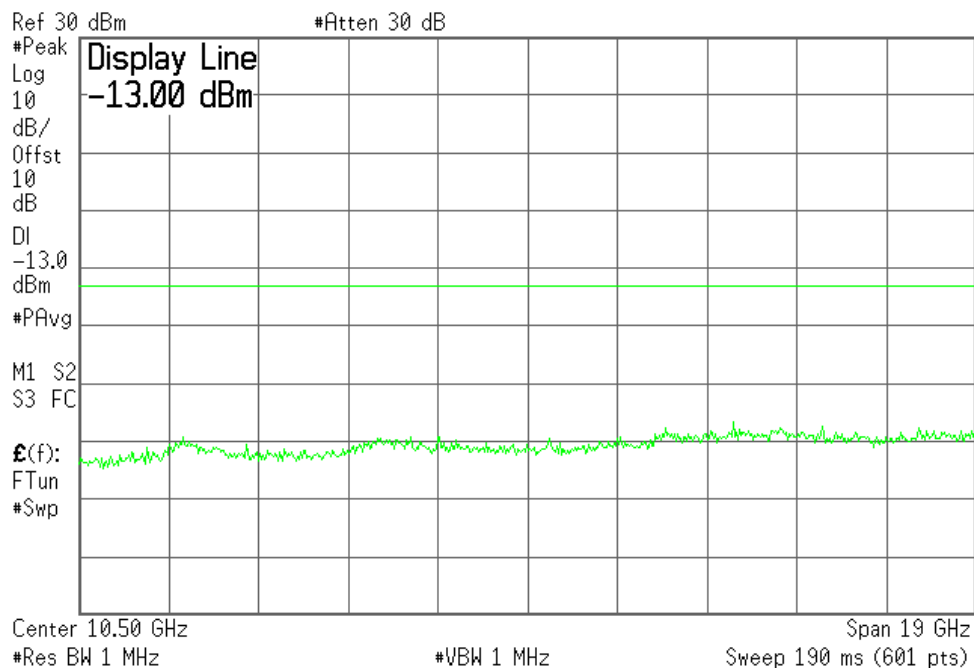

Cellular Harmonics for Ch. 251 (848.8 MHz)	Level (dBm)
Second	--
Third	--
All others	< -30dBm up to 20GHz

Plot 6.4.46) Out of Band Emissions at Antenna Terminals

WCDMA, Low channel, 1852.4 MHz, 1 MHz to 1 GHz

Agilent 14:43:02 Jul 12, 2006 L

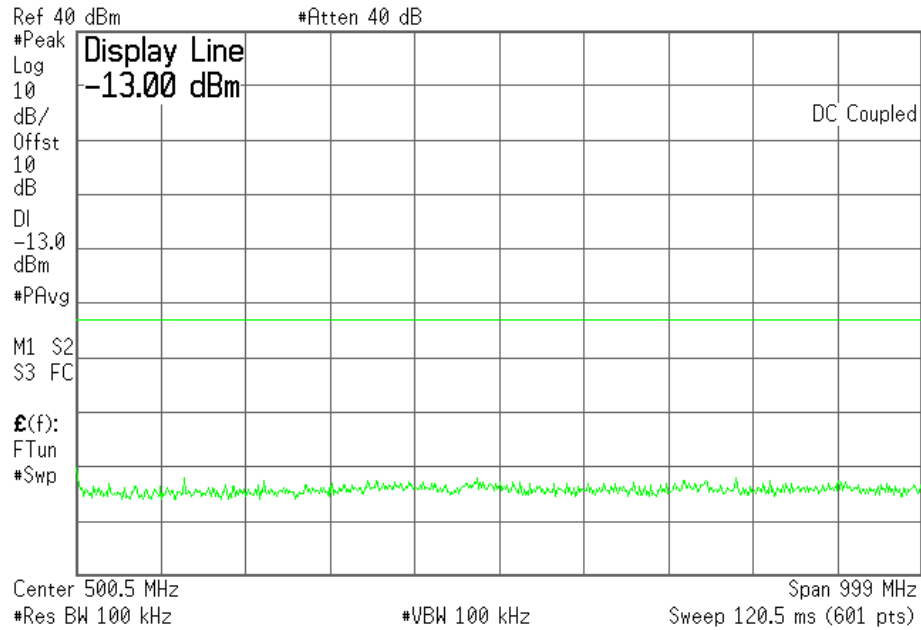

Plot 6.4.47) Out of Band Emissions at Antenna Terminals

WCDMA, Low channel, 1852.4 MHz, TX signal +/- 20 MHz

Agilent 15:31:22 Jul 12, 2006 L

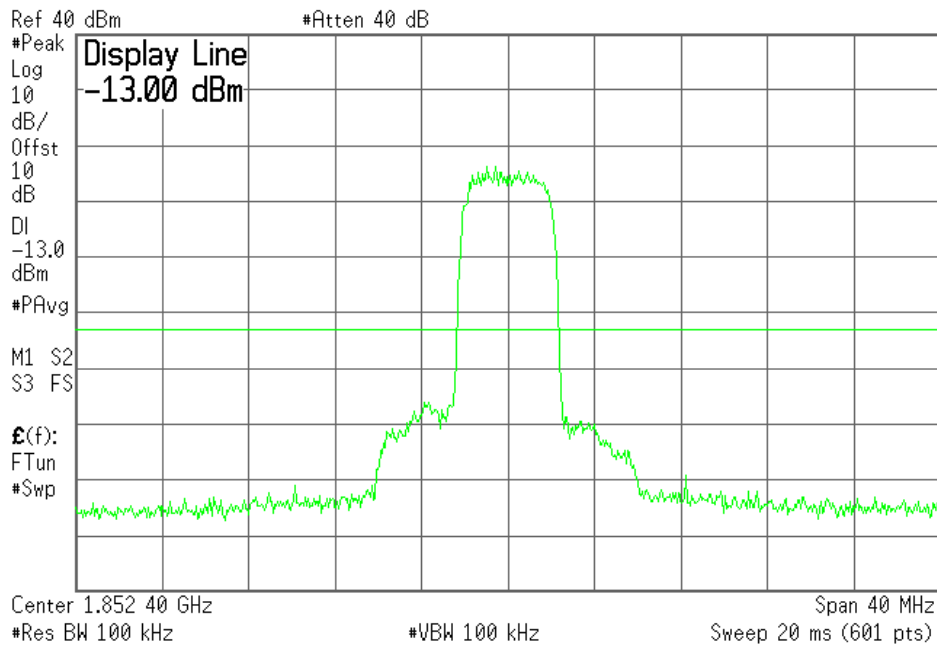

SIERRA WIRELESS, INC.

Plot 6.4.48) Out of Band Emissions at Antenna Terminals

WCDMA, Low channel, 1852.4 MHz, 1 GHz to 20 GHz

Agilent 16:00:41 Jul 12, 2006

L

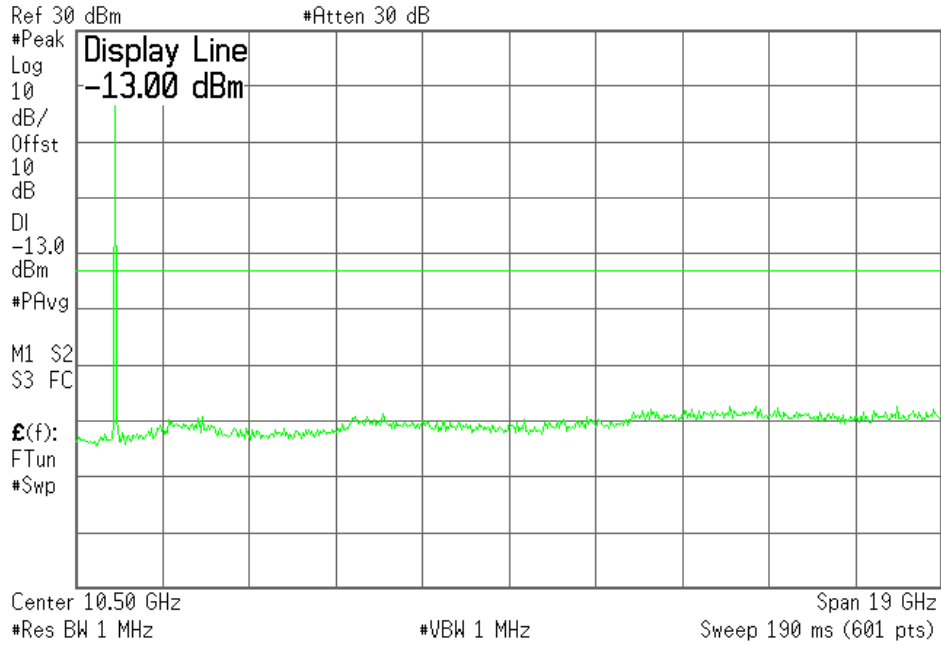

The strong emission shown is the carrier signal.

Plot 6.4.49) Out of Band Emissions at Antenna Terminals

WCDMA, Middle channel, 1880 MHz, 1 MHz to 1 GHz

Agilent 14:43:47 Jul 12, 2006

L

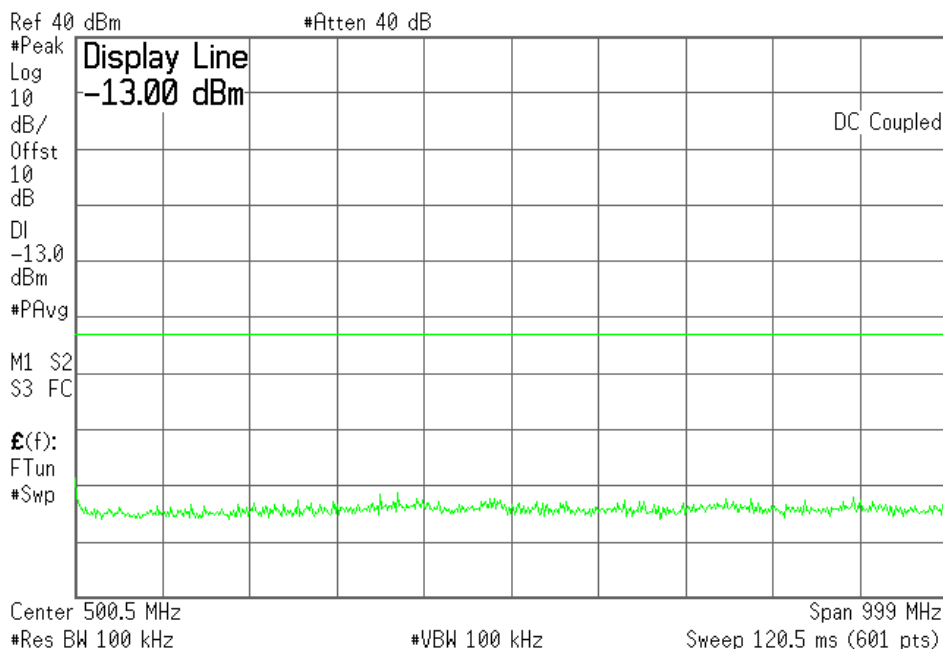

Plot 6.4.50) Out of Band Emissions at Antenna Terminals

WCDMA, Middle channel, 1880 MHz, TX signal +/- 20 MHz

Agilent 15:32:31 Jul 12, 2006

L

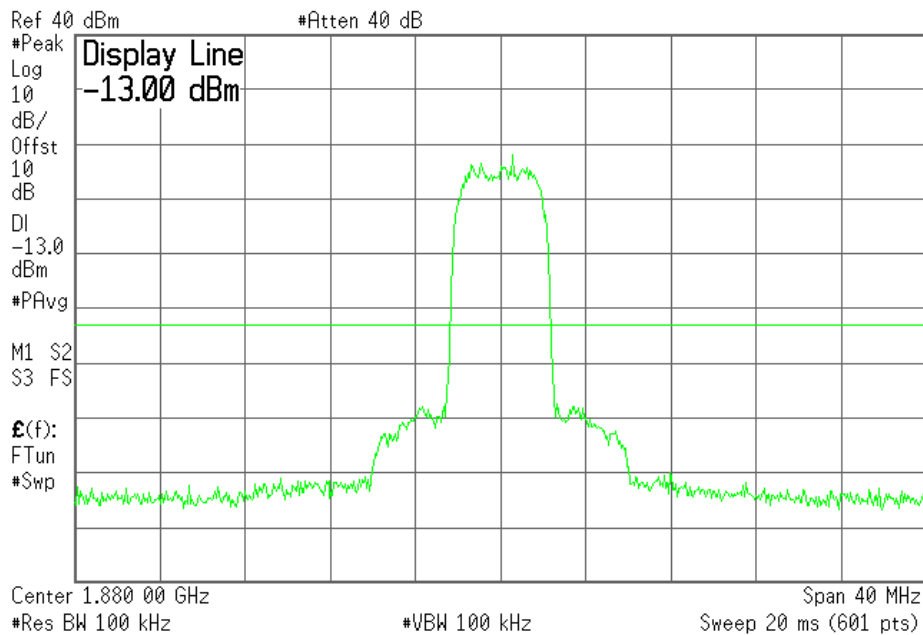

SIERRA WIRELESS, INC.

Plot 6.4.51) Out of Band Emissions at Antenna Terminals

WCDMA, Middle channel, 1880 MHz, 1 GHz to 20 GHz

Agilent 16:03:50 Jul 12, 2006

L

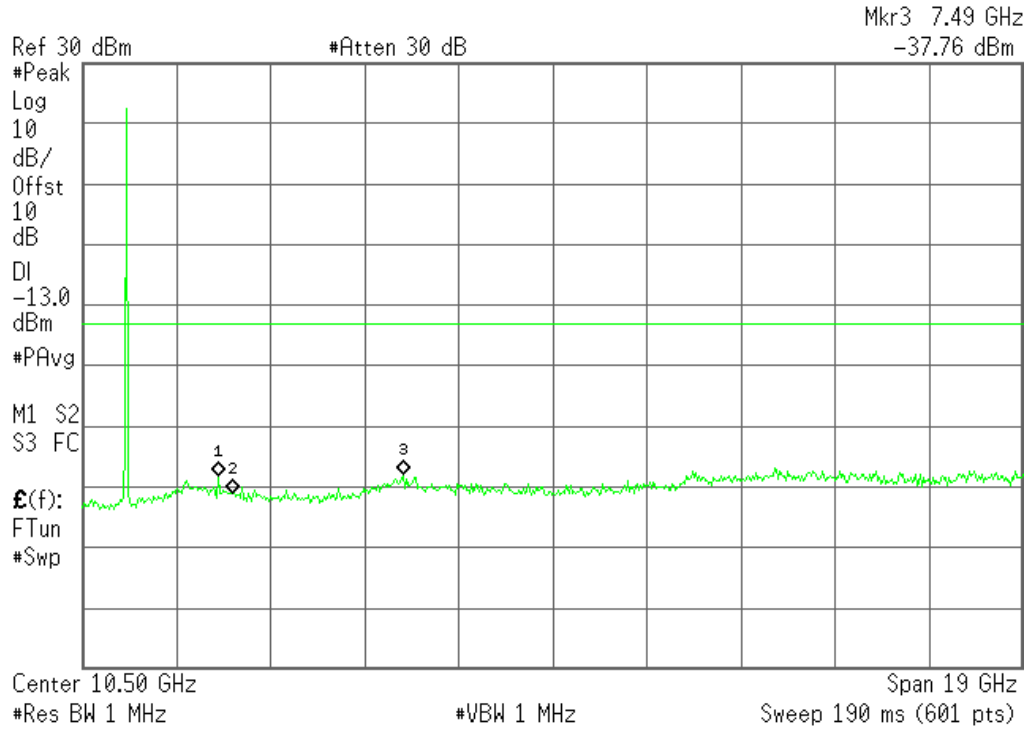

The strong emission shown is the carrier signal.

Plot 6.4.52) Out of Band Emissions at Antenna Terminals

WCDMA, High channel, 1907.6 MHz, 1 MHz to 1 GHz

Agilent 14:44:35 Jul 12, 2006 L

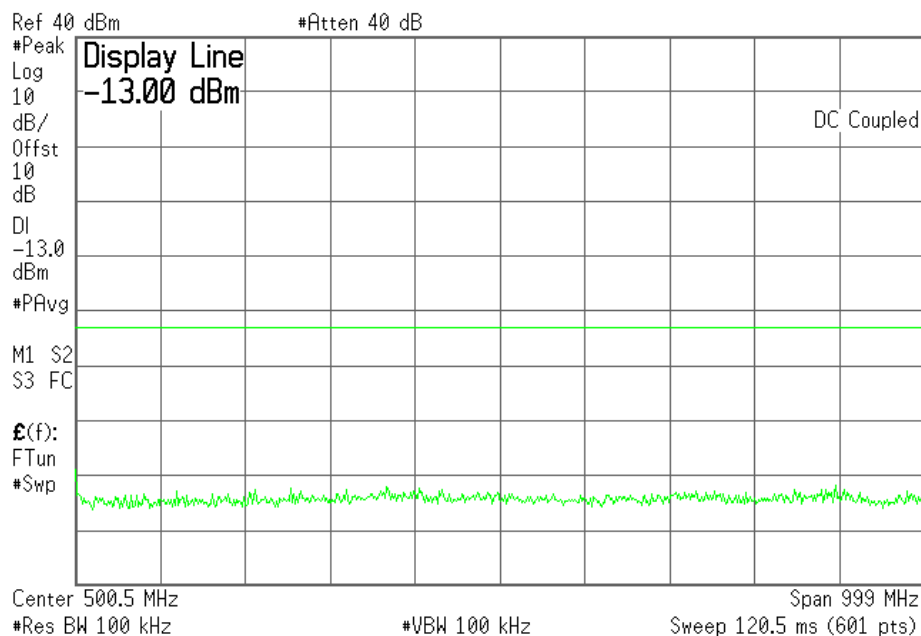

Plot 6.4.53) Out of Band Emissions at Antenna Terminals

WCDMA, High channel, 1907.6 MHz, TX signal +/- 20 MHz

Agilent 15:33:19 Jul 12, 2006 L

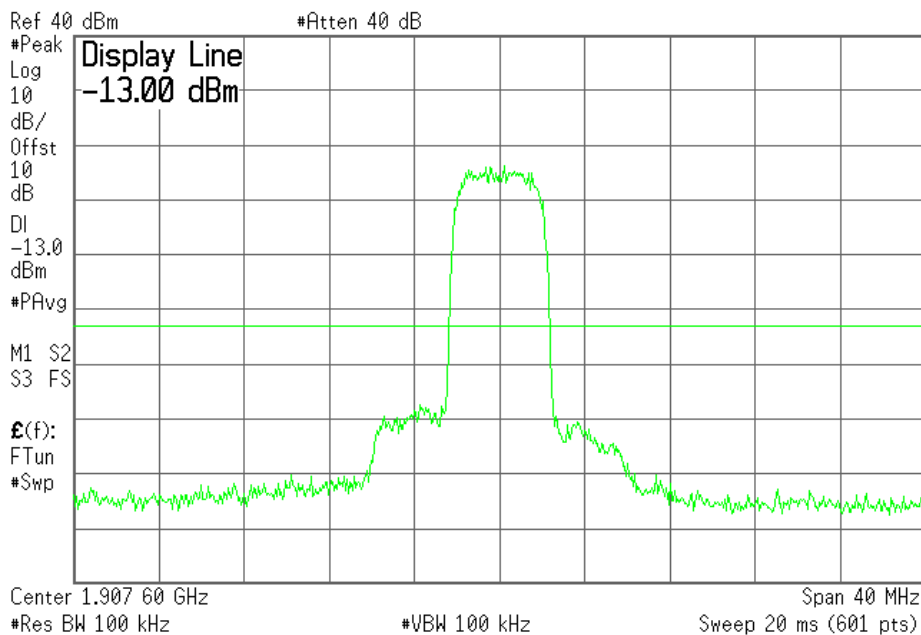

Plot 6.4.54) Out of Band Emissions at Antenna Terminals

WCDMA, High channel, 1907.6 MHz, 1 GHz to 20 GHz

Agilent 16:08:23 Jul 12, 2006

L

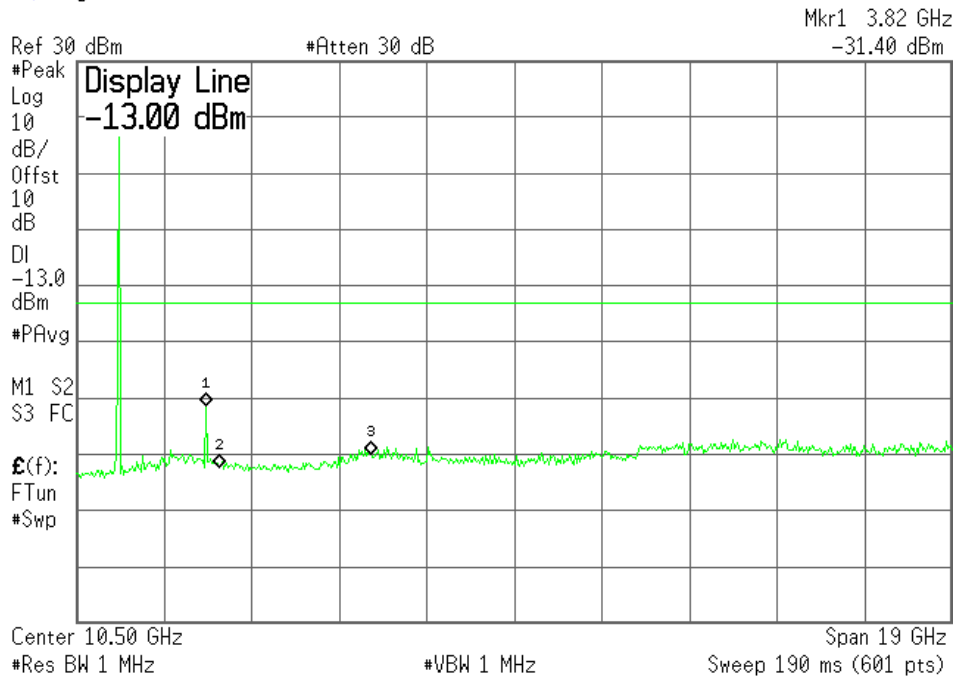

The strong emission shown is the carrier signal.

7 Block Edge Compliance

FCC part 22H/24E

7.1 Test Procedure

The transmitter output was connected to a Rohde & Schwarz CMU200 Test Set and configured to operate at maximum power. The block edge emissions were measured at the required operating frequencies in each band on the Spectrum Analyzer.

Test Setup

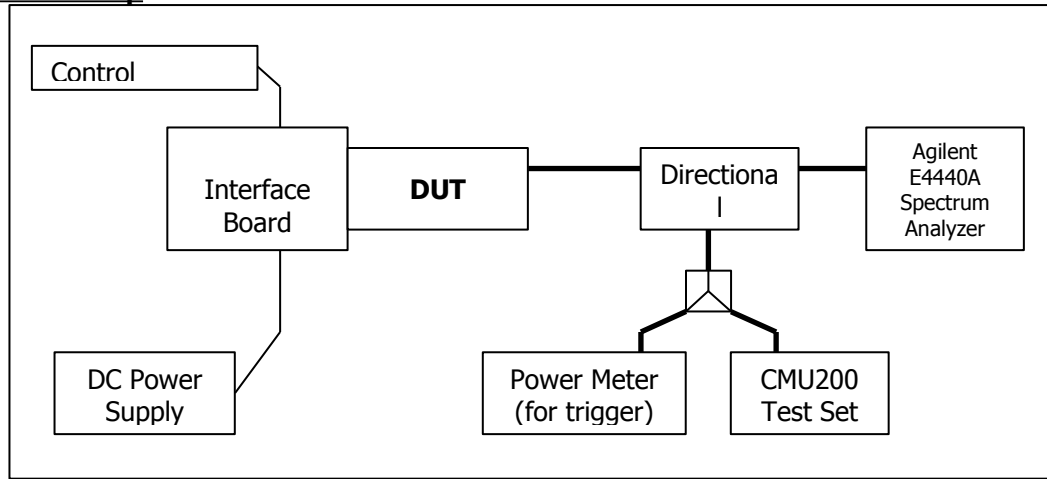

7.2 Test Equipment

Instrument List

EQUIPMENT	MANUFACTURER	MODEL NO.	SERIAL NO.	CAL. DATE
Control Computer	TC	Generic PC	100488	N/A
Wireless Test Set	Rohde & Schwarz	CMU200	836766/030	N/A
Spectrum Analyzer	Agilent	PSA E4440A	US41421268	Sept. 29, 2004
DC Power Supply	HP	6632A	3530A	N/A
Interface Board	Shop built	Minnow	N/A	N/A
Directional Coupler	Mini-Circuits	ZA3PD-2	N/A	N/A

7.3 Test Results

Block Test	Frequency Boundaries (MHz)	Channels Tested	Corresponding Plots	Result
1	GMSK: Below 824 MHz, above 849 MHz	128, 251	7.4.1, 7.4.2	Complies
2	8PSK: Below 824 MHz, above 849 MHz	128, 251	7.4.3, 7.4.4	Complies
3	GMSK: Below 1850MHz, above 1910MHz	512, 810	7.4.5, 7.4.6	Complies
4	8PSK: Below 1850MHz, above 1910MHz	512, 810	7.4.7, 7.4.8	Complies
Block Test	Frequency Boundaries (MHz)	Channels Tested	Corresponding Plots	Result
1	WCDMA: Below 824MHz, above 849MHz	4132, 4233	7.4.9, 7.4.10	Complies
2	WCDMA: Below 1850MHz, above 1910MHz	9262, 9538	7.4.11, 7.4.12	Complies

7.4 Test Plots

Plot 7.4.1) GSMK; Cellular low channel, below 824 MHz

Agilent 12:11:47 Jul 11, 2006 L

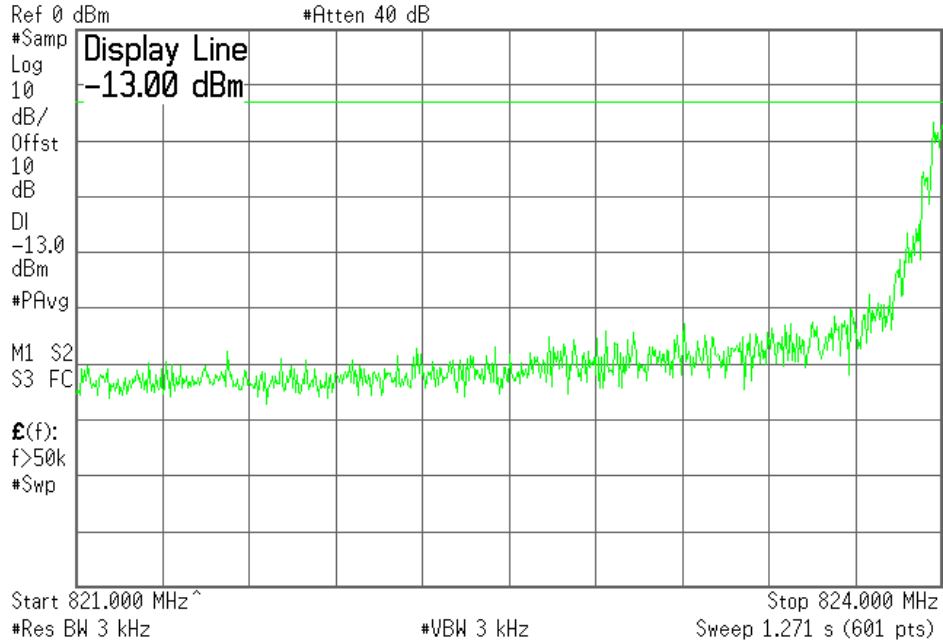

Plot 7.4.2) GSMK; Cellular high channel, above 849 MHz

Agilent 12:13:57 Jul 11, 2006 L

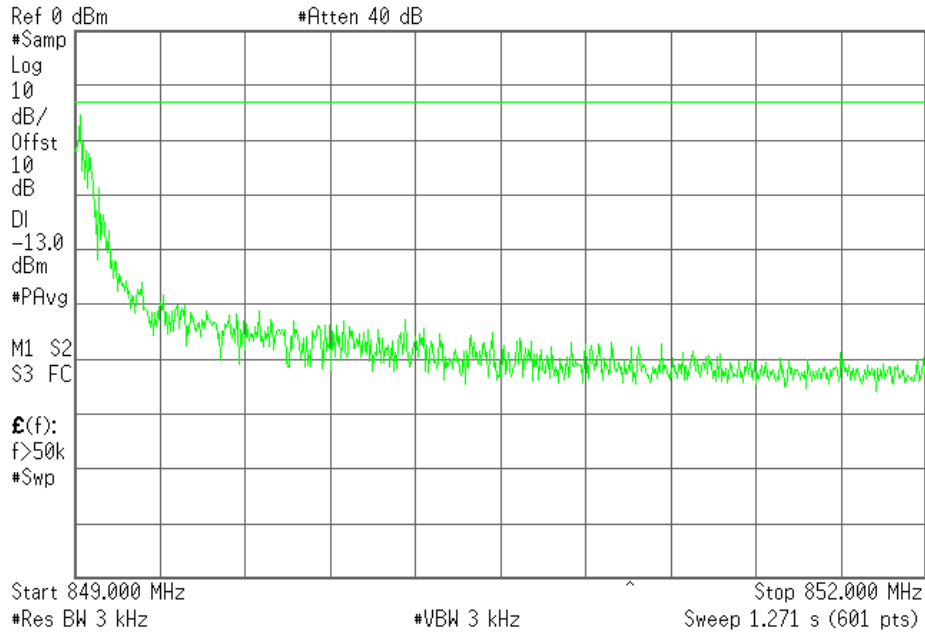

Plot 7.4.3) 8-PSK; Cellular low channel, below 824 MHz

* Agilent 15:41:59 Jul 11, 2006 L

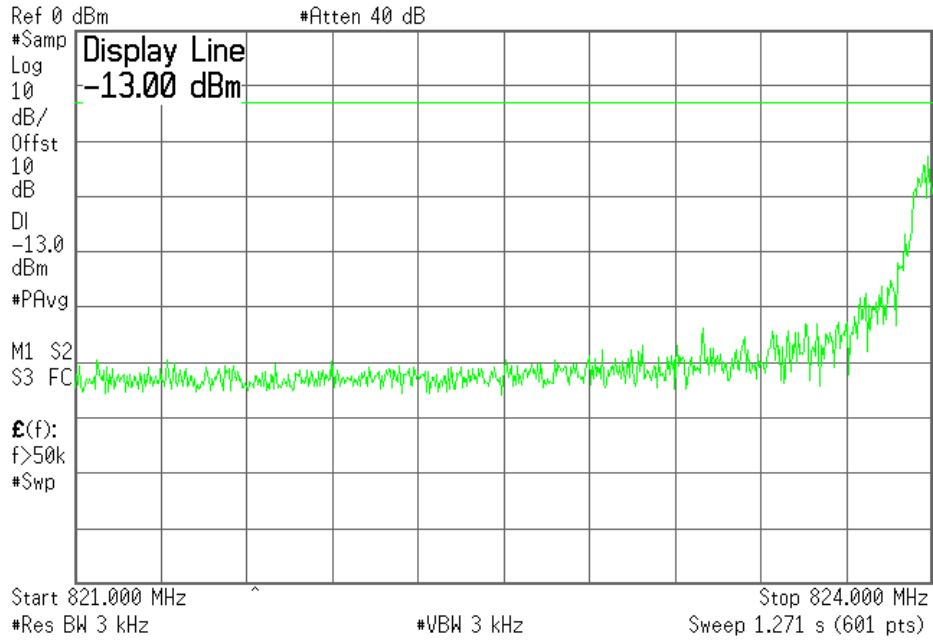

Plot 7.4.4) 8-PSK; Cellular high channel, above 849 MHz

* Agilent 12:17:26 Jul 11, 2006 L

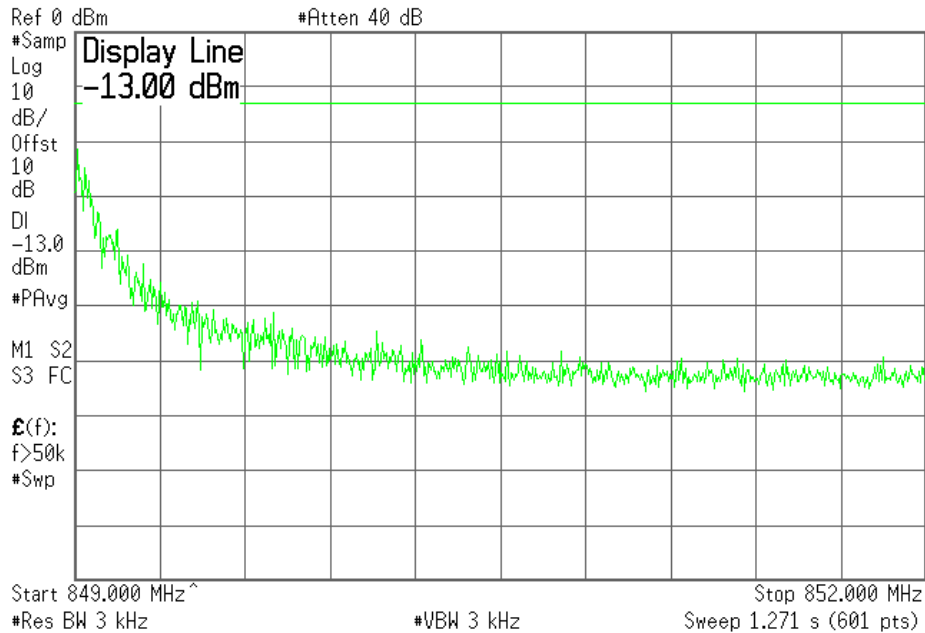

Plot 7.4.5) GMSK; PCS low channel, below 1850 MHz

Agilent 16:07:09 Jul 11, 2006 L

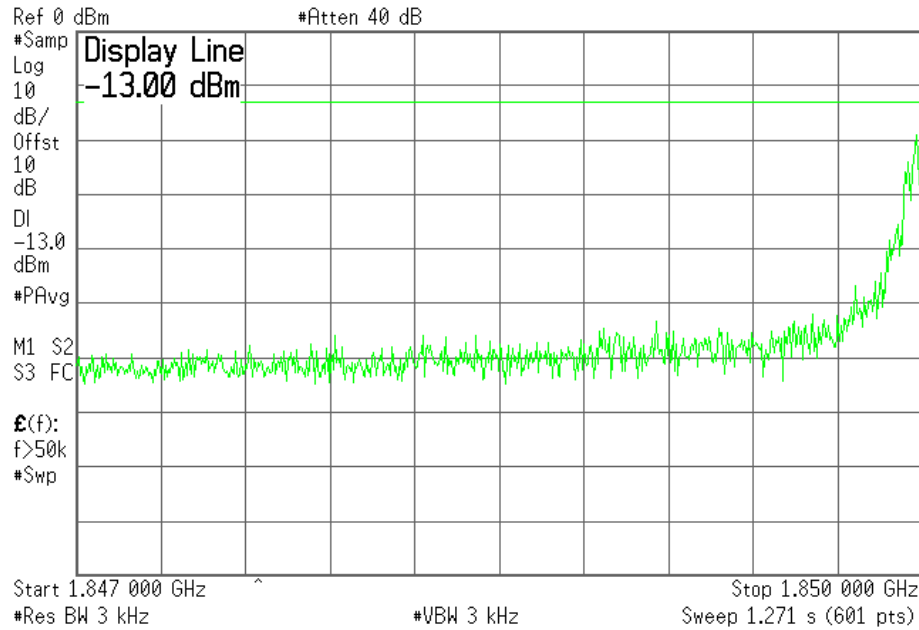

Plot 7.4.6) GMSK; PCS high channel, above 1910 MHz

Agilent 16:23:33 Jul 11, 2006 L

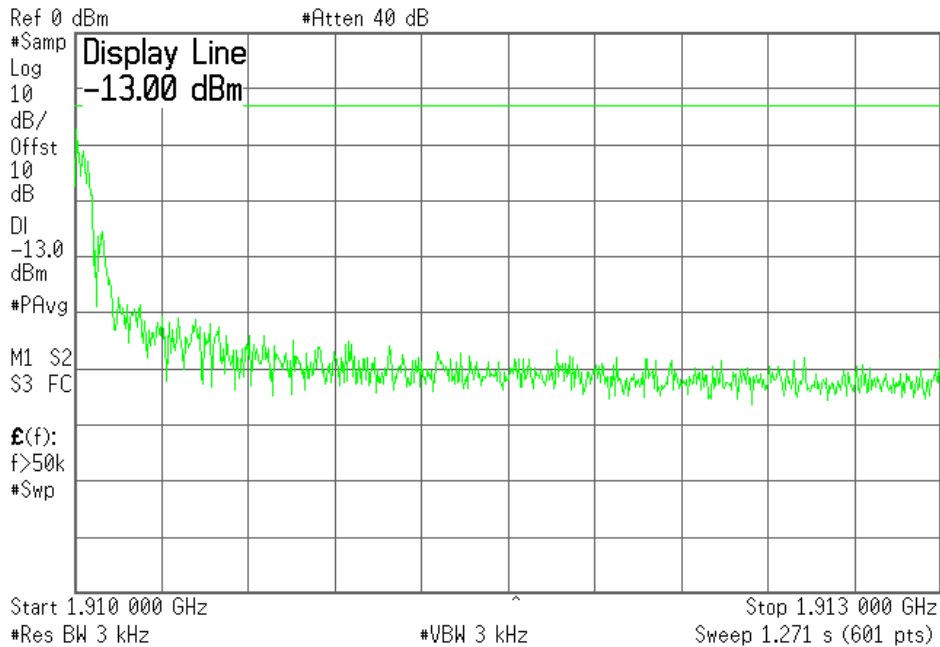

Plot 7.4.7) 8-PSK; PCS low channel, below 1850 MHz

Agilent 16:20:21 Jul 11, 2006 L

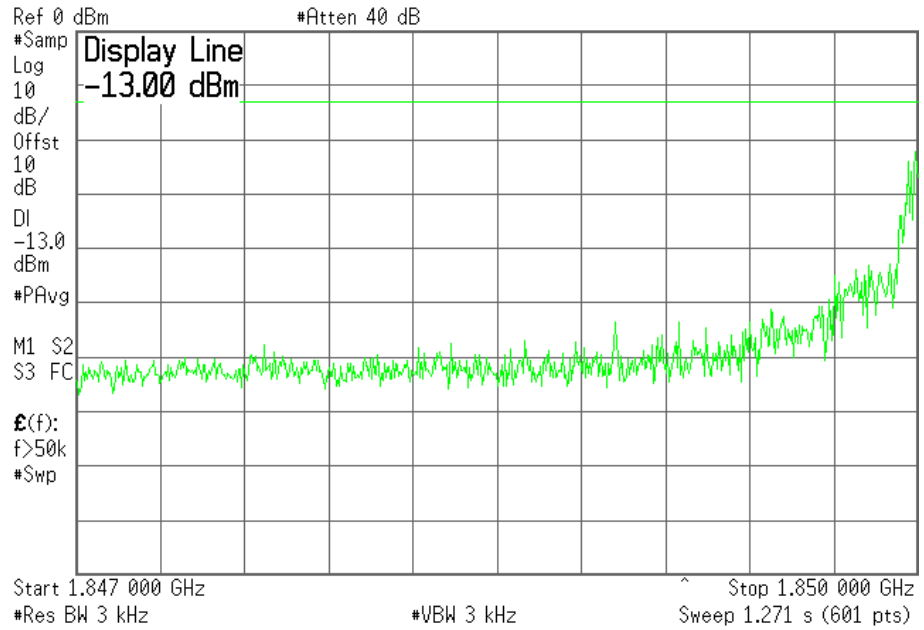

Plot 7.4.8) 8-PSK; PCS high channel, above 1910 MHz

Agilent 16:21:49 Jul 11, 2006 L

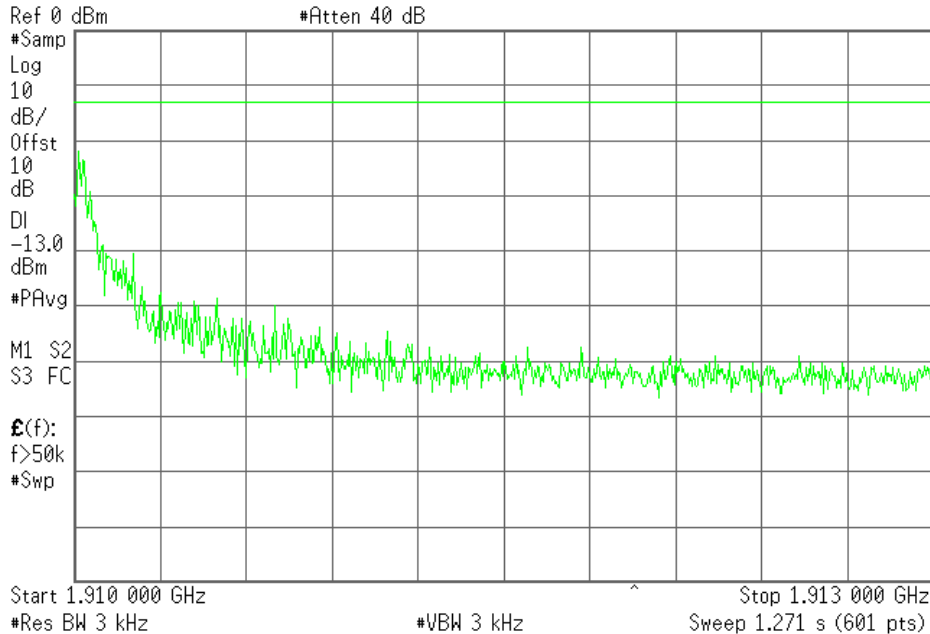

Plot 7.4.9) WCDMA; Cellular low channel, below 824 MHz

* Agilent 16:53:04 Jul 12, 2006

L

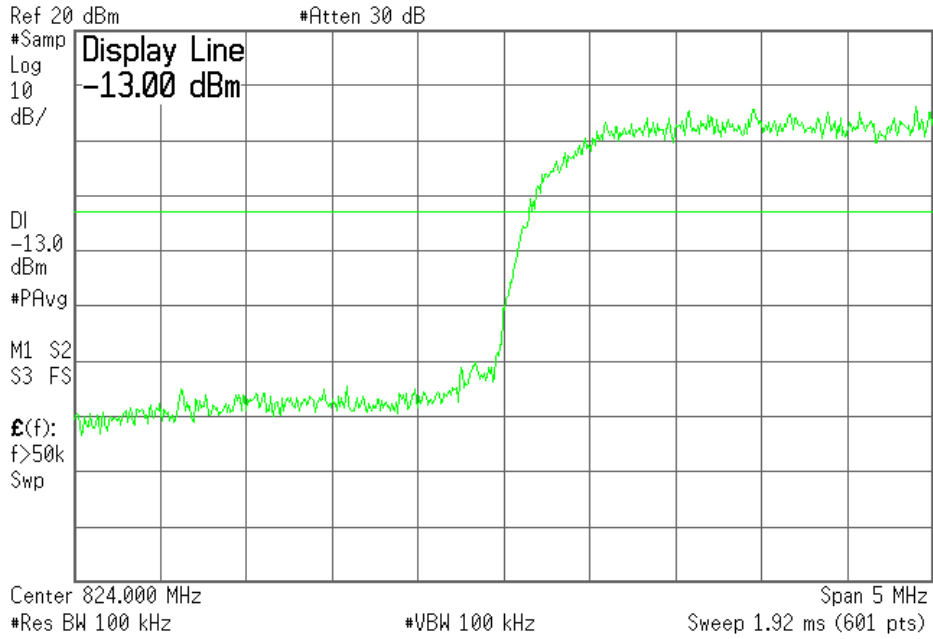

Plot 7.4.10) WCDMA; Cellular high channel, above 849 MHz

* Agilent 16:51:55 Jul 12, 2006

L

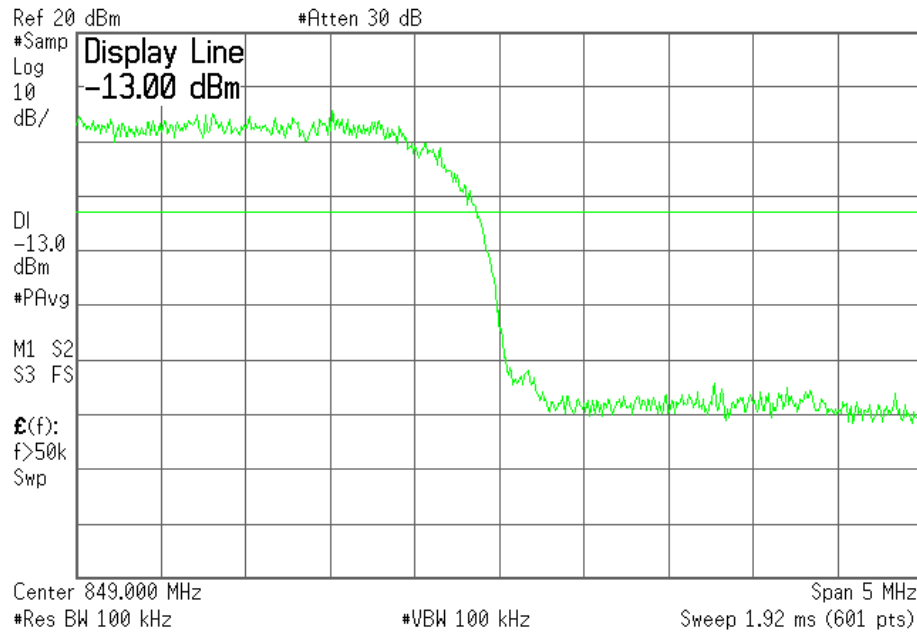

Plot 7.4.11) WCDMA; PCS low channel, below 1850 MHz

* Agilent 16:55:28 Jul 12, 2006 L

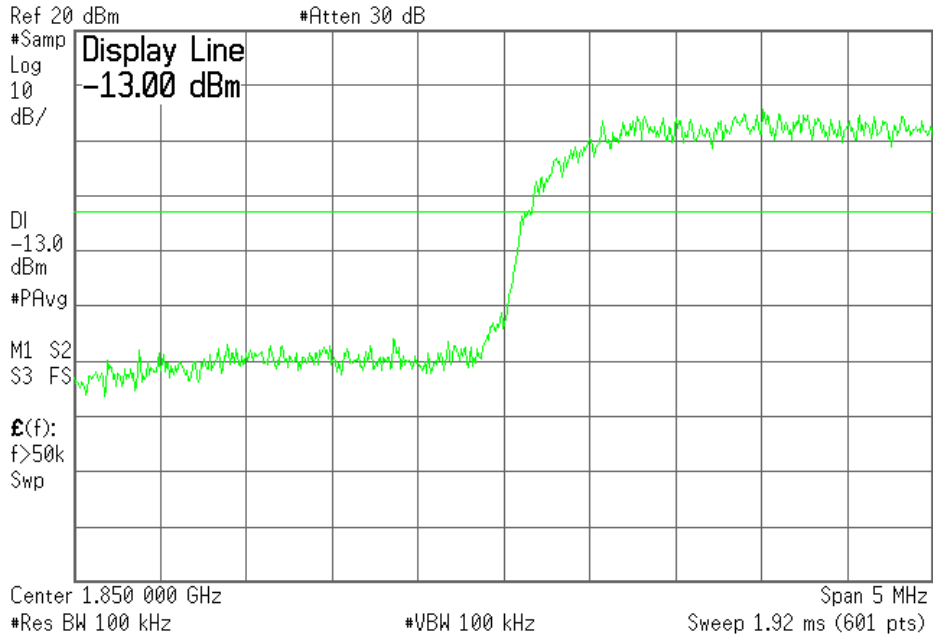

Plot 7.4.12) WCDMA; PCS high channel, above 1910 MHz

* Agilent 16:56:42 Jul 12, 2006 L

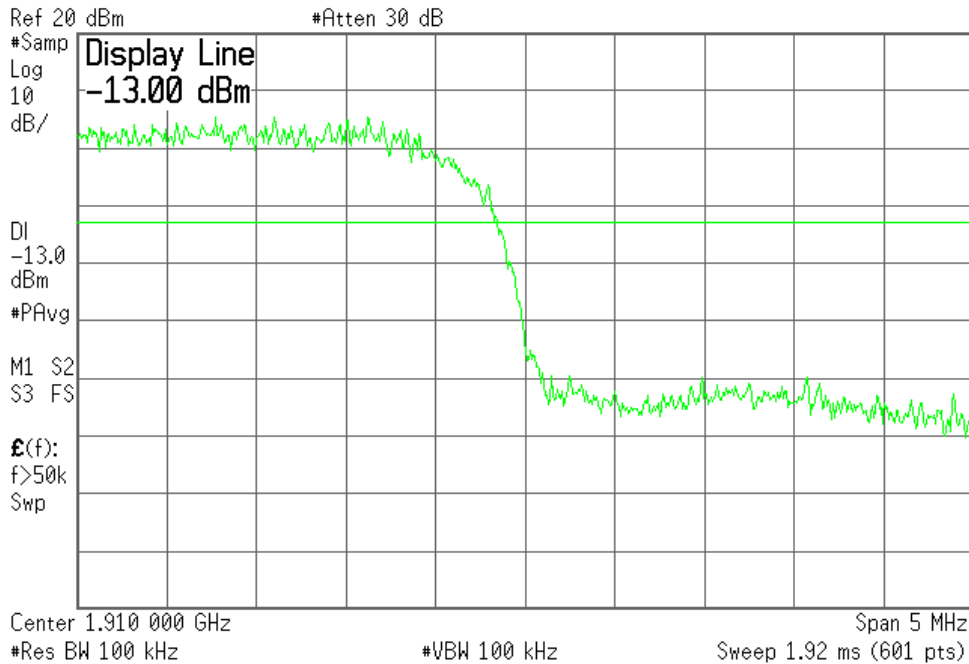

8 Frequency Stability Versus Temperature

FCC 2.1055

8.1 Summary of Results

The MC8775 Frequency Stability versus temperature meets the requirement of being within ± 0.1 ppm of the received base station frequency.

8.2 Test Procedure

The MC8775 was placed inside the temperature chamber. The transmitting frequency error is measured at 25 degrees C, and then the temperature is set to +60 degrees C and allowed to stabilize. After sufficient soak time, the transmitting frequency error is measured. The temperature is decreased by 10 degrees, allowed to stabilize and soak, then the measurement is repeated. This is repeated until -20 degrees C is completed. The process is then repeated back up to +60 degrees C. Frequency metering included internal averaging of the CMU200 to stabilize the reading. Reference power supply voltage for these tests is 3.3 volts.

Test Setup

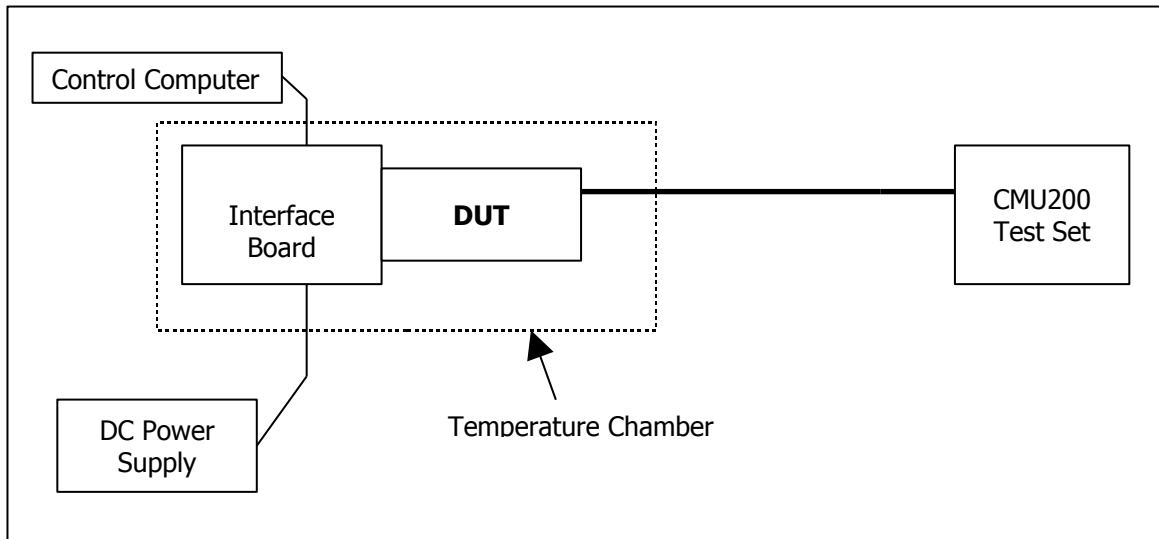

8.3 Test Equipment

EQUIPMENT	MANUFACTURER	MODEL NO.	SERIAL NO.	CAL. DATE
Control Computer	TC	Generic PC	100488	N/A
Wireless Test Set	Rohde & Schwarz	CMU200	836766/030	N/A
Spectrum Analyzer	Agilent	PSA E4440A	US41421268	Sept. 29, 2004
DC Power Supply	HP	6632A	3530A	N/A
Interface Board	Shop built	Minnow	N/A	N/A
Directional Coupler	Mini-Circuits	ZA3PD-2	N/A	N/A

SIERRA WIRELESS, INC.

8.4 Test Results

Low to High Temperature Frequency Error

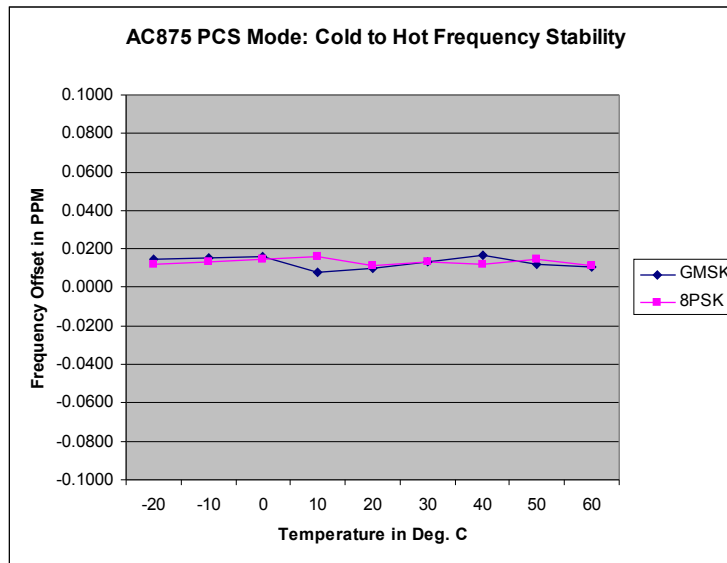
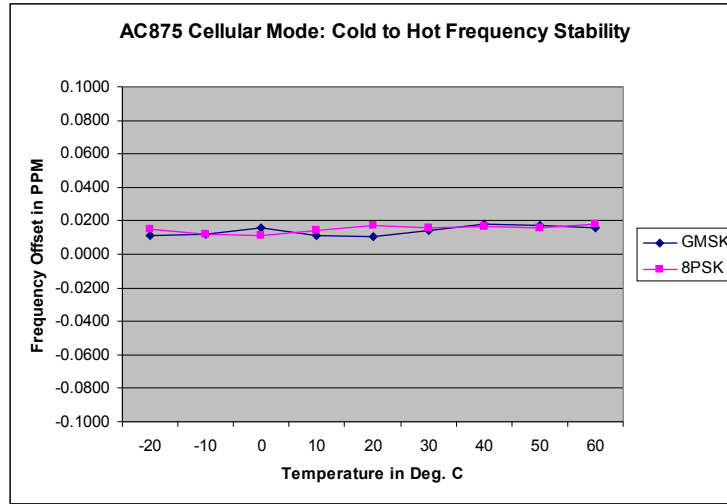

Low to High Temperature Tabular Readings

Temp.(C)	Cellular Mode: 824MHz to 848MHz				PCS Mode: 1850MHz to 1909MHz			
	GMSK Mode		8-PSK Mode		GMSK Mode		8-PSK Mode	
	Offset (Hz)	Offset (ppm)	Offset (Hz)	Offset (ppm)	Offset (Hz)	Offset (ppm)	Offset (Hz)	Offset (ppm)
-20	-21	0.0112	-28	0.0149	-27	0.0144	-22	0.0117
-10	-22	0.0117	-22	0.0117	-29	0.0154	-25	0.0133
0	-29	0.0154	-21	0.0112	-30	0.0160	-27	0.0144
10	-21	0.0112	-27	0.0144	-15	0.0080	-30	0.0160
20	-20	0.0106	-32	0.0170	-19	0.0101	-21	0.0112
30	-27	0.0144	-30	0.0160	-25	0.0133	-25	0.0133
40	-34	0.0181	-31	0.0165	-32	0.0170	-23	0.0122
50	-32	0.0170	-30	0.0160	-22	0.0117	-27	0.0144
60	-30	0.0160	-34	0.0181	-20	0.0106	-21	0.0112

SIERRA WIRELESS, INC.

Low to High Temperature Frequency Error

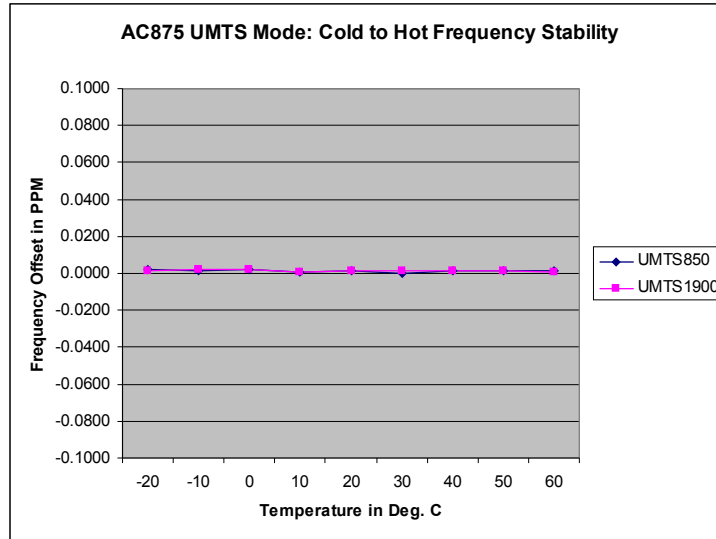

Low to High Temperature Tabular Readings

Temp.(C)	UMTS Mode: 1850MHz to 1909MHz		UMTS Mode: 1850MHz to 1909MHz	
	Offset (Hz)	Offset (Hz)	Offset (Hz)	Offset (ppm)
60	4	0.0021	2	0.0011
50	3	0.0016	4	0.0021
40	4	0.0021	4	0.0021
30	-1	0.0005	-1	0.0005
20	3	0.0016	3	0.0016
10	0	0.0000	3	0.0016
0	-2	0.0011	2	0.0011
-10	-3	0.0016	3	0.0016
-20	3	0.0016	1	0.0005

SIERRA WIRELESS, INC.

High to Low Temperature Frequency Error

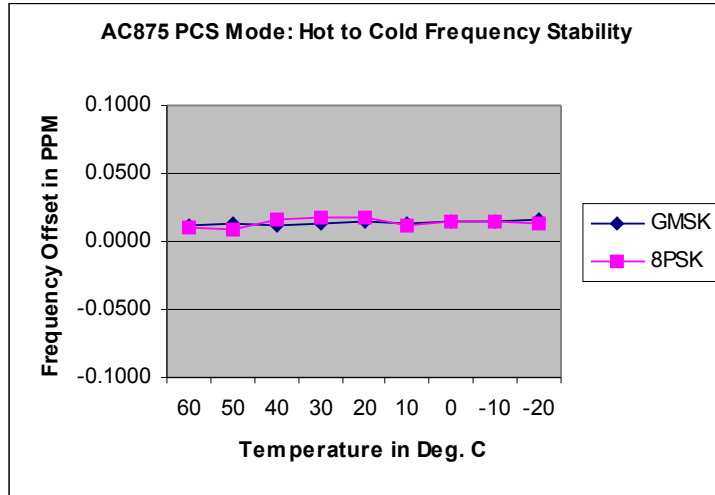
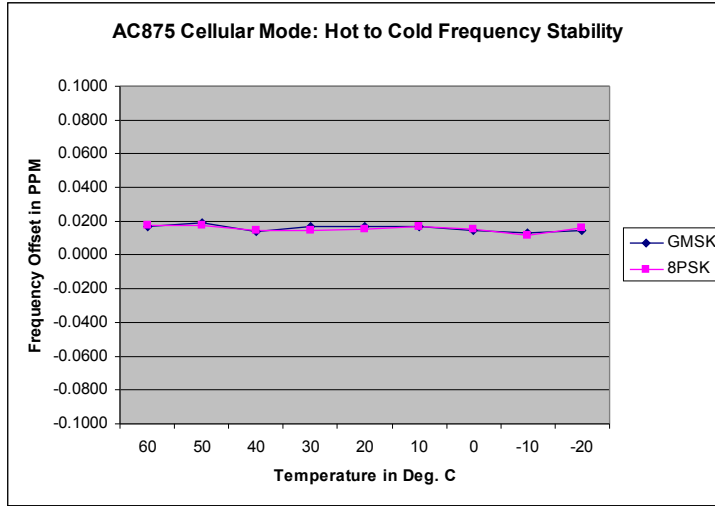

High to Low Temperature Tabular Readings

Temp.(C)	Cellular Mode: 824MHz to 848MHz				PCS Mode: 1850MHz to 1909MHz			
	GMSK Mode		8-PSK Mode		GMSK Mode		8-PSK Mode	
	Offset (Hz)	Offset (ppm)	Offset (Hz)	Offset (ppm)	Offset (Hz)	Offset (ppm)	Offset (Hz)	Offset (ppm)
60	-32	0.017	-33	0.017	-23	0.012	-18	0.0096
50	-36	0.019	-33	0.017	-25	0.013	-17	0.0090
40	-26	0.013	-28	0.014	-22	0.011	-30	0.0160
30	-31	0.016	-27	0.014	-26	0.013	-32	0.0170
20	-32	0.017	-29	0.015	-29	0.015	-33	0.0176
10	-32	0.017	-32	0.017	-26	0.013	-22	0.0117

SIERRA WIRELESS, INC.

FCC Part 22 & 24 Test Report	MC8775	July 13, 2006	Page 67 of 72
------------------------------	--------	---------------	---------------

0	-28	0.0149	-29	0.0154	-27	0.0144	-27	0.0144
-10	-25	0.0133	-22	0.0117	-28	0.0149	-28	0.0149
-20	-27	0.0144	-30	0.0160	-30	0.0160	-26	0.0138

SIERRA WIRELESS, INC.

High to Low Temperature Frequency Error

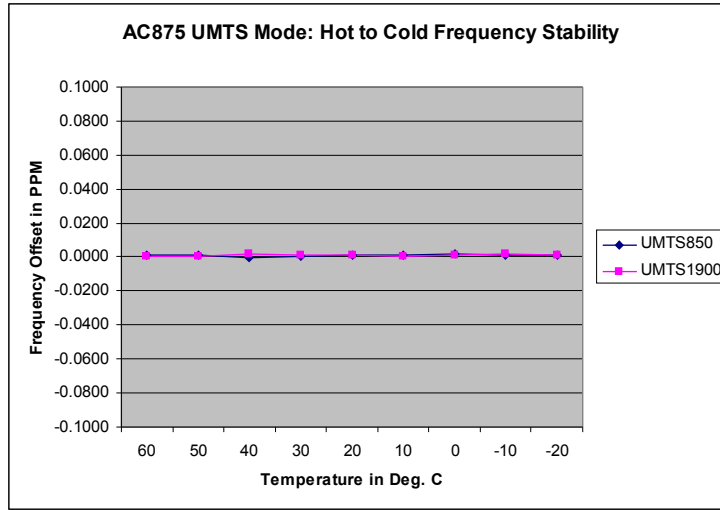

High to Low Temperature Tabular Readings

Temp.(C)	UMTS Mode: 1850MHz to 1909MHz		UMTS Mode: 1850MHz to 1909MHz	
	Offset (Hz)	Offset (Hz)	Offset (ppm)	Offset (ppm)
60	2	0.0011	1	0.0005
50	-2	0.0011	-1	0.0005
40	0	0.0000	3	0.0016
30	-1	0.0005	2	0.0011
20	2	0.0011	2	0.0011
10	-2	0.0011	-1	0.0005
0	-4	0.0021	2	0.0011
-10	2	0.0011	3	0.0016
-20	2	0.0011	2	0.0011

9 Frequency Stability Versus Voltage

FCC 2.1055

9.1 Summary of Results

The unit meets the limit of less than 0.1ppm of frequency offset from center for 85% and 115% of the supply voltage for 3.3 volts.

9.2 Test Procedure

The MC8775 was connected to a DC Power Supply and a UMTS test set (CMU 200) with frequency error measurement capability. The power supply output is adjusted to the test voltage as measured at the input terminals to the module while transmitting. A voltmeter was used to confirm the terminal voltage. The peak frequency error is recorded (worst case).

The test voltages are 2.8 volts to 3.8 volts.

Test Setup

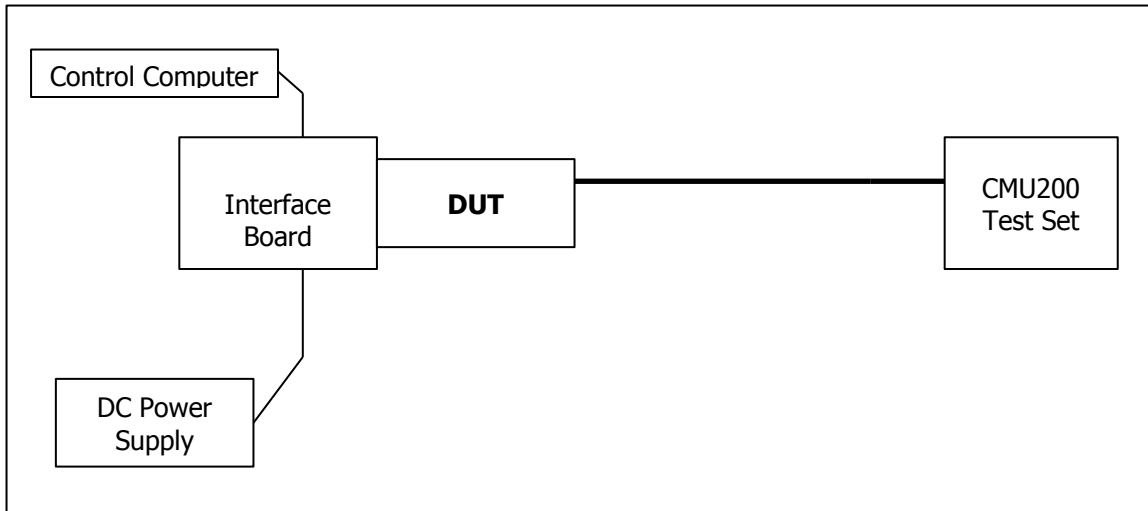

9.3 Test Equipment

EQUIPMENT	MANUFACTURER	MODEL NO.	SERIAL NO.	CAL. DATE
Control Computer	TC	Generic PC	100488	N/A
Wireless Test Set	Rohde & Schwarz	CMU200	836766/030	N/A
Spectrum Analyzer	Agilent	PSA E4440A	US41421268	Sept. 29, 2004
DC Power Supply	HP	6632A	3530A	N/A
Interface Board	Shop built	Minnow	N/A	N/A
Directional Coupler	Mini-Circuits	ZA3PD-2	N/A	N/A

9.4 Test Results

GSM 85% to 115% of 3.3 Volts Frequency Error

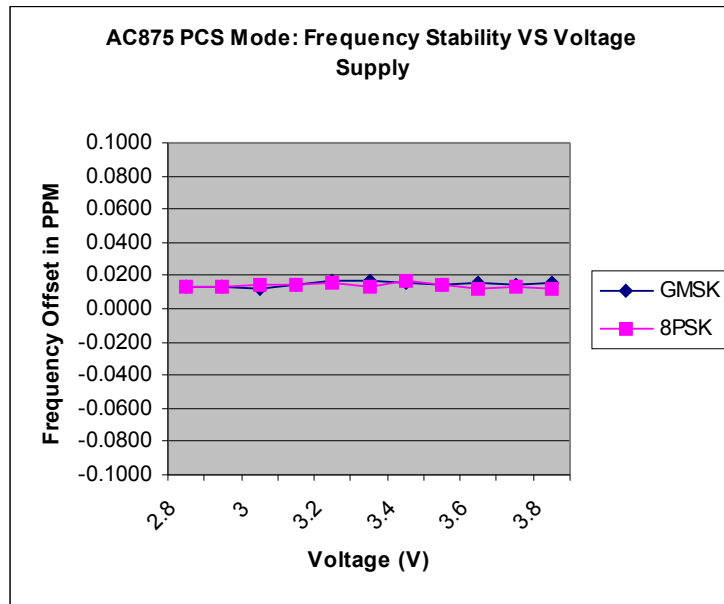
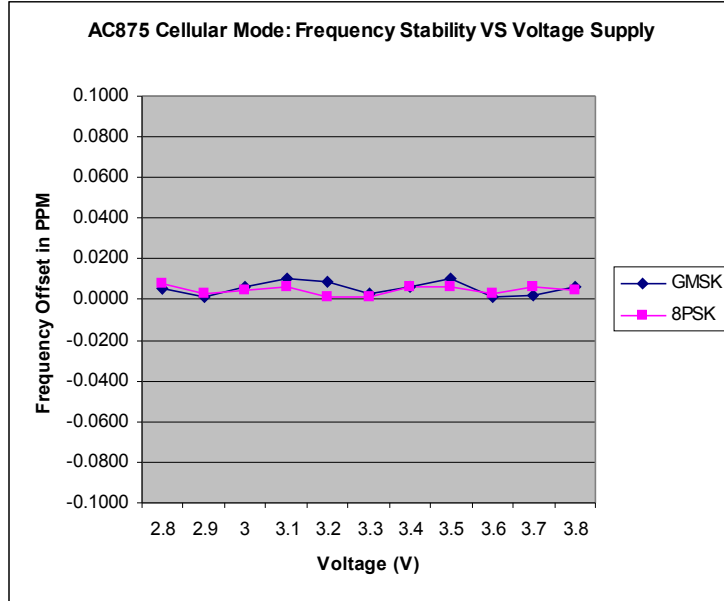

SIERRA WIRELESS, INC.

GSM 85% to 115% of 3.3 Volts Frequency Error, Tabular Data

Supply (V)	Cellular Mode: 824MHz to 848MHz				PCS Mode: 1850MHz to 1909MHz			
	GMSK Mode		8-PSK Mode		GMSK Mode		8-PSK Mode	
	Offset (Hz)	Offset (ppm)	Offset (Hz)	Offset (ppm)	Offset (Hz)	Offset (ppm)	Offset (Hz)	Offset (ppm)
2.8	10	0.0053	15	0.0080	-26	0.0138	-24	0.0128
2.9	2	0.0011	5	0.0027	-25	0.0133	-25	0.0133
3	11	0.0059	8	0.0043	-23	0.0122	-27	0.0144
3.1	20	0.0106	11	0.0059	-28	0.0149	-28	0.0149
3.2	16	0.0085	3	0.0016	-32	0.0170	-30	0.0160
3.3	5	0.0027	-2	0.0011	-32	0.0170	-26	0.0138
3.4	12	0.0064	12	0.0064	-29	0.0154	-32	0.0170
3.5	19	0.0101	11	0.0059	-27	0.0144	-28	0.0149
3.6	-2	0.0011	6	0.0032	-30	0.0160	-23	0.0122
3.7	4	0.0021	12	0.0064	-27	0.0144	-24	0.0128
3.8	12	0.0064	8	0.0043	-29	0.0154	-22	0.0117

SIERRA WIRELESS, INC.

UMTS 85% to 115% of 3.3 Volts Frequency Error, Tabular Data

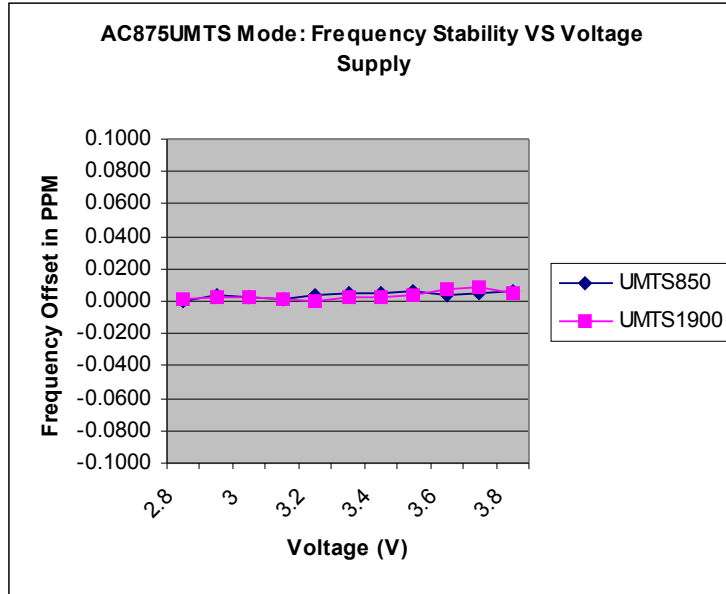

Supply (V)	UMTS Mode			
	850MHz		1900MHz	
	Offset (Hz)	Offset (ppm)	Offset (Hz)	Offset (ppm)
2.8	0	0.0000	1	0.0012
2.9	-3	0.0036	2	0.0024
3	-2	0.0024	-2	0.0024
3.1	-1	0.0012	1	0.0012
3.2	-3	0.0036	0	0.0000
3.3	-4	0.0048	-2	0.0024
3.4	-4	0.0048	-2	0.0024
3.5	-5	0.0060	-3	0.0036
3.6	-3	0.0036	-6	0.0072
3.7	-4	0.0048	-7	0.0084
3.8	-5	0.0060	-4	0.0048