



ELECTROMAGNETIC COMPATIBILITY TEST REPORT

Company : Arima Computer Corporation.
Address : 2nd Fl., No. 327, Sung Lung Road, Taipei, Taiwan
Product name : Tablet PC with built-in 802.11a&b Wireless LAN module
Model name : NEC VERSA LitePad
Data applies to : NEC Versa T400, LaVie TB(PC-TB7005T), LaVie G
(PC-LG93JGLRD), VersaPro(VA93JGL)
Date Received : JAN. 15, 2003
Date Tested : FEB. 05~MAR. 28, 2003

MEASUREMENT REQUIREMENT USED :

47 CFR Part 15, Subpart B and Subpart C (Section 15.247),
ANSI C63.4-2001

WE HEREBY CERTIFY THAT: The measurements shown in the attachment were made in accordance with the procedures indicated, and the energy emitted by the equipment was found to be within the limits applicable. We assume full responsibility for the accuracy and completeness of these measurements and vouch for the qualifications of all persons taking them.

| | Name | Signature | Date |
|-------------------|-----------------------|----------------------|----------------------|
| Testing Engineer | Roger Sheng / NVLAP | <i>Roger Sheng</i> | <i>Mar. 28, 2003</i> |
| Approving Manager | Chieh-De Tsai / NVLAP | <i>Chieh-De Tsai</i> | <i>Mar. 28, 2003</i> |

Notes :

1. This report will be invalid if duplicated or photocopied in part.
2. This report refers only to the specimen(s) submitted to test, and is invalid as separately used.
3. This report is invalid without examination stamp and signature of this institute.
4. The tested specimen(s) will be preserved for thirty days from the data issued.
5. The report must not be used to claim product certification, approval, or endorsement by NVLAP, NIST, or any agency of the federal government.



TABLE OF CONTENTS

| TITLE | PAGE NO. |
|---|-----------------|
| 1. GENERAL INFORMATION | 4 |
| 1.1 GENERAL STATEMENT | 4 |
| 1.2 GENERAL DESCRIPTION OF EUT & POWER | 4 |
| 1.3 DESCRIPTION OF PERIPHERALS | 5 |
| 1.4 EUT & PERIPHERALS SETUP DIAGRAM | 7 |
| 1.5 EUT OPERATING CONDITION | 7 |
| 1.6 DESCRIPTION OF TEST SITE | 8 |
| 1.7 SUMMARY OF TEST RESULTS | 8 |
| 2. CONDUCTED POWERLINE TEST | 9 |
| 2.1 TEST EQUIPMENTS | 9 |
| 2.2 TEST SETUP | 9 |
| 2.3 CONDUCTED POWER LINE EMISSION LIMIT | 10 |
| 2.4 TEST PROCEDURE | 10 |
| 2.5 UNCERTAINTY OF CONDUCTED EMISSION | 10 |
| 2.6 CONDUCTED RF VOLTAGE MEASUREMENT | 11 |
| 2.7 CONDUCTED RF VOLTAGE MEASUREMENT | 12 |
| 2.7 PHOTOS OF CONDUCTION TEST | 13 |
| 3. RADIATED EMISSION TEST | 14 |
| 3.1 TEST EQUIPMENTS | 14 |
| 3.2 TEST SETUP | 14 |
| 3.3 RADIATION LIMIT | 15 |
| 3.4 TEST PROCEDURES | 16 |
| 3.5 UNCERTAINTY OF RADIATED EMISSION | 16 |
| 3.6 RADIATED RF NOISE MEASUREMENT | 17 |
| 3.7 PHOTOS OF OPEN SITE | 28 |
| 4. 6dB BANDWIDTH MEASUREMENT | 30 |
| 4.1 TEST EQUIPMENTS | 30 |
| 4.2 TEST SETUP | 30 |
| 4.3 LIMITS OF 6dB BANDWIDTH MEASUREMENT | 30 |
| 4.4 TEST PROCEDURE | 30 |
| 4.5 UNCERTAINTY OF CONDUCTED EMISSION | 30 |
| 4.6 TEST RESULTS | 31 |
| 4.7 PHOTO OF 6DB BANDWIDTH MEASUREMENT | 32 |
| 5. MAXIMUM PEAK OUTPUT POWER | 33 |
| 5.1 TEST EQUIPMENTS | 33 |
| 5.2 TEST SETUP | 33 |
| 5.3 LIMITS OF MAXIMUM PEAK OUTPUT POWER | 33 |
| 5.4 TEST PROCEDURE | 34 |
| 5.5 UNCERTAINTY OF CONDUCTED EMISSION | 34 |
| 5.6 TEST RESULTS | 34 |



TABLE OF CONTENTS

| TITLE | PAGE NO. |
|---|----------|
| 6. POWER SPECTRAL DENSITY MEASUREMENT | 35 |
| 6.1 TEST EQUIPMENTS..... | 35 |
| 6.2 TEST SETUP..... | 35 |
| 6.3 LIMITS OF POWER SPECTRAL DENSITY MEASUREMENT..... | 35 |
| 6.4 TEST PROCEDURE | 36 |
| 6.5 UNCERTAINTY OF CONDUCTED EMISSION | 36 |
| 6.6 TEST RESULTS..... | 36 |
| 6.7 PHOTO OF POWER SPECTRAL DENSITY MEASUREMENT | 37 |
| 7. OUT OF BAND MEASUREMENT | 38 |
| 7.1 TEST EQUIPMENTS..... | 38 |
| 7.2 TEST SETUP..... | 38 |
| 7.3 LIMITS OF OUT OF BAND EMISSIONS MEASUREMENT | 38 |
| 7.4 TEST PROCEDURE | 38 |
| 7.5 UNCERTAINTY OF CONDUCTED EMISSION | 38 |
| 7.6 TEST RESULTS..... | 39 |
| 7.7 PHOTO OF OUT OF BAND MEASUREMENT | 40 |
| 8. ANTENNA REQUIREMENT | 41 |
| 8.1 STANDARD APPLICABLE..... | 41 |
| 8.2 ANTENNA CONNECTED CONSTRUCTION | 41 |



1. GENERAL INFORMATION

1.1 GENERAL STATEMENT

MEASUREMENT DEVIATION : Comply with standard in full

TRACEABILITY : This test result is traceable to national or international std.

1.2 GENERAL DESCRIPTION OF EUT & POWER

MANUFACTURER : Arima computer corporation.

PRODUCT NAME : Tablet PC with built-in 802.11a&b Wireless LAN module

MODEL NAME : NEC VERSA Litepad

DATA APPLIES TO : NEC versa T400, Lavie TB(PC-TB7005T), Lavie G
(PC-LG93JGLRD), versapro(VA93JGL)

FREQUENCY RANGE : 2400 MHz TO 24835 MHz (ISM band) for 802.11b,
5150 MHz TO 5350MHz (U-NII band) for 802.11a
5725 MHz TO 5825MHz (U-NII band) for 802.11a

CHANNEL NUMBER : 11 channel for 802.11b
12 channel for 802.11a

CHANNEL Bandwidth : 20 MHz

AIR DATA RATE : 56Mbps

TYPE OF MODULATION : OFDM-BPSK/QPSK/16QAM/64QAM for 802.11a
DSSS-BPSK/QPSK/CCK , For 802.11b

FREQUENCY SELECTION : BY SOFTWARE

ANTENNA TYPE : PIFA

Power Adapter :

Manufacturer : NEC CustomTechnica, Ltd.

Model Number : ADP-50HH REV.A

Serial Number : 2405180DA

Input : 100~240 VAC

Output : 19 VDC 2.64A



1.3 DESCRIPTION OF PERIPHERALS

(1) Notebook PC

MANUFACTURER : DELL CORP.
MODEL NUMBER : PP01L
SERIAL NUMBER : CN-09C748-48155-1AP-6081
F.C.C. : DOC
POWER CORD : Unshielded, Detachable, 1.8m

(2) MODEM

MANUFACTURER : ZyXEL CORP.
MODEL NUMBER : omni 56K
SERIAL NUMBER : S1Z4107729
F.C.C. ID : I880MNI56K
POWER CORD : UnShielded , Detachable , 1.8m (9VAC from Power Adapter)

(3) PRINTER

MANUFACTURER : HP CORP.
MODEL NUMBER : C6431D
SERIAL NUMBER : CN19T6S011
F.C.C. : DOC
POWER CORD : Unshielded , Detachable , 1.8m
DATA CABLE : Shielded , Detachable , 1.2m

(4) MONITOR

MANUFACTURER : HP CORP.
MODEL NUMBER : D8894A
SERIAL NUMBER : CN00905269
F.C.C. ID : ARSCM569N
POWER CORD : UnShielded , Detachable , 1.8m
SIGNAL CABLE : Shielded , Undetachable , 1.8m

(5) KEYBOARD

MANUFACTURER : HP CORP.
MODEL NUMBER : SK-2502C
SERIAL NUMBER : M000303429
F.C.C. ID : -----
POWER SOURCE : 5VDC (from Notebook PC)
SIGNAL CABLE : Shielded , Undetachable , 1.8m



(6) MOUSE

MANUFACTURER : HP CORP.
MODEL NUMBER : SK-2502C
SERIAL NUMBER : M000303429
F.C.C. ID : -----
POWER SOURCE : 5VDC (from Notebook PC)
SIGNAL CABLE : Shielded , Undetachable , 1.8m

(6) MOUSE

MODEL NUMBER : M-S34
SERIAL NUMBER : LZE95050431
MANUFACTURER : HP CORP.
FCC ID : DZL211029
SIGNAL CABLE : Shielded , Undetachable , 1.8m
POWER SOURCE : 5VDC (from PC)

(7) PC

MANUFACTURER : HP CORP.
MODEL NUMBER : 8894
SERIAL NUMBER : P3129-WOYO
F.C.C. : DOC
POWER CORD : Unshielded, Detachable, 1.8m

(8) CABLE

| | Type | Connector | shielded | Length |
|-----|---------------------------------|---------------|----------|--------|
| (A) | Cross-over Cat5 twisted-pair | RJ-45,Plastic | NO | 15m |
| (B) | Telephone Line | RJ-45,Plastic | NO | 15m |



1.4 EUT & PERIPHERALS SETUP DIAGRAM

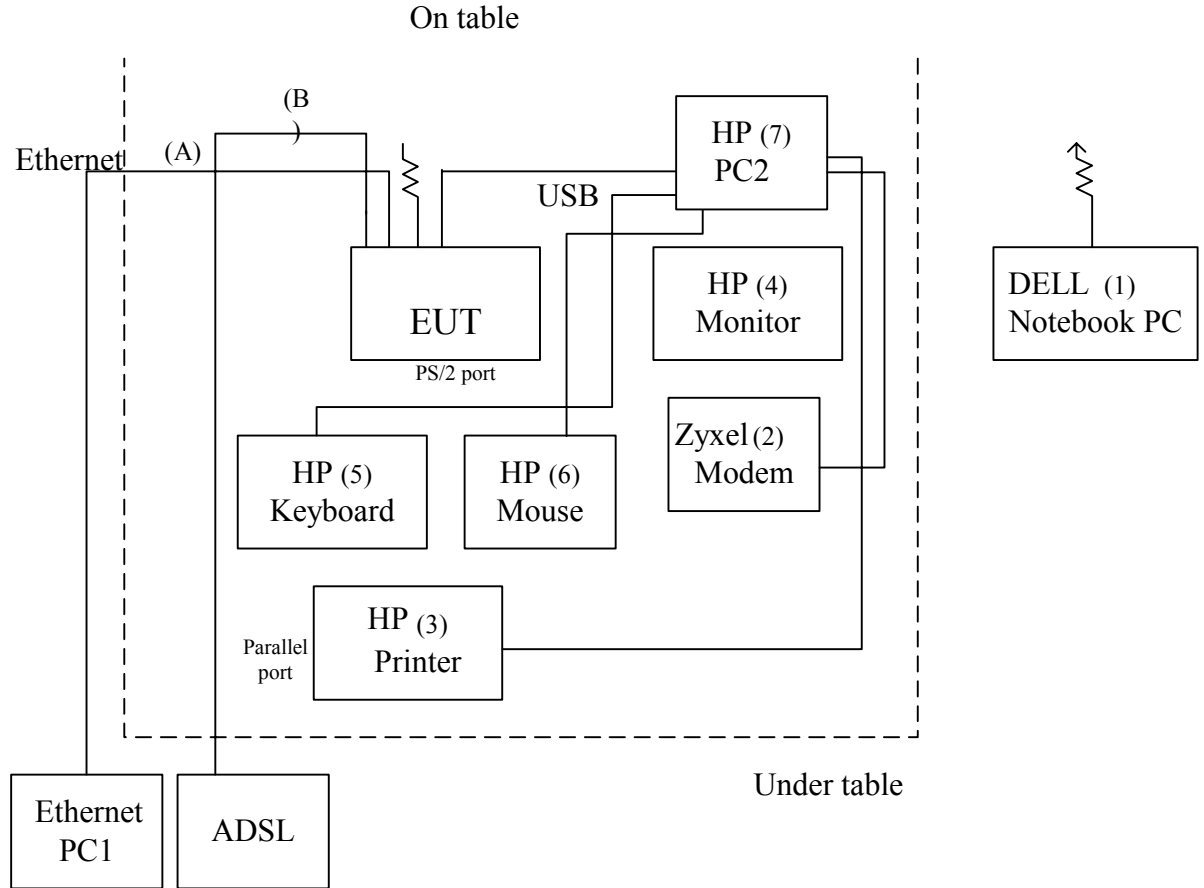

The indicated numbers (1) (2)..., Please refer to item 1.3

1.5 EUT OPERATING CONDITION

1. Set up all computers as in the setup diagram.
2. Run ART.exe, change the test modes to TX, RX, or Stand By mode.
3. Set the carrier frequency to lowest middle, highest channel.
4. Turn on the RF output.
5. Start test.



1.6 DESCRIPTION OF TEST SITE

SITE DESCRIPTION : FCC certificate NO. : 31040/SIT
 TUV certificate NO. : I9664582-9911
 BSMI certificate NO. : SL2-IN-E-0002
 NVLAP Lab code : 200118-0
 CNLA certificate NO. : CNLA-ZL97018
 VCCI certificate NO. : R-1189, C-1250

NAME OF SITE : Electronics Research & Service Organization
 Industrial Technology Research Institute

SITE LOCATION : R1500, 195-4 , sec. 4, Chung Hsing Rd., Chu-Tung Chen.
 Hsin-Chu, Taiwan 310 R.O.C.

1.7 SUMMARY OF TEST RESULTS

The EUT has been tested according to the following specifications :

| APPLIED STANDARD : 47 CFR Part 15, Subpart B and Subpart C | | | |
|--|--|--------|-------------------------------|
| Standard Section | Test Type and Limit | Result | REMARK |
| 15.107 15.207 | AC Power Conducted Emission Limit : table 15.107 or 15.207 | PASS | Meet the requirement of limit |
| 15.247(a)(2) | Spectrum Bandwidth of a Direct Sequence Spread Spectrum System Limit : 6dB bandwidth > 500KHz | PASS | Meet the requirement of limit |
| 15.247(b) | Maximum Peak Output Power Limit : max. 30dBm | PASS | Meet the requirement of limit |
| 15.109 15.205 15.209 | Transmitter Radiated Emissions Limit : Table 15.209 | PASS | Meet the requirement of limit |
| 15.247(d) | Power Spectral Density Limit : max. 8dBm | PASS | Meet the requirement of limit |
| 15.247(c) | Out of Band Emission and Restricted Band Radiation Limit:20dB less than peak value of fundamental frequency Restricted band Limit:Table 15.209 | PASS | Meet the requirement of limit |



2. CONDUCTED POWERLINE TEST

2.1 TEST EQUIPMENTS

The following test equipments are used during the conducted powerline tests :

| MANUFACTURER OR TYPE | MODEL No | SERIAL NO. | DATE OF CALIBRATION | CALIBRATION PERIOD | REMARK |
|-----------------------------|--------------|------------------------|---|--------------------|---------|
| SPECTRUM ANALYZER & DISPLAY | HP 8568A | 2235A02320 | APR. 01, 2002 | 1 Year | PRETEST |
| QUASI-PEAK ADAPTER | HP 85650 A | 2341A00672 | APR. 01, 2002 | 1 Year | PRETEST |
| ISOLATION TRANSFORMER | SOLAR 7032-1 | N/A | N/A | N/A | FINAL |
| L.I.S.N. | EMCO 3850/2 | 9311-1025 9401-1028 | JAN. 08, 2002 For Characteristic impedance MAY 18, 2002 For Insertion loss | 1 Year | FINAL |
| TEST RECEIVER | R/S ESHS30 | 838550/003 | JUN. 07, 2002 | 1 Year | FINAL |
| SHIELDED ROOM | KEENE 5983 | NO.1 | N/A | N/A | FINAL |
| PULSE LIMIT | R/S EHS3Z2 | 357.8810.52 | JUL. 10, 2002 | 1 Year | FINAL |
| N TYPE COAXIAL CABLE | ----- | ----- | JUL. 10, 2002 | 1 Year | FINAL |
| 50 TERMINATOR | ----- | ----- | JUL. 10, 2002 | 1 Year | FINAL |

2.2 TEST SETUP

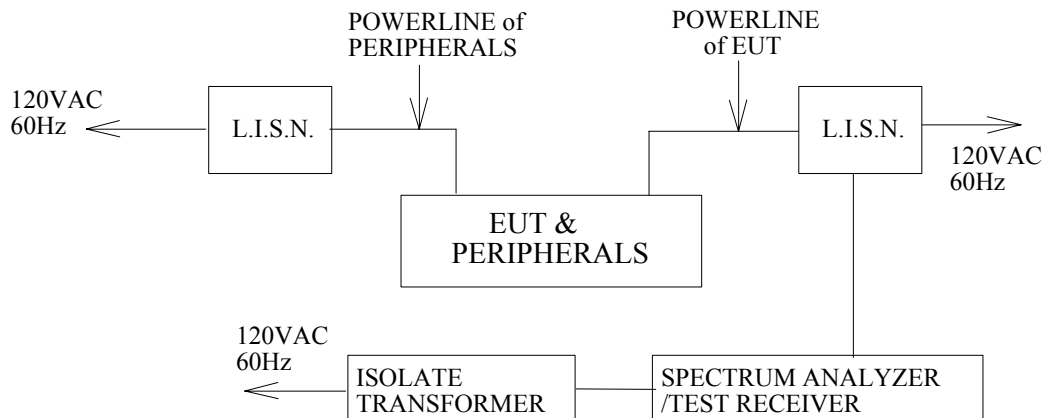



2.3 CONDUCTED POWER LINE EMISSION LIMIT

For unintentional device, according to § 15.107(a) Line Conducted Emission Limits is as following :

| FREQUENCY (MHz) | MAXIMUM RF LINE VOLTAGE (dB μ V) | | | |
|--------------------|--------------------------------------|------|---------|-------|
| | CLASS A | | CLASS B | |
| | Q.P. | Ave. | Q.P. | Ave. |
| 0.15 - 0.50 | 79 | 66 | 66-56 | 56-46 |
| 0.50 - 5.00 | 73 | 60 | 56 | 46 |
| 5.00 - 30.0 | 73 | 60 | 60 | 50 |

For intentional device, according to § 15.207(a) Line Conducted Emission Limit is same as above table.

2.4 TEST PROCEDURE

The test procedure is performed in a 12ft \times 12ft \times 8ft(L \times W \times H) shielded room. the EUT along with its peripherals were placed on a 1.0m(W) \times 1.5m(L) and 0.8m in height wooden table and the EUT was adjusted to maintain a 0.4 meter space from a vertical reference plane. The EUT was connected to power mains through a line impedance stabilization network (LISN) which provides 50 ohm coupling impedance for measuring instrument and the chasis ground was bounded to the horizontal ground plane of shielded room. All peripherals were connected to the second LISN and the chasis ground also bounded to the horizontal ground plane of shielded room. The excess power cable between the EUT and the LISN was bundled. The power cables of peripherals were unbundled. All connecting cables of EUT and peripherals were moved to find the maximum emission.

2.5 UNCERTAINTY OF CONDUCTED EMISSION

The uncertainty of conducted emission is ± 1.36 dB.



2.6 CONDUCTED RF VOLTAGE MEASUREMENT (TX)

The EUT is in Transmitting mode white testing

The frequency spectrum from 0.15 MHz to 30 MHz was investigated. All emissions not reported below are more than 20 dB below the prescribed limits.

Temperature : 26

Humidity : 65 % RH

| FREQUENCY (MHz) | READING(dB μ V) | | | | LIMITS (dB μ V) | |
|--------------------|---------------------|------|-----------------------|------|------------------------|-------|
| | ONE END & GRD'D | | THE OTHER END & GRD'D | | Q.P. | Ave. |
| | Q.P. | Ave. | Q.P. | Ave. | | |
| 0.150 | * | * | 49.8 | * | 66.00 | 56.00 |
| 0.219 | 45.6 | * | * | * | 62.90 | 54.80 |
| 0.291 | 41.0 | * | 44.1 | * | 60.50 | 50.20 |
| 0.582 | 27.2 | * | * | * | 56.00 | 46.00 |
| 0.651 | * | * | 34.3 | * | 56.00 | 46.00 |
| 1.593 | * | * | 27.9 | * | 56.00 | 46.00 |
| 1.599 | 25.9 | * | * | * | 56.00 | 46.00 |
| 2.841 | 28.5 | * | * | * | 56.00 | 46.00 |
| 3.984 | 27.4 | * | * | * | 56.00 | 46.00 |
| 4.419 | * | * | 28.7 | * | 56.00 | 46.00 |
| 6.558 | 28.3 | * | * | * | 60.00 | 50.00 |
| 12.348 | 22.8 | * | * | * | 60.00 | 50.00 |
| 14.961 | * | * | 19.6 | * | 60.00 | 50.00 |
| 26.823 | * | * | 33.1 | * | 60.00 | 50.00 |
| 27.315 | 32.8 | * | * | * | 60.00 | 50.00 |
| 30.000 | * | * | * | * | 60.00 | 50.00 |

REMARKS :

- * Undetectable or the Q.P. value is lower than the limits of Ave.
- After the preliminary scan, we found the EUT is in Transmitting mode producing the highest emission level so the channel 6 (2437MHz) were recorded for final testing.
- Mode : Transmitting (TX)



2.7 CONDUCTED RF VOLTAGE MEASUREMENT (RX)

The EUT is in Receiving mode white testing

The frequency spectrum from 0.15 MHz to 30 MHz was investigated. All emissions not reported below are more than 20 dB below the prescribed limits.

Temperature : 26

Humidity : 65 % RH

| FREQUENCY (MHz) | READING(dB μ V) | | | | LIMITS (dB μ V) | |
|--------------------|---------------------|------|-----------------------|------|------------------------|-------|
| | ONE END & GRD'D | | THE OTHER END & GRD'D | | Q.P. | Ave. |
| | Q.P. | Ave. | Q.P. | Ave. | | |
| 0.150 | 53.3 | * | 53.5 | * | 66.00 | 56.00 |
| 0.291 | 37.9 | * | * | * | 64.80 | 54.80 |
| 0.513 | * | * | 40.6 | * | 56.00 | 46.00 |
| 0.585 | 30.6 | * | * | * | 56.00 | 46.00 |
| 0.660 | * | * | 37.1 | * | 56.00 | 46.00 |
| 1.248 | * | * | 32.4 | * | 56.00 | 46.00 |
| 1.830 | 29.0 | * | * | * | 56.00 | 46.00 |
| 3.738 | 28.6 | * | 22.5 | * | 56.00 | 46.00 |
| 4.236 | 20.6 | * | * | * | 56.00 | 46.00 |
| 4.257 | * | * | 26.6 | * | 56.00 | 46.00 |
| 12.015 | 29.6 | * | * | * | 60.00 | 50.00 |
| 12.048 | * | * | 23.5 | * | 60.00 | 50.00 |
| 26.823 | 34.6 | * | * | * | 60.00 | 50.00 |
| 27.474 | * | * | 34.8 | * | 60.00 | 50.00 |
| 30.000 | * | * | * | * | 60.00 | 50.00 |

REMARKS :

- * Undetectable or the Q.P. value is lower than the limits of Ave.
- After the preliminary scan, we found the EUT is in Transmitting mode producing the highest emission level so the channel 6 (2437MHz) were recorded for final testing.
- Mode: Receiving (RX)



2.7 PHOTOS OF CONDUCTION TEST





3. RADIATED EMISSION TEST

3.1 TEST EQUIPMENTS

The following test equipments are utilized in making the measurements contained in this report.

| MANUFACTURER OR TYPE | MODEL NO | SERIAL NO | DATE OF CALIBRATION | CALIBRATION PERIOD | REMARK |
|----------------------|-------------|--------------------------|---------------------|--------------------|--------|
| CHASE BI-LOG ANTENNA | CBL6112B | 2421 | MAY 07, 2002 | 1 Year | FINAL |
| R/S TEST RECEIVER | ESMI | 842088/005 841978/008 | SEPT. 3, 2002 | 1 Year | FINAL |
| OPEN SITE | ----- | No.1 | JUL. 10~12, 2002 | 1 Year | FINAL |
| N TYPE COAXIAL CABLE | CHA9525 | 4 | JUL. 13, 2002 | 1 Year | FINAL |
| Horn Antenna | AH-118 | 10089 | FEB. 25, 2002 | 1 Year | FINAL |
| HP Pre-amplifier | 8449B | 3008A01471 | OCT. 11, 2002 | 1 Year | FINAL |
| HP High pass filter | 84300/80038 | 011 | cal. on use | 1 Year | FINAL |
| Horn Antenna | AH-840 | 03077 | FEB. 25, 2002 | 1 Year | FINAL |

3.2 TEST SETUP

The diagram below shows the test setup which is utilized to make these measurements.

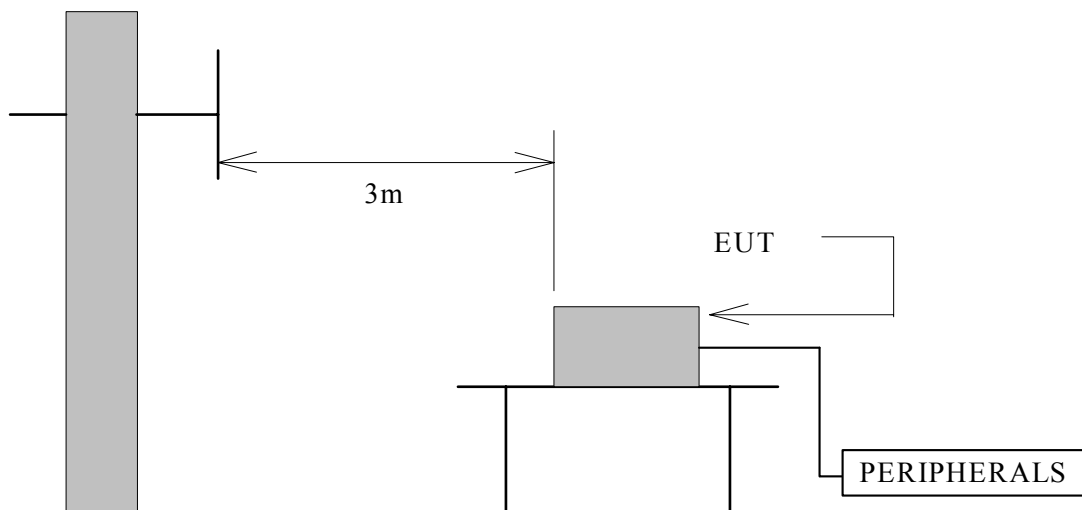

Antenna Elevation Variable



3.3 RADIATION LIMIT

For unintentional device, according to § 15.109(a), except for Class A digital devices, the field strength of radiated emissions from unintentional radiators at a distance of 3 meters shall not exceed the following values :

| FREQUENCY (MHz) | DISTANCE (METERS) | Radiated (dB μ V/m) | Radiated (μ V/m) |
|--------------------|----------------------|----------------------------|--------------------------|
| 30-88 | 3 | 40.0 | 100 |
| 88-216 | 3 | 43.5 | 150 |
| 216-960 | 3 | 46.0 | 200 |
| Above 960 | 3 | 54.0 | 500 |

For intentional device, according to § 15.209(a), the general requirement of field strength of radiated emissions from intentional radiators at a distance of 3 meters shall not exceed the above table.



3.4 TEST PROCEDURES

- a. The EUT was placed on the top of a rotating table 0.8 meters above the ground at a 10 meter open area test site. The table was rotated 360 degrees to determine the position of the highest radiation.
- b. The EUT was set 3 meters away from the interference-receiving antenna, which was mounted on the top of a variable-height antenna tower.
- c. The antenna is a broadband antenna, and its height is varied from one meter to four meters above the ground to determine the maximum value of the field strength. Both horizontal and vertical polarization of the antenna are set to make the measurement.
- d. For each suspected emission, the EUT was arranged to its worst case and then the antenna was tuned to heights from 1 meter to 4 meters and the rotatable table was turned from 0 degrees to 360 degrees to find the maximum reading.
- e. The test-receiver system was set to Peak Detect Function and Specified Bandwidth with Maximum Hold Mode.
- f. If the emission level of the EUT in peak mode was 10 dB lower than the limit specified, then testing could be stopped and the peak values of the EUT would be reported. Otherwise the emissions that did not have 10 dB margin would be re-tested one by one using peak, quasi-peak or average method as specified and then reported in a data sheet.

NOTE :

1. The resolution bandwidth and video bandwidth of test receiver/spectrum analyzer is 120 KHz for Peak detection (PK) and Quasi-peak detection (QP) at frequency below 1GHz.
2. The resolution bandwidth and video bandwidth of test receiver/spectrum analyzer is 1 MHz for Peak detection and frequency above 1GHz.
3. The resolution bandwidth of test receiver/spectrum analyzer is 1 MHz and the video bandwidth is 10 Hz for Average detection (AV) at frequency above 1GHz.

3.5 UNCERTAINTY OF RADIATED EMISSION

The uncertainty of radiated emission is ± 2.72 dB.



3.6 RADIATED RF NOISE MEASUREMENT

Test Requirement: 15.109, 15.209

The frequency spectrum **from 30 MHz to 1000 MHz** was investigated. All emissions not reported below are more than 30 dB below the prescribed limits.

All readings are quasi-peak values.

Temperature : 25

Humidity : 65 % RH

| FREQ- UENCY (MHz) | ANTENNA FACTOR (dB) | CABLE LOSS (dB) | METER READING at 3m(dB μ V/m) | | LIMITS at 3m (dB μ V/M) | EMISSION LEVEL at 3m(dB μ V/m) | |
|-------------------------|---------------------------|-----------------------|--------------------------------------|----------|-----------------------------------|---------------------------------------|----------|
| | | | HORIZON-TAL | VERTICAL | | HORIZON-TAL | VERTICAL |
| 30.00 | 21.39 | 0.90 | * | * | 40.00 | * | * |
| 34.99 | 14.64 | 1.00 | 7.50 | 11.90 | 40.00 | 23.14 | 27.54 |
| 46.75 | 9.93 | 1.34 | 16.10 | 28.60 | 40.00 | 27.37 | 39.87 |
| 85.61 | 9.43 | 1.76 | 20.30 | 28.17 | 40.00 | 31.49 | 39.36 |
| 132.84 | 12.32 | 2.25 | 12.70 | 15.24 | 43.50 | 27.27 | 29.81 |
| 181.25 | 9.85 | 2.60 | 6.30 | 7.26 | 43.50 | 18.75 | 19.71 |
| 260.87 | 12.92 | 3.14 | 5.80 | 5.24 | 46.00 | 21.86 | 21.30 |
| 527.99 | 18.27 | 4.36 | 5.30 | 6.73 | 46.00 | 27.93 | 29.36 |
| 927.83 | 20.84 | 5.82 | 8.40 | 9.48 | 46.00 | 35.06 | 36.14 |
| 1000.00 | 24.69 | 5.70 | * | * | 46.00 | * | * |

REMARKS : 1. * Undetectable

2. Emission level (dB μ V/M) = Antenna Factor (dB/m) + Cable loss (dB)
 + Meter Reading (dB μ V).

3. After the preliminary scan, we found the EUT is in Transmitting mode producing the highest emission level so the channel 1 (2412MHz) were recorded for final testing.

4. Mode : Transmitting (Tx)



Test Requirement: 15.109, 15.209

The frequency spectrum **from 30 MHz to 1000 MHz** was investigated. All emissions not reported below are more than 30 dB below the prescribed limits.

All readings are quasi-peak values.

Temperature : 25

Humidity : 65 % RH

| FREQ- UENCY (MHz) | ANTENNA FACTOR (dB) | CABLE LOSS (dB) | METER READING at3m(dB μ V/m) | | LIMITS at 3m (dB μ V/M) | EMISSION LEVEL at3m(dB μ V/m) | |
|-------------------------|---------------------------|-----------------------|---------------------------------|----------|-------------------------------|----------------------------------|----------|
| | | | HORIZONTAL | VERTICAL | | HORIZONTAL | VERTICAL |
| 30.00 | 21.39 | 0.90 | * | * | 40.00 | * | * |
| 35.10 | 14.60 | 1.00 | 5.30 | 6.29 | 40.00 | 20.90 | 21.89 |
| 45.97 | 10.21 | 1.32 | 15.10 | 23.20 | 40.00 | 26.63 | 34.73 |
| 71.08 | 7.35 | 1.61 | 21.50 | 23.80 | 40.00 | 30.46 | 32.76 |
| 82.97 | 8.88 | 1.73 | 27.50 | 27.65 | 40.00 | 38.11 | 38.26 |
| 133.07 | 12.31 | 2.25 | 14.10 | 8.80 | 43.50 | 28.66 | 23.36 |
| 181.24 | 9.85 | 2.60 | 8.60 | 5.80 | 43.50 | 21.05 | 18.25 |
| 192.29 | 9.97 | 2.60 | 12.80 | 7.00 | 43.50 | 25.37 | 19.57 |
| 230.00 | 11.68 | 2.90 | 5.40 | 7.80 | 46.00 | 19.98 | 22.38 |
| 664.50 | 19.86 | 5.08 | 9.20 | 6.60 | 46.00 | 34.14 | 31.54 |
| 1000.00 | 24.69 | 5.70 | * | * | 46.00 | * | * |

REMARKS : 1. * Undetectable

2. Emission level (dB μ V/M) = Antenna Factor (dB/m) + Cable loss (dB)
 + Meter Reading (dB μ V).

3. After the preliminary scan, we found the EUT is in Receiving mode producing the highest emission level so the channel 1 (2412MHz) were recorded for final testing.

4. Mode: Receiving (Rx)



Test Requirement: 15.109 ,15.209

The frequency spectrum **above 1 GHz** was investigated. All emissions not reported below are more than 45 dB below the prescribed limits. Readings are both peak and average values.

| | | | |
|-----------------------|----------------------|-------------|-------------|
| Operation Mode : | Receiving(RX) | Test Date : | 2003/2/10 |
| | 2412MHz(CH1) | Test By: | Roger Sheng |
| Fundamental Frequency | 22 | Humidity : | 65% |

| Freq. (MHz) | Reading (dBuV) | AF (dBuV) | Cable (dB) | Pre-amp (dB) | Dist dB | Filter dB | Level (dBuV/m) | Limit at 3m (dBuV/m) | Margin (dB) | Mark (P/O/A) | Pol (H/V) | Height (Meter) |
|----------------|-------------------|--------------|---------------|-----------------|------------|--------------|-------------------|-------------------------|----------------|-----------------|--------------|-------------------|
| 2255.35 | 59.68 | 31.94 | 1.94 | 35.28 | 9.5 | 0 | 48.79 | 74 | -25.21 | P | V | 1.0 |
| 2255.35 | 40.76 | 31.94 | 1.94 | 35.28 | 9.5 | 0 | 29.87 | 54 | -24.13 | A | V | 1.0 |
| 2324.71 | 46.32 | 31.88 | 2.13 | 35.29 | 9.5 | 0 | 35.53 | 74 | -38.47 | P | V | 1.0 |
| 2324.71 | 32.76 | 31.88 | 2.13 | 35.29 | 9.5 | 0 | 21.97 | 54 | -32.03 | A | V | 1.0 |
| 2392.04 | 54.01 | 31.81 | 2.30 | 35.31 | 9.5 | 0 | 43.31 | 74 | -30.69 | P | V | 1.0 |
| 2392.04 | 36.77 | 31.81 | 2.30 | 35.31 | 9.5 | 0 | 26.07 | 54 | -27.93 | A | V | 1.0 |
| 3055.41 | 43.97 | 31.667 | 1.93 | 35.48 | 9.5 | 0 | 32.58 | 74 | -41.42 | P | V | 1.0 |
| 3055.41 | 31.91 | 31.667 | 1.93 | 35.48 | 9.5 | 0 | 20.51 | 54 | -33.49 | A | V | 1.0 |
| 4464.01 | 42.56 | 32.322 | 2.63 | 35.29 | 9.5 | 0 | 32.72 | 74 | -41.28 | P | V | 1.5 |
| 4464.01 | 30.32 | 32.322 | 2.63 | 35.29 | 9.5 | 0 | 20.48 | 54 | -33.52 | A | V | 1.5 |
| 2255.35 | 52.75 | 31.945 | 1.94 | 35.28 | 9.5 | 0 | 41.86 | 74 | -32.14 | P | H | 1.0 |
| 2255.35 | 36.14 | 31.945 | 1.94 | 35.28 | 9.5 | 0 | 25.25 | 54 | -28.75 | A | H | 1.0 |
| 2324.71 | 44.69 | 31.875 | 2.13 | 35.29 | 9.5 | 0 | 33.90 | 74 | -40.10 | P | H | 1.0 |
| 2324.71 | 32.33 | 31.875 | 2.13 | 35.29 | 9.5 | 0 | 21.54 | 54 | -32.46 | A | H | 1.0 |
| 2392.04 | 46.74 | 31.808 | 2.30 | 35.31 | 9.5 | 0 | 36.04 | 74 | -37.96 | P | H | 1.0 |
| 2392.04 | 33.07 | 31.808 | 2.30 | 35.31 | 9.5 | 0 | 22.37 | 54 | -31.63 | A | H | 1.0 |
| 3055.41 | 44.94 | 31.667 | 1.93 | 35.48 | 9.5 | 0 | 33.55 | 74 | -40.45 | P | H | 1.0 |
| 3055.41 | 32.21 | 31.667 | 1.93 | 35.48 | 9.5 | 0 | 20.81 | 54 | -33.19 | A | H | 1.0 |
| 4464.00 | 41.79 | 32.322 | 2.63 | 35.29 | 9.5 | 0 | 31.95 | 74 | -42.05 | P | H | 1.5 |
| 4464.00 | 30.51 | 32.322 | 2.63 | 35.29 | 9.5 | 0 | 20.66 | 54 | -33.34 | A | H | 1.5 |

Note :

1. Measurement was up to 18GHz ,“---” means that the emissions level is too low to be measured.
2. AF: Antenna Factor, Cable: Cable Loss, Pre-Amp: Pre Amplifier Gain, Dist :correction to extrea plate reading to 3m specification distance 1m measurement distance = -9.5dB
3. Analyzer setting P(Peak): RBW=1MHz, VBW=1MHz, A(Average): RBW=1MHz,VBW=10Hz
- 4.The result basic equation calculation is as follow:

$$\text{Level}=\text{Reading}+\text{AF}+\text{Closs}-\text{Preamp}+\text{Filter}-\text{Dist}$$

$$\text{Margin}=\text{Level}-\text{Limit}$$



Test Requirement: 15.109 ,15.209

The frequency spectrum **above 1 GHz** was investigated. All emissions not reported below are more than 45 dB below the prescribed limits. Readings are both peak and average values.

| | | | |
|-----------------------|----------------------|-------------|-------------|
| Operation Mode : | Receiving(RX) | Test Date : | 2003/2/10 |
| | 2437MHz(CH6) | Test By: | Roger Sheng |
| Fundamental Frequency | 22 | Humidity : | 65% |

| Freq. | Reading | AF | Cable | Pre-amp | Dist | Filter | Level | Limit | Margin | Mark | Pol | Height |
|---------|---------|--------|-------|---------|------|--------|--------|----------------|--------|---------|-------|---------|
| (MHz) | (dBuV) | (dBuV) | (dB) | (dB) | dB | dB | dBuV/m | at 3m (dBuV/m) | (dB) | (P/Q/A) | (H/V) | (Meter) |
| 2256.17 | 59.61 | 31.94 | 1.95 | 35.28 | 9.5 | 0 | 48.71 | 74 | -25.29 | P | V | 1.0 |
| 2256.17 | 40.53 | 31.94 | 1.95 | 35.28 | 9.5 | 0 | 29.64 | 54 | -24.36 | A | V | 1.0 |
| 2385.11 | 53.33 | 31.81 | 2.29 | 35.31 | 9.5 | 0 | 42.62 | 74 | -31.38 | P | V | 1.0 |
| 2385.11 | 35.66 | 31.81 | 2.29 | 35.31 | 9.5 | 0 | 24.95 | 54 | -29.05 | A | V | 1.0 |
| 2527.71 | 48.56 | 31.71 | 2.55 | 35.34 | 9.5 | 0 | 37.97 | 74 | -36.03 | P | V | 1.0 |
| 2527.71 | 33.17 | 31.71 | 2.55 | 35.34 | 9.5 | 0 | 22.58 | 54 | -31.42 | A | V | 1.0 |
| 4484.01 | 42.35 | 32.31 | 2.61 | 35.30 | 9.5 | 0 | 32.48 | 74 | -41.52 | P | V | 1.5 |
| 4484.01 | 30.63 | 32.31 | 2.61 | 35.30 | 9.5 | 0 | 20.76 | 54 | -33.24 | A | V | 1.5 |
| 2256.17 | 52.75 | 31.94 | 1.95 | 35.28 | 9.5 | 0 | 41.86 | 74 | -32.14 | P | H | 1.0 |
| 2256.17 | 36.01 | 31.94 | 1.95 | 35.28 | 9.5 | 0 | 25.12 | 54 | -28.88 | A | H | 1.0 |
| 2385.11 | 45.67 | 31.81 | 2.29 | 35.31 | 9.5 | 0 | 34.96 | 74 | -39.04 | P | H | 1.0 |
| 2385.11 | 35.66 | 31.81 | 2.29 | 35.31 | 9.5 | 0 | 24.95 | 54 | -29.05 | A | H | 1.0 |
| 2527.71 | 45.97 | 31.71 | 2.55 | 35.34 | 9.5 | 0 | 35.38 | 74 | -38.62 | P | H | 1.0 |
| 2527.71 | 32.94 | 31.71 | 2.55 | 35.34 | 9.5 | 0 | 22.35 | 54 | -31.65 | A | H | 1.0 |
| 4484.01 | 43.26 | 32.31 | 2.61 | 35.30 | 9.5 | 0 | 33.39 | 74 | -40.61 | P | H | 1.5 |
| 4484.01 | 31.06 | 32.31 | 2.61 | 35.30 | 9.5 | 0 | 21.19 | 54 | -32.81 | A | H | 1.5 |

Note :

1. Measurement was up to 18GHz ,“---” means that the emissions level is too low to be measured.
2. AF: Antenna Factor, Closs: Cable Loss, Pre-Amp: Pre Amplifier Gain, Dist :correction to extra plate reading to 3m specification distance 1m measurement distance = -9.5dB
3. Analyzer setting P(Peak): RBW=1MHz, VBW=1MHz, A(Average): RBW=1MHz,VBW=10Hz
- 4.The result basic equation calculation is as follow:
 Level=Reading+AF+Closs-Preamp+Filter-Dist
 Margin=Level-Limit



Test Requirement: 15.109 ,15.209

The frequency spectrum **above 1 GHz** was investigated. All emissions not reported below are more than 45 dB below the prescribed limits. Readings are both peak and average values.

| | | | |
|-----------------------|-----------------------|-------------|-------------|
| Operation Mode : | Receiving (RX) | Test Date : | 2003/2/10 |
| | 2462MHz(CH11) | Test By: | Roger Sheng |
| Fundamental Frequency | 22 | Humidity : | 65% |

| Freq. | Reading | AF | Cable | Pre-amp | Dist | Filter | Level | Limit | Margin | Mark | Pol | Height |
|---------|---------|--------|-------|---------|------|--------|----------|----------------|--------|---------|-------|---------|
| (MHz) | (dBuV) | (dBuV) | (dB) | (dB) | dB | dB | (dBuV/m) | at 3m (dBuV/m) | (dB) | (P/Q/A) | (H/V) | (Meter) |
| 2129.22 | 48.98 | 32.071 | 1.61 | 35.26 | 9.5 | 0 | 37.91 | 74 | -36.09 | P | V | 1.0 |
| 2129.22 | 33.32 | 32.071 | 1.61 | 35.26 | 9.5 | 0 | 22.25 | 54 | -31.75 | A | V | 1.0 |
| 2265.66 | 59.42 | 31.934 | 1.97 | 35.28 | 9.5 | 0 | 48.54 | 74 | -25.46 | P | V | 1.0 |
| 2265.66 | 30.75 | 31.934 | 1.97 | 35.28 | 9.5 | 0 | 19.87 | 54 | -34.13 | A | V | 1.0 |
| 2394.14 | 53.91 | 31.806 | 2.31 | 35.31 | 9.5 | 0 | 43.21 | 74 | -30.79 | P | V | 1.0 |
| 2394.14 | 36.29 | 31.806 | 2.31 | 35.31 | 9.5 | 0 | 25.60 | 54 | -28.40 | A | V | 1.0 |
| 2528.57 | 53.77 | 31.71 | 2.55 | 35.34 | 9.5 | 0 | 43.18 | 74 | -30.82 | P | V | 1.0 |
| 2528.57 | 35.31 | 31.71 | 2.55 | 35.34 | 9.5 | 0 | 24.71 | 54 | -29.29 | A | V | 1.0 |
| 2785.91 | 47.32 | 31.71 | 2.16 | 35.43 | 9.5 | 0 | 36.25 | 74 | -37.75 | P | V | 1.0 |
| 2785.91 | 32.94 | 31.71 | 2.16 | 35.43 | 9.5 | 0 | 21.87 | 54 | -32.13 | A | V | 1.0 |
| 4504.01 | 42.79 | 32.326 | 2.60 | 35.30 | 9.5 | 0 | 32.92 | 74 | -41.08 | P | V | 1.5 |
| 4504.01 | 31.98 | 32.326 | 2.60 | 35.30 | 9.5 | 0 | 22.11 | 54 | -31.89 | A | V | 1.5 |
| 2129.22 | 42.48 | 32.071 | 1.61 | 35.26 | 9.5 | 0 | 31.41 | 74 | -42.59 | P | H | 1.0 |
| 2129.22 | 31.96 | 32.071 | 1.61 | 35.26 | 9.5 | 0 | 20.89 | 54 | -33.11 | A | H | 1.0 |
| 2265.66 | 51.68 | 31.934 | 1.97 | 35.28 | 9.5 | 0 | 40.80 | 74 | -33.20 | P | H | 1.0 |
| 2265.66 | 34.76 | 31.934 | 1.97 | 35.28 | 9.5 | 0 | 23.88 | 54 | -30.12 | A | H | 1.0 |
| 2394.14 | 43.98 | 31.806 | 2.31 | 35.31 | 9.5 | 0 | 33.29 | 74 | -40.71 | P | H | 1.0 |
| 2394.14 | 32.51 | 31.806 | 2.31 | 35.31 | 9.5 | 0 | 21.82 | 54 | -32.18 | A | H | 1.0 |
| 2528.57 | 48.15 | 31.71 | 2.55 | 35.34 | 9.5 | 0 | 37.56 | 74 | -36.44 | P | H | 1.0 |
| 2528.57 | 32.48 | 31.71 | 2.55 | 35.34 | 9.5 | 0 | 21.89 | 54 | -32.11 | A | H | 1.0 |
| 2785.91 | 44.81 | 31.71 | 2.16 | 35.43 | 9.5 | 0 | 33.74 | 74 | -40.26 | P | H | 1.0 |
| 2785.91 | 32.15 | 31.71 | 2.16 | 35.43 | 9.5 | 0 | 21.08 | 54 | -32.92 | A | H | 1.0 |
| 4504.01 | 43.21 | 32.326 | 2.60 | 35.30 | 9.5 | 0 | 33.33 | 74 | -40.67 | P | H | 1.5 |
| 4504.01 | 30.83 | 32.326 | 2.60 | 35.30 | 9.5 | 0 | 20.96 | 54 | -33.04 | A | H | 1.5 |

Note :

1. Measurement was up to 18GHz, “---” means that the emissions level is too low to be measured.
2. AF: Antenna Factor, Cable: Cable Loss, Pre-Amp: Pre Amplifier Gain, Dist :correction to extra plate reading to 3m specification distance 1m measurement distance = -9.5dB
3. Analyzer setting P(Peak): RBW=1MHz, VBW=1MHz, A(Average): RBW=1MHz,VBW=10Hz
- 4.The result basic equation calculation is as follow:
 $Level=Reading+AF+Closs-Preamp+Filter-Dist$, $Margin=Level-Limit$



Test Requirement: 15.205

The frequency spectrum **above 1 GHz** was investigated. All emissions not reported below are more than 45 dB below the prescribed limits. Readings are both peak and average values.

| | | | |
|------------------------|-----------------------|-------------|-------------|
| Operation Mode: | Transmitting | Test Date : | 2003/2/10 |
| Fundamental Frequency: | 2412MHz (CH 1) | Test By: | Roger Sheng |
| Temperature : | 22 | Humidity : | 65% |

| Freq. (MHz) | Reading (dBuV) | AF (dBuV) | Cable (dB) | Pre-amp (dB) | Dist (dB) | Filter (dB) | Level (dBuV/m) | Limit at 3m (dBuV/m) | Margin (dB) | Mark (P/Q/A) | Pol (H/V) | Height (Meter) |
|----------------|-------------------|--------------|---------------|-----------------|--------------|----------------|-------------------|-------------------------|----------------|-----------------|--------------|-------------------|
| 4824.01* | 48.30 | 34.438 | 2.77 | 35.38 | 9.5 | 1 | 41.63 | 74 | -32.37 | P | H | 1.0 |
| 4824.01* | 43.40 | 34.438 | 2.77 | 35.38 | 9.5 | 1 | 36.73 | 54 | -17.27 | A | H | 1.0 |
| 5579.41 | 49.72 | 36.427 | 3.88 | 35.48 | 9.5 | 1 | 46.04 | 74 | -27.96 | P | H | 1.2 |
| 5579.41 | 44.14 | 36.427 | 3.88 | 35.48 | 9.5 | 1 | 40.46 | 54 | -13.54 | A | H | 1.2 |
| 6335.91 | 50.67 | 37.772 | 4.27 | 35.54 | 9.5 | 1 | 48.67 | 74 | -25.33 | P | H | 1.2 |
| 6335.91 | 47.24 | 37.772 | 4.27 | 35.54 | 9.5 | 1 | 45.24 | 54 | -8.76 | A | H | 1.2 |
| 7238.26 | 43.66 | 39.805 | 3.95 | 35.56 | 9.5 | 1 | 43.35 | 74 | -30.65 | P | H | 1.0 |
| 7238.26 | 31.54 | 39.805 | 3.95 | 35.56 | 9.5 | 1 | 31.23 | 54 | -22.77 | A | H | 1.0 |
| 9648.05 | 47.24 | 38.535 | 4.10 | 35.67 | 9.5 | 1 | 45.70 | 74 | -28.30 | P | H | 1.0 |
| 9648.05 | 39.74 | 38.535 | 4.10 | 35.67 | 9.5 | 1 | 38.20 | 54 | -15.80 | A | H | 1.0 |
| 12059.93* | --- | 42.60 | 15.20 | 35.30 | 9.5 | 1 | --- | --- | --- | --- | H | 1.0 |
| 14471.97* | --- | 43.40 | 16.80 | 34.00 | 9.5 | 1 | --- | --- | --- | --- | H | 1.0 |
| 16884.01 | --- | 45.20 | 17.60 | 34.30 | 9.5 | 1 | --- | --- | --- | --- | H | 1.0 |
| 19296.05* | --- | 36.30 | 18.50 | 34.30 | 9.5 | 1 | --- | --- | --- | --- | H | 1.0 |
| 21708.09 | --- | 36.20 | 19.20 | 34.60 | 9.5 | 1 | --- | --- | --- | --- | H | 1.0 |
| 24120.13 | --- | 36.80 | 21.00 | 34.20 | 9.5 | 1 | --- | --- | --- | --- | H | 1.0 |

Note :

- The measurement was searched to 10th harmonic, Remark “---” means that the emissions level is too low to be measured.
- AF: Antenna Factor, Cable: Cable Loss, Pre-Amp: Pre Amplifier Gain, Dist :correction to extra plate
 reading to 3m specification distance 1m measurement distance = -9.5dB
 Filter: High Pass Filter Insertion Loss (3.5GHz)
- Analyzer setting P(Peak): RBW=1MHz, VBW=1MHz, A(Average): RBW=1MHz, VBW=10Hz
- Remark “*” means that Restricted band.
- The result basic equation calculation is as follow:
 Level=Reading+AF+Closs-Preamp+Filter-Dist
 Margin=Level-Limit



Test Requirement: 15.205

The frequency spectrum **above 1 GHz** was investigated. All emissions not reported below are more than 45 dB below the prescribed limits. Readings are both peak and average values.

| | | | |
|------------------------|--------------------------|-------------|-------------|
| Operation Mode: | Transmitting (TX) | Test Date : | 2003/2/10 |
| Fundamental Frequency: | 2412MHz (CH 1) | Test By: | Roger Sheng |
| Temperature : | 22 | Humidity : | 65% |

| Freq. (MHz) | Reading (dBuV) | AF (dBuV) | Cable (dB) | Pre-amp (dB) | Dist (dB) | Filter (dB) | Level (dBuV/m) | Limit at 3m (dBuV/m) | Margin (dB) | Mark (P/O/A) | Pol (H/V) | Height (Meter) |
|----------------|-------------------|--------------|---------------|-----------------|--------------|----------------|-------------------|-------------------------|----------------|-----------------|--------------|-------------------|
| 4824* | 53.46 | 34.438 | 2.77 | 35.38 | 9.5 | 1 | 46.79 | 74 | -27.21 | P | V | 1.0 |
| 4824* | 50.76 | 34.438 | 2.77 | 35.38 | 9.5 | 1 | 44.09 | 54 | -9.91 | A | V | 1.0 |
| 5579.4 | 60.30 | 36.427 | 3.88 | 35.48 | 9.5 | 1 | 56.62 | 74 | -17.38 | P | V | 1.2 |
| 5579.4 | 55.15 | 36.427 | 3.88 | 35.48 | 9.5 | 1 | 51.47 | 54 | -2.53 | A | V | 1.2 |
| 6335.9 | 56.13 | 37.772 | 4.27 | 35.54 | 9.5 | 1 | 54.13 | 74 | -19.87 | P | V | 1.2 |
| 6335.9 | 52.76 | 37.772 | 4.27 | 35.54 | 9.5 | 1 | 50.76 | 54 | -3.24 | A | V | 1.2 |
| 7238.26 | 44.67 | 39.805 | 3.95 | 35.56 | 9.5 | 1 | 44.36 | 74 | -29.64 | P | V | 1.0 |
| 7238.26 | 32.38 | 39.805 | 3.95 | 35.56 | 9.5 | 1 | 32.07 | 54 | -21.93 | A | V | 1.0 |
| 9648.05 | 48.82 | 38.535 | 4.10 | 35.67 | 9.5 | 1 | 47.28 | 74 | -26.72 | P | V | 1.0 |
| 9648.05 | 42.21 | 38.535 | 4.10 | 35.67 | 9.5 | 1 | 40.67 | 54 | -13.33 | A | V | 1.0 |
| 12059.93* | --- | 42.60 | 15.20 | 35.30 | 9.5 | 1 | --- | --- | --- | --- | V | 1.0 |
| 14471.97* | --- | 43.40 | 16.80 | 34.00 | 9.5 | 1 | --- | --- | --- | --- | V | 1.0 |
| 16884.01 | --- | 45.20 | 17.60 | 34.30 | 9.5 | 1 | --- | --- | --- | --- | V | 1.0 |
| 19296.05* | --- | 36.30 | 18.50 | 34.30 | 9.5 | 1 | --- | --- | --- | --- | V | 1.0 |
| 21708.09 | --- | 36.20 | 19.20 | 34.60 | 9.5 | 1 | --- | --- | --- | --- | V | 1.0 |
| 24120.13 | --- | 36.80 | 21.00 | 34.20 | 9.5 | 1 | --- | --- | --- | --- | V | 1.0 |

Note :

- The measurement was searched to 10th harmonic, Remark “---” means that the emissions level is too low to be measured.
- AF: Antenna Factor, Cable: Cable Loss, Pre-Amp: Pre Amplifier Gain, Dist :correction to extra plate
 reading to 3m specification distance 1m measurement distance = -9.5dB
 Filter: High Pass Filter Insertion Loss (3.5GHz)
- Analyzer setting P(Peak): RBW=1MHz, VBW=1MHz, A(Average): RBW=1MHz, VBW=10Hz
- Remark “*” means that Restricted band.
- The result basic equation calculation is as follow:
 $Level=Reading+AF+Closs-Preamp+Filter-Dist, Margin=Level-Limit$



Test Requirement: 15.205

The frequency spectrum **above 1 GHz** was investigated. All emissions not reported below are more than 45 dB below the prescribed limits. Readings are both peak and average values.

| | | | |
|------------------------|-------------------------|-------------|-------------|
| Operation Mode: | Transmitting(TX) | Test Date : | 2003/2/10 |
| Fundamental Frequency: | 2437MHz (CH 6) | Test By: | Roger Sheng |
| Temperature : | 22 | Humidity : | 65% |

| Freq. (MHz) | Reading (dBuV) | AF (dBuV) | Cable (dB) | Pre-amp (dB) | Dist (dB) | Filter (dB) | Level (dBuV/m) | Limit at 3m (dBuV/m) | Margin (dB) | Mark (P/Q/A) | Pol (H/V) | Height (Meter) |
|----------------|-------------------|--------------|---------------|-----------------|--------------|----------------|-------------------|-------------------------|----------------|-----------------|--------------|-------------------|
| 4873.38* | 48.72 | 34.764 | 2.80 | 35.40 | 9.5 | 1 | 42.39 | 74 | -31.61 | P | H | 1.0 |
| 4873.85* | 42.21 | 34.767 | 2.80 | 35.40 | 9.5 | 1 | 35.88 | 54 | -18.12 | A | H | 1.0 |
| 5605.88 | 48.56 | 36.469 | 3.96 | 35.48 | 9.5 | 1 | 45.01 | 74 | -28.99 | P | H | 1.2 |
| 5605.88 | 40.63 | 36.469 | 3.96 | 35.48 | 9.5 | 1 | 37.08 | 54 | -16.92 | A | H | 1.2 |
| 6336.01 | 51.16 | 37.772 | 4.27 | 35.54 | 9.5 | 1 | 49.16 | 74 | -24.84 | P | H | 1.2 |
| 6336.01 | 46.32 | 37.772 | 4.27 | 35.54 | 9.5 | 1 | 44.32 | 54 | -9.68 | A | H | 1.2 |
| 7311.01* | 46.34 | 39.776 | 4.00 | 35.57 | 9.5 | 1 | 46.05 | 74 | -27.95 | P | H | 1.0 |
| 7311.01* | 36.44 | 39.776 | 4.00 | 35.57 | 9.5 | 1 | 36.15 | 54 | -17.85 | A | H | 1.0 |
| 9748.01 | 45.33 | 38.525 | 4.02 | 35.72 | 9.5 | 1 | 43.65 | 74 | -30.35 | P | H | 1.0 |
| 9748.01 | 37.68 | 38.525 | 4.02 | 35.72 | 9.5 | 1 | 36.00 | 54 | -18.00 | A | H | 1.0 |
| 12185.10* | --- | 32.14 | 4.53 | 35.24 | 9.5 | 1 | --- | --- | --- | --- | H | 1.0 |
| 14622.12 | --- | 43.40 | 16.80 | 34.00 | 9.5 | 1 | --- | --- | --- | --- | H | 1.0 |
| 17059.14 | --- | 45.20 | 17.60 | 34.30 | 9.5 | 1 | --- | --- | --- | --- | H | 1.0 |
| 19496.16* | --- | 36.30 | 18.50 | 34.30 | 9.5 | 1 | --- | --- | --- | --- | H | 1.0 |
| 21933.18 | --- | 36.20 | 19.20 | 34.60 | 9.5 | 1 | --- | --- | --- | --- | H | 1.0 |
| 24370.20 | --- | 36.80 | 21.00 | 34.20 | 9.5 | 1 | --- | --- | --- | --- | H | 1.0 |

Note :

- The measurement was searched to 10th harmonic, Remark “---” means that the emissions level is too low to be measured
- AF: Antenna Factor, cable: Cable Loss, Pre-Amp: Pre Amplifier Gain, Dist :correction to extra plate reading to 3m specification distance 1m measurement distance = -9.5dB
 Filter: High Pass Filter Insertion Loss (3.5GHz)
- Analyzer setting P(Peak): RBW=1MHz, VBW=1MHz, A(Average): RBW=1MHz, VBW=10Hz
- Remark “*” means that Restricted band.
- The result basic equation calculation is as follow:
 $Level=Reading+AF+Loss+Preamp+Filter-Dist, Margin=Level-Limit$



Test Requirement: 15.205

The frequency spectrum **above 1 GHz** was investigated. All emissions not reported below are more than 45 dB below the prescribed limits. Readings are both peak and average values.

| | | | |
|------------------------|--------------------------|-------------|-------------|
| Operation Mode: | Transmitting (TX) | Test Date : | 2003/2/10 |
| Fundamental Frequency: | 2437MHz (CH 6) | Test By: | Roger Sheng |
| Temperature : | 22 | Humidity : | 65% |

| Freq. (MHz) | Reading (dBuV) | AF (dBuV) | Cable (dB) | Pre-amp (dB) | Dist dB | Filter dB | Level (dBuV/m) | Limit at 3m (dBuV/m) | Margin (dB) | Mark (P/Q/A) | Pol (H/V) | Height (Meter) |
|----------------|-------------------|--------------|---------------|-----------------|------------|--------------|-------------------|-------------------------|----------------|-----------------|--------------|-------------------|
| 4873.38* | 56.73 | 34.764 | 2.80 | 35.40 | 9.5 | 1 | 50.40 | 74 | -23.60 | P | V | 1.0 |
| 4873.85* | 55.01 | 34.767 | 2.80 | 35.40 | 9.5 | 1 | 48.68 | 54 | -5.32 | A | V | 1.0 |
| 5605.88 | 60.83 | 36.469 | 3.96 | 35.48 | 9.5 | 1 | 57.28 | 74 | -16.72 | P | V | 1.2 |
| 5605.88 | 54.94 | 36.469 | 3.96 | 35.48 | 9.5 | 1 | 51.39 | 54 | -2.61 | A | V | 1.2 |
| 6336.00 | 55.23 | 37.772 | 4.27 | 35.54 | 9.5 | 1 | 53.23 | 74 | -20.77 | P | V | 1.2 |
| 6336.00 | 53.25 | 37.772 | 4.27 | 35.54 | 9.5 | 1 | 51.25 | 54 | -2.75 | A | V | 1.2 |
| 7311.01* | 48.57 | 39.776 | 4.00 | 35.57 | 9.5 | 1 | 48.28 | 74 | -25.72 | P | V | 1.0 |
| 7311.01* | 37.71 | 39.776 | 4.00 | 35.57 | 9.5 | 1 | 37.42 | 54 | -16.58 | A | V | 1.0 |
| 9748.01 | 47.79 | 38.525 | 4.02 | 35.72 | 9.5 | 1 | 46.11 | 74 | -27.89 | P | V | 1.0 |
| 9748.01 | 39.48 | 38.525 | 4.02 | 35.72 | 9.5 | 1 | 37.80 | 54 | -16.20 | A | V | 1.0 |
| 12185.10* | --- | 32.14 | 4.53 | 35.24 | 9.5 | 1 | --- | --- | --- | P | V | 1.0 |
| 14622.12 | --- | 43.40 | 16.80 | 34.00 | 9.5 | 1 | --- | --- | --- | A | V | 1.0 |
| 17059.14 | --- | 45.20 | 17.60 | 34.30 | 9.5 | 1 | --- | --- | --- | P | V | 1.0 |
| 19496.16* | --- | 36.30 | 18.50 | 34.30 | 9.5 | 1 | --- | --- | --- | A | V | 1.0 |
| 21933.18 | --- | 36.20 | 19.20 | 34.60 | 9.5 | 1 | --- | --- | --- | P | V | 1.0 |
| 24370.20 | --- | 36.80 | 21.00 | 34.20 | 9.5 | 1 | --- | --- | --- | A | V | 1.0 |

Note :

- The measurement was searched to 10th harmonic, Remark “---” means that the emissions level is too low to be measured.
- AF: Antenna Factor, Cable: Cable Loss, Pre-Amp: Pre Amplifier Gain, Dist : correction to extra plate reading to 3m specification distance 1m measurement distance = -9.5dB
 Filter: High Pass Filter Insertion Loss (3.5GHz)
- Analyzer setting P(Peak): RBW=1MHz, VBW=1MHz, A(Average): RBW=1MHz, VBW=10Hz
- Remark “*” means that Restricted band.
- The result basic equation calculation is as follow:
 $Level = Reading + AF + Closs - Preamp + Filter - Dist, Margin = Level - Limit$



Test Requirement: 15.205

The frequency spectrum **above 1 GHz** was investigated. All emissions not reported below are more than 45 dB below the prescribed limits. Readings are both peak and average values.

| | | | |
|------------------------|--------------------------|-------------|-------------|
| Operation Mode: | Transmitting (TX) | Test Date : | 2003/2/10 |
| Fundamental Frequency: | 2462MHz (CH 11) | Test By: | Roger Sheng |
| Temperature : | 22 | Humidity : | 65% |

| Freq. (MHz) | Reading (dBuV) | AF (dBuV) | Cable (dB) | Pre-amp (dB) | Dist dB | Filter dB | Level (dBuV/mat 3m (dBuV/m) | Limit (dB) | Margin (dB) | Mark (P/Q/A) | Pol (H/V) | Height (Meter) |
|----------------|-------------------|--------------|---------------|-----------------|------------|--------------|--------------------------------|---------------|----------------|-----------------|--------------|-------------------|
| 4923.39* | 48.71 | 35.09 | 2.83 | 35.41 | 9.5 | 1 | 42.72 | 74 | -31.28 | P | H | 1.0 |
| 4923.39* | 41.17 | 35.09 | 2.83 | 35.41 | 9.5 | 1 | 35.18 | 54 | -18.82 | A | H | 1.0 |
| 5627.43 | 48.76 | 36.51 | 4.04 | 35.49 | 9.5 | 1 | 45.31 | 74 | -28.69 | P | H | 1.2 |
| 5627.43 | 40.94 | 36.51 | 4.04 | 35.49 | 9.5 | 1 | 37.49 | 54 | -16.51 | A | H | 1.2 |
| 6335.91 | 49.71 | 37.77 | 4.27 | 35.54 | 9.5 | 1 | 47.71 | 74 | -26.29 | P | H | 1.2 |
| 6335.91 | 44.91 | 37.77 | 4.27 | 35.54 | 9.5 | 1 | 42.90 | 54 | -11.10 | A | H | 1.2 |
| 7383.19* | 47.51 | 39.75 | 4.06 | 35.57 | 9.5 | 1 | 47.24 | 74 | -26.76 | P | H | 1.0 |
| 7383.19 | 35.88 | 39.75 | 4.06 | 35.57 | 9.5 | 1 | 35.61 | 54 | -18.39 | A | H | 1.0 |
| 9848.01 | 46.01 | 38.52 | 3.93 | 35.77 | 9.5 | 1 | 44.19 | 74 | -29.81 | P | H | 1.0 |
| 9848.01 | 37.92 | 38.52 | 3.93 | 35.77 | 9.5 | 1 | 36.10 | 54 | -17.90 | A | H | 1.0 |
| 12310.04* | --- | 32.14 | 4.53 | 35.24 | 9.5 | 1 | --- | --- | --- | --- | H | 1.0 |
| 14772.06 | --- | 43.40 | 16.80 | 34.00 | 9.5 | 1 | --- | --- | --- | --- | H | 1.0 |
| 17234.08 | --- | 45.20 | 17.60 | 34.30 | 9.5 | 1 | --- | --- | --- | --- | H | 1.0 |
| 19696.11* | --- | 36.30 | 18.50 | 34.30 | 9.5 | 1 | --- | --- | --- | --- | H | 1.0 |
| 22158.12* | --- | 36.20 | 19.20 | 34.60 | 9.5 | 1 | --- | --- | --- | --- | H | 1.0 |
| 24620.14 | --- | 36.80 | 21.00 | 34.20 | 9.5 | 1 | --- | --- | --- | --- | H | 1.0 |

Note :

- The measurement was searched to 10th harmonic, Remark “---” means that the emissions level is too low to be measured.
- AF: Antenna Factor, Cable: Cable Loss, Pre-Amp: Pre Amplifier Gain, Dist :correction to extra plate
 reading to 3m specification distance 1m measurement distance = -9.5dB
 Filter: High Pass Filter Insertion Loss (3.5GHz)
- Analyzer setting P(Peak): RBW=1MHz, VBW=1MHz, A(Average): RBW=1MHz, VBW=10Hz
- Remark “*” means that Restricted band.
- The result basic equation calculation is as follow:
 Level=Reading+AF+Closs-Preamp+Filter-Dist
 Margin=Level-Limit



Test Requirement: 15.205

The frequency spectrum **above 1 GHz** was investigated. All emissions not reported below are more than 45 dB below the prescribed limits. Readings are both peak and average values.

| | | | |
|------------------------|--------------------------|-------------|-------------|
| Operation Mode: | Transmitting (TX) | Test Date : | 2003/2/10 |
| Fundamental Frequency: | 2462MHz (CH 11) | Test By: | Roger Sheng |
| Temperature : | 22 | Humidity : | 65% |

| Freq. (MHz) | Reading (dBuV) | AF (dBuV) | Cable (dB) | Pre-amp (dB) | Dist dB | Filter dB | Level (dBuV/m) | Limit at 3m (dBuV/m) | Margin (dB) | Mark (P/O/A) | Pol (H/V) | Height (Meter) |
|----------------|-------------------|--------------|---------------|-----------------|------------|--------------|-------------------|-------------------------|----------------|-----------------|--------------|-------------------|
| 4923.39* | 55.64 | 35.0944 | 2.83 | 35.41 | 9.5 | 1 | 49.65 | 74 | -24.35 | P | V | 1.0 |
| 4923.39* | 53.38 | 35.0944 | 2.83 | 35.41 | 9.5 | 1 | 47.39 | 54 | -6.61 | A | V | 1.0 |
| 5627.43 | 57.85 | 36.5039 | 4.04 | 35.49 | 9.5 | 1 | 54.40 | 74 | -19.60 | P | V | 1.2 |
| 5627.43 | 53.23 | 36.5039 | 4.04 | 35.49 | 9.5 | 1 | 49.78 | 54 | -4.22 | A | V | 1.2 |
| 6335.9 | 54.98 | 37.7718 | 4.27 | 35.54 | 9.5 | 1 | 52.98 | 74 | -21.02 | P | V | 1.2 |
| 6335.9 | 52.8 | 37.7718 | 4.27 | 35.54 | 9.5 | 1 | 50.80 | 54 | -3.20 | A | V | 1.2 |
| 7383.19* | 48.67 | 39.7467 | 4.06 | 35.57 | 9.5 | 1 | 48.40 | 74 | -25.60 | P | V | 1.0 |
| 7383.19* | 36.89 | 39.7467 | 4.06 | 35.57 | 9.5 | 1 | 36.62 | 54 | -17.38 | A | V | 1.0 |
| 9848.01 | 46.47 | 38.5152 | 3.93 | 35.77 | 9.5 | 1 | 44.65 | 74 | -29.35 | P | V | 1.0 |
| 9848.01 | 38.82 | 38.52 | 3.93 | 35.774 | 9.5 | 1 | 37.00 | 54 | -17.00 | A | V | 1.0 |
| 12310.04* | --- | 32.14 | 4.53 | 35.24 | 9.5 | 1 | --- | --- | --- | --- | V | 1.0 |
| 14772.06 | --- | 43.40 | 16.80 | 34.00 | 9.5 | 1 | --- | --- | --- | --- | V | 1.0 |
| 17234.08 | --- | 45.20 | 17.60 | 34.30 | 9.5 | 1 | --- | --- | --- | --- | V | 1.0 |
| 19696.1* | --- | 36.30 | 18.50 | 34.30 | 9.5 | 1 | --- | --- | --- | --- | V | 1.0 |
| 22158.12* | --- | 36.20 | 19.20 | 34.60 | 9.5 | 1 | --- | --- | --- | --- | V | 1.0 |
| 24620.14 | --- | 36.80 | 21.00 | 34.20 | 9.5 | 1 | --- | --- | --- | --- | V | 1.0 |

Note :

- The measurement was searched to 10th harmonic, Remark “---” means that the emissions level is too low to be measured.
- AF: Antenna Factor, Cable: Cable Loss, Pre-Amp: Pre Amplifier Gain, Dist :correction to extra plate
 reading to 3m specification distance 1m measurement distance = -9.5dB
 Filter: High Pass Filter Insertion Loss (3.5GHz)
- Analyzer setting P(Peak): RBW=1MHz, VBW=1MHz, A(Average): RBW=1MHz, VBW=10Hz
- Remark “*” means that Restricted band.
- The result basic equation calculation is as follow:
 Level=Reading+AF+Closs-Preamp+Filter-Dist
 Margin=Level-Limit



3.7 PHOTOS OF OPEN SITE





Industrial Technology Research Institute

Electronics Research & Service Organization

Bldg. 17, 195-4 Sec. 4, Chung Hsing Rd., Chutung, Hsinchu, 310

Taiwan, Republic Of China

TEL : 886-3-5917069 FAX : 886-3-5825720

FCC ID : ID4-NEC-LITEPAD

Report No. : 510-9201-057-1F

Page 29 of 41





4. 6dB BANDWIDTH MEASUREMENT

4.1 TEST EQUIPMENTS

| Description & Manufacturer | Model No. | Serial No. | DATE OF CALIBRATION |
|-------------------------------|-----------|--------------------------|---------------------|
| ROHDE & SCHWARZ TEST RECEIVER | ESMI | 842088/005 841978/008 | SEPT. 3, 2002 |
| HP ATTENUATOR | 8496B | 3247A18505 | Cal. on use |
| HP PLOTTER | 7750A | 725A 852141 | N/A |

NOTE :

1. The measurement uncertainty is less than +/- 2.6dB, which is calculated as per the NAMAS document NIS81.
2. The calibration interval of the above test instruments is 12 months and the calibrations are traceable to NML/ROC and NIST/USA.

4.2 TEST SETUP

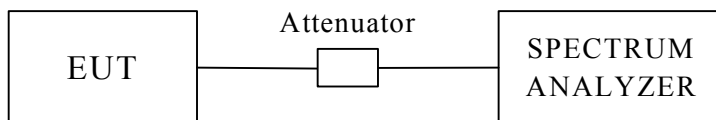

4.3 LIMITS OF 6dB BANDWIDTH MEASUREMENT

The minimum of 6dB Bandwidth Measurement is >500KHz

4.4 TEST PROCEDURE

The transmitter output was connected to the spectrum analyzer through an attenuator. The bandwidth of the fundamental frequency was measured by spectrum analyzer with 100 KHz RBW and 100 KHz VBW. The 6dB bandwidth is defined as the total spectrum the power of which is higher than peak power minus 6dB.

4.5 UNCERTAINTY OF CONDUCTED EMISSION

The uncertainty of conducted emission is ± 200 KHz.



4.6 TEST RESULTS

| | | | |
|--------------------------------|---|---------------------------------|-------------------|
| EUT | Tablet PC with built-in 802.11a&b Wireless LAN module | MODEL | NEC VERSA Litepad |
| INPUT POWER (SYSTEM) | 12VDC(From Adapter) | ENVIRONMENTAL CONDITIONS | 27 , 70%RH, |
| TESTED BY : Roger Sheng | | | |

| CHANNEL | CHANNEL FREQUENCY (MHz) | 6dB BANDWIDTH (MHz) | MINIMUM LIMIT (MHz) | PASS / FAIL |
|----------------|--------------------------------|----------------------------|----------------------------|--------------------|
| 1 | 2412 | 13.02 | 0.5 | PASS |
| 6 | 2437 | 12.04 | 0.5 | PASS |
| 11 | 2462 | 13.00 | 0.5 | PASS |



4.7 PHOTO OF 6DB BANDWIDTH MEASUREMENT

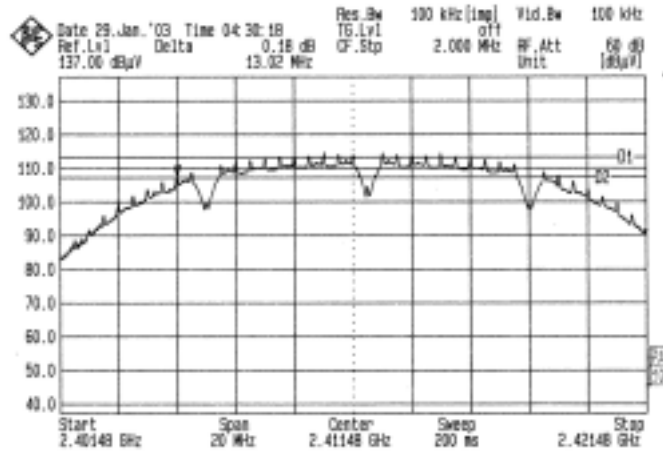

Channel 1

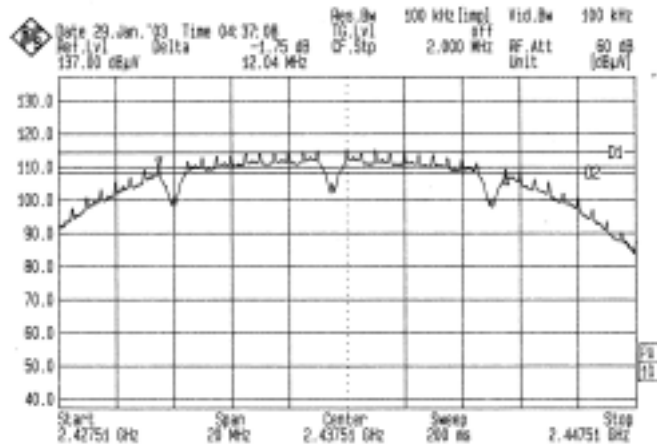

Channel 6

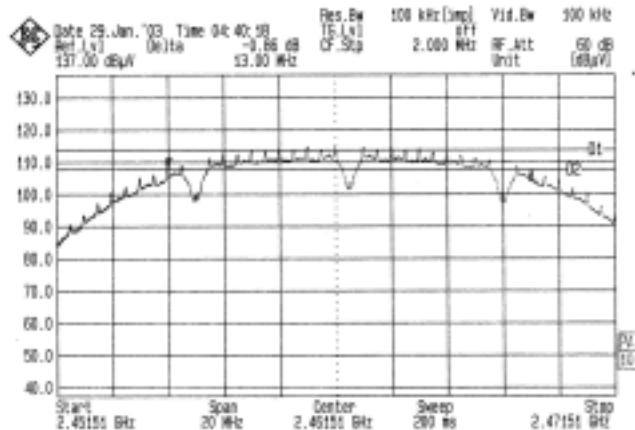

Channel 11



5. MAXIMUM PEAK OUTPUT POWER

5.1 TEST EQUIPMENTS

| Description & Manufacturer | Model No. | Serial No. | DATE OF CALIBRATION |
|-------------------------------|-----------|--------------------------|---------------------|
| ROHDE & SCHWARZ TEST RECEIVER | ESMI | 842088/005 841978/008 | SEPT. 3, 2002 |
| HP ATTENUATOR | 8496B | 3247A18505 | Cal. on use |
| HP PLOTTER | 7750A | 725A 852141 | N/A |

NOTE :

1. The measurement uncertainty is less than +/- 2.6dB, which is calculated as per the NAMAS document NIS81.
2. The calibration interval of the above test instruments is 12 months and the calibrations are traceable to NML/ROC and NIST/USA.

5.2 TEST SETUP

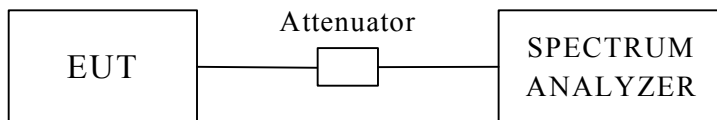

5.3 LIMITS OF MAXIMUM PEAK OUTPUT POWER

The Maximum Peak Output Power Measurement is 30dBm.



5.4 TEST PROCEDURE

The RF power output was measured with a Power meter connected to the RF Antenna connector (conducted measurement) while EUT was operating in transmit mode at the appropriate center frequency.

5.5 UNCERTAINTY OF CONDUCTED EMISSION

The uncertainty of conducted emission is ± 1.82 dB.

5.6 TEST RESULTS

| | | | |
|--------------------------------|---|---------------------------------|-------------------|
| EUT | Tablet PC with built-in 802.11a&b Wireless LAN module | MODEL | NEC VERSA Litepad |
| INPUT POWER (SYSTEM) | 12VDC(From Adapter) | ENVIRONMENTAL CONDITIONS | 27 , 70%RH, |
| TESTED BY : Roger Sheng | | | |

| CHANNEL | CHANNEL FREQUENCY (MHz) | PEAK POWER OUTPUT (dBm) | PEAK POWER LIMIT (dBm) | PASS / FAIL |
|----------------|--------------------------------|--------------------------------|-------------------------------|--------------------|
| 1 | 2412 | 15.50 | 30 | PASS |
| 6 | 2437 | 16.95 | 30 | PASS |
| 11 | 2462 | 17.50 | 30 | PASS |



6. POWER SPECTRAL DENSITY MEASUREMENT

6.1 TEST EQUIPMENTS

| Description & Manufacturer | Model No. | Serial No. | DATE OF CALIBRATION |
|-------------------------------|-----------|--------------------------|---------------------|
| ROHDE & SCHWARZ TEST RECEIVER | ESMI | 842088/005 841978/008 | SEPT. 3, 2002 |
| HP ATTENUATOR | 8496B | 3247A18505 | Cal. on use |
| HP PLOTTER | 7750A | 725A 852141 | N/A |

NOTE :

1. The measurement uncertainty is less than +/- 2.6dB, which is calculated as per the NAMAS document NIS81.
2. The calibration interval of the above test instruments is 12 months and the calibrations are traceable to NML/ROC and NIST/USA.

6.2 TEST SETUP

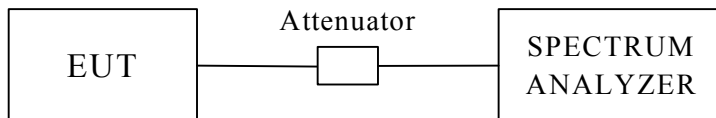

6.3 LIMITS OF POWER SPECTRAL DENSITY MEASUREMENT

The Maximum Power Spectral Density Measurement is 8dBm.



6.4 TEST PROCEDURE

The transmitter output was connected to the spectrum analyzer through an attenuator, the bandwidth of the fundamental frequency was measured with the spectrum analyzer using 3KHz RBW and 30KHz VBW, set sweep time=span / 3KHz.

The power spectral density was measured and recorded.

The sweep time is allowed to be longer than span / 3KHz for a full response of the mixer in the spectrum analyzer.

6.5 UNCERTAINTY OF CONDUCTED EMISSION

The uncertainty of conducted emission is ± 1.82 dB.

6.6 TEST RESULTS

| | | | |
|--------------------------------|---|---------------------------------|-------------------|
| EUT | Tablet PC with built-in 802.11a&b Wireless LAN module | MODEL | NEC VERSA Litepad |
| INPUT POWER (SYSTEM) | 12VDC(From Adapter) | ENVIRONMENTAL CONDITIONS | 27 , 70%RH, |
| TESTED BY : Roger Sheng | | | |

| CHANNEL | CHANNEL FREQUENCY (MHz) | Final RF Power Level IN 3KHz BW (dBm) | MAXIMUM LIMIT (dBm) | PASS / FAIL |
|----------------|--------------------------------|--|----------------------------|--------------------|
| 1 | 2412 | -3.09 | 8 | PASS |
| 6 | 2437 | -5.04 | 8 | PASS |
| 11 | 2462 | -4.71 | 8 | PASS |

Note:

- 1.The measurement value of RF Power Level + 10dB attenuator=Final RF Power Level



6.7 PHOTO OF POWER SPECTRAL DENSITY MEASUREMENT

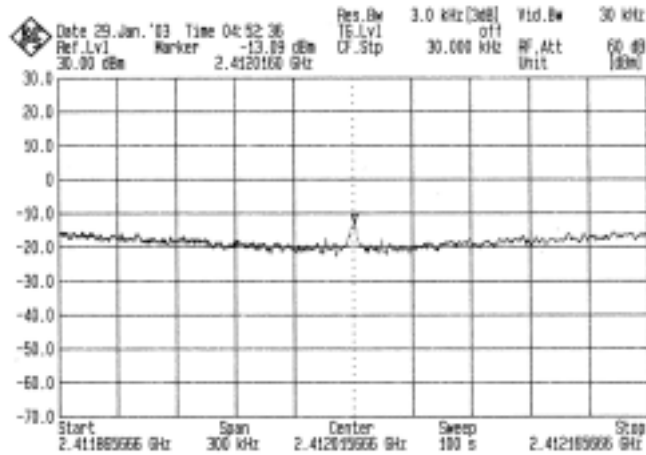

Channel 1

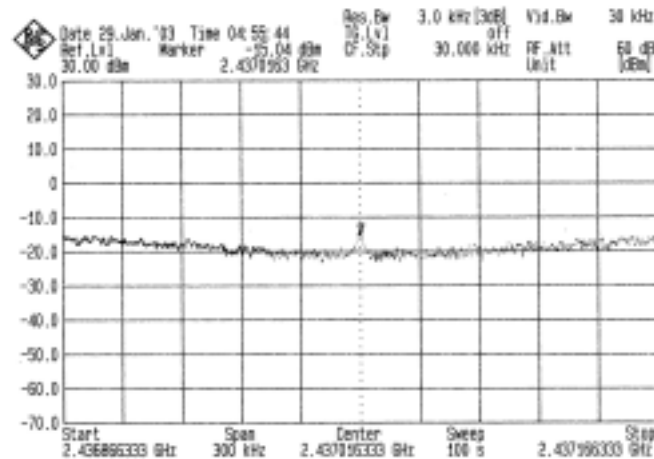

Channel 6

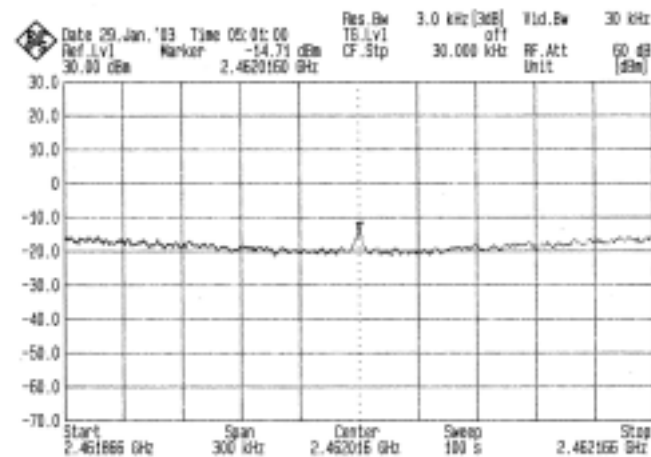

Channel 11



7. OUT OF BAND MEASUREMENT

7.1 TEST EQUIPMENTS

| Description & Manufacturer | Model No. | Serial No. | DATE OF CALIBRATION |
|-------------------------------|-----------|--------------------------|---------------------|
| ROHDE & SCHWARZ TEST RECEIVER | ESMI | 842088/005 841978/008 | SEPT. 3, 2002 |
| HP ATTENUATOR | 8496B | 3247A18505 | Cal. on use |
| HP PLOTTER | 7750A | 725A 852141 | N/A |

NOTE :

1. The measurement uncertainty is less than +/- 2.6dB, which is calculated as per the NAMAS document NIS81.
2. The calibration interval of the above test instruments is 12 months and the calibrations are traceable to NML/ROC and NIST/USA.

7.2 TEST SETUP

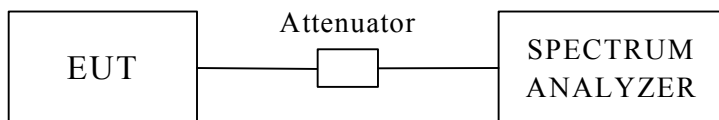

7.3 LIMITS OF OUT OF BAND EMISSIONS MEASUREMENT

1. Below -20dB of the highest emission level of operating band (in 100KHz Resolution Bandwidth).
2. Fall in the restricted bands listed in section 15.205. The maximum permitted average field strength is listed in section 15.209.

7.4 TEST PROCEDURE

The transmitter output was connected to the spectrum analyzer via a low loss cable. Set both RBW and VBW of spectrum analyzer to 100KHz with suitable frequency span including 100KHz bandwidth from band edge. The band edges was measured and recorded.

7.5 UNCERTAINTY OF CONDUCTED EMISSION

The uncertainty of conducted emission is ± 1.82 dB.



7.6 TEST RESULTS

A. Conducted

Refer to 7.7 photo of out band Emission measurement

B. Radiated

| 2,412.00MHz(CH1) | | | | | | | | | | | | |
|------------------|---------|--------|-------|---------|--------------|------|--------|--------------|-----------------------|--------|---------|-------|
| Freq. | Reading | AF | Closs | Pre-amp | Delta | Dist | Filter | Level | Limit | Margin | Mark | Pol |
| (MHz) | (dBuV) | (dBuV) | (dB) | (dB) | (dB) | dB | dB | (dBuV/m) | At3m (dBuV/m) | (dB) | (P/Q/A) | (H/V) |
| 2336 | ----- | 31.86 | 2.16 | 35.30 | 49.17 | 9.5 | 0 | 53.36 | 74 | -20.64 | P | V |
| 2336 | ----- | 31.86 | 2.16 | 35.30 | | 9.5 | 0 | 50.36 | 54 | -3.64 | A | V |
| ● 2412 | 113.20 | 31.79 | 2.36 | 35.31 | | 9.5 | 0 | 102.53 | Fundamental Frequency | | P | V |
| ● 2412 | 110.20 | 31.79 | 2.36 | 35.31 | | 9.5 | 0 | 99.53 | Fundamental Frequency | | A | V |
| 2336 | ----- | 31.86 | 2.16 | 35.30 | 49.17 | 9.5 | 0 | 47.56 | 74 | -26.44 | P | H |
| 2336 | ----- | 31.86 | 2.16 | 35.30 | | 9.5 | 0 | 44.56 | 54 | -9.44 | A | H |
| ● 2412 | 107.40 | 31.79 | 2.36 | 35.31 | | 9.5 | 0 | 96.73 | Fundamental Frequency | | P | H |
| ● 2412 | 104.40 | 31.79 | 2.36 | 35.31 | | 9.5 | 0 | 93.73 | Fundamental Frequency | | A | H |

NOTE1: The band edge emission plot on the following first figure shows 49.17dB delta between carrier maximum power and local maximum emission in restrict band (at 2336MHz). The **vertical average** emission of carrier strength list in the test result of channel 1 is 99.53dBuV/m, so the maximum field strength in restrict band is 50.36 dBuV/m at 2336MHz which is under 54 dBuV/m limit.

NOTE2: “●” mark means fundamental frequency

| 2,462.00MHz (CH11) | | | | | | | | | | | | |
|--------------------|---------|--------|-------|---------|--------------|------|--------|--------------|-----------------------|--------|---------|-------|
| Freq. | Reading | AF | Closs | Pre-amp | Delta | Dist | Filter | Level | Limit | Margin | Mark | Pol |
| (MHz) | (dBuV) | (dBuV) | (dB) | (dB) | (dB) | dB | dB | (dBuV/m) | At 3m (dBuV/m) | (dB) | (P/Q/A) | (H/V) |
| 2483.5 | ----- | 31.72 | 2.55 | 35.33 | 49.48 | 9.5 | 0 | 54.13 | 74 | -19.87 | P | V |
| 2483.5 | ----- | 31.72 | 2.55 | 35.33 | | 9.5 | 0 | 50.03 | 54 | -3.97 | A | V |
| ● 2462 | 114.20 | 31.74 | 2.49 | 35.32 | | 9.5 | 0 | 103.61 | Fundamental Frequency | | P | V |
| ● 2462 | 110.10 | 31.74 | 2.49 | 35.32 | | 9.5 | 0 | 99.51 | Fundamental Frequency | | A | V |
| 2483.5 | ----- | 31.72 | 2.55 | 35.33 | 49.48 | 9.5 | 0 | 45.20 | 74 | -28.80 | P | H |
| 2483.5 | ----- | 31.72 | 2.55 | 35.33 | | 9.5 | 0 | 41.23 | 54 | -12.77 | A | H |
| ● 2462 | 105.27 | 31.74 | 2.49 | 35.32 | | 9.5 | 0 | 94.68 | Fundamental Frequency | | P | H |
| ● 2462 | 101.30 | 31.74 | 2.49 | 35.32 | | 9.5 | 0 | 90.71 | Fundamental Frequency | | A | H |

NOTE1: The band edge emission plot on the following first figure shows 49.48dB delta between carrier maximum power and local maximum emission in restrict band (at 2483.5 MHz). The **vertical average** emission of carrier strength list in the test result of channel 11 is 99.51dBuV/m, so the maximum field strength in restrict band is 50.03 dBuV/m at 2483.5MHz which is under 54 dBuV/m limit.

NOTE2: “●” mark means fundamental frequency



7.7 PHOTO OF OUT OF BAND MEASUREMENT

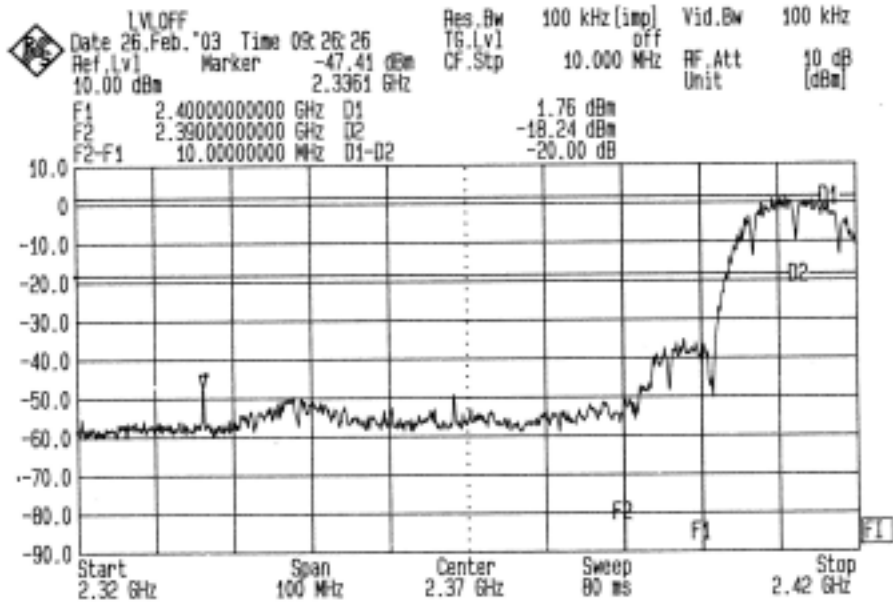

Lower Band Edge

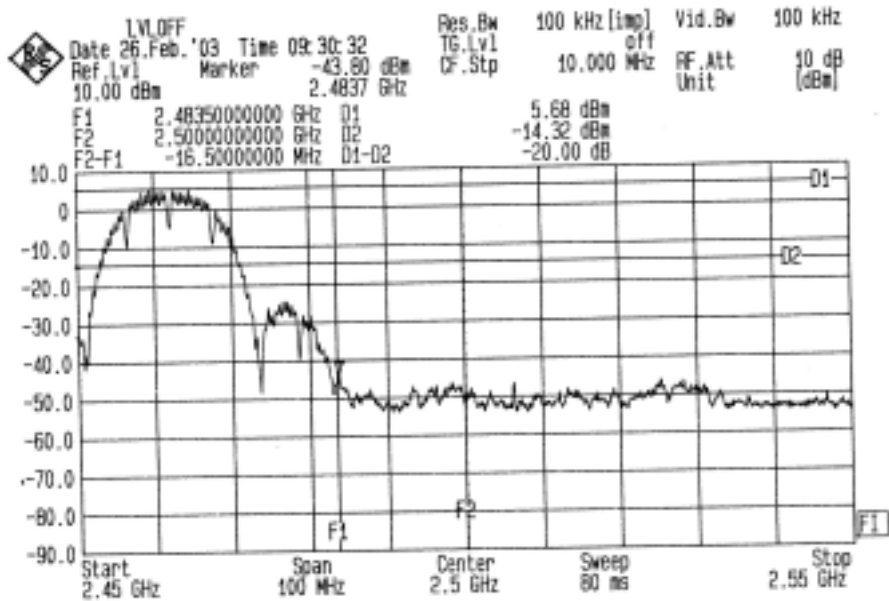

Higher Band Edge



8. ANTENNA REQUIREMENT

8.1 STANDARD APPLICABLE

For intentional device, according to FCC 47 CFR Section 15.203, an intentional radiator shall be designed to ensure that no antenna other than that furnished by the responsible party shall be used with the device.

And according to FCC 47 CFR Section 15.247 (b), if transmitting antennas of directional gain greater than 6dBi are used, the power shall be reduced by the amount in dB that the directional gain of the antenna exceeds 6dBi.

8.2 ANTENNA CONNECTED CONSTRUCTION

The antenna used in this product is PIFA antenna. The PIFA antenna connector is JST And the maximum Gain of these antennas are only -2dBi.