

KIDDESIGNS INC.			
MATERIAL: FR-4	TITLE: Main Board	1 OF 7 PAGE	
PLATING: Tunmeric	MODEL NAME: Walkie Talkie	SCALE: 2.00	
THCKENSS: 1.0mm	MODEL NO.: MS-210	LAYER: Toplayer	
	DWG NO.:PCB_MS-210-01V5	REV:5	Copper thickness:10Z
SIZE:	SCH NO.:SCH_MS-210-01V5	REV:5	Form NO.:ENG-026-A

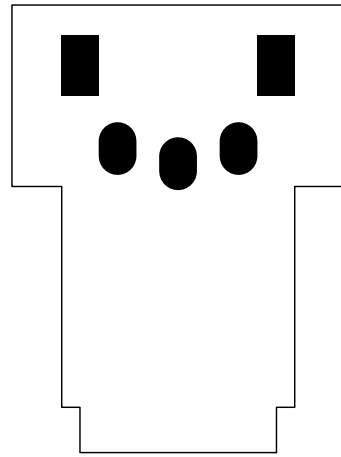

KIDDESIGNS INC.			
MATERIAL: FR-4	TITLE: Main Board	2 OF 7 PAGE	
PLATING: Tunmeric	MODEL NAME: Walkie Talkie	SCALE: 2.00	
THCKENSS: 1.0mm	MODEL NO.: MS-210	LAYER: BottonLayer	
	DWG NO.:PCB_MS-210-01V5	REV:5	Copper thickness:10Z
SIZE:	SCH NO.:SCH_MS-210-01V5	REV:5	Form NO.:ENG-026-A

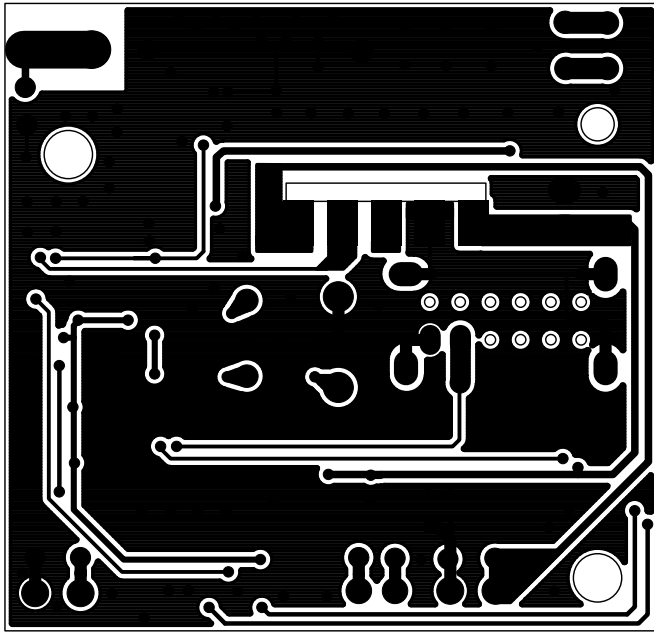
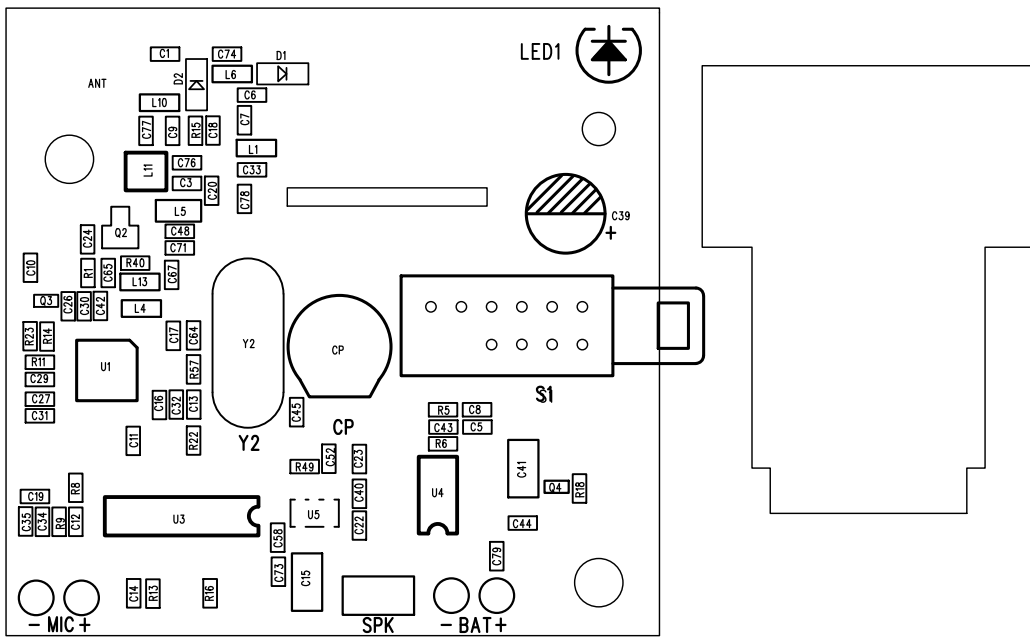

KIDDESIGNS INC.			
MATERIAL: FR-4	TITLE: Main Board	3 OF 7 PAGE	
PLATING: Tunmeric	MODEL NAME: Walkie Talkie	SCALE: 2.00	
THCKENSS: 1.0mm	MODEL NO.: MS-210	LAYER: Top Silkscreen Overlay	
	DWG NO.:PCB_MS-210-01V5	REV:5	Copper thickness:10Z
SIZE:	SCH NO.:SCH_MS-210-01V5	REV:5	Form NO.:ENG-026-A

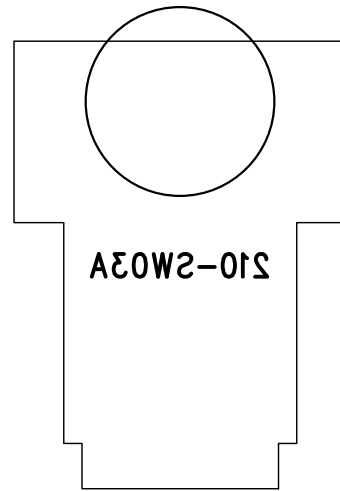
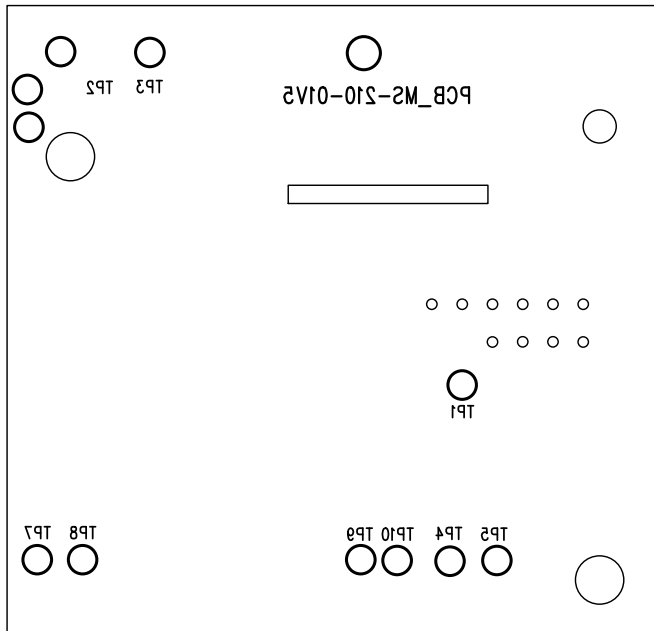

KIDDESIGNS INC.			
MATERIAL: FR-4	TITLE: Main Board	4 OF 7 PAGE	
PLATING: Tunmeric	MODEL NAME: Walkie Talkie	SCALE: 2.00	
THCKENSS: 1.0mm	MODEL NO.: MS-210	LAYER: Bottom Silkscreen Overlay	
	DWG NO.:PCB_MS-210-01V5	REV:5	Copper thickness:10Z
SIZE:	SCH NO.:SCH_MS-210-01V5	REV:5	Form NO.:ENG-026-A

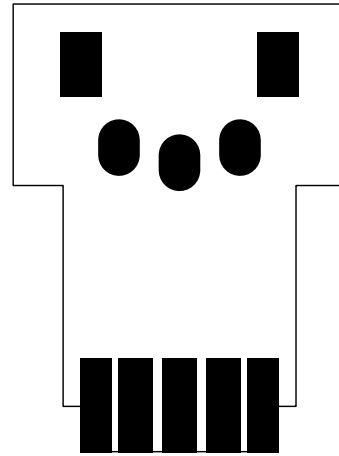
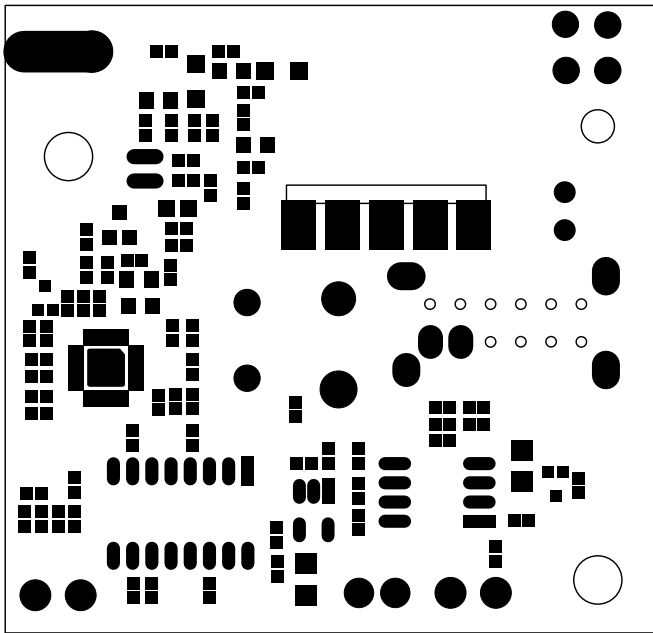

KIDDESIGNS INC.			
MATERIAL: FR-4	TITLE: Main Board	5 OF 7 PAGE	
PLATING: Tunmeric	MODEL NAME: Walkie Talkie	SCALE: 2.00	
THCKENSS: 1.0mm	MODEL NO.: MS-210	LAYER: Top Soider Mask	
	DWG NO.:PCB_MS-210-01V5	REV:5	Copper thickness:10Z
SIZE:	SCH NO.:SCH_MS-210-01V5	REV:5	Form NO.:ENG-026-A

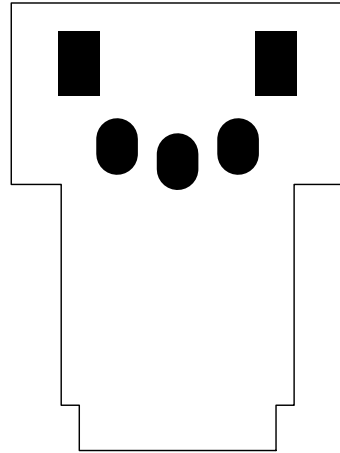
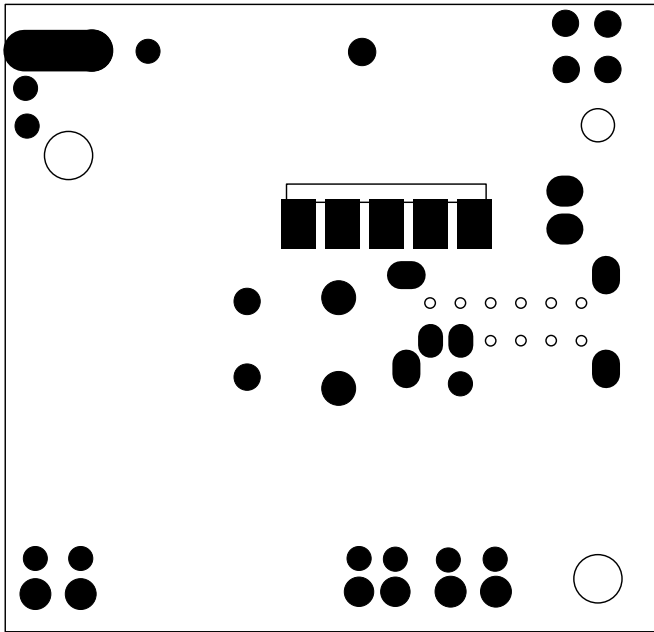

KIDDESIGNS INC.			
MATERIAL: FR-4	TITLE: Main Board	6 OF 7 PAGE	
PLATING: Tunmeric	MODEL NAME: Walkie Talkie	SCALE: 2.00	
THCKENSS: 1.0mm	MODEL NO.: MS-210	LAYER: Bottom Soider Mask	
	DWG NO.:PCB_MS-210-01V5	REV:5	Copper thickness:10Z
SIZE:	SCH NO.:SCH_MS-210-01V5	REV:5	Form NO.:ENG-026-A

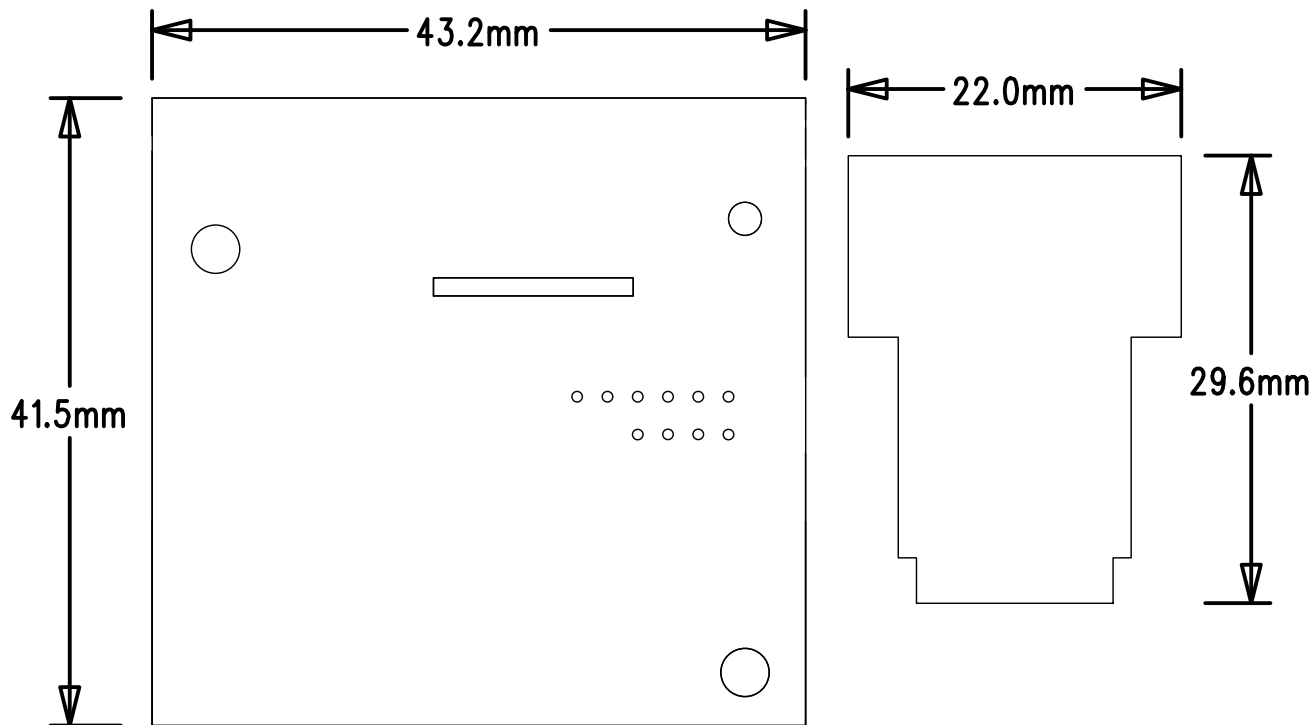

KIDDESIGNS INC.			
MATERIAL: FR-4	TITLE: Main Board	7 OF 7 PAGE	
PLATING: Tunmeric	MODEL NAME: Walkie Talkie	SCALE: 2.00	
THCKENSS: 1.0mm	MODEL NO.: MS-210	LAYER:	Mechanical
	DWG NO.:PCB_MS-210-01V5	REV:5	Copper thickness:10Z
SIZE:	SCH NO.:SCH_MS-210-01V5	REV:5	Form NO.:ENG-026-A