

FCC Test Report

Report No.: RF180821E03-1 R1

FCC ID: I88WSQ20

Test Model: WSQ20

Received Date: Oct. 11, 2018

Test Date: Dec. 18, 2018 to Jan. 04, 2019

Issued Date: Jan. 30, 2019

Applicant: Zyxel Communications Corporation

Address: No.2 Industry East RD. IX, Hsinchu Science Park, Hsinchu 30075, Taiwan

Issued By: Bureau Veritas Consumer Products Services (H.K.) Ltd., Taoyuan Branch
Hsin Chu Laboratory

Lab Address: E-2, No.1, Li Hsin 1st Road, Hsinchu Science Park, Hsinchu City 300,
Taiwan R.O.C.

Test Location: E-2, No.1, Li Hsin 1st Road, Hsinchu Science Park, Hsinchu City 300,
Taiwan R.O.C.

**FCC Registration /
Designation Number:** 723255 / TW2022



This report is for your exclusive use. Any copying or replication of this report to or for any other person or entity, or use of our name or trademark, is permitted only with our prior written permission. This report sets forth our findings solely with respect to the test samples identified herein. The results set forth in this report are not indicative or representative of the quality or characteristics of the lot from which a test sample was taken or any similar or identical product unless specifically and expressly noted. Our report includes all of the tests requested by you and the results thereof based upon the information that you provided to us. You have 60 days from date of issuance of this report to notify us of any material error or omission caused by our negligence, provided, however, that such notice shall be in writing and shall specifically address the issue you wish to raise. A failure to raise such issue within the prescribed time shall constitute your unqualified acceptance of the completeness of this report, the tests conducted and the correctness of the report contents. Unless specific mention, the uncertainty of measurement has been explicitly taken into account to declare the compliance or non-compliance to the specification. The report must not be used by the client to claim product certification, approval, or endorsement by TAF or any government agencies.

Table of Contents

Release Control Record	4
1 Certificate of Conformity	5
2 Summary of Test Results	6
2.1 Measurement Uncertainty	6
2.2 Modification Record	6
3 General Information	7
3.1 General Description of EUT	7
3.2 Description of Test Modes	10
3.2.1 Test Mode Applicability and Tested Channel Detail	11
3.3 Duty Cycle of Test Signal	13
3.4 Description of Support Units	14
3.4.1 Configuration of System under Test	15
3.5 General Description of Applied Standard	16
4 Test Types and Results	17
4.1 Radiated Emission and Bandedge Measurement	17
4.1.1 Limits of Radiated Emission and Bandedge Measurement	17
4.1.2 Test Instruments	18
4.1.3 Test Procedure	20
4.1.4 Deviation from Test Standard	21
4.1.5 Test Setup	21
4.1.6 EUT Operating Condition	22
4.1.7 Test Results	23
4.2 Conducted Emission Measurement	43
4.2.1 Limits of Conducted Emission Measurement	43
4.2.2 Test Instruments	43
4.2.3 Test Procedure	44
4.2.4 Deviation from Test Standard	44
4.2.5 Test Setup	44
4.2.6 EUT Operating Condition	44
4.2.7 Test Results	45
4.3 Transmit Power Measurement	47
4.3.1 Limits of Transmit Power Measurement	47
4.3.2 Test Setup	47
4.3.3 Test Instruments	47
4.3.4 Test Procedure	47
4.3.5 Deviation from Test Standard	47
4.3.6 EUT Operating Condition	47
4.3.7 Test Result	48
4.4 Occupied Bandwidth Measurement	51
4.4.1 Test Setup	51
4.4.2 Test Instruments	51
4.4.3 Test Procedure	51
4.4.4 Test Results	52
4.5 Peak Power Spectral Density Measurement	58
4.5.1 Limits of Peak Power Spectral Density Measurement	58
4.5.2 Test Setup	58
4.5.3 Test Instruments	58
4.5.4 Test Procedure	58
4.5.5 Deviation from Test Standard	58
4.5.6 EUT Operating Condition	58
4.5.7 Test Results	59
4.6 Frequency Stability Measurement	65
4.6.1 Limits of Frequency Stability Measurement	65

4.6.2	Test Setup.....	65
4.6.3	Test Instruments	65
4.6.4	Test Procedure	65
4.6.5	Deviation from Test Standard	65
4.6.6	EUT Operating Condition	65
4.6.7	Test Results	66
4.7	6dB Bandwidth Measurement	67
4.7.1	Limits of 6dB Bandwidth Measurement.....	67
4.7.2	Test Setup.....	67
4.7.3	Test Instruments	67
4.7.4	Test Procedure	67
4.7.5	Deviation from Test Standard	67
4.7.6	EUT Operating Condition	67
4.7.7	Test Results	68
5	Pictures of Test Arrangements.....	70
	Annex A- Radiated Out of Band Emission (OOBE) Measurement (For U-NII-3 band)	71
	Appendix – Information on the Testing Laboratories	74

Release Control Record

Issue No.	Description	Date Issued
RF180821E03-1	Original release.	Jan. 15, 2019
RF180821E03-1 R1	Modify RF Chip Model No. & FW.	Jan. 30, 2019

1 Certificate of Conformity

Product: Multy Mini Dual-Band WiFi System Add-on

Brand: ZYXEL

Test Model: WSQ20

Sample Status: ENGINEERING SAMPLE

Applicant: Zyxel Communications Corporation

Test Date: Dec. 18, 2018 to Jan. 04, 2019

Standard: 47 CFR FCC Part 15, Subpart E (Section 15.407)
ANSI C63.10: 2013

The above equipment has been tested by **Bureau Veritas Consumer Products Services (H.K.) Ltd., Taoyuan Branch**, and found compliance with the requirement of the above standards. The test record, data evaluation & Equipment Under Test (EUT) configurations represented herein are true and accurate accounts of the measurements of the sample's EMC characteristics under the conditions specified in this report.

Prepared by : Wendy Wu , **Date:** Jan. 30, 2019
Wendy Wu / Specialist

Approved by : May Chen , **Date:** Jan. 30, 2019
May Chen / Manager

2 Summary of Test Results

47 CFR FCC Part 15, Subpart E (Section 15.407)			
FCC Clause	Test Item	Result	Remarks
15.407(b)(6)	AC Power Conducted Emissions	Pass	Meet the requirement of limit. Minimum passing margin is -11.17dB at 0.50156MHz.
15.407(b) (1/2/3/4(i/ii)/6)	Radiated Emissions & Band Edge Measurement*	Pass	Meet the requirement of limit. Minimum passing margin is -0.7dB at 5150.00MHz.
15.407(a)(1/2/3)	Max Average Transmit Power	Pass	Meet the requirement of limit.
---	Occupied Bandwidth Measurement	-	Reference only.
15.407(a)(1/2/3)	Peak Power Spectral Density	Pass	Meet the requirement of limit.
15.407(e)	6dB bandwidth	Pass	Meet the requirement of limit. (U-NII-3 Band only)
15.407(g)	Frequency Stability	Pass	Meet the requirement of limit.
15.203	Antenna Requirement	Pass	Antenna connector is R-SMA not a standard connector.

*For U-NII-3 band compliance with rule part 15.407(b)(4)(i), the OOB test plots were recorded in Annex A.

2.1 Measurement Uncertainty

Where relevant, the following measurement uncertainty levels have been estimated for tests performed on the EUT as specified in CISPR 16-4-2:

Measurement	Frequency	Expanded Uncertainty (k=2) (±)
Conducted Emissions at mains ports	150kHz ~ 30MHz	1.84 dB
Radiated Emissions up to 1 GHz	30MHz ~ 1GHz	5.33 dB
Radiated Emissions above 1 GHz	1GHz ~ 6GHz	5.10 dB
	6GHz ~ 18GHz	4.85 dB
	18GHz ~ 40GHz	5.24 dB

2.2 Modification Record

There were no modifications required for compliance.

3 General Information

3.1 General Description of EUT

Product	Multy Mini Dual-Band WiFi System Add-on
Brand	ZYXEL
Test Model	WSQ20
RF CPU Model No.	QCA9563
RF Chip Model No.	2.4G: QCA9563 5G: QCA9982 BLE:CSR8811
FW	V1.00(ABOF.0)B5
Status of EUT	ENGINEERING SAMPLE
Power Supply Rating	DC 12V from adapter
Modulation Type	CCK, DQPSK, DBPSK for DSSS 64QAM, 16QAM, QPSK, BPSK for OFDM 256QAM for OFDM in 11ac mode only
Modulation Technology	DSSS, OFDM
Transfer Rate	802.11b: up to 11Mbps 802.11a/g: up to 54Mbps 802.11n: up to 450Mbps 802.11ac: up to 1300Mbps
Operating Frequency	2.4GHz: 2.412 ~ 2.462GHz 5GHz: 5.18~ 5.24GHz, 5.745 ~ 5.825GHz
Number of Channel	2.4GHz: 802.11b, 802.11g, 802.11n (HT20): 11 802.11n (HT40): 7 5GHz: 802.11a, 802.11n (HT20), 802.11ac (VHT20): 9 802.11n (HT40), 802.11ac (VHT40): 4 802.11ac (VHT80): 2
Output Power	2.4GHz: 960.188mW 5GHz: CDD Mode 5.18 ~ 5.24GHz: 947.747mW 5.745 ~ 5.825GHz: 992.446mW Beamforming Mode: 5.18 ~ 5.24GHz: 922.217mW 5.745 ~ 5.825GHz: 967.39mW
Antenna Type	Refer to Note
Antenna Connector	Refer to Note
Accessory Device	Adapter x 1
Data Cable Supplied	NA

Note:

1. There are WLAN and Bluetooth technology used for the EUT. The EUT has below radios as following table:

Radio 1	Radio 2
WLAN	Bluetooth

2. Simultaneously transmission condition.

Condition	Technology	
1	WLAN 2.4GHz	Bluetooth
2	WLAN 5GHz	Bluetooth

Note: The emission of the simultaneous operation has been evaluated and no non-compliance was found.

3. The EUT could be supplied with power adapter as the following table:

No.	Brand	Model No.	Spec.	Remark
1	APD	WA-36A12R	Input: 100-240Vac, 0.9A, 50/60Hz Output: 12V, 3A DC output cable: Unshielded 1.8m	Changeable plug
2	APD	WA-36A12FU	Input: 100-240Vac, 0.9A, 50/60Hz Output: 12V, 3A DC output cable: Unshielded 1.8m	Fixed plug

Note:

1. The Adapters 1 is as same as Adapter 2; except for plug shape is different.
 2. From the above adapter, **Adapters 1** was selected for the final test. Therefore only the test data of the mode was recorded in this report.

4. The antennas provided to the EUT, please refer to the following table:

For WLAN				
Chain No	Antenna Net Gain (dBi)	Frequency range (GHz)	Antenna Type	Connector Type
0	0	2.4 ~ 2.4835	PIFA	IPEX
1	0	2.4 ~ 2.4835	PIFA	IPEX
2	0	2.4 ~ 2.4835	PIFA	IPEX
0	0	5.15 ~ 5.25	Dipole	IPEX
	0	5.725 ~ 5.85		
1	0	5.15 ~ 5.25	Dipole	IPEX
	0	5.725 ~ 5.85		
2	0	5.15 ~ 5.25	PIFA	IPEX
	0.7	5.725 ~ 5.85		
For Bluetooth				
Antenna Net Gain(dBi)	Frequency range (MHz)	Antenna Type	Connector Type	
2.3	2402~2480	PIFA	IPEX	

5. The EUT incorporates a MIMO function:

2.4GHz Band		
MODULATION MODE	TX & RX CONFIGURATION	
802.11b	3TX	3RX
802.11g	3TX	3RX
802.11n (HT20)	3TX	3RX
802.11n (HT40)	3TX	3RX
5GHz Band		
MODULATION MODE	TX & RX CONFIGURATION	
802.11a	3TX	3RX
802.11n (HT20)	3TX	3RX
802.11n (HT40)	3TX	3RX
802.11ac (VHT20)	3TX	3RX
802.11ac (VHT40)	3TX	3RX
802.11ac (VHT80)	3TX	3RX

Note:

- All of modulation mode support beamforming function except 2.4GHz & 802.11a modulation mode.
- The EUT support Beamforming and CDD mode, therefore both mode were investigated and the worst case scenario was identified. The worst case data were presented in test report.
- The modulation and bandwidth are similar for 802.11n mode for 20MHz (40MHz) and 802.11ac mode for 20MHz (40MHz), therefore investigated worst case to representative mode in test report. (Final test mode refer section 3.2.1)

6. The power setting are list as below:

CDD Mode							
802.11a		802.11ac (VHT20)		802.11ac (VHT40)		802.11ac (VHT80)	
Frequency (MHz)	Power Setting	Frequency (MHz)	Power Setting	Frequency (MHz)	Power Setting	Frequency (MHz)	Power Setting
5180	21.5	5180	22	5190	15.5	5210	13
5200	26	5200	26	5230	25	5775	20.5
5240	26	5240	26	5755	24.5		
5745	25.5	5745	25.5	5795	24.5		
5785	25.5	5785	25.5				
5825	25.5	5825	25.5				
Beamforming Mode							
802.11ac (VHT20)		802.11ac (VHT40)		802.11ac (VHT80)			
Frequency (MHz)	Power Setting	Frequency (MHz)	Power Setting	Frequency (MHz)	Power Setting		
5180	22	5190	15.5	5210	13		
5200	26	5230	25	5775	20.5		
5240	26	5755	24.5				
5745	25.5	5795	24.5				
5785	25.5						
5825	25.5						

7. The above EUT information is declared by manufacturer and for more detailed features description, please refer to the manufacturer's specifications or user's manual.

3.2 Description of Test Modes

FOR 5180 ~ 5240MHz

4 channels are provided for 802.11a, 802.11n (HT20), 802.11ac (VHT20):

Channel	Frequency	Channel	Frequency
36	5180MHz	44	5220MHz
40	5200MHz	48	5240MHz

2 channels are provided for 802.11n (HT40), 802.11ac (VHT40):

Channel	Frequency	Channel	Frequency
38	5190MHz	46	5230MHz

1 channel is provided for 802.11ac (VHT80):

Channel	Frequency
42	5210MHz

FOR 5745 ~ 5825MHz:

5 channels are provided for 802.11a, 802.11n (HT20), 802.11ac (VHT20):

Channel	Frequency	Channel	Frequency
149	5745MHz	161	5805MHz
153	5765MHz	165	5825MHz
157	5785MHz		

2 channels are provided for 802.11n (HT40), 802.11ac (VHT40):

Channel	Frequency	Channel	Frequency
151	5755MHz	159	5795MHz

1 channel is provided for 802.11ac (VHT80):

Channel	Frequency
155	5775MHz

3.2.1 Test Mode Applicability and Tested Channel Detail

EUT Configure Mode	Applicable To				Description
	RE \geq 1G	RE $<$ 1G	PLC	APCM	
-	√	√	√	√	-

Where **RE \geq 1G**: Radiated Emission above 1GHz **RE $<$ 1G**: Radiated Emission below 1GHz
PLC: Power Line Conducted Emission **APCM**: Antenna Port Conducted Measurement

NOTE:

- The EUT had been pre-tested on the positioned of each 3 axis. The worst case was found when positioned on **X-plane**.

Radiated Emission Test (Above 1GHz):

- Pre-Scan has been conducted to determine the worst-case mode from all possible combinations between available modulations, data rates and antenna ports (if EUT with antenna diversity architecture).
- Following channel(s) was (were) selected for the final test as listed below.

CDD Mode						
Mode	FREQ. Band (MHz)	Available Channel	Tested Channel	Modulation Technology	Modulation Type	Data Rate (Mbps)
802.11a	5180-5240	36 to 48	36, 40, 48	OFDM	BPSK	6
802.11ac (VHT20)		36 to 48	36, 40, 48	OFDM	BPSK	6.5
802.11ac (VHT40)		38 to 46	38, 46	OFDM	BPSK	13.5
802.11ac (VHT80)		42	42	OFDM	BPSK	29.3
802.11a	5745-5825	149 to 165	149, 157, 165	OFDM	BPSK	6
802.11ac (VHT20)		149 to 165	149, 157, 165	OFDM	BPSK	6.5
802.11ac (VHT40)		151 to 159	151, 159	OFDM	BPSK	13.5
802.11ac (VHT80)		155	155	OFDM	BPSK	29.3

Radiated Emission Test (Below 1GHz):

- Pre-Scan has been conducted to determine the worst-case mode from all possible combinations between available modulations, data rates and antenna ports (if EUT with antenna diversity architecture).
- Following channel(s) was (were) selected for the final test as listed below.

CDD Mode						
Mode	FREQ. Band (MHz)	Available Channel	Tested Channel	Modulation Technology	Modulation Type	Data Rate (Mbps)
802.11a	5180-5240 5745-5825	36 to 48 149 to 165	149	OFDM	BPSK	6

Power Line Conducted Emission Test:

- Pre-Scan has been conducted to determine the worst-case mode from all possible combinations between available modulations, data rates and antenna ports (if EUT with antenna diversity architecture).
- Following channel(s) was (were) selected for the final test as listed below.

CDD Mode						
Mode	FREQ. Band (MHz)	Available Channel	Tested Channel	Modulation Technology	Modulation Type	Data Rate (Mbps)
802.11a	5180-5240 5745-5825	36 to 48 149 to 165	149	OFDM	BPSK	6

Antenna Port Conducted Measurement:

- This item includes all test value of each mode, but only includes spectrum plot of worst value of each mode.
- Pre-Scan has been conducted to determine the worst-case mode from all possible combinations between available modulations, data rates and antenna ports (if EUT with antenna diversity architecture).
- Following channel(s) was (were) selected for the final test as listed below.

CDD Mode						
Mode	FREQ. Band (MHz)	Available Channel	Tested Channel	Modulation Technology	Modulation Type	Data Rate (Mbps)
802.11a	5180-5240	36 to 48	36, 40, 48	OFDM	BPSK	6
802.11ac (VHT20)		36 to 48	36, 40, 48	OFDM	BPSK	6.5
802.11ac (VHT40)		38 to 46	38, 46	OFDM	BPSK	13.5
802.11ac (VHT80)		42	42	OFDM	BPSK	29.3
802.11a	5745-5825	149 to 165	149, 157, 165	OFDM	BPSK	6
802.11ac (VHT20)		149 to 165	149, 157, 165	OFDM	BPSK	6.5
802.11ac (VHT40)		151 to 159	151, 159	OFDM	BPSK	13.5
802.11ac (VHT80)		155	155	OFDM	BPSK	29.3
Beamforming Mode (Output power only)						
Mode	FREQ. Band (MHz)	Available Channel	Tested Channel	Modulation Technology	Modulation Type	Data Rate (Mbps)
802.11ac (VHT20)	5180-5240	36 to 48	36, 40, 48	OFDM	BPSK	6.5
802.11ac (VHT40)		38 to 46	38, 46	OFDM	BPSK	13.5
802.11ac (VHT80)		42	42	OFDM	BPSK	29.3
802.11ac (VHT20)	5745-5825	149 to 165	149, 157, 165	OFDM	BPSK	6.5
802.11ac (VHT40)		151 to 159	151, 159	OFDM	BPSK	13.5
802.11ac (VHT80)		155	155	OFDM	BPSK	29.3

Test Condition:

APPLICABLE TO	ENVIRONMENTAL CONDITIONS	INPUT POWER	TESTED BY
RE \geq 1G	22deg. C, 64%RH	120Vac, 60Hz	Steven Chiang
RE $<$ 1G	24deg. C, 68%RH	120Vac, 60Hz	Andy Ho
PLC	24deg. C, 76%RH	120Vac, 60Hz	Andy Ho
APCM	25deg. C, 60%RH	120Vac, 60Hz	Anderson Chen

3.3 Duty Cycle of Test Signal

If duty cycle of test signal is < 98%, duty factor shall be considered.

802.11a: Duty cycle = 2.026/2.118 = 0.957, Duty factor = $10 \cdot \log(1/0.957) = 0.19$

802.11ac (VHT20): Duty cycle = 1.898/1.989 = 0.954, Duty factor = $10 \cdot \log(1/0.954) = 0.2$

802.11ac (VHT40): Duty cycle = 1.828/1.925 = 0.964, Duty factor = $10 \cdot \log(1/0.95) = 0.22$

802.11ac (VHT80): Duty cycle = 0.867/0.975 = 0.936, Duty factor = $10 \cdot \log(1/0.889) = 0.51$

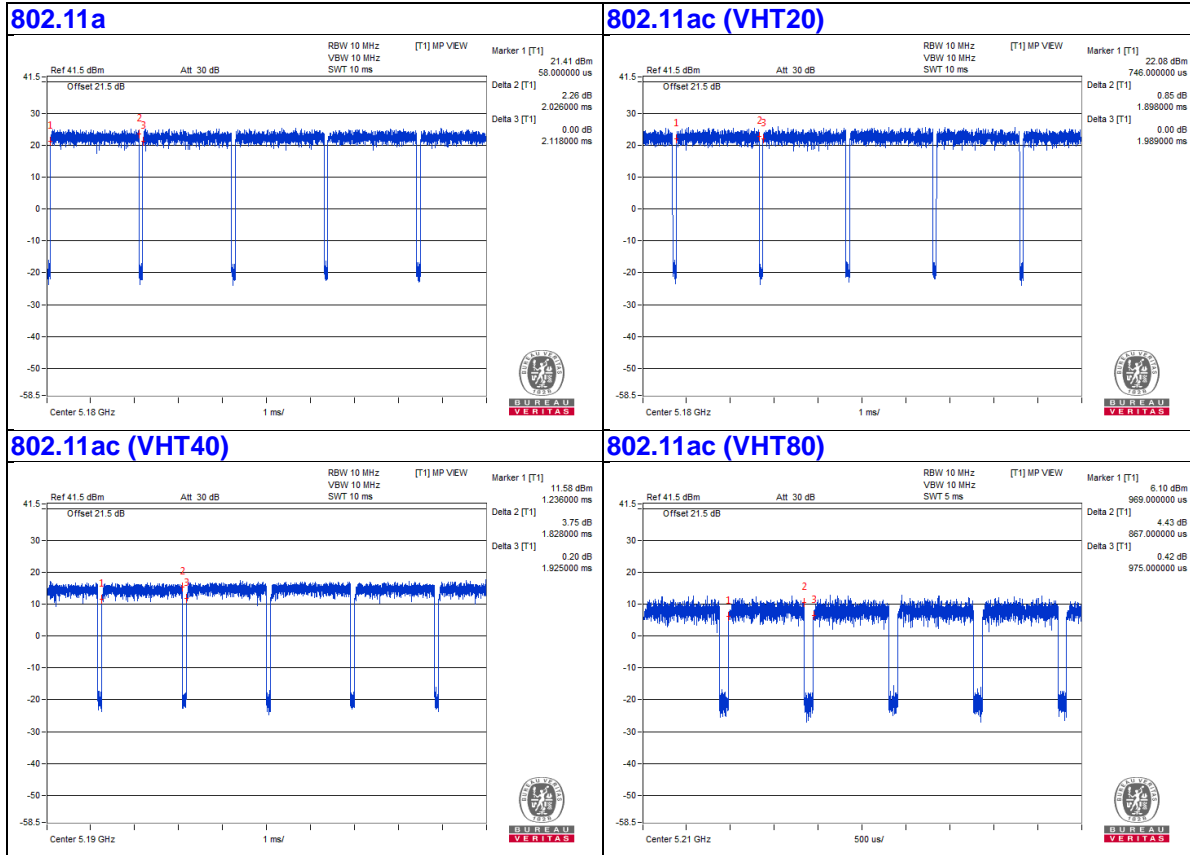

3.4 Description of Support Units

The EUT has been tested as an independent unit together with other necessary accessories or support units. The following support units or accessories were used to form a representative test configuration during the tests.

ID	Product	Brand	Model No.	Serial No.	FCC ID	Remarks
A.	Laptop	DELL	E6420	B92T3R1	FCC DoC	Provided by Lab
B.	PowerBank	MI	PLM09ZM	NA	NA	Supplied by client

Note:

1. All power cords of the above support units are non-shielded (1.8m).

ID	Descriptions	Qty.	Length (m)	Shielding (Yes/No)	Cores (Qty.)	Remarks
1.	RJ-45 Cable	1	10	No	0	Provided by Lab
2.	DC Cable	1	1.8	No	0	Supplied by client
3.	microUSB Cable	1	1	Yes	0	Supplied by client

3.4.1 Configuration of System under Test

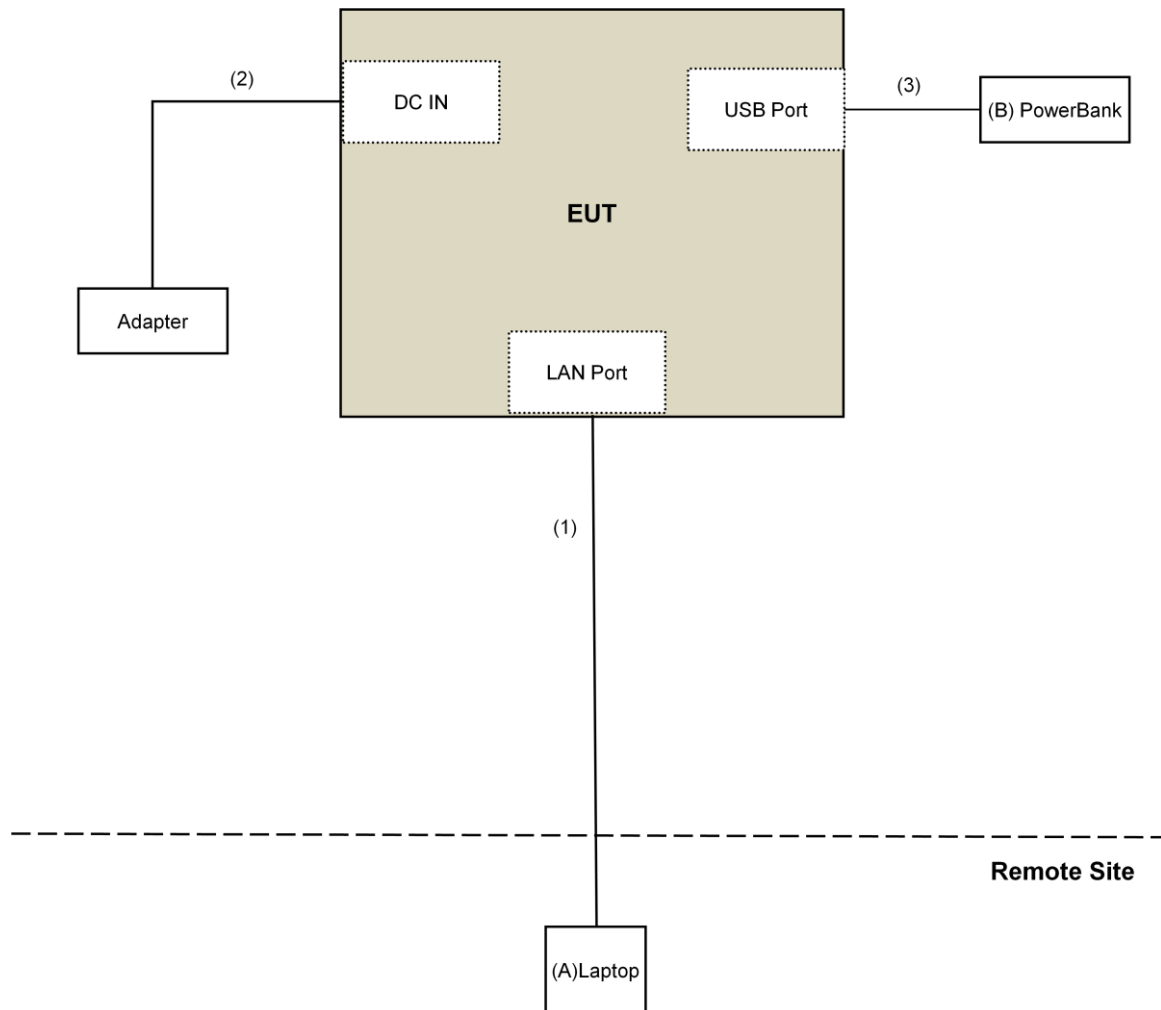

3.5 General Description of Applied Standard

The EUT is a RF Product. According to the specifications of the manufacturer, it must comply with the requirements of the following standards:

FCC Part 15, Subpart E (15.407)
KDB 789033 D02 General UNII Test Procedure New Rules v02r01
KDB 662911 D01 Multiple Transmitter Output v02r01
ANSI C63.10-2013

All test items have been performed and recorded as per the above standards.

4 Test Types and Results

4.1 Radiated Emission and Bandedge Measurement

4.1.1 Limits of Radiated Emission and Bandedge Measurement

Radiated emissions which fall in the restricted bands must comply with the radiated emission limits specified as below table.

Frequencies (MHz)	Field Strength (microvolts/meter)	Measurement Distance (meters)
0.009 ~ 0.490	2400/F(kHz)	300
0.490 ~ 1.705	24000/F(kHz)	30
1.705 ~ 30.0	30	30
30 ~ 88	100	3
88 ~ 216	150	3
216 ~ 960	200	3
Above 960	500	3

NOTE:

1. The lower limit shall apply at the transition frequencies.
2. Emission level (dBuV/m) = 20 log Emission level (uV/m).
3. For frequencies above 1000MHz, the field strength limits are based on average detector, however, the peak field strength of any emission shall not exceed the maximum permitted average limits, specified above by more than 20dB under any condition of modulation.

Limits of unwanted emission out of the restricted bands

Applicable To		Limit	
789033 D02 General UNII Test Procedure New Rules v02r01		Field Strength at 3m	
		PK:74 (dBuV/m)	AV:54 (dBuV/m)
Frequency Band	Applicable To	EIRP Limit	Equivalent Field Strength at 3m
5150~5250 MHz	15.407(b)(1)	PK:-27 (dBm/MHz)	PK:68.2(dBuV/m)
5250~5350 MHz	15.407(b)(2)		
5470~5725 MHz	15.407(b)(3)		
5725~5850 MHz	<input checked="" type="checkbox"/> 15.407(b)(4)(i)	PK:-27 (dBm/MHz) ^{*1} PK:10 (dBm/MHz) ^{*2} PK:15.6 (dBm/MHz) ^{*3} PK:27 (dBm/MHz) ^{*4}	PK: 68.2(dBuV/m) ^{*1} PK:105.2 (dBuV/m) ^{*2} PK: 110.8(dBuV/m) ^{*3} PK:122.2 (dBuV/m) ^{*4}
	<input type="checkbox"/> 15.407(b)(4)(ii)	Emission limits in section 15.247(d)	
^{*1} beyond 75 MHz or more above of the band edge.		^{*2} below the band edge increasing linearly to 10 dBm/MHz at 25 MHz above.	
^{*3} below the band edge increasing linearly to a level of 15.6 dBm/MHz at 5 MHz above.		^{*4} from 5 MHz above or below the band edge increasing linearly to a level of 27 dBm/MHz at the band edge.	

Note:

The following formula is used to convert the equipment isotropic radiated power (eirp) to field strength:

$$E = \frac{1000000\sqrt{30P}}{3} \mu\text{V/m, where P is the eirp (Watts).}$$

4.1.2 Test Instruments

DESCRIPTION & MANUFACTURER	MODEL NO.	SERIAL NO.	CALIBRATED DATE	CALIBRATED UNTIL
Test Receiver Keysight	N9038A	MY54450088	July 05, 2018	July 04, 2019
Pre-Amplifier EMCI	EMC001340	980142	Feb. 09, 2018	Feb. 08, 2019
Loop Antenna Electro-Metrics	EM-6879	269	Sep. 07, 2018	Sep. 06, 2019
RF Cable	NA	LOOPCAB-001	Jan. 15, 2018	Jan. 14, 2019
RF Cable	NA	LOOPCAB-002	Jan. 15, 2018	Jan. 14, 2019
Pre-Amplifier Mini-Circuits	ZFL-1000VH2B	AMP-ZFL-01	Oct. 30, 2018	Oct. 29, 2019
Trilog Broadband Antenna SCHWARZBECK	VULB 9168	9168-406	Nov. 22, 2018	Nov. 21, 2019
RF Cable	8D	966-4-1	Mar. 21, 2018	Mar. 20, 2019
RF Cable	8D	966-4-2	Mar. 21, 2018	Mar. 20, 2019
RF Cable	8D	966-4-3	Mar. 21, 2018	Mar. 20, 2019
Fixed attenuator Mini-Circuits	UNAT-5+	PAD-3m-4-01	Sep. 27, 2018	Sep. 26, 2019
Horn_Antenna SCHWARZBECK	BBHA 9120D	9120D-783	Nov. 25, 2018	Nov. 24, 2019
Pre-Amplifier Mini-Circuits	ZVA-183-S+	AMP-ZVA-03	May 10, 2018	May 09, 2019
RF Cable	EMC104-SM-SM-1200	160923	Jan. 29, 2018	Jan. 28, 2019
RF Cable	EMC104-SM-SM-2000	150318	Jan. 29, 2018	Jan. 28, 2019
RF Cable	EMC104-SM-SM-5000	150321	Jan. 29, 2018	Jan. 28, 2019
Pre-Amplifier EMCI	EMC184045SE	980387	Jan. 29, 2018	Jan. 28, 2019
Horn_Antenna SCHWARZBECK	BBHA 9170	BBHA9170608	Nov. 25, 2018	Nov. 24, 2019
RF Cable	EMC102-KM-KM-1200	160925	Jan. 29, 2018	Jan. 28, 2019
Software	ADT_Radiated_V8.7.08	NA	NA	NA
Boresight Antenna Tower & Turn Table Max-Full	MF-7802BS	MF780208530	NA	NA
Spectrum Analyzer R&S	FSV40	100964	June 20, 2018	June 19, 2019
Power meter Anritsu	ML2495A	1014008	May 09, 2018	May 08, 2019
Power sensor Anritsu	MA2411B	0917122	May 09, 2018	May 08, 2019
Fixed Attenuator Mini-Circuits	MDCS18N-10	MDCS18N-10-01	Apr. 16, 2018	Apr. 15, 2019
AC Power Source Extech Electronics	6205	1440452	NA	NA
Temperature & Humidity Chamber Giant Force	GTH-150-40-SP-AR	MAA0812-008	Jan. 10, 2018	Jan. 09, 2019
True RMS Clamp Meter FLUKE	325	31130711WS	May 22, 2018	May 21, 2019

Note:

1. The calibration interval of the above test instruments is 12 months and the calibrations are traceable to NML/ROC and NIST/USA.
2. The test was performed in 966 Chamber No. 4.
3. The CANADA Site Registration No. is 20331-2
4. Loop antenna was used for all emissions below 30 MHz.
5. Tested Date: Dec. 18, 2018 to Jan. 04, 2019

4.1.3 Test Procedure

For Radiated emission below 30MHz

- a. The EUT was placed on the top of a rotating table 0.8 meters above the ground at a 3 meter chamber room. The table was rotated 360 degrees to determine the position of the highest radiation.
- b. The EUT was set 3 meters away from the interference-receiving antenna, which was mounted on the top of a variable-height antenna tower.
- c. Parallel, perpendicular, and ground-parallel orientations of the antenna are set to make the measurement.
- d. For each suspected emission, the EUT was arranged to its worst case and the rotatable table was turned from 0 degrees to 360 degrees to find the maximum reading.
- e. The test-receiver system was set to Quasi-Peak Detect Function and Specified Bandwidth with Maximum Hold Mode.

NOTE:

1. The resolution bandwidth and video bandwidth of test receiver/spectrum analyzer is 9kHz at frequency below 30MHz.

For Radiated emission above 30MHz

- a. The EUT was placed on the top of a rotating table 0.8 meters (for 30MHz ~ 1GHz) / 1.5 meters (for above 1GHz) above the ground at 3 meter chamber room for test. The table was rotated 360 degrees to determine the position of the highest radiation.
- b. The EUT was set 3 meters away from the interference-receiving antenna, which was mounted on the top of a variable-height antenna tower.
- c. The height of antenna is varied from one meter to four meters above the ground to determine the maximum value of the field strength. Both horizontal and vertical polarizations of the antenna are set to make the measurement.
- d. For each suspected emission, the EUT was arranged to its worst case and then the antenna was tuned to heights from 1 meter to 4 meters and the rotatable table was turned from 0 degrees to 360 degrees to find the maximum reading.
- e. The test-receiver system was set to quasi-peak detect function and specified bandwidth with maximum hold mode when the test frequency is below 1 GHz.
- f. The test-receiver system was set to peak and average detects function and specified bandwidth with maximum hold mode when the test frequency is above 1 GHz. If the peak reading value also meets average limit, measurement with the average detector is unnecessary.

Note:

1. The resolution bandwidth and video bandwidth of test receiver/spectrum analyzer is 120kHz for Quasi-peak detection (QP) at frequency below 1GHz.
2. The resolution bandwidth of test receiver/spectrum analyzer is 1 MHz and the video bandwidth is 3 MHz for Peak detection (PK) at frequency above 1GHz.
3. The resolution bandwidth of test receiver/spectrum analyzer is 1MHz and the video bandwidth is $\geq 1/T$ (Duty cycle < 98%) or 10Hz (Duty cycle $\geq 98\%$) for Average detection (AV) at frequency above 1GHz.
4. All modes of operation were investigated and the worst-case emissions are reported.

4.1.4 Deviation from Test Standard

No deviation.

4.1.5 Test Setup

For Radiated emission below 30MHz

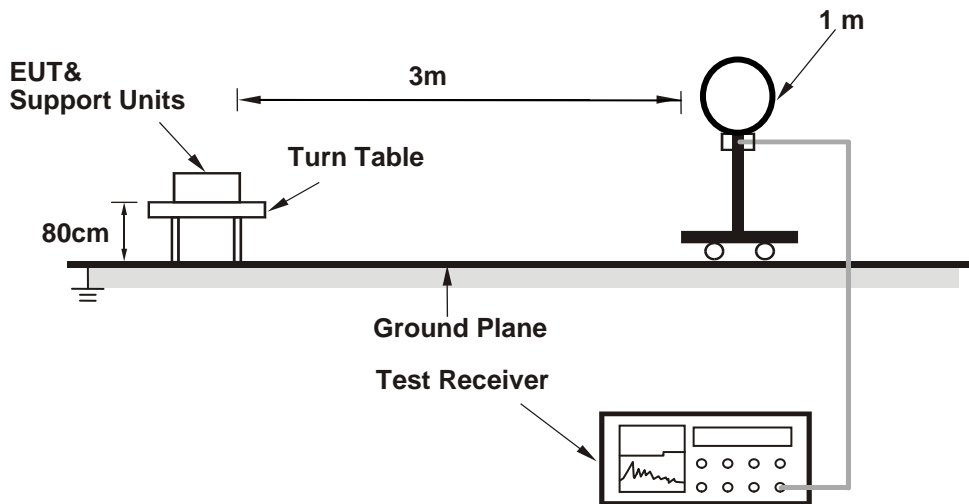

For Radiated emission 30MHz to 1GHz

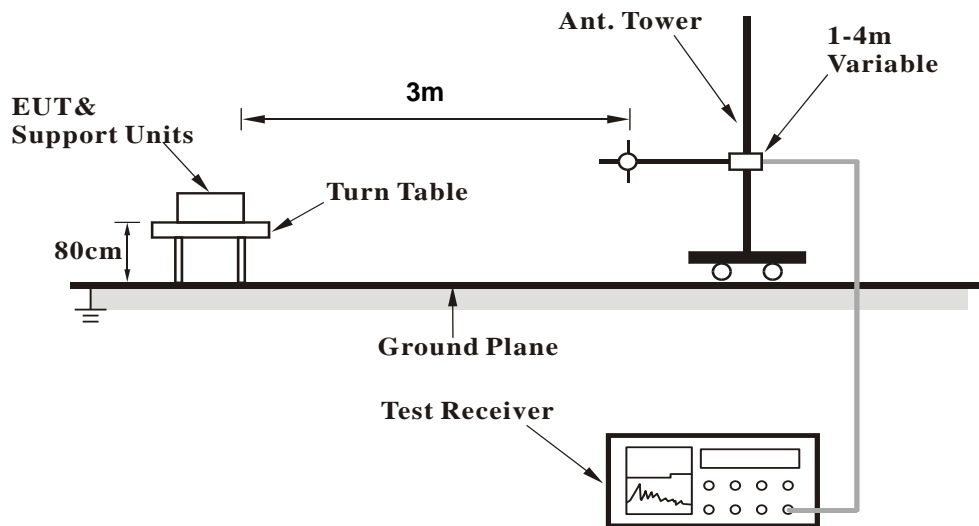

For Radiated emission above 1GHz

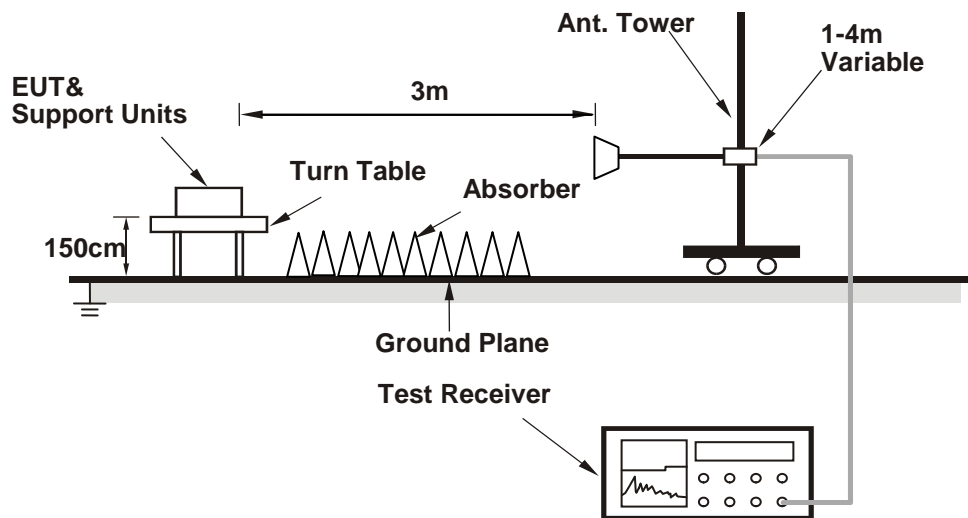

For the actual test configuration, please refer to the attached file (Test Setup Photo).

4.1.6 EUT Operating Condition

- a. Connected the EUT with the Laptop is placed on remote site.
- b. Controlling software (QDART-Connectivity (1.0.00053)) has been activated to set the EUT on specific status.

4.1.7 Test Results

Above 1GHz Data:

802.11a

CHANNEL	TX Channel 36	DETECTOR FUNCTION	Peak (PK)
FREQUENCY RANGE	1GHz ~ 40GHz		Average (AV)

ANTENNA POLARITY & TEST DISTANCE: HORIZONTAL AT 3 M

NO.	FREQ. (MHz)	EMISSION LEVEL (dBuV/m)	LIMIT (dBuV/m)	MARGIN (dB)	ANTENNA HEIGHT (m)	TABLE ANGLE (Degree)	RAW VALUE (dBuV)	CORRECTION FACTOR (dB/m)
1	5150.00	67.1 PK	74.0	-6.9	1.16 H	179	64.1	3.0
2	5150.00	53.0 AV	54.0	-1.0	1.16 H	179	50.0	3.0
3	*5180.00	121.0 PK			1.16 H	179	118.1	2.9
4	*5180.00	111.5 AV			1.16 H	179	108.6	2.9
5	#10360.00	54.5 PK	68.2	-13.7	1.40 H	28	41.5	13.0
6	15540.00	49.5 PK	74.0	-24.5	1.30 H	52	36.4	13.1
7	15540.00	40.3 AV	54.0	-13.7	1.30 H	52	27.2	13.1

ANTENNA POLARITY & TEST DISTANCE: VERTICAL AT 3 M

NO.	FREQ. (MHz)	EMISSION LEVEL (dBuV/m)	LIMIT (dBuV/m)	MARGIN (dB)	ANTENNA HEIGHT (m)	TABLE ANGLE (Degree)	RAW VALUE (dBuV)	CORRECTION FACTOR (dB/m)
1	5150.00	62.1 PK	74.0	-11.9	1.20 V	293	59.1	3.0
2	5150.00	46.3 AV	54.0	-7.7	1.20 V	293	43.3	3.0
3	*5180.00	115.6 PK			1.20 V	293	112.7	2.9
4	*5180.00	106.1 AV			1.20 V	293	103.2	2.9
5	#10360.00	57.2 PK	68.2	-11.0	1.28 V	260	44.2	13.0
6	15540.00	53.3 PK	74.0	-20.7	2.11 V	142	40.2	13.1
7	15540.00	42.3 AV	54.0	-11.7	2.11 V	142	29.2	13.1

REMARKS:

1. Emission Level(dBuV/m) = Raw Value(dBuV) + Correction Factor(dB/m)
2. Correction Factor(dB/m) = Antenna Factor(dB/m) + Cable Factor(dB) – Pre-Amplifier Factor(dB)
3. The other emission levels were very low against the limit.
4. Margin value = Emission Level – Limit value
5. " * ": Fundamental frequency.
6. " # ": The radiated frequency is out of the restricted band.

CHANNEL	TX Channel 40	DETECTOR FUNCTION	Peak (PK)
FREQUENCY RANGE	1GHz ~ 40GHz		Average (AV)

ANTENNA POLARITY & TEST DISTANCE: HORIZONTAL AT 3 M

NO.	FREQ. (MHz)	EMISSION LEVEL (dBuV/m)	LIMIT (dBuV/m)	MARGIN (dB)	ANTENNA HEIGHT (m)	TABLE ANGLE (Degree)	RAW VALUE (dBuV)	CORRECTION FACTOR (dB/m)
1	5150.00	66.8 PK	74.0	-7.2	1.14 H	178	63.8	3.0
2	5150.00	53.0 AV	54.0	-1.0	1.14 H	178	50.0	3.0
3	*5200.00	124.9 PK			1.14 H	178	122.0	2.9
4	*5200.00	115.6 AV			1.14 H	178	112.7	2.9
5	#10400.00	58.7 PK	68.2	-9.5	1.34 H	16	45.6	13.1
6	15600.00	49.4 PK	74.0	-24.6	1.27 H	54	36.4	13.0
7	15600.00	40.1 AV	54.0	-13.9	1.27 H	54	27.1	13.0

ANTENNA POLARITY & TEST DISTANCE: VERTICAL AT 3 M

NO.	FREQ. (MHz)	EMISSION LEVEL (dBuV/m)	LIMIT (dBuV/m)	MARGIN (dB)	ANTENNA HEIGHT (m)	TABLE ANGLE (Degree)	RAW VALUE (dBuV)	CORRECTION FACTOR (dB/m)
1	5150.00	61.6 PK	74.0	-12.4	1.24 V	314	58.6	3.0
2	5150.00	45.9 AV	54.0	-8.1	1.24 V	314	42.9	3.0
3	*5200.00	119.3 PK			1.24 V	314	116.4	2.9
4	*5200.00	110.0 AV			1.24 V	314	107.1	2.9
5	#10400.00	60.9 PK	68.2	-7.3	1.30 V	272	47.8	13.1
6	15600.00	53.7 PK	74.0	-20.3	2.12 V	151	40.7	13.0
7	15600.00	42.7 AV	54.0	-11.3	2.12 V	151	29.7	13.0

REMARKS:

1. Emission Level(dBuV/m) = Raw Value(dBuV) + Correction Factor(dB/m)
2. Correction Factor(dB/m) = Antenna Factor(dB/m) + Cable Factor(dB) – Pre-Amplifier Factor(dB)
3. The other emission levels were very low against the limit.
4. Margin value = Emission Level – Limit value
5. " * ": Fundamental frequency.
6. " # ": The radiated frequency is out of the restricted band.

CHANNEL	TX Channel 48	DETECTOR FUNCTION	Peak (PK)
FREQUENCY RANGE	1GHz ~ 40GHz		Average (AV)

ANTENNA POLARITY & TEST DISTANCE: HORIZONTAL AT 3 M

NO.	FREQ. (MHz)	EMISSION LEVEL (dBuV/m)	LIMIT (dBuV/m)	MARGIN (dB)	ANTENNA HEIGHT (m)	TABLE ANGLE (Degree)	RAW VALUE (dBuV)	CORRECTION FACTOR (dB/m)
1	*5240.00	124.8 PK			1.11 H	183	122.3	2.5
2	*5240.00	115.3 AV			1.11 H	183	112.8	2.5
3	5350.00	52.4 PK	74.0	-21.6	1.11 H	183	49.6	2.8
4	5350.00	41.1 AV	54.0	-12.9	1.11 H	183	38.3	2.8
5	#10480.00	58.9 PK	68.2	-9.3	1.29 H	21	45.7	13.2
6	15720.00	48.8 PK	74.0	-25.2	1.27 H	53	36.4	12.4
7	15720.00	39.7 AV	54.0	-14.3	1.27 H	53	27.3	12.4

ANTENNA POLARITY & TEST DISTANCE: VERTICAL AT 3 M

NO.	FREQ. (MHz)	EMISSION LEVEL (dBuV/m)	LIMIT (dBuV/m)	MARGIN (dB)	ANTENNA HEIGHT (m)	TABLE ANGLE (Degree)	RAW VALUE (dBuV)	CORRECTION FACTOR (dB/m)
1	*5240.00	119.2 PK			1.25 V	304	116.7	2.5
2	*5240.00	109.6 AV			1.25 V	304	107.1	2.5
3	5350.00	52.6 PK	74.0	-21.4	1.25 V	304	49.8	2.8
4	5350.00	41.3 AV	54.0	-12.7	1.25 V	304	38.5	2.8
5	#10480.00	60.5 PK	68.2	-7.7	1.34 V	267	47.3	13.2
6	15720.00	53.7 PK	74.0	-20.3	2.13 V	160	41.3	12.4
7	15720.00	42.7 AV	54.0	-11.3	2.13 V	160	30.3	12.4

REMARKS:

- Emission Level(dBuV/m) = Raw Value(dBuV) + Correction Factor(dB/m)
- Correction Factor(dB/m) = Antenna Factor(dB/m) + Cable Factor(dB) – Pre-Amplifier Factor(dB)
- The other emission levels were very low against the limit.
- Margin value = Emission Level – Limit value
- " * ": Fundamental frequency.
- " # ": The radiated frequency is out of the restricted band.

CHANNEL	TX Channel 149	DETECTOR FUNCTION	Peak (PK)
FREQUENCY RANGE	1GHz ~ 40GHz		Average (AV)

ANTENNA POLARITY & TEST DISTANCE: HORIZONTAL AT 3 M

NO.	FREQ. (MHz)	EMISSION LEVEL (dBuV/m)	LIMIT (dBuV/m)	MARGIN (dB)	ANTENNA HEIGHT (m)	TABLE ANGLE (Degree)	RAW VALUE (dBuV)	CORRECTION FACTOR (dB/m)
1	#5644.72	60.5 PK	68.2	-7.7	1.11 H	173	57.3	3.2
2	*5745.00	124.3 PK			1.11 H	173	120.7	3.6
3	*5745.00	114.4 AV			1.11 H	173	110.8	3.6
4	#5928.81	62.1 PK	68.2	-6.1	1.11 H	173	58.2	3.9
5	11490.00	57.6 PK	74.0	-16.4	1.15 H	28	43.8	13.8
6	11490.00	44.6 AV	54.0	-9.4	1.15 H	28	30.8	13.8
7	#17235.00	52.8 PK	68.2	-15.4	1.26 H	62	35.7	17.1

ANTENNA POLARITY & TEST DISTANCE: VERTICAL AT 3 M

NO.	FREQ. (MHz)	EMISSION LEVEL (dBuV/m)	LIMIT (dBuV/m)	MARGIN (dB)	ANTENNA HEIGHT (m)	TABLE ANGLE (Degree)	RAW VALUE (dBuV)	CORRECTION FACTOR (dB/m)
1	#5562.28	60.2 PK	68.2	-8.0	1.08 V	301	57.0	3.2
2	*5745.00	118.7 PK			1.08 V	301	115.1	3.6
3	*5745.00	109.0 AV			1.08 V	301	105.4	3.6
4	#5944.61	61.0 PK	68.2	-7.2	1.08 V	301	57.1	3.9
5	11490.00	60.2 PK	74.0	-13.8	1.22 V	259	46.4	13.8
6	11490.00	47.3 AV	54.0	-6.7	1.22 V	259	33.5	13.8
7	#17235.00	53.7 PK	68.2	-14.5	2.12 V	152	36.6	17.1

REMARKS:

1. Emission Level(dBuV/m) = Raw Value(dBuV) + Correction Factor(dB/m)
2. Correction Factor(dB/m) = Antenna Factor(dB/m) + Cable Factor(dB) – Pre-Amplifier Factor(dB)
3. The other emission levels were very low against the limit.
4. Margin value = Emission Level – Limit value
5. " * ": Fundamental frequency.
6. " # ": The radiated frequency is out of the restricted band.

CHANNEL	TX Channel 157	DETECTOR FUNCTION	Peak (PK)
FREQUENCY RANGE	1GHz ~ 40GHz		Average (AV)

ANTENNA POLARITY & TEST DISTANCE: HORIZONTAL AT 3 M

NO.	FREQ. (MHz)	EMISSION LEVEL (dBuV/m)	LIMIT (dBuV/m)	MARGIN (dB)	ANTENNA HEIGHT (m)	TABLE ANGLE (Degree)	RAW VALUE (dBuV)	CORRECTION FACTOR (dB/m)
1	#5584.54	61.3 PK	68.2	-6.9	1.15 H	178	58.0	3.3
2	*5785.00	124.0 PK			1.15 H	178	120.4	3.6
3	*5785.00	114.2 AV			1.15 H	178	110.6	3.6
4	#5935.91	62.0 PK	68.2	-6.2	1.15 H	178	58.1	3.9
5	11570.00	57.3 PK	74.0	-16.7	1.17 H	17	43.6	13.7
6	11570.00	44.5 AV	54.0	-9.5	1.17 H	17	30.8	13.7
7	#17355.00	53.2 PK	68.2	-15.0	1.26 H	65	35.6	17.6

ANTENNA POLARITY & TEST DISTANCE: VERTICAL AT 3 M

NO.	FREQ. (MHz)	EMISSION LEVEL (dBuV/m)	LIMIT (dBuV/m)	MARGIN (dB)	ANTENNA HEIGHT (m)	TABLE ANGLE (Degree)	RAW VALUE (dBuV)	CORRECTION FACTOR (dB/m)
1	#5615.10	59.1 PK	68.2	-9.1	1.20 V	301	55.7	3.4
2	*5785.00	118.2 PK			1.20 V	301	114.6	3.6
3	*5785.00	108.5 AV			1.20 V	301	104.9	3.6
4	#6008.72	60.3 PK	68.2	-7.9	1.20 V	301	56.3	4.0
5	11570.00	60.2 PK	74.0	-13.8	1.23 V	264	46.5	13.7
6	11570.00	47.1 AV	54.0	-6.9	1.23 V	264	33.4	13.7
7	#17355.00	53.3 PK	68.2	-14.9	2.12 V	150	35.7	17.6

REMARKS:

1. Emission Level(dBuV/m) = Raw Value(dBuV) + Correction Factor(dB/m)
2. Correction Factor(dB/m) = Antenna Factor(dB/m) + Cable Factor(dB) – Pre-Amplifier Factor(dB)
3. The other emission levels were very low against the limit.
4. Margin value = Emission Level – Limit value
5. " * ": Fundamental frequency.
6. " # ": The radiated frequency is out of the restricted band.

CHANNEL	TX Channel 165	DETECTOR FUNCTION	Peak (PK)
FREQUENCY RANGE	1GHz ~ 40GHz		Average (AV)

ANTENNA POLARITY & TEST DISTANCE: HORIZONTAL AT 3 M

NO.	FREQ. (MHz)	EMISSION LEVEL (dBuV/m)	LIMIT (dBuV/m)	MARGIN (dB)	ANTENNA HEIGHT (m)	TABLE ANGLE (Degree)	RAW VALUE (dBuV)	CORRECTION FACTOR (dB/m)
1	#5595.66	61.1 PK	68.2	-7.1	1.15 H	180	57.8	3.3
2	*5825.00	124.0 PK			1.15 H	180	120.2	3.8
3	*5825.00	114.1 AV			1.15 H	180	110.3	3.8
4	#5957.78	62.1 PK	68.2	-6.1	1.15 H	180	58.2	3.9
5	11650.00	57.7 PK	74.0	-16.3	1.12 H	13	44.1	13.6
6	11650.00	44.7 AV	54.0	-9.3	1.12 H	13	31.1	13.6
7	#17475.00	52.8 PK	68.2	-15.4	1.28 H	68	34.2	18.6

ANTENNA POLARITY & TEST DISTANCE: VERTICAL AT 3 M

NO.	FREQ. (MHz)	EMISSION LEVEL (dBuV/m)	LIMIT (dBuV/m)	MARGIN (dB)	ANTENNA HEIGHT (m)	TABLE ANGLE (Degree)	RAW VALUE (dBuV)	CORRECTION FACTOR (dB/m)
1	#5569.56	59.7 PK	68.2	-8.5	1.14 V	303	56.4	3.3
2	*5825.00	118.6 PK			1.14 V	303	114.8	3.8
3	*5825.00	108.8 AV			1.14 V	303	105.0	3.8
4	#5935.77	60.9 PK	68.2	-7.3	1.14 V	303	57.0	3.9
5	11650.00	60.2 PK	74.0	-13.8	1.28 V	274	46.6	13.6
6	11650.00	47.2 AV	54.0	-6.8	1.28 V	274	33.6	13.6
7	#17475.00	53.7 PK	68.2	-14.5	2.12 V	143	35.1	18.6

REMARKS:

1. Emission Level(dBuV/m) = Raw Value(dBuV) + Correction Factor(dB/m)
2. Correction Factor(dB/m) = Antenna Factor(dB/m) + Cable Factor(dB) – Pre-Amplifier Factor(dB)
3. The other emission levels were very low against the limit.
4. Margin value = Emission Level – Limit value
5. " * ": Fundamental frequency.
6. " # ": The radiated frequency is out of the restricted band.

802.11ac (VHT20)

CHANNEL	TX Channel 36	DETECTOR FUNCTION	Peak (PK)
FREQUENCY RANGE	1GHz ~ 40GHz		Average (AV)

ANTENNA POLARITY & TEST DISTANCE: HORIZONTAL AT 3 M								
NO.	FREQ. (MHz)	EMISSION LEVEL (dBuV/m)	LIMIT (dBuV/m)	MARGIN (dB)	ANTENNA HEIGHT (m)	TABLE ANGLE (Degree)	RAW VALUE (dBuV)	CORRECTION FACTOR (dB/m)
1	5150.00	66.5 PK	74.0	-7.5	1.00 H	193	63.5	3.0
2	5150.00	53.3 AV	54.0	-0.7	1.00 H	193	50.3	3.0
3	*5180.00	120.9 PK			1.00 H	193	118.0	2.9
4	*5180.00	111.2 AV			1.00 H	193	108.3	2.9
5	#10360.00	54.6 PK	68.2	-13.6	1.42 H	41	41.6	13.0
6	15540.00	49.4 PK	74.0	-24.6	1.29 H	36	36.3	13.1
7	15540.00	40.0 AV	54.0	-14.0	1.29 H	36	26.9	13.1

ANTENNA POLARITY & TEST DISTANCE: VERTICAL AT 3 M								
NO.	FREQ. (MHz)	EMISSION LEVEL (dBuV/m)	LIMIT (dBuV/m)	MARGIN (dB)	ANTENNA HEIGHT (m)	TABLE ANGLE (Degree)	RAW VALUE (dBuV)	CORRECTION FACTOR (dB/m)
1	5150.00	62.6 PK	74.0	-11.4	1.25 V	310	59.6	3.0
2	5150.00	46.7 AV	54.0	-7.3	1.25 V	310	43.7	3.0
3	*5180.00	114.8 PK			1.25 V	310	111.9	2.9
4	*5180.00	105.2 AV			1.25 V	310	102.3	2.9
5	#10360.00	56.9 PK	68.2	-11.3	1.26 V	251	43.9	13.0
6	15540.00	53.9 PK	74.0	-20.1	2.08 V	143	40.8	13.1
7	15540.00	42.6 AV	54.0	-11.4	2.08 V	143	29.5	13.1

REMARKS:

1. Emission Level(dBuV/m) = Raw Value(dBuV) + Correction Factor(dB/m)
2. Correction Factor(dB/m) = Antenna Factor(dB/m) + Cable Factor(dB) – Pre-Amplifier Factor(dB)
3. The other emission levels were very low against the limit.
4. Margin value = Emission Level – Limit value
5. " * ": Fundamental frequency.
6. " # ": The radiated frequency is out of the restricted band.

CHANNEL	TX Channel 40	DETECTOR FUNCTION	Peak (PK)
FREQUENCY RANGE	1GHz ~ 40GHz		Average (AV)

ANTENNA POLARITY & TEST DISTANCE: HORIZONTAL AT 3 M

NO.	FREQ. (MHz)	EMISSION LEVEL (dBuV/m)	LIMIT (dBuV/m)	MARGIN (dB)	ANTENNA HEIGHT (m)	TABLE ANGLE (Degree)	RAW VALUE (dBuV)	CORRECTION FACTOR (dB/m)
1	5150.00	58.9 PK	74.0	-15.1	1.16 H	185	55.9	3.0
2	5150.00	48.3 AV	54.0	-5.7	1.16 H	185	45.3	3.0
3	*5200.00	124.3 PK			1.16 H	185	121.4	2.9
4	*5200.00	114.6 AV			1.16 H	185	111.7	2.9
5	#10400.00	58.7 PK	68.2	-9.5	1.38 H	13	45.6	13.1
6	15600.00	49.9 PK	74.0	-24.1	1.24 H	59	36.9	13.0
7	15600.00	40.5 AV	54.0	-13.5	1.24 H	59	27.5	13.0

ANTENNA POLARITY & TEST DISTANCE: VERTICAL AT 3 M

NO.	FREQ. (MHz)	EMISSION LEVEL (dBuV/m)	LIMIT (dBuV/m)	MARGIN (dB)	ANTENNA HEIGHT (m)	TABLE ANGLE (Degree)	RAW VALUE (dBuV)	CORRECTION FACTOR (dB/m)
1	5150.00	54.6 PK	74.0	-19.4	1.20 V	314	51.6	3.0
2	5150.00	42.8 AV	54.0	-11.2	1.20 V	314	39.8	3.0
3	*5200.00	118.2 PK			1.20 V	314	115.3	2.9
4	*5200.00	108.6 AV			1.20 V	314	105.7	2.9
5	#10400.00	60.9 PK	68.2	-7.3	1.26 V	267	47.8	13.1
6	15600.00	53.6 PK	74.0	-20.4	2.14 V	164	40.6	13.0
7	15600.00	42.4 AV	54.0	-11.6	2.14 V	164	29.4	13.0

REMARKS:

1. Emission Level(dBuV/m) = Raw Value(dBuV) + Correction Factor(dB/m)
2. Correction Factor(dB/m) = Antenna Factor(dB/m) + Cable Factor(dB) – Pre-Amplifier Factor(dB)
3. The other emission levels were very low against the limit.
4. Margin value = Emission Level – Limit value
5. " * ": Fundamental frequency.
6. " # ": The radiated frequency is out of the restricted band.

CHANNEL	TX Channel 48	DETECTOR FUNCTION	Peak (PK)
FREQUENCY RANGE	1GHz ~ 40GHz		Average (AV)

ANTENNA POLARITY & TEST DISTANCE: HORIZONTAL AT 3 M

NO.	FREQ. (MHz)	EMISSION LEVEL (dBuV/m)	LIMIT (dBuV/m)	MARGIN (dB)	ANTENNA HEIGHT (m)	TABLE ANGLE (Degree)	RAW VALUE (dBuV)	CORRECTION FACTOR (dB/m)
1	*5240.00	124.6 PK			1.14 H	183	122.1	2.5
2	*5240.00	115.1 AV			1.14 H	183	112.6	2.5
3	5350.00	53.1 PK	74.0	-20.9	1.14 H	183	50.3	2.8
4	5350.00	41.0 AV	54.0	-13.0	1.14 H	183	38.2	2.8
5	#10480.00	58.7 PK	68.2	-9.5	1.29 H	22	45.5	13.2
6	15720.00	49.0 PK	74.0	-25.0	1.22 H	55	36.6	12.4
7	15720.00	39.8 AV	54.0	-14.2	1.22 H	55	27.4	12.4

ANTENNA POLARITY & TEST DISTANCE: VERTICAL AT 3 M

NO.	FREQ. (MHz)	EMISSION LEVEL (dBuV/m)	LIMIT (dBuV/m)	MARGIN (dB)	ANTENNA HEIGHT (m)	TABLE ANGLE (Degree)	RAW VALUE (dBuV)	CORRECTION FACTOR (dB/m)
1	*5240.00	118.5 PK			1.20 V	308	116.0	2.5
2	*5240.00	109.1 AV			1.20 V	308	106.6	2.5
3	5350.00	52.9 PK	74.0	-21.1	1.20 V	308	50.1	2.8
4	5350.00	40.9 AV	54.0	-13.1	1.20 V	308	38.1	2.8
5	#10480.00	61.4 PK	68.2	-6.8	1.32 V	287	48.2	13.2
6	15720.00	53.4 PK	74.0	-20.6	2.07 V	161	41.0	12.4
7	15720.00	42.5 AV	54.0	-11.5	2.07 V	161	30.1	12.4

REMARKS:

1. Emission Level(dBuV/m) = Raw Value(dBuV) + Correction Factor(dB/m)
2. Correction Factor(dB/m) = Antenna Factor(dB/m) + Cable Factor(dB) – Pre-Amplifier Factor(dB)
3. The other emission levels were very low against the limit.
4. Margin value = Emission Level – Limit value
5. " * ": Fundamental frequency.
6. " # ": The radiated frequency is out of the restricted band.

CHANNEL	TX Channel 149	DETECTOR FUNCTION	Peak (PK)
FREQUENCY RANGE	1GHz ~ 40GHz		Average (AV)

ANTENNA POLARITY & TEST DISTANCE: HORIZONTAL AT 3 M

NO.	FREQ. (MHz)	EMISSION LEVEL (dBuV/m)	LIMIT (dBuV/m)	MARGIN (dB)	ANTENNA HEIGHT (m)	TABLE ANGLE (Degree)	RAW VALUE (dBuV)	CORRECTION FACTOR (dB/m)
1	#5601.03	61.9 PK	68.2	-6.3	1.17 H	189	58.5	3.4
2	*5745.00	123.9 PK			1.17 H	189	120.3	3.6
3	*5745.00	114.2 AV			1.17 H	189	110.6	3.6
4	#5989.34	62.3 PK	68.2	-5.9	1.17 H	189	58.3	4.0
5	11490.00	57.6 PK	74.0	-16.4	1.11 H	21	43.8	13.8
6	11490.00	44.8 AV	54.0	-9.2	1.11 H	21	31.0	13.8
7	#17235.00	52.6 PK	68.2	-15.6	1.33 H	66	35.5	17.1

ANTENNA POLARITY & TEST DISTANCE: VERTICAL AT 3 M

NO.	FREQ. (MHz)	EMISSION LEVEL (dBuV/m)	LIMIT (dBuV/m)	MARGIN (dB)	ANTENNA HEIGHT (m)	TABLE ANGLE (Degree)	RAW VALUE (dBuV)	CORRECTION FACTOR (dB/m)
1	#5615.70	61.0 PK	68.2	-7.2	1.17 V	299	57.6	3.4
2	*5745.00	117.8 PK			1.17 V	299	114.2	3.6
3	*5745.00	108.2 AV			1.17 V	299	104.6	3.6
4	#6013.47	62.6 PK	68.2	-5.6	1.17 V	299	58.6	4.0
5	11490.00	59.9 PK	74.0	-14.1	1.24 V	281	46.1	13.8
6	11490.00	47.0 AV	54.0	-7.0	1.24 V	281	33.2	13.8
7	#17235.00	53.4 PK	68.2	-14.8	2.15 V	138	36.3	17.1

REMARKS:

1. Emission Level(dBuV/m) = Raw Value(dBuV) + Correction Factor(dB/m)
2. Correction Factor(dB/m) = Antenna Factor(dB/m) + Cable Factor(dB) – Pre-Amplifier Factor(dB)
3. The other emission levels were very low against the limit.
4. Margin value = Emission Level – Limit value
5. " * ": Fundamental frequency.
6. " # ": The radiated frequency is out of the restricted band.

CHANNEL	TX Channel 157	DETECTOR FUNCTION	Peak (PK)
FREQUENCY RANGE	1GHz ~ 40GHz		Average (AV)

ANTENNA POLARITY & TEST DISTANCE: HORIZONTAL AT 3 M

NO.	FREQ. (MHz)	EMISSION LEVEL (dBuV/m)	LIMIT (dBuV/m)	MARGIN (dB)	ANTENNA HEIGHT (m)	TABLE ANGLE (Degree)	RAW VALUE (dBuV)	CORRECTION FACTOR (dB/m)
1	#5623.19	62.5 PK	68.2	-5.7	1.16 H	185	59.1	3.4
2	*5785.00	123.6 PK			1.16 H	185	120.0	3.6
3	*5785.00	114.0 AV			1.16 H	185	110.4	3.6
4	#5958.46	62.6 PK	68.2	-5.6	1.16 H	185	58.7	3.9
5	11570.00	57.4 PK	74.0	-16.6	1.13 H	0	43.7	13.7
6	11570.00	44.4 AV	54.0	-9.6	1.13 H	0	30.7	13.7
7	#17355.00	53.1 PK	68.2	-15.1	1.29 H	75	35.5	17.6

ANTENNA POLARITY & TEST DISTANCE: VERTICAL AT 3 M

NO.	FREQ. (MHz)	EMISSION LEVEL (dBuV/m)	LIMIT (dBuV/m)	MARGIN (dB)	ANTENNA HEIGHT (m)	TABLE ANGLE (Degree)	RAW VALUE (dBuV)	CORRECTION FACTOR (dB/m)
1	#5577.60	59.9 PK	68.2	-8.3	1.21 V	297	56.6	3.3
2	*5785.00	117.5 PK			1.21 V	297	113.9	3.6
3	*5785.00	107.8 AV			1.21 V	297	104.2	3.6
4	#5955.19	62.1 PK	68.2	-6.1	1.21 V	297	58.2	3.9
5	11570.00	60.4 PK	74.0	-13.6	1.28 V	276	46.7	13.7
6	11570.00	47.4 AV	54.0	-6.6	1.28 V	276	33.7	13.7
7	#17355.00	53.5 PK	68.2	-14.7	2.12 V	144	35.9	17.6

REMARKS:

1. Emission Level(dBuV/m) = Raw Value(dBuV) + Correction Factor(dB/m)
2. Correction Factor(dB/m) = Antenna Factor(dB/m) + Cable Factor(dB) – Pre-Amplifier Factor(dB)
3. The other emission levels were very low against the limit.
4. Margin value = Emission Level – Limit value
5. " * ": Fundamental frequency.
6. " # ": The radiated frequency is out of the restricted band.

CHANNEL	TX Channel 165	DETECTOR FUNCTION	Peak (PK)
FREQUENCY RANGE	1GHz ~ 40GHz		Average (AV)

ANTENNA POLARITY & TEST DISTANCE: HORIZONTAL AT 3 M

NO.	FREQ. (MHz)	EMISSION LEVEL (dBuV/m)	LIMIT (dBuV/m)	MARGIN (dB)	ANTENNA HEIGHT (m)	TABLE ANGLE (Degree)	RAW VALUE (dBuV)	CORRECTION FACTOR (dB/m)
1	#5595.74	61.8 PK	68.2	-6.4	1.07 H	192	58.5	3.3
2	*5825.00	123.8 PK			1.07 H	192	120.0	3.8
3	*5825.00	114.1 AV			1.07 H	192	110.3	3.8
4	#5973.89	63.6 PK	68.2	-4.6	1.07 H	192	59.6	4.0
5	11650.00	57.7 PK	74.0	-16.3	1.16 H	0	44.1	13.6
6	11650.00	44.6 AV	54.0	-9.4	1.16 H	0	31.0	13.6
7	#17475.00	52.6 PK	68.2	-15.6	1.32 H	61	34.0	18.6

ANTENNA POLARITY & TEST DISTANCE: VERTICAL AT 3 M

NO.	FREQ. (MHz)	EMISSION LEVEL (dBuV/m)	LIMIT (dBuV/m)	MARGIN (dB)	ANTENNA HEIGHT (m)	TABLE ANGLE (Degree)	RAW VALUE (dBuV)	CORRECTION FACTOR (dB/m)
1	#5566.17	59.8 PK	68.2	-8.4	1.09 V	302	56.5	3.3
2	*5825.00	118.1 PK			1.09 V	302	114.3	3.8
3	*5825.00	108.5 AV			1.09 V	302	104.7	3.8
4	#6000.51	62.6 PK	68.2	-5.6	1.09 V	302	58.6	4.0
5	11650.00	59.5 PK	74.0	-14.5	1.31 V	273	45.9	13.6
6	11650.00	46.8 AV	54.0	-7.2	1.31 V	273	33.2	13.6
7	#17475.00	54.1 PK	68.2	-14.1	2.08 V	155	35.5	18.6

REMARKS:

1. Emission Level(dBuV/m) = Raw Value(dBuV) + Correction Factor(dB/m)
2. Correction Factor(dB/m) = Antenna Factor(dB/m) + Cable Factor(dB) – Pre-Amplifier Factor(dB)
3. The other emission levels were very low against the limit.
4. Margin value = Emission Level – Limit value
5. " * ": Fundamental frequency.
6. " # ": The radiated frequency is out of the restricted band.

802.11ac (VHT40)

CHANNEL	TX Channel 38	DETECTOR FUNCTION	Peak (PK)
FREQUENCY RANGE	1GHz ~ 40GHz		Average (AV)

ANTENNA POLARITY & TEST DISTANCE: HORIZONTAL AT 3 M

NO.	FREQ. (MHz)	EMISSION LEVEL (dBuV/m)	LIMIT (dBuV/m)	MARGIN (dB)	ANTENNA HEIGHT (m)	TABLE ANGLE (Degree)	RAW VALUE (dBuV)	CORRECTION FACTOR (dB/m)
1	5150.00	67.3 PK	74.0	-6.7	1.20 H	185	64.3	3.0
2	5150.00	53.2 AV	54.0	-0.8	1.20 H	185	50.2	3.0
3	*5190.00	112.2 PK			1.20 H	185	109.3	2.9
4	*5190.00	103.1 AV			1.20 H	185	100.2	2.9
5	#10380.00	53.9 PK	68.2	-14.3	1.37 H	32	40.9	13.0
6	15570.00	49.7 PK	74.0	-24.3	1.35 H	49	36.7	13.0
7	15570.00	40.3 AV	54.0	-13.7	1.35 H	49	27.3	13.0

ANTENNA POLARITY & TEST DISTANCE: VERTICAL AT 3 M

NO.	FREQ. (MHz)	EMISSION LEVEL (dBuV/m)	LIMIT (dBuV/m)	MARGIN (dB)	ANTENNA HEIGHT (m)	TABLE ANGLE (Degree)	RAW VALUE (dBuV)	CORRECTION FACTOR (dB/m)
1	5150.00	62.5 PK	74.0	-11.5	1.15 V	291	59.5	3.0
2	5150.00	46.7 AV	54.0	-7.3	1.15 V	291	43.7	3.0
3	*5190.00	111.6 PK			1.15 V	291	108.7	2.9
4	*5190.00	96.8 AV			1.15 V	291	93.9	2.9
5	#10380.00	56.0 PK	68.2	-12.2	1.33 V	253	43.0	13.0
6	15570.00	53.1 PK	74.0	-20.9	2.16 V	127	40.1	13.0
7	15570.00	42.3 AV	54.0	-11.7	2.16 V	127	29.3	13.0

REMARKS:

1. Emission Level(dBuV/m) = Raw Value(dBuV) + Correction Factor(dB/m)
2. Correction Factor(dB/m) = Antenna Factor(dB/m) + Cable Factor(dB) – Pre-Amplifier Factor(dB)
3. The other emission levels were very low against the limit.
4. Margin value = Emission Level – Limit value
5. " * ": Fundamental frequency.
6. " # ": The radiated frequency is out of the restricted band.

CHANNEL	TX Channel 46	DETECTOR FUNCTION	Peak (PK)
FREQUENCY RANGE	1GHz ~ 40GHz		Average (AV)

ANTENNA POLARITY & TEST DISTANCE: HORIZONTAL AT 3 M

NO.	FREQ. (MHz)	EMISSION LEVEL (dBuV/m)	LIMIT (dBuV/m)	MARGIN (dB)	ANTENNA HEIGHT (m)	TABLE ANGLE (Degree)	RAW VALUE (dBuV)	CORRECTION FACTOR (dB/m)
1	5150.00	66.5 PK	74.0	-7.5	1.12 H	184	63.5	3.0
2	5150.00	50.7 AV	54.0	-3.3	1.12 H	184	47.7	3.0
3	*5230.00	122.0 PK			1.12 H	184	119.4	2.6
4	*5230.00	112.4 AV			1.12 H	184	109.8	2.6
5	5350.00	54.3 PK	74.0	-19.7	1.12 H	184	51.5	2.8
6	5350.00	43.0 AV	54.0	-11.0	1.12 H	184	40.2	2.8
7	#10460.00	58.6 PK	68.2	-9.6	1.33 H	15	45.4	13.2
8	15690.00	48.9 PK	74.0	-25.1	1.25 H	43	36.6	12.3
9	15690.00	39.8 AV	54.0	-14.2	1.25 H	43	27.5	12.3

ANTENNA POLARITY & TEST DISTANCE: VERTICAL AT 3 M

NO.	FREQ. (MHz)	EMISSION LEVEL (dBuV/m)	LIMIT (dBuV/m)	MARGIN (dB)	ANTENNA HEIGHT (m)	TABLE ANGLE (Degree)	RAW VALUE (dBuV)	CORRECTION FACTOR (dB/m)
1	5150.00	61.3 PK	74.0	-12.7	1.25 V	302	58.3	3.0
2	5150.00	45.4 AV	54.0	-8.6	1.25 V	302	42.4	3.0
3	*5230.00	121.4 PK			1.25 V	302	118.8	2.6
4	*5230.00	106.1 AV			1.25 V	302	103.5	2.6
5	5350.00	53.4 PK	74.0	-20.6	1.25 V	302	50.6	2.8
6	5350.00	41.1 AV	54.0	-12.9	1.25 V	302	38.3	2.8
7	#10460.00	61.2 PK	68.2	-7.0	1.34 V	283	48.0	13.2
8	15690.00	53.6 PK	74.0	-20.4	2.07 V	163	41.3	12.3
9	15690.00	42.9 AV	54.0	-11.1	2.07 V	163	30.6	12.3

REMARKS:

1. Emission Level(dBuV/m) = Raw Value(dBuV) + Correction Factor(dB/m)
2. Correction Factor(dB/m) = Antenna Factor(dB/m) + Cable Factor(dB) – Pre-Amplifier Factor(dB)
3. The other emission levels were very low against the limit.
4. Margin value = Emission Level – Limit value
5. " * ": Fundamental frequency.
6. " # ": The radiated frequency is out of the restricted band.

CHANNEL	TX Channel 151	DETECTOR FUNCTION	Peak (PK)
FREQUENCY RANGE	1GHz ~ 40GHz		Average (AV)

ANTENNA POLARITY & TEST DISTANCE: HORIZONTAL AT 3 M

NO.	FREQ. (MHz)	EMISSION LEVEL (dBuV/m)	LIMIT (dBuV/m)	MARGIN (dB)	ANTENNA HEIGHT (m)	TABLE ANGLE (Degree)	RAW VALUE (dBuV)	CORRECTION FACTOR (dB/m)
1	#5560.45	58.8 PK	68.2	-9.4	1.04 H	183	55.6	3.2
2	*5755.00	120.1 PK			1.04 H	183	116.5	3.6
3	*5755.00	110.6 AV			1.04 H	183	107.0	3.6
4	#5936.65	59.2 PK	68.2	-9.0	1.04 H	183	55.3	3.9
5	11510.00	57.6 PK	74.0	-16.4	1.09 H	19	43.8	13.8
6	11510.00	44.7 AV	54.0	-9.3	1.09 H	19	30.9	13.8
7	#17265.00	52.9 PK	68.2	-15.3	1.24 H	84	35.8	17.1

ANTENNA POLARITY & TEST DISTANCE: VERTICAL AT 3 M

NO.	FREQ. (MHz)	EMISSION LEVEL (dBuV/m)	LIMIT (dBuV/m)	MARGIN (dB)	ANTENNA HEIGHT (m)	TABLE ANGLE (Degree)	RAW VALUE (dBuV)	CORRECTION FACTOR (dB/m)
1	#5580.40	58.2 PK	68.2	-10.0	1.20 V	300	54.9	3.3
2	*5755.00	114.1 PK			1.20 V	300	110.5	3.6
3	*5755.00	104.3 AV			1.20 V	300	100.7	3.6
4	#5930.48	59.9 PK	68.2	-8.3	1.20 V	300	56.0	3.9
5	11510.00	60.0 PK	74.0	-14.0	1.27 V	272	46.2	13.8
6	11510.00	47.0 AV	54.0	-7.0	1.27 V	272	33.2	13.8
7	#17265.00	53.5 PK	68.2	-14.7	2.13 V	149	36.4	17.1

REMARKS:

1. Emission Level(dBuV/m) = Raw Value(dBuV) + Correction Factor(dB/m)
2. Correction Factor(dB/m) = Antenna Factor(dB/m) + Cable Factor(dB) – Pre-Amplifier Factor(dB)
3. The other emission levels were very low against the limit.
4. Margin value = Emission Level – Limit value
5. " * ": Fundamental frequency.
6. " # ": The radiated frequency is out of the restricted band.

CHANNEL	TX Channel 159	DETECTOR FUNCTION	Peak (PK)
FREQUENCY RANGE	1GHz ~ 40GHz		Average (AV)

ANTENNA POLARITY & TEST DISTANCE: HORIZONTAL AT 3 M

NO.	FREQ. (MHz)	EMISSION LEVEL (dBuV/m)	LIMIT (dBuV/m)	MARGIN (dB)	ANTENNA HEIGHT (m)	TABLE ANGLE (Degree)	RAW VALUE (dBuV)	CORRECTION FACTOR (dB/m)
1	#5555.23	60.1 PK	68.2	-8.1	1.16 H	178	56.9	3.2
2	*5795.00	120.5 PK			1.16 H	178	116.9	3.6
3	*5795.00	110.8 AV			1.16 H	178	107.2	3.6
4	#6006.00	60.2 PK	68.2	-8.0	1.16 H	178	56.2	4.0
5	11590.00	57.3 PK	74.0	-16.7	1.08 H	0	43.7	13.6
6	11590.00	44.6 AV	54.0	-9.4	1.08 H	0	31.0	13.6
7	#17385.00	52.9 PK	68.2	-15.3	1.29 H	60	35.0	17.9

ANTENNA POLARITY & TEST DISTANCE: VERTICAL AT 3 M

NO.	FREQ. (MHz)	EMISSION LEVEL (dBuV/m)	LIMIT (dBuV/m)	MARGIN (dB)	ANTENNA HEIGHT (m)	TABLE ANGLE (Degree)	RAW VALUE (dBuV)	CORRECTION FACTOR (dB/m)
1	#5605.10	58.1 PK	68.2	-10.1	1.11 V	301	54.7	3.4
2	*5795.00	113.9 PK			1.11 V	301	110.3	3.6
3	*5795.00	104.1 AV			1.11 V	301	100.5	3.6
4	#5974.18	59.5 PK	68.2	-8.7	1.11 V	301	55.5	4.0
5	11590.00	60.6 PK	74.0	-13.4	1.23 V	278	47.0	13.6
6	11590.00	47.5 AV	54.0	-6.5	1.23 V	278	33.9	13.6
7	#17385.00	53.3 PK	68.2	-14.9	2.07 V	141	35.4	17.9

REMARKS:

1. Emission Level(dBuV/m) = Raw Value(dBuV) + Correction Factor(dB/m)
2. Correction Factor(dB/m) = Antenna Factor(dB/m) + Cable Factor(dB) – Pre-Amplifier Factor(dB)
3. The other emission levels were very low against the limit.
4. Margin value = Emission Level – Limit value
5. " * ": Fundamental frequency.
6. " # ": The radiated frequency is out of the restricted band.

802.11ac (VHT80)

CHANNEL	TX Channel 42	DETECTOR FUNCTION	Peak (PK)
FREQUENCY RANGE	1GHz ~ 40GHz		Average (AV)

ANTENNA POLARITY & TEST DISTANCE: HORIZONTAL AT 3 M								
NO.	FREQ. (MHz)	EMISSION LEVEL (dBuV/m)	LIMIT (dBuV/m)	MARGIN (dB)	ANTENNA HEIGHT (m)	TABLE ANGLE (Degree)	RAW VALUE (dBuV)	CORRECTION FACTOR (dB/m)
1	5150.00	65.4 PK	74.0	-8.6	1.11 H	188	62.4	3.0
2	5150.00	53.1 AV	54.0	-0.9	1.11 H	188	50.1	3.0
3	*5210.00	106.6 PK			1.11 H	188	103.8	2.8
4	*5210.00	97.3 AV			1.11 H	188	94.5	2.8
5	5350.00	52.7 PK	74.0	-21.3	1.11 H	188	49.9	2.8
6	5350.00	42.2 AV	54.0	-11.8	1.11 H	188	39.4	2.8
7	#10420.00	54.3 PK	68.2	-13.9	1.44 H	40	41.2	13.1
8	15630.00	50.0 PK	74.0	-24.0	1.34 H	53	37.2	12.8
9	15630.00	40.6 AV	54.0	-13.4	1.34 H	53	27.8	12.8

ANTENNA POLARITY & TEST DISTANCE: VERTICAL AT 3 M								
NO.	FREQ. (MHz)	EMISSION LEVEL (dBuV/m)	LIMIT (dBuV/m)	MARGIN (dB)	ANTENNA HEIGHT (m)	TABLE ANGLE (Degree)	RAW VALUE (dBuV)	CORRECTION FACTOR (dB/m)
1	5150.00	62.4 PK	74.0	-11.6	1.15 V	299	59.4	3.0
2	5150.00	46.4 AV	54.0	-7.6	1.15 V	299	43.4	3.0
3	*5210.00	99.5 PK			1.15 V	299	96.7	2.8
4	*5210.00	90.7 AV			1.15 V	299	87.9	2.8
5	5350.00	53.2 PK	74.0	-20.8	1.15 V	299	50.4	2.8
6	5350.00	41.0 AV	54.0	-13.0	1.15 V	299	38.2	2.8
7	#10420.00	56.2 PK	68.2	-12.0	1.32 V	257	43.1	13.1
8	15630.00	53.4 PK	74.0	-20.6	2.15 V	147	40.6	12.8
9	15630.00	42.1 AV	54.0	-11.9	2.15 V	147	29.3	12.8

REMARKS:

1. Emission Level(dBuV/m) = Raw Value(dBuV) + Correction Factor(dB/m)
2. Correction Factor(dB/m) = Antenna Factor(dB/m) + Cable Factor(dB) – Pre-Amplifier Factor(dB)
3. The other emission levels were very low against the limit.
4. Margin value = Emission Level – Limit value
5. " * ": Fundamental frequency.
6. " # ": The radiated frequency is out of the restricted band.

CHANNEL	TX Channel 155	DETECTOR FUNCTION	Peak (PK)
FREQUENCY RANGE	1GHz ~ 40GHz		Average (AV)

ANTENNA POLARITY & TEST DISTANCE: HORIZONTAL AT 3 M

NO.	FREQ. (MHz)	EMISSION LEVEL (dBuV/m)	LIMIT (dBuV/m)	MARGIN (dB)	ANTENNA HEIGHT (m)	TABLE ANGLE (Degree)	RAW VALUE (dBuV)	CORRECTION FACTOR (dB/m)
1	#5645.48	67.3 PK	68.2	-0.9	1.24 H	178	64.1	3.2
2	*5775.00	114.5 PK			1.24 H	178	110.9	3.6
3	*5775.00	104.8 AV			1.24 H	178	101.2	3.6
4	#5927.15	63.8 PK	68.2	-4.4	1.24 H	178	59.9	3.9
5	11550.00	57.8 PK	74.0	-16.2	1.18 H	4	44.2	13.6
6	11550.00	45.0 AV	54.0	-9.0	1.18 H	4	31.4	13.6
7	#17325.00	53.2 PK	68.2	-15.0	1.28 H	63	35.8	17.4

ANTENNA POLARITY & TEST DISTANCE: VERTICAL AT 3 M

NO.	FREQ. (MHz)	EMISSION LEVEL (dBuV/m)	LIMIT (dBuV/m)	MARGIN (dB)	ANTENNA HEIGHT (m)	TABLE ANGLE (Degree)	RAW VALUE (dBuV)	CORRECTION FACTOR (dB/m)
1	#5650.70	62.7 PK	68.7	-6.0	1.19 V	300	59.5	3.2
2	*5775.00	107.4 PK			1.19 V	300	103.8	3.6
3	*5775.00	98.2 AV			1.19 V	300	94.6	3.6
4	#6014.07	58.8 PK	68.2	-9.4	1.19 V	300	54.8	4.0
5	11550.00	60.0 PK	74.0	-14.0	1.25 V	263	46.4	13.6
6	11550.00	47.0 AV	54.0	-7.0	1.25 V	263	33.4	13.6
7	#17325.00	53.0 PK	68.2	-15.2	2.13 V	133	35.6	17.4

REMARKS:

1. Emission Level(dBuV/m) = Raw Value(dBuV) + Correction Factor(dB/m)
2. Correction Factor(dB/m) = Antenna Factor(dB/m) + Cable Factor(dB) – Pre-Amplifier Factor(dB)
3. The other emission levels were very low against the limit.
4. Margin value = Emission Level – Limit value
5. " * ": Fundamental frequency.
6. " # ": The radiated frequency is out of the restricted band.

Below 1GHz Data:

802.11a

CHANNEL	TX Channel 149	DETECTOR FUNCTION	Quasi-Peak (QP)
FREQUENCY RANGE	9kHz ~ 1GHz		

ANTENNA POLARITY & TEST DISTANCE: HORIZONTAL AT 3 M								
NO.	FREQ. (MHz)	EMISSION LEVEL (dBuV/m)	LIMIT (dBuV/m)	MARGIN (dB)	ANTENNA HEIGHT (m)	TABLE ANGLE (Degree)	RAW VALUE (dBuV)	CORRECTION FACTOR (dB/m)
1	30.15	31.3 QP	40.0	-8.7	2.00 H	169	41.1	-9.8
2	90.65	30.6 QP	43.5	-12.9	1.50 H	243	43.8	-13.2
3	215.42	32.6 QP	43.5	-10.9	1.50 H	269	43.0	-10.4
4	311.86	40.8 QP	46.0	-5.2	1.50 H	162	47.5	-6.7
5	375.00	37.2 QP	46.0	-8.8	1.00 H	118	42.2	-5.0
6	500.01	42.7 QP	46.0	-3.3	2.01 H	243	44.6	-1.9

REMARKS:

1. Emission Level(dBuV/m) = Raw Value(dBuV) + Correction Factor(dB/m)
2. Correction Factor(dB/m) = Antenna Factor(dB/m) + Cable Factor(dB) – Pre-Amplifier Factor(dB)
3. Margin value = Emission Level – Limit value
4. The emission levels were very low against the limit of frequency range 9kHz~30MHz: the amplitude of spurious emissions attenuated more than 20 dB below the permissible value to be report.

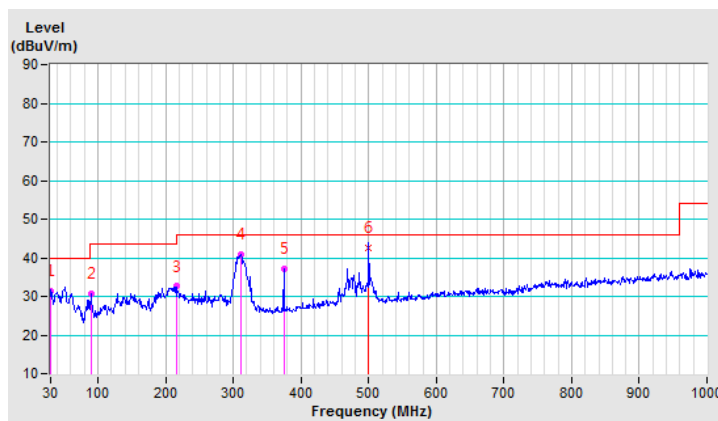

CHANNEL	TX Channel 149	DETECTOR FUNCTION	Quasi-Peak (QP)
FREQUENCY RANGE	9kHz ~ 1GHz		

ANTENNA POLARITY & TEST DISTANCE: VERTICAL AT 3 M

NO.	FREQ. (MHz)	EMISSION LEVEL (dBuV/m)	LIMIT (dBuV/m)	MARGIN (dB)	ANTENNA HEIGHT (m)	TABLE ANGLE (Degree)	RAW VALUE (dBuV)	CORRECTION FACTOR (dB/m)
1	30.58	36.7 QP	40.0	-3.3	1.00 V	265	46.5	-9.8
2	43.00	33.6 QP	40.0	-6.4	1.00 V	174	42.0	-8.4
3	61.11	32.7 QP	40.0	-7.3	1.00 V	113	41.9	-9.2
4	312.78	31.8 QP	46.0	-14.2	1.50 V	318	38.5	-6.7
5	375.03	34.2 QP	46.0	-11.8	1.50 V	241	39.2	-5.0
6	500.01	36.8 QP	46.0	-9.2	2.00 V	265	38.7	-1.9

REMARKS:

1. Emission Level(dBuV/m) = Raw Value(dBuV) + Correction Factor(dB/m)
2. Correction Factor(dB/m) = Antenna Factor(dB/m) + Cable Factor(dB) – Pre-Amplifier Factor(dB)
3. Margin value = Emission Level – Limit value
4. The emission levels were very low against the limit of frequency range 9kHz~30MHz: the amplitude of spurious emissions attenuated more than 20 dB below the permissible value to be report.

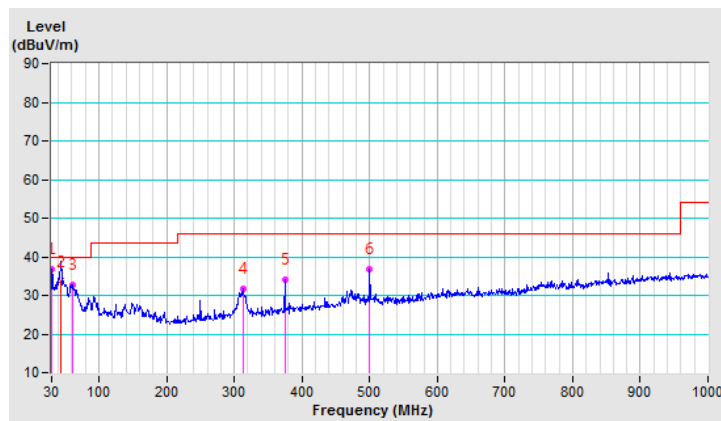

4.2 Conducted Emission Measurement

4.2.1 Limits of Conducted Emission Measurement

Frequency (MHz)	Conducted Limit (dBuV)	
	Quasi-peak	Average
0.15 - 0.5	66 - 56	56 - 46
0.50 - 5.0	56	46
5.0 - 30.0	60	50

Note: 1. The lower limit shall apply at the transition frequencies.

2. The limit decreases in line with the logarithm of the frequency in the range of 0.15 to 0.50MHz.

4.2.2 Test Instruments

DESCRIPTION & MANUFACTURER	MODEL NO.	SERIAL NO.	CALIBRATED DATE	CALIBRATED UNTIL
Test Receiver R&S	ESCS 30	847124/029	Oct. 24, 2018	Oct. 23, 2019
Line-Impedance Stabilization Network (for EUT) R&S	ESH3-Z5	848773/004	Oct. 22, 2018	Oct. 21, 2019
Line-Impedance Stabilization Network (for Peripheral) R&S	ENV216	100072	June 04, 2018	June 03, 2019
50 ohms Terminator	N/A	3	Oct. 22, 2018	Oct. 21, 2019
RF Cable	5D-FB	COCCAB-001	Sep. 28, 2018	Sep. 27, 2019
Fixed attenuator EMCI	STI02-2200-10	003	Mar. 16, 2018	Mar. 15, 2019
Software BVADT	BVADT_Cond_ V7.3.7.4	NA	NA	NA

Note:

1. The calibration interval of the above test instruments are 12 months and the calibrations are traceable to NML/ROC and NIST/USA.
2. The test was performed in Conduction 1.
- 3 Tested Date: Dec. 18, 2018

4.2.3 Test Procedure

- The EUT was placed 0.4 meters from the conducting wall of the shielded room with EUT being connected to the power mains through a line impedance stabilization network (LISN). Other support units were connected to the power mains through another LISN. The two LISNs provide 50 ohm/ 50uH of coupling impedance for the measuring instrument.
- Both lines of the power mains connected to the EUT were checked for maximum conducted interference.
- The frequency range from 150kHz to 30MHz was searched. Emission levels under (Limit - 20dB) was not recorded.

NOTE: All modes of operation were investigated and the worst-case emissions are reported.

4.2.4 Deviation from Test Standard

No deviation.

4.2.5 Test Setup

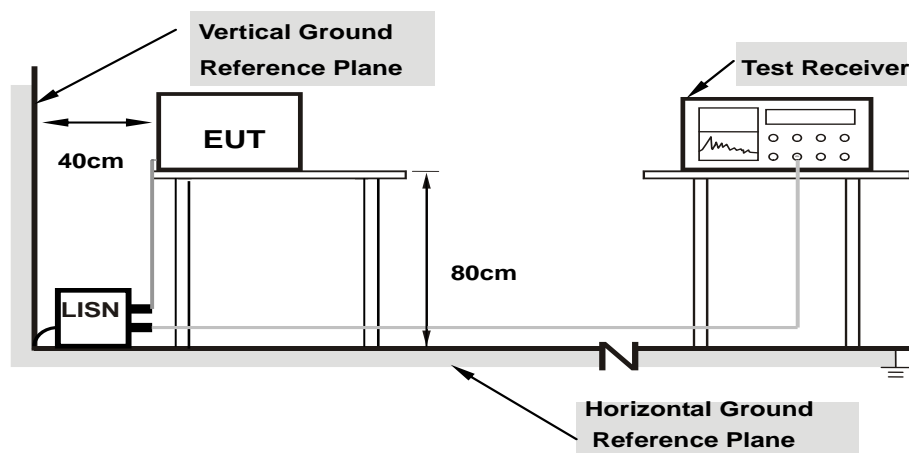

Note: 1.Support units were connected to second LISN.

For the actual test configuration, please refer to the attached file (Test Setup Photo).

4.2.6 EUT Operating Condition

Same as 4.1.6.

4.2.7 Test Results

Phase	Line (L)	Detector Function	Quasi-Peak (QP) / Average (AV)
-------	----------	-------------------	--------------------------------

No	Freq. [MHz]	Corr.	Reading Value		Emission Level		Limit		Margin	
		Factor (dB)	[dB (uV)]		[dB (uV)]		[dB (uV)]		(dB)	
			Q.P.	AV.	Q.P.	AV.	Q.P.	AV.	Q.P.	AV.
1	0.15000	10.03	35.86	19.22	45.89	29.25	66.00	56.00	-20.11	-26.75
2	0.16172	10.03	31.77	15.55	41.80	25.58	65.38	55.38	-23.58	-29.80
3	0.18516	10.04	28.80	13.95	38.84	23.99	64.25	54.25	-25.41	-30.26
4	0.50156	10.09	29.70	24.74	39.79	34.83	56.00	46.00	-16.21	-11.17
5	10.93359	10.76	19.75	12.40	30.51	23.16	60.00	50.00	-29.49	-26.84
6	20.25781	11.37	13.93	4.14	25.30	15.51	60.00	50.00	-34.70	-34.49

REMARKS:

1. Q.P. and AV. are abbreviations of quasi-peak and average individually.
2. The emission levels of other frequencies were very low against the limit.
3. Margin value = Emission level - Limit value
4. Correction factor = Insertion loss + Cable loss
5. Emission Level = Correction Factor + Reading Value.

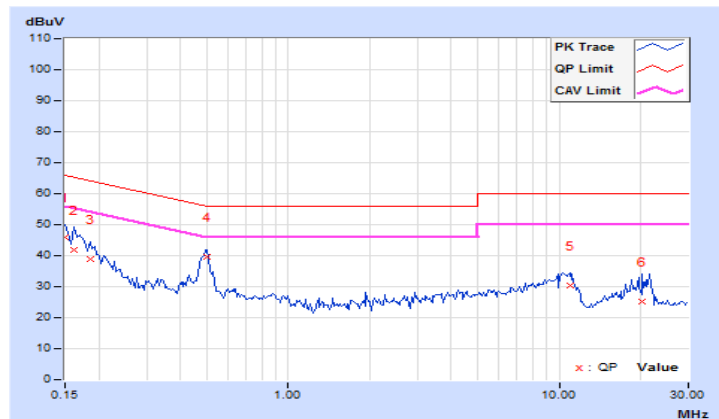

Phase	Neutral (N)	Detector Function	Quasi-Peak (QP) / Average (AV)
-------	-------------	-------------------	--------------------------------

No	Freq. [MHz]	Corr. Factor	Reading Value [dB (uV)]		Emission Level [dB (uV)]		Limit [dB (uV)]		Margin (dB)	
		(dB)	Q.P.	AV.	Q.P.	AV.	Q.P.	AV.	Q.P.	AV.
	1	0.15000	9.94	35.58	17.64	45.52	27.58	66.00	56.00	-20.48
2	0.17734	9.95	30.06	13.23	40.01	23.18	64.61	54.61	-24.60	-31.43
3	0.25938	9.96	17.48	2.87	27.44	12.83	61.45	51.45	-34.01	-38.62
4	0.50156	9.98	29.01	24.01	38.99	33.99	56.00	46.00	-17.01	-12.01
5	10.89453	10.58	19.36	12.11	29.94	22.69	60.00	50.00	-30.06	-27.31
6	20.76953	11.15	12.95	2.85	24.10	14.00	60.00	50.00	-35.90	-36.00

REMARKS:

1. Q.P. and AV. are abbreviations of quasi-peak and average individually.
2. The emission levels of other frequencies were very low against the limit.
3. Margin value = Emission level - Limit value
4. Correction factor = Insertion loss + Cable loss
5. Emission Level = Correction Factor + Reading Value.

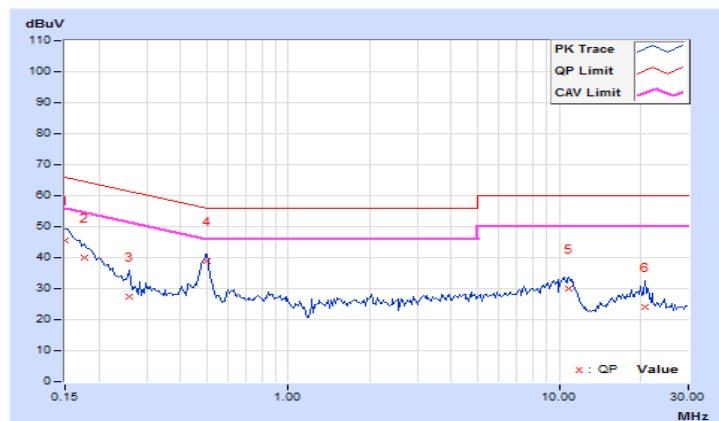

4.3 Transmit Power Measurement

4.3.1 Limits of Transmit Power Measurement

Operation Band	EUT Category		Limit
U-NII-1		Outdoor Access Point	1 Watt (30 dBm) (Max. e.i.r.p \leq 125mW(21 dBm) at any elevation angle above 30 degrees as measured from the horizon)
		Fixed point-to-point Access Point	1 Watt (30 dBm)
	√	Indoor Access Point	1 Watt (30 dBm)
		Client device	250mW (24 dBm)
U-NII-2A			250mW (24 dBm) or 11 dBm+10 log B*
U-NII-2C			250mW (24 dBm) or 11 dBm+10 log B*
U-NII-3		√	1 Watt (30 dBm)

*B is the 26 dB emission bandwidth in megahertz

Per KDB 662911 Method of conducted output power measurement on IEEE 802.11 devices,

Array Gain = 0 dB (i.e., no array gain) for $N_{ANT} \leq 4$;

Array Gain = 0 dB (i.e., no array gain) for channel widths ≥ 40 MHz for any N_{ANT} ;

Array Gain = $5 \log(N_{ANT}/N_{SS})$ dB or 3 dB, whichever is less for 20-MHz channel widths with $N_{ANT} \geq 5$.

For power measurements on all other devices: Array Gain = $10 \log(N_{ANT}/N_{SS})$ dB.

4.3.2 Test Setup

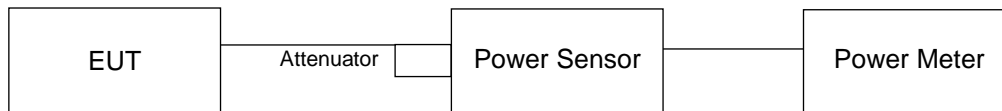

4.3.3 Test Instruments

Refer to section 4.1.2 to get information of above instrument.

4.3.4 Test Procedure

Method PM is used to perform output power measurement, trigger and gating function of wide band power meter is enabled to measure max output power of TX on burst. Duty factor is not added to measured value.

4.3.5 Deviation from Test Standard

No deviation.

4.3.6 EUT Operating Condition

The software provided by client to enable the EUT under transmission condition continuously at lowest, middle and highest channel frequencies individually.

4.3.7 Test Result

CDD Mode
802.11a

Chan.	Chan. Freq. (MHz)	Maximum Conducted Power (dBm)			Total Power (mW)	Total Power (dBm)	Limit (dBm)	Pass / Fail
		Chain 0	Chain 1	Chain 2				
36	5180	20.36	20.22	20.54	327.079	25.15	30.00	Pass
40	5200	24.80	24.78	25.38	947.747	29.77	30.00	Pass
48	5240	24.84	24.87	25.23	945.117	29.75	30.00	Pass
149	5745	25.00	25.22	25.36	992.446	29.97	30.00	Pass
157	5785	25.01	25.16	25.35	987.82	29.95	30.00	Pass
165	5825	25.13	25.04	25.17	973.843	29.88	30.00	Pass

802.11ac (VHT20)

Chan.	Chan. Freq. (MHz)	Maximum Conducted Power (dBm)			Total Power (mW)	Total Power (dBm)	Limit (dBm)	Pass / Fail
		Chain 0	Chain 1	Chain 2				
36	5180	20.11	20.50	20.79	334.717	25.25	30.00	Pass
40	5200	24.61	24.77	25.19	919.354	29.63	30.00	Pass
48	5240	24.60	24.55	25.18	903.115	29.56	30.00	Pass
149	5745	24.96	24.98	25.10	951.698	29.78	30.00	Pass
157	5785	24.83	24.95	25.10	940.291	29.73	30.00	Pass
165	5825	24.87	24.92	25.00	933.586	29.70	30.00	Pass

802.11ac (VHT40)

Chan.	Chan. Freq. (MHz)	Maximum Conducted Power (dBm)			Total Power (mW)	Total Power (dBm)	Limit (dBm)	Pass / Fail
		Chain 0	Chain 1	Chain 2				
38	5190	14.63	14.92	15.23	93.429	19.70	30.00	Pass
46	5230	24.58	24.74	25.28	922.217	29.65	30.00	Pass
151	5755	24.95	25.05	25.15	959.839	29.82	30.00	Pass
159	5795	25.03	24.98	25.24	967.39	29.86	30.00	Pass

802.11ac (VHT80)

Chan.	Chan. Freq. (MHz)	Maximum Conducted Power (dBm)			Total Power (mW)	Total Power (dBm)	Limit (dBm)	Pass / Fail
		Chain 0	Chain 1	Chain 2				
42	5210	11.84	12.39	12.54	50.561	17.04	30.00	Pass
155	5775	20.22	20.63	20.42	330.961	25.20	30.00	Pass

Beamforming Mode

802.11ac (VHT20)

Chan.	Chan. Freq. (MHz)	Maximum Conducted Power (dBm)			Total Power (mW)	Total Power (dBm)	Limit (dBm)	Pass / Fail
		Chain 0	Chain 1	Chain 2				
36	5180	20.11	20.50	20.79	334.717	25.25	30.00	Pass
40	5200	24.61	24.77	25.19	919.354	29.63	30.00	Pass
48	5240	24.60	24.55	25.18	903.115	29.56	30.00	Pass
149	5745	24.96	24.98	25.10	951.698	29.78	30.00	Pass
157	5785	24.83	24.95	25.10	940.291	29.73	30.00	Pass
165	5825	24.87	24.92	25.00	933.586	29.70	30.00	Pass

- Note:** 1. For U-NII-1: Directional gain = $0\text{dBi} + 10\log(3) = 4.77\text{dBi} < 6\text{dBi}$, so the power limit shall not be reduced.
 2. For U-NII-3: Directional gain = $10 \log[(10^{G0/20} + 10^{G1/20} + 10^{G2/20})^2 / 3] = 5.01\text{dBi} < 6\text{dBi}$, so the power limit shall not be reduced.

802.11ac (VHT40)

Chan.	Chan. Freq. (MHz)	Maximum Conducted Power (dBm)			Total Power (mW)	Total Power (dBm)	Limit (dBm)	Pass / Fail
		Chain 0	Chain 1	Chain 2				
38	5190	14.63	14.92	15.23	93.429	19.70	30.00	Pass
46	5230	24.58	24.74	25.28	922.217	29.65	30.00	Pass
151	5755	24.95	25.05	25.15	959.839	29.82	30.00	Pass
159	5795	25.03	24.98	25.24	967.39	29.86	30.00	Pass

- Note:** 1. For U-NII-1: Directional gain = $0\text{dBi} + 10\log(3) = 4.77\text{dBi} < 6\text{dBi}$, so the power limit shall not be reduced.
 2. For U-NII-3: Directional gain = $10 \log[(10^{G0/20} + 10^{G1/20} + 10^{G2/20})^2 / 3] = 5.01\text{dBi} < 6\text{dBi}$, so the power limit shall not be reduced.

802.11ac (VHT80)

Chan.	Chan. Freq. (MHz)	Maximum Conducted Power (dBm)			Total Power (mW)	Total Power (dBm)	Limit (dBm)	Pass / Fail
		Chain 0	Chain 1	Chain 2				
42	5210	11.84	12.39	12.54	50.561	17.04	30.00	Pass
155	5775	20.22	20.63	20.42	330.961	25.20	30.00	Pass

- Note:** 1. For U-NII-1: Directional gain = $0\text{dBi} + 10\log(3) = 4.77\text{dBi} < 6\text{dBi}$, so the power limit shall not be reduced.
 2. For U-NII-3: Directional gain = $10 \log[(10^{G0/20} + 10^{G1/20} + 10^{G2/20})^2 / 3] = 5.01\text{dBi} < 6\text{dBi}$, so the power limit shall not be reduced.

4.4 Occupied Bandwidth Measurement

4.4.1 Test Setup

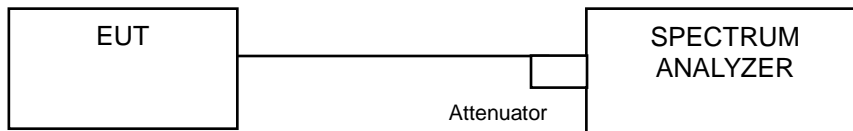

4.4.2 Test Instruments

Refer to section 4.1.2 to get information of above instrument.

4.4.3 Test Procedure

The transmitter output was connected to the spectrum analyzer through an attenuator. The bandwidth of the fundamental frequency was measured by spectrum analyzer with resolution bandwidth in the range of 1% to 5% of the anticipated emission bandwidth, and a video bandwidth at least 3x the resolution bandwidth and set the detector to SAMPLE. The width of a frequency band such that, below the lower and above the upper frequency limits, the mean powers emitted are each equal to a specified percentage 0.5 %of the total mean power of a given emission.

4.4.4 Test Results

802.11a

Channel	Channel Frequency (MHz)	Occupied Bandwidth (MHz)		
		Chain 0	Chain 1	Chain 2
36	5180	16.44	16.44	16.44
40	5200	16.68	16.92	16.80
48	5240	16.68	16.92	16.80
149	5745	17.04	16.70	16.92
157	5785	16.87	16.92	16.92
165	5825	17.16	17.04	17.22

802.11ac (VHT20)

Channel	Channel Frequency (MHz)	Occupied Bandwidth (MHz)		
		Chain 0	Chain 1	Chain 2
36	5180	17.64	17.64	17.64
40	5200	17.76	17.88	17.88
48	5240	17.76	17.88	17.88
149	5745	17.88	18.00	17.88
157	5785	17.88	17.88	17.88
165	5825	17.88	17.88	17.88

802.11ac (VHT40)

Channel	Channel Frequency (MHz)	Occupied Bandwidth (MHz)		
		Chain 0	Chain 1	Chain 2
38	5190	37.44	36.96	36.72
46	5230	36.96	37.68	36.48
151	5755	36.35	36.35	36.35
159	5795	36.72	36.72	36.35

802.11ac (VHT80)

Channel	Channel Frequency (MHz)	Occupied Bandwidth (MHz)		
		Chain 0	Chain 1	Chain 2
42	5210	77.76	77.76	75.84
155	5775	75.84	75.84	75.84

Spectrum Plot of Max Value

802.11a / Chain 2 : CH165

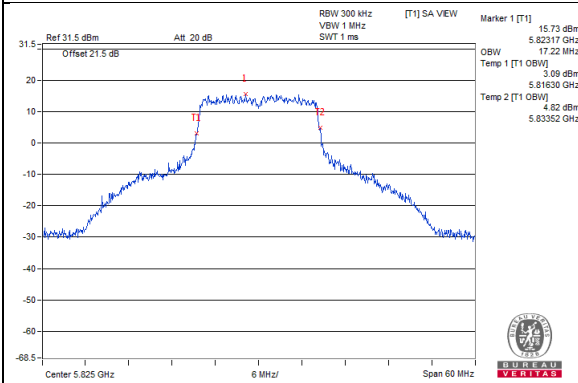

802.11ac (VHT20) / Chain 1: CH149

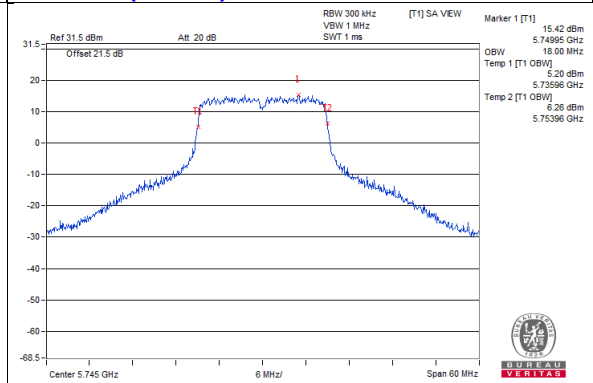

802.11ac (VHT40) / Chain 1: CH46

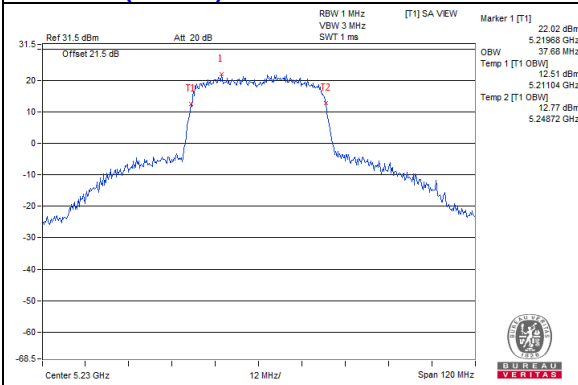

802.11ac (VHT80) / Chain 0 : CH42

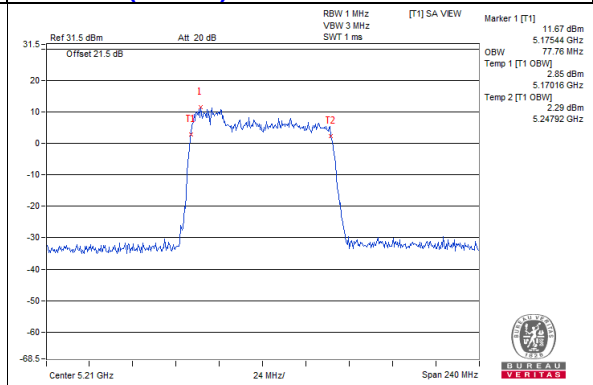

Spectrum Plot for near by DFS band (DFS is required, if 99% OCP straddle into U-NII-2A band)

802.11a_Chain0 / CH48

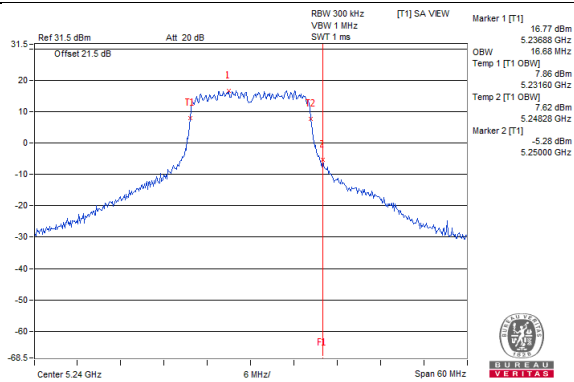

802.11a_Chain1 / CH48

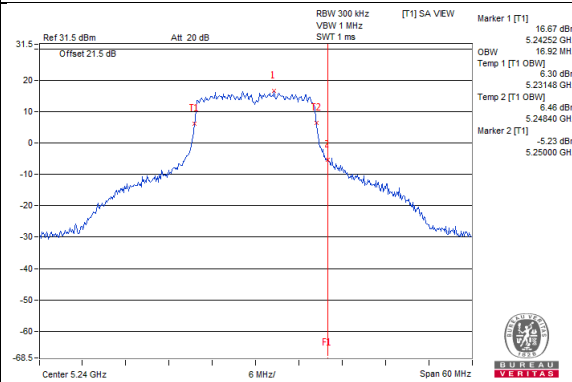

802.11a_Chain2 / CH48

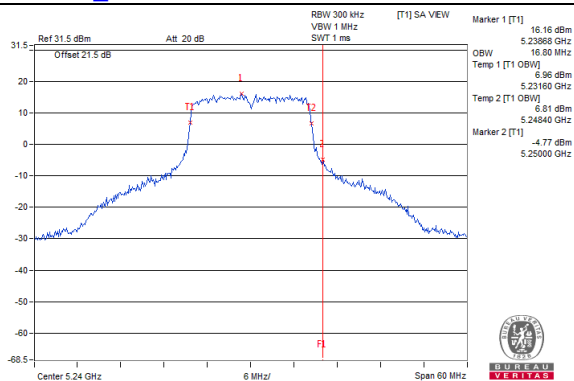

802.11ac(VHT20)_Chain0 / CH48

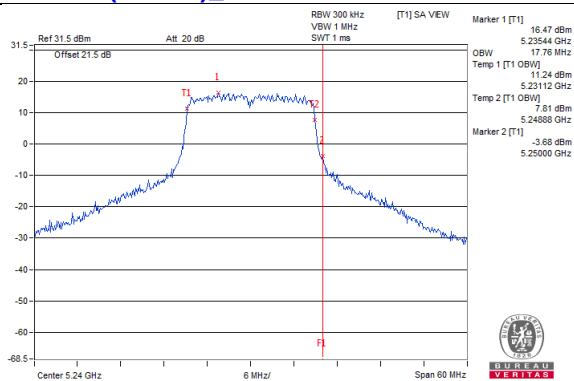

802.11ac(VHT20)_Chain1 / CH48

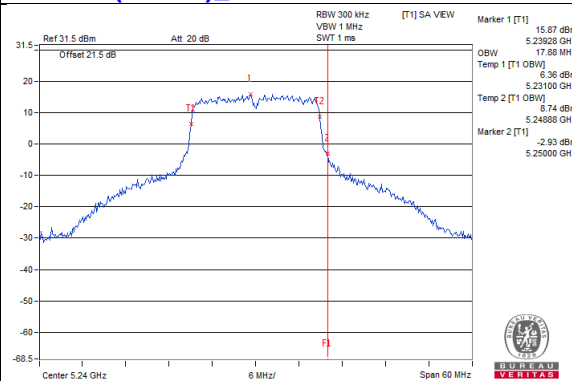

802.11ac(VHT20)_Chain2 / CH48

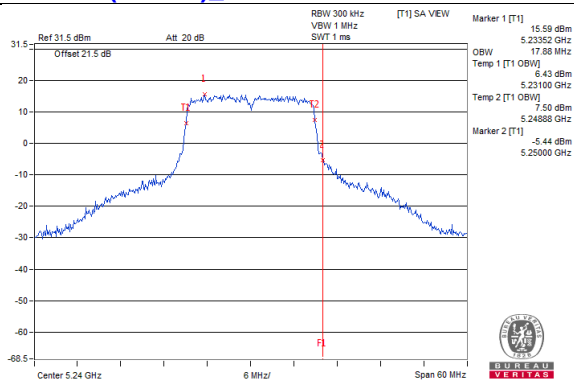

Spectrum Plot for near by DFS band (DFS is required, if 99% OCP straddle into U-NII-2A band)

802.11ac(VHT40)_Chain0 / CH46

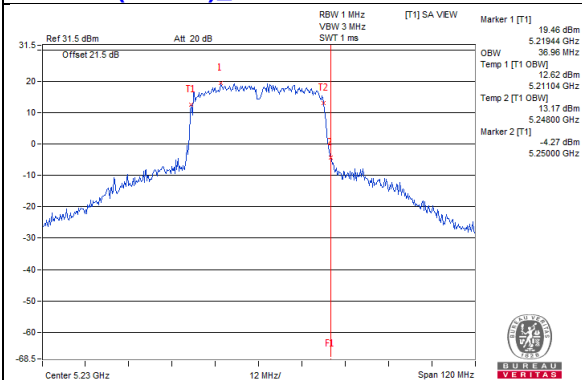

802.11ac(VHT40)_Chain1 / CH46

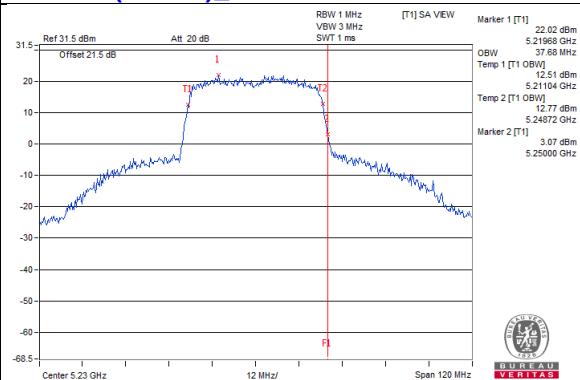

802.11ac(VHT40)_Chain2 / CH46

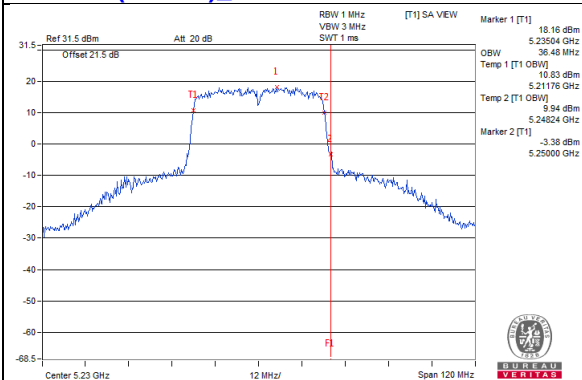

802.11ac(VHT80)_Chain0 / CH42

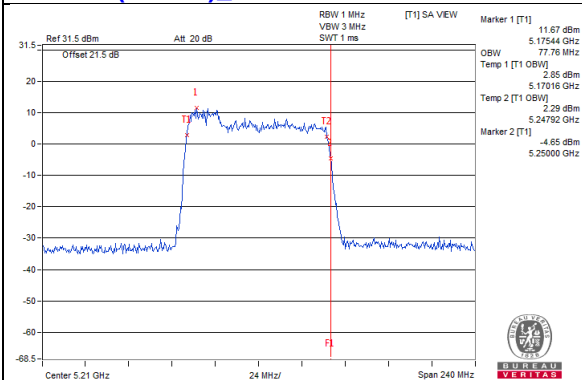

802.11ac(VHT80)_Chain1 / CH42

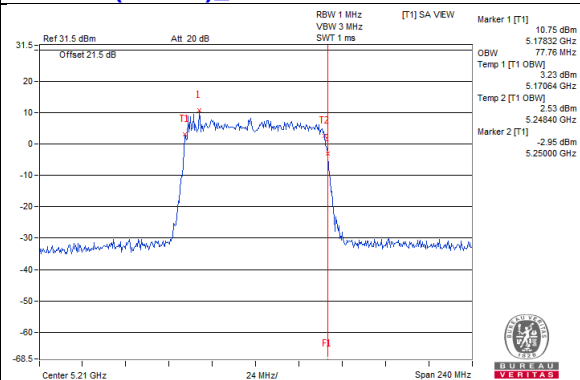

802.11ac(VHT80)_Chain2 / CH42

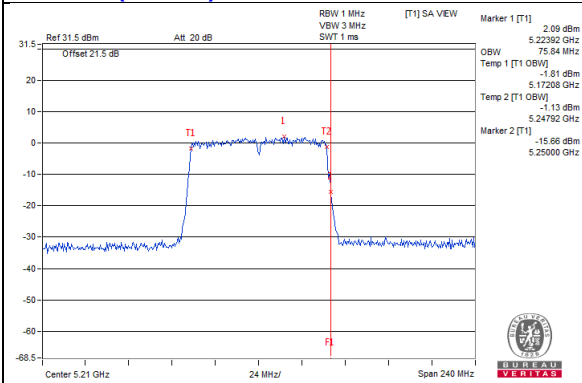

**Spectrum Plot for near by DFS band
(DFS is required, if 99% OCP straddle into U-NII-2C band)**

802.11a_Chain0 / CH149

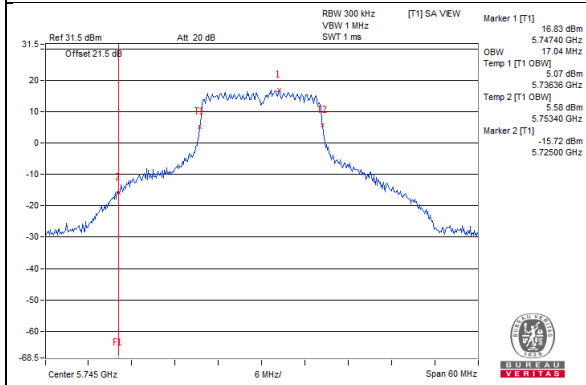

802.11a_Chain1 / CH149

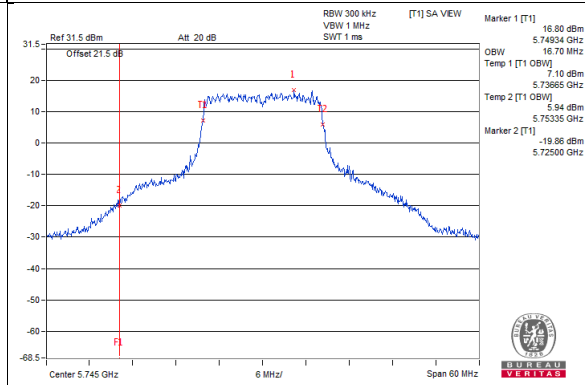

802.11a_Chain2 / CH149

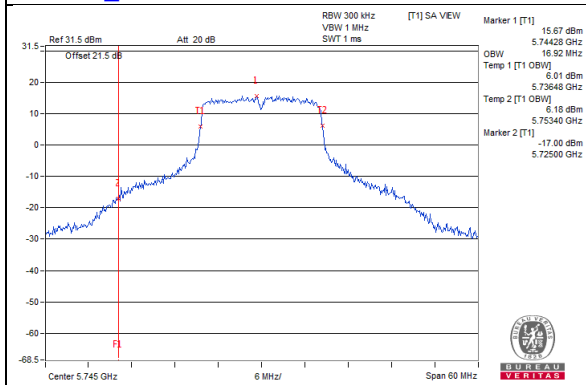

802.11ac(VHT20)_Chain0 / CH149

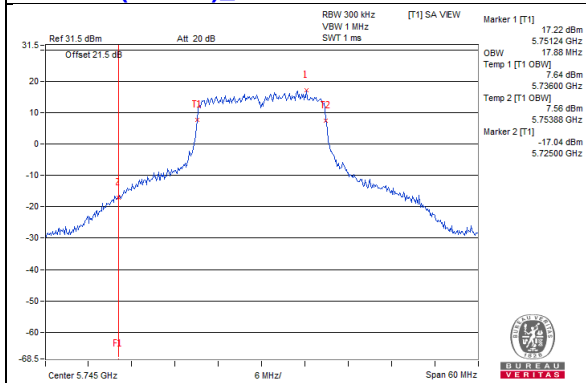

802.11ac(VHT20)_Chain1 / CH149

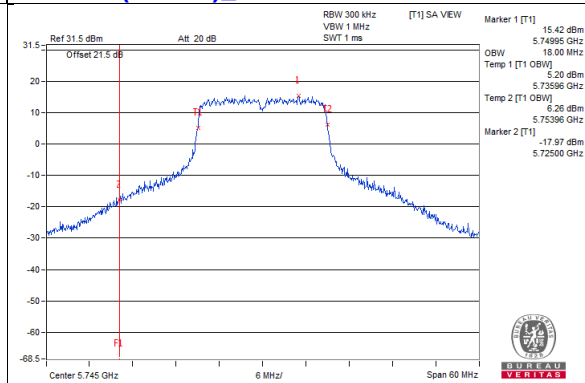

802.11ac(VHT20)_Chain2 / CH149

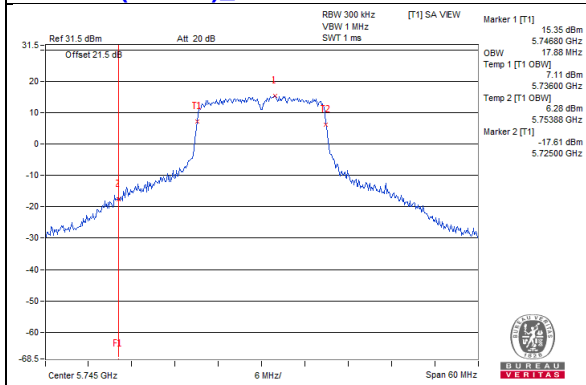

Spectrum Plot for near by DFS band (DFS is required, if 99% OCP straddle into U-NII-2C band)

802.11ac(VHT40)_Chain0 / CH151

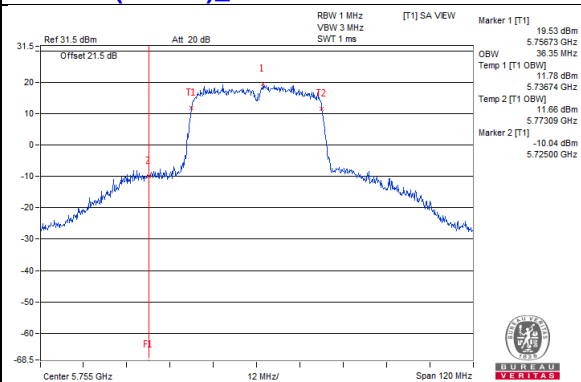

802.11ac(VHT40)_Chain1 / CH151

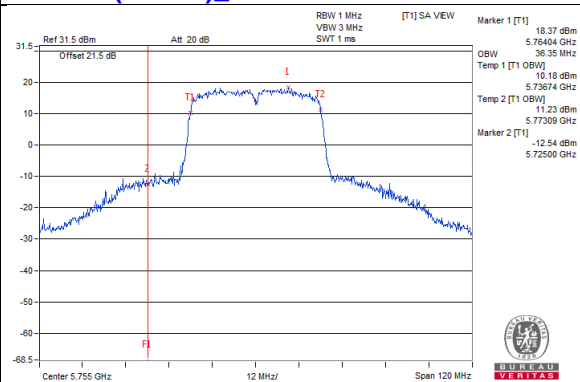

802.11ac(VHT40)_Chain2 / CH151

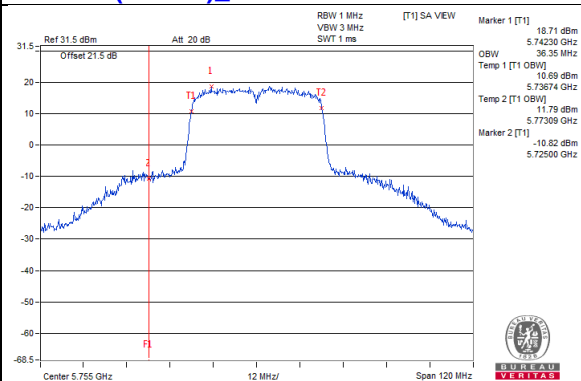

802.11ac(VHT80)_Chain0 / CH155

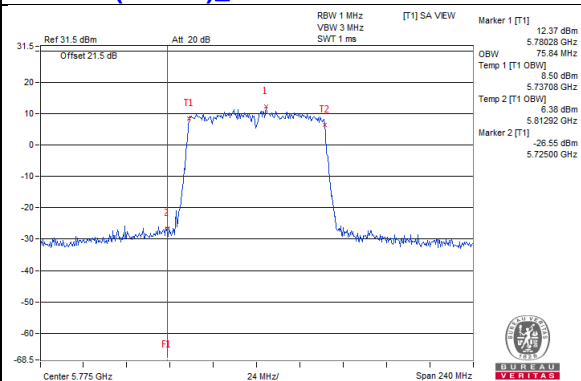

802.11ac(VHT80)_Chain1 / CH155

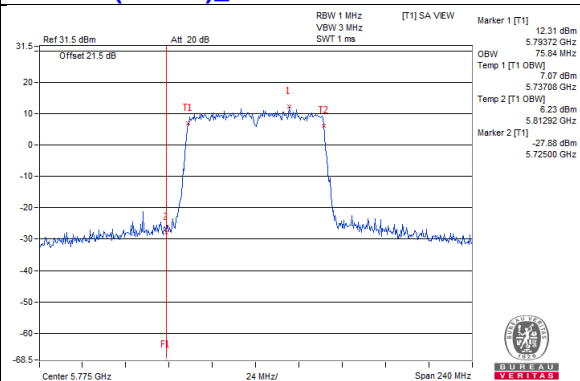

802.11ac(VHT80)_Chain2 / CH155

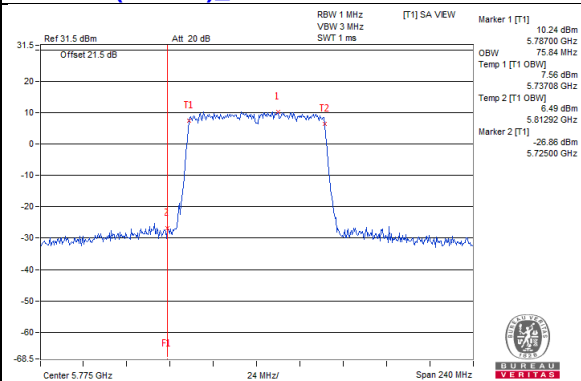

4.5 Peak Power Spectral Density Measurement

4.5.1 Limits of Peak Power Spectral Density Measurement

Operation Band	EUT Category		Limit
U-NII-1		Outdoor Access Point	17dBm/ MHz
		Fixed point-to-point Access Point	
	√	Indoor Access Point	
		Client device	
U-NII-2A			11dBm/ MHz
U-NII-2C			11dBm/ MHz
U-NII-3	√		30dBm/ 500kHz

4.5.2 Test Setup

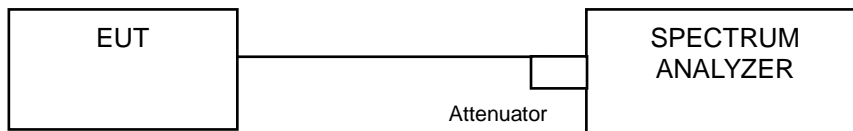

4.5.3 Test Instruments

Refer to section 4.1.2 to get information of above instrument.

4.5.4 Test Procedure

For U-NII-1:

Using method SA-2

1. Set span to encompass the entire emission bandwidth (EBW) of the signal.
2. Set RBW = 1 MHz, Set VBW ≥ 3 MHz, Detector = RMS
3. Sweep time = auto, trigger set to "free run".
4. Trace average at least 100 traces in power averaging mode.
5. Record the max value and add 10 log (1/duty cycle)

For U-NII-3:

1. Set span to encompass the entire emission bandwidth (EBW) of the signal.
2. Set RBW = 300 kHz, Set VBW ≥ 1 MHz, Detector = RMS
3. Use the peak marker function to determine the maximum power level in any 300 kHz band segment within the fundamental EBW.
4. Scale the observed power level to an equivalent value in 500 kHz by adjusting (reducing) the measured power by a bandwidth correction factor (BWCF) where $BWCF = 10\log(500\text{ kHz}/300\text{kHz})$
5. Sweep time = auto, trigger set to "free run".
6. Trace average at least 100 traces in power averaging mode.
7. Record the max value and add 10 log (1/duty cycle)

4.5.5 Deviation from Test Standard

No deviation.

4.5.6 EUT Operating Condition

Same as Item 4.3.6.

4.5.7 Test Results

For U-NII-1:

802.11a

Chan.	Chan. Freq. (MHz)	PSD W/O Duty Factor (dBm/MHz)			Duty Factor (dB)	Total PSD With Duty Factor (dBm/MHz)	MAX. Limit (dBm/MHz)	Pass / Fail
		Chain 0	Chain 1	Chain 2				
36	5180	7.28	6.66	7.07	0.19	11.97	17.00	Pass
40	5200	10.17	10.89	11.25	0.19	15.75	17.00	Pass
48	5240	10.94	11.57	11.04	0.19	16.15	17.00	Pass

- Note:**
- Method a) of power density measurement of KDB 662911 is using for calculating total power density. Total power density is summing entire spectra across corresponding frequency bins on the various outputs by computer.
 - Directional gain = $0\text{dBi} + 10\log(3) = 4.77\text{dBi} < 6\text{dBi}$, so the power density limit shall not be reduced.
 - Refer to section 3.3 for duty cycle spectrum plot.

802.11ac (VHT20)

Chan.	Chan. Freq. (MHz)	PSD W/O Duty Factor (dBm/MHz)			Duty Factor (dB)	Total PSD With Duty Factor (dBm/MHz)	MAX. Limit (dBm/MHz)	Pass / Fail
		Chain 0	Chain 1	Chain 2				
36	5180	7.11	6.80	6.58	0.20	11.81	17.00	Pass
40	5200	11.26	10.87	9.22	0.20	15.51	17.00	Pass
48	5240	11.01	10.46	9.99	0.20	15.48	17.00	Pass

- Note:**
- Method a) of power density measurement of KDB 662911 is using for calculating total power density. Total power density is summing entire spectra across corresponding frequency bins on the various outputs by computer.
 - Directional gain = $0\text{dBi} + 10\log(3) = 4.77\text{dBi} < 6\text{dBi}$, so the power density limit shall not be reduced.
 - Refer to section 3.3 for duty cycle spectrum plot.

802.11ac (VHT40)

Chan.	Chan. Freq. (MHz)	PSD W/O Duty Factor (dBm/MHz)			Duty Factor (dB)	Total PSD With Duty Factor (dBm/MHz)	MAX. Limit (dBm/MHz)	Pass / Fail
		Chain 0	Chain 1	Chain 2				
38	5190	-1.42	-1.85	-1.80	0.22	3.31	17.00	Pass
46	5230	8.36	8.29	7.26	0.22	12.99	17.00	Pass

- Note:**
- Method a) of power density measurement of KDB 662911 is using for calculating total power density. Total power density is summing entire spectra across corresponding frequency bins on the various outputs by computer.
 - Directional gain = $0\text{dBi} + 10\log(3) = 4.77\text{dBi} < 6\text{dBi}$, so the power density limit shall not be reduced.
 - Refer to section 3.3 for duty cycle spectrum plot.

802.11ac (VHT80)

Chan.	Chan. Freq. (MHz)	PSD W/O Duty Factor (dBm/MHz)			Duty Factor (dB)	Total PSD With Duty Factor (dBm/MHz)	MAX. Limit (dBm/MHz)	Pass / Fail
		Chain 0	Chain 1	Chain 2				
42	5210	-9.14	-8.73	-9.63	0.51	-3.87	17.00	Pass

- Note:**
- Method a) of power density measurement of KDB 662911 is using for calculating total power density. Total power density is summing entire spectra across corresponding frequency bins on the various outputs by computer.
 - Directional gain = $0\text{dBi} + 10\log(3) = 4.77\text{dBi} < 6\text{dBi}$, so the power density limit shall not be reduced.
 - Refer to section 3.3 for duty cycle spectrum plot.

Spectrum Plot of Worst Value

802.11a_Chain 1 / CH48

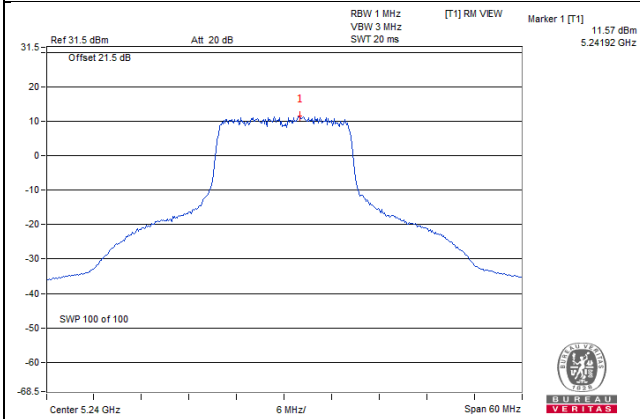

802.11ac (VHT20)_Chain 0 / CH40

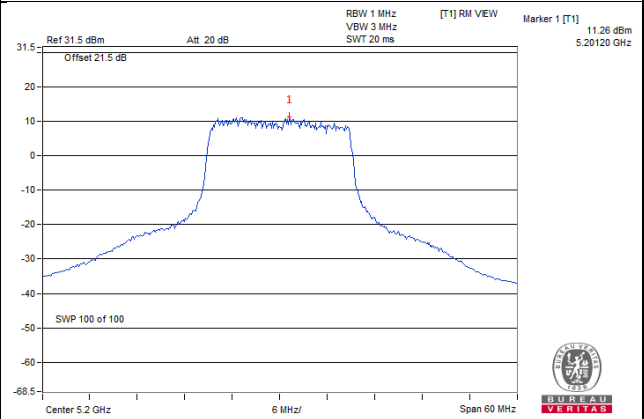

802.11ac (VHT40)_Chain 0 / CH46

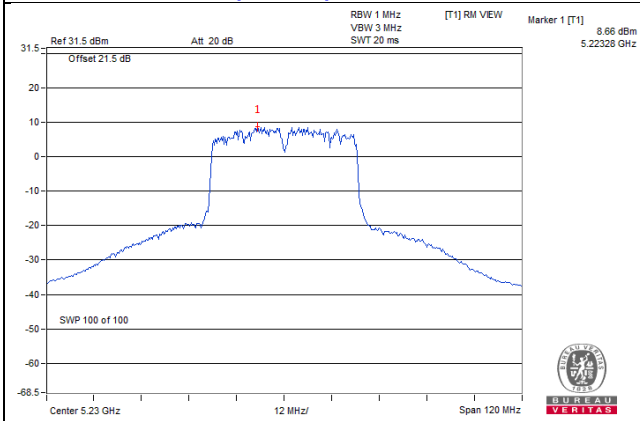

802.11ac (VHT80)_Chain 1 / CH42

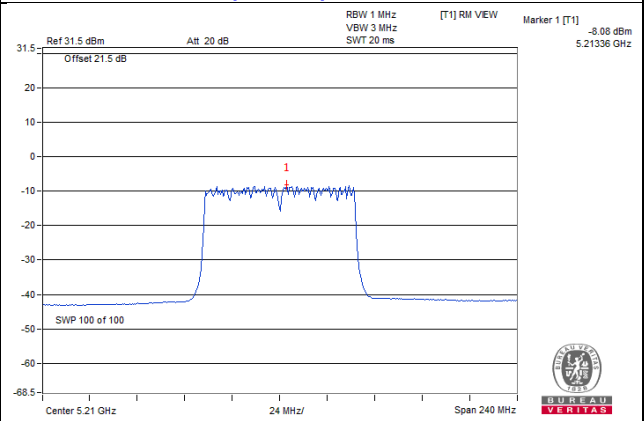

For U-NII-3:
802.11a

Chan.	Freq. (MHz)	PSD W/O Duty Factor (dBm/300kHz)			Duty Factor (dB)	Total PSD With Duty Factor		Total PSD With Duty Factor (dBm/500kHz)	Limit (dBm/500kHz)	Pass /Fail
		Chain 0	Chain 1	Chain 2		mW/300kHz	dBm/300kHz			
149	5745	2.87	2.41	2.43	0.19	5.6746	7.54	9.76	30.00	Pass
157	5785	2.01	2.36	2.42	0.19	5.2858	7.23	9.45	30.00	Pass
165	5825	2.81	2.31	2.47	0.19	5.6223	7.50	9.72	30.00	Pass

- Note: 1. Method b) Measure and sum spectral maxima across the outputs of KDB 662911 is using for calculating total power density.
 2. Directional gain = $10 \log[(10^{G0/20} + 10^{G1/20} + 10^{G2/20})^2 / 3] = 5.01 \text{ dBi} < 6 \text{ dBi}$, so the power density limit shall not be reduced.
 3. Refer to section 3.3 for duty cycle spectrum plot.

802.11ac (VHT20)

Chan.	Freq. (MHz)	PSD W/O Duty Factor (dBm/300kHz)			Duty Factor (dB)	Total PSD With Duty Factor		Total PSD With Duty Factor (dBm/500kHz)	Limit (dBm/500kHz)	Pass /Fail
		Chain 0	Chain 1	Chain 2		mW/300kHz	dBm/300kHz			
149	5745	2.46	1.33	2.25	0.20	5.0292	7.01	9.23	30.00	Pass
157	5785	1.58	1.58	1.67	0.20	4.5549	6.58	8.80	30.00	Pass
165	5825	2.26	1.30	1.79	0.20	4.7595	6.78	9.00	30.00	Pass

- Note: 1. Method b) Measure and sum spectral maxima across the outputs of KDB 662911 is using for calculating total power density.
 2. Directional gain = $10 \log[(10^{G0/20} + 10^{G1/20} + 10^{G2/20})^2 / 3] = 5.01 \text{ dBi} < 6 \text{ dBi}$, so the power density limit shall not be reduced.
 3. Refer to section 3.3 for duty cycle spectrum plot.

802.11ac (VHT40)

Chan.	Freq. (MHz)	PSD W/O Duty Factor (dBm/300kHz)			Duty Factor (dB)	Total PSD With Duty Factor		Total PSD With Duty Factor (dBm/500kHz)	Limit (dBm/500kHz)	Pass /Fail
		Chain 0	Chain 1	Chain 2		mW/300kHz	dBm/300kHz			
151	5755	-1.19	-1.82	-1.40	0.22	2.2561	3.53	5.75	30.00	Pass
159	5795	-0.90	-1.82	-1.84	0.22	2.2379	3.50	5.72	30.00	Pass

- Note: 1. Method b) Measure and sum spectral maxima across the outputs of KDB 662911 is using for calculating total power density.
 2. Directional gain = $10 \log[(10^{G0/20} + 10^{G1/20} + 10^{G2/20})^2 / 3] = 5.01 \text{ dBi} < 6 \text{ dBi}$, so the power density limit shall not be reduced.
 3. Refer to section 3.3 for duty cycle spectrum plot.

802.11ac (VHT80)

Chan.	Freq. (MHz)	PSD W/O Duty Factor (dBm/300kHz)			Duty Factor (dB)	Total PSD With Duty Factor		Total PSD With Duty Factor (dBm/500kHz)	Limit (dBm/500kHz)	Pass /Fail
		Chain 0	Chain 1	Chain 2		mW/300kHz	dBm/300kHz			
155	5745	-8.39	-8.71	-8.95	0.51	0.4575	-3.40	-1.18	30.00	Pass

Note: 1. Method b) Measure and sum spectral maxima across the outputs of KDB 662911 is using for calculating total power density.

2. Directional gain = $10 \log[(10^{G0/20} + 10^{G1/20} + 10^{G2/20})^2 / 3] = 5.01 \text{dBi} < 6 \text{dBi}$, so the power density limit shall not be reduced.

3. Refer to section 3.3 for duty cycle spectrum plot.

Spectrum Plot of Worst Value

802.11a – Chain 0: CH 149

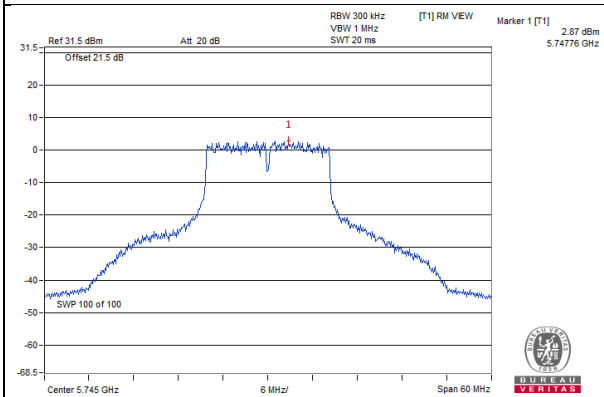

802.11ac (VHT20) – Chain 0: CH 149

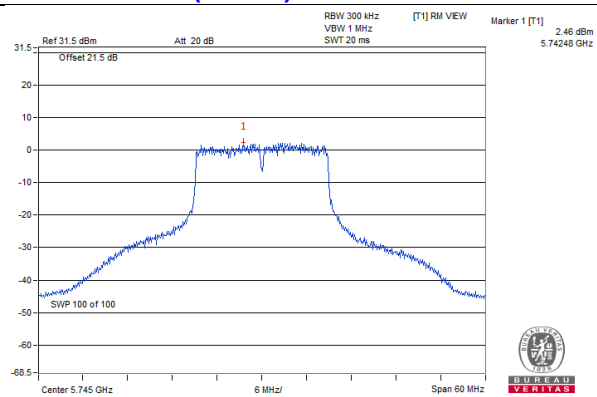

802.11ac (VHT40) – Chain 0: CH 159

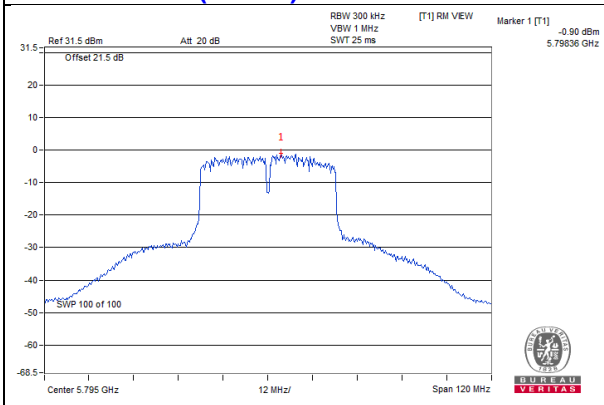

802.11ac (VHT80) – Chain 0: CH 155

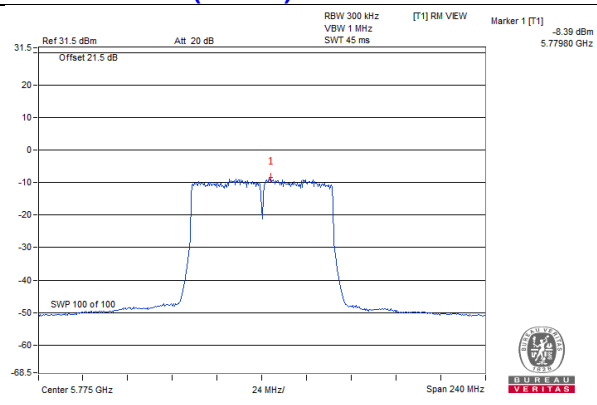

4.6 Frequency Stability Measurement

4.6.1 Limits of Frequency Stability Measurement

The frequency of the carrier signal shall be maintained within band of operation

4.6.2 Test Setup

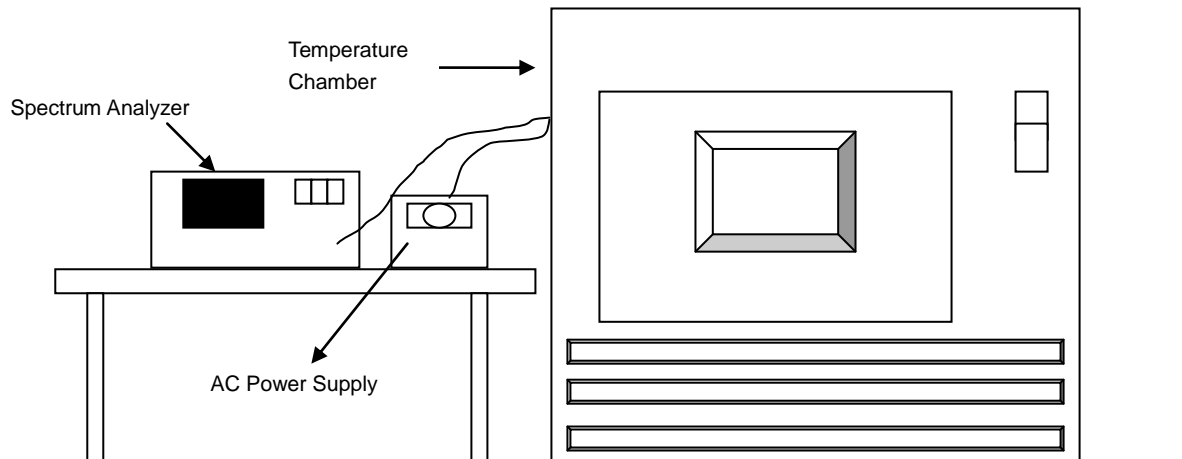

4.6.3 Test Instruments

Refer to section 4.1.2 to get information of above instrument.

4.6.4 Test Procedure

- The EUT was placed inside the environmental test chamber and powered by nominal AC voltage.
- Turn the EUT on and couple its output to a spectrum analyzer.
- Turn the EUT off and set the chamber to the highest temperature specified.
- Allow sufficient time (approximately 30 min) for the temperature of the chamber to stabilize, turn the EUT on and measure the operating frequency after 0, 2, 5, and 10 Minutes.
- Repeated step c and d with the temperature chamber sets to each desired temperature.
- The test chamber was allowed to stabilize at +20 degree C for a minimum of 30 Minutes. The supply voltage was then adjusted on the EUT from 85% to 115% and the frequency record.

4.6.5 Deviation from Test Standard

No deviation.

4.6.6 EUT Operating Condition

Set the EUT transmit at un-modulation mode to test frequency stability.

4.6.7 Test Results

Frequency Stability Versus Temp.									
Operating Frequency: 5180 MHz					Limit: within 5150 ~ 5250 MHz				
TEMP. (°C)	Power Supply (Vac)	0 Minute		2 Minutes		5 Minutes		10 Minutes	
		Measured Frequency (MHz)	Pass/Fail	Measured Frequency (MHz)	Pass/Fail	Measured Frequency (MHz)	Pass/Fail	Measured Frequency (MHz)	Pass/Fail
50	120	5180.0002	PASS	5179.9971	PASS	5179.9956	PASS	5179.9999	PASS
40	120	5179.9991	PASS	5179.9986	PASS	5180.0007	PASS	5179.9977	PASS
30	120	5179.999	PASS	5179.9969	PASS	5179.9973	PASS	5179.9996	PASS
20	120	5180.0181	PASS	5180.0202	PASS	5180.0179	PASS	5180.0205	PASS
10	120	5179.9945	PASS	5179.9925	PASS	5179.9957	PASS	5179.993	PASS
0	120	5180.0191	PASS	5180.0224	PASS	5180.0202	PASS	5180.0185	PASS
-10	120	5179.9803	PASS	5179.9835	PASS	5179.9805	PASS	5179.9812	PASS
-20	120	5179.9753	PASS	5179.9774	PASS	5179.9785	PASS	5179.976	PASS
-30	120	5180.0207	PASS	5180.0182	PASS	5180.0178	PASS	5180.021	PASS

Frequency Stability Versus Voltage									
Operating Frequency: 5180 MHz					Limit: within 5150 ~ 5250 MHz				
TEMP. (°C)	Power Supply (Vac)	0 Minute		2 Minutes		5 Minutes		10 Minutes	
		Measured Frequency (MHz)	Pass/Fail	Measured Frequency (MHz)	Pass/Fail	Measured Frequency (MHz)	Pass/Fail	Measured Frequency (MHz)	Pass/Fail
20	138	5180.0189	PASS	5180.0201	PASS	5180.0175	PASS	5180.0209	PASS
	120	5180.0181	PASS	5180.0202	PASS	5180.0179	PASS	5180.0205	PASS
	102	5180.0191	PASS	5180.02	PASS	5180.018	PASS	5180.02	PASS

4.7 6dB Bandwidth Measurement

4.7.1 Limits of 6dB Bandwidth Measurement

The minimum of 6dB Bandwidth Measurement is 0.5MHz.

4.7.2 Test Setup

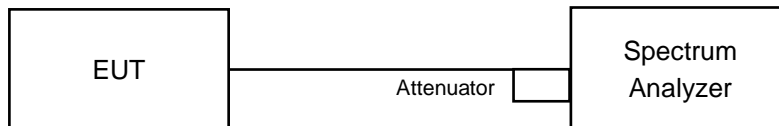

4.7.3 Test Instruments

Refer to section 4.1.2 to get information of above instrument.

4.7.4 Test Procedure

MEASUREMENT PROCEDURE REF

- Set resolution bandwidth (RBW) = 100kHz
- Set the video bandwidth (VBW) $\geq 3 \times$ RBW, Detector = Peak.
- Trace mode = max hold.
- Sweep = auto couple.
- Measure the maximum width of the emission that is constrained by the frequencies associated with the two amplitude points (upper and lower) that are attenuated by 6 dB relative to the maximum level measured in the fundamental emission

4.7.5 Deviation from Test Standard

No deviation.

4.7.6 EUT Operating Condition

The software provided by client to enable the EUT under transmission condition continuously at lowest, middle and highest channel frequencies individually.

4.7.7 Test Results

802.11a

Channel	Frequency (MHz)	6dB Bandwidth (MHz)			Minimum Limit (MHz)	Pass / Fail
		Chain 0	Chain 1	Chain 2		
149	5745	16.40	16.35	16.38	0.5	PASS
157	5785	16.37	16.38	16.38	0.5	PASS
165	5825	16.39	16.38	16.36	0.5	PASS

802.11ac (VHT20)

Channel	Frequency (MHz)	6dB Bandwidth (MHz)			Minimum Limit (MHz)	Pass / Fail
		Chain 0	Chain 1	Chain 2		
149	5745	17.58	17.33	17.57	0.5	PASS
157	5785	17.58	17.58	17.58	0.5	PASS
165	5825	17.62	17.57	17.58	0.5	PASS

802.11ac (VHT40)

Channel	Frequency (MHz)	6dB Bandwidth (MHz)			Minimum Limit (MHz)	Pass / Fail
		Chain 0	Chain 1	Chain 2		
151	5755	35.17	35.12	35.16	0.5	PASS
159	5795	35.16	35.15	35.11	0.5	PASS

802.11ac (VHT80)

Channel	Frequency (MHz)	6dB Bandwidth (MHz)			Minimum Limit (MHz)	Pass / Fail
		Chain 0	Chain 1	Chain 2		
155	5775	76.10	75.90	76.21	0.5	PASS

Spectrum Plot of Worst Value

802.11a_Chain 1 / CH149

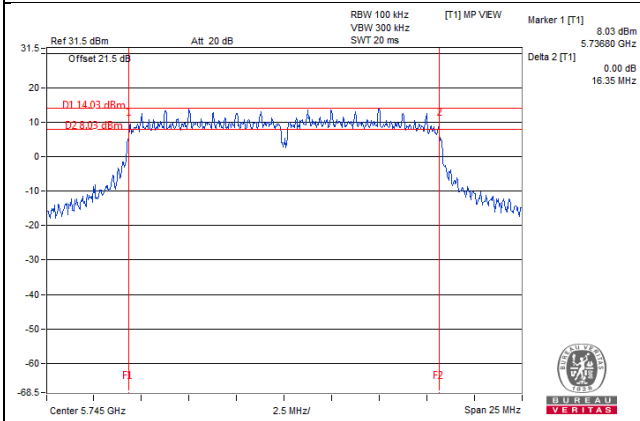

802.11ac (VHT20)_Chain 1 / CH149

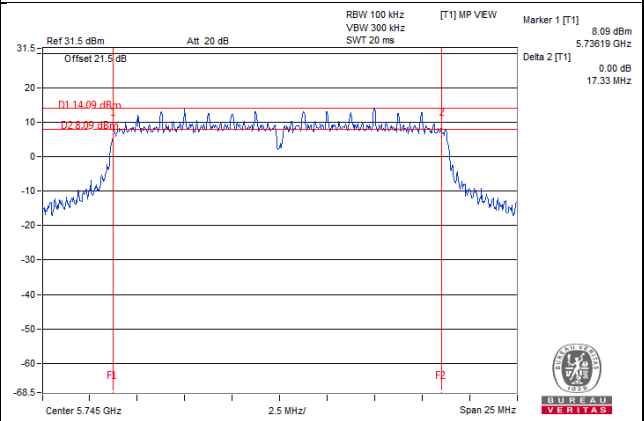

802.11ac (VHT40)_Chain 2 / CH159

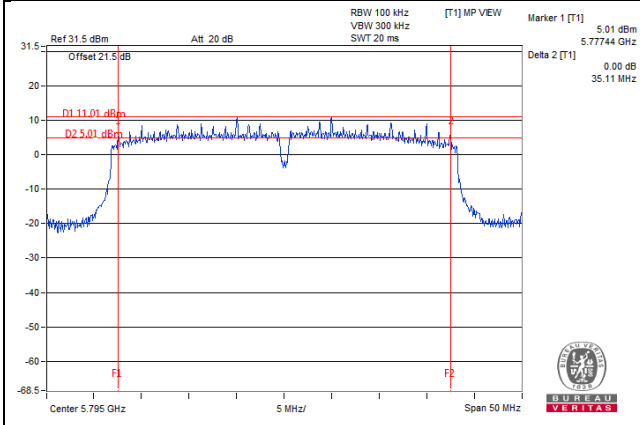

802.11ac (VHT80)_Chain 1 / CH155

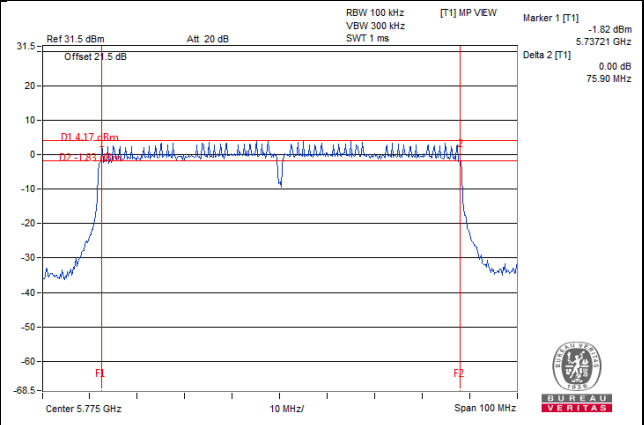

5 Pictures of Test Arrangements

Please refer to the attached file (Test Setup Photo).

Annex A- Radiated Out of Band Emission (OOBE) Measurement (For U-NII-3 band)

802.11a

CH 149 5745 MHz

Horizontal

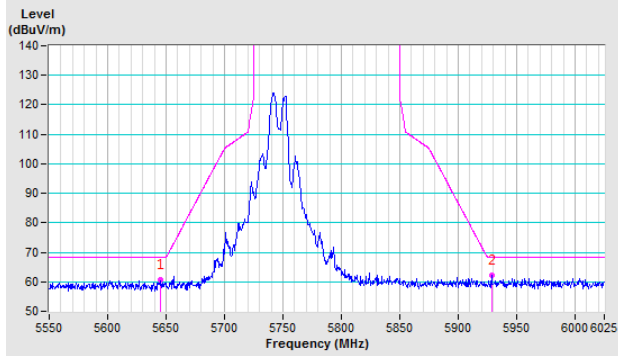

Vertical

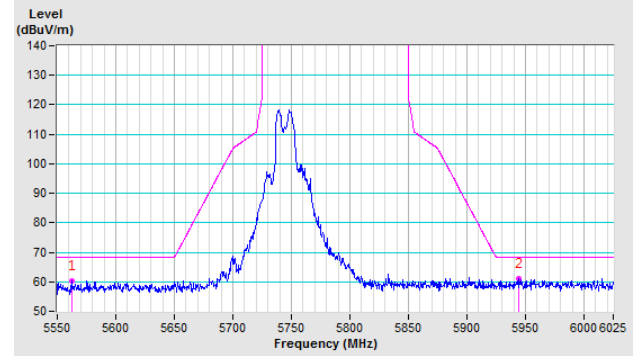

CH 157 5785 MHz

Horizontal

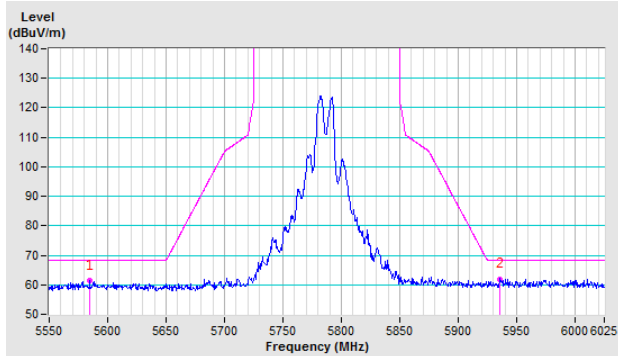

Vertical

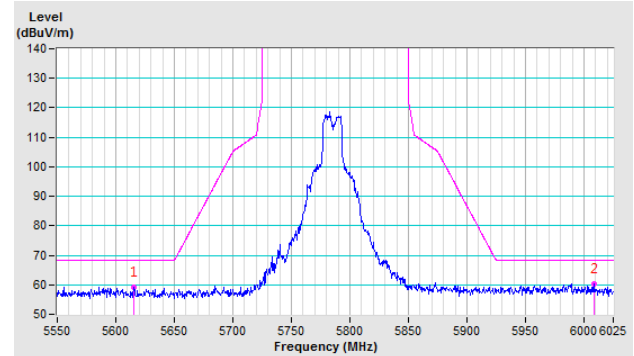

CH 165 5825 MHz

Horizontal

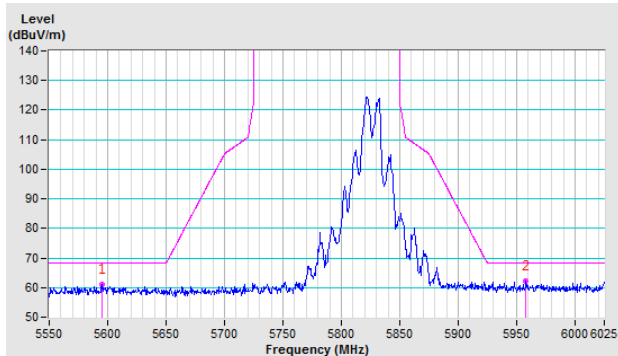

Vertical

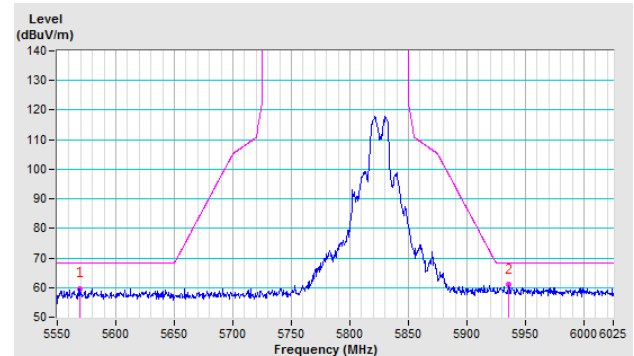

802.11ac (VHT20)

CH 149 5745 MHz

Horizontal

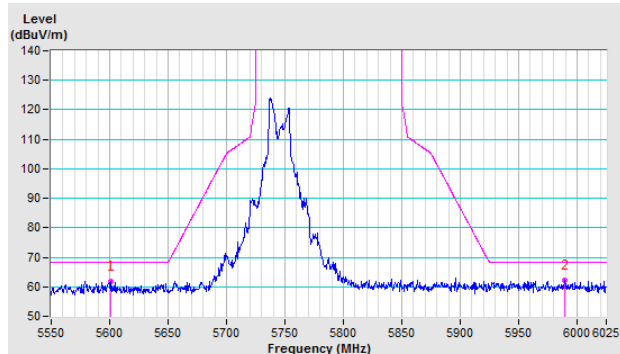

Vertical

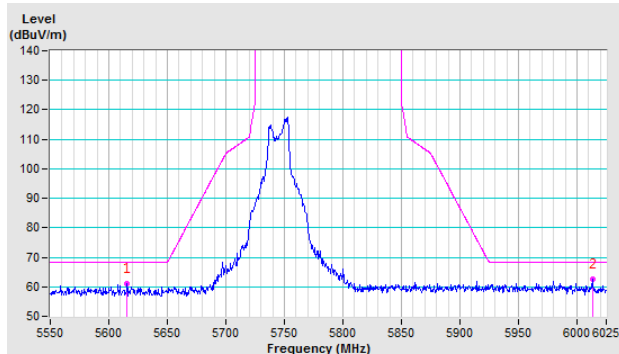

CH 157 5785 MHz

Horizontal

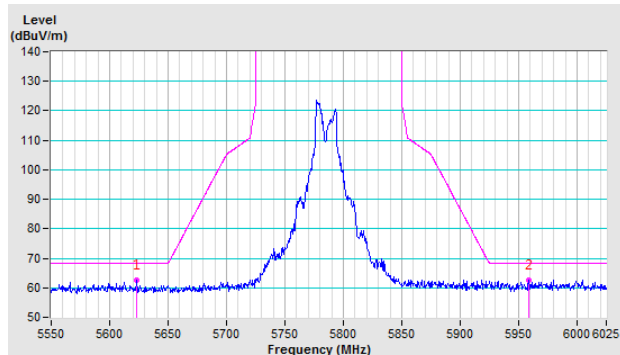

Vertical

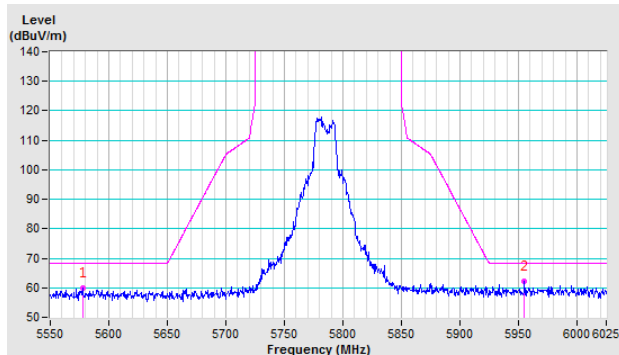

CH 165 5825 MHz

Horizontal

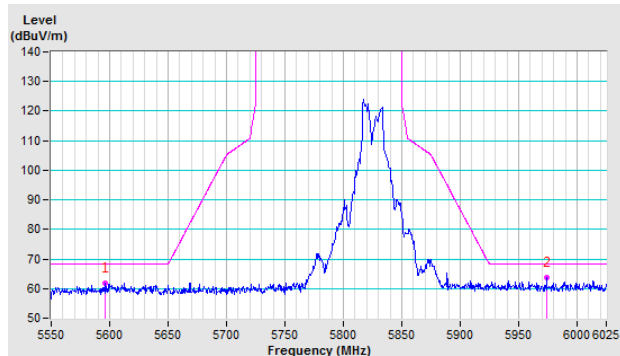

Vertical

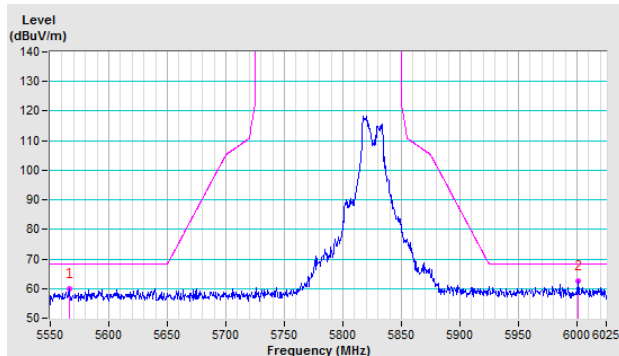

802.11ac (VHT40)

CH 151 5755 MHz

Horizontal

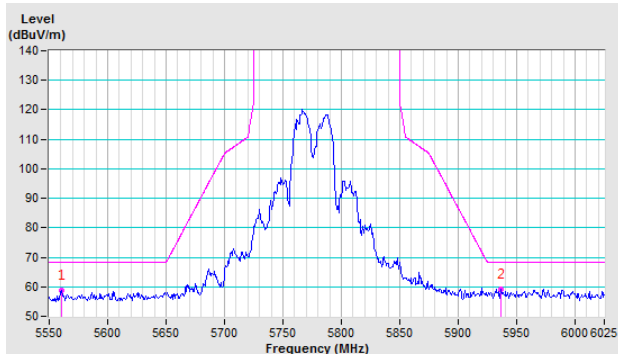

Vertical

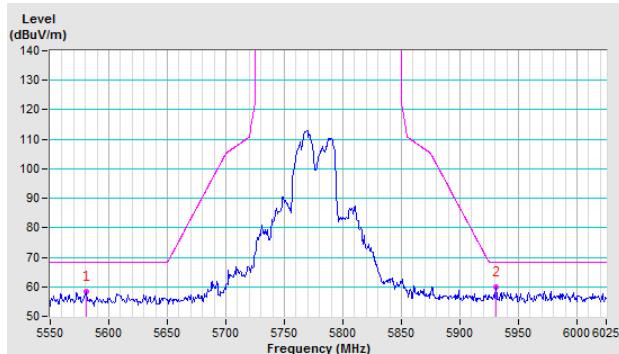

CH 159 5795 MHz

Horizontal

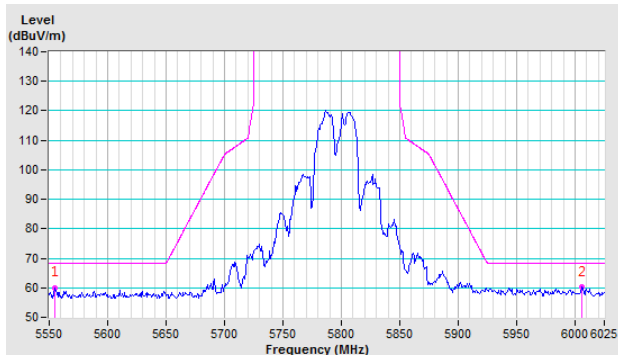

Vertical

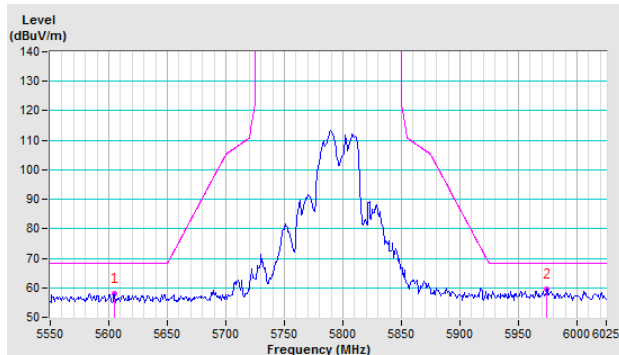

802.11ac (VHT80)

CH 155 5775 MHz

Horizontal

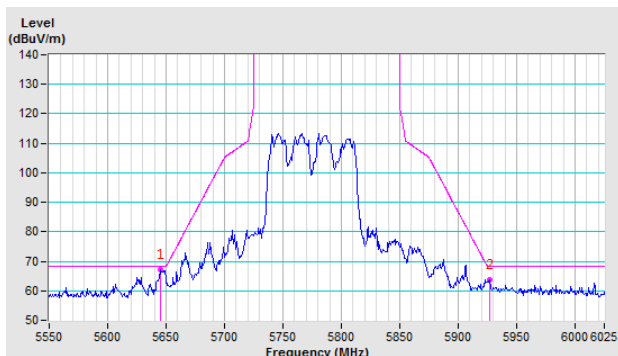

Vertical

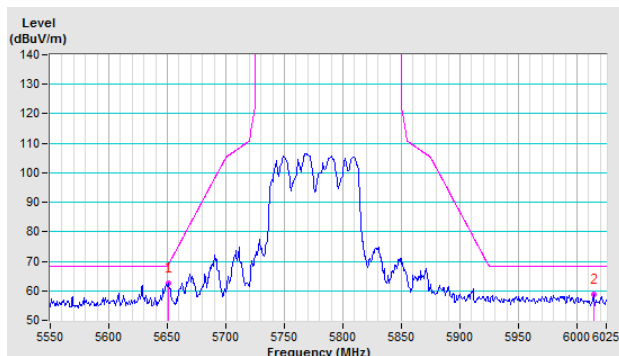

Appendix – Information on the Testing Laboratories

We, Bureau Veritas Consumer Products Services (H.K.) Ltd., Taoyuan Branch, were founded in 1988 to provide our best service in EMC, Radio, Telecom and Safety consultation. Our laboratories are FCC recognized accredited test firms and accredited according to ISO/IEC 17025.

If you have any comments, please feel free to contact us at the following:

Linkou EMC/RF Lab

Tel: 886-2-26052180

Fax: 886-2-26051924

Hsin Chu EMC/RF/Telecom Lab

Tel: 886-3-6668565

Fax: 886-3-6668323

Hwa Ya EMC/RF/Safety Lab

Tel: 886-3-3183232

Fax: 886-3-3270892

Email: service.adt@tw.bureauveritas.com

Web Site: www.bureauveritas-adt.com

The address and road map of all our labs can be found in our web site also.

--- END ---