

FCC Test Report (WLAN)

Report No.: RFBHYD-WTW-P21051101-1

FCC ID: I88WSM20

Test Model: WSM20

Received Date: July 12, 2021

Test Date: July 26 to Aug. 10, 2021

Issued Date: Oct. 27, 2021

Applicant: Zyxel Communications Corporation

Address: No.2 Industry East RD. IX, Hsinchu Science Park, Hsinchu 30075, Taiwan

Issued By: Bureau Veritas Consumer Products Services (H.K.) Ltd., Taoyuan Branch
Hsin Chu Laboratory

Lab Address: E-2, No.1, Li Hsin 1st Road, Hsinchu Science Park, Hsinchu City 300,
Taiwan

Test Location: E-2, No.1, Li Hsin 1st Road, Hsinchu Science Park, Hsinchu City 300,
Taiwan

**FCC Registration /
Designation Number:** 723255 / TW2022



This report is for your exclusive use. Any copying or replication of this report to or for any other person or entity, or use of our name or trademark, is permitted only with our prior written permission. This report sets forth our findings solely with respect to the test samples identified herein. The results set forth in this report are not indicative or representative of the quality or characteristics of the lot from which a test sample was taken or any similar or identical product unless specifically and expressly noted. Our report includes all of the tests requested by you and the results thereof based upon the information that you provided to us. You have 60 days from date of issuance of this report to notify us of any material error or omission caused by our negligence, provided, however, that such notice shall be in writing and shall specifically address the issue you wish to raise. A failure to raise such issue within the prescribed time shall constitute your unqualified acceptance of the completeness of this report, the tests conducted and the correctness of the report contents. Unless specific mention, the uncertainty of measurement has been explicitly taken into account to declare the compliance or non-compliance to the specification.

Table of Contents

Release Control Record	4
1 Certificate of Conformity	5
2 Summary of Test Results	6
2.1 Measurement Uncertainty	6
2.2 Modification Record	6
3 General Information	7
3.1 General Description of EUT	7
3.2 Description of Test Modes	10
3.2.1 Test Mode Applicability and Tested Channel Detail	11
3.3 Duty Cycle of Test Signal	14
3.4 Description of Support Units	15
3.4.1 Configuration of System under Test	16
3.5 General Description of Applied Standards and References	17
4 Test Types and Results	18
4.1 Radiated Emission and Bandedge Measurement	18
4.1.1 Limits of Radiated Emission and Bandedge Measurement	18
4.1.2 Test Instruments	19
4.1.3 Test Procedure	21
4.1.4 Deviation from Test Standard	21
4.1.5 Test Setup	22
4.1.6 EUT Operating Condition	23
4.1.7 Test Results	24
4.2 Conducted Emission Measurement	44
4.2.1 Limits of Conducted Emission Measurement	44
4.2.2 Test Instruments	44
4.2.3 Test Procedure	45
4.2.4 Deviation from Test Standard	45
4.2.5 Test Setup	45
4.2.6 EUT Operating Condition	45
4.2.7 Test Results	46
4.3 Transmit Power Measurement	48
4.3.1 Limits of Transmit Power Measurement	48
4.3.2 Test Setup	48
4.3.3 Test Instruments	48
4.3.4 Test Procedure	49
4.3.5 Deviation from Test Standard	49
4.3.6 EUT Operating Condition	49
4.3.7 Test Results	50
4.4 Occupied Bandwidth Measurement	54
4.4.1 Test Setup	54
4.4.2 Test Instruments	54
4.4.3 Test Procedure	54
4.4.4 Test Results	55
4.5 Peak Power Spectral Density Measurement	59
4.5.1 Limits of Peak Power Spectral Density Measurement	59
4.5.2 Test Setup	59
4.5.3 Test Instruments	59
4.5.4 Test Procedure	59
4.5.5 Deviation from Test Standard	60
4.5.6 EUT Operating Condition	60
4.5.7 Test Results	61
4.6 Frequency Stability Measurement	66
4.6.1 Limits of Frequency Stability Measurement	66

4.6.2	Test Setup.....	66
4.6.3	Test Instruments	66
4.6.4	Test Procedure	66
4.6.5	Deviation from Test Standard	66
4.6.6	EUT Operating Condition	66
4.6.7	Test Results	67
4.7	6dB Bandwidth Measurement	68
4.7.1	Limits of 6dB Bandwidth Measurement.....	68
4.7.2	Test Setup.....	68
4.7.3	Test Instruments	68
4.7.4	Test Procedure	68
4.7.5	Deviation from Test Standard	68
4.7.6	EUT Operating Condition	68
4.7.7	Test Results	69
5	Pictures of Test Arrangements.....	71
	Annex A - Radiated Out of Band Emission (OOBE) Measurement (For U-NII-3 band)	72
	Annex B - Band-Edge Measurement (For U-NII-1 band)	75
	Appendix – Information of the Testing Laboratories	79

Release Control Record

Issue No.	Description	Date Issued
RFBHYD-WTW-P21051101-1	Original release.	Oct. 27, 2021

1 Certificate of Conformity

Product: AX1800 Dual-Band WiFi 6 System

Brand: ZYXEL

Test Model: WSM20

Sample Status: Engineering sample

Applicant: Zyxel Communications Corporation

Test Date: July 26 to Aug. 10, 2021

Standard: 47 CFR FCC Part 15, Subpart E (Section 15.407)
ANSI C63.10: 2013

The above equipment has been tested by **Bureau Veritas Consumer Products Services (H.K.) Ltd., Taoyuan Branch**, and found compliance with the requirement of the above standards. The test record, data evaluation & Equipment Under Test (EUT) configurations represented herein are true and accurate accounts of the measurements of the sample's EMC characteristics under the conditions specified in this report.

Prepared by :



Date:

Oct. 27, 2021

Claire Kuan / Specialist

Approved by :



Date:

Oct. 27, 2021

Clark Lin / Technical Manager

2 Summary of Test Results

47 CFR FCC Part 15, Subpart E (Section 15.407)			
FCC Clause	Test Item	Result	Remarks
15.407(b)(8)	AC Power Conducted Emissions	Pass	Meet the requirement of limit. Minimum passing margin is -14.76 dB at 0.45078 MHz.
15.407(b) (1/2/3/4(i/ii)/8)	Radiated Emissions & Band Edge Measurement*	Pass	Meet the requirement of limit. Minimum passing margin is -0.6 dB at 5150.00 MHz, 11490.00 MHz and 11510.00 MHz.
15.407(a)(1/2/3)	Max Average Transmit Power	Pass	Meet the requirement of limit.
---	Occupied Bandwidth Measurement	-	Reference only.
15.407(a)(1/2/3)	Peak Power Spectral Density	Pass	Meet the requirement of limit.
15.407(e)	6dB bandwidth	Pass	Meet the requirement of limit. (U-NII-3 Band only)
15.407(g)	Frequency Stability	Pass	Meet the requirement of limit.
15.203	Antenna Requirement	Pass	Antenna connector is i-pex(MHF) not a standard connector.

Note:

- For U-NII-3 band compliance with rule part 15.407(b)(4)(i), the OOB test plots were recorded in Annex A.
- For U-NII-1, U-NII-2A, U-NII-2C band compliance with rule 15.407(b) of the band-edge items, the test plots were recorded in Annex B. Test Procedures refer to report 4.1.3.
- Determining compliance based on the results of the compliance measurement, not taking into account measurement instrumentation uncertainty.

2.1 Measurement Uncertainty

Where relevant, the following measurement uncertainty levels have been estimated for tests performed on the EUT as specified in CISPR 16-4-2:

Measurement	Frequency	Expanded Uncertainty (k=2) (\pm)
Conducted Emissions at mains ports	150kHz ~ 30MHz	1.9 dB
Radiated Emissions up to 1 GHz	9kHz ~ 30MHz	3.1 dB
	30MHz ~ 1GHz	5.4 dB
Radiated Emissions above 1 GHz	1GHz ~ 18GHz	5.0 dB
	18GHz ~ 40GHz	5.3 dB

2.2 Modification Record

There were no modifications required for compliance.

3 General Information

3.1 General Description of EUT

Product	AX1800 Dual-Band WiFi 6 System
Brand	ZYXEL
Test Model	WSM20
RF CPU Model No.	MT7621AT
RF Chip Model No.	MT7975DN
FW Version	V1.00(ABZF.0)B2
Status of EUT	Engineering sample
Power Supply Rating	12 Vdc from power adapter
Modulation Type	64QAM, 16QAM, QPSK, BPSK for OFDM 256QAM for OFDM in 11ac mode 1024QAM for OFDMA in 11ax HE mode
Modulation Technology	OFDM, OFDMA
Transfer Rate	802.11a: up to 54 Mbps 802.11n: up to 300 Mbps 802.11ac: up to 866.7 Mbps 802.11ax: up to 1201.0 Mbps
Operating Frequency	5.18~ 5.24 GHz, 5.745 ~ 5.825 GHz
Number of Channel	802.11a, 802.11n (HT20), 802.11ac (VHT20), 802.11ax (HE20): 9 802.11n (HT40), 802.11ac (VHT40), 802.11ax (HE40): 4 802.11ac (VHT80), 802.11ax (HE80): 2
Output Power	CDD Mode: 5.18 ~ 5.24 GHz: 904.325 mW 5.745 ~ 5.825 GHz: 687.181 mW Beamforming Mode: 5.18 ~ 5.24 GHz: 751.029 mW 5.745 ~ 5.825 GHz: 687.181 mW
Antenna Type	Refer to Note
Antenna Connector	Refer to Note
Accessory	- AC Adapter (Brand: APD, Model: WB-18Q12FU) - Ethernet Cable (Unshielded, 1.5m)

Note:

1. Simultaneously transmission condition.

Condition	Technology	
1	WLAN 2.4GHz	WLAN 5GHz

Note: The emission of the simultaneous operation has been evaluated and no non-compliance was found.

2. The EUT must be supplied with a power adapter and following below table:

Brand	Model No.	Spec.
APD	WB-18Q12FU	AC Input: 100-240V, 50-60Hz, 0.6A Max. DC Output: 12.0V, 1.5A 18.0W DC Cable: Unshielded, 2.0m

3. The antennas provided to the EUT, please refer to the following table:

Antenna NO.	RF Chain NO.	Brand	Model	Antenna Net Gain(dBi)	Frequency range	Antenna Type	Connector Type	Cable Length (mm)
2	2.4G_Chain 0	WHAYU	56-001-000044Z	2.5	2.4~2.4835GHz	Dipole	i-pex(MHF)	115
	5G_Chain 0			3.4	5.15~5.85GHz			
3	2.4G_Chain 1	WHAYU	56-001-000045Z	2.4	2.4~2.4835GHz	PIFA	i-pex(MHF)	115
	5G_Chain 1			3.4	5.15~5.85GHz			

4. The EUT incorporates a MIMO function:

5GHz Band		
MODULATION MODE	TX & RX CONFIGURATION	
802.11a	2TX	2RX
802.11n (HT20)	2TX	2RX
802.11n (HT40)	2TX	2RX
802.11ac (VHT20)	2TX	2RX
802.11ac (VHT40)	2TX	2RX
802.11ac (VHT80)	2TX	2RX
802.11ax (HE20)	2TX	2RX
802.11ax (HE40)	2TX	2RX
802.11ax (HE80)	2TX	2RX

Note:

- All of modulation mode support beamforming function except 802.11a modulation mode.
- The EUT support Beamforming and CDD mode, therefore both mode were investigated and the worst case scenario was identified. The worst case data were presented in test report.
- The modulation and bandwidth are similar for 802.11n mode for 20MHz (40MHz), 802.11ac mode for 20MHz (40MHz, 80MHz) and 802.11ax mode for 20MHz (40MHz, 80MHz), therefore the manufacturer will control the power for 802.11n/ac mode is the same as the 802.11ax or more lower than it and investigated worst case to representative mode in test report.

5. The power setting are list as below:

CDD Mode							
802.11a		802.11ac (VHT20)		802.11ac (VHT40)		802.11ac (VHT80)	
Frequency (MHz)	Power Setting	Frequency (MHz)	Power Setting	Frequency (MHz)	Power Setting	Frequency (MHz)	Power Setting
5180	19.5	5180	18	5190	14	5210	12.5
5200	24	5200	23	5230	21.5	5775	22
5240	24.5	5240	23.5	5755	24		
5745	21.5	5745	23	5795	23.5		
5785	22.5	5785	23				
5825	22	5825	22.5				
802.11ax (HE20)		802.11ax (HE40)		802.11ax (HE80)			
Frequency (MHz)	Power Setting	Frequency (MHz)	Power Setting	Frequency (MHz)	Power Setting		
5180	18	5190	14	5210	12.5		
5200	23	5230	21.5	5775	22		
5240	23.5	5755	24				
5745	23	5795	23.5				
5785	23						
5825	22.5						

Beamforming Mode					
802.11ac (VHT20)		802.11ac (VHT40)		802.11ac (VHT80)	
Frequency (MHz)	Power Setting	Frequency (MHz)	Power Setting	Frequency (MHz)	Power Setting
5180	18	5190	14	5210	12.5
5200	23	5230	21.5	5775	22
5240	23.5	5755	24		
5745	23	5795	23.5		
5785	23				
5825	22.5				
802.11ax (HE20)		802.11ax (HE40)		802.11ax (HE80)	
Frequency (MHz)	Power Setting	Frequency (MHz)	Power Setting	Frequency (MHz)	Power Setting
5180	18	5190	14	5210	12.5
5200	23	5230	21.5	5775	22
5240	23.5	5755	24		
5745	23	5795	23.5		
5785	23				
5825	22.5				

6. The above EUT information is declared by manufacturer and for more detailed features description, please refer to the manufacturer's specifications or user's manual.
7. The above Antenna information is declared by manufacturer and for more detailed features description, please refer to the manufacturer's specifications, the laboratory shall not be held responsible.

3.2 Description of Test Modes

FOR 5180 ~ 5240MHz

4 channels are provided for 802.11a, 802.11n (HT20), 802.11ac (VHT20), 802.11ax (HE20):

Channel	Frequency	Channel	Frequency
36	5180 MHz	44	5220 MHz
40	5200 MHz	48	5240 MHz

2 channels are provided for 802.11n (HT40), 802.11ac (VHT40), 802.11ax (HE40):

Channel	Frequency	Channel	Frequency
38	5190 MHz	46	5230 MHz

1 channel is provided for 802.11ac (VHT80), 802.11ax (HE80):

Channel	Frequency
42	5210 MHz

FOR 5745 ~ 5825MHz:

5 channels are provided for 802.11a, 802.11n (HT20), 802.11ac (VHT20), 802.11ax (HE20):

Channel	Frequency	Channel	Frequency
149	5745 MHz	161	5805 MHz
153	5765 MHz	165	5825 MHz
157	5785 MHz		

2 channels are provided for 802.11n (HT40), 802.11ac (VHT40), 802.11ax (HE40):

Channel	Frequency	Channel	Frequency
151	5755 MHz	159	5795 MHz

1 channel is provided for 802.11ac (VHT80), 802.11ax (HE80):

Channel	Frequency
155	5775 MHz

3.2.1 Test Mode Applicability and Tested Channel Detail

EUT Configure Mode	Applicable To				Description
	RE \geq 1G	RE<1G	PLC	APCM	
-	√	√	√	√	-

Where **RE \geq 1G**: Radiated Emission above 1GHz
RE<1G: Radiated Emission below 1GHz
PLC: Power Line Conducted Emission
APCM: Antenna Port Conducted Measurement

Radiated Emission Test (Above 1GHz):

- Pre-Scan has been conducted to determine the worst-case mode from all possible combinations between available modulations, data rates and antenna ports (if EUT with antenna diversity architecture).
- Following channel(s) was (were) selected for the final test as listed below.

CDD Mode						
Mode	FREQ. Band (MHz)	Available Channel	Tested Channel	Modulation Technology	Modulation Type	Data Rate Parameter
802.11a	5180-5240	36 to 48	36, 40, 48	OFDM	BPSK	6Mb/s
802.11ax (HE20)		36 to 48	36, 40, 48	OFDMA	BPSK	MCS0
802.11ax (HE40)		38 to 46	38, 46	OFDMA	BPSK	MCS0
802.11ax (HE80)		42	42	OFDMA	BPSK	MCS0
802.11a	5745-5825	149 to 165	149, 157, 165	OFDM	BPSK	6Mb/s
802.11ax (HE20)		149 to 165	149, 157, 165	OFDMA	BPSK	MCS0
802.11ax (HE40)		151 to 159	151, 159	OFDMA	BPSK	MCS0
802.11ax (HE80)		155	155	OFDMA	BPSK	MCS0

Radiated Emission Test (Below 1GHz):

- Pre-Scan has been conducted to determine the worst-case mode from all possible combinations between available modulations, data rates and antenna ports (if EUT with antenna diversity architecture).
- Following channel(s) was (were) selected for the final test as listed below.

CDD Mode						
Mode	FREQ. Band (MHz)	Available Channel	Tested Channel	Modulation Technology	Modulation Type	Data Rate Parameter
802.11a	5180-5240 5745-5825	36 to 48 149 to 165	48	OFDM	BPSK	6Mb/s

Power Line Conducted Emission Test:

- Pre-Scan has been conducted to determine the worst-case mode from all possible combinations between available modulations, data rates and antenna ports (if EUT with antenna diversity architecture).
- Following channel(s) was (were) selected for the final test as listed below.

CDD Mode						
Mode	FREQ. Band (MHz)	Available Channel	Tested Channel	Modulation Technology	Modulation Type	Data Rate Parameter
802.11a	5180-5240 5745-5825	36 to 48 149 to 165	48	OFDM	BPSK	6Mb/s

Antenna Port Conducted Measurement:

- This item includes all test value of each mode, but only includes spectrum plot of worst value of each mode.
- Pre-Scan has been conducted to determine the worst-case mode from all possible combinations between available modulations, data rates and antenna ports (if EUT with antenna diversity architecture).
- Following channel(s) was (were) selected for the final test as listed below.

CDD Mode						
Mode	FREQ. Band (MHz)	Available Channel	Tested Channel	Modulation Technology	Modulation Type	Data Rate Parameter
802.11a	5180-5240	36 to 48	36, 40, 48	OFDM	BPSK	6Mb/s
802.11ac (VHT20) (output power only)		36 to 48	36, 40, 48	OFDM	BPSK	MCS0
802.11ac (VHT40) (output power only)		38 to 46	38, 46	OFDM	BPSK	MCS0
802.11ac (VHT80) (output power only)		42	42	OFDM	BPSK	MCS0
802.11ax (HE20)		36 to 48	36, 40, 48	OFDMA	BPSK	MCS0
802.11ax (HE40)		38 to 46	38, 46	OFDMA	BPSK	MCS0
802.11ax (HE80)		42	42	OFDMA	BPSK	MCS0
Mode		FREQ. Band (MHz)	Available Channel	Tested Channel	Modulation Technology	Modulation Type
802.11a	5745-5825	149 to 165	149, 157, 165	OFDM	BPSK	6Mb/s
802.11ac (VHT20) (output power only)		149 to 165	149, 157, 165	OFDM	BPSK	MCS0
802.11ac (VHT40) (output power only)		151 to 159	151, 159	OFDM	BPSK	MCS0
802.11ac (VHT80) (output power only)		155	155	OFDM	BPSK	MCS0
802.11ax (HE20)		149 to 165	149, 157, 165	OFDMA	BPSK	MCS0
802.11ax (HE40)		151 to 159	151, 159	OFDMA	BPSK	MCS0
802.11ax (HE80)		155	155	OFDMA	BPSK	MCS0
Beamforming Mode (output power only)						
Mode	FREQ. Band (MHz)	Available Channel	Tested Channel	Modulation Technology	Modulation Type	Data Rate Parameter
802.11ac (VHT20)	5180-5240	36 to 48	36, 40, 48	OFDM	BPSK	MCS0
802.11ac (VHT40)		38 to 46	38, 46	OFDM	BPSK	MCS0
802.11ac (VHT80)		42	42	OFDM	BPSK	MCS0
802.11ax (HE20)		36 to 48	36, 40, 48	OFDMA	BPSK	MCS0
802.11ax (HE40)		38 to 46	38, 46	OFDMA	BPSK	MCS0
802.11ax (HE80)		42	42	OFDMA	BPSK	MCS0
802.11ac (VHT20)		5745-5825	149 to 165	149, 157, 165	OFDM	BPSK
802.11ac (VHT40)	151 to 159		151, 159	OFDM	BPSK	MCS0
802.11ac (VHT80)	155		155	OFDM	BPSK	MCS0
802.11ax (HE20)	149 to 165		149, 157, 165	OFDMA	BPSK	MCS0
802.11ax (HE40)	151 to 159		151, 159	OFDMA	BPSK	MCS0
802.11ax (HE80)	155		155	OFDMA	BPSK	MCS0

Test Condition:

Applicable To	Environmental Conditions	Input Power	Tested By
RE \geq 1G	20deg. C, 70%RH	120Vac, 60Hz	Ryan Du Tom Yang
RE<1G	25deg. C, 66%RH	120Vac, 60Hz	Tom Yang
PLC	25deg. C, 66%RH	120Vac, 60Hz	Tom Yang
APCM	25deg. C, 60%RH	120Vac, 60Hz	Leon Dai

3.3 Duty Cycle of Test Signal

Duty cycle of test signal is > 98 %, duty factor is not required.

802.11a: Duty cycle = 2.724 ms / 2.771 ms = 0.983

802.11ax (HE20): Duty cycle = 3.788 ms / 3.86 ms = 0.981

802.11ax (HE40): Duty cycle = 3.778 ms / 3.833 ms = 0.986

802.11ax (HE80): Duty cycle = 2.306 ms / 2.346 ms = 0.983

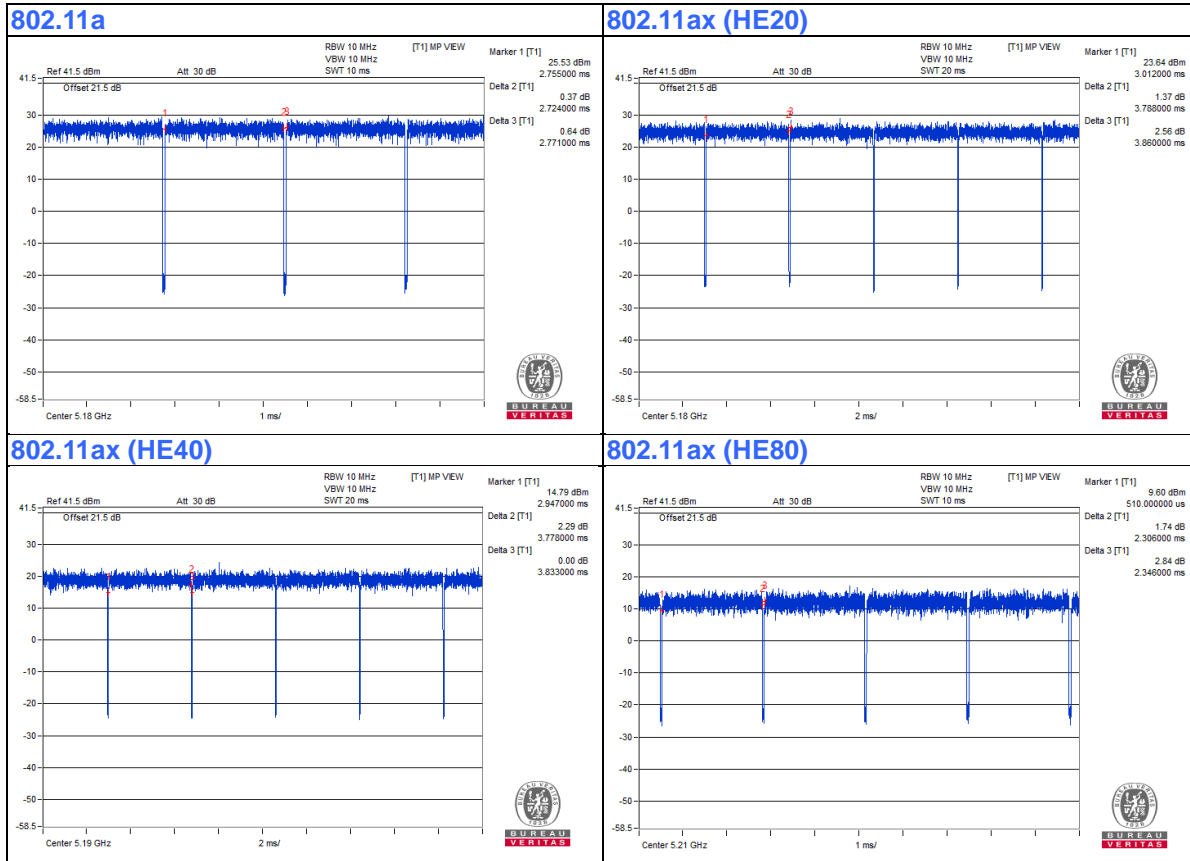

3.4 Description of Support Units

The EUT has been tested as an independent unit together with other necessary accessories or support units. The following support units or accessories were used to form a representative test configuration during the tests.

ID	Product	Brand	Model No.	Serial No.	FCC ID	Remarks
A.	Laptop	DELL	E5430	4YV4VY1	DoC	Provided by Lab
B.	Switch	D-Link	DGS-1005D	DR8WC92000523	NA	Provided by Lab
C.	Laptop	DELL	E5430	HYV4VY1	DoC	Provided by Lab

Note:

1. All power cords of the above support units are non-shielded (1.8m).

ID	Descriptions	Qty.	Length (m)	Shielding (Yes/No)	Cores (Qty.)	Remarks
1.	RJ-45 Cable	1	10	No	0	Provided by Lab
2.	RJ-45 Cable	2	10	No	0	Provided by Lab
3.	RJ-45 Cable	1	10	No	0	Provided by Lab
4.	RJ-45 Cable	1	1.5	No	0	Supplied by client
5.	DC Cable	1	2	No	0	Supplied by client

3.4.1 Configuration of System under Test

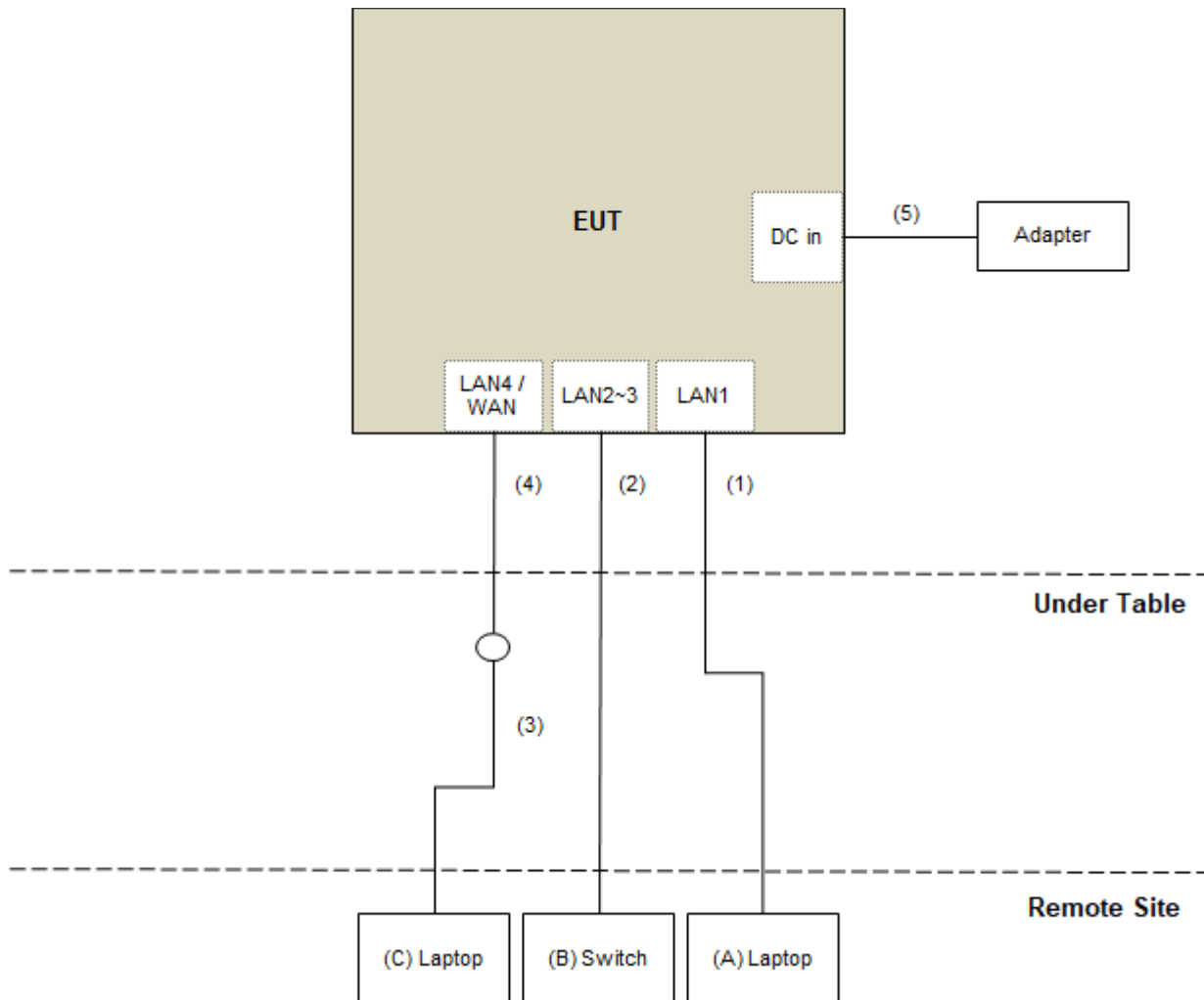

3.5 General Description of Applied Standards and References

The EUT is a RF Product. According to the specifications of the manufacturer, it must comply with the requirements of the following standards and references:

Test Standard:

FCC Part 15, Subpart E (15.407)

ANSI C63.10-2013

All test items have been performed and recorded as per the above standards.

References Test Guidance:

KDB 789033 D02 General UNII Test Procedure New Rules v02r01

KDB 662911 D01 Multiple Transmitter Output v02r01

All test items have been performed as a reference to the above KDB test guidance.

4 Test Types and Results

4.1 Radiated Emission and Bandedge Measurement

4.1.1 Limits of Radiated Emission and Bandedge Measurement

Radiated emissions which fall in the restricted bands must comply with the radiated emission limits specified as below table.

Frequencies (MHz)	Field Strength (microvolts/meter)	Measurement Distance (meters)
0.009 ~ 0.490	2400/F(kHz)	300
0.490 ~ 1.705	24000/F(kHz)	30
1.705 ~ 30.0	30	30
30 ~ 88	100	3
88 ~ 216	150	3
216 ~ 960	200	3
Above 960	500	3

NOTE:

- The lower limit shall apply at the transition frequencies.
- Emission level (dBuV/m) = 20 log Emission level (uV/m).
- For frequencies above 1000MHz, the field strength limits are based on average detector, however, the peak field strength of any emission shall not exceed the maximum permitted average limits, specified above by more than 20dB under any condition of modulation.

Limits of unwanted emission out of the restricted bands

Applicable To		Limit	
789033 D02 General UNII Test Procedure New Rules v02r01		Field Strength at 3m	
		PK:74 (dBµV/m)	AV:54 (dBµV/m)
Frequency Band	Applicable To	EIRP Limit	Equivalent Field Strength at 3m
5150~5250 MHz	15.407(b)(1)	PK:-27 (dBm/MHz)	PK:68.2(dBµV/m)
5250~5350 MHz	15.407(b)(2)		
5470~5725 MHz	15.407(b)(3)		
5725~5850 MHz	15.407(b)(4)(i)	PK: -27 (dBm/MHz) ^{*1} PK: 10 (dBm/MHz) ^{*2} PK: 15.6 (dBm/MHz) ^{*3} PK: 27 (dBm/MHz) ^{*4}	PK: 68.2(dBµV/m) ^{*1} PK: 105.2 (dBµV/m) ^{*2} PK: 110.8(dBµV/m) ^{*3} PK: 122.2 (dBµV/m) ^{*4}
5725~5850 MHz	15.407(b)(4)(i)	PK:-27 (dBm/MHz) ^{*1} PK:10 (dBm/MHz) ^{*2} PK:15.6 (dBm/MHz) ^{*3} PK:27 (dBm/MHz) ^{*4}	PK: 68.2(dBµV/m) ^{*1} PK:105.2 (dBµV/m) ^{*2} PK: 110.8(dBµV/m) ^{*3} PK:122.2 (dBµV/m) ^{*4}
^{*1} beyond 75 MHz or more above of the band edge.		^{*2} below the band edge increasing linearly to 10 dBm/MHz at 25 MHz above.	
^{*3} below the band edge increasing linearly to a level of 15.6 dBm/MHz at 5 MHz above.		^{*4} from 5 MHz above or below the band edge increasing linearly to a level of 27 dBm/MHz at the band edge.	

Note:

The following formula is used to convert the equipment isotropic radiated power (eirp) to field strength:

$$E = \frac{1000000\sqrt{30P}}{3} \mu\text{V/m, where P is the eirp (Watts).}$$

4.1.2 Test Instruments

For Radiated emission & OBE & Bandedge test:

DESCRIPTION & MANUFACTURER	MODEL NO.	SERIAL NO.	CALIBRATED DATE	CALIBRATED UNTIL
Test Receiver Keysight	N9038A	MY54450088	July 06, 2021	July 05, 2022
Pre-Amplifier EMCI	EMC001340	980142	May 24, 2021	May 23, 2022
Loop Antenna Electro-Metrics	EM-6879	264	Mar. 05, 2021	Mar. 04, 2022
RF Cable	5D-FB	LOOPCAB-001	Jan. 07, 2021	Jan. 06, 2022
RF Cable	5D-FB	LOOPCAB-002	Jan. 07, 2021	Jan. 06, 2022
Pre-Amplifier Mini-Circuits	ZFL-1000VH2	QA0838008	Oct. 20, 2020	Oct. 19, 2021
Trilog Broadband Antenna SCHWARZBECK	VULB 9168	9168-361	Nov. 05, 2020	Nov. 04, 2021
RF Cable	8D	966-3-1	Mar. 16, 2021	Mar. 15, 2022
RF Cable	8D	966-3-2	Mar. 16, 2021	Mar. 15, 2022
RF Cable	8D	966-3-3	Mar. 16, 2021	Mar. 15, 2022
Fixed attenuator Mini-Circuits	UNAT-5+	PAD-3m-3-01	Sep. 24, 2020	Sep. 23, 2021
Horn_Antenna SCHWARZBECK	BBHA9120-D	9120D-406	Nov. 22, 2020	Nov. 21, 2021
Pre-Amplifier EMCI	EMC12630SE	980384	Jan. 11, 2021	Jan. 10, 2022
RF Cable	EMC104-SM-SM-1500	180504	Apr. 26, 2021	Apr. 25, 2022
RF Cable	EMC104-SM-SM-2000	180601	June 08, 2021	June 07, 2022
RF Cable	EMC104-SM-SM-6000	210201	May 13, 2021	May 12, 2022
Spectrum Analyzer Keysight	N9030A	MY54490679	July 09, 2021	July 08, 2022
Pre-Amplifier EMCI	EMC184045SE	980387	Jan. 11, 2021	Jan. 10, 2022
Horn_Antenna SCHWARZBECK	BBHA 9170	BBHA9170519	Nov. 22, 2020	Nov. 21, 2021
RF Cable	EMC102-KM-KM-1200	160924	Jan. 11, 2021	Jan. 10, 2022
RF Cable	EMC-KM-KM-4000	200214	Mar. 10, 2021	Mar. 09, 2022
Software	ADT_Radiated_V8.7.08	NA	NA	NA
Antenna Tower & Turn Table Max-Full	MF-7802	MF780208406	NA	NA
Boresight Antenna Fixture	FBA-01	FBA-SIP01	NA	NA

Note:

1. The calibration interval of the above test instruments is 12 months and the calibrations are traceable to NML/ROC and NIST/USA.
2. The test was performed in 966 Chamber No. 3.
3. Tested Date: July 26 to Aug. 05, 2021

For other test items test:

DESCRIPTION & MANUFACTURER	MODEL NO.	SERIAL NO.	CALIBRATED DATE	CALIBRATED UNTIL
Spectrum Analyzer R&S	FSV40	101516	Mar. 08, 2021	Mar. 07, 2022
Power meter Anritsu	ML2495A	1529002	June 21, 2021	June 20, 2022
Power sensor Anritsu	MA2411B	1339443	May 31, 2021	May 30, 2022
10dB Attenuator Woken	MDCS18N-10	MDCS18N-10-01	Apr. 13, 2021	Apr. 12, 2022
AC Power Source Extech Electronics	6905S	1991551	NA	NA
Temperature & Humidity Chamber Giant Force	GTH-150-40-SP-AR	MAA0812-008	Jan. 14, 2021	Jan. 13, 2022
True RMS Clamp Meter FLUKE	325	31130711WS	June 02, 2021	June 01, 2022
Software	ADT_RF Test Software V6.6.5.4	NA	NA	NA

- NOTE:**
1. The test was performed in Oven room 2.
 2. The calibration interval of the above test instruments is 12 months and the calibrations are traceable to NML/ROC and NIST/USA.
 3. Tested Date: Aug. 10, 2021

4.1.3 Test Procedure

For Radiated emission below 30MHz

- a. The EUT was placed on the top of a rotating table 0.8 meters above the ground at a 3 meter chamber room. The table was rotated 360 degrees to determine the position of the highest radiation.
- b. The EUT was set 3 meters away from the interference-receiving antenna, which was mounted on the top of a variable-height antenna tower.
- c. Parallel, perpendicular, and ground-parallel orientations of the antenna are set to make the measurement.
- d. For each suspected emission, the EUT was arranged to its worst case and the rotatable table was turned from 0 degrees to 360 degrees to find the maximum reading.
- e. The test-receiver system was set to Quasi-Peak Detect Function and Specified Bandwidth with Maximum Hold Mode.

Note:

1. The resolution bandwidth and video bandwidth of test receiver/spectrum analyzer is 9kHz at frequency below 30MHz.

For Radiated emission above 30MHz

- a. The EUT was placed on the top of a rotating table 0.8 meters (for 30MHz ~ 1GHz) / 1.5 meters (for above 1GHz) above the ground at 3 meter chamber room for test. The table was rotated 360 degrees to determine the position of the highest radiation.
- b. The EUT was set 3 meters away from the interference-receiving antenna, which was mounted on the top of a variable-height antenna tower.
- c. The height of antenna is varied from one meter to four meters above the ground to determine the maximum value of the field strength. Both horizontal and vertical polarizations of the antenna are set to make the measurement.
- d. For each suspected emission, the EUT was arranged to its worst case and then the antenna was tuned to heights from 1 meter to 4 meters and the rotatable table was turned from 0 degrees to 360 degrees to find the maximum reading.
- e. The test-receiver system was set to quasi-peak detect function and specified bandwidth with maximum hold mode when the test frequency is below 1 GHz.
- f. The test-receiver system was set to peak and average detects function and specified bandwidth with maximum hold mode when the test frequency is above 1 GHz. If the peak reading value also meets average limit, measurement with the average detector is unnecessary.

Note:

1. The resolution bandwidth and video bandwidth of test receiver/spectrum analyzer is 120kHz for Quasi-peak detection (QP) at frequency below 1GHz.
2. The resolution bandwidth of test receiver/spectrum analyzer is 1 MHz and the video bandwidth is 3 MHz for Peak detection (PK) at frequency above 1GHz.
3. The resolution bandwidth of test receiver/spectrum analyzer is 1MHz and the video bandwidth is $\geq 1/T$ (Duty cycle < 98%) or 10Hz (Duty cycle $\geq 98\%$) for Average detection (AV) at frequency above 1GHz.
4. All modes of operation were investigated and the worst-case emissions are reported.

4.1.4 Deviation from Test Standard

No deviation.

4.1.5 Test Setup

For Radiated emission below 30MHz

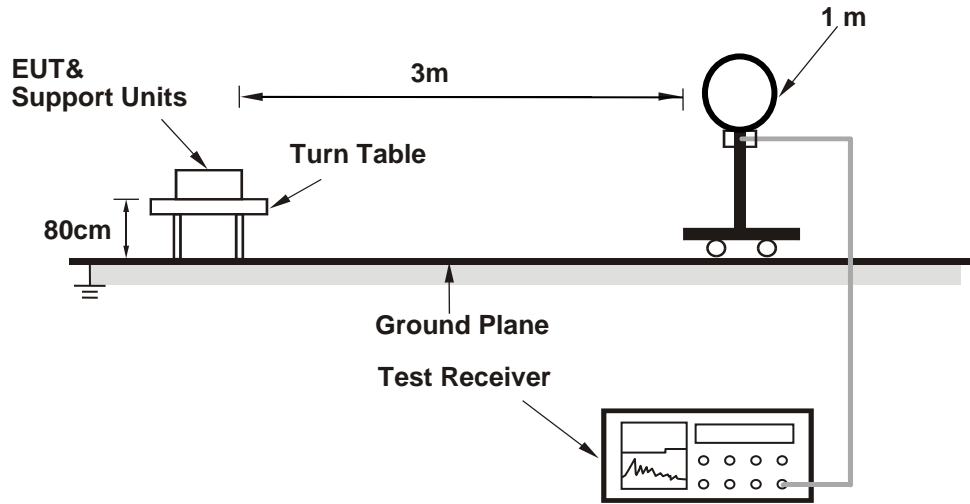

For Radiated emission 30MHz to 1GHz

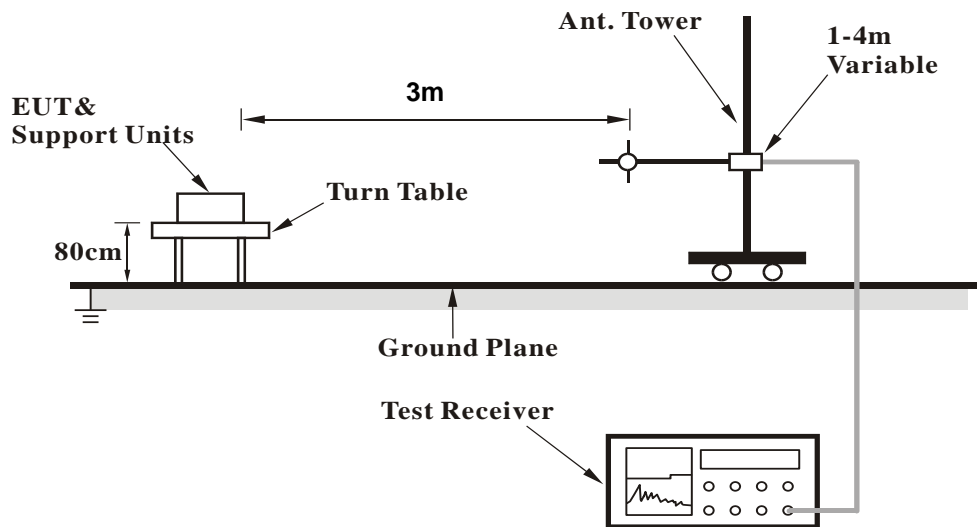

For Radiated emission above 1GHz

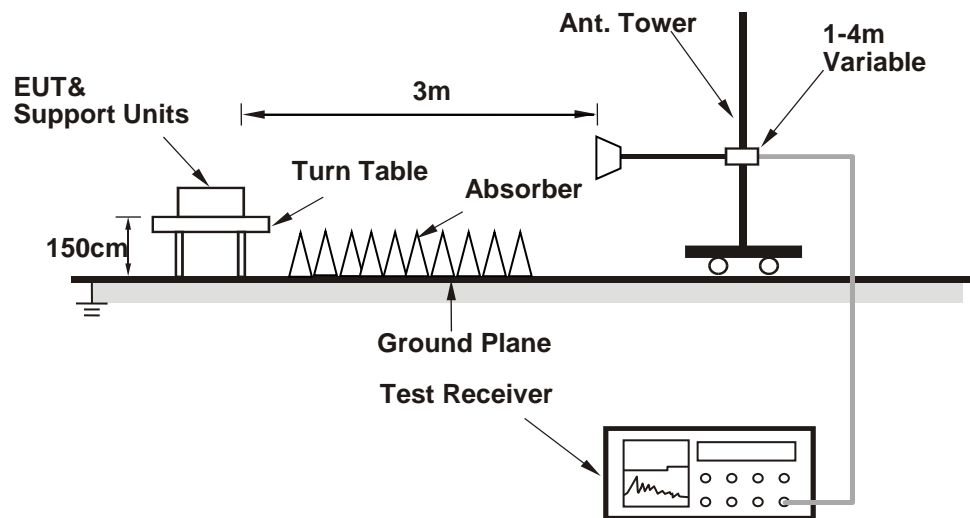

For the actual test configuration, please refer to the attached file (Test Setup Photo).

4.1.6 EUT Operating Condition

- a. Placed the EUT on the testing table.
- b. Controlling software (package_Ulv2.13_DLLv5.11_20191004-alpha-RSSI -DFS) has been activated to set the EUT under transmission condition continuously at specific channel frequency.

4.1.7 Test Results

Above 1GHz Data:

RF Mode	TX 802.11a	Channel	CH 36 : 5180 MHz
Frequency Range	1GHz ~ 40GHz	Detector Function	Peak (PK) Average (AV)

Antenna Polarity & Test Distance : Horizontal at 3 m								
No	Frequency (MHz)	Emission Level (dBuV/m)	Limit (dBuV/m)	Margin (dB)	Antenna Height (m)	Table Angle (Degree)	Raw Value (dBuV)	Correction Factor (dB/m)
1	5150.00	65.8 PK	74.0	-8.2	1.73 H	31	61.1	4.7
2	5150.00	53.3 AV	54.0	-0.7	1.73 H	31	48.6	4.7
3	*5180.00	118.6 PK			1.73 H	31	114.0	4.6
4	*5180.00	109.2 AV			1.73 H	31	104.6	4.6
5	#10360.00	56.7 PK	68.2	-11.5	1.64 H	234	43.3	13.4
6	15540.00	54.6 PK	74.0	-19.4	1.38 H	183	40.1	14.5
7	15540.00	41.3 AV	54.0	-12.7	1.38 H	183	26.8	14.5
Antenna Polarity & Test Distance : Vertical at 3 m								
No	Frequency (MHz)	Emission Level (dBuV/m)	Limit (dBuV/m)	Margin (dB)	Antenna Height (m)	Table Angle (Degree)	Raw Value (dBuV)	Correction Factor (dB/m)
1	5150.00	62.2 PK	74.0	-11.8	1.53 V	158	57.5	4.7
2	5150.00	48.1 AV	54.0	-5.9	1.53 V	158	43.4	4.7
3	*5180.00	113.7 PK			1.53 V	158	109.1	4.6
4	*5180.00	104.7 AV			1.53 V	158	100.1	4.6
5	#10360.00	53.1 PK	68.2	-15.1	2.19 V	206	39.7	13.4
6	15540.00	52.4 PK	74.0	-21.6	1.73 V	140	37.9	14.5
7	15540.00	40.6 AV	54.0	-13.4	1.73 V	140	26.1	14.5

Remarks:

1. Emission Level(dBuV/m) = Raw Value(dBuV) + Correction Factor(dB/m)
2. Correction Factor(dB/m) = Antenna Factor(dB/m) + Cable Factor(dB) – Pre-Amplifier Factor(dB)
3. Margin value = Emission Level – Limit value
4. The other emission levels were very low against the limit.
5. " * ": Fundamental frequency.
6. " # ": The radiated frequency is out of the restricted band.

RF Mode	TX 802.11a	Channel	CH 40 : 5200 MHz
Frequency Range	1GHz ~ 40GHz	Detector Function	Peak (PK) Average (AV)

Antenna Polarity & Test Distance : Horizontal at 3 m

No	Frequency (MHz)	Emission Level (dBuV/m)	Limit (dBuV/m)	Margin (dB)	Antenna Height (m)	Table Angle (Degree)	Raw Value (dBuV)	Correction Factor (dB/m)
1	5150.00	72.0 PK	74.0	-2.0	1.46 H	27	67.3	4.7
2	5150.00	53.2 AV	54.0	-0.8	1.46 H	27	48.5	4.7
3	*5200.00	123.2 PK			1.46 H	27	118.8	4.4
4	*5200.00	113.4 AV			1.46 H	27	109.0	4.4
5	#10400.00	61.1 PK	68.2	-7.1	1.60 H	249	47.5	13.6
6	15600.00	58.0 PK	74.0	-16.0	1.41 H	189	43.5	14.5
7	15600.00	45.3 AV	54.0	-8.7	1.41 H	189	30.8	14.5

Antenna Polarity & Test Distance : Vertical at 3 m

No	Frequency (MHz)	Emission Level (dBuV/m)	Limit (dBuV/m)	Margin (dB)	Antenna Height (m)	Table Angle (Degree)	Raw Value (dBuV)	Correction Factor (dB/m)
1	5150.00	61.7 PK	74.0	-12.3	2.33 V	144	57.0	4.7
2	5150.00	47.6 AV	54.0	-6.4	2.33 V	144	42.9	4.7
3	*5200.00	119.1 PK			2.33 V	144	114.7	4.4
4	*5200.00	109.9 AV			2.33 V	144	105.5	4.4
5	#10400.00	58.1 PK	68.2	-10.1	2.19 V	202	44.5	13.6
6	15600.00	57.8 PK	74.0	-16.2	1.68 V	128	43.3	14.5
7	15600.00	45.2 AV	54.0	-8.8	1.68 V	128	30.7	14.5

Remarks:

1. Emission Level(dBuV/m) = Raw Value(dBuV) + Correction Factor(dB/m)
2. Correction Factor(dB/m) = Antenna Factor(dB/m) + Cable Factor(dB) – Pre-Amplifier Factor(dB)
3. Margin value = Emission Level – Limit value
4. The other emission levels were very low against the limit.
5. " * ": Fundamental frequency.
6. " # ": The radiated frequency is out of the restricted band.

RF Mode	TX 802.11a	Channel	CH 48 : 5240 MHz
Frequency Range	1GHz ~ 40GHz	Detector Function	Peak (PK) Average (AV)

Antenna Polarity & Test Distance : Horizontal at 3 m								
No	Frequency (MHz)	Emission Level (dBuV/m)	Limit (dBuV/m)	Margin (dB)	Antenna Height (m)	Table Angle (Degree)	Raw Value (dBuV)	Correction Factor (dB/m)
1	4873.97	55.4 PK	74.0	-18.6	1.63 H	75	51.6	3.8
2	4873.97	47.1 AV	54.0	-6.9	1.63 H	75	43.3	3.8
3	*5240.00	122.7 PK			1.63 H	75	118.3	4.4
4	*5240.00	113.0 AV			1.63 H	75	108.6	4.4
5	#10480.00	61.4 PK	68.2	-6.8	1.63 H	260	47.7	13.7
6	15720.00	57.4 PK	74.0	-16.6	1.46 H	199	43.0	14.4
7	15720.00	45.0 AV	54.0	-9.0	1.46 H	199	30.6	14.4

Antenna Polarity & Test Distance : Vertical at 3 m								
No	Frequency (MHz)	Emission Level (dBuV/m)	Limit (dBuV/m)	Margin (dB)	Antenna Height (m)	Table Angle (Degree)	Raw Value (dBuV)	Correction Factor (dB/m)
1	5150.00	55.0 PK	74.0	-19.0	2.37 V	131	50.3	4.7
2	5150.00	44.0 AV	54.0	-10.0	2.37 V	131	39.3	4.7
3	*5240.00	119.1 PK			2.37 V	131	114.7	4.4
4	*5240.00	109.4 AV			2.37 V	131	105.0	4.4
5	#10480.00	57.6 PK	68.2	-10.6	2.17 V	210	43.9	13.7
6	15720.00	57.5 PK	74.0	-16.5	1.73 V	121	43.1	14.4
7	15720.00	44.9 AV	54.0	-9.1	1.73 V	121	30.5	14.4

Remarks:

1. Emission Level(dBuV/m) = Raw Value(dBuV) + Correction Factor(dB/m)
2. Correction Factor(dB/m) = Antenna Factor(dB/m) + Cable Factor(dB) – Pre-Amplifier Factor(dB)
3. Margin value = Emission Level – Limit value
4. The other emission levels were very low against the limit.
5. " * ": Fundamental frequency.
6. " # ": The radiated frequency is out of the restricted band.

RF Mode	TX 802.11a	Channel	CH 149 : 5745 MHz
Frequency Range	1GHz ~ 40GHz	Detector Function	Peak (PK) Average (AV)

Antenna Polarity & Test Distance : Horizontal at 3 m

No	Frequency (MHz)	Emission Level (dBuV/m)	Limit (dBuV/m)	Margin (dB)	Antenna Height (m)	Table Angle (Degree)	Raw Value (dBuV)	Correction Factor (dB/m)
1	#5645.10	60.2 PK	68.2	-8.0	1.76 H	79	55.7	4.5
2	*5745.00	119.2 PK			1.76 H	79	114.2	5.0
3	*5745.00	109.9 AV			1.76 H	79	104.9	5.0
4	#5930.61	54.2 PK	68.2	-14.0	1.76 H	79	49.1	5.1
5	11490.00	67.0 PK	74.0	-7.0	1.61 H	233	52.4	14.6
6	11490.00	53.4 AV	54.0	-0.6	1.61 H	233	38.8	14.6
7	#17235.00	57.3 PK	68.2	-10.9	1.63 H	342	39.3	18.0

Antenna Polarity & Test Distance : Vertical at 3 m

No	Frequency (MHz)	Emission Level (dBuV/m)	Limit (dBuV/m)	Margin (dB)	Antenna Height (m)	Table Angle (Degree)	Raw Value (dBuV)	Correction Factor (dB/m)
1	#5604.10	54.0 PK	68.2	-14.2	1.71 V	73	49.5	4.5
2	*5745.00	115.6 PK			1.71 V	73	110.6	5.0
3	*5745.00	105.7 AV			1.71 V	73	100.7	5.0
4	#5988.91	52.6 PK	68.2	-15.6	1.71 V	73	47.4	5.2
5	11490.00	63.8 PK	74.0	-10.2	1.99 V	223	49.2	14.6
6	11490.00	49.3 AV	54.0	-4.7	1.99 V	223	34.7	14.6
7	#17235.00	57.2 PK	68.2	-11.0	1.72 V	105	39.2	18.0

Remarks:

1. Emission Level(dBuV/m) = Raw Value(dBuV) + Correction Factor(dB/m)
2. Correction Factor(dB/m) = Antenna Factor(dB/m) + Cable Factor(dB) – Pre-Amplifier Factor(dB)
3. Margin value = Emission Level – Limit value
4. The other emission levels were very low against the limit.
5. " * ": Fundamental frequency.
6. " # ": The radiated frequency is out of the restricted band.

RF Mode	TX 802.11a	Channel	CH 157 : 5785 MHz
Frequency Range	1GHz ~ 40GHz	Detector Function	Peak (PK) Average (AV)

Antenna Polarity & Test Distance : Horizontal at 3 m

No	Frequency (MHz)	Emission Level (dBuV/m)	Limit (dBuV/m)	Margin (dB)	Antenna Height (m)	Table Angle (Degree)	Raw Value (dBuV)	Correction Factor (dB/m)
1	#5616.67	59.2 PK	68.2	-9.0	1.80 H	82	54.7	4.5
2	*5785.00	120.2 PK			1.80 H	82	115.1	5.1
3	*5785.00	110.8 AV			1.80 H	82	105.7	5.1
4	#5938.97	55.2 PK	68.2	-13.0	1.80 H	82	50.1	5.1
5	11570.00	68.9 PK	74.0	-5.1	1.67 H	235	54.3	14.6
6	11570.00	53.2 AV	54.0	-0.8	1.67 H	235	38.6	14.6
7	#17355.00	58.8 PK	68.2	-9.4	1.65 H	345	40.6	18.2

Antenna Polarity & Test Distance : Vertical at 3 m

No	Frequency (MHz)	Emission Level (dBuV/m)	Limit (dBuV/m)	Margin (dB)	Antenna Height (m)	Table Angle (Degree)	Raw Value (dBuV)	Correction Factor (dB/m)
1	#5642.68	54.3 PK	68.2	-13.9	1.75 V	110	49.8	4.5
2	*5785.00	115.9 PK			1.75 V	110	110.8	5.1
3	*5785.00	106.3 AV			1.75 V	110	101.2	5.1
4	#6024.83	52.5 PK	68.2	-15.7	1.75 V	110	47.3	5.2
5	11570.00	65.9 PK	74.0	-8.1	2.16 V	209	51.3	14.6
6	11570.00	50.7 AV	54.0	-3.3	2.16 V	209	36.1	14.6
7	#17355.00	58.2 PK	68.2	-10.0	1.76 V	117	40.0	18.2

Remarks:

1. Emission Level(dBuV/m) = Raw Value(dBuV) + Correction Factor(dB/m)
2. Correction Factor(dB/m) = Antenna Factor(dB/m) + Cable Factor(dB) – Pre-Amplifier Factor(dB)
3. Margin value = Emission Level – Limit value
4. The other emission levels were very low against the limit.
5. " * ": Fundamental frequency.
6. " # ": The radiated frequency is out of the restricted band.

RF Mode	TX 802.11a	Channel	CH 165 : 5825 MHz
Frequency Range	1GHz ~ 40GHz	Detector Function	Peak (PK) Average (AV)

Antenna Polarity & Test Distance : Horizontal at 3 m

No	Frequency (MHz)	Emission Level (dBuV/m)	Limit (dBuV/m)	Margin (dB)	Antenna Height (m)	Table Angle (Degree)	Raw Value (dBuV)	Correction Factor (dB/m)
1	#5645.93	57.4 PK	68.2	-10.8	1.83 H	79	52.9	4.5
2	*5825.00	119.5 PK			1.83 H	79	114.5	5.0
3	*5825.00	110.4 AV			1.83 H	79	105.4	5.0
4	#5931.75	55.5 PK	68.2	-12.7	1.83 H	79	50.4	5.1
5	11650.00	70.8 PK	74.0	-3.2	1.69 H	235	56.4	14.4
6	11650.00	53.3 AV	54.0	-0.7	1.69 H	235	38.9	14.4
7	#17475.00	58.5 PK	68.2	-9.7	1.61 H	341	39.7	18.8

Antenna Polarity & Test Distance : Vertical at 3 m

No	Frequency (MHz)	Emission Level (dBuV/m)	Limit (dBuV/m)	Margin (dB)	Antenna Height (m)	Table Angle (Degree)	Raw Value (dBuV)	Correction Factor (dB/m)
1	#5579.65	54.0 PK	68.2	-14.2	1.73 V	116	49.5	4.5
2	*5825.00	115.3 PK			1.73 V	116	110.3	5.0
3	*5825.00	105.7 AV			1.73 V	116	100.7	5.0
4	#5980.09	52.0 PK	68.2	-16.2	1.73 V	116	46.8	5.2
5	11650.00	65.8 PK	74.0	-8.2	2.10 V	224	51.4	14.4
6	11650.00	50.2 AV	54.0	-3.8	2.10 V	224	35.8	14.4
7	#17475.00	57.9 PK	68.2	-10.3	1.72 V	102	39.1	18.8

Remarks:

1. Emission Level(dBuV/m) = Raw Value(dBuV) + Correction Factor(dB/m)
2. Correction Factor(dB/m) = Antenna Factor(dB/m) + Cable Factor(dB) – Pre-Amplifier Factor(dB)
3. Margin value = Emission Level – Limit value
4. The other emission levels were very low against the limit.
5. " * ": Fundamental frequency.
6. " # ": The radiated frequency is out of the restricted band.

RF Mode	TX 802.11ax (HE20)	Channel	CH 36 : 5180 MHz
Frequency Range	1GHz ~ 40GHz	Detector Function	Peak (PK) Average (AV)

Antenna Polarity & Test Distance : Horizontal at 3 m

No	Frequency (MHz)	Emission Level (dBuV/m)	Limit (dBuV/m)	Margin (dB)	Antenna Height (m)	Table Angle (Degree)	Raw Value (dBuV)	Correction Factor (dB/m)
1	5150.00	67.9 PK	74.0	-6.1	1.65 H	39	63.2	4.7
2	5150.00	52.7 AV	54.0	-1.3	1.65 H	39	48.0	4.7
3	*5180.00	119.9 PK			1.65 H	39	115.3	4.6
4	*5180.00	108.6 AV			1.65 H	39	104.0	4.6
5	#10360.00	51.7 PK	68.2	-16.5	1.51 H	251	38.3	13.4
6	15540.00	47.6 PK	74.0	-26.4	1.42 H	182	33.1	14.5
7	15540.00	36.9 AV	54.0	-17.1	1.42 H	182	22.4	14.5

Antenna Polarity & Test Distance : Vertical at 3 m

No	Frequency (MHz)	Emission Level (dBuV/m)	Limit (dBuV/m)	Margin (dB)	Antenna Height (m)	Table Angle (Degree)	Raw Value (dBuV)	Correction Factor (dB/m)
1	5150.00	58.6 PK	74.0	-15.4	2.43 V	120	53.9	4.7
2	5150.00	47.8 AV	54.0	-6.2	2.43 V	120	43.1	4.7
3	*5180.00	113.3 PK			2.43 V	120	108.7	4.6
4	*5180.00	102.9 AV			2.43 V	120	98.3	4.6
5	#10360.00	47.7 PK	68.2	-20.5	2.06 V	216	34.3	13.4
6	15540.00	48.0 PK	74.0	-26.0	1.68 V	109	33.5	14.5
7	15540.00	37.0 AV	54.0	-17.0	1.68 V	109	22.5	14.5

Remarks:

1. Emission Level(dBuV/m) = Raw Value(dBuV) + Correction Factor(dB/m)
2. Correction Factor(dB/m) = Antenna Factor(dB/m) + Cable Factor(dB) – Pre-Amplifier Factor(dB)
3. Margin value = Emission Level – Limit value
4. The other emission levels were very low against the limit.
5. " * ": Fundamental frequency.
6. " # ": The radiated frequency is out of the restricted band.

RF Mode	TX 802.11ax (HE20)	Channel	CH 40 : 5200 MHz
Frequency Range	1GHz ~ 40GHz	Detector Function	Peak (PK) Average (AV)

Antenna Polarity & Test Distance : Horizontal at 3 m

No	Frequency (MHz)	Emission Level (dBuV/m)	Limit (dBuV/m)	Margin (dB)	Antenna Height (m)	Table Angle (Degree)	Raw Value (dBuV)	Correction Factor (dB/m)
1	5150.00	63.0 PK	74.0	-11.0	1.62 H	40	58.3	4.7
2	5150.00	53.0 AV	54.0	-1.0	1.62 H	40	48.3	4.7
3	*5200.00	124.4 PK			1.62 H	40	120.0	4.4
4	*5200.00	113.4 AV			1.62 H	40	109.0	4.4
5	#10400.00	56.6 PK	68.2	-11.6	1.60 H	256	43.0	13.6
6	15600.00	52.5 PK	74.0	-21.5	1.46 H	194	38.0	14.5
7	15600.00	41.1 AV	54.0	-12.9	1.46 H	194	26.6	14.5

Antenna Polarity & Test Distance : Vertical at 3 m

No	Frequency (MHz)	Emission Level (dBuV/m)	Limit (dBuV/m)	Margin (dB)	Antenna Height (m)	Table Angle (Degree)	Raw Value (dBuV)	Correction Factor (dB/m)
1	5150.00	58.8 PK	74.0	-15.2	2.41 V	118	54.1	4.7
2	5150.00	47.8 AV	54.0	-6.2	2.41 V	118	43.1	4.7
3	*5200.00	119.7 PK			2.41 V	118	115.3	4.4
4	*5200.00	107.8 AV			2.41 V	118	103.4	4.4
5	#10400.00	52.7 PK	68.2	-15.5	2.08 V	208	39.1	13.6
6	15600.00	53.6 PK	74.0	-20.4	1.72 V	116	39.1	14.5
7	15600.00	41.7 AV	54.0	-12.3	1.72 V	116	27.2	14.5

Remarks:

1. Emission Level(dBuV/m) = Raw Value(dBuV) + Correction Factor(dB/m)
2. Correction Factor(dB/m) = Antenna Factor(dB/m) + Cable Factor(dB) – Pre-Amplifier Factor(dB)
3. Margin value = Emission Level – Limit value
4. The other emission levels were very low against the limit.
5. " * ": Fundamental frequency.
6. " # ": The radiated frequency is out of the restricted band.

RF Mode	TX 802.11ax (HE20)	Channel	CH 48 : 5240 MHz
Frequency Range	1GHz ~ 40GHz	Detector Function	Peak (PK) Average (AV)

Antenna Polarity & Test Distance : Horizontal at 3 m

No	Frequency (MHz)	Emission Level (dBuV/m)	Limit (dBuV/m)	Margin (dB)	Antenna Height (m)	Table Angle (Degree)	Raw Value (dBuV)	Correction Factor (dB/m)
1	*5240.00	125.5 PK			1.63 H	38	121.1	4.4
2	*5240.00	114.0 AV			1.63 H	38	109.6	4.4
3	5359.90	55.4 PK	74.0	-18.6	1.63 H	38	51.0	4.4
4	5359.90	45.8 AV	54.0	-8.2	1.63 H	38	41.4	4.4
5	#10480.00	56.5 PK	68.2	-11.7	1.57 H	264	42.8	13.7
6	15720.00	52.9 PK	74.0	-21.1	1.47 H	195	38.5	14.4
7	15720.00	41.4 AV	54.0	-12.6	1.47 H	195	27.0	14.4

Antenna Polarity & Test Distance : Vertical at 3 m

No	Frequency (MHz)	Emission Level (dBuV/m)	Limit (dBuV/m)	Margin (dB)	Antenna Height (m)	Table Angle (Degree)	Raw Value (dBuV)	Correction Factor (dB/m)
1	*5240.00	120.2 PK			2.38 V	120	115.8	4.4
2	*5240.00	108.3 AV			2.38 V	120	103.9	4.4
3	5350.00	54.4 PK	74.0	-19.6	2.38 V	120	50.1	4.3
4	5350.00	44.1 AV	54.0	-9.9	2.38 V	120	39.8	4.3
5	#10480.00	53.0 PK	68.2	-15.2	2.12 V	222	39.3	13.7
6	15720.00	53.2 PK	74.0	-20.8	1.71 V	129	38.8	14.4
7	15720.00	41.5 AV	54.0	-12.5	1.71 V	129	27.1	14.4

Remarks:

1. Emission Level(dBuV/m) = Raw Value(dBuV) + Correction Factor(dB/m)
2. Correction Factor(dB/m) = Antenna Factor(dB/m) + Cable Factor(dB) – Pre-Amplifier Factor(dB)
3. Margin value = Emission Level – Limit value
4. The other emission levels were very low against the limit.
5. " * ": Fundamental frequency.
6. " # ": The radiated frequency is out of the restricted band.

RF Mode	TX 802.11ax (HE20)	Channel	CH 149 : 5745 MHz
Frequency Range	1GHz ~ 40GHz	Detector Function	Peak (PK) Average (AV)

Antenna Polarity & Test Distance : Horizontal at 3 m

No	Frequency (MHz)	Emission Level (dBuV/m)	Limit (dBuV/m)	Margin (dB)	Antenna Height (m)	Table Angle (Degree)	Raw Value (dBuV)	Correction Factor (dB/m)
1	#5649.30	58.8 PK	68.2	-9.4	1.72 H	61	54.3	4.5
2	*5745.00	123.2 PK			1.72 H	61	118.2	5.0
3	*5745.00	112.8 AV			1.72 H	61	107.8	5.0
4	#5944.04	53.9 PK	68.2	-14.3	1.72 H	61	48.8	5.1
5	11490.00	65.3 PK	74.0	-8.7	1.57 H	226	50.7	14.6
6	11490.00	52.7 AV	54.0	-1.3	1.57 H	226	38.1	14.6
7	#17235.00	57.8 PK	68.2	-10.4	1.58 H	333	39.8	18.0

Antenna Polarity & Test Distance : Vertical at 3 m

No	Frequency (MHz)	Emission Level (dBuV/m)	Limit (dBuV/m)	Margin (dB)	Antenna Height (m)	Table Angle (Degree)	Raw Value (dBuV)	Correction Factor (dB/m)
1	#5561.44	55.0 PK	68.2	-13.2	1.64 V	133	50.5	4.5
2	*5745.00	119.3 PK			1.64 V	133	114.3	5.0
3	*5745.00	106.5 AV			1.64 V	133	101.5	5.0
4	#5933.82	52.1 PK	68.2	-16.1	1.64 V	133	47.0	5.1
5	11490.00	66.3 PK	74.0	-7.7	2.12 V	217	51.7	14.6
6	11490.00	50.3 AV	54.0	-3.7	2.12 V	217	35.7	14.6
7	#17235.00	58.4 PK	68.2	-9.8	1.75 V	106	40.4	18.0

Remarks:

1. Emission Level(dBuV/m) = Raw Value(dBuV) + Correction Factor(dB/m)
2. Correction Factor(dB/m) = Antenna Factor(dB/m) + Cable Factor(dB) – Pre-Amplifier Factor(dB)
3. Margin value = Emission Level – Limit value
4. The other emission levels were very low against the limit.
5. " * ": Fundamental frequency.
6. " # ": The radiated frequency is out of the restricted band.

RF Mode	TX 802.11ax (HE20)	Channel	CH 157 : 5785 MHz
Frequency Range	1GHz ~ 40GHz	Detector Function	Peak (PK) Average (AV)

Antenna Polarity & Test Distance : Horizontal at 3 m

No	Frequency (MHz)	Emission Level (dBuV/m)	Limit (dBuV/m)	Margin (dB)	Antenna Height (m)	Table Angle (Degree)	Raw Value (dBuV)	Correction Factor (dB/m)
1	#5636.40	57.7 PK	68.2	-10.5	1.81 H	76	53.2	4.5
2	*5785.00	122.7 PK			1.81 H	76	117.6	5.1
3	*5785.00	112.3 AV			1.81 H	76	107.2	5.1
4	#5941.10	54.7 PK	68.2	-13.5	1.81 H	76	49.6	5.1
5	11570.00	66.0 PK	74.0	-8.0	1.64 H	232	51.4	14.6
6	11570.00	53.0 AV	54.0	-1.0	1.64 H	232	38.4	14.6
7	#17355.00	58.3 PK	68.2	-9.9	1.58 H	329	40.1	18.2

Antenna Polarity & Test Distance : Vertical at 3 m

No	Frequency (MHz)	Emission Level (dBuV/m)	Limit (dBuV/m)	Margin (dB)	Antenna Height (m)	Table Angle (Degree)	Raw Value (dBuV)	Correction Factor (dB/m)
1	#5637.47	53.6 PK	68.2	-14.6	1.74 V	114	49.1	4.5
2	*5785.00	118.2 PK			1.74 V	114	113.1	5.1
3	*5785.00	105.8 AV			1.74 V	114	100.7	5.1
4	#5962.37	52.4 PK	68.2	-15.8	1.74 V	114	47.2	5.2
5	11570.00	65.9 PK	74.0	-8.1	2.10 V	214	51.3	14.6
6	11570.00	50.1 AV	54.0	-3.9	2.10 V	214	35.5	14.6
7	#17355.00	58.4 PK	68.2	-9.8	1.78 V	92	40.2	18.2

Remarks:

1. Emission Level(dBuV/m) = Raw Value(dBuV) + Correction Factor(dB/m)
2. Correction Factor(dB/m) = Antenna Factor(dB/m) + Cable Factor(dB) – Pre-Amplifier Factor(dB)
3. Margin value = Emission Level – Limit value
4. The other emission levels were very low against the limit.
5. " * ": Fundamental frequency.
6. " # ": The radiated frequency is out of the restricted band.

RF Mode	TX 802.11ax (HE20)	Channel	CH 165 : 5825 MHz
Frequency Range	1GHz ~ 40GHz	Detector Function	Peak (PK) Average (AV)

Antenna Polarity & Test Distance : Horizontal at 3 m

No	Frequency (MHz)	Emission Level (dBuV/m)	Limit (dBuV/m)	Margin (dB)	Antenna Height (m)	Table Angle (Degree)	Raw Value (dBuV)	Correction Factor (dB/m)
1	#5581.35	57.7 PK	68.2	-10.5	1.79 H	70	53.2	4.5
2	*5825.00	122.2 PK			1.79 H	70	117.2	5.0
3	*5825.00	111.5 AV			1.79 H	70	106.5	5.0
4	#5993.95	56.0 PK	68.2	-12.2	1.79 H	70	50.8	5.2
5	11650.00	65.6 PK	74.0	-8.4	1.64 H	228	51.2	14.4
6	11650.00	52.9 AV	54.0	-1.1	1.64 H	228	38.5	14.4
7	#17475.00	58.7 PK	68.2	-9.5	1.57 H	327	39.9	18.8

Antenna Polarity & Test Distance : Vertical at 3 m

No	Frequency (MHz)	Emission Level (dBuV/m)	Limit (dBuV/m)	Margin (dB)	Antenna Height (m)	Table Angle (Degree)	Raw Value (dBuV)	Correction Factor (dB/m)
1	#5639.62	53.9 PK	68.2	-14.3	1.64 V	110	49.4	4.5
2	*5825.00	117.1 PK			1.64 V	110	112.1	5.0
3	*5825.00	105.5 AV			1.64 V	110	100.5	5.0
4	#5970.72	53.1 PK	68.2	-15.1	1.64 V	110	47.9	5.2
5	11650.00	65.7 PK	74.0	-8.3	2.10 V	211	51.3	14.4
6	11650.00	49.7 AV	54.0	-4.3	2.10 V	211	35.3	14.4
7	#17475.00	58.4 PK	68.2	-9.8	1.77 V	78	39.6	18.8

Remarks:

1. Emission Level(dBuV/m) = Raw Value(dBuV) + Correction Factor(dB/m)
2. Correction Factor(dB/m) = Antenna Factor(dB/m) + Cable Factor(dB) – Pre-Amplifier Factor(dB)
3. Margin value = Emission Level – Limit value
4. The other emission levels were very low against the limit.
5. " * ": Fundamental frequency.
6. " # ": The radiated frequency is out of the restricted band.

RF Mode	TX 802.11ax (HE40)	Channel	CH 38 : 5190 MHz
Frequency Range	1GHz ~ 40GHz	Detector Function	Peak (PK) Average (AV)

Antenna Polarity & Test Distance : Horizontal at 3 m

No	Frequency (MHz)	Emission Level (dBuV/m)	Limit (dBuV/m)	Margin (dB)	Antenna Height (m)	Table Angle (Degree)	Raw Value (dBuV)	Correction Factor (dB/m)
1	5150.00	65.4 PK	74.0	-8.6	1.76 H	33	60.7	4.7
2	5150.00	53.4 AV	54.0	-0.6	1.76 H	33	48.7	4.7
3	*5190.00	113.7 PK			1.76 H	33	109.2	4.5
4	*5190.00	102.1 AV			1.76 H	33	97.6	4.5
5	#10380.00	47.3 PK	68.2	-20.9	1.56 H	244	33.9	13.4
6	15570.00	47.4 PK	74.0	-26.6	1.46 H	187	32.8	14.6
7	15570.00	36.5 AV	54.0	-17.5	1.46 H	187	21.9	14.6

Antenna Polarity & Test Distance : Vertical at 3 m

No	Frequency (MHz)	Emission Level (dBuV/m)	Limit (dBuV/m)	Margin (dB)	Antenna Height (m)	Table Angle (Degree)	Raw Value (dBuV)	Correction Factor (dB/m)
1	5150.00	57.9 PK	74.0	-16.1	2.35 V	117	53.2	4.7
2	5150.00	48.7 AV	54.0	-5.3	2.35 V	117	44.0	4.7
3	*5190.00	108.2 PK			2.35 V	117	103.7	4.5
4	*5190.00	96.7 AV			2.35 V	117	92.2	4.5
5	#10380.00	47.1 PK	68.2	-21.1	2.03 V	224	33.7	13.4
6	15570.00	47.6 PK	74.0	-26.4	1.62 V	103	33.0	14.6
7	15570.00	36.6 AV	54.0	-17.4	1.62 V	103	22.0	14.6

Remarks:

1. Emission Level(dBuV/m) = Raw Value(dBuV) + Correction Factor(dB/m)
2. Correction Factor(dB/m) = Antenna Factor(dB/m) + Cable Factor(dB) – Pre-Amplifier Factor(dB)
3. Margin value = Emission Level – Limit value
4. The other emission levels were very low against the limit.
5. " * ": Fundamental frequency.
6. " # ": The radiated frequency is out of the restricted band.

RF Mode	TX 802.11ax (HE40)	Channel	CH 46 : 5230 MHz
Frequency Range	1GHz ~ 40GHz	Detector Function	Peak (PK) Average (AV)

Antenna Polarity & Test Distance : Horizontal at 3 m

No	Frequency (MHz)	Emission Level (dBuV/m)	Limit (dBuV/m)	Margin (dB)	Antenna Height (m)	Table Angle (Degree)	Raw Value (dBuV)	Correction Factor (dB/m)
1	5150.00	67.3 PK	74.0	-6.7	1.82 H	42	62.6	4.7
2	5150.00	53.0 AV	54.0	-1.0	1.82 H	42	48.3	4.7
3	*5230.00	118.4 PK			1.82 H	42	114.0	4.4
4	*5230.00	108.6 AV			1.82 H	42	104.2	4.4
5	5350.00	56.0 PK	74.0	-18.0	1.82 H	42	51.7	4.3
6	5350.00	46.9 AV	54.0	-7.1	1.82 H	42	42.6	4.3
7	#10460.00	52.1 PK	68.2	-16.1	1.47 H	255	38.5	13.6
8	15690.00	47.7 PK	74.0	-26.3	1.45 H	195	33.2	14.5
9	15690.00	36.7 AV	54.0	-17.3	1.45 H	195	22.2	14.5

Antenna Polarity & Test Distance : Vertical at 3 m

No	Frequency (MHz)	Emission Level (dBuV/m)	Limit (dBuV/m)	Margin (dB)	Antenna Height (m)	Table Angle (Degree)	Raw Value (dBuV)	Correction Factor (dB/m)
1	5150.00	58.4 PK	74.0	-15.6	2.49 V	122	53.7	4.7
2	5150.00	47.3 AV	54.0	-6.7	2.49 V	122	42.6	4.7
3	*5230.00	114.8 PK			2.49 V	122	110.4	4.4
4	*5230.00	104.4 AV			2.49 V	122	100.0	4.4
5	#10460.00	47.6 PK	68.2	-20.6	2.00 V	229	34.0	13.6
6	15690.00	48.3 PK	74.0	-25.7	1.73 V	117	33.8	14.5
7	15690.00	37.4 AV	54.0	-16.6	1.73 V	117	22.9	14.5

Remarks:

1. Emission Level(dBuV/m) = Raw Value(dBuV) + Correction Factor(dB/m)
2. Correction Factor(dB/m) = Antenna Factor(dB/m) + Cable Factor(dB) – Pre-Amplifier Factor(dB)
3. Margin value = Emission Level – Limit value
4. The other emission levels were very low against the limit.
5. " * ": Fundamental frequency.
6. " # ": The radiated frequency is out of the restricted band.

RF Mode	TX 802.11ax (HE40)	Channel	CH 151 : 5755 MHz
Frequency Range	1GHz ~ 40GHz	Detector Function	Peak (PK) Average (AV)

Antenna Polarity & Test Distance : Horizontal at 3 m

No	Frequency (MHz)	Emission Level (dBuV/m)	Limit (dBuV/m)	Margin (dB)	Antenna Height (m)	Table Angle (Degree)	Raw Value (dBuV)	Correction Factor (dB/m)
1	#5648.86	67.5 PK	68.2	-0.7	1.80 H	80	63.0	4.5
2	*5755.00	121.3 PK			1.80 H	80	116.3	5.0
3	*5755.00	109.3 AV			1.80 H	80	104.3	5.0
4	#5969.44	55.2 PK	68.2	-13.0	1.80 H	80	50.0	5.2
5	11510.00	64.6 PK	74.0	-9.4	1.60 H	225	50.0	14.6
6	11510.00	53.4 AV	54.0	-0.6	1.60 H	225	38.8	14.6
7	#17265.00	56.6 PK	68.2	-11.6	1.57 H	357	38.7	17.9

Antenna Polarity & Test Distance : Vertical at 3 m

No	Frequency (MHz)	Emission Level (dBuV/m)	Limit (dBuV/m)	Margin (dB)	Antenna Height (m)	Table Angle (Degree)	Raw Value (dBuV)	Correction Factor (dB/m)
1	#5644.39	56.1 PK	68.2	-12.1	1.63 V	71	51.6	4.5
2	*5755.00	114.9 PK			1.63 V	71	109.9	5.0
3	*5755.00	104.2 AV			1.63 V	71	99.2	5.0
4	#6001.20	52.0 PK	68.2	-16.2	1.63 V	71	46.8	5.2
5	11510.00	62.4 PK	74.0	-11.6	2.08 V	213	47.8	14.6
6	11510.00	49.8 AV	54.0	-4.2	2.08 V	213	35.2	14.6
7	#17265.00	57.6 PK	68.2	-10.6	1.70 V	86	39.7	17.9

Remarks:

1. Emission Level(dBuV/m) = Raw Value(dBuV) + Correction Factor(dB/m)
2. Correction Factor(dB/m) = Antenna Factor(dB/m) + Cable Factor(dB) – Pre-Amplifier Factor(dB)
3. Margin value = Emission Level – Limit value
4. The other emission levels were very low against the limit.
5. " * ": Fundamental frequency.
6. " # ": The radiated frequency is out of the restricted band.

RF Mode	TX 802.11ax (HE40)	Channel	CH 159 : 5795 MHz
Frequency Range	1GHz ~ 40GHz	Detector Function	Peak (PK) Average (AV)

Antenna Polarity & Test Distance : Horizontal at 3 m

No	Frequency (MHz)	Emission Level (dBuV/m)	Limit (dBuV/m)	Margin (dB)	Antenna Height (m)	Table Angle (Degree)	Raw Value (dBuV)	Correction Factor (dB/m)
1	#5648.61	59.0 PK	68.2	-9.2	1.71 H	77	54.5	4.5
2	*5795.00	120.5 PK			1.71 H	77	115.4	5.1
3	*5795.00	118.9 AV			1.71 H	77	113.8	5.1
4	#5929.07	55.6 PK	68.2	-12.6	1.71 H	77	50.5	5.1
5	11590.00	64.9 PK	74.0	-9.1	1.65 H	227	50.3	14.6
6	11590.00	53.1 AV	54.0	-0.9	1.65 H	227	38.5	14.6
7	#17385.00	56.7 PK	68.2	-11.5	1.60 H	342	38.4	18.3

Antenna Polarity & Test Distance : Vertical at 3 m

No	Frequency (MHz)	Emission Level (dBuV/m)	Limit (dBuV/m)	Margin (dB)	Antenna Height (m)	Table Angle (Degree)	Raw Value (dBuV)	Correction Factor (dB/m)
1	#5581.59	53.5 PK	68.2	-14.7	1.60 V	137	49.0	4.5
2	*5795.00	114.4 PK			1.60 V	137	109.3	5.1
3	*5795.00	103.7 AV			1.60 V	137	98.6	5.1
4	#5936.77	53.8 PK	68.2	-14.4	1.60 V	137	48.7	5.1
5	11590.00	61.8 PK	74.0	-12.2	2.07 V	208	47.2	14.6
6	11590.00	49.4 AV	54.0	-4.6	2.07 V	208	34.8	14.6
7	#17385.00	57.2 PK	68.2	-11.0	1.74 V	84	38.9	18.3

Remarks:

1. Emission Level(dBuV/m) = Raw Value(dBuV) + Correction Factor(dB/m)
2. Correction Factor(dB/m) = Antenna Factor(dB/m) + Cable Factor(dB) – Pre-Amplifier Factor(dB)
3. Margin value = Emission Level – Limit value
4. The other emission levels were very low against the limit.
5. " * ": Fundamental frequency.
6. " # ": The radiated frequency is out of the restricted band.

RF Mode	TX 802.11ax (HE80)	Channel	CH 42 : 5210 MHz
Frequency Range	1GHz ~ 40GHz	Detector Function	Peak (PK) Average (AV)

Antenna Polarity & Test Distance : Horizontal at 3 m

No	Frequency (MHz)	Emission Level (dBuV/m)	Limit (dBuV/m)	Margin (dB)	Antenna Height (m)	Table Angle (Degree)	Raw Value (dBuV)	Correction Factor (dB/m)
1	5149.70	63.6 PK	74.0	-10.4	1.70 H	36	58.8	4.8
2	5149.70	52.9 AV	54.0	-1.1	1.70 H	36	48.1	4.8
3	*5210.00	107.1 PK			1.70 H	36	102.7	4.4
4	*5210.00	96.9 AV			1.70 H	36	92.5	4.4
5	5357.20	52.2 PK	74.0	-21.8	1.70 H	36	47.8	4.4
6	5357.20	39.9 AV	54.0	-14.1	1.70 H	36	35.5	4.4
7	#10420.00	46.2 PK	68.2	-22.0	1.59 H	230	32.7	13.5
8	15630.00	47.7 PK	74.0	-26.3	1.51 H	199	33.1	14.6
9	15630.00	37.0 AV	54.0	-17.0	1.51 H	199	22.4	14.6

Antenna Polarity & Test Distance : Vertical at 3 m

No	Frequency (MHz)	Emission Level (dBuV/m)	Limit (dBuV/m)	Margin (dB)	Antenna Height (m)	Table Angle (Degree)	Raw Value (dBuV)	Correction Factor (dB/m)
1	5148.62	56.1 PK	74.0	-17.9	2.51 V	152	51.3	4.8
2	5148.62	44.7 AV	54.0	-9.3	2.51 V	152	39.9	4.8
3	*5210.00	101.8 PK			2.51 V	152	97.4	4.4
4	*5210.00	90.8 AV			2.51 V	152	86.4	4.4
5	#10420.00	46.6 PK	68.2	-21.6	2.08 V	216	33.1	13.5
6	15630.00	48.1 PK	74.0	-25.9	1.63 V	90	33.5	14.6
7	15630.00	36.9 AV	54.0	-17.1	1.63 V	90	22.3	14.6

Remarks:

1. Emission Level(dBuV/m) = Raw Value(dBuV) + Correction Factor(dB/m)
2. Correction Factor(dB/m) = Antenna Factor(dB/m) + Cable Factor(dB) – Pre-Amplifier Factor(dB)
3. Margin value = Emission Level – Limit value
4. The other emission levels were very low against the limit.
5. " * ": Fundamental frequency.
6. " # ": The radiated frequency is out of the restricted band.

RF Mode	TX 802.11ax (HE80)	Channel	CH 155 : 5775 MHz
Frequency Range	1GHz ~ 40GHz	Detector Function	Peak (PK) Average (AV)

Antenna Polarity & Test Distance : Horizontal at 3 m

No	Frequency (MHz)	Emission Level (dBuV/m)	Limit (dBuV/m)	Margin (dB)	Antenna Height (m)	Table Angle (Degree)	Raw Value (dBuV)	Correction Factor (dB/m)
1	#5649.14	66.9 PK	68.2	-1.3	1.80 H	77	62.4	4.5
2	*5775.00	116.9 PK			1.80 H	77	111.8	5.1
3	*5775.00	104.5 AV			1.80 H	77	99.4	5.1
4	#5941.73	61.9 PK	68.2	-6.3	1.80 H	77	56.8	5.1
5	11550.00	60.6 PK	74.0	-13.4	1.66 H	212	46.0	14.6
6	11550.00	49.7 AV	54.0	-4.3	1.66 H	212	35.1	14.6
7	#17325.00	52.9 PK	68.2	-15.3	1.65 H	351	34.8	18.1

Antenna Polarity & Test Distance : Vertical at 3 m

No	Frequency (MHz)	Emission Level (dBuV/m)	Limit (dBuV/m)	Margin (dB)	Antenna Height (m)	Table Angle (Degree)	Raw Value (dBuV)	Correction Factor (dB/m)
1	#5630.52	59.2 PK	68.2	-9.0	1.53 V	142	54.7	4.5
2	*5775.00	110.4 PK			1.53 V	142	105.3	5.1
3	*5775.00	98.6 AV			1.53 V	142	93.5	5.1
4	#5938.70	55.2 PK	68.2	-13.0	1.53 V	142	50.1	5.1
5	11550.00	59.3 PK	74.0	-14.7	2.08 V	198	44.7	14.6
6	11550.00	47.4 AV	54.0	-6.6	2.08 V	198	32.8	14.6
7	#17325.00	53.0 PK	68.2	-15.2	1.65 V	91	34.9	18.1

Remarks:

1. Emission Level(dBuV/m) = Raw Value(dBuV) + Correction Factor(dB/m)
2. Correction Factor(dB/m) = Antenna Factor(dB/m) + Cable Factor(dB) – Pre-Amplifier Factor(dB)
3. Margin value = Emission Level – Limit value
4. The other emission levels were very low against the limit.
5. " * ": Fundamental frequency.
6. " # ": The radiated frequency is out of the restricted band.

Below 1GHz Data:

RF Mode	TX 802.11a	Channel	CH 48 : 5240 MHz
Frequency Range	9kHz ~ 1GHz	Detector Function	Quasi-Peak (QP)

Antenna Polarity & Test Distance : Horizontal at 3 m								
No	Frequency (MHz)	Emission Level (dBuV/m)	Limit (dBuV/m)	Margin (dB)	Antenna Height (m)	Table Angle (Degree)	Raw Value (dBuV)	Correction Factor (dB/m)
1	30.36	23.5 QP	40.0	-16.5	1.50 H	53	32.9	-9.4
2	72.68	20.1 QP	40.0	-19.9	3.00 H	285	31.3	-11.2
3	166.43	25.8 QP	43.5	-17.7	1.50 H	260	33.8	-8.0
4	322.33	27.7 QP	46.0	-18.3	1.00 H	228	33.3	-5.6
5	463.47	28.2 QP	46.0	-17.8	2.00 H	37	30.0	-1.8
6	535.76	29.8 QP	46.0	-16.2	1.50 H	238	30.2	-0.4

Remarks:

1. Emission Level(dBuV/m) = Raw Value(dBuV) + Correction Factor(dB/m)
2. Correction Factor(dB/m) = Antenna Factor(dB/m) + Cable Factor(dB) – Pre-Amplifier Factor(dB)
3. Margin value = Emission Level – Limit value
4. The other emission levels were very low against the limit of frequency range 30MHz~1000MHz.
5. The emission levels were very low against the limit of frequency range 9kHz~30MHz: the amplitude of spurious emissions attenuated more than 20 dB below the permissible value to be report.

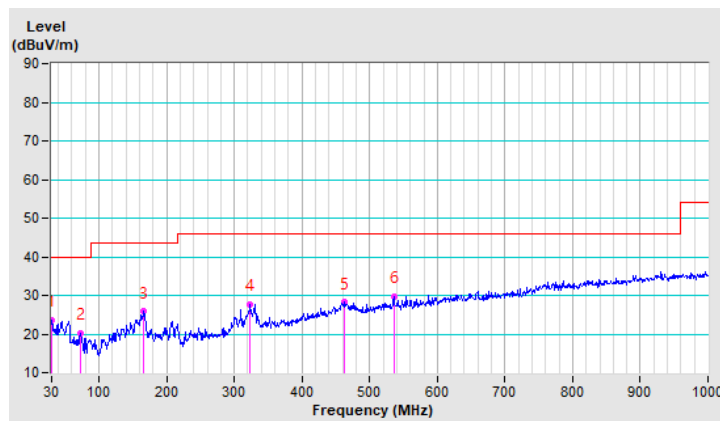

RF Mode	TX 802.11a	Channel	CH 48 : 5240 MHz
Frequency Range	9kHz ~ 1GHz	Detector Function	Quasi-Peak (QP)

Antenna Polarity & Test Distance : Vertical at 3 m

No	Frequency (MHz)	Emission Level (dBuV/m)	Limit (dBuV/m)	Margin (dB)	Antenna Height (m)	Table Angle (Degree)	Raw Value (dBuV)	Correction Factor (dB/m)
1	30.85	23.6 QP	40.0	-16.4	3.00 V	360	33.1	-9.5
2	46.01	33.1 QP	40.0	-6.9	3.00 V	360	41.2	-8.1
3	88.52	29.9 QP	43.5	-13.6	3.00 V	360	43.7	-13.8
4	214.74	25.0 QP	43.5	-18.5	1.00 V	64	35.6	-10.6
5	301.87	25.0 QP	46.0	-21.0	1.50 V	360	31.5	-6.5
6	468.90	29.9 QP	46.0	-16.1	1.00 V	86	31.6	-1.7

Remarks:

1. Emission Level(dBuV/m) = Raw Value(dBuV) + Correction Factor(dB/m)
2. Correction Factor(dB/m) = Antenna Factor(dB/m) + Cable Factor(dB) – Pre-Amplifier Factor(dB)
3. Margin value = Emission Level – Limit value
4. The other emission levels were very low against the limit of frequency range 30MHz~1000MHz.
5. The emission levels were very low against the limit of frequency range 9kHz~30MHz: the amplitude of spurious emissions attenuated more than 20 dB below the permissible value to be report.

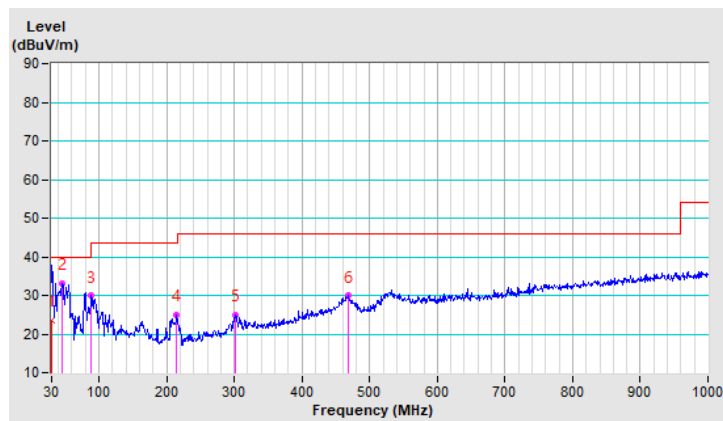

4.2 Conducted Emission Measurement

4.2.1 Limits of Conducted Emission Measurement

Frequency (MHz)	Conducted Limit (dBuV)	
	Quasi-peak	Average
0.15 - 0.5	66 - 56	56 - 46
0.50 - 5.0	56	46
5.0 - 30.0	60	50

Note: 1. The lower limit shall apply at the transition frequencies.

2. The limit decreases in line with the logarithm of the frequency in the range of 0.15 to 0.50MHz.

4.2.2 Test Instruments

DESCRIPTION & MANUFACTURER	MODEL NO.	SERIAL NO.	CALIBRATED DATE	CALIBRATED UNTIL
Test Receiver R&S	ESCS 30	847124/029	Oct. 20, 2020	Oct. 19, 2021
Line-Impedance Stabilization Network (for EUT) R&S	ESH3-Z5	848773/004	Oct. 27, 2020	Oct. 26, 2021
Line-Impedance Stabilization Network (for Peripheral) R&S	ESH3-Z5	835239/001	Mar. 26, 2021	Mar. 25, 2022
50 ohms Terminator	50	3	Oct. 26, 2020	Oct. 25, 2021
RF Cable	5D-FB	COCCAB-001	Sep. 26, 2020	Sep. 25, 2021
Fixed attenuator EMCI	STI02-2200-10	005	Aug. 29, 2020	Aug. 28, 2021
Software BVADT	BVADT_Cond_V7.3.7.4	NA	NA	NA

Note:

1. The calibration interval of the above test instruments are 12 months and the calibrations are traceable to NML/ROC and NIST/USA.
2. The test was performed in Conduction 1.
3. Tested Date: July 31, 2021

4.2.3 Test Procedure

- The EUT was placed 0.4 meters from the conducting wall of the shielded room with EUT being connected to the power mains through a line impedance stabilization network (LISN). Other support units were connected to the power mains through another LISN. The two LISNs provide 50 ohm/ 50uH of coupling impedance for the measuring instrument.
- Both lines of the power mains connected to the EUT were checked for maximum conducted interference.
- The frequency range from 150kHz to 30MHz was searched. Emission levels under (Limit - 20dB) was not recorded.

Note: All modes of operation were investigated and the worst-case emissions are reported.

4.2.4 Deviation from Test Standard

No deviation.

4.2.5 Test Setup

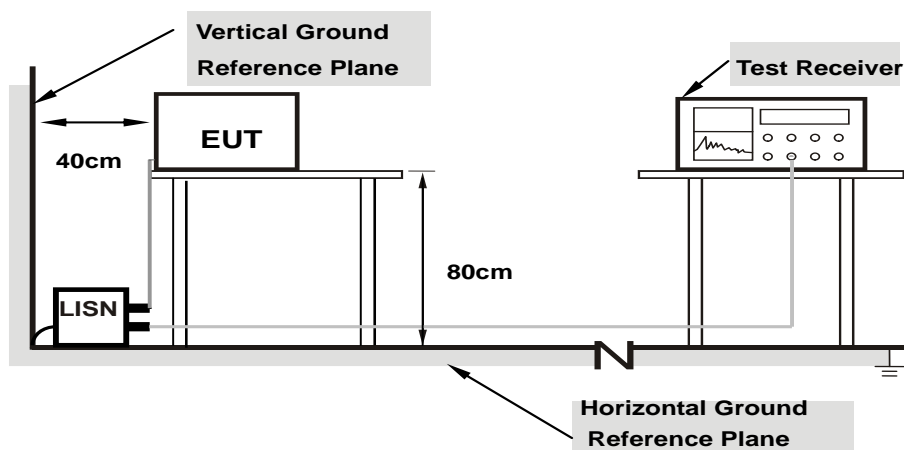

Note: 1.Support units were connected to second LISN.

For the actual test configuration, please refer to the attached file (Test Setup Photo).

4.2.6 EUT Operating Condition

Same as 4.1.6.

4.2.7 Test Results

RF Mode	TX 802.11a	Channel	CH 48 : 5240 MHz
Frequency Range	150kHz ~ 30MHz	Detector Function & Resolution Bandwidth	Quasi-Peak (QP) / Average (AV), 9kHz

Phase Of Power : Line (L)										
No	Frequency (MHz)	Correction Factor (dB)	Reading Value (dBuV)		Emission Level (dBuV)		Limit (dBuV)		Margin (dB)	
			Q.P.	AV.	Q.P.	AV.	Q.P.	AV.	Q.P.	AV.
1	0.15391	9.97	32.35	15.70	42.32	25.67	65.79	55.79	-23.47	-30.12
2	0.24766	10.01	23.63	10.39	33.64	20.40	61.84	51.84	-28.20	-31.44
3	0.45078	10.03	29.81	22.07	39.84	32.10	56.86	46.86	-17.02	-14.76
4	0.88828	10.06	16.88	8.53	26.94	18.59	56.00	46.00	-29.06	-27.41
5	1.74219	10.11	11.72	1.44	21.83	11.55	56.00	46.00	-34.17	-34.45
6	3.45703	10.22	14.21	3.72	24.43	13.94	56.00	46.00	-31.57	-32.06

Remarks:

1. Q.P. and AV. are abbreviations of quasi-peak and average individually.
2. The emission levels of other frequencies were very low against the limit.
3. Margin value = Emission level – Limit value
4. Correction factor = Insertion loss + Cable loss
5. Emission Level = Correction Factor + Reading Value

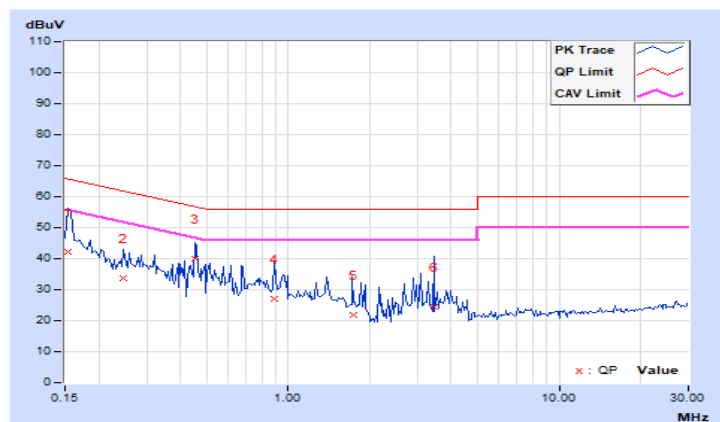

RF Mode	TX 802.11a	Channel	CH 48 : 5240 MHz
Frequency Range	150kHz ~ 30MHz	Detector Function & Resolution Bandwidth	Quasi-Peak (QP) / Average (AV), 9kHz

Phase Of Power : Neutral (N)										
No	Frequency (MHz)	Correction Factor (dB)	Reading Value (dBuV)		Emission Level (dBuV)		Limit (dBuV)		Margin (dB)	
			Q.P.	AV.	Q.P.	AV.	Q.P.	AV.	Q.P.	AV.
1	0.15781	9.96	32.45	15.72	42.41	25.68	65.58	55.58	-23.17	-29.90
2	0.22812	10.00	26.02	8.68	36.02	18.68	62.52	52.52	-26.50	-33.84
3	0.45859	10.02	26.76	21.85	36.78	31.87	56.72	46.72	-19.94	-14.85
4	0.75547	10.04	7.86	-0.17	17.90	9.87	56.00	46.00	-38.10	-36.13
5	3.41406	10.21	10.14	-0.55	20.35	9.66	56.00	46.00	-35.65	-36.34
6	4.00000	10.24	11.97	3.52	22.21	13.76	56.00	46.00	-33.79	-32.24

Remarks:

1. Q.P. and AV. are abbreviations of quasi-peak and average individually.
2. The emission levels of other frequencies were very low against the limit.
3. Margin value = Emission level – Limit value
4. Correction factor = Insertion loss + Cable loss
5. Emission Level = Correction Factor + Reading Value

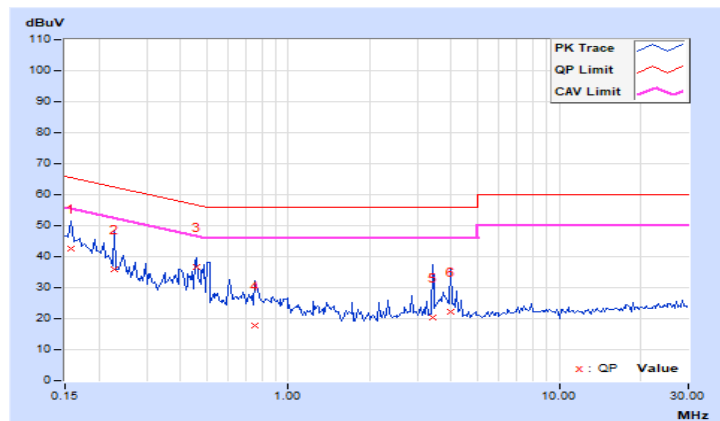

4.3 Transmit Power Measurement

4.3.1 Limits of Transmit Power Measurement

Operation Band	EUT Category		Limit
U-NII-1		Outdoor Access Point	1 Watt (30 dBm) (Max. e.i.r.p \leq 125mW(21 dBm) at any elevation angle above 30 degrees as measured from the horizon)
		Fixed point-to-point Access Point	1 Watt (30 dBm)
	√	Indoor Access Point	1 Watt (30 dBm)
		Client device	250mW (24 dBm)
U-NII-2A			250mW (24 dBm) or 11 dBm+10 log B*
U-NII-2C			250mW (24 dBm) or 11 dBm+10 log B*
U-NII-3		√	1 Watt (30 dBm)

*B is the 26 dB emission bandwidth in megahertz

Per KDB 662911 Method of conducted output power measurement on IEEE 802.11 devices,

Array Gain = 0 dB (i.e., no array gain) for $N_{ANT} \leq 4$;

Array Gain = 0 dB (i.e., no array gain) for channel widths ≥ 40 MHz for any N_{ANT} ;

Array Gain = $5 \log(N_{ANT}/N_{SS})$ dB or 3 dB, whichever is less for 20-MHz channel widths with $N_{ANT} \geq 5$.

For power measurements on all other devices: Array Gain = $10 \log(N_{ANT}/N_{SS})$ dB.

4.3.2 Test Setup

FOR POWER OUTPUT MEASUREMENT

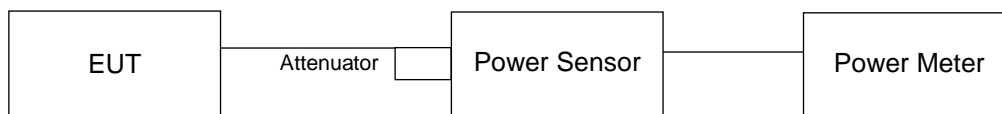

FOR 26dB OCCUPIED BANDWIDTH

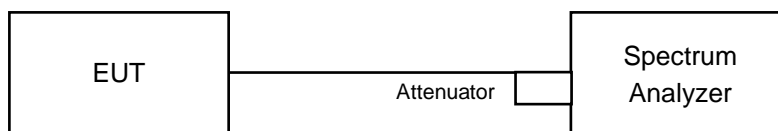

4.3.3 Test Instruments

Refer to section 4.1.2 to get information of above instrument.

4.3.4 Test Procedure

FOR POWER OUTPUT MEASUREMENT

Method PM is used to perform output power measurement, trigger and gating function of wide band power meter is enabled to measure max output power of TX on burst. Duty factor is not added to measured value.

FOR 26dB OCCUPIED BANDWIDTH

1. Set RBW = approximately 1% of the emission bandwidth.
2. Set the VBW > RBW.
3. Detector = Peak.
4. Trace mode = max hold.
5. Measure the maximum width of the emission that is 26 dB down from the peak of the emission. Compare this with the RBW setting of the analyzer. Readjust RBW and repeat measurement as needed until the RBW/EBW ratio is approximately 1%.

4.3.5 Deviation from Test Standard

No deviation.

4.3.6 EUT Operating Condition

The software provided by client to enable the EUT under transmission condition continuously at lowest, middle and highest channel frequencies individually.

4.3.7 Test Results

CDD Mode

802.11a

Chan.	Chan. Freq. (MHz)	Average Power (dBm)		Total Power (mW)	Total Power (dBm)	Limit (dBm)	Pass / Fail
		Chain 0	Chain 1				
36	5180	22.85	23.39	411.025	26.14	30	Pass
40	5200	25.45	26.52	799.497	29.03	30	Pass
48	5240	26.39	26.71	904.325	29.56	30	Pass
149	5745	24.87	24.72	603.385	27.81	30	Pass
157	5785	24.86	24.91	615.938	27.90	30	Pass
165	5825	25.04	24.53	602.946	27.80	30	Pass

802.11ac (VHT20)

Chan.	Chan. Freq. (MHz)	Average Power (dBm)		Total Power (mW)	Total Power (dBm)	Limit (dBm)	Pass / Fail
		Chain 0	Chain 1				
36	5180	21.52	21.89	296.431	24.72	30	Pass
40	5200	25.14	25.64	693.025	28.41	30	Pass
48	5240	25.77	25.51	733.204	28.65	30	Pass
149	5745	24.69	24.56	580.201	27.64	30	Pass
157	5785	24.28	24.36	540.815	27.33	30	Pass
165	5825	24.38	24.42	550.852	27.41	30	Pass

802.11ac (VHT40)

Chan.	Chan. Freq. (MHz)	Average Power (dBm)		Total Power (mW)	Total Power (dBm)	Limit (dBm)	Pass / Fail
		Chain 0	Chain 1				
38	5190	17.82	17.91	122.336	20.88	30	Pass
46	5230	24.80	24.45	580.607	27.64	30	Pass
151	5755	25.20	25.15	658.472	28.19	30	Pass
159	5795	24.36	24.44	550.869	27.41	30	Pass

802.11ac (VHT80)

Chan.	Chan. Freq. (MHz)	Average Power (dBm)		Total Power (mW)	Total Power (dBm)	Limit (dBm)	Pass / Fail
		Chain 0	Chain 1				
42	5210	14.37	15.42	62.186	17.94	30	Pass
155	5775	22.85	23.10	396.926	25.99	30	Pass

802.11ax (HE20)

Chan.	Chan. Freq. (MHz)	Average Power (dBm)		Total Power (mW)	Total Power (dBm)	Limit (dBm)	Pass / Fail
		Chain 0	Chain 1				
36	5180	21.55	21.99	301.014	24.79	30	Pass
40	5200	25.31	25.79	718.94	28.57	30	Pass
48	5240	25.85	25.64	751.029	28.76	30	Pass
149	5745	24.73	24.71	592.968	27.73	30	Pass
157	5785	24.39	24.47	554.688	27.44	30	Pass
165	5825	24.50	24.63	572.241	27.58	30	Pass

802.11ax (HE40)

Chan.	Chan. Freq. (MHz)	Average Power (dBm)		Total Power (mW)	Total Power (dBm)	Limit (dBm)	Pass / Fail
		Chain 0	Chain 1				
38	5190	17.92	18.25	128.778	21.10	30	Pass
46	5230	24.98	24.61	603.843	27.81	30	Pass
151	5755	25.30	25.42	687.181	28.37	30	Pass
159	5795	24.43	24.55	562.434	27.50	30	Pass

802.11ax (HE80)

Chan.	Chan. Freq. (MHz)	Average Power (dBm)		Total Power (mW)	Total Power (dBm)	Limit (dBm)	Pass / Fail
		Chain 0	Chain 1				
42	5210	14.48	15.77	65.812	18.18	30	Pass
155	5775	23.20	23.19	417.379	26.21	30	Pass

Beamforming Mode

802.11ac (VHT20)

Chan.	Chan. Freq. (MHz)	Average Power (dBm)		Total Power (mW)	Total Power (dBm)	Limit (dBm)	Pass / Fail
		Chain 0	Chain 1				
36	5180	21.52	21.89	296.431	24.72	29.59	Pass
40	5200	25.14	25.64	693.025	28.41	29.59	Pass
48	5240	25.77	25.51	733.204	28.65	29.59	Pass
149	5745	24.69	24.56	580.201	27.64	29.59	Pass
157	5785	24.28	24.36	540.815	27.33	29.59	Pass
165	5825	24.38	24.42	550.852	27.41	29.59	Pass

Note: Directional gain = $3.4\text{dBi} + 10\log(2) = 6.41\text{dBi} > 6\text{dBi}$, so the power limit shall be reduced to $30 - (6.41 - 6) = 29.59\text{dBm}$.

802.11ac (VHT40)

Chan.	Chan. Freq. (MHz)	Average Power (dBm)		Total Power (mW)	Total Power (dBm)	Limit (dBm)	Pass / Fail
		Chain 0	Chain 1				
38	5190	17.82	17.91	122.336	20.88	29.59	Pass
46	5230	24.80	24.45	580.607	27.64	29.59	Pass
151	5755	25.20	25.15	658.472	28.19	29.59	Pass
159	5795	24.36	24.44	550.869	27.41	29.59	Pass

Note: Directional gain = $3.4\text{dBi} + 10\log(2) = 6.41\text{dBi} > 6\text{dBi}$, so the power limit shall be reduced to $30 - (6.41 - 6) = 29.59\text{dBm}$.

802.11ac (VHT80)

Chan.	Chan. Freq. (MHz)	Average Power (dBm)		Total Power (mW)	Total Power (dBm)	Limit (dBm)	Pass / Fail
		Chain 0	Chain 1				
42	5210	14.37	15.42	62.186	17.94	29.59	Pass
155	5775	22.85	23.10	396.926	25.99	29.59	Pass

Note: Directional gain = $3.4\text{dBi} + 10\log(2) = 6.41\text{dBi} > 6\text{dBi}$, so the power limit shall be reduced to $30 - (6.41 - 6) = 29.59\text{dBm}$.

802.11ax (HE20)

Chan.	Chan. Freq. (MHz)	Average Power (dBm)		Total Power (mW)	Total Power (dBm)	Limit (dBm)	Pass / Fail
		Chain 0	Chain 1				
36	5180	21.55	21.99	301.014	24.79	29.59	Pass
40	5200	25.31	25.79	718.94	28.57	29.59	Pass
48	5240	25.85	25.64	751.029	28.76	29.59	Pass
149	5745	24.73	24.71	592.968	27.73	29.59	Pass
157	5785	24.39	24.47	554.688	27.44	29.59	Pass
165	5825	24.50	24.63	572.241	27.58	29.59	Pass

Note: Directional gain = $3.4\text{dBi} + 10\log(2) = 6.41\text{dBi} > 6\text{dBi}$, so the power limit shall be reduced to $30 - (6.41 - 6) = 29.59\text{dBm}$.

802.11ax (HE40)

Chan.	Chan. Freq. (MHz)	Average Power (dBm)		Total Power (mW)	Total Power (dBm)	Limit (dBm)	Pass / Fail
		Chain 0	Chain 1				
38	5190	17.92	18.25	128.778	21.10	29.59	Pass
46	5230	24.98	24.61	603.843	27.81	29.59	Pass
151	5755	25.30	25.42	687.181	28.37	29.59	Pass
159	5795	24.43	24.55	562.434	27.50	29.59	Pass

Note: Directional gain = $3.4\text{dBi} + 10\log(2) = 6.41\text{dBi} > 6\text{dBi}$, so the power limit shall be reduced to $30 - (6.41 - 6) = 29.59\text{dBm}$.

802.11ax (HE80)

Chan.	Chan. Freq. (MHz)	Average Power (dBm)		Total Power (mW)	Total Power (dBm)	Limit (dBm)	Pass / Fail
		Chain 0	Chain 1				
42	5210	14.48	15.77	65.812	18.18	29.59	Pass
155	5775	23.20	23.19	417.379	26.21	29.59	Pass

Note: Directional gain = $3.4\text{dBi} + 10\log(2) = 6.41\text{dBi} > 6\text{dBi}$, so the power limit shall be reduced to $30 - (6.41 - 6) = 29.59\text{dBm}$.

4.4 Occupied Bandwidth Measurement

4.4.1 Test Setup

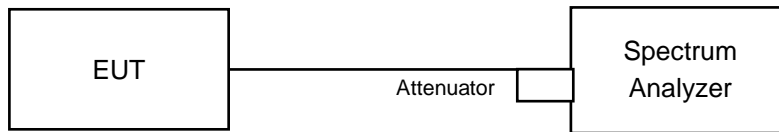

4.4.2 Test Instruments

Refer to section 4.1.2 to get information of above instrument.

4.4.3 Test Procedure

The transmitter output was connected to the spectrum analyzer through an attenuator. The bandwidth of the fundamental frequency was measured by spectrum analyzer with resolution bandwidth in the range of 1% to 5% of the anticipated emission bandwidth, and a video bandwidth at least 3x the resolution bandwidth and set the detector to SAMPLE. The width of a frequency band such that, below the lower and above the upper frequency limits, the mean powers emitted are each equal to a specified percentage 0.5% of the total mean power of a given emission.

4.4.4 Test Results

CDD Mode

802.11a

Channel	Frequency (MHz)	Occupied Bandwidth (MHz)	
		Chain 0	Chain 1
36	5180	16.44	16.44
40	5200	17.52	18.6
48	5240	18.24	18.6
149	5745	16.68	16.92
157	5785	16.8	17.16
165	5825	16.8	17.04

802.11ax (HE20)

Channel	Frequency (MHz)	Occupied Bandwidth (MHz)	
		Chain 0	Chain 1
36	5180	18.84	19.08
40	5200	19.08	19.32
48	5240	19.08	19.2
149	5745	19.2	19.44
157	5785	19.08	19.32
165	5825	19.08	19.2

802.11ax (HE40)

Channel	Frequency (MHz)	Occupied Bandwidth (MHz)	
		Chain 0	Chain 1
38	5190	37.68	37.68
46	5230	38.16	38.16
151	5755	38.64	39.84
159	5795	38.16	38.64

802.11ax (HE80)

Channel	Frequency (MHz)	Occupied Bandwidth (MHz)	
		Chain 0	Chain 1
42	5210	76.8	76.8
155	5775	77.28	77.28

Spectrum Plot of Worst Value

802.11a_Chain 1 / CH40

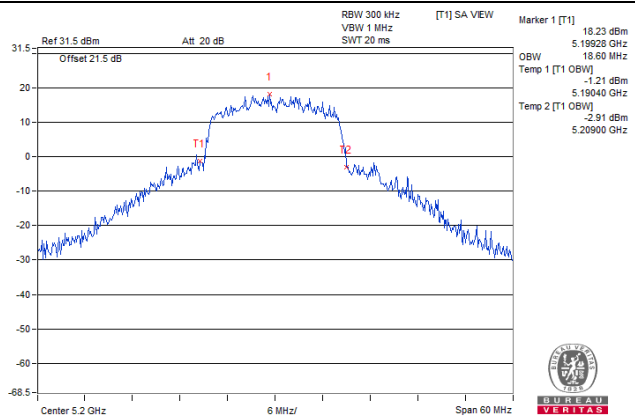

802.11ax (HE20)_Chain 1 / CH149

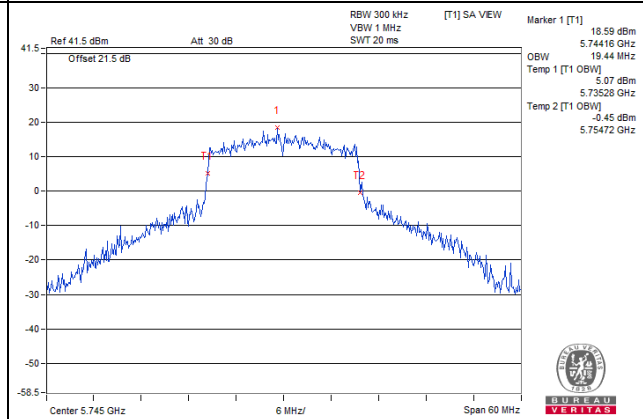

802.11ax (HE40)_Chain 1 / CH151

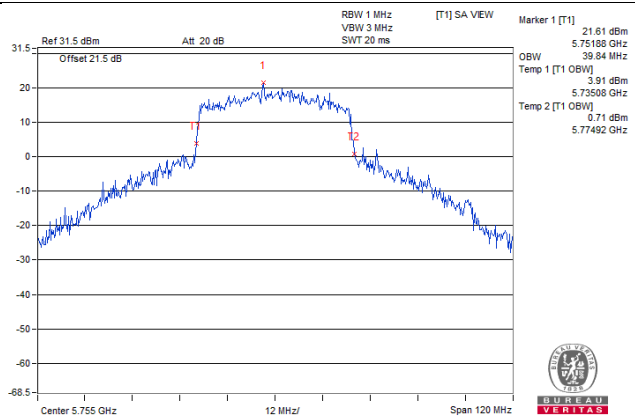

802.11ax (HE80)_Chain 0 / CH155

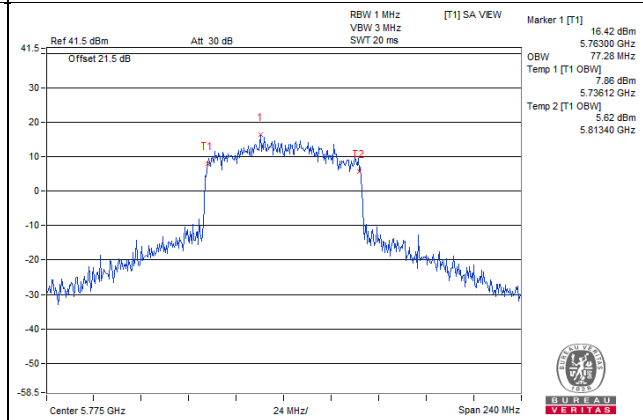

**Spectrum Plot for near by DFS band
(DFS is required, if 99% OCP straddle into U-NII-2A band)**

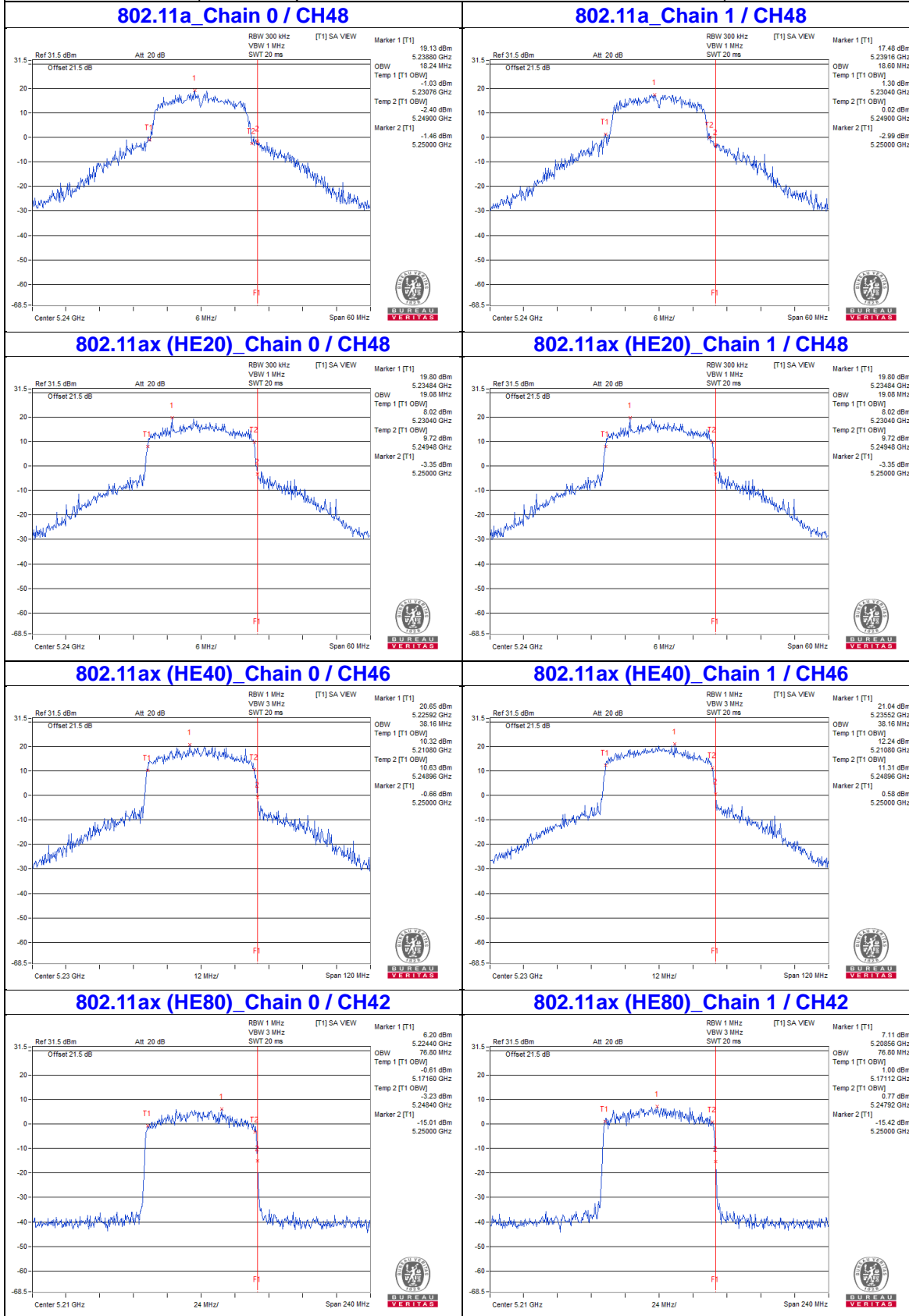

**Spectrum Plot for near by DFS band
(DFS is required, if 99% OCP straddle into U-NII-2C band)**

802.11a_Chain 0 / CH149

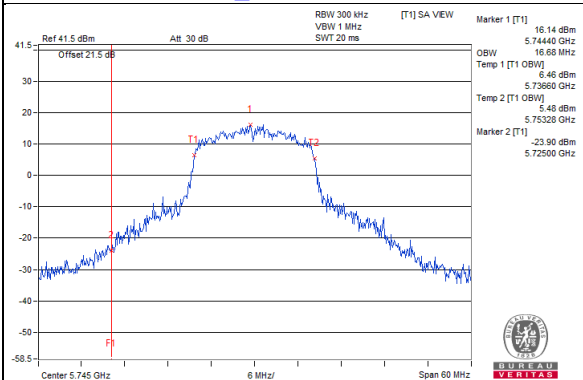

802.11a_Chain 1 / CH149

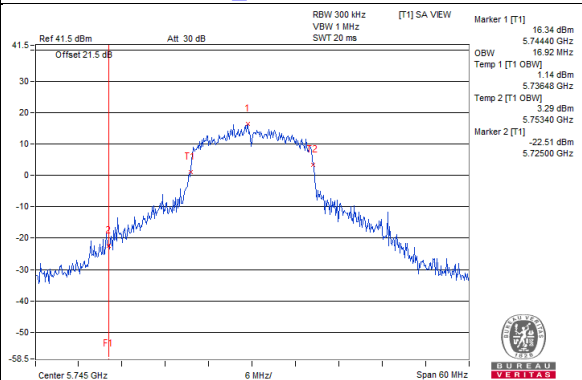

802.11ax (HE20)_Chain 0 / CH149

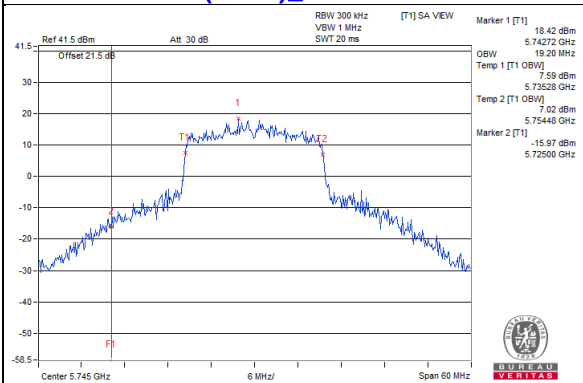

802.11ax (HE20)_Chain 1 / CH149

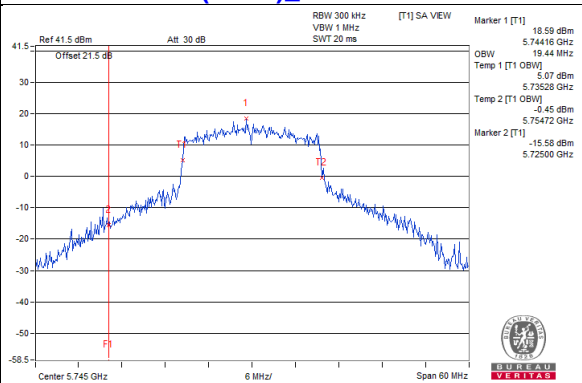

802.11ax (HE40)_Chain 0 / CH151

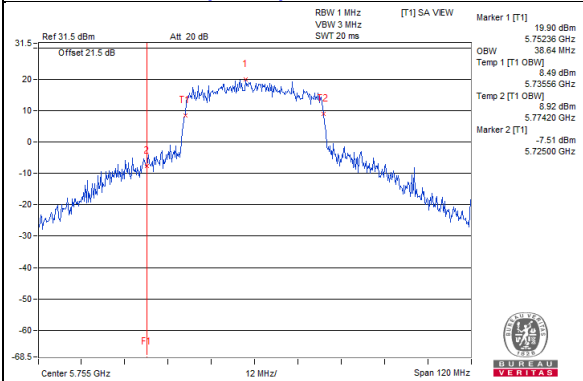

802.11ax (HE40)_Chain 1 / CH151

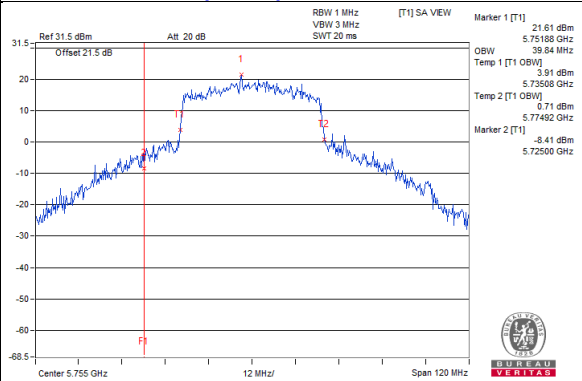

802.11ax (HE80)_Chain 0 / CH155

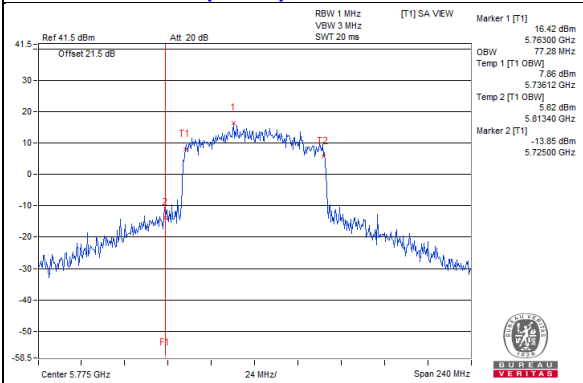

802.11ax (HE80)_Chain 1 / CH155

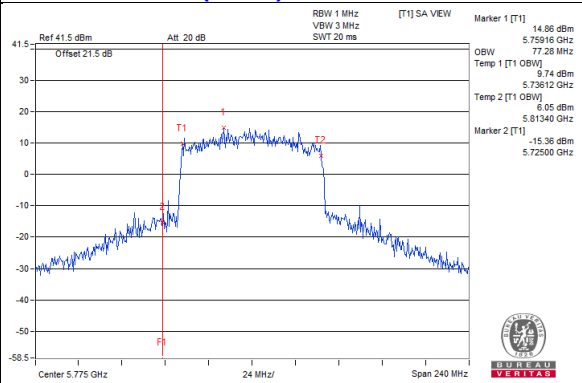

4.5 Peak Power Spectral Density Measurement

4.5.1 Limits of Peak Power Spectral Density Measurement

Operation Band	EUT Category		Limit
U-NII-1		Outdoor Access Point	17dBm/ MHz
		Fixed point-to-point Access Point	
	√	Indoor Access Point	11dBm/ MHz
		Client device	
U-NII-2A			11dBm/ MHz
U-NII-2C			11dBm/ MHz
U-NII-3	√		30dBm/ 500kHz

Note: This device can support different category application which switched by access point mode and client mode by software.

4.5.2 Test Setup

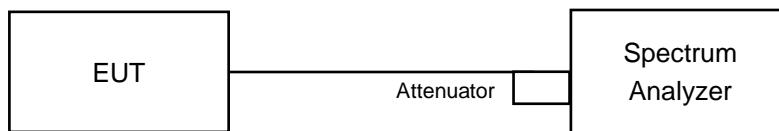

4.5.3 Test Instruments

Refer to section 4.1.2 to get information of above instrument.

4.5.4 Test Procedure

For U-NII-1 band:

Using method SA-1

1. Set span to encompass the entire emission bandwidth (EBW) of the signal.
2. Set RBW = 1 MHz, Set VBW ≥ 3 MHz, Detector = RMS
3. Sweep time = auto, trigger set to "free run".
4. Trace average at least 100 traces in power averaging mode.
5. Record the max value

For U-NII-3 band:

1. Set span to encompass the entire emission bandwidth (EBW) of the signal.
2. Set RBW = 300 kHz, Set VBW ≥ 1 MHz, Detector = RMS
3. Use the peak marker function to determine the maximum power level in any 300 kHz band segment within the fundamental EBW.
4. Scale the observed power level to an equivalent value in 500 kHz by adjusting (increasing) the measured power by a bandwidth correction factor (BWCF) where $BWCF = 10\log(500\text{ kHz}/300\text{ kHz})$
5. Sweep time = auto, trigger set to "free run".
6. Trace average at least 100 traces in power averaging mode.
7. Record the max value

4.5.5 Deviation from Test Standard

No deviation.

4.5.6 EUT Operating Condition

Same as Item 4.3.6.

4.5.7 Test Results

For U-NII-1 band:

CDD Mode

802.11a

Chan.	Chan. Freq. (MHz)	PSD (dBm/MHz)		Total Power Density (dBm/MHz)	MAX. Limit (dBm/MHz)	Pass / Fail
		Chain 0	Chain 1			
36	5180	11.18	11.80	14.51	16.59	Pass
40	5200	13.62	12.55	16.13	16.59	Pass
48	5240	13.14	13.31	16.24	16.59	Pass

Note: 1. Method a) of power density measurement of KDB 662911 is using for calculating total power density. Total power density is summing entire spectra across corresponding frequency bins on the various outputs by computer.

2. Directional gain = $3.4\text{dBi} + 10\log(2) = 6.41\text{dBi} > 6\text{dBi}$, so the power density limit shall be reduced to $17-(6.41-6) = 16.59\text{dBm}$.

802.11ax (HE20)

Chan.	Chan. Freq. (MHz)	PSD (dBm/MHz)		Total Power Density (dBm/MHz)	MAX. Limit (dBm/MHz)	Pass / Fail
		Chain 0	Chain 1			
36	5180	9.27	9.92	12.62	16.59	Pass
40	5200	12.81	13.44	16.15	16.59	Pass
48	5240	13.31	13.33	16.33	16.59	Pass

Note: 1. Method a) of power density measurement of KDB 662911 is using for calculating total power density. Total power density is summing entire spectra across corresponding frequency bins on the various outputs by computer.

2. Directional gain = $3.4\text{dBi} + 10\log(2) = 6.41\text{dBi} > 6\text{dBi}$, so the power density limit shall be reduced to $17-(6.41-6) = 16.59\text{dBm}$.

802.11ax (HE40)

Chan.	Chan. Freq. (MHz)	PSD (dBm/MHz)		Total Power Density (dBm/MHz)	MAX. Limit (dBm/MHz)	Pass / Fail
		Chain 0	Chain 1			
38	5190	2.67	2.68	5.69	16.59	Pass
46	5230	9.71	9.39	12.56	16.59	Pass

Note: 1. Method a) of power density measurement of KDB 662911 is using for calculating total power density. Total power density is summing entire spectra across corresponding frequency bins on the various outputs by computer.

2. Directional gain = $3.4\text{dBi} + 10\log(2) = 6.41\text{dBi} > 6\text{dBi}$, so the power density limit shall be reduced to $17-(6.41-6) = 16.59\text{dBm}$.

802.11ax (HE80)

Chan.	Chan. Freq. (MHz)	PSD (dBm/MHz)		Total Power Density (dBm/MHz)	MAX. Limit (dBm/MHz)	Pass / Fail
		Chain 0	Chain 1			
42	5210	-3.30	-1.88	0.48	16.59	Pass

Note: 1. Method a) of power density measurement of KDB 662911 is using for calculating total power density. Total power density is summing entire spectra across corresponding frequency bins on the various outputs by computer.

2. Directional gain = $3.4\text{dBi} + 10\log(2) = 6.41\text{dBi} > 6\text{dBi}$, so the power density limit shall be reduced to $17-(6.41-6) = 16.59\text{dBm}$.

Spectrum Plot of Worst Value

802.11a_Chain 0 / CH40

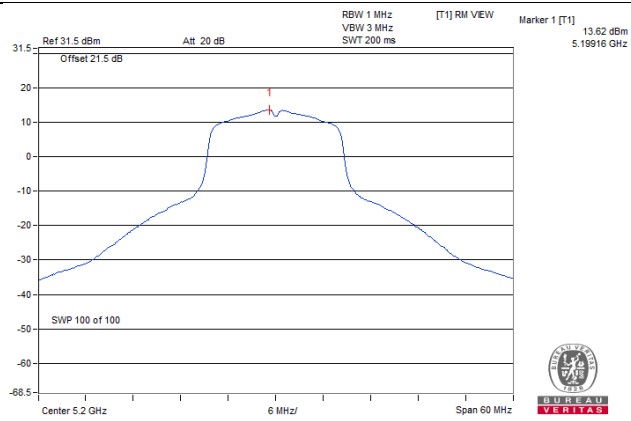

802.11ax (HE20)_Chain 1 / CH40

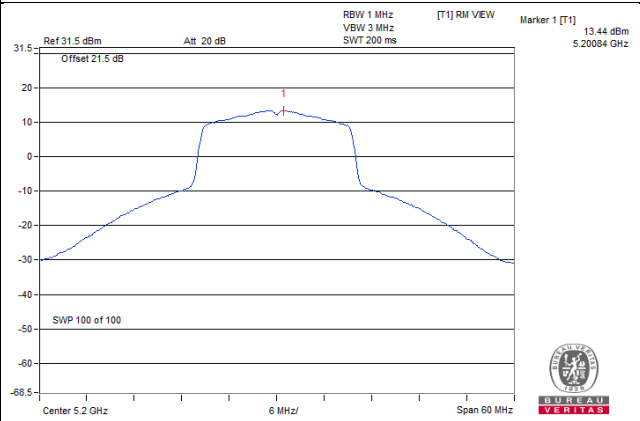

802.11ax (HE40)_Chain 0 / CH46

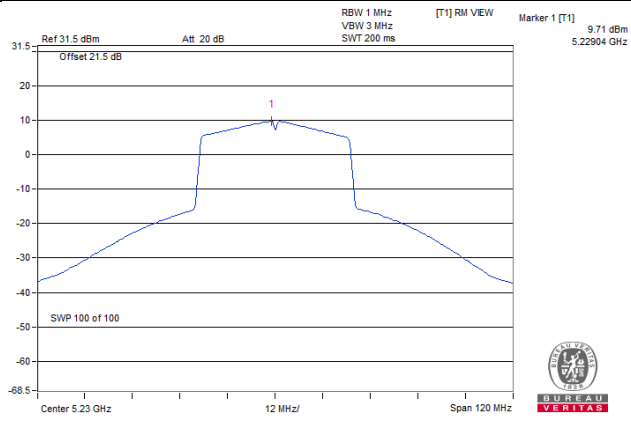

802.11ax (HE80)_Chain 1 / CH42

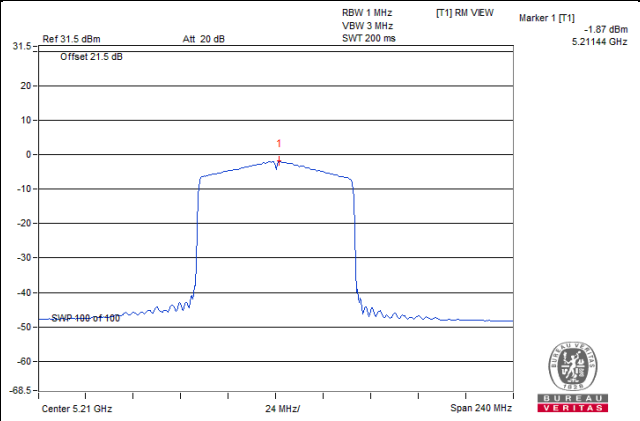

For U-NII-3 band:

CDD Mode

802.11a

Chan.	Freq. (MHz)	PSD (dBm/300kHz)		Total PSD		Total PSD (dBm/500kHz)	Limit (dBm/500kHz)	Pass /Fail
		Chain 0	Chain 1	mW/300kHz	dBm/300kHz			
149	5745	4.99	4.78	6.161	7.90	10.12	29.59	Pass
157	5785	4.90	5.04	6.282	7.98	10.20	29.59	Pass
165	5825	5.13	5.08	6.479	8.12	10.34	29.59	Pass

- Note:**
- Method b) Measure and sum spectral maxima across the outputs of KDB 662911 is using for calculating total power density.
 - Directional gain = $3.4\text{dBi} + 10\log(2) = 6.41\text{dBi} > 6\text{dBi}$, so the power density limit shall be reduced to $30 - (6.41 - 6) = 29.59\text{dBm}$.

802.11ax (HE20)

Chan.	Freq. (MHz)	PSD (dBm/300kHz)		Total PSD		Total PSD (dBm/500kHz)	Limit (dBm/500kHz)	Pass /Fail
		Chain 0	Chain 1	mW/300kHz	dBm/300kHz			
149	5745	4.40	4.24	5.409	7.33	9.55	29.59	Pass
157	5785	3.88	3.75	4.815	6.83	9.05	29.59	Pass
165	5825	4.04	3.74	4.901	6.90	9.12	29.59	Pass

- Note:**
- Method b) Measure and sum spectral maxima across the outputs of KDB 662911 is using for calculating total power density.
 - Directional gain = $3.4\text{dBi} + 10\log(2) = 6.41\text{dBi} > 6\text{dBi}$, so the power density limit shall be reduced to $30 - (6.41 - 6) = 29.59\text{dBm}$.

802.11ax (HE40)

Chan.	Freq. (MHz)	PSD (dBm/300kHz)		Total PSD		Total PSD (dBm/500kHz)	Limit (dBm/500kHz)	Pass /Fail
		Chain 0	Chain 1	mW/300kHz	dBm/300kHz			
151	5755	1.76	1.80	3.013	4.79	7.01	29.59	Pass
159	5795	1.00	1.10	2.547	4.06	6.28	29.59	Pass

- Note:**
- Method b) Measure and sum spectral maxima across the outputs of KDB 662911 is using for calculating total power density.
 - Directional gain = $3.4\text{dBi} + 10\log(2) = 6.41\text{dBi} > 6\text{dBi}$, so the power density limit shall be reduced to $30 - (6.41 - 6) = 29.59\text{dBm}$.

802.11ax (HE80)

Chan.	Freq. (MHz)	PSD (dBm/300kHz)		Total PSD		Total PSD (dBm/500kHz)	Limit (dBm/500kHz)	Pass /Fail
		Chain 0	Chain 1	mW/300kHz	dBm/300kHz			
155	5775	-3.29	-3.36	0.9301	-0.31	1.91	29.59	Pass

- Note:**
- Method b) Measure and sum spectral maxima across the outputs of KDB 662911 is using for calculating total power density.
 - Directional gain = $3.4\text{dBi} + 10\log(2) = 6.41\text{dBi} > 6\text{dBi}$, so the power density limit shall be reduced to $30 - (6.41 - 6) = 29.59\text{dBm}$.

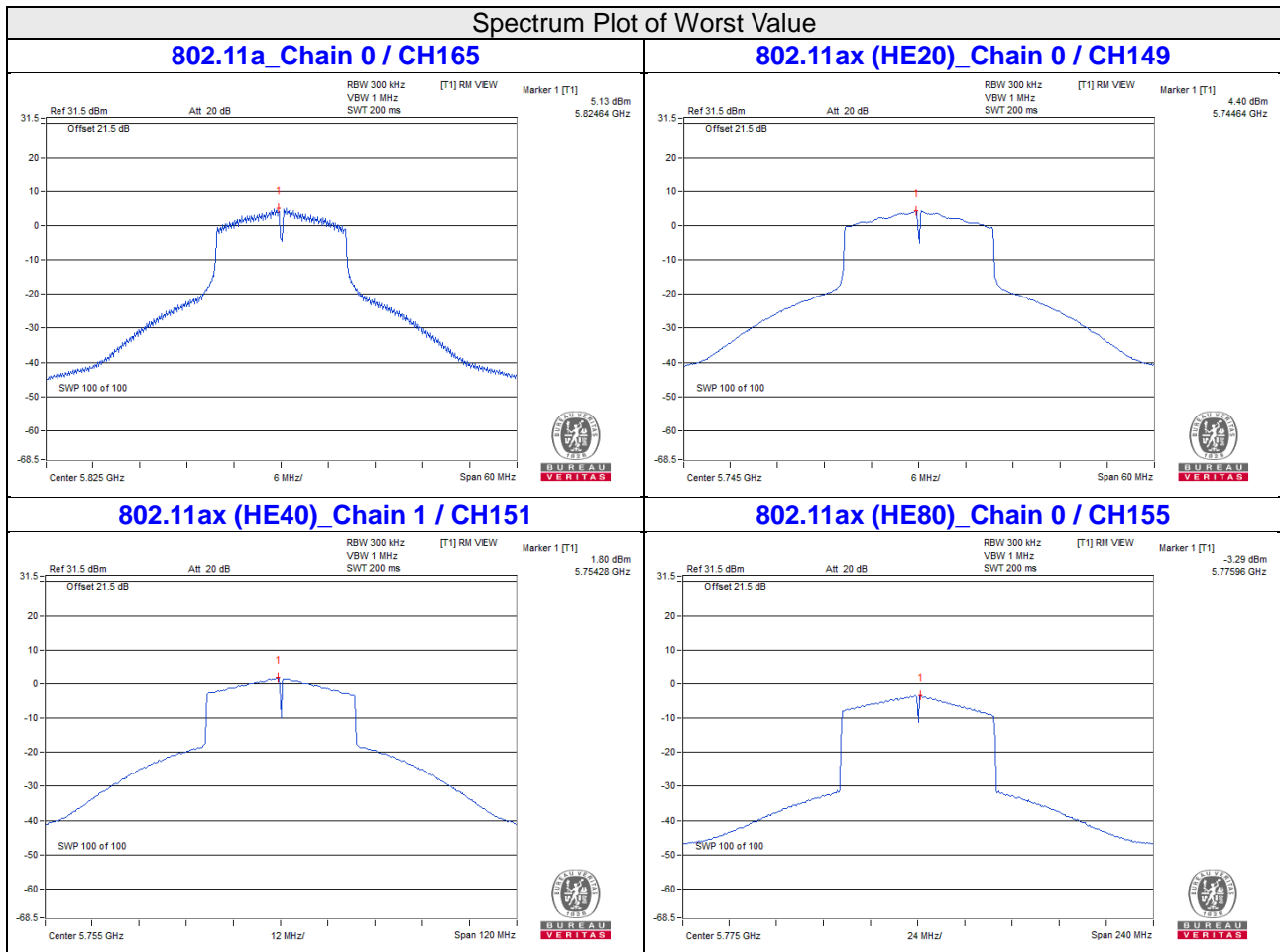

4.6 Frequency Stability Measurement

4.6.1 Limits of Frequency Stability Measurement

The frequency of the carrier signal shall be maintained within band of operation

4.6.2 Test Setup

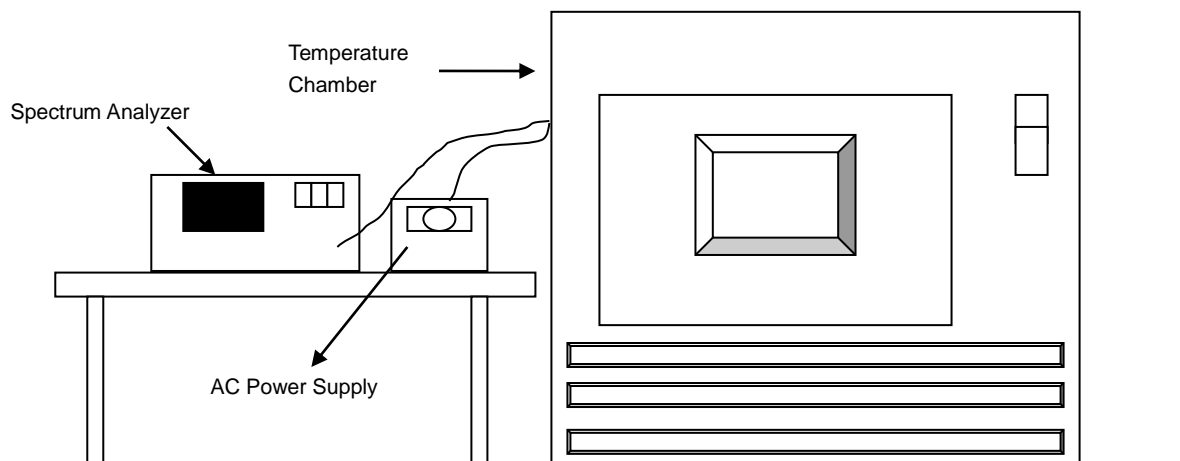

4.6.3 Test Instruments

Refer to section 4.1.2 to get information of above instrument.

4.6.4 Test Procedure

- The EUT was placed inside the environmental test chamber and powered by nominal AC voltage.
- Turn the EUT on and couple its output to a spectrum analyzer.
- Turn the EUT off and set the chamber to the highest temperature specified.
- Allow sufficient time (approximately 30 min) for the temperature of the chamber to stabilize, turn the EUT on and measure the operating frequency after 2, 5, and 10 Minutes.
- Repeat step (d) with the temperature chamber set to the next desired temperature until measurements down to the lowest specified temperature have been completed.
- The test chamber was allowed to stabilize at +20 degree C for a minimum of 30 Minutes. The supply voltage was then adjusted on the EUT from 85% to 115% and the frequency record.

4.6.5 Deviation from Test Standard

No deviation.

4.6.6 EUT Operating Condition

Set the EUT transmit at un-modulation mode to test frequency stability.

4.6.7 Test Results

Frequency Stability Versus Temp.									
Operating Frequency: 5180 MHz									
TEMP. (°C)	Power Supply (Vac)	0 Minute		2 Minutes		5 Minutes		10 Minutes	
		Measured Frequency (MHz)	Pass/Fail	Measured Frequency (MHz)	Pass/Fail	Measured Frequency (MHz)	Pass/Fail	Measured Frequency (MHz)	Pass/Fail
40	120	5179.9926	Pass	5179.9933	Pass	5179.9972	Pass	5179.9969	Pass
30	120	5179.9928	Pass	5179.9974	Pass	5179.9959	Pass	5179.9944	Pass
20	120	5180.0147	Pass	5180.0196	Pass	5180.0157	Pass	5180.0167	Pass
10	120	5179.9976	Pass	5179.9978	Pass	5179.9974	Pass	5180.0007	Pass
0	120	5179.9826	Pass	5179.9822	Pass	5179.9869	Pass	5179.986	Pass

Frequency Stability Versus Voltage									
Operating Frequency: 5180 MHz									
TEMP. (°C)	Power Supply (Vac)	0 Minute		2 Minutes		5 Minutes		10 Minutes	
		Measured Frequency (MHz)	Pass/Fail	Measured Frequency (MHz)	Pass/Fail	Measured Frequency (MHz)	Pass/Fail	Measured Frequency (MHz)	Pass/Fail
20	138	5180.0148	Pass	5180.0201	Pass	5180.0147	Pass	5180.0175	Pass
	120	5180.0147	Pass	5180.0196	Pass	5180.0157	Pass	5180.0167	Pass
	102	5180.0149	Pass	5180.0206	Pass	5180.0148	Pass	5180.0161	Pass

4.7 6dB Bandwidth Measurement

4.7.1 Limits of 6dB Bandwidth Measurement

The minimum of 6dB Bandwidth Measurement is 0.5MHz.

4.7.2 Test Setup

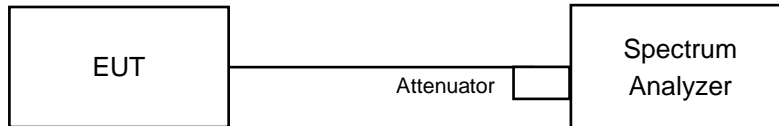

4.7.3 Test Instruments

Refer to section 4.1.2 to get information of above instrument.

4.7.4 Test Procedure

MEASUREMENT PROCEDURE REF

- Set resolution bandwidth (RBW) = 100kHz
- Set the video bandwidth (VBW) $\geq 3 \times$ RBW, Detector = Peak.
- Trace mode = max hold.
- Sweep = auto couple.
- Measure the maximum width of the emission that is constrained by the frequencies associated with the two amplitude points (upper and lower) that are attenuated by 6 dB relative to the maximum level measured in the fundamental emission

4.7.5 Deviation from Test Standard

No deviation.

4.7.6 EUT Operating Condition

The software provided by client to enable the EUT under transmission condition continuously at lowest, middle and highest channel frequencies individually.

4.7.7 Test Results

CDD Mode

802.11a

Channel	Frequency (MHz)	6dB Bandwidth (MHz)		Minimum Limit (MHz)	Pass / Fail
		Chain 0	Chain 1		
149	5745	15.16	15.1	0.5	Pass
157	5785	15.09	15.14	0.5	Pass
165	5825	15.73	14.44	0.5	Pass

802.11ax (HE20)

Channel	Frequency (MHz)	6dB Bandwidth (MHz)		Minimum Limit (MHz)	Pass / Fail
		Chain 0	Chain 1		
149	5745	17.71	15.3	0.5	Pass
157	5785	15.63	16.26	0.5	Pass
165	5825	16.27	17.31	0.5	Pass

802.11ax (HE40)

Channel	Frequency (MHz)	6dB Bandwidth (MHz)		Minimum Limit (MHz)	Pass / Fail
		Chain 0	Chain 1		
151	5755	35.43	34.49	0.5	Pass
159	5795	35.91	33.92	0.5	Pass

802.11ax (HE80)

Channel	Frequency (MHz)	6dB Bandwidth (MHz)		Minimum Limit (MHz)	Pass / Fail
		Chain 0	Chain 1		
155	5775	70.2	74.08	0.5	Pass

Spectrum Plot of Worst Value

802.11a_Chain 0 / CH157

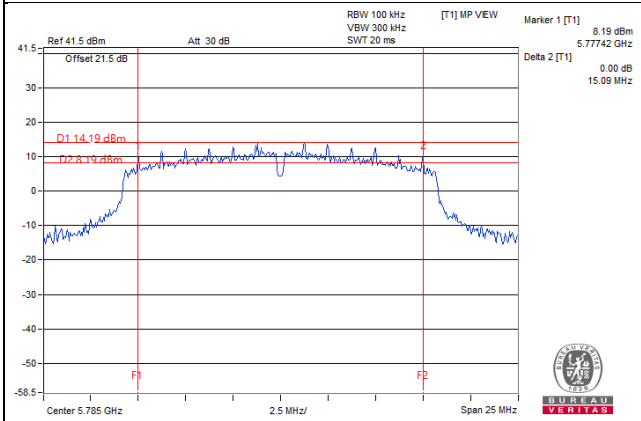

802.11ax (HE20)_Chain 1 / CH149

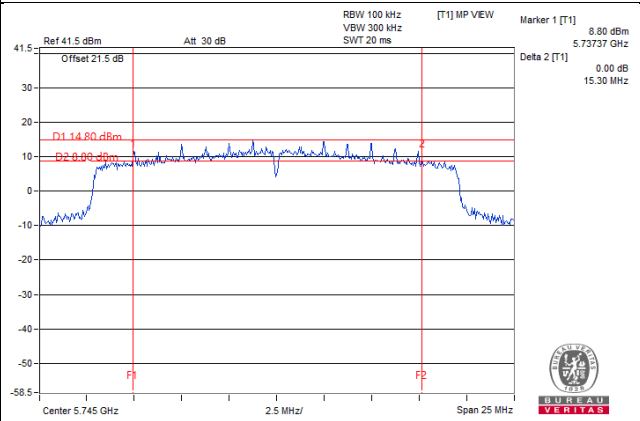

802.11ax (HE40)_Chain 1 / CH159

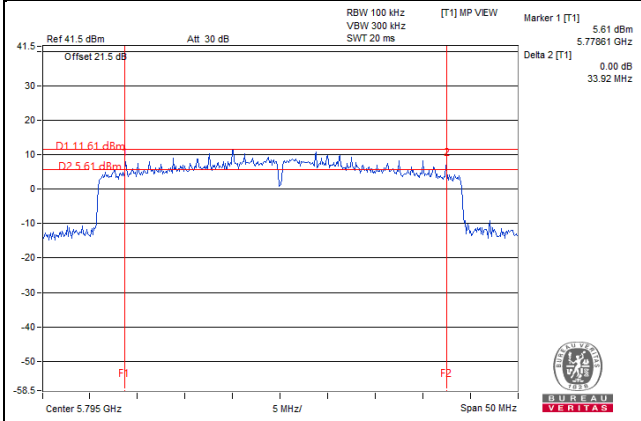

802.11ax (HE80)_Chain 0 / CH155

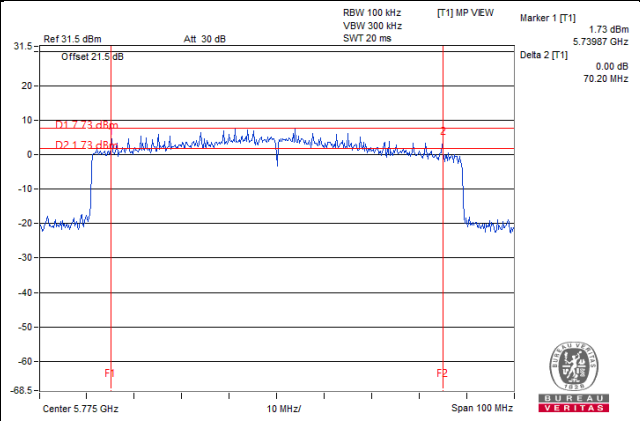

5 Pictures of Test Arrangements

Please refer to the attached file (Test Setup Photo).

Annex A - Radiated Out of Band Emission (OOBE) Measurement (For U-NII-3 band)

802.11a CH 149 : 5745 MHz

Horizontal

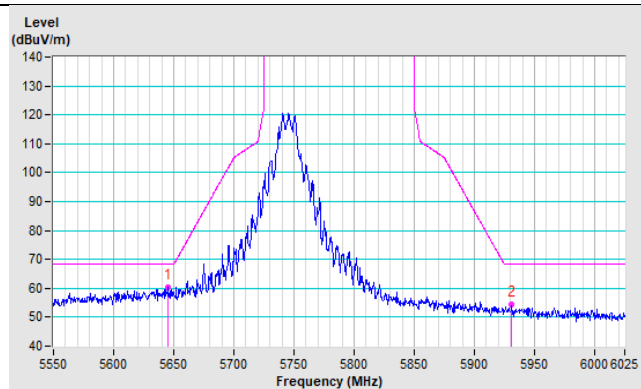

Vertical

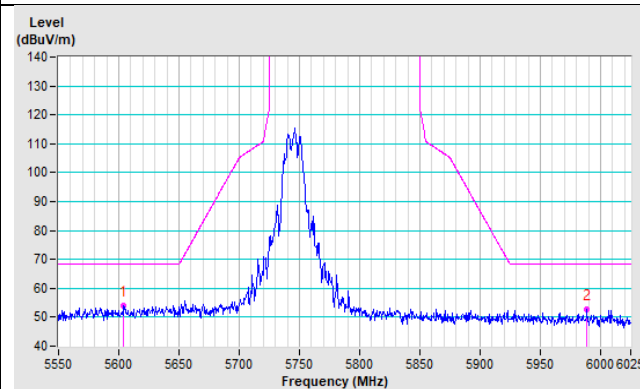

802.11a CH 157 : 5785 MHz

Horizontal

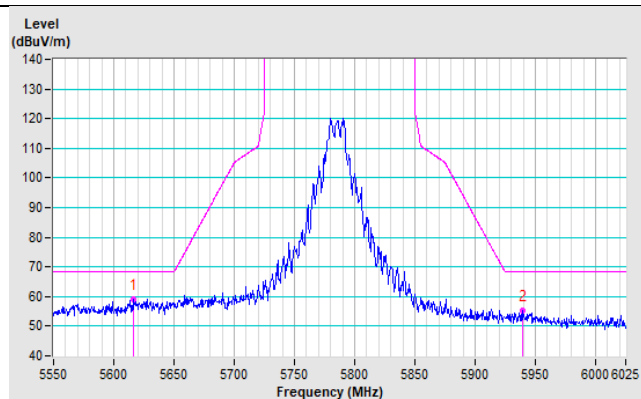

Vertical

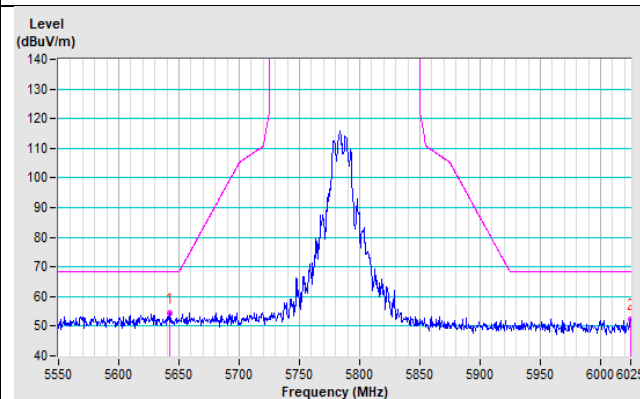

802.11a CH 165 : 5825 MHz

Horizontal

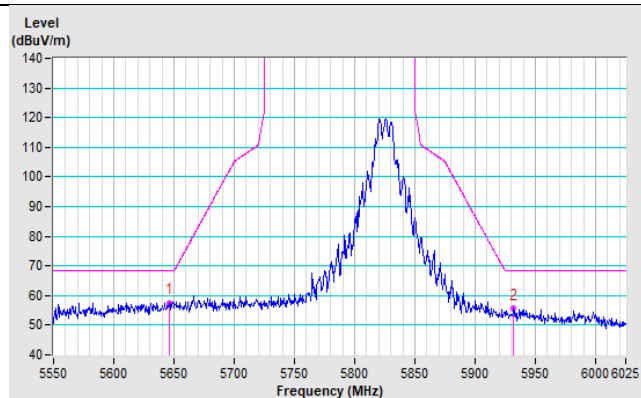

Vertical

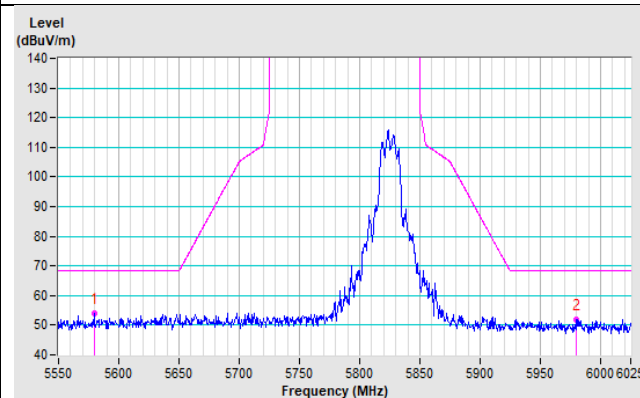

802.11ax (HE20) CH 149 : 5745 MHz

Horizontal

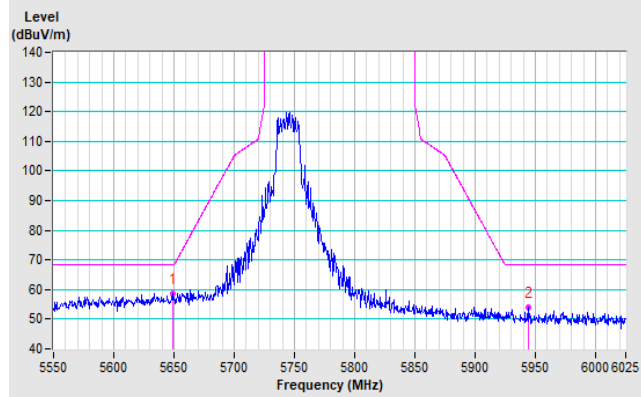

Vertical

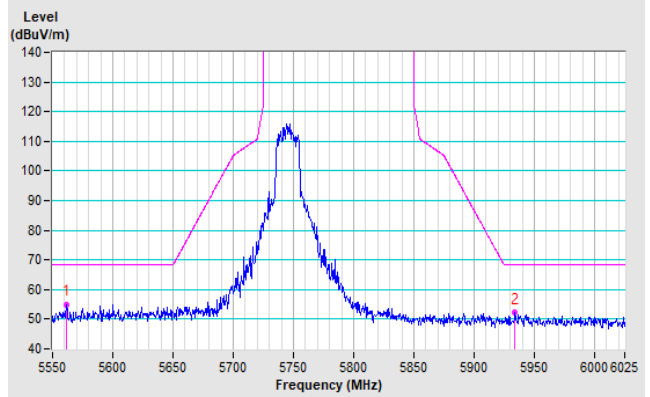

802.11ax (HE20) CH 157 : 5785 MHz

Horizontal

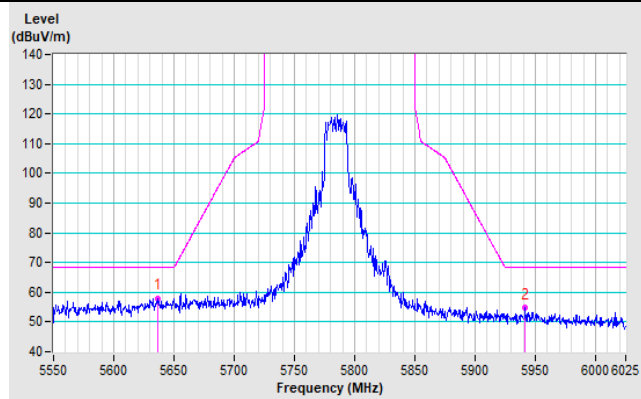

Vertical

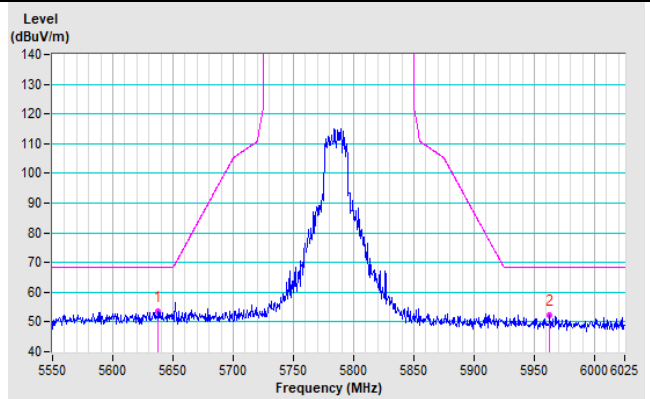

802.11ax (HE20) CH 165 : 5825 MHz

Horizontal

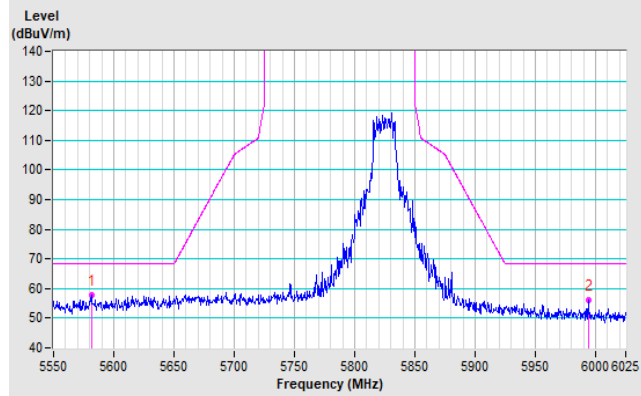

Vertical

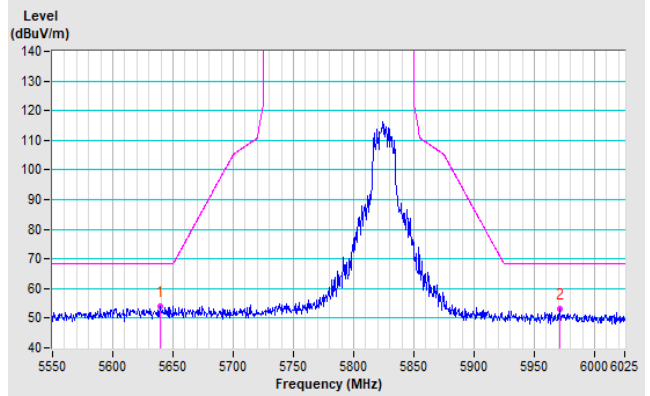

802.11ax (HE40) CH 151 : 5755 MHz

Horizontal

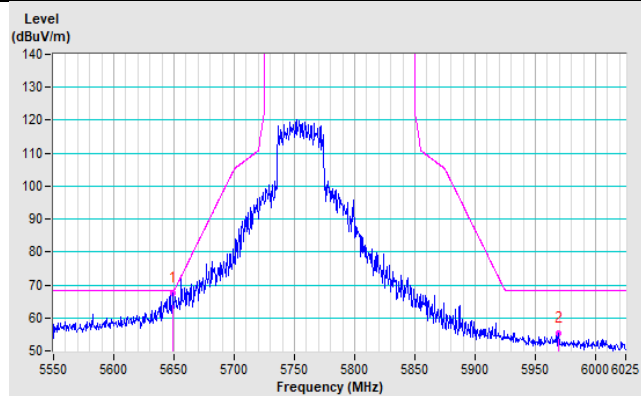

Vertical

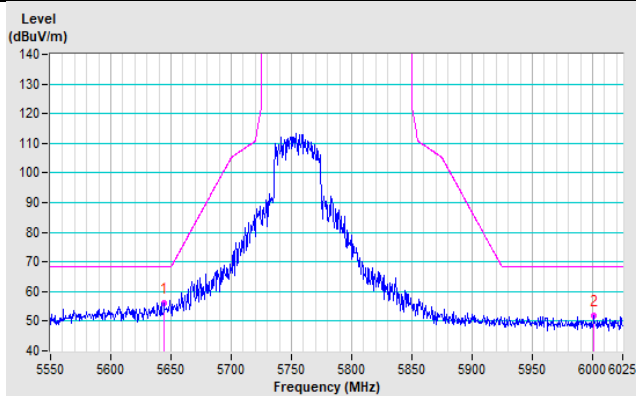

802.11ax (HE40) CH 159 : 5795 MHz

Horizontal

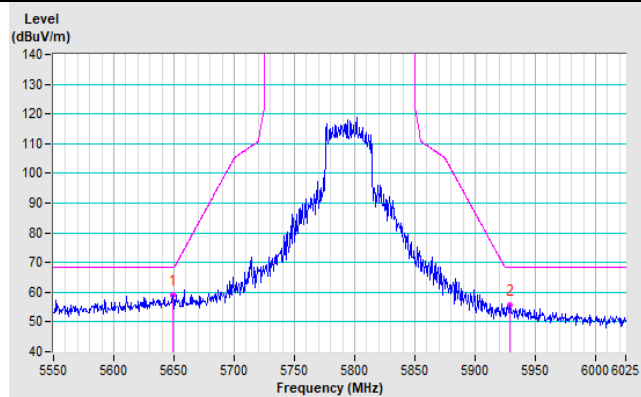

Vertical

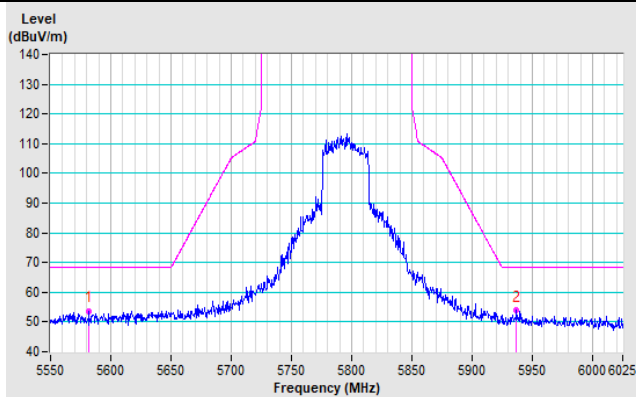

802.11ax (HE80) CH 155 : 5775 MHz

Horizontal

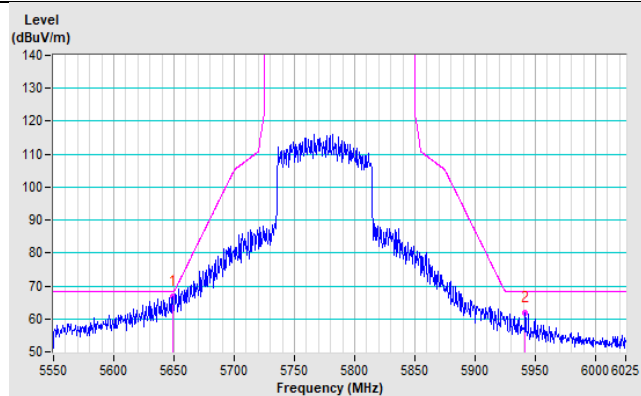

Vertical

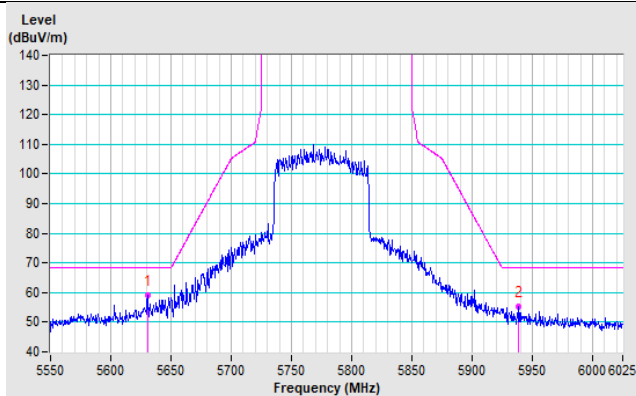

Annex B - Band-Edge Measurement (For U-NII-1 band)

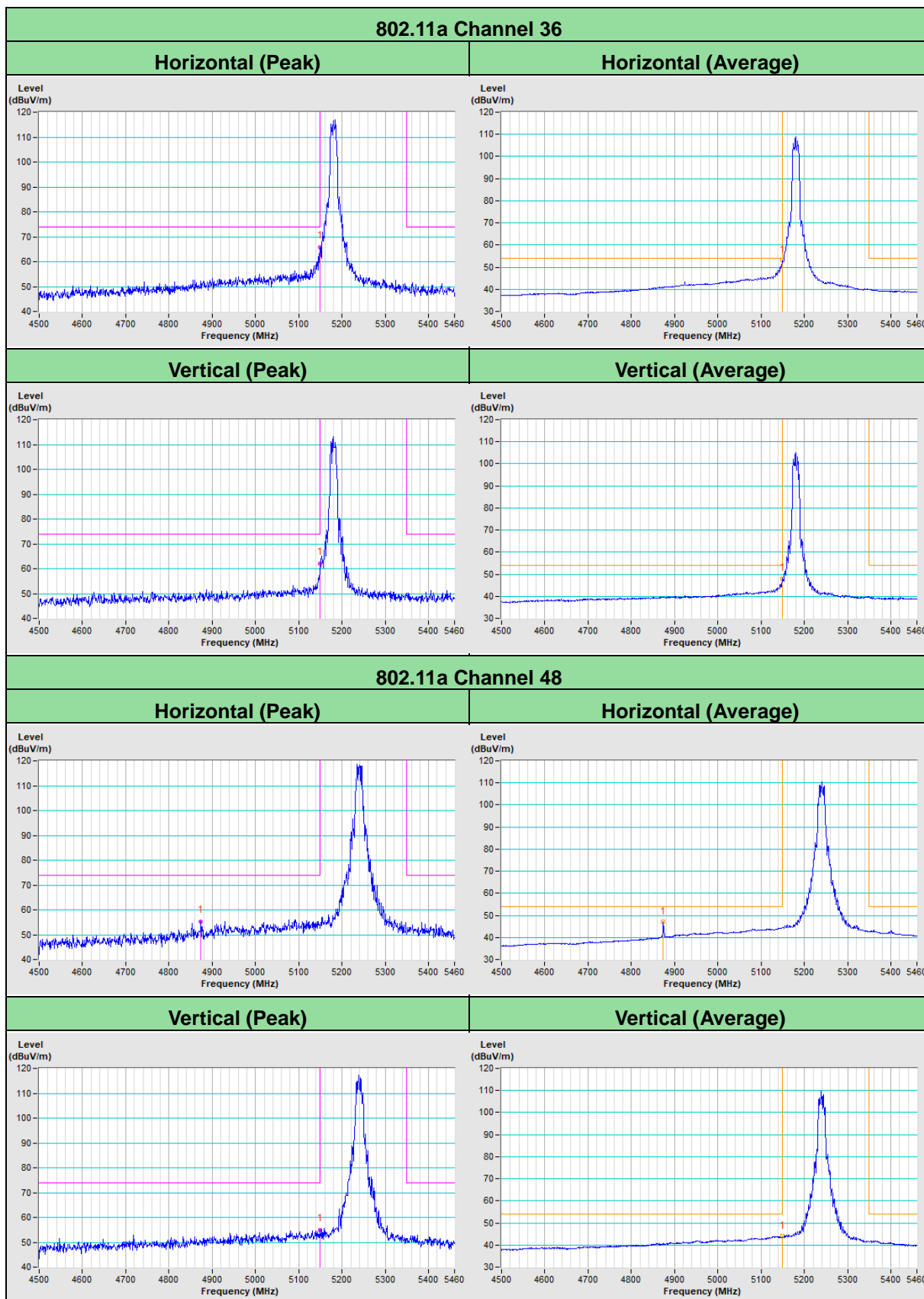

802.11ax (HE20) Channel 36

Horizontal (Peak)

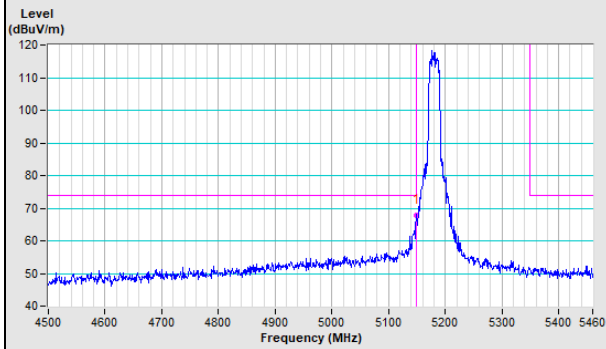

Horizontal (Average)

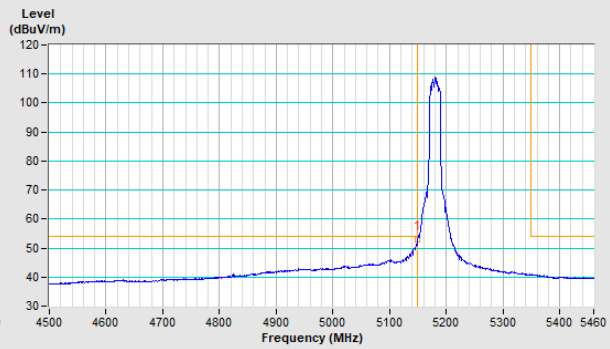

Vertical (Peak)

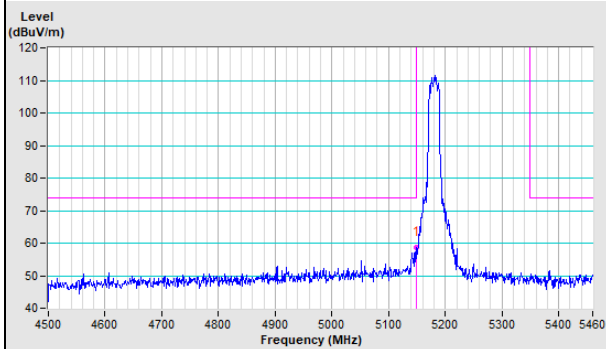

Vertical (Average)

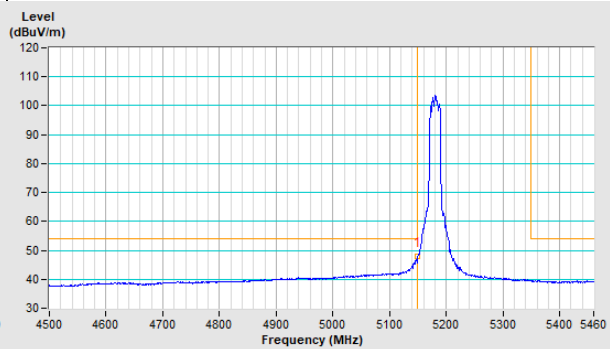

802.11ax (HE20) Channel 48

Horizontal (Peak)

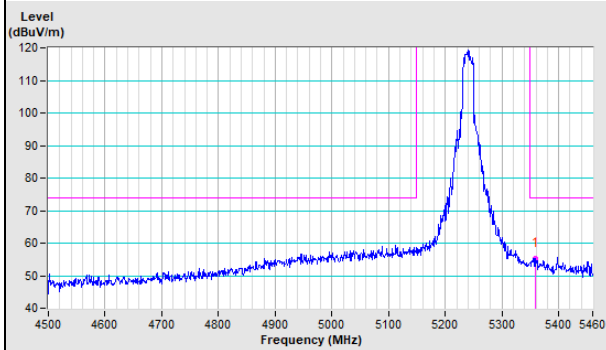

Horizontal (Average)

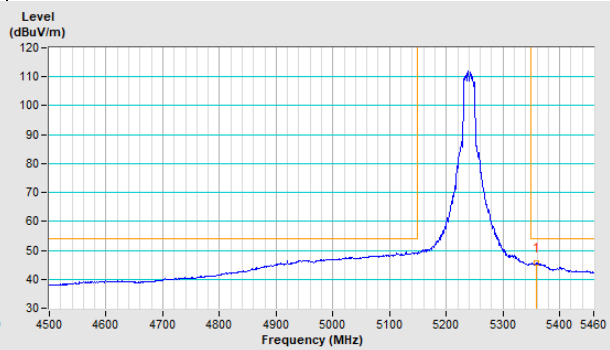

Vertical (Peak)

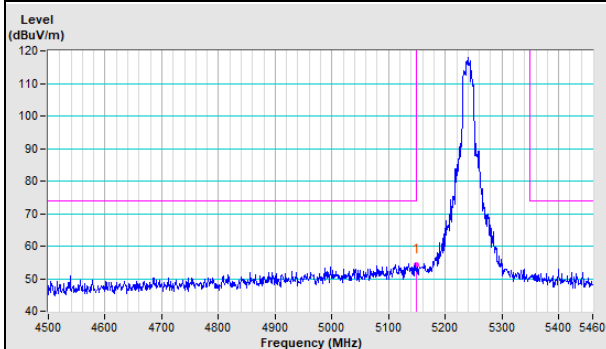

Vertical (Average)

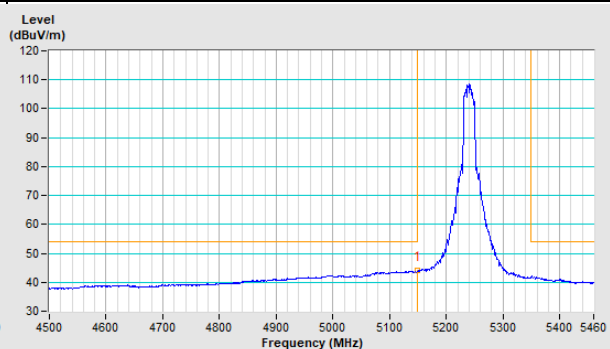

802.11ax (HE40) Channel 38

Horizontal (Peak)	Horizontal (Average)
-------------------	----------------------

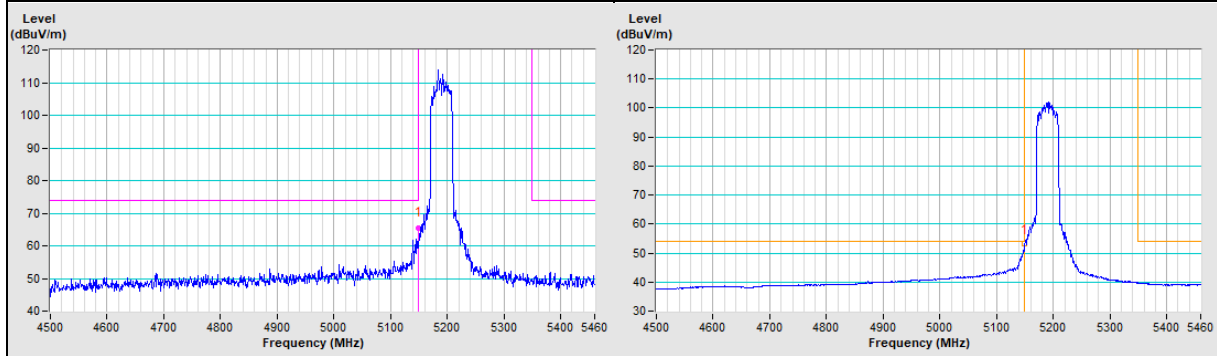

Vertical (Peak)	Vertical (Average)
-----------------	--------------------

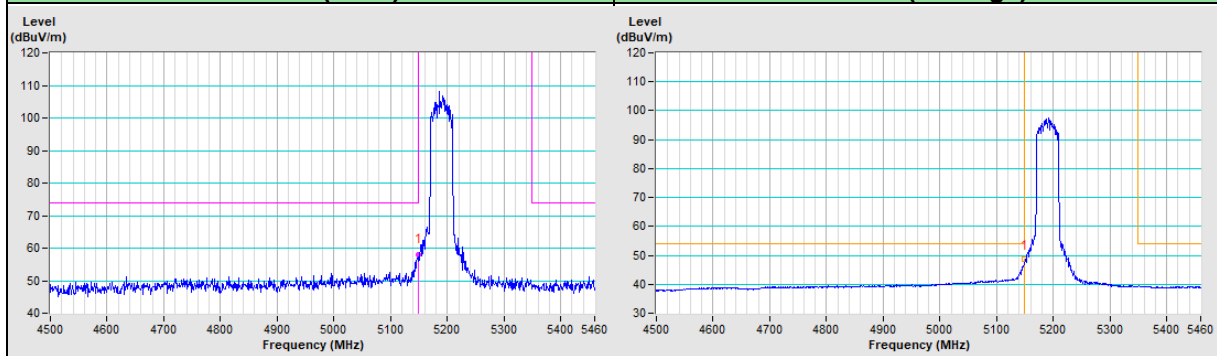

802.11ax (HE40) Channel 46

Horizontal (Peak)	Horizontal (Average)
-------------------	----------------------

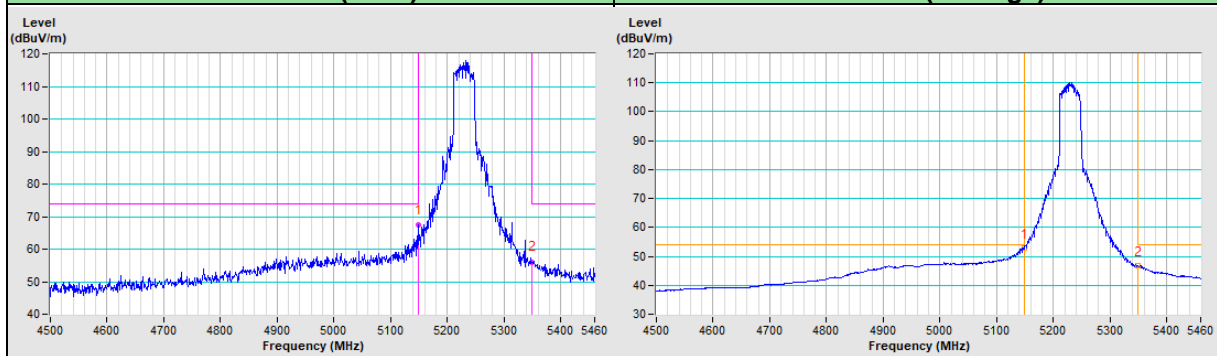

Vertical (Peak)	Vertical (Average)
-----------------	--------------------

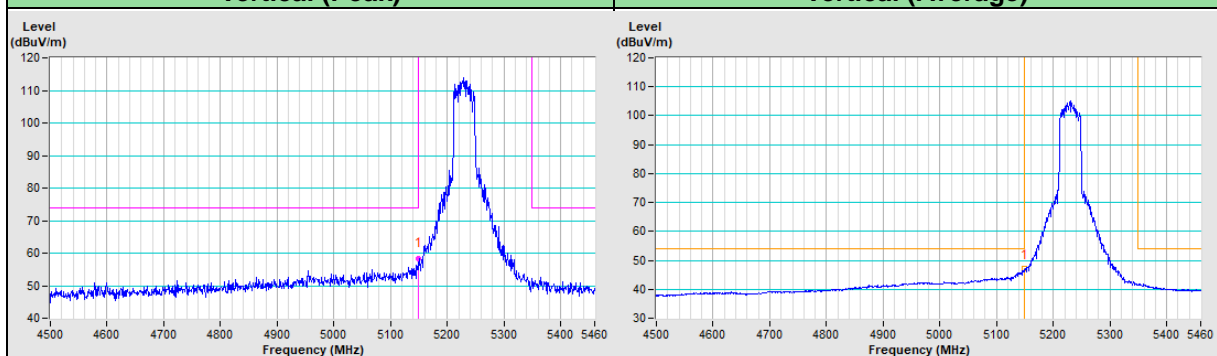

802.11ax (HE80) Channel 42

Horizontal (Peak)

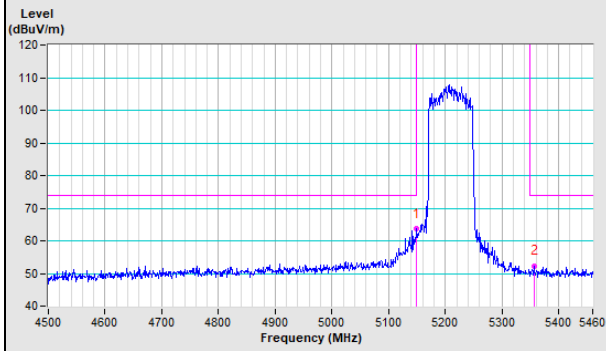

Horizontal (Average)

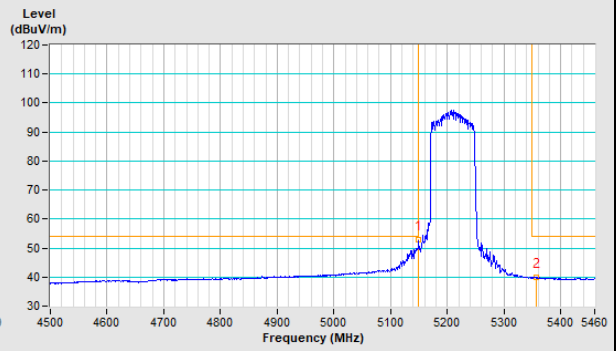

Vertical (Peak)

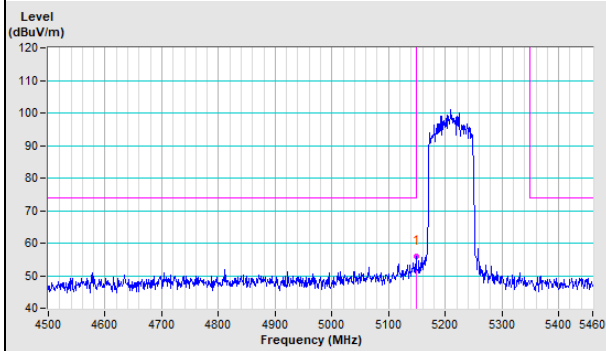

Vertical (Average)

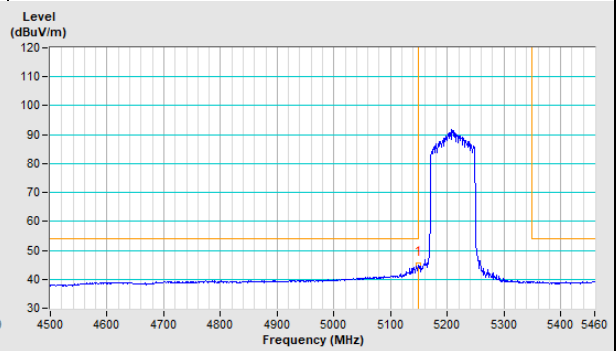

Appendix – Information of the Testing Laboratories

We, Bureau Veritas Consumer Products Services (H.K.) Ltd., Taoyuan Branch, were founded in 1988 to provide our best service in EMC, Radio, Telecom and Safety consultation. Our laboratories are FCC recognized accredited test firms and accredited according to ISO/IEC 17025.

If you have any comments, please feel free to contact us at the following:

Lin Kou EMC/RF Lab

Tel: 886-2-26052180

Fax: 886-2-26051924

Hsin Chu EMC/RF/Telecom Lab

Tel: 886-3-6668565

Fax: 886-3-6668323

Hwa Ya EMC/RF/Safety Lab

Tel: 886-3-3183232

Fax: 886-3-3270892

Email: service.adt@tw.bureauveritas.com

Web Site: www.bureauveritas-adt.com

The address and road map of all our labs can be found in our web site also.

--- END ---