



WRE2205

Wireless N300 Range Extender

Version 1.00
Edition 3, 08/2013



User's Guide

Default Details

LAN IP Address	http://192.168.1.2
User Name	admin
Password	1234
SSID	ZyXEL
Pre-shared Key	00000000

IMPORTANT!

READ CAREFULLY BEFORE USE.

KEEP THIS GUIDE FOR FUTURE REFERENCE.

Related Documentation

- Quick Start Guide

The Quick Start Guide shows how to connect the WRE2205 and access the Web Configurator wizards. It also contains a connection diagram and package contents list.

Contents Overview

User's Guide	7
Introduction	9
The Web Configurator	13
Connection Wizard	15
Status	21
Tutorials	26
Technical Reference	36
Wireless LAN	38
LAN	47
System	49
Tools	50
Troubleshooting	56

Table of Contents

Contents Overview	3
Table of Contents	4
Part I: User's Guide	7
Chapter 1	
Introduction.....	9
1.1 Overview	9
1.2 Securing the WRE2205	10
1.3 Front Panel	10
1.4 The WPS Button	11
1.4.1 WiFi Protected Setup	11
Chapter 2	
The Web Configurator	13
2.1 Overview	13
2.2 Accessing the Web Configurator	13
2.3 Resetting the WRE2205	14
Chapter 3	
Connection Wizard	15
3.1 Overview	15
3.2 Configuring the WRE2205 for Connection to an AP	15
3.2.1 Selecting Automatically Detected AP Parameters	15
3.2.2 Manually Configuring AP Parameters	17
3.3 Completing the Connection Wizard	18
Chapter 4	
Status	21
4.1 WRE2205 Status	21
4.1.1 Summary: Packet Statistics	23
4.1.2 Summary: WLAN Station Status	23
4.2 Navigation Panel	24
Chapter 5	
Tutorials.....	26
5.1 Overview	26

5.2 Connecting a Wireless Client using WPS	26
5.2.1 Push Button Configuration (PBC)	26
5.2.2 PIN Configuration	28
5.3 Connecting the WRE2205 to an AP	29
5.3.1 Connecting to an AP with the WPS PBC Method	30
5.3.2 Connecting to an AP with the WPS PIN Method	31
5.3.3 Selecting an AP from an Automatically Detected List	32
5.3.4 Selecting an AP by Manually Entering Security Information	34
Part II: Technical Reference.....	36
Chapter 6	
Wireless LAN.....	38
6.1 Overview	38
6.2 What You Can Do	38
6.3 What You Should Know	38
6.3.1 Wireless Security Overview	39
6.4 General Wireless LAN Screen	40
6.5 MAC Address List	41
6.6 Wireless LAN Advanced Screen	42
6.7 Quality of Service (QoS) Screen	43
6.8 WPS Screen	43
6.9 WPS Station Screen	44
6.10 AP Select Screen	45
Chapter 7	
LAN	47
7.1 Overview	47
7.2 What You Need To Know	47
7.3 LAN IP Screen	47
Chapter 8	
System	49
8.1 Overview	49
8.2 What You Can Do	49
8.3 System Password Screen	49
Chapter 9	
Tools	50
9.1 Overview	50
9.2 What You Can Do	50

9.3 Firmware Upload Screen	50
9.4 Configuration Screen	52
9.4.1 Backup Configuration	53
9.4.2 Restore Configuration	53
9.4.3 Back to Factory Defaults	54
9.5 Restart Screen	54
9.6 LED Screen	54
Chapter 10	
Troubleshooting.....	56
10.1 Power, Hardware Connections, and LEDs	56
10.2 WRE2205 Access and Login	57
10.3 Internet Access	58
10.4 Resetting the WRE2205 to Its Factory Defaults	60
10.5 Wireless Problems	60
Appendix A Legal Information.....	61
Index	66

PART I

User's Guide

Introduction

1.1 Overview

The WRE2205 (N) is a universal repeater that is an access point and a wireless client at the same time. The WRE2205 (N) wirelessly relays communications from its wireless clients to the access point.

Figure 1 Universal Repeater

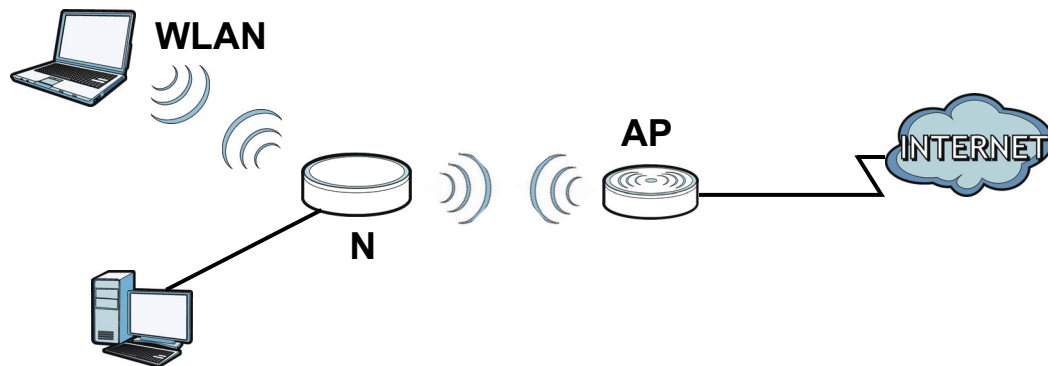

You can create the following connections using the WRE2205:

- **LAN.** You can connect network devices via the Ethernet port of the WRE2205 so that they can communicate with each other and access the Internet.
- **WLAN.** Wireless clients can connect to the WRE2205 to access network resources.

Use a (supported) web browser to manage the WRE2205.



See [Chapter 4](#) on [page 21](#) for more information.

1.2 Securing the WRE2205

Do the following things regularly to make the WRE2205 more secure and to manage the WRE2205 more effectively.

- Change the password. Use a password that's not easy to guess and that consists of different types of characters, such as numbers and letters.
- Write down the password and put it in a safe place.
- Back up the configuration (and make sure you know how to restore it). Restoring an earlier working configuration may be useful if the device becomes unstable or even crashes. If you forget your password, you will have to reset the WRE2205 to its factory default settings. If you backed up an earlier configuration file, you would not have to totally re-configure the WRE2205. You could simply restore your last configuration.

1.3 Front Panel

Figure 2 Front Panel

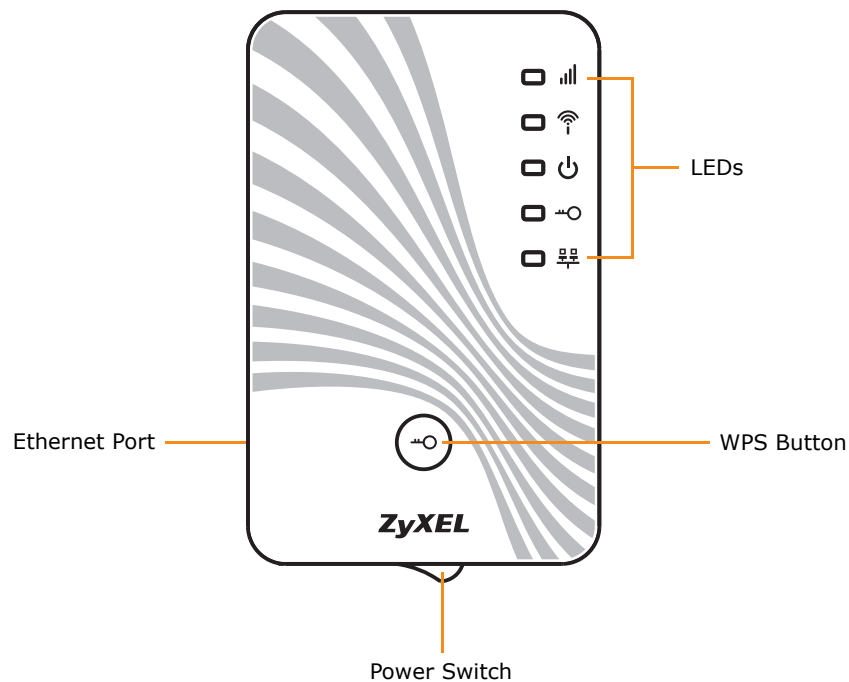

The following table describes the LEDs and the WPS button.

Table 1 Front Panel LEDs and WPS Button





LED	STATUS	DESCRIPTION
	On	Signal strength 50-100%
	Blinking	Signal strength 25-50%
	Blinking rapidly	Signal strength <25%
	Off	No signal detected, disconnected or the LED is turned off in the firmware.

Table 1 Front Panel LEDs and WPS Button (continued)

LED	STATUS	DESCRIPTION
	Blinking	The WRE2205 is sending/receiving data through the wireless LAN.
	Off	The wireless LAN is not ready or the LED is turned off in the firmware.
	On	The WRE2205 is receiving power and functioning properly.
	Blinking	The WRE2205 is resetting to factory defaults.
	Off	The WRE2205 is not receiving power or the LED is turned off in the firmware.
	On	This remains on for 5 minutes after a successful WPS connection has been established.
	Blinking	The WRE2205 is waiting for another WPS device to connect.
	Off	There is no WPS connection established or a WPS connection has been established for more than five minutes, or the LED is turned off in the firmware.
	On	The WRE2205 has a successful 10/100MB LAN connection.
	Blinking	The WRE2205 is sending/receiving data through the LAN.
	Off	The LAN is not connected or the LED is turned off in the firmware.

1.4 The WPS Button

The WPS button can be used to begin WiFi Protected Setup (WPS), reboot the WRE2205 while keeping its configuration or reboot the WRE2205 to factory default configuration.

Table 2 WPS Button Functions

ACTION	RESULT
Push once or hold for less than 5 seconds	The WRE2205 begins connecting to an AP via WPS. See Section 5.3 on page 29 .
Push twice	The WRE2205 begins connecting to a wireless client via WPS. See Section 5.2 on page 26 .
Hold for 5 to 10 seconds	The WRE2205 keeps its configuration and reboots.
Hold for more than 10 seconds	The WRE2205 resets its configuration to factory defaults and reboots. See Section 2.3 on page 14 .

1.4.1 WiFi Protected Setup

Your WRE2205 supports Wi-Fi Protected Setup (WPS), which is an easy way to set up a secure wireless network. WPS is an industry standard specification, defined by the WiFi Alliance.

WPS allows you to quickly set up a wireless network with strong security, without having to configure security settings manually. Each WPS connection works between two devices. Both devices must support WPS (check each device's documentation to make sure).

Depending on the devices you have, you can either press a button (recommended) on the device itself, or in its configuration utility or enter a PIN (a unique Personal Identification Number that allows one device to authenticate the other) in each of the two devices. When WPS is activated on

a device, it has two minutes to find another device that also has WPS activated. Then, the two devices connect and set up a secure network by themselves.

For more information on using WPS, see [Section 5.2 on page 26](#).

The Web Configurator

2.1 Overview

This chapter describes how to access the WRE2205 Web Configurator and provides an overview of its screens.

The Web Configurator is an HTML-based management interface that allows easy setup and management of the WRE2205 via Internet browser. Use Internet Explorer 6.0 and later versions, Mozilla Firefox 3 and later versions, or Safari 2.0 and later versions. The recommended screen resolution is 1024 by 768 pixels.

In order to use the Web Configurator you need to allow:

- Web browser pop-up windows from your device. Web pop-up blocking is enabled by default in Windows XP SP (Service Pack) 2.
- JavaScript (enabled by default).
- Java permissions (enabled by default).

Refer to [Chapter 10 Troubleshooting](#) to see how to make sure these functions are allowed in Internet Explorer.

2.2 Accessing the Web Configurator

- 1 Make sure your WRE2205 hardware is properly connected and prepare your computer or computer network to connect to the WRE2205 (refer to the Quick Start Guide).

Note: Your computer or the part of your network connected to the WRE2205 must be on the same subnet as the WRE2205.

The WRE2205's DHCP server is enabled before the WRE2205 is associated with your AP or wireless router and disabled after association. If this is the first time you are accessing your WRE2205, you can configure your computer as a DHCP client (computer factory default) so it will get an IP address automatically from the WRE2205. After the WRE2205 is associated with your wireless router, your computer will get its IP address from the wireless router.

- 2 Launch your web browser.
- 3 If this is the first time you are accessing your WRE2205, type "http://192.168.1.2" as the website address in your web browser. This is the default LAN IP address. Alternatively, after the WRE2205 has successfully associated with your wireless router, type "http://zyxelsetupxxxx" instead of the default IP address, where xxxx is the last four digits of the MAC address.

- 4 Type **admin** (default) as the user name and **1234** (default) as the password and click **OK**.

Figure 3 Login Screen

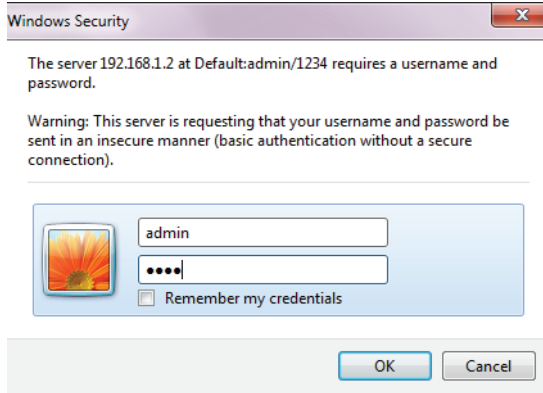

2.3 Resetting the WRE2205

If you forget your password or IP address, or you cannot access the Web Configurator, press the **WPS** button for more than 10 seconds to reload the factory-default configuration file. This means that you will lose all configurations that you had previously saved, the username will be reset to **admin** and password will be reset to **1234**. The IP address will be reset to "192.168.1.2".

- 1 Make sure the power LED is on.
- 2 Press and hold the **WPS** button. After 10 seconds, the power LED begins flashing.
- 3 Release the **WPS** button. The WRE2205 reloads factory defaults and begins to reboot.

Connection Wizard

3.1 Overview

This chapter provides information on the wizard setup screens in the Web Configurator.

The Web Configurator's wizard setup helps you configure your device. The first time you access the WRE2205 Web Configurator, the wizard displays automatically. For subsequent access, click  to start the wizard setup.

3.2 Configuring the WRE2205 for Connection to an AP

In this step of the configuration wizard, you must configure the WRE2205 with the security parameters of the AP you want to connect to. These parameters can be configured by selecting those automatically detected by the WRE2205, or by configuring them manually. Manual configuration is useful when the AP is hidden.

3.2.1 Selecting Automatically Detected AP Parameters

- 1 Select an AP using the following screen.

Figure 4 Wizard: Wireless Setup



The following table describes the labels in this screen.

Table 3 Network > Wireless LAN > AP Select

LABEL	DESCRIPTION
Select	Use the radio button to select the wireless device to which you want to connect.
SSID	This displays the Service Set IDentity of the wireless device. The SSID is a unique name that identifies a wireless network. All devices in a wireless network must use the same SSID.
MAC	This displays the MAC address of the wireless device.
Channel	This displays the channel number used by this wireless device.
Mode	This displays which IEEE 802.11b/g/n wireless networking standards the wireless device supports.
Security Mode	This displays the type of security configured on the wireless device. When no is shown, no security is configured and you can connect to it without a password.
Strength	This displays the strength of the wireless signal. The signal strength mainly depends on the antenna output power and the distance between your WRE2205 and this device.
Setup repeater manually	Select this to setup the AP manually.
SSID	If Setup repeater manually is selected, use this field to type the SSID of the AP. This is useful when the AP's SSID is hidden.
Refresh	Click this to search for available wireless devices within transmission range and update this table.
BACK	Click this to go back to the previous step in the wizard.
NEXT	Click this to start the next step in the AP setup process.
EXIT	Click this to exit the wizard.
Previous	Click this to see the previous page of APs.
Next	Click this to see the next page of APs.

Note: The wireless stations and WRE2205 must use the same SSID, channel ID, WPA-PSK (if WPA-PSK is enabled) or WPA2-PSK (if WPA2-PSK is enabled) for wireless communication.

- 2 Type a key. The number of characters accepted by the KEY field is shown in the following table.

Table 4 Maximum Key Lengths

ENCRYPTION	KEY FORMAT	KEY LENGTH
64-bit WEP	ASCII	5 characters
	Hex	10 characters
128-bit WEP	ASCII	13 characters
	Hex	26 characters
WPA pre-shared key	Passphrase	8-63 characters
	Hex	64 characters

Figure 5 Wizard: Type a Key

eaZy 123

Wireless Setup

1

Please enter your wireless network's password

KEY :

BACK NEXT EXIT

ZyXEL

3.2.2 Manually Configuring AP Parameters

If the AP you want to connect to is not listed, then follow these steps to configure the security settings of the AP manually.

- 1 Select **Setup repeater manually**.
- 2 Type the SSID of the AP into the **SSID** field.

Figure 6 Wizard: Manually Typing the SSID

eaZy 123

Wireless Setup

1

Select	SSID	MAC	Channel	Mode	Security Mode	Strength
1 <input type="radio"/>	Unizyx_WLAN	50:67:f0:37:a0:88	6	bgn	WPA2	96% <input type="text"/>
2 <input type="radio"/>	Unizyx_GUEST	e2:67:f0:37:a0:88	6	bgn	WPA2-PSK	96% <input type="text"/>
3 <input type="radio"/>	ESBU_MAC_AUTH	e6:67:f0:37:a0:88	6	bgn	WPA2-PSK	96% <input type="text"/>
4 <input type="radio"/>	Unizyx_WLAN_4F	ea:67:f0:37:a0:88	6	bgn	WPA2	96% <input type="text"/>
5 <input type="radio"/>	marcom	28:cf:da:b6:4a:c5	1	bgn	WPA2-PSK	82% <input type="text"/>

Setup repeater manually

SSID :

Previous 1/13 Next

Refresh NEXT EXIT

ZyXEL

- 3 Configure the security settings. The number of characters accepted by the KEY field is shown in the following table.

Table 5 Maximum Key Lengths

ENCRYPTION	KEY FORMAT	KEY LENGTH
64-bit WEP	ASCII	5 characters
	Hex	10 characters
128-bit WEP	ASCII	13 characters
	Hex	26 characters
WPA pre-shared key	Passphrase	8-63 characters
	Hex	64 characters

Figure 7 Wizard: Manually Configuring Security Settings

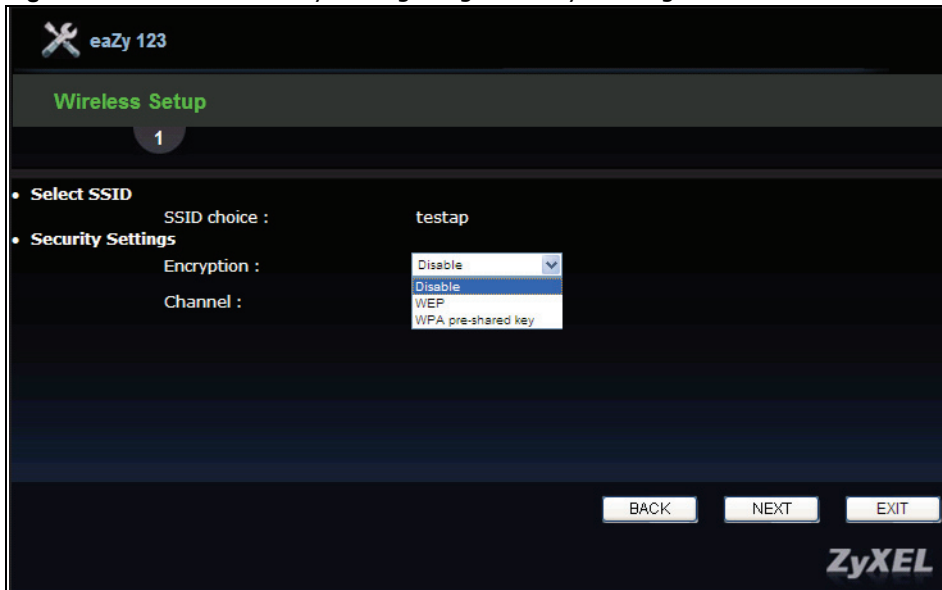

3.3 Completing the Connection Wizard

- 1 Click **Next**. The key verification screen appears.

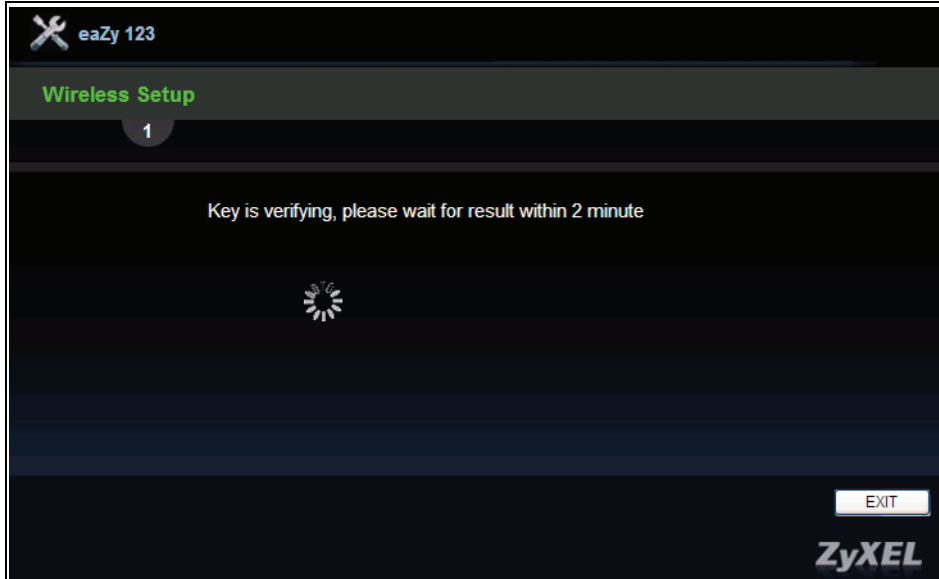
Figure 8 Wizard: Verifying the Key

The following screen appears if the key verifies successfully.

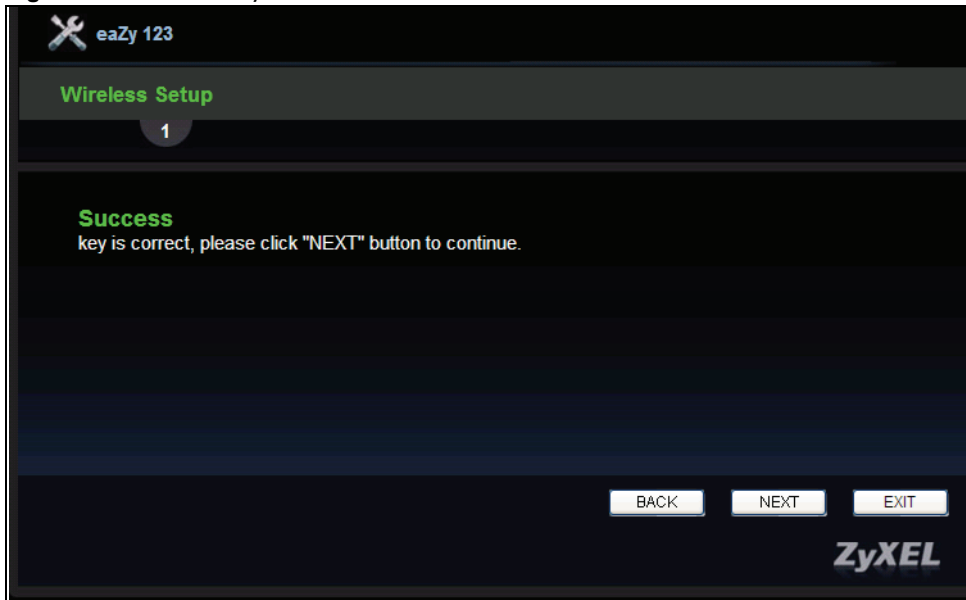
Figure 9 Wizard: Key Verification Success

The following screen appears if the key fails to verify. Click **BACK** and check the key.

Figure 10 Wizard: Key Verification Failed

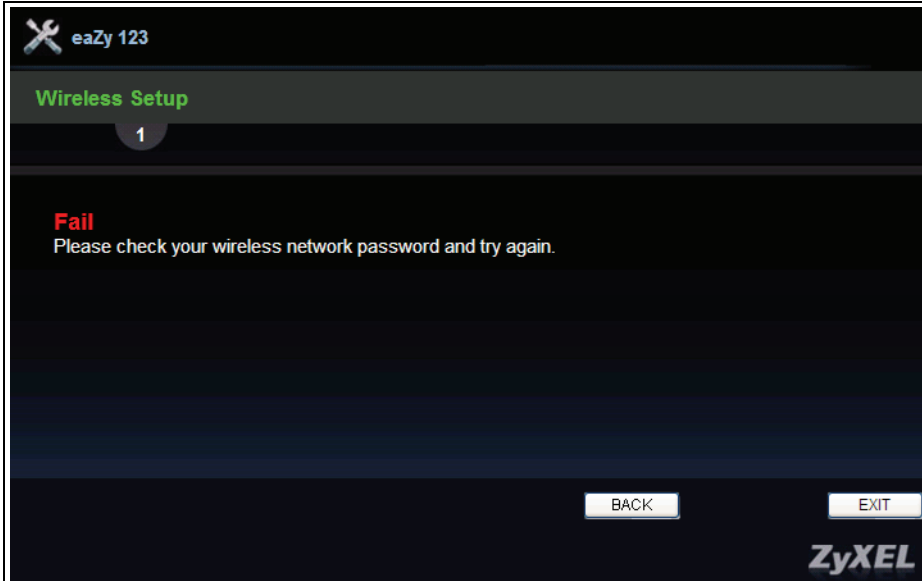

- 2 Click **Apply** to complete the wizard setup and restart the WRE2205.

Figure 11 Connection Wizard Complete

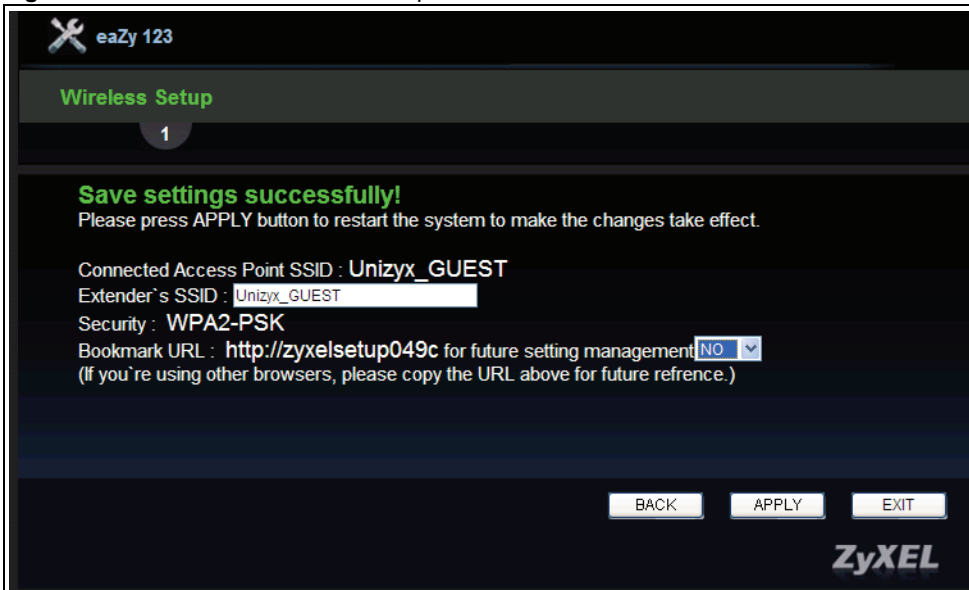

4.1 WRE2205 Status

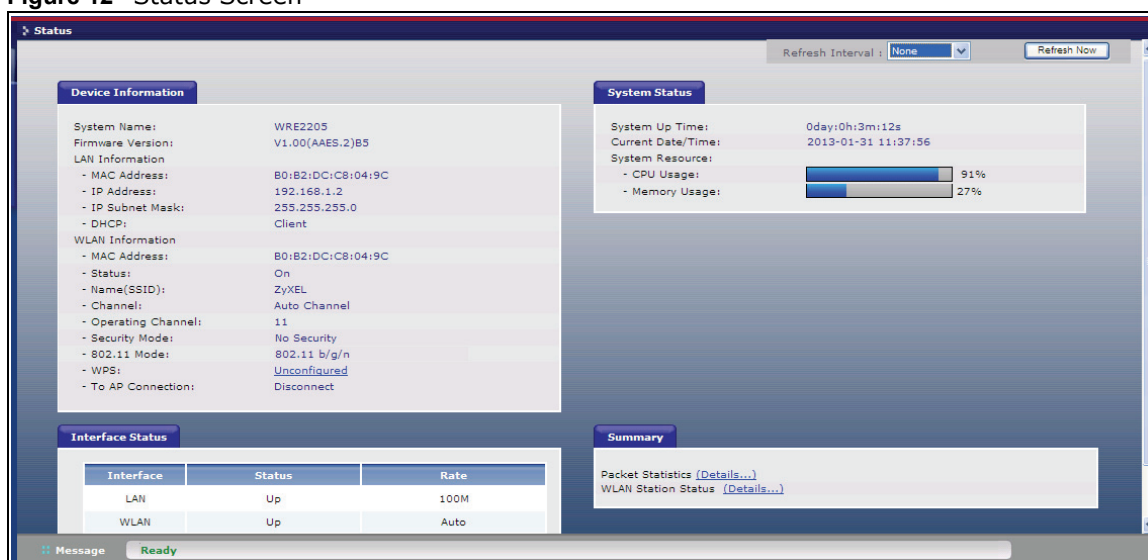

The screen below shows the status screen.

Figure 12 Status Screen



The following table describes the icons shown in the **Status** screen.

Table 6 Status Screen Icon Key

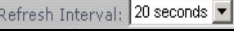
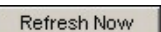
ICON	DESCRIPTION
	Click this icon to open the setup wizard.
	Click this icon to view copyright and a link for related product information.
	Select a number of seconds or None from the drop-down list box to refresh all screen statistics automatically at the end of every time interval or to not refresh the screen statistics.
	Click this button to refresh the status screen statistics.

The following table describes the labels shown in the **Status** screen.

Table 7 Web Configurator Status Screen

LABEL	DESCRIPTION
Device Information	
System Name	This is the System Name .

Table 7 Web Configurator Status Screen (continued)

LABEL	DESCRIPTION
Firmware Version	This is the current firmware version of the WRE2205.
LAN Information	
- MAC Address	This shows the LAN Ethernet adapter MAC Address of your device.
- IP Address	This shows the LAN port's IP address.
- IP Subnet Mask	This shows the LAN port's subnet mask.
- DHCP	This shows the LAN port's DHCP role.
WLAN Information	
- MAC Address	This shows the wireless adapter MAC Address of your device.
- Status	This shows the current status of the Wireless LAN - On or Off .
- Name (SSID)	This shows a descriptive name used to identify the WRE2205 in the wireless LAN.
- Channel	This shows the channel number which you select manually or the WRE2205 automatically scans and selects.
- Operating Channel	This shows the channel number which the WRE2205 is currently using over the wireless LAN.
- Security Mode	This shows the level of wireless security the WRE2205 is using.
- 802.11 Mode	This shows the wireless standard.
- WPS	This displays Configured when the WPS has been set up. This displays Unconfigured if the WPS has not been set up. Click the status to display Network > Wireless LAN > WPS screen.
- To AP Connection	This shows whether the WRE2205 is connected to an AP or not.
System Status	
System Up Time	This is the total time the WRE2205 has been on.
Current Date/Time	This field displays your WRE2205's present date and time.
System Resource	
- CPU Usage	This displays what percentage of the WRE2205's processing ability is currently used. When this percentage is close to 100%, the WRE2205 is running at full load, and the throughput is not going to improve anymore. If you want some applications to have more throughput, you should turn off other applications.
- Memory Usage	This shows what percentage of the heap memory the WRE2205 is using.
Interface Status	
Interface	This displays the WRE2205 port types. The port types are: LAN and WLAN .
Status	For the LAN port, this field displays Down (line is down) or Up (line is up or connected). For the WLAN, it displays Up when the WLAN is enabled or Down when the WLAN is disabled.
Rate	For the LAN ports, this displays the port speed and duplex setting or NA when the line is disconnected. For the WLAN, it displays the maximum transmission rate when the WLAN is enabled and NA when the WLAN is disabled or Auto .
Summary	
Packet Statistics	Use this screen to view port status and packet specific statistics.
WLAN Station Status	Use this screen to view the wireless stations that are currently associated to the WRE2205.

4.1.1 Summary: Packet Statistics

Click the **Packet Statistics (Details...)** hyperlink in the **Status** screen. Read-only information here includes port status, packet specific statistics and the "system up time". The **Poll Interval(s)** field is configurable and is used for refreshing the screen.

Figure 13 Summary: Packet Statistics

Port	Status	TxPkts	RxPkts	Collisions	Tx B/s	Rx B/s
LAN	100M	4990	4374	0	2926	324
WLAN	Auto	2279	56158	0	199	7811

System Up Time : 0day:0h:23m:40s

Poll Interval : 5 sec Set Interval Stop

The following table describes the labels in this screen.

Table 8 Summary: Packet Statistics

LABEL	DESCRIPTION
Port	This is the WRE2205's port type.
Status	For the LAN ports, this displays the port speed and duplex setting or Down when the line is disconnected. For the WLAN, it displays Up when the WLAN is enabled or Down when the WLAN is disabled or Auto .
TxPkts	This is the number of transmitted packets on this port.
RxPkts	This is the number of received packets on this port.
Collisions	This is the number of collisions on this port.
Tx B/s	This displays the transmission speed in bytes per second on this port.
Rx B/s	This displays the reception speed in bytes per second on this port.
System Up Time	This is the total time the WRE2205 has been on.
Poll Interval	Enter the time interval for refreshing statistics in this field.
Set Interval	Click this button to apply the new poll interval you entered in the Poll Interval field.
Stop	Click Stop to stop refreshing statistics.

4.1.2 Summary: WLAN Station Status

Click the **WLAN Station Status (Details...)** hyperlink in the **Status** screen. View the wireless stations that are currently associated to the WRE2205 in the **Association List**. Association means that a wireless client (for example, your network or computer with a wireless network card) has connected successfully to the AP (or wireless router) using the same SSID, channel and security settings.

Figure 14 Summary: WLAN Station Status

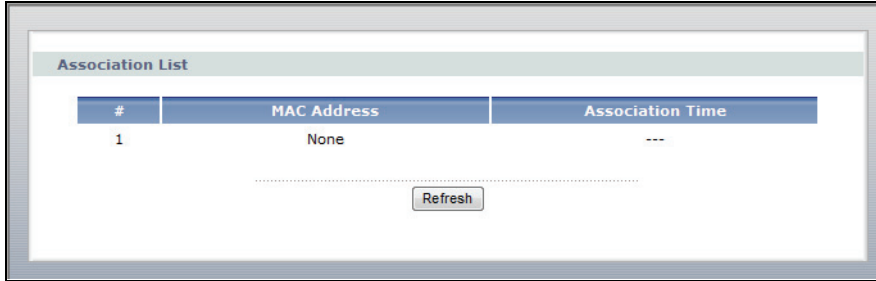

The following table describes the labels in this screen.

Table 9 Summary: WLAN Station Status

LABEL	DESCRIPTION
#	This is the index number of an associated wireless station.
MAC Address	This field displays the MAC address of an associated wireless station.
Association Time	This field displays the time a wireless station first associated with the WRE2205's WLAN network.
Refresh	Click Refresh to reload the list.

4.2 Navigation Panel

Use the menu in the navigation panel menus to configure WRE2205 features.

Figure 15 Menus



The following table describes the sub-menus.

Table 10 Menus

LINK	TAB	FUNCTION
Status		This screen shows the WRE2205's general device, system and interface status information. Use this screen to access the wizard, and summary statistics tables.
Network		

Table 10 Menus (continued)

LINK	TAB	FUNCTION
Wireless LAN	AP Select	Use this screen to connect to an access point.
	General	Use this screen to configure wireless LAN.
	MAC Address List	Use the MAC Address List screen to allow devices to access the WRE2205.
	Advanced	This screen allows you to configure advanced wireless settings.
	QoS	Use this screen to configure Wi-Fi Multimedia Quality of Service (WMM QoS). WMM QoS allows you to prioritize wireless traffic according to the delivery requirements of individual services.
	WPS	Use this screen to configure WPS.
	WPS Station	Use this screen to connect the WRE2205 to a wireless station or access point using WPS.
LAN	IP	Use this screen to configure LAN IP address, subnet mask and gateway.
Maintenance		
System	Password	Use this screen to change the password.
Tools	Firmware	Use this screen to upload firmware to your WRE2205.
	Configuration	Use this screen to backup and restore the configuration or reset the factory defaults to your WRE2205.
	Restart	This screen allows you to reboot the WRE2205 without turning the power off.
	LED	Use this screen to configure which LEDs are enabled or disabled.

5.1 Overview

This chapter provides tutorials for your WRE2205 as follows:

- Connecting a Wireless Client using WPS
 - [Push Button Configuration \(PBC\)](#)
 - [PIN Configuration](#)
- Connecting the WRE2205 to an AP
 - [Connecting to an AP with the WPS PBC Method](#)
 - [Connecting to an AP with the WPS PIN Method](#)
 - [Selecting an AP from an Automatically Detected List](#)
 - [Selecting an AP by Manually Entering Security Information](#)

5.2 Connecting a Wireless Client using WPS

This section gives you an example of how to connect a client to the WRE2205 using WPS.

There are two WPS methods for creating a secure connection. This tutorial shows you how to do both.

- **Push Button Configuration (PBC)** - create a secure wireless network by simply pressing the WPS button twice on the WRE2205's front panel or by clicking the **Start PBC** button in the **Network > Wireless LAN > WPS Station** screen. See [Section 5.2.1 on page 26](#). This is the easier method.
- **PIN Configuration** - create a secure wireless network simply by entering a wireless client's PIN (Personal Identification Number) in the WRE2205's interface. See [Section 5.2.2 on page 28](#). This is the more secure method, since one device can authenticate the other.

Note: The wireless client must be a WPS-aware device (for example, a WPS USB adapter or PCI card).

5.2.1 Push Button Configuration (PBC)

This section gives you an example of how to set up a wireless network using WPS PBC. This example uses the WRE2205 as the registrar and NWD210N as the wireless client in a notebook.

- 1 Make sure that your WRE2205 is turned on and that it is within range of your computer.

- 2 Make sure that you have installed the wireless client (this example uses the NWD210N) driver and utility in your notebook.
- 3 In the wireless client utility, find the WPS settings. Enable WPS and press the WPS button (**Start** or **WPS** button)
- 4 Log into WRE2205's Web Configurator and navigate to the **Network > Wireless LAN > WPS Station** screen.
- 5 In the WRE2205's Web Configurator, select **Registrar** in **Config Mode** and then press **Start PBC**.

Note: Your WRE2205 has a WPS button, as well as a **Start PBC** button in the Web Configurator. Both buttons have exactly the same function; you can use one or the other.

Note: It doesn't matter whether you press the button on the WRE2205 or the wireless client first. WPS times out after two minutes of pressing a button. Press the button on the second device within about a minute of the first, then wait two minutes for the WPS configuration to complete.

The WRE2205 sends the proper configuration settings to the wireless client. Then the wireless client is able to communicate with the WRE2205 securely.

The following figure shows an example of how to set up wireless network and security by pressing a button on both WRE2205 and wireless client (the NWD210N in this example).

Figure 16 Example WPS Process: PBC Method

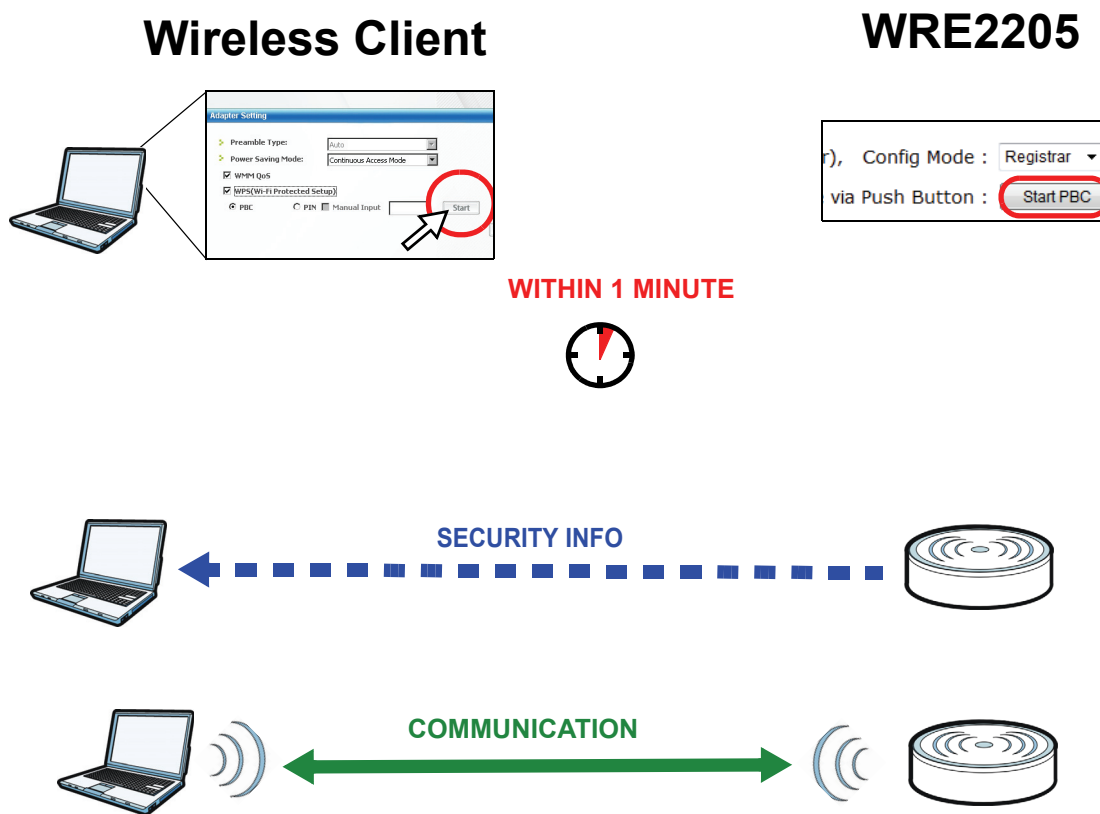

5.2.2 PIN Configuration

When you use the PIN configuration method, you need to use both WRE2205's configuration interface and the client's utilities.

- 1 Launch your wireless client's configuration utility. Go to the WPS settings and select the PIN method to get a PIN number.
- 2 On the WRE2205, navigate to the **Network > Wireless LAN > WPS Station** screen.
- 3 In the WRE2205's Web Configurator, select **Registrar** in **Config Mode**.
- 4 In the WRE2205's Web Configurator, enter the PIN number in the **Input client PIN code**.
- 5 Click the **Start** buttons (or the buttons next to the PIN fields) on both the wireless client utility screen and the WRE2205's **WPS Station** screen within about one minute, then wait two minutes for the WPS configuration to complete.

The WRE2205 authenticates the wireless client and sends the proper configuration settings to the wireless client. Then the wireless client is able to communicate with the WRE2205 securely.

The following figure shows an example of how to set up wireless network and security on WRE2205 and wireless client (ex. NWD210N in this example) by using PIN method.

Figure 17 Example WPS Process: PIN Method

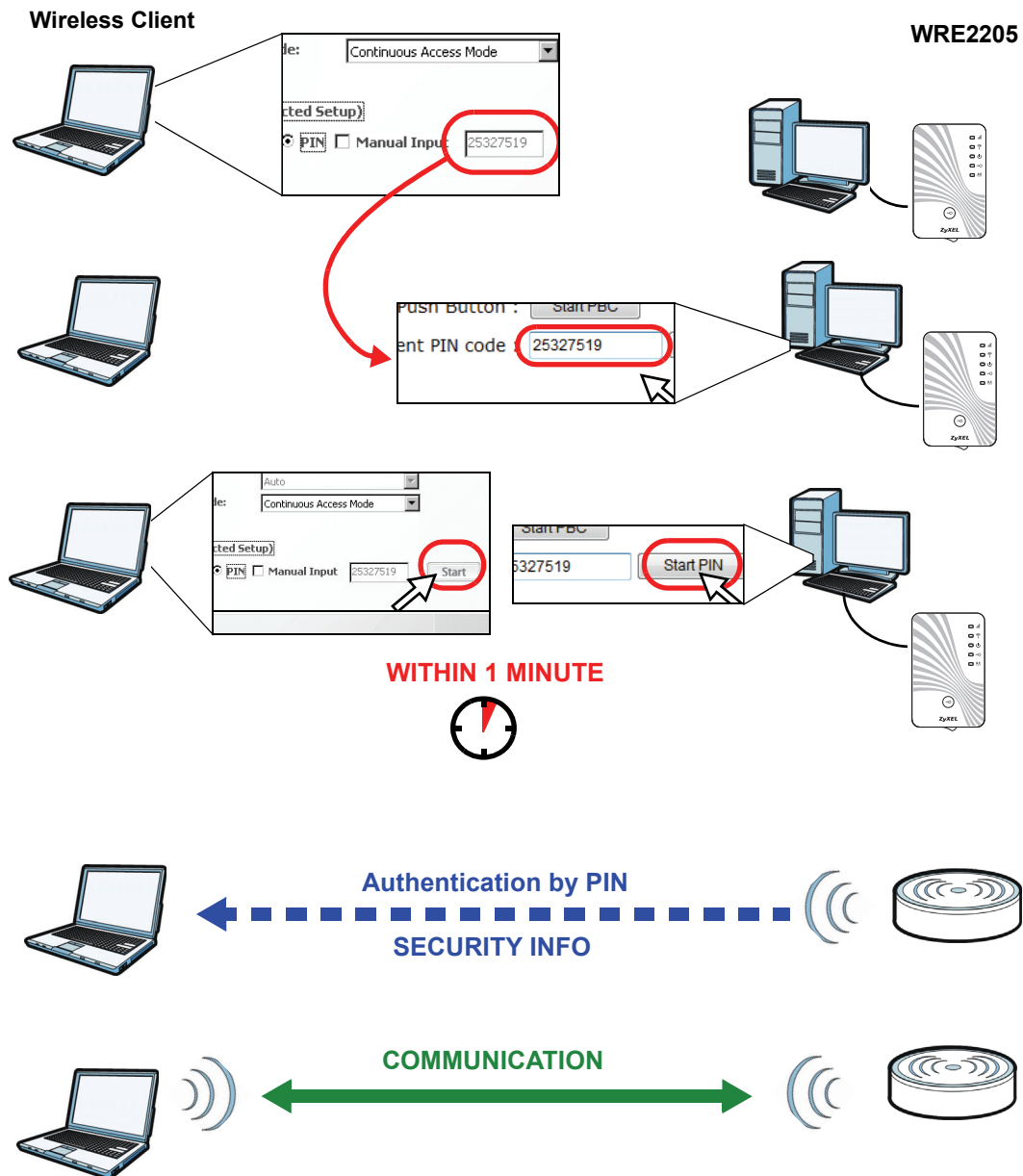

5.3 Connecting the WRE2205 to an AP

This section gives you an example of how to connect the WRE2205 to an AP.

There are four AP connection methods. This tutorial shows you how to use all of them.

- **Connecting to an AP with the WPS PBC method** - create a secure wireless network simply by pressing a button. See [Section 5.3.1 on page 30](#). This is the easier method.

- **Connecting to an AP with the WPS PIN method** - create a secure wireless network simply by entering the WRE2205's PIN (Personal Identification Number) in the AP's interface. See [Section 5.3.2 on page 31](#). This is the more secure method, since one device can authenticate the other.
- **Selecting an AP from an Automatically Detected List** - create a secure wireless network simply by selecting an AP from a list of detected APs. See [Section 5.3.3 on page 32](#). This is the easier method.
- **Selecting an AP by Manually Entering Security Information** - create a secure wireless network by manually entering the AP's wireless security settings in the WRE2205's interface. See [Section 5.3.4 on page 34](#). This is useful when the AP is hidden.

5.3.1 Connecting to an AP with the WPS PBC Method

This section gives you an example of how to connect to an AP using WPS PBC. This example uses the WRE2205 as the enrollee and an AP as the registrar.

- 1 Make sure that your WRE2205 is turned on and that it is within range of the AP.
- 2 Make sure that you have installed the AP and have access to the configuration interface of the AP or the AP's WPS button.
- 3 Log into WRE2205's Web Configurator and navigate to the **Network > Wireless LAN > WPS Station** screen. Select **Enrollee** in **Config Mode** and press **Start PBC**.
- 4 In the configuration interface of the AP, find the WPS settings. Enable WPS and press the WPS button (**Start** or **WPS** button)

Note: Your WRE2205 has a WPS button located on its panel, as well as a WPS button in its configuration utility. Both buttons have exactly the same function; you can use one or the other.

Note: It doesn't matter whether you press the button on the WRE2205 or the AP first. WPS times out after two minutes of pressing a button. Press the button on the second device within about a minute of the first, then wait two minutes for the WPS configuration to complete.

The AP sends the proper configuration settings to the WRE2205. Then the WRE2205 is able to communicate with the AP securely.

The following figure shows an example of how to set up wireless network and security by pressing a button on both WRE2205 and AP.

Figure 18 Example Connection to AP using WPS: PBC Method

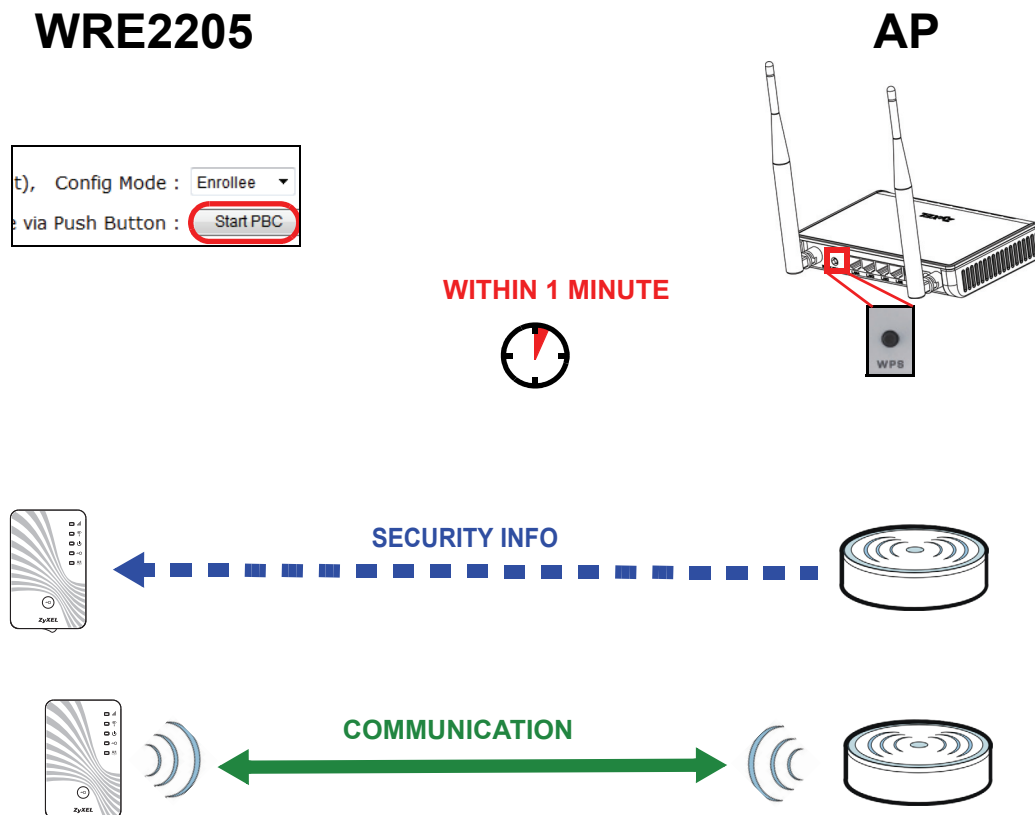

5.3.2 Connecting to an AP with the WPS PIN Method

When you use the PIN configuration method, you need to use both the configuration interface of the AP and the WRE2205's configuration interface.

- 1 Log into WRE2205's Web Configurator and navigate to the **Network > Wireless LAN > WPS Station** screen. Select **Enrollee** in **Config Mode** to get a PIN number.
- 2 Enter the PIN number in the WPS PIN field of the AP's configuration interface.
- 3 Click the **Start PIN** button on the WRE2205 and the Start button (or the button next to the PIN field) on the AP's configuration interface within about one minute, then wait two minutes for the WPS configuration to complete.

The AP authenticates the WRE2205 and sends the proper configuration settings to the WRE2205. This may take up to two minutes. Then the WRE2205 is able to communicate with the AP securely.

The following figure shows an example of how to set up wireless network and security on the AP and WRE2205 by using PIN method.

Figure 19 Example Connection to AP using WPS: PIN Method

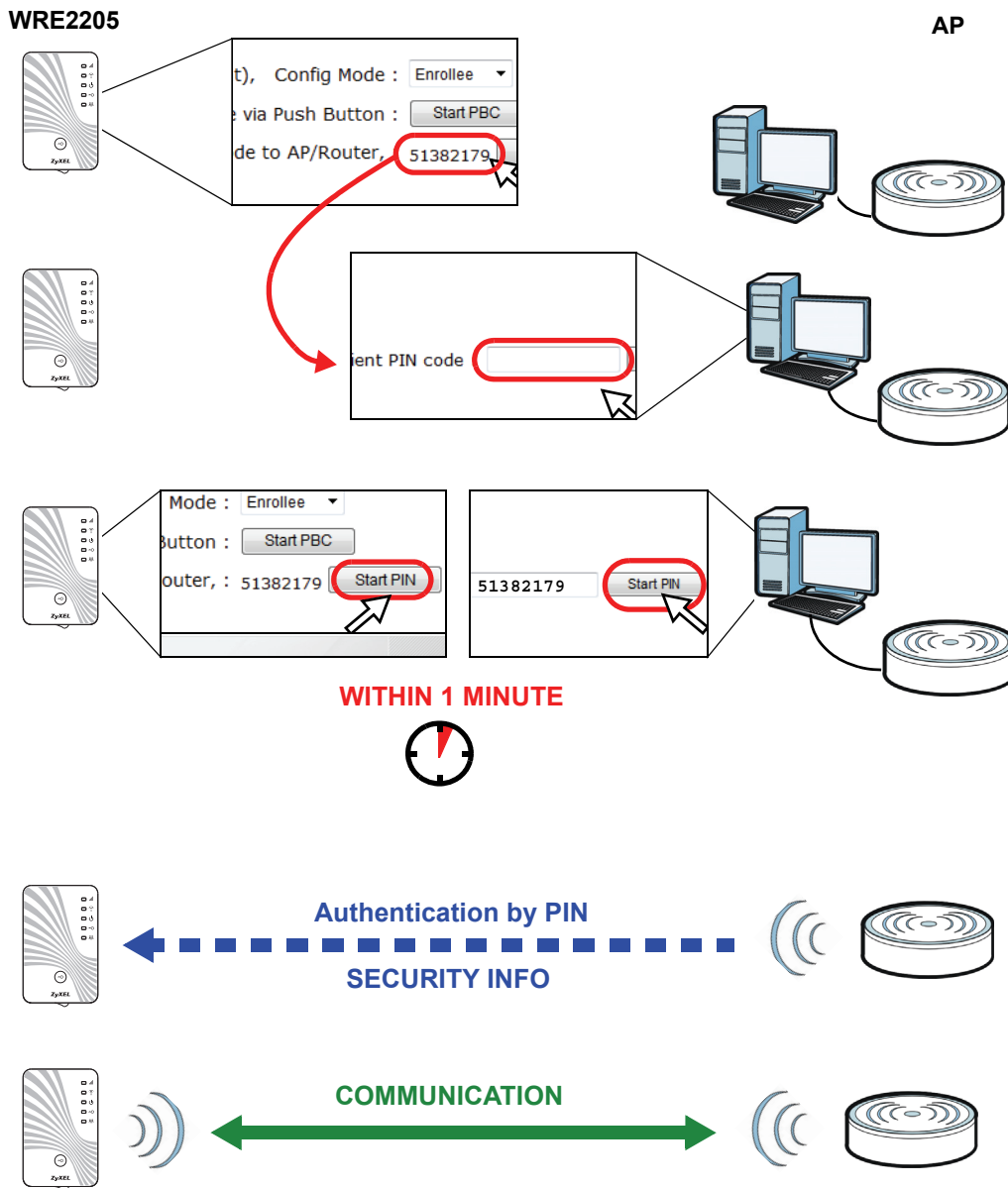

5.3.3 Selecting an AP from an Automatically Detected List

Follow the steps below to create a secure wireless network by selecting an AP from a list of detected APs.

The instructions require that your hardware is connected (see the Quick Start Guide) and you are logged into the Web Configurator through your LAN connection (see [Section 2.2 on page 13](#)).

- 1 Select an AP from the **Select** column and click **Next**.

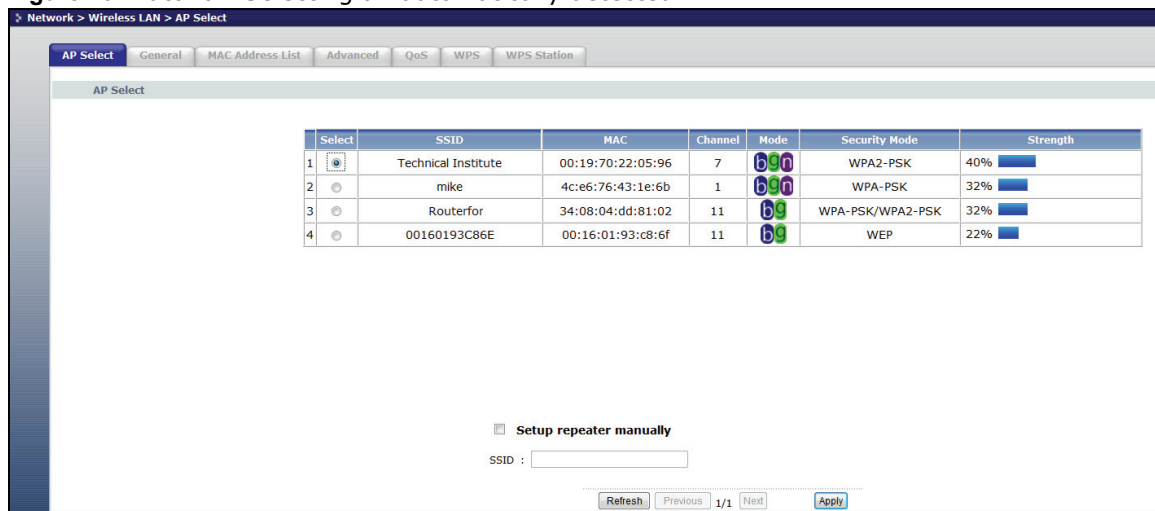
Figure 20 Tutorial: Selecting an automatically detected AP

- 2 Type a key into the **KEY** field and click **Next**.

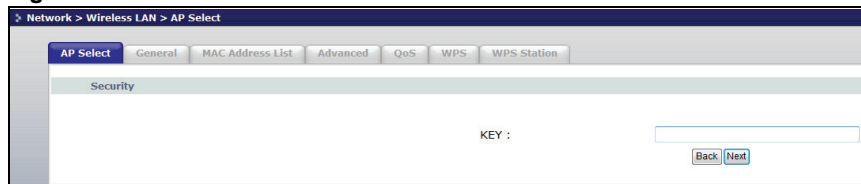
Figure 21 Tutorial: The KEY field

- 3 Wait for the WRE2205 to verify the key with the AP.

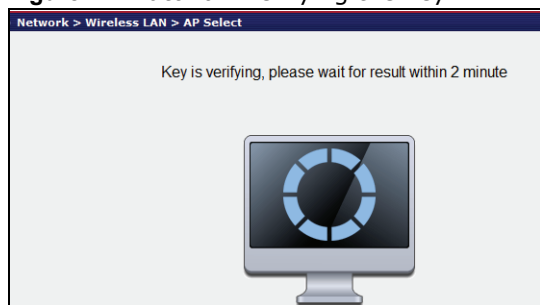
Figure 22 Tutorial: Verifying the key

- 4 When the key is verified, click **Next**.

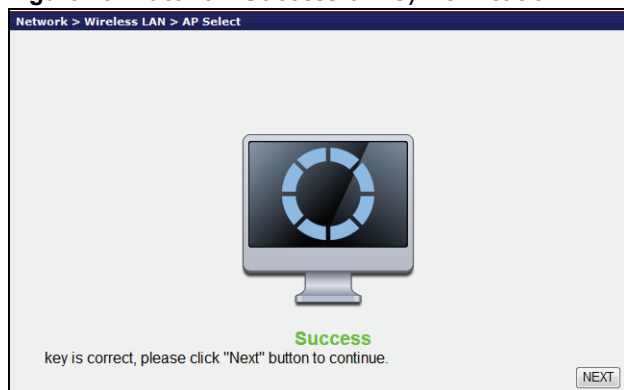
Figure 23 Tutorial: Successful key verification

- Click **APPLY** to save settings and restart the WRE2205. Click **CONTINUE** to go to the Status screen without saving the settings and restarting the WRE2205.

Figure 24 Tutorial: Saving settings

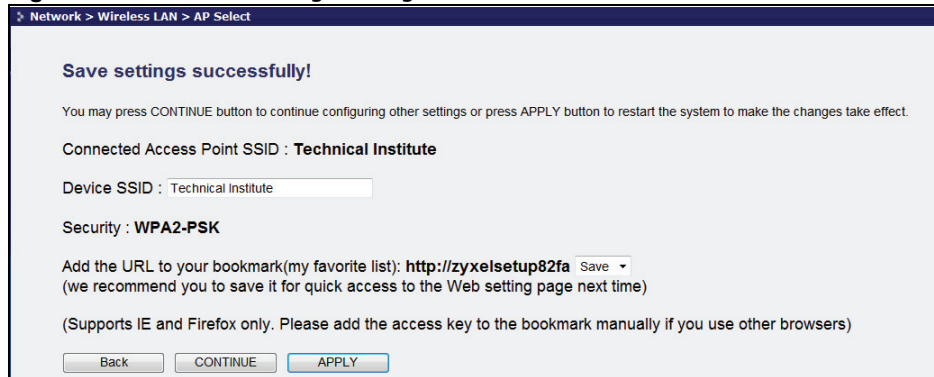

5.3.4 Selecting an AP by Manually Entering Security Information

This example shows you how to configure wireless security settings with the following parameters on your WRE2205.

SSID	ExampleSSID
Channel	7
Security	WPA2 PSK

Follow the steps below to create a secure wireless network by manually entering the AP's wireless security settings in the WRE2205's interface.

The instructions require that your hardware is connected (see the Quick Start Guide) and you are logged into the Web Configurator through your LAN connection (see [Section 2.2 on page 13](#)).

- Select **Setup repeater manually**.
- Type the SSID of the AP into the **SSID** field and click **Next**.

Figure 25 Tutorial: Typing an SSID

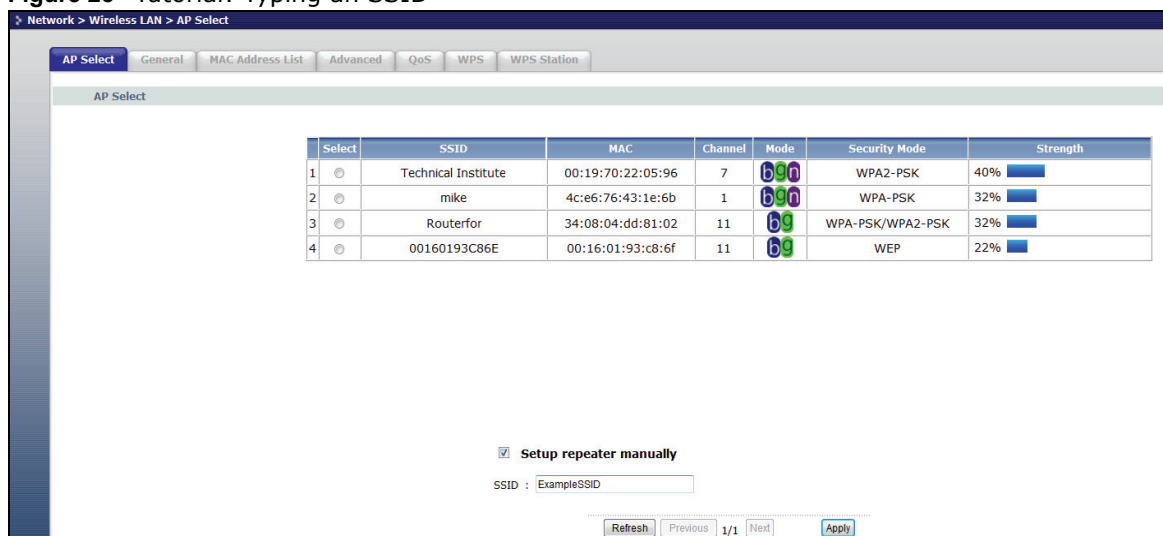

- 3 Select the security settings and click **Next**.

Figure 26 Tutorial: Security Settings

Network > Wireless LAN > AP Select

AP Select General MAC Address List Advanced QoS WPS WPS Station

Security

- Select SSID
- Security Settings

SSID choice : ExampleSSID

Encryption : WPA pre-shared key

WPA Unicast Cipher Suite : WPA(TKIP) WPA2(AES) WPA2 Mixed

Pre-shared Key Format : Passphrase

Pre-shared Key :

Channel : 7

APPLY CANCEL

- 4 Click **Apply** to save settings and restart the WRE2205. Click **CONTINUE** to go to the Status screen without saving the settings and restarting the WRE2205.

Figure 27 Tutorial: Saving settings

Network > Wireless LAN > AP Select

Save settings successfully!

You may press CONTINUE button to continue configuring other settings or press APPLY button to restart the system to make the changes take effect.

device SSID : **Technical Institute**

Security : **WPA-shared key**

Add the URL to your bookmark(my favorite list): <http://zyxelsetup82fa> Save

(we recommend you to save it for quick access to the Web setting page next time)

(Supports IE and Firefox only. Please add the access key to the bookmark manually if you use other browsers)

Back CONTINUE APPLY

PART II

Technical Reference

Wireless LAN

6.1 Overview

This chapter discusses how to configure the wireless network settings in your WRE2205. See [Section 1.1 on page 9](#) for an overview of wireless networks.

6.2 What You Can Do

- Use the **General** screen to enable the Wireless LAN, enter the SSID and select the wireless security mode ([Section 6.4 on page 40](#)).
- Use the **MAC Address List** screen to allow or deny wireless stations based on their MAC addresses from connecting to the WRE2205 ([Section 6.5 on page 41](#)).
- Use the **Advanced** screen to allow intra-BSS networking and set the RTS/CTS Threshold ([Section 6.6 on page 42](#)).
- Use the **QoS** screen to enable Wifi MultiMedia Quality of Service (WMM QoS). WMM QoS prioritizes traffic using pre-defined voice, video, best-effort and background priorities ([Section 6.7 on page 43](#)).
- Use the **WPS** screen to quickly set up a wireless network with strong security, without having to configure security settings manually ([Section 6.8 on page 43](#)).
- Use the **WPS Station** screen to add a wireless station using WPS ([Section 6.9 on page 44](#)).
- Use the **AP Select** screen to choose an access point that you want the WRE2205 to connect to. You should know the security settings of the target AP ([Section 6.10 on page 45](#)).

6.3 What You Should Know

Every wireless network must follow these basic guidelines.

- Every wireless client in the same wireless network must use the same SSID.
The SSID is the name of the wireless network. It stands for Service Set IDentity.
- If two wireless networks overlap, they should use different channels.
Like radio stations or television channels, each wireless network uses a specific channel, or frequency, to send and receive information.
- Every wireless client in the same wireless network must use security compatible with the AP.
Security stops unauthorized devices from using the wireless network. It can also protect the information that is sent in the wireless network.

6.3.1 Wireless Security Overview

The following sections introduce different types of wireless security you can set up in the wireless network.

6.3.1.1 MAC Address List

Every wireless client has a unique identification number, called a MAC address.¹ A MAC address is usually written using twelve hexadecimal characters²; for example, 00A0C5000002 or 00:A0:C5:00:00:02. To get the MAC address for each wireless client, see the appropriate User's Guide or other documentation.

You can use the MAC Address List to tell the AP which wireless clients are allowed to use the wireless network. If a wireless client is allowed to use the wireless network, it still has to have the correct settings (SSID, channel, and security). If a wireless client is not allowed to use the wireless network, it does not matter if it has the correct settings.

This type of security does not protect the information that is sent in the wireless network. Furthermore, there are ways for unauthorized devices to get the MAC address of an authorized wireless client. Then, they can use that MAC address to use the wireless network.

6.3.1.2 Encryption

Wireless networks can use encryption to protect the information that is sent in the wireless network. Encryption is like a secret code. If you do not know the secret code, you cannot understand the message.

Table 11 Types of Encryption for Each Type of Authentication

	NO AUTHENTICATION
Weakest	No Security
↕	Static WEP
↕	WPA-PSK
Strongest	WPA2-PSK

For example, if users do not log in to the wireless network, you can choose no authentication, if users do log on to the wireless network, you can choose No Security, **Static WEP**, **WPA-PSK**, or **WPA2-PSK**.

Usually, you should set up the strongest encryption that every wireless client in the wireless network supports. Suppose the wireless network has two wireless clients. Device A only supports WEP, and device B supports WEP and WPA-PSK. Therefore, you should set up **Static WEP** in the wireless network.

Note: It is recommended that wireless networks use WPA-PSK, or stronger encryption. IEEE 802.1x and WEP encryption are better than none at all, but it is still possible for unauthorized devices to figure out the original information pretty quickly.

1. Some wireless devices, such as scanners, can detect wireless networks but cannot use wireless networks. These kinds of wireless devices might not have MAC addresses.
2. Hexadecimal characters are 0, 1, 2, 3, 4, 5, 6, 7, 8, 9, A, B, C, D, E, and F.

Many types of encryption use a key to protect the information in the wireless network. The longer the key, the stronger the encryption. Every wireless client in the wireless network must have the same key.

6.3.1.3 WPS

WiFi Protected Setup (WPS) is an industry standard specification, defined by the WiFi Alliance. WPS allows you to quickly set up a wireless network with strong security, without having to configure security settings manually. Depending on the devices in your network, you can either press a button (on the device itself, or in its configuration utility) or enter a PIN (Personal Identification Number) in the devices. Then, they connect and set up a secure network by themselves. See how to set up a secure wireless network using WPS in the [Section 5.2 on page 26](#).

6.4 General Wireless LAN Screen

Use this screen to enable the Wireless LAN, enter the SSID and select the wireless security mode.

Note: If you are configuring the WRE2205 from a computer connected to the wireless LAN and you change the WRE2205's SSID, channel or security settings, you will lose your wireless connection when you press **Apply** to confirm. You must then change the wireless settings of your computer to match the WRE2205's new settings.

Click **Network > Wireless LAN** to open the **General** screen.

Figure 28 Network > Wireless LAN > General

The following table describes the general wireless LAN labels in this screen.

Table 12 Network > Wireless LAN > General

LABEL	DESCRIPTION
WLAN STA Information	This shows the wireless and security settings of the selected AP wireless network.
SSID	This displays the Service Set IDentity of the wireless device to which you are connecting.
WLAN AP Information / Wireless Setup	Use this section to configure the wireless settings between the WRE2205 and its wireless clients.
Name(SSID)	(Service Set IDentity) The SSID identifies the Service Set with which a wireless station is associated. Wireless stations associating to the access point (AP) must have the same SSID. Enter a descriptive name (up to 32 printable 7-bit ASCII characters) for the wireless LAN.

Table 12 Network > Wireless LAN > General (continued)

LABEL	DESCRIPTION
Hide SSID	Select this check box to hide the SSID in the outgoing beacon frame so a station cannot obtain the SSID through scanning using a site survey tool.
Operating Channel	This displays the channel the WRE2205 is currently using.
Apply	Click Apply to save your changes back to the WRE2205.
Reset	Click Reset to reload the previous configuration for this screen.

6.5 MAC Address List

The MAC Address List screen allows you to specify which devices are allowed to access the WRE2205, while denying access to all unspecified devices. Every Ethernet device has a unique MAC (Media Access Control) address. The MAC address is assigned at the factory and consists of six pairs of hexadecimal characters, for example, 00:A0:C5:00:00:02. You need to know the MAC address of the devices to configure this screen.

To change your WRE2205's MAC Address List settings, click **Network > Wireless LAN > MAC Address List**. The screen appears as shown.

Figure 29 Network > Wireless LAN > MAC Address List

Network > Wireless LAN > MAC Address List

AP Select General **MAC Address List** Advanced QoS WPS WPS Station

MAC Address List

For security reason, the Wireless Repeater features MAC Address Filtering that only allows authorized MAC Addresses associating to the Wireless Repeater.

Active

Set	MAC Address
1	00:00:00:00:00:00
2	00:00:00:00:00:00
3	00:00:00:00:00:00
4	00:00:00:00:00:00
5	00:00:00:00:00:00
6	00:00:00:00:00:00
7	00:00:00:00:00:00
8	00:00:00:00:00:00
9	00:00:00:00:00:00
10	00:00:00:00:00:00
11	00:00:00:00:00:00
12	00:00:00:00:00:00
13	00:00:00:00:00:00
14	00:00:00:00:00:00
15	00:00:00:00:00:00
16	00:00:00:00:00:00

Apply Reset

The following table describes the labels in this menu.

Table 13 Network > Wireless LAN > MAC Address List

LABEL	DESCRIPTION
Active	Select this to enable MAC address filtering.
Set	This is the index number of the MAC address.
MAC Address	Enter the MAC addresses of the wireless station that are allowed access to the WRE2205 in these address fields. Enter the MAC addresses in a valid MAC address format, that is, six hexadecimal character pairs, for example, 12:34:56:78:9a:bc.
Apply	Click Apply to save your changes back to the WRE2205.
Reset	Click Reset to reload the previous configuration for this screen.

6.6 Wireless LAN Advanced Screen

Use this screen to configure advanced wireless LAN parameters.

Click **Network > Wireless LAN > Advanced**. The screen appears as shown.

Figure 30 Network > Wireless LAN > Advanced

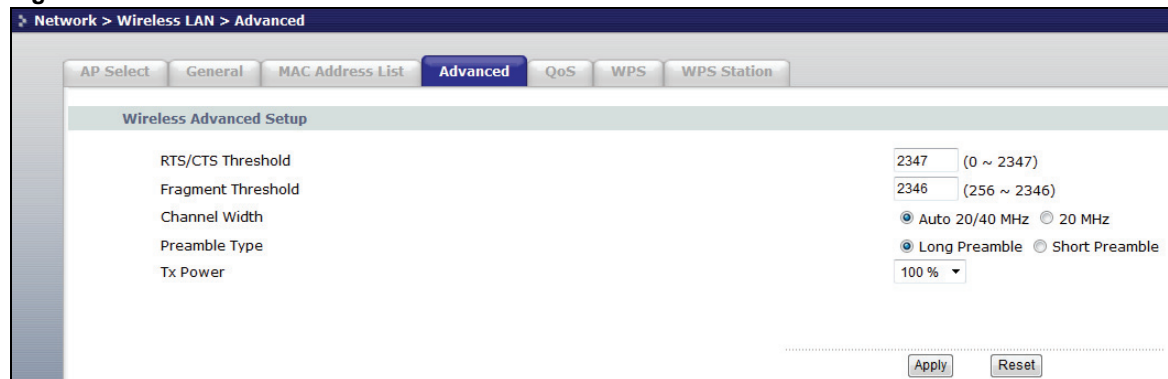

The following table describes the labels in this screen.

Table 14 Network > Wireless LAN > Advanced

LABEL	DESCRIPTION
Wireless Advanced Setup	
RTS/CTS Threshold	Data with its frame size larger than this value will perform the RTS (Request To Send)/CTS (Clear To Send) handshake. Enter a value between 0 and 2347 .
Fragmentation Threshold	The threshold (number of bytes) for the fragmentation boundary for directed messages. It is the maximum data fragment size that can be sent. Enter an even number between 256 and 2346 .
Channel Width	Select whether the WRE2205 uses a wireless channel width of 20MHz or Auto 20/40MHz. A standard 20MHz channel offers transfer speeds of up to 150Mbps whereas a 40MHz channel uses two standard channels and offers speeds of up to 300 Mbps. Because not all devices support 40MHz channels, select Auto 20/40MHz to allow the WRE2205 to adjust the channel bandwidth automatically.

Table 14 Network > Wireless LAN > Advanced (continued)

LABEL	DESCRIPTION
Preamble Type	A preamble affects the timing in your wireless network. There are two preamble modes: long and short. If a device uses a different preamble mode than the WRE2205 does, it cannot communicate with the WRE2205.
Tx Power	This field controls the transmission power of the WRE2205. When using the WRE2205 with a notebook computer, select a lower transmission power level when you are close to the AP in order to conserve battery power.
Apply	Click Apply to save your changes to the WRE2205.
Reset	Click Reset to reload the previous configuration for this screen.

6.7 Quality of Service (QoS) Screen

Use the **QoS** screen to enable Wifi MultiMedia Quality of Service (WMM QoS). WMM QoS prioritizes traffic using pre-defined voice, video, best-effort and background priorities.

Click **Network > Wireless LAN > QoS**. The following screen appears.

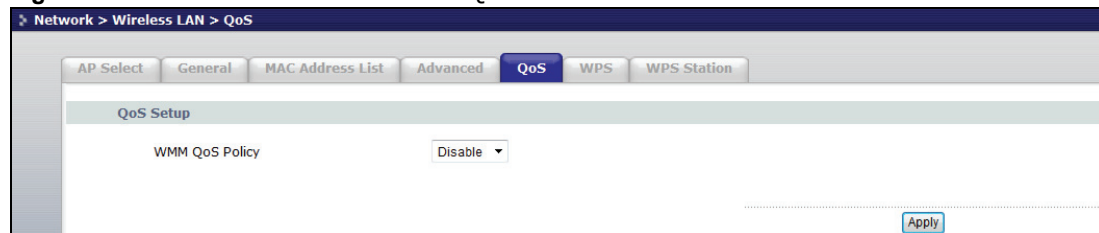
Figure 31 Network > Wireless LAN > QoS

The following table describes the labels in this screen.

Table 15 Network > Wireless LAN > QoS

LABEL	DESCRIPTION
WMM QoS Policy	Enable this to have the WRE2205 automatically give a service a priority level according to the ToS value in the IP header of packets it sends. WMM QoS (Wifi MultiMedia Quality of Service) gives high priority to voice and video, which makes them run more smoothly.
Apply	Click Apply to save your changes to the WRE2205.

6.8 WPS Screen

Use this screen to enable/disable WPS, view or generate a new PIN and check current WPS status. To open this screen, click **Network > Wireless LAN > WPS** tab.

Figure 32 Network > Wireless LAN > WPS

The following table describes the labels in this screen.

Table 16 Network > Wireless LAN > WPS

LABEL	DESCRIPTION
WPS Setup	
Enable WPS	Select this to enable the WPS feature.
PIN Number	This displays a PIN number last time system generated. Click Generate to generate a new PIN number.
WPS Status	
Status	This displays Configured when the WRE2205 has connected to a wireless network using WPS or when Enable WPS is selected and wireless or wireless security settings have been changed. The current wireless and wireless security settings also appear in the screen. This displays Unconfigured if WPS is disabled and there are no wireless or wireless security changes on the WRE2205 or you click Release_Configuration to remove the configured wireless and wireless security settings.
Release Configuration	This button is only available when the WPS status displays Configured . Click this button to remove all configured wireless and wireless security settings for WPS connections on the WRE2205.
Apply	Click Apply to save your changes back to the WRE2205.
Refresh	Click Refresh to get this screen information afresh.

6.9 WPS Station Screen

Use this screen when you want to add a wireless station using WPS.

Note: WPS can only be configured between two devices at a time. For example if devices A and B are first configured using WPS, then use either A or B to configure device C using WPS.

To open this screen, click **Network > Wireless LAN > WPS Station** tab.

Note: WPS times out after two minutes of pressing a button. Press the button on the second device within about a minute of the first, then wait two minutes for the WPS configuration to complete.

To add the second wireless station, you have to press these buttons on both device and the wireless station again after the first 2 minutes.

Figure 33 Network > Wireless LAN > WPS Station

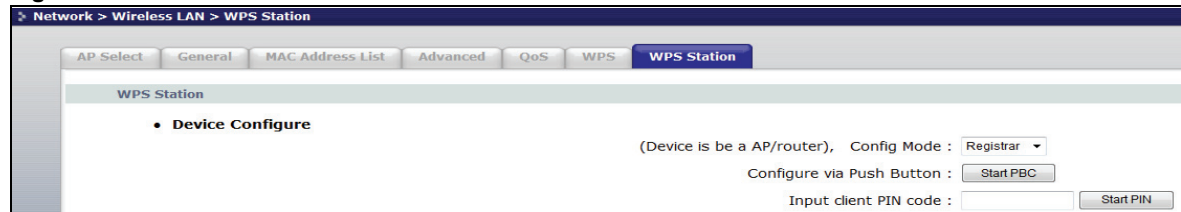

The following table describes the labels in this screen.

Table 17 Network > Wireless LAN > WPS Station

LABEL	DESCRIPTION
Config Mode	Use this to select Registrar or Enrollee mode. Select Registrar mode to make wireless clients follow the wireless settings of the WRE2205. Select Enrollee mode to make the WRE2205 follow the wireless settings of an access point.
Push Button	Use this button when you use the PBC (Push Button Configuration) method to configure wireless stations's wireless settings. See Section 5.2.1 on page 26 . Click this to start WPS-aware wireless station scanning and the wireless security information synchronization.
Input station's PIN number	Use this button when you use the PIN Configuration method to configure wireless station's wireless settings. See Section 5.2.2 on page 28 . Type the same PIN number generated in the wireless station's utility. Then click Start to associate to each other and perform the wireless security information synchronization.

6.10 AP Select Screen

Use this screen to choose an access point that you want the WRE2205 to connect to. You should know the security settings of the target AP.

To open this screen, click **Network > Wireless LAN > AP Select** tab.

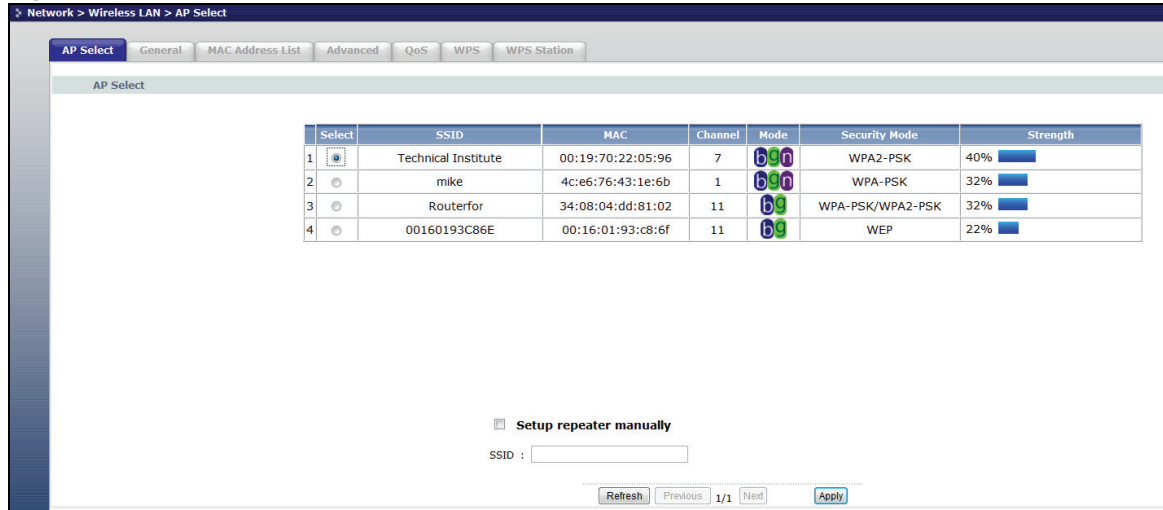
Figure 34 Network > Wireless LAN > AP Select

The following table describes the labels in this screen.

Table 18 Network > Wireless LAN > AP Select

LABEL	DESCRIPTION
Select	Use the radio button to select the wireless device to which you want to connect.
SSID	This displays the Service Set IDentity of the wireless device. The SSID is a unique name that identifies a wireless network. All devices in a wireless network must use the same SSID.
MAC	This displays the MAC address of the wireless device.
Channel	This displays the channel number used by this wireless device.
Mode	This displays which IEEE 802.11b/g/n wireless networking standards the wireless device supports.
Security Mode	This displays the type of security configured on the wireless device. When no is shown, no security is configured and you can connect to it without a password.
Strength	This displays the strength of the wireless signal. The signal strength mainly depends on the antenna output power and the distance between your WRE2205 and this device.
Setup repeater manually	Select this to setup the AP manually.
SSID	If Setup repeater manually is selected, use this field to type the SSID of the AP. This is useful when the AP's SSID is hidden.
Refresh	Click this to search for available wireless devices within transmission range and update this table.
Previous	Click this to see the previous page of APs.
Next	Click this to see the next page of APs.
Apply	Click this to start the next step in the AP setup process.

7.1 Overview

This screen allows you to assign the WRE2205 a fixed or dynamic IP address. The default IP address is 192.168.1.2. In initial configuration, the WRE2205 acts as a DHCP server, so it can assign your computer an IP address in the same network range as the default IP. After the WRE2205 connects to an AP, the DHCP server function is disabled and your computer gets its IP from the AP. If the AP connection is dropped, connect to the WRE2205 again using the default domain name, <http://zyxelsetupxxxx> where xxxx is the last four numbers of the MAC address. The MAC address can be found on a label on the product.

7.2 What You Need To Know

The LAN parameters of the WRE2205 are preset in the factory with the following values:

- IP address of 192.168.1.2 with subnet mask of 255.255.255.0 (24 bits)

7.3 LAN IP Screen

Use this screen to change your basic LAN settings. Click **Network > LAN**.

Figure 35 Network > LAN > IP

The screenshot shows the 'Network > LAN > IP' configuration page. At the top, there is a breadcrumb trail 'Network > LAN > IP' and a blue 'IP' button. Below this is a 'LAN TCP/IP' section with two radio buttons: 'Get from DHCP Server' (selected) and 'User Defined LAN IP'. Under 'User Defined LAN IP', there are three input fields: 'IP Address' (192.168.2.254), 'IP Subnet Mask' (255.255.255.0), and 'Gateway'. At the bottom right, there are 'Apply' and 'Reset' buttons.

The following table describes the labels in this screen.

Table 19 Network > LAN > IP

LABEL	DESCRIPTION
Get from DHCP Server	Select this to have the WRE2205 get a dynamic IP address from a DHCP server.
User Defined LAN IP	Click this to enable the manual IP configuration.
IP Address	Type the IP address of your WRE2205 in dotted decimal notation 192.168.1.2 (factory default).
IP Subnet Mask	The subnet mask specifies the network number portion of an IP address.
Apply	Click Apply to save your changes back to the WRE2205.
Reset	Click Reset to begin configuring this screen afresh.

8.1 Overview

This chapter provides information on the **System** screen.

8.2 What You Can Do

Use the **Password** screen to set the password ([Section 8.3 on page 49](#)).

8.3 System Password Screen

Use this screen to set the web configurator password. Click **Maintenance > System**. The following screen displays.

Figure 36 Maintenance > System > Password

The following table describes the labels in this screen.

Table 20 Maintenance > System > Password

LABEL	DESCRIPTION
Password Setup	Change your WRE2205's password (recommended) using the fields as shown.
Old Password	Type the default password or the existing password you use to access the system in this field.
New Password	Type your new system password (up to 30 characters). Note that as you type a password, the screen displays an asterisk (*) for each character you type.
Retype to Confirm	Type the new password again in this field.
Apply	Click Apply to save your changes back to the WRE2205.
Reset	Click Reset to begin configuring this screen afresh.

9.1 Overview

This chapter shows you how to upload a new firmware, upload or save backup configuration files, restart the WRE2205 and configure LEDs.

9.2 What You Can Do

- Use the **Firmware** screen to upload firmware to your WRE2205 ([Section 9.3 on page 50](#)).
- Use the **Configuration** screen to view information related to factory defaults, backup configuration, and restore configuration ([Section 9.4 on page 52](#)).
- Use the **Restart** screen to have the WRE2205 reboot ([Section 9.5 on page 54](#)).
- Use the **LED** screen to configure the LEDs ([Section 9.6 on page 54](#)).

9.3 Firmware Upload Screen

Find firmware at www.zyxel.com in a file that (usually) uses the system model name with a “*.bin” extension, e.g., “WRE2205.bin”. The upload process uses HTTP (Hypertext Transfer Protocol) and may take up to two minutes. After a successful upload, the system will reboot.

Click **Maintenance > Tools**. Follow the instructions in this screen to upload firmware to your WRE2205.

Figure 37 Maintenance > Tools > Firmware

The following table describes the labels in this screen.

Table 21 Maintenance > Tools > Firmware

LABEL	DESCRIPTION
Firmware Upgrade	Use this section if you have already manually downloaded new firmware from the website. Remember that you must decompress compressed (.zip) files before you can upload them.
File Path	Click Choose File to find the location of the firmware .bin file you want to upload.
Upload	Click Upload to begin the upload process. This process may take up to two minutes.
On-line Firmware Upgrade	Use this section if you have want to check for new firmware on the website and the WRE2205 has an Internet connection.
Check for latest Firmware Now	The following fields display when you click this button.
You are currently using firmware version:	The firmware version consists of the trunk version number, model code, and release number. For example, V1.00(AAAG.5) means V1.00 is the trunk number, AAAG represents WRE2205, and 5 means the fifth release.
The Latest Firmware Version	Compare the release number in the previous field with the release number in this one to see if you have the latest firmware. In this example, V1.00(AAAG.5), the numbers are the same (5), so the WRE2205 already has the latest firmware.
Release Date	The date the firmware was issued is shown in year-month-date format.
Release Note	The release note shows what has changed (new features, bug fixes, known issues) in this firmware version. Check the Release Note before deciding to use new firmware.
Size	This is the size of the firmware in bytes. 15073234 is about 15 MB.
Do_Firmware_Upgrade	Click this button to download and upgrade the new firmware to the WRE2205.

Note: Do not turn off the WRE2205 while firmware upload is in progress!

After you see the **Firmware Upgrading** screen, wait until the upgrade process is complete.

Figure 38 Firmware Upgrading

The WRE2205 automatically restarts in this time causing a temporary network disconnect. In some operating systems, you may see the following icon on your desktop.

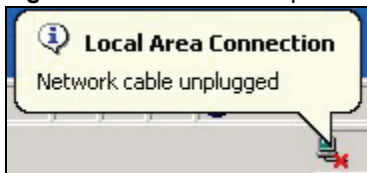
Figure 39 Network Temporarily Disconnected

After the WRE2205 restarts, the **Upgrade Accomplished** screen appears.

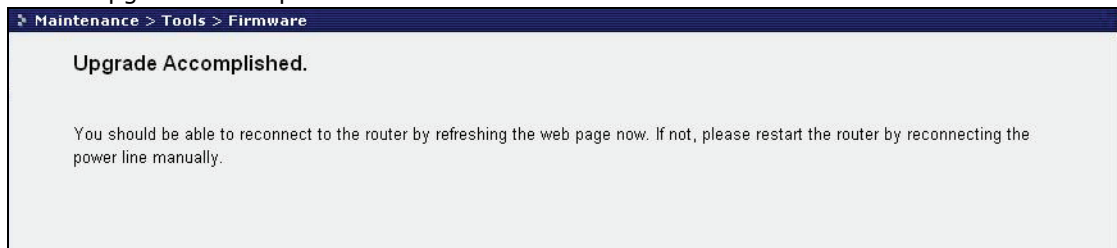
Figure 40 Upgrade Accomplished

Refresh the web page and log in again and check your new firmware version in the **Status** screen.

9.4 Configuration Screen

Click **Maintenance > Tools > Configuration**. Information related to factory defaults, backup configuration, and restoring configuration appears as shown next.

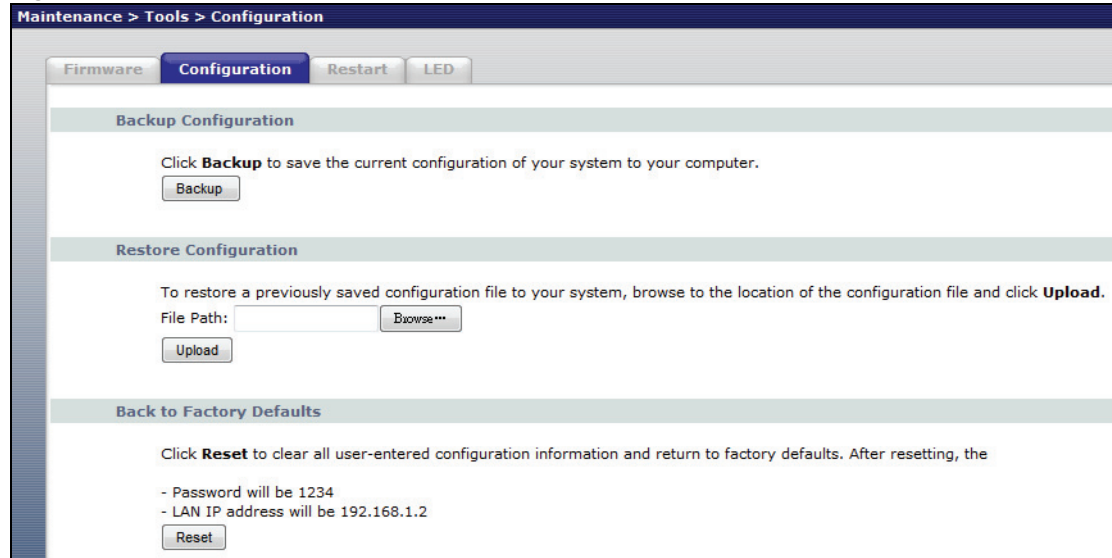
Figure 41 Maintenance > Tools > Configuration

9.4.1 Backup Configuration

Backup configuration allows you to back up (save) the WRE2205's current configuration to a file on your computer. Once your WRE2205 is configured and functioning properly, it is highly recommended that you back up your configuration file before making configuration changes. The backup configuration file will be useful in case you need to return to your previous settings.

Click **Backup** to save the WRE2205's current configuration to your computer.

9.4.2 Restore Configuration

Restore configuration allows you to upload a new or previously saved configuration file from your computer to your WRE2205.

Table 22 Maintenance Restore Configuration

LABEL	DESCRIPTION
File Path	Type in the location of the file you want to upload in this field or click Browse... to find it.
Browse...	Click Browse... to find the file you want to upload. Remember that you must decompress compressed (.ZIP) files before you can upload them.
Upload	Click Upload to begin the upload process.

Note: Do not turn off the WRE2205 while configuration file upload is in progress.

After you see a "configuration upload successful" screen, you must then wait one minute before logging into the WRE2205 again.

The WRE2205 automatically restarts in this time causing a temporary network disconnect. In some operating systems, you may see the following icon on your desktop.

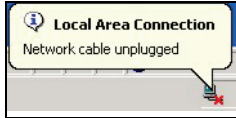
Figure 42 Temporarily Disconnected

If you uploaded the default configuration file you may need to change the IP address of your computer to be in the same subnet as that of the default WRE2205 IP address (192.168.1.2). Refer to your operating system's help files for details on how to set up your computer's IP address.

9.4.3 Back to Factory Defaults

Pressing the **Reset** button on the Maintenance > Tools > Configuration screen clears all user-entered configuration information and returns the WRE2205 to its factory defaults.

You can also press the **WPS** button on the front panel for more than 10 seconds to reset the factory defaults of your WRE2205. Refer to [Section 2.3 on page 14](#) for more information on the resetting the WRE2205.

9.5 Restart Screen

System restart allows you to reboot the WRE2205 without turning the power off.

Click **Maintenance > Tools > Restart**. Click **Restart** to have the WRE2205 reboot. This does not affect the WRE2205's configuration.

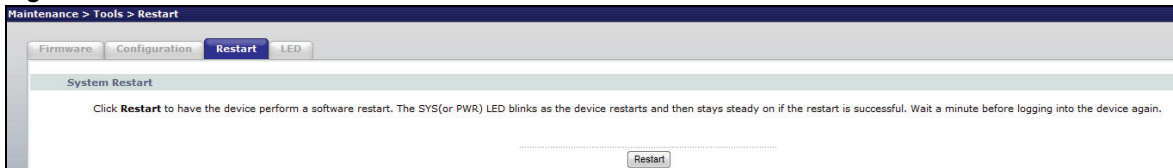
Figure 43 Maintenance > Tools > Restart

9.6 LED Screen

Click **Maintenance > Tools > LED**. Use this screen to configure which LEDs are enabled or disabled.

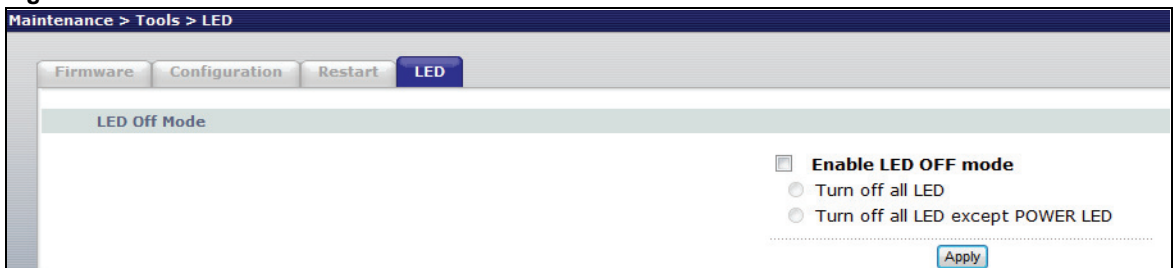
Figure 44 Maintenance > Tools > LED

The following table describes the labels on the LED screen.

Table 23 Maintenance > Tools > LED Screen

LABEL	DESCRIPTION
Enable LED OFF mode	Type in the location of the file you want to upload in this field or click Browse... to find it.
Turn off all LED	Select this to turn off all LEDs.
Turn off all LED except POWER LED	Select this to turn off all LEDs except the power LED.
Apply	Click Apply to save your changes back to the WRE2205.

Troubleshooting

This chapter offers some suggestions to solve problems you might encounter. The potential problems are divided into the following categories.

- [Power, Hardware Connections, and LEDs](#)
- [WRE2205 Access and Login](#)
- [Internet Access](#)
- [Resetting the WRE2205 to Its Factory Defaults](#)
- [Wireless Problems](#)

10.1 Power, Hardware Connections, and LEDs

The WRE2205 does not turn on. None of the LEDs turn on.

- 1 Make sure you are using the power adaptor or cord included with the WRE2205.
- 2 Make sure the power adaptor or cord is connected to the WRE2205 and plugged in to an appropriate power source. Make sure the power source is turned on.
- 3 Disconnect and re-connect the power adaptor or cord to the WRE2205.
- 4 If the problem continues, contact the vendor.

One of the LEDs does not behave as expected.

- 1 Make sure you understand the normal behavior of the LED. See [Section 1.3 on page 10](#).
- 2 Make sure you understand how the LEDs are enabled or disabled. See [Section 9.6 on page 54](#).
- 3 Check the hardware connections. See the Quick Start Guide.
- 4 Inspect your cables for damage. Contact the vendor to replace any damaged cables.
- 5 Disconnect and re-connect the power adaptor to the WRE2205.
- 6 If the problem continues, contact the vendor.

10.2 WRE2205 Access and Login

I don't know the IP address of my WRE2205.

- 1 Click **Start > Run**, enter **cmd**, and then enter **Ping zyxelsetupxxxx**, where xxxx is the last four digits of the MAC address of the WRE2205. You can find the MAC address on a label on the WRE2205.
- 2 The default IP address is **192.168.1.2**.
- 3 If you changed the IP address and have forgotten it, you might get the IP address of the WRE2205 by looking up the IP address of the default gateway for your computer. To do this in most Windows computers, click **Start > Run**, enter **cmd**, and then enter **ipconfig**. The IP address of the **Default Gateway** might be the IP address of the WRE2205 (it depends on the network), so enter this IP address in your Internet browser. Login (see the Quick Start Guide for instructions) and go to the **Device Information** table in the **Status** screen. Your WRE2205's IP address is available in the **Device Information** table.
 - If the **DHCP** setting under **LAN information** is **None**, your device has a fixed IP address.
 - If the **DHCP** setting under **LAN information** is **Client**, then your device receives an IP address from a DHCP server on the network.
- 4 If your WRE2205 is a DHCP client, you can find your IP address from the DHCP server. This information is only available from the DHCP server which allocates IP addresses on your network. Find this information directly from the DHCP server or contact your system administrator for more information.
- 5 Reset your WRE2205 to change all settings back to their default. This means your current settings are lost. See [Section 10.4 on page 60](#) in the **Troubleshooting** for information on resetting your WRE2205.

I forgot the username and password.

- 1 The default username is **admin** and default password is **1234**.
- 2 If this does not work, you have to reset the device to its factory defaults. See [Section 10.4 on page 60](#).

I cannot see or access the **Login** screen in the Web Configurator.

- 1 Make sure you are using the correct IP address.
 - The default IP address is 192.168.1.2.
 - If you changed the IP address, use the new IP address.

- If you changed the IP address and have forgotten it, see the troubleshooting suggestions for [I don't know the IP address of my WRE2205](#).
- 2 Check the hardware connections, and make sure the LEDs are behaving as expected. See the Quick Start Guide.
 - 3 Make sure your Internet browser does not block pop-up windows and has JavaScript and Java enabled.
 - 4 Make sure your computer is in the same subnet as the WRE2205. (If you know that there are routers between your computer and the WRE2205, skip this step.)
 - If there is a DHCP server on your network, make sure your computer is using a dynamic IP address.
 - If there is no DHCP server on your network, make sure your computer's IP address is in the same subnet as the WRE2205.
 - 5 Reset the device to its factory defaults, and try to access the WRE2205 with the default IP address.
 - 6 If the problem continues, contact the network administrator or vendor, or try one of the advanced suggestions.

Advanced Suggestions

- If your computer is connected wirelessly, use a computer that is connected to a **LAN/ETHERNET** port.

I can see the **Login** screen, but I cannot log in to the WRE2205.

- 1 Make sure you have entered the password correctly. The default username is **admin** and default password is **1234**. This field is case-sensitive, so make sure [Caps Lock] is not on.
- 2 This can happen when you fail to log out properly from your last session. Try logging in again after 5 minutes.
- 3 Disconnect and re-connect the power adaptor or cord to the WRE2205.
- 4 If this does not work, you have to reset the device to its factory defaults. See [Section 10.4 on page 60](#).

10.3 Internet Access

I cannot access the Internet.

- 1 Check the hardware connections, and make sure the LEDs are behaving as expected. See the Quick Start Guide.

- 2 Try to connect directly to the AP. If you can access the Internet, check that the WRE2205 has associated with the AP by checking the **WLAN STA Information** SSID field shows the SSID of the AP. See [Section 6.4 on page 40](#).
- 3 If you are trying to access the Internet wirelessly, make sure the wireless settings in the wireless client are the same as the settings in the AP.
- 4 Disconnect all the cables from your device, and follow the directions in the Quick Start Guide again.
- 5 If the problem continues, contact your ISP.

I cannot access the Internet anymore. I had access to the Internet (with the WRE2205), but my Internet connection is not available anymore.

- 1 Check the hardware connections, and make sure the LEDs are behaving as expected. See the Quick Start Guide and [Section 1.3 on page 10](#).
- 2 Reboot the WRE2205.
- 3 Try to connect directly to the AP. If you can access the Internet, check that the WRE2205 has associated with the AP by checking the **WLAN STA Information** SSID field shows the SSID of the AP. See [Section 6.4 on page 40](#).
- 4 If the problem continues, contact your ISP.

The Internet connection is slow or intermittent.

- 1 There might be a lot of traffic on the network. Look at the LEDs, and check [Section 1.3 on page 10](#). If the WRE2205 is sending or receiving a lot of information, try closing some programs that use the Internet, especially peer-to-peer applications.
- 2 Check the signal strength. If the signal strength is low, try moving the WRE2205 closer to the AP if possible, and look around to see if there are any devices that might be interfering with the wireless network (for example, microwaves, other wireless networks, and so on).
- 3 Reboot the WRE2205.
- 4 If the problem continues, contact the network administrator or vendor, or try one of the advanced suggestions.

Advanced Suggestion

- Check the settings for QoS. If it is disabled, you might consider activating it.

10.4 Resetting the WRE2205 to Its Factory Defaults

If you reset the WRE2205, you lose all of the changes you have made. The WRE2205 re-loads its default settings, and the username/password resets to **admin/1234**. You have to make all of your changes again.

You will lose all of your changes when you reset the WRE2205 to its factory defaults.

To reset the WRE2205,

- 1 Make sure the power LED is on.
- 2 Press the **WPS** button for longer than 10 seconds to set the WRE2205 back to its factory-default configuration.

OR

- 3 Click **Maintenance > Tools > Restart** and then click **Restart**.

If the WRE2205 restarts automatically, wait for the WRE2205 to finish restarting, and log in to the Web Configurator. The username is **admin** and password is **1234**.

If the WRE2205 does not restart automatically, disconnect and reconnect the WRE2205's power. Then, follow the directions above again.

10.5 Wireless Problems

I cannot access the WRE2205 or ping any computer from the WLAN.

- 1 Make sure the wireless LAN is enabled on the WRE2205.
- 2 Make sure the wireless adapter on the wireless station is working properly.
- 3 Make sure the wireless adapter installed on your computer is IEEE 802.11 compatible and supports the same wireless standard as the WRE2205.
- 4 Make sure your computer (with a wireless adapter installed) is within the transmission range of the WRE2205.
- 5 Check that both the WRE2205 and your wireless station are using the same wireless and wireless security settings, and that both the WRE2205 and the AP are using the same wireless and wireless security settings.
- 6 Make sure traffic between the WLAN and the LAN is not blocked by the MAC Address List of the WRE2205. See [Section 6.5 on page 41](#).

Legal Information

Copyright

Copyright © 2013 by ZyXEL Communications Corporation.

The contents of this publication may not be reproduced in any part or as a whole, transcribed, stored in a retrieval system, translated into any language, or transmitted in any form or by any means, electronic, mechanical, magnetic, optical, chemical, photocopying, manual, or otherwise, without the prior written permission of ZyXEL Communications Corporation.

Published by ZyXEL Communications Corporation. All rights reserved.

Disclaimer

ZyXEL does not assume any liability arising out of the application or use of any products, or software described herein. Neither does it convey any license under its patent rights nor the patent rights of others. ZyXEL further reserves the right to make changes in any products described herein without notice. This publication is subject to change without notice.

Certifications

Federal Communications Commission (FCC) Interference Statement

The device complies with Part 15 of FCC rules. Operation is subject to the following two conditions:

- This device may not cause harmful interference.
- This device must accept any interference received, including interference that may cause undesired operations.

This device has been tested and found to comply with the limits for a Class B digital device pursuant to Part 15 of the FCC Rules. These limits are designed to provide reasonable protection against harmful interference in a residential installation. This device generates, uses, and can radiate radio frequency energy, and if not installed and used in accordance with the instructions, may cause harmful interference to radio communications. However, there is no guarantee that interference will not occur in a particular installation.

If this device does cause harmful interference to radio/television reception, which can be determined by turning the device off and on, the user is encouraged to try to correct the interference by one or more of the following measures:

- 1 Reorient or relocate the receiving antenna.
- 2 Increase the separation between the equipment and the receiver.
- 3 Connect the equipment into an outlet on a circuit different from that to which the receiver is connected.
- 4 Consult the dealer or an experienced radio/TV technician for help.



FCC Radiation Exposure Statement

- This transmitter must not be co-located or operating in conjunction with any other antenna or transmitter.
- IEEE 802.11b, 802.11g or 802.11n (20MHz) operation of this product in the U.S.A. is firmware-limited to channels 1 through 11. IEEE 802.11n (40MHz) operation of this product in the U.S.A. is firmware-limited to channels 3 through 9.
- To comply with FCC RF exposure compliance requirements, a separation distance of at least 20 cm must be maintained between the antenna of this device and all persons.

注意！

依據 低功率電波輻射性電機管理辦法

第十二條 經型式認證合格之低功率射頻電機，非經許可，公司、商號或使用
者均不得擅自變更頻率、加大功率或變更原設計之特性及功能。

第十四條 低功率射頻電機之使用不得影響飛航安全及干擾合法通信；經發現
有干擾現象時，應立即停用，並改善至無干擾時方得繼續使用。
前項合法通信，指依電信規定作業之無線電信。低功率射頻電機須忍受
合法通信或工業、科學及醫療用電波輻射性電機設備之干擾。

Notices

Changes or modifications not expressly approved by the party responsible for compliance could void the user's authority to operate the equipment.

This device has been designed for the WLAN 2.4 GHz network throughout the EC region and Switzerland, with restrictions in France.

Ce produit est conçu pour les bandes de fréquences 2,4 GHz conformément à la législation Européenne. En France métropolitaine, suivant les décisions n°03-908 et 03-909 de l'ARCEP, la puissance d'émission ne devra pas dépasser 10 mW (10 dB) dans le cadre d'une installation WiFi en extérieur pour les fréquences comprises entre 2454 MHz et 2483,5 MHz.

This Class B digital apparatus complies with Canadian ICES-003.
 Cet appareil numérique de la classe B est conforme à la norme NMB-003 du Canada.

Viewing Certifications

Go to <http://www.zyxel.com> to view this product's documentation and certifications.

ZyXEL Limited Warranty

ZyXEL warrants to the original end user (purchaser) that this product is free from any defects in material or workmanship for a specific period (the Warranty Period) from the date of purchase. The Warranty Period varies by region. Check with your vendor and/or the authorized ZyXEL local distributor for details about the Warranty Period of this product. During the warranty period, and upon proof of purchase, should the product have indications of failure due to faulty workmanship and/or materials, ZyXEL will, at its discretion, repair or replace the defective products or components without charge for either parts or labor, and to whatever extent it shall deem necessary to restore the product or components to proper operating condition. Any replacement will consist of a new or re-manufactured functionally equivalent product of equal or higher value, and will be solely at the discretion of ZyXEL. This warranty shall not apply if the product has been modified, misused, tampered with, damaged by an act of God, or subjected to abnormal working conditions.

Note

Repair or replacement, as provided under this warranty, is the exclusive remedy of the purchaser. This warranty is in lieu of all other warranties, express or implied, including any implied warranty of merchantability or fitness for a particular use or purpose. ZyXEL shall in no event be held liable for indirect or consequential damages of any kind to the purchaser.

To obtain the services of this warranty, contact your vendor. You may also refer to the warranty policy for the region in which you bought the device at http://www.zyxel.com/web/support_warranty_info.php.

Registration

Register your product online to receive e-mail notices of firmware upgrades and information at www.zyxel.com for global products, or at www.us.zyxel.com for North American products.

Open Source Licenses (all products)

This product contains in part some free software distributed under GPL license terms and/or GPL like licenses. Open source licenses are provided with the firmware package. You can download the latest firmware at www.zyxel.com. To obtain the source code covered under those Licenses, please contact support@zyxel.com.tw to get it.

Regulatory Information

European Union

The following information applies if you use the product within the European Union.

Declaration of Conformity with Regard to EU Directive 1999/5/EC (R&TTE Directive)

Compliance Information for 2.4GHz and 5GHz Wireless Products Relevant to the EU and Other Countries Following the EU Directive 1999/5/EC (R&TTE Directive)

[Czech]	ZyXEL tímto prohlašuje, že tento zařízení je ve shodě se základními požadavky a dalšími příslušnými ustanoveními směrnice 1999/5/EC.
[Danish]	Undertegnede ZyXEL erklærer herved, at følgende udstyr overholder de væsentlige krav og øvrige relevante krav i direktiv 1999/5/EF.
[German]	Hiermit erklart ZyXEL, dass sich das Gerät Ausstattung in Übereinstimmung mit den grundlegenden Anforderungen und den übrigen einschlägigen Bestimmungen der Richtlinie 1999/5/EU befindet.
[Estonian]	Käesolevaga kinnitab ZyXEL seadme seadmed vastavust direktiivi 1999/5/EÜ põhinõuetele ja nimetatud direktiivist tulenevatele teistele asjakohastele sätetele.
English	Hereby, ZyXEL declares that this equipment is in compliance with the essential requirements and other relevant provisions of Directive 1999/5/EC.
[Spanish]	Por medio de la presente ZyXEL declara que el equipo cumple con los requisitos esenciales y cualesquiera otras disposiciones aplicables o exigibles de la Directiva 1999/5/CE.
[Greek]	ΜΕ ΤΗΝ ΠΑΡΟΥΣΑ ΖΥΧΕΛ ΔΗΛΩΝΕΙ ΟΤΙ ΕΞΟΠΛΙΣΜΟΣ ΣΥΜΜΟΡΦΩΝΕΤΑΙ ΠΡΟΣ ΤΙΣ ΟΥΣΙΩΔΕΙΣ ΑΠΑΙΤΗΣΕΙΣ ΚΑΙ ΤΙΣ ΛΟΙΠΕΣ ΣΧΕΤΙΚΕΣ ΔΙΑΤΑΞΕΙΣ ΤΗΣ ΟΔΗΓΙΑΣ 1999/5/ΕΚ.
[French]	Par la présente ZyXEL déclare que l'appareil équipements est conforme aux exigences essentielles et aux autres dispositions pertinentes de la directive 1999/5/EC.
[Italian]	Con la presente ZyXEL dichiara che questo attrezzatura è conforme ai requisiti essenziali ed alle altre disposizioni pertinenti stabilite dalla direttiva 1999/5/CE.
[Latvian]	Ar šo ZyXEL deklarē, ka iekārtas atbilst Direktīvas 1999/5/EK būtiskajām prasībām un citiem ar to saistītajiem noteikumiem.
[Lithuanian]	Šiuo ZyXEL deklaruoja, kad šis įranga atitinka esminius reikalavimus ir kitas 1999/5/EB Direktyvos nuostatas.
[Dutch]	Hierbij verklaart ZyXEL dat het toestel uitrusting in overeenstemming is met de essentiële eisen en de andere relevante bepalingen van richtlijn 1999/5/EC.
[Maltese]	Hawnhekk, ZyXEL, jiddikjara li dan taghmir jikkonforma mal-htigijiet essenzjali u ma provvedimenti oħrajn rilevanti li hemm fid-Dirrettiva 1999/5/EC.

[Hungarian]	Alulírott, ZyXEL nyilatkozom, hogy a berendezés megfelel a vonatkozó alapvető követelményeknek és az 1999/5/EK irányelv egyéb előírásainak.
[Polish]	Niniejszym ZyXEL oświadcza, że sprzęt jest zgodny z zasadniczymi wymogami oraz pozostałymi stosownymi postanowieniami Dyrektywy 1999/5/EC.
[Portuguese]	ZyXEL declara que este equipamento está conforme com os requisitos essenciais e outras disposições da Directiva 1999/5/EC.
[Slovenian]	ZyXEL izjavlja, da je ta oprema v skladu z bistvenimi zahtevami in ostalimi relevantnimi določili direktive 1999/5/EC.
[Slovak]	ZyXEL týmto vyhlasuje, že zariadenia spĺňa základné požiadavky a všetky príslušné ustanovenia Smernice 1999/5/EC.
[Finnish]	ZyXEL vakuuttaa täten että laitteet tyyppinen laite on direktiivin 1999/5/EY oleellisten vaatimusten ja sitä koskevien direktiivin muiden ehtojen mukainen.
[Swedish]	Härmed intygar ZyXEL att denna utrustning står i överensstämmelse med de väsentliga egenskapskrav och övriga relevanta bestämmelser som framgår av direktiv 1999/5/EC.
[Bulgarian]	С настоящото ZyXEL декларира, че това оборудване е в съответствие със съществените изисквания и другите приложими разпоредбите на Директива 1999/5/EC.
[Icelandic]	Hér með lýsir, ZyXEL því yfir að þessi búnaður er í samræmi við grunnkröfur og önnur viðeigandi ákvæði tilskipunar 1999/5/EC.
[Norwegian]	Erklærer herved ZyXEL at dette utstyret er i samsvar med de grunnleggende kravene og andre relevante bestemmelser i direktiv 1999/5/EF.
[Romanian]	Prin prezenta, ZyXEL declară că acest echipament este în conformitate cu cerințele esențiale și alte prevederi relevante ale Directivei 1999/5/EC.



National Restrictions

This product may be used in all EU countries (and other countries following the EU directive 1999/5/EC) without any limitation except for the countries mentioned below:

Ce produit peut être utilisé dans tous les pays de l'UE (et dans tous les pays ayant transposés la directive 1999/5/CE) sans aucune limitation, excepté pour les pays mentionnés ci-dessous:

Questo prodotto è utilizzabile in tutte i paesi EU (ed in tutti gli altri paesi che seguono le direttive EU 1999/5/EC) senza nessuna limitazione, eccetto per i paesi menzionati di seguito:

Das Produkt kann in allen EU Staaten ohne Einschränkungen eingesetzt werden (sowie in anderen Staaten die der EU Direktive 1995/5/CE folgen) mit Ausnahme der folgenden aufgeführten Staaten:

In the majority of the EU and other European countries, the 2, 4- and 5-GHz bands have been made available for the use of wireless local area networks (LANs). Later in this document you will find an overview of countries in which additional restrictions or requirements or both are applicable.

The requirements for any country may evolve. ZyXEL recommends that you check with the local authorities for the latest status of their national regulations for both the 2,4- and 5-GHz wireless LANs.

The following countries have restrictions and/or requirements in addition to those given in the table labeled "Overview of Regulatory Requirements for Wireless LANs":.

Overview of Regulatory Requirements for Wireless LANs			
Frequency Band (MHz)	Max Power Level (EIRP) ¹ (mW)	Indoor ONLY	Indoor and Outdoor
2400-2483.5	100		✓
5150-5350	200	✓	
5470-5725	1000		✓

Belgium

The Belgian Institute for Postal Services and Telecommunications (BIPT) must be notified of any outdoor wireless link having a range exceeding 300 meters. Please check <http://www.bipt.be> for more details.

Draadloze verbindingen voor buitengebruik en met een reikwijdte van meer dan 300 meter dienen aangemeld te worden bij het Belgisch Instituut voor postdiensten en telecommunicatie (BIPT). Zie <http://www.bipt.be> voor meer gegevens.

Les liaisons sans fil pour une utilisation en extérieur d'une distance supérieure à 300 mètres doivent être notifiées à l'Institut Belge des services Postaux et des Télécommunications (IBPT). Visitez <http://www.ibpt.be> pour de plus amples détails.

Denmark

In Denmark, the band 5150 - 5350 MHz is also allowed for outdoor usage.

I Danmark må frekvensbåndet 5150 - 5350 også anvendes udendørs.

France

For 2.4 GHz, the output power is restricted to 10 mW EIRP when the product is used outdoors in the band 2454 - 2483.5 MHz. There are no restrictions when used indoors or in other parts of the 2.4 GHz band. Check <http://www.arcep.fr> for more details.

Pour la bande 2.4 GHz, la puissance est limitée à 10 mW en p.i.r.e. pour les équipements utilisés en extérieur dans la bande 2454 - 2483.5 MHz. Il n'y a pas de restrictions pour des utilisations en intérieur ou dans d'autres parties de la bande 2.4 GHz. Consultez <http://www.arcep.fr/> pour de plus amples détails.

R&TTE 1999/5/EC		
WLAN 2.4 – 2.4835 GHz		
IEEE 802.11 b/g/n		
Location	Frequency Range(GHz)	Power (EIRP)
Indoor (No restrictions)	2.4 – 2.4835	100mW (20dBm)
Outdoor	2.4 – 2.454	100mW (20dBm)
	2.454 – 2.4835	10mW (10dBm)

Italy

This product meets the National Radio Interface and the requirements specified in the National Frequency Allocation Table for Italy. Unless this wireless LAN product is operating within the boundaries of the owner's property, its use requires a "general authorization." Please check <http://www.sviluppoeconomico.gov.it/> for more details.

Questo prodotto è conforme alla specifiche di Interfaccia Radio Nazionali e rispetta il Piano Nazionale di ripartizione delle frequenze in Italia. Se non viene installato all'interno del proprio fondo, l'utilizzo di prodotti Wireless LAN richiede una "Autorizzazione Generale". Consultare <http://www.sviluppoeconomico.gov.it/> per maggiori dettagli.

Latvia

The outdoor usage of the 2.4 GHz band requires an authorization from the Electronic Communications Office. Please check <http://www.esd.lv> for more details.

2.4 GHz frekvenču joslas izmantošanai ārpus telpām nepieciešama atļauja no Elektronisko sakaru direkcijas. Vairāk informācijas: <http://www.esd.lv>.

Notes:

1. Although Norway, Switzerland and Liechtenstein are not EU member states, the EU Directive 1999/5/EC has also been implemented in those countries.
2. The regulatory limits for maximum output power are specified in EIRP. The EIRP level (in dBm) of a device can be calculated by adding the gain of the antenna used(specified in dBi) to the output power available at the connector (specified in dBm).

List of national codes

COUNTRY	ISO 3166 2 LETTER CODE	COUNTRY	ISO 3166 2 LETTER CODE
Austria	AT	Malta	MT
Belgium	BE	Netherlands	NL
Cyprus	CY	Poland	PL
Czech Republic	CR	Portugal	PT
Denmark	DK	Slovakia	SK
Estonia	EE	Slovenia	SI
Finland	FI	Spain	ES
France	FR	Sweden	SE
Germany	DE	United Kingdom	GB
Greece	GR	Iceland	IS
Hungary	HU	Liechtenstein	LI
Ireland	IE	Norway	NO
Italy	IT	Switzerland	CH
Latvia	LV	Bulgaria	BG
Lithuania	LT	Romania	RO
Luxembourg	LU	Turkey	TR

Safety Warnings

- Do NOT use this product near water, for example, in a wet basement or near a swimming pool.
- Do NOT expose your device to dampness, dust or corrosive liquids.
- Do NOT store things on the device.
- Do NOT install, use, or service this device during a thunderstorm. There is a remote risk of electric shock from lightning.
- Connect ONLY suitable accessories to the device.
- Do NOT open the device or unit. Opening or removing covers can expose you to dangerous high voltage points or other risks. ONLY qualified service personnel should service or disassemble this device. Please contact your vendor for further information.
- Make sure to connect the cables to the correct ports.
- Place connecting cables carefully so that no one will step on them or stumble over them.
- Always disconnect all cables from this device before servicing or disassembling.
- Use ONLY an appropriate power adaptor or cord for your device.

- Connect the power adaptor or cord to the right supply voltage (for example, 110V AC in North America or 230V AC in Europe).
- Do NOT allow anything to rest on the power adaptor or cord and do NOT place the product where anyone can walk on the power adaptor or cord.
- Do NOT use the device if the power adaptor or cord is damaged as it might cause electrocution.
- If the power adaptor or cord is damaged, remove it from the power outlet.
- Do NOT attempt to repair the power adaptor or cord. Contact your local vendor to order a new one.
- Do not use the device outside, and make sure all the connections are indoors. There is a remote risk of electric shock from lightning.
- Do NOT obstruct the device ventilation slots, as insufficient airflow may harm your device.
- Antenna Warning! This device meets ETSI and FCC certification requirements when using the included antenna(s). Only use the included antenna(s).
- If you wall mount your device, make sure that no electrical lines, gas or water pipes will be damaged.

Your product is marked with this symbol, which is known as the WEEE mark. WEEE stands for Waste Electronics and Electrical Equipment. It means that used electrical and electronic products should not be mixed with general waste. Used electrical and electronic equipment should be treated separately.



Index

B

Backup configuration [53](#)

C

certifications

notices [61](#)

viewing [62](#)

Channel [22](#)

Configuration

backup [53](#)

reset the factory defaults [54](#)

restore [53](#)

copyright [61](#)

CPU usage [22](#)

D

disclaimer [61](#)

documentation

related [2](#)

duplex setting [22](#)

E

encryption [39](#)

key [40](#)

F

FCC interference statement [61](#)

Firmware upload [50](#)

file extension

using HTTP

firmware version [22](#)

G

General wireless LAN screen [40](#)

Guide

Quick Start [2](#)

I

IP Address [48](#)

L

LAN setup [47](#)

Link type [22](#)

M

MAC [41](#)

MAC address [39](#)

MAC address filtering [41](#)

MAC Address List [39, 41](#)

managing the device

good habits [10](#)

Media access control [41](#)

Memory usage [22](#)

N

Navigation Panel [24](#)

O

other documentation [2](#)
overview [9](#)

P

port speed [22](#)
product registration [62](#)

Q

Quality of Service (QoS) [43](#)
Quick Start Guide [2](#)

R

registration
 product [62](#)
related documentation [2](#)
Reset the device [14](#)
Restore configuration [53](#)
RTS/CTS Threshold [42](#)

S

safety warnings [64](#)
Service Set [40](#)
Service Set IDentification [16, 40, 46](#)
Service Set IDentity. See SSID.
SSID [16, 22, 38, 40, 46](#)
Subnet Mask [48](#)
Summary
 Packet statistics [23](#)
 Wireless station status [23](#)
System General Setup [49](#)
System restart [54](#)

W

warranty [62](#)
 note [62](#)
Web Configurator
 how to access [13](#)
 Overview [13](#)
Wireless association list [23](#)
wireless channel [60](#)
wireless LAN [60](#)
Wireless LAN wizard [15](#)
Wireless network [39](#)
 basic guidelines [38](#)
 encryption [39](#)
 security [38](#)
 SSID [38](#)
Wireless security [38](#)
 overview [39](#)
 troubleshooting [60](#)
 type [39](#)
Wireless tutorial [26](#)
 WPS [26](#)
Wizard setup [15](#)
 complete [20](#)
 wireless LAN [15](#)
WPS button [11, 14](#)