

## FCC Test Report

**Report No.:** RF170714E03A-1

**FCC ID:** I88WAP6804

**Test Model:** WAP6804

**Received Date:** Dec. 15, 2016

**Test Date:** Dec. 24, 2016; Jan. 05 to Aug 10, 2017

**Issued Date:** Sep. 14, 2017

**Applicant:** Zyxel Communications Corporation

**Address:** No.2 Industry East RD. IX, Hsinchu Science Park, Hsinchu 30075, Taiwan

**Issued By:** Bureau Veritas Consumer Products Services (H.K.) Ltd., Taoyuan Branch  
Hsin Chu Laboratory

**Lab Address:** E-2, No.1, Li Hsin 1st Road, Hsinchu Science Park, Hsinchu City 300,  
Taiwan R.O.C.

**Test Location (1):** E-2, No.1, Li Hsin 1st Road, Hsinchu Science Park, Hsinchu City 300,  
Taiwan R.O.C.

**Test Location (2):** No. 49, Ln. 206, Wende Rd., Shangshan Tsuen, Chiung Lin Hsiang, Hsin  
Chu Hsien 307, Taiwan R.O.C.



This report is for your exclusive use. Any copying or replication of this report to or for any other person or entity, or use of our name or trademark, is permitted only with our prior written permission. This report sets forth our findings solely with respect to the test samples identified herein. The results set forth in this report are not indicative or representative of the quality or characteristics of the lot from which a test sample was taken or any similar or identical product unless specifically and expressly noted. Our report includes all of the tests requested by you and the results thereof based upon the information that you provided to us. You have 60 days from date of issuance of this report to notify us of any material error or omission caused by our negligence, provided, however, that such notice shall be in writing and shall specifically address the issue you wish to raise. A failure to raise such issue within the prescribed time shall constitute your unqualified acceptance of the completeness of this report, the tests conducted and the correctness of the report contents. Unless specific mention, the uncertainty of measurement has been explicitly taken into account to declare the compliance or non-compliance to the specification. The report must not be used by the client to claim product certification, approval, or endorsement by TAF or any government agencies.

## Table of Contents

<b>Release Control Record</b> .....	<b>4</b>
<b>1 Certificate of Conformity</b> .....	<b>5</b>
<b>2 Summary of Test Results</b> .....	<b>6</b>
2.1 Measurement Uncertainty .....	6
2.2 Modification Record .....	6
<b>3 General Information</b> .....	<b>7</b>
3.1 General Description of EUT (DFS Band) .....	7
3.2 Description of Test Modes .....	12
3.2.1 Test Mode Applicability and Tested Channel Detail .....	13
3.3 Duty Cycle of Test Signal .....	15
3.4 Description of Support Units .....	16
3.4.1 Configuration of System under Test .....	17
3.5 General Description of Applied Standard .....	18
<b>4 Test Types and Results</b> .....	<b>19</b>
4.1 Radiated Emission and Bandedge Measurement .....	19
4.1.1 Limits of Radiated Emission and Bandedge Measurement .....	19
4.1.2 Test Instruments .....	20
4.1.3 Test Procedure .....	22
4.1.4 Deviation from Test Standard .....	22
4.1.5 Test Setup .....	23
4.1.6 EUT Operating Condition .....	24
4.1.7 Test Results .....	25
4.2 Conducted Emission Measurement .....	68
4.2.1 Limits of Conducted Emission Measurement .....	68
4.2.2 Test Instruments .....	68
4.2.3 Test Procedure .....	69
4.2.4 Deviation from Test Standard .....	69
4.2.5 Test Setup .....	69
4.2.6 EUT Operating Condition .....	69
4.2.7 Test Results .....	70
4.3 Transmit Power Measurement .....	72
4.3.1 Limits of Transmit Power Measurement .....	72
4.3.2 Test Setup .....	73
4.3.3 Test Instruments .....	73
4.3.4 Test Procedure .....	74
4.3.5 Deviation from Test Standard .....	75
4.3.6 EUT Operating Condition .....	75
4.3.7 Test Result .....	76
4.4 Occupied Bandwidth Measurement .....	92
4.4.1 Test Setup .....	92
4.4.2 Test Instruments .....	92
4.4.3 Test Procedure .....	92
4.4.4 Test Results .....	93
4.5 Peak Power Spectral Density Measurement .....	96
4.5.1 Limits of Peak Power Spectral Density Measurement .....	96
4.5.2 Test Setup .....	96
4.5.3 Test Instruments .....	96
4.5.4 Test Procedure .....	97
4.5.5 Deviation from Test Standard .....	97
4.5.6 EUT Operating Condition .....	97
4.5.7 Test Results .....	98
4.6 Frequency Stability Measurement .....	112
4.6.1 Limits of Frequency Stability Measurement .....	112

4.6.2	Test Setup.....	112
4.6.3	Test Instruments .....	112
4.6.4	Test Procedure .....	113
4.6.5	Deviation from Test Standard .....	113
4.6.6	EUT Operating Condition .....	113
4.6.7	Test Results .....	114
4.7	6dB Bandwidth Measurement .....	115
4.7.1	Limits of 6dB Bandwidth Measurement.....	115
4.7.2	Test Setup.....	115
4.7.3	Test Instruments .....	115
4.7.4	Test Procedure .....	115
4.7.5	Deviation from Test Standard .....	115
4.7.6	EUT Operating Condition .....	115
4.7.7	Test Results .....	116
<b>5</b>	<b>Pictures of Test Arrangements.....</b>	<b>118</b>
	<b>Appendix – Information on the Testing Laboratories .....</b>	<b>119</b>

### Release Control Record

Issue No.	Description	Date Issued
RF170714E03A-1	Original release.	Sep. 14, 2017

## 1 Certificate of Conformity

**Product:** Dual-Band AC2100 Gigabit Wireless Bridge

**Brand:** ZYXEL

**Test Model:** WAP6804

**Sample Status:** ENGINEERING SAMPLE

**Applicant:** Zyxel Communications Corporation

**Test Date:** Dec. 24, 2016; Jan. 05 to Aug 10, 2017

**Standard:** 47 CFR FCC Part 15, Subpart E (Section 15.407)  
ANSI C63.10: 2013

The above equipment has been tested by **Bureau Veritas Consumer Products Services (H.K.) Ltd., Taoyuan Branch**, and found compliance with the requirement of the above standards. The test record, data evaluation & Equipment Under Test (EUT) configurations represented herein are true and accurate accounts of the measurements of the sample's EMC characteristics under the conditions specified in this report.

**Prepared by :** Wendy Wu , **Date:** Sep. 14, 2017  
Wendy Wu / Specialist

**Approved by :** May Chen , **Date:** Sep. 14, 2017  
May Chen / Manager

## 2 Summary of Test Results

47 CFR FCC Part 15, Subpart E (Section 15.407)			
FCC Clause	Test Item	Result	Remarks
15.407(b)(6)	AC Power Conducted Emissions	Pass	Meet the requirement of limit. Minimum passing margin is -6.03dB at 0.25156MHz.
15.407(b) (1/2/3/4(i/ii)/6)	Radiated Emissions & Band Edge Measurement*	Pass	Meet the requirement of limit. Minimum passing margin is -0.2dB at 5470.00MHz.
15.407(a)(1/2/3)	Max Average Transmit Power	Pass	Meet the requirement of limit.
---	Occupied Bandwidth Measurement	-	Reference only.
15.407(a)(1/2/3)	Peak Power Spectral Density	Pass	Meet the requirement of limit.
15.407(e)	6dB bandwidth	Pass	Meet the requirement of limit. (U-NII-3 Band only)
15.407(g)	Frequency Stability	Pass	Meet the requirement of limit.
15.203	Antenna Requirement	Pass	Antenna connector is i-pex not a standard connector.

### 2.1 Measurement Uncertainty

Where relevant, the following measurement uncertainty levels have been estimated for tests performed on the EUT as specified in CISPR 16-4-2:

Measurement	Frequency	Expanded Uncertainty (k=2) (±)
Conducted Emissions at mains ports	150kHz ~ 30MHz	1.84 dB
Radiated Emissions up to 1 GHz	30MHz ~ 1GHz	5.30 dB
Radiated Emissions above 1 GHz	1GHz ~ 6GHz	3.41 dB
	6GHz ~ 18GHz	3.49 dB
	18GHz ~ 40GHz	3.30 dB

### 2.2 Modification Record

There were no modifications required for compliance.

### 3 General Information

#### 3.1 General Description of EUT (DFS Band)

Product	Dual-Band AC2100 Gigabit Wireless Bridge
Brand	ZYXEL
Test Model	WAP6804
RF CPU Model No.	QT3860BC
RF Chip Model No.	2.4GHz: RTL8192EE 5GHz: QT2518B
FW	1.00(ABKH.0)b3_20170630
Status of EUT	ENGINEERING SAMPLE
Power Supply Rating	DC 12V from power adapter
Modulation Type	64QAM, 16QAM, QPSK, BPSK for OFDM 256QAM for OFDM in 11ac mode.
Modulation Technology	OFDM
Transfer Rate	802.11a: up to 54Mbps 802.11n: up to 600Mbps 802.11ac: up to 1733.3Mbps
Operating Frequency	5.26 ~ 5.32GHz, 5.5 ~ 5.72GHz
Number of Channel	802.11a, 802.11n (HT20), 802.11ac (VHT20): 16 802.11n (HT40), 802.11ac (VHT40): 8 802.11ac (VHT80): 4
Output Power	<b>5.26GHz ~ 5.32GHz:</b> <b>CDD Mode:</b> 236.492mW <b>Beamforming Mode:</b> 236.492mW <b>5.5GHz ~ 5.72GHz:</b> <b>CDD Mode:</b> 192.836mW <b>Beamforming Mode:</b> 234.816mW
Antenna Type	PCB antenna
Antenna Connector	i-pex
Accessory Device	Adapter x 1
Data Cable Supplied	Ethernet cable x 1 (Unshielded, 1.8m)

Note:

- This report is prepared for FCC class II permissive change. The difference compared with the Report No.: RF170714E03-1 as the following:
  - ◆ Add DFS band <5.26 ~ 5.32GHz, 5.5 ~ 5.72GHz>
- According to above condition, all test items need to be performed. And all data weres verified to meet the requirements
- The EUT power needs to be supplied from power adapter, the information is as below table:

Brand	Model No.	Spec.
UMEC	UP0181D-12PA	Input: 100-240V, 0.4A, 50/60Hz (MAX) Output: 12V, 1.5A DC Cable (unshielded, 1.5m)

4. The antennas provided to the EUT, please refer to the following table:

Frequency	Antenna Gain (dBi)			Antenna Gain (dBi)		
	ANT_0			ANT_1		
	20 MHz	40 MHz	80 MHz	20 MHz	40 MHz	80 MHz
5260	2.12	--	--	2.90	--	--
5270	--	2.01	--	--	2.68	--
5290	--	--	2.36	--	--	2.54
5300	2.57	--	--	2.59	--	--
5310	--	2.55	--	--	2.17	--
5320	--	--	2.65	--	--	2.30
5500	2.45	--	--	2.85	--	--
5510	--	2.72	--	--	2.83	--
5530	--	--	2.40	--	--	3.17
5550	--	2.51	--	--	3.08	--
5580	2.39	--	--	3.05	--	--
5610	--	--	2.51	--	--	3.08
5620	3.03	--	--	3.29	--	--
5630	--	2.93	--	--	3.24	--
5670	--	2.86	--	--	2.81	--
5690	--	--	2.92	--	--	2.56
5700	3.26	--	--	2.58	--	--
5710	--	3.60	--	--	3.53	--
5720	--	--	3.36	--	--	3.54
Frequency	Antenna Gain (dBi)			Antenna Gain (dBi)		
	ANT_2			ANT_3		
	20 MHz	40 MHz	80 MHz	20 MHz	40 MHz	80 MHz
5260	2.72	--	--	2.62	--	--
5270	--	2.36	--	--	2.73	--
5290	--	--	2.38	--	--	2.98
5300	2.14	--	--	3.08	--	--
5310	--	1.90	--	--	2.75	--
5320	--	--	2.11	--	--	2.74
5500	3.00	--	--	3.70	--	--
5510	--	3.01	--	--	3.25	--
5530	--	--	3.42	--	--	2.99
5550	--	2.89	--	--	2.82	--
5580	3.06	--	--	3.51	--	--
5610	--	--	2.89	--	--	2.82
5620	3.23	--	--	3.54	--	--
5630	--	2.98	--	--	3.75	--
5670	--	3.25	--	--	3.55	--
5690	--	--	3.03	--	--	3.20
5700	2.65	--	--	3.39	--	--
5710	--	3.52	--	--	3.29	--
5720	--	--	3.72	--	--	3.23



## 5. The Directional gain table:

Frequency (MHz)	Max Gain (dBi)			Max Gain (dBi)		
	4TX Nss=1 for CDD and TX BF			4TX Nss=2 for TX BF		
	20 MHz	40 MHz	80 MHz	20 MHz	40 MHz	80 MHz
5260	6.11	--	--	3.10	--	--
5270	--	6.10	--	--	3.09	--
5290	--	--	6.19	--	--	3.18
5300	6.18	--	--	3.17	--	--
5310	--	5.96	--	--	2.95	--
5320	5.98	--	--	2.97	--	--
5500	6.80	--	--	3.79	--	--
5510	--	6.77	--	--	3.76	--
5530	--	--	7.02	--	--	4.01
5550	--	6.55	--	--	3.54	--
5580	6.77	--	--	3.76	--	--
5610	--	--	6.55	--	--	3.54
5620	6.37	--	--	3.36	--	--
5630	--	6.23	--	--	3.22	--
5670	--	6.50	--	--	3.49	--
5690	--	--	6.34	--	--	3.33
5700	6.37	--	--	3.36	--	--
5710	--	6.66	--	--	3.65	--
5720	6.40	--	--	3.39	--	--

## Note:

1. Non-TxBF mode & TxBF mode antenna gain refer to KDB 662911 F 2) f) (ii)

$$DirectionalGain = 10 \cdot \log \left[ \frac{\sum_{j=1}^{N_{SS}} \left\{ \sum_{k=1}^{N_{ANT}} g_{j,k} \right\}^2}{N_{ANT}} \right]$$

where

Each antenna is driven by no more than one spatial stream;

 $N_{SS}$  = the number of independent spatial streams of data;

 $N_{ANT}$  = the total number of antennas

 $g_{j,k} = 10^{G_k / 20}$  if the  $k$ th antenna is being fed by spatial stream  $j$ , or zero if it is not;

 $G_k$  is the gain in dBi of the  $k$ th antenna.

6. The EUT incorporates a MIMO function.

MODULATION MODE	DATA RATE (MCS)	TX & RX CONFIGURATION		NON-TXBF Mode	TXBF Mode
		4TX	4RX		
802.11a	6 ~ 54Mbps	4TX	4RX	v	-
802.11n (HT20)	MCS 0~7	4TX	4RX	v	v
	MCS 8~15	4TX	4RX	v	v
	MCS 16~23	4TX	4RX	v	v
	MCS 24~31	4TX	4RX	v	v
802.11n (HT40)	MCS 0~7	4TX	4RX	v	v
	MCS 8~15	4TX	4RX	v	v
	MCS 16~23	4TX	4RX	v	v
	MCS 24~31	4TX	4RX	v	v
802.11ac (VHT20)	MCS0~8 Nss=1	4TX	4RX	v	v
	MCS0~8 Nss=2	4TX	4RX	v	v
	MCS0~9 Nss=3	4TX	4RX	v	v
	MCS0~8 Nss=4	4TX	4RX	v	v
802.11ac (VHT40)	MCS0~9 Nss=1	4TX	4RX	v	v
	MCS0~9 Nss=2	4TX	4RX	v	v
	MCS0~9 Nss=3	4TX	4RX	v	v
	MCS0~9 Nss=4	4TX	4RX	v	v
802.11ac (VHT80)	MCS0~9 Nss=1	4TX	4RX	v	v
	MCS0~9 Nss=2	4TX	4RX	v	v
	MCS0~9 Nss=3	4TX	4RX	v	v
	MCS0~9 Nss=4	4TX	4RX	v	v

Note. : 1. The modulation and bandwidth are similar for 802.11n mode for 20MHz (40MHz) and 802.11ac mode for 20MHz (40MHz), therefore investigated worst case to representative mode in test report. (Final test mode refer section 3.2.1)  
 2. All of modulation mode support beamforming function except 802.11a modulation mode.

7. The power setting are list as below:

Modulation Mode	Frequency (MHz)	Power Setting (CDD / Beamforming NSS=1)	Power Setting (Beamforming NSS=2)
802.11a	5260	17	-
	5300	17	-
	5320	17	-
	5500	16	-
	5580	16	-
	5700	16	-
	5720	16	-
802.11ac (VHT20)	5260	17	17
	5300	17	17
	5320	17	17
	5500	16	17
	5580	16	17
	5700	16	17
	5720	16	17
802.11ac (VHT40)	5270	17	17
	5310	17	17
	5510	16	17
	5550	16	17
	5670	16	17
	5710	16	17
802.11ac (VHT80)	5290	16	16
	5530	15	17
	5610	16	17
	5710	16	17

8. The above EUT information is declared by manufacturer and for more detailed features description, please refer to the manufacturer's specifications or user's manual.

### 3.2 Description of Test Modes

#### FOR 5260 ~ 5320MHz

4 channels are provided for 802.11a, 802.11n (HT20), 802.11ac (VHT20):

Channel	Frequency	Channel	Frequency
52	5260 MHz	60	5300 MHz
56	5280 MHz	64	5320 MHz

2 channels are provided for 802.11n (HT40), 802.11ac (VHT40):

Channel	Frequency	Channel	Frequency
54	5270 MHz	62	5310 MHz

1 channel is provided for 802.11ac (VHT80):

Channel	Frequency
58	5290 MHz

#### FOR 5500 ~ 5720MHz

12 channels are provided for 802.11a, 802.11n (HT20), 802.11ac (VHT20):

Channel	Frequency	Channel	Frequency
100	5500 MHz	124	5620 MHz
104	5520 MHz	128	5640 MHz
108	5540 MHz	132	5660 MHz
112	5560 MHz	136	5680 MHz
116	5580 MHz	140	5700 MHz
120	5600 MHz	144	5720 MHz

6 channels are provided for 802.11n (HT40), 802.11ac (VHT40):

Channel	Frequency	Channel	Frequency
102	5510 MHz	126	5630 MHz
110	5550 MHz	134	5670 MHz
118	5590 MHz	142	5710 MHz

3 channels are provided for 802.11ac (VHT80):

Channel	Frequency	Channel	Frequency
106	5530 MHz	138	5690 MHz
122	5610 MHz		

### 3.2.1 Test Mode Applicability and Tested Channel Detail

EUT Configure Mode	Applicable To				Description
	RE $\geq$ 1G	RE $<$ 1G	PLC	APCM	
-	√	√	√	√	-

Where **RE $\geq$ 1G**: Radiated Emission above 1GHz      **RE $<$ 1G**: Radiated Emission below 1GHz  
**PLC**: Power Line Conducted Emission      **APCM**: Antenna Port Conducted Measurement

**NOTE:**

- The EUT had been pre-tested on the positioned of each 2 axis. The worst case was found when positioned on **Y-plane**.

#### **Radiated Emission Test (Above 1GHz):**

- Pre-Scan has been conducted to determine the worst-case mode from all possible combinations between available modulations, data rates and antenna ports (if EUT with antenna diversity architecture).
- Following channel(s) was (were) selected for the final test as listed below.

CDD Mode						
Mode	FREQ. Band (MHz)	Available Channel	Tested Channel	Modulation Technology	Modulation Type	Data Rate (Mbps)
802.11a	5260-5320	52 to 64	52, 60, 64	OFDM	BPSK	6
802.11ac (VHT20)		52 to 64	52, 60, 64	OFDM	BPSK	6.5
802.11ac (VHT40)		54 to 62	54, 62	OFDM	BPSK	13.5
802.11ac (VHT80)		58	58	OFDM	BPSK	29.3
802.11a	5500-5720	100 to 144	100, 116, 140, 144	OFDM	BPSK	6
802.11ac (VHT20)		100 to 144	100, 116, 140, 144	OFDM	BPSK	6.5
802.11ac (VHT40)		102 to 142	102, 110, 134, 142	OFDM	BPSK	13.5
802.11ac (VHT80)		106 to 138	106, 122, 138	OFDM	BPSK	29.3
Beamforming Mode						
Mode	FREQ. Band (MHz)	Available Channel	Tested Channel	Modulation Technology	Modulation Type	Data Rate (Mbps)
802.11ac (VHT20)	5260-5320	52 to 64	52, 60, 64	OFDM	BPSK	13
802.11ac (VHT40)		54 to 62	54, 62	OFDM	BPSK	27
802.11ac (VHT80)		58	58	OFDM	BPSK	58.5
802.11ac (VHT20)	5500-5720	100 to 144	100, 116, 140, 144	OFDM	BPSK	13
802.11ac (VHT40)		102 to 142	102, 110, 134, 142	OFDM	BPSK	27
802.11ac (VHT80)		106 to 138	106, 122, 138	OFDM	BPSK	58.5

#### **Radiated Emission Test (Below 1GHz):**

- Pre-Scan has been conducted to determine the worst-case mode from all possible combinations between available modulations, data rates and antenna ports (if EUT with antenna diversity architecture).
- Following channel(s) was (were) selected for the final test as listed below.

CDD Mode						
Mode	FREQ. Band (MHz)	Available Channel	Tested Channel	Modulation Technology	Modulation Type	Data Rate (Mbps)
802.11ac (VHT40)	5260-5320	54 to 62	54	OFDM	BPSK	13.5

### Power Line Conducted Emission Test:

- Pre-Scan has been conducted to determine the worst-case mode from all possible combinations between available modulations, data rates and antenna ports (if EUT with antenna diversity architecture).
- Following channel(s) was (were) selected for the final test as listed below.

CDD Mode						
Mode	FREQ. Band (MHz)	Available Channel	Tested Channel	Modulation Technology	Modulation Type	Data Rate (Mbps)
802.11ac (VHT40)	5260-5320	54 to 62	54	OFDM	BPSK	13.5

### Antenna Port Conducted Measurement:

- This item includes all test value of each mode, but only includes spectrum plot of worst value of each mode.
- Pre-Scan has been conducted to determine the worst-case mode from all possible combinations between available modulations, data rates and antenna ports (if EUT with antenna diversity architecture).
- Following channel(s) was (were) selected for the final test as listed below.

CDD Mode						
Mode	FREQ. Band (MHz)	Available Channel	Tested Channel	Modulation Technology	Modulation Type	Data Rate (Mbps)
802.11a	5260-5320	52 to 64	52, 60, 64	OFDM	BPSK	6
802.11a	5500-5720	100 to 144	100, 116, 140, 144	OFDM	BPSK	6
CDD Mode / Beamforming Mode (Nss=1) (output power only)						
Mode	FREQ. Band (MHz)	Available Channel	Tested Channel	Modulation Technology	Modulation Type	Data Rate (Mbps)
802.11ac (VHT20)	5260-5320	52 to 64	52, 60, 64	OFDM	BPSK	6.5
802.11ac (VHT40)		54 to 62	54, 62	OFDM	BPSK	13.5
802.11ac (VHT80)		58	58	OFDM	BPSK	29.3
802.11ac (VHT20)	5500-5720	100 to 144	100, 116, 140, 144	OFDM	BPSK	6.5
802.11ac (VHT40)		102 to 142	102, 110, 134, 142	OFDM	BPSK	13.5
802.11ac (VHT80)		106 to 138	106, 122, 138	OFDM	BPSK	29.3
Beamforming Mode (Nss=2)						
Mode	FREQ. Band (MHz)	Available Channel	Tested Channel	Modulation Technology	Modulation Type	Data Rate (Mbps)
802.11ac (VHT20)	5260-5320	52 to 64	52, 60, 64	OFDM	BPSK	13
802.11ac (VHT40)		54 to 62	54, 62	OFDM	BPSK	27
802.11ac (VHT80)		58	58	OFDM	BPSK	58.5
802.11ac (VHT20)	5500-5720	100 to 144	100, 116, 140, 144	OFDM	BPSK	13
802.11ac (VHT40)		102 to 142	102, 110, 134, 142	OFDM	BPSK	27
802.11ac (VHT80)		106 to 138	106, 122, 138	OFDM	BPSK	58.5

### Test Condition:

Applicable To	Environmental Conditions	Input Power	Tested By
RE $\geq$ 1G	23deg. C, 66%RH	120Vac, 60Hz	Terry Huang
RE $<$ 1G	23deg. C, 65%RH	120Vac, 60Hz	Jyunchun Lin
PLC	29deg. C, 75%RH	120Vac, 60Hz	Andy Ho
APCM	24deg. C, 68%RH	120Vac, 60Hz	Robert Cheng

### 3.3 Duty Cycle of Test Signal

If duty cycle of test signal is  $\geq 98\%$ , duty factor is not required.

If duty cycle of test signal is  $< 98\%$ , duty factor shall be considered.

**802.11a:** Duty cycle =  $2.688 \text{ ms} / 2.766 \text{ ms} = 0.972$ , Duty factor =  $10 * \log(1/0.972) = 0.12$

**802.11ac (VHT20):** Duty cycle =  $4.974 \text{ ms} / 5.02 \text{ ms} = 0.991$

**802.11ac (VHT40):** Duty cycle =  $4.777 \text{ ms} / 4.82 \text{ ms} = 0.991$

**802.11ac (VHT80):** Duty cycle =  $5.508 \text{ ms} / 5.56 \text{ ms} = 0.991$

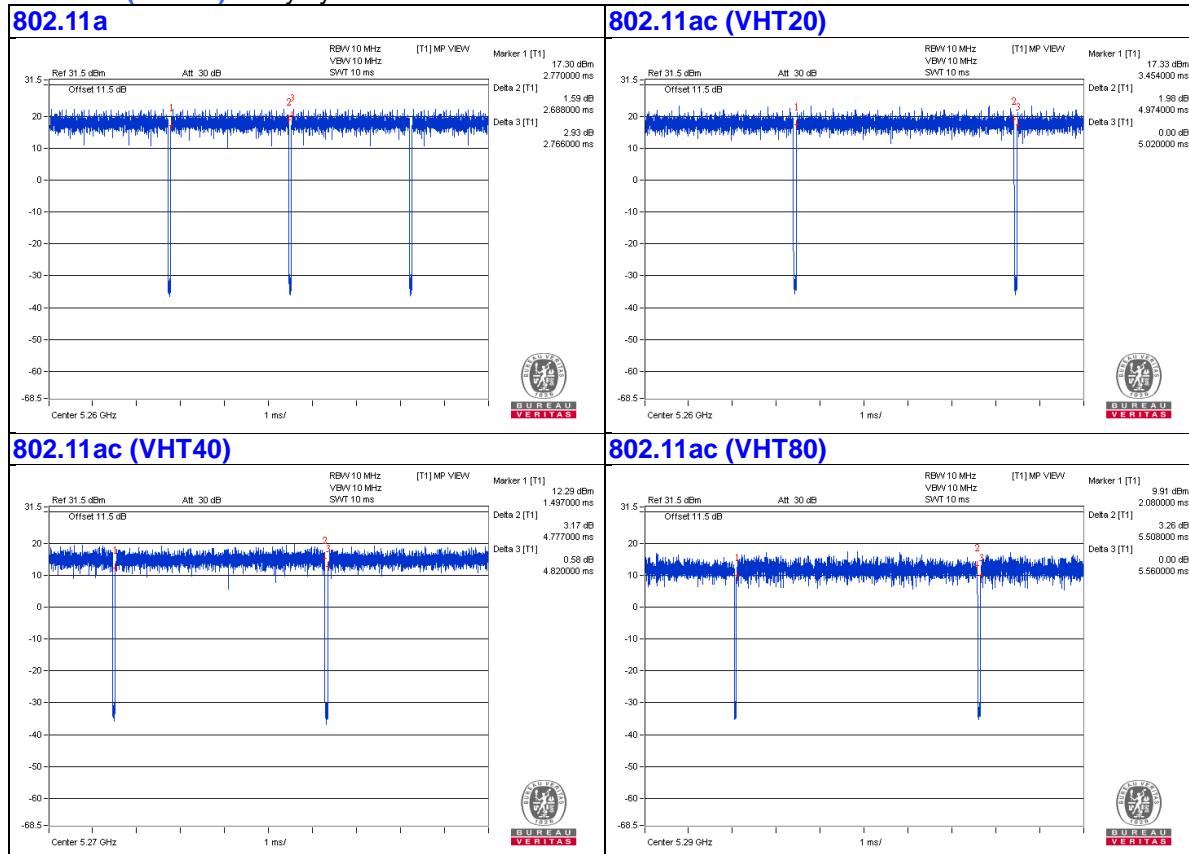

### 3.4 Description of Support Units

The EUT has been tested as an independent unit together with other necessary accessories or support units. The following support units or accessories were used to form a representative test configuration during the tests.

ID	Product	Brand	Model No.	Serial No.	FCC ID	Remarks
A.	Laptop	DELL	E5430	HYV4VY1	FCC DoC	Provided by Lab

Note:

1. All power cords of the above support units are non-shielded (1.8m).

ID	Descriptions	Qty.	Length (m)	Shielding (Yes/No)	Cores (Qty.)	Remarks
1.	RJ-45 Cable	1	10	No	0	Provided by Lab
2.	DC Cable	1	1.5	No	0	Supplied by client



### 3.4.1 Configuration of System under Test

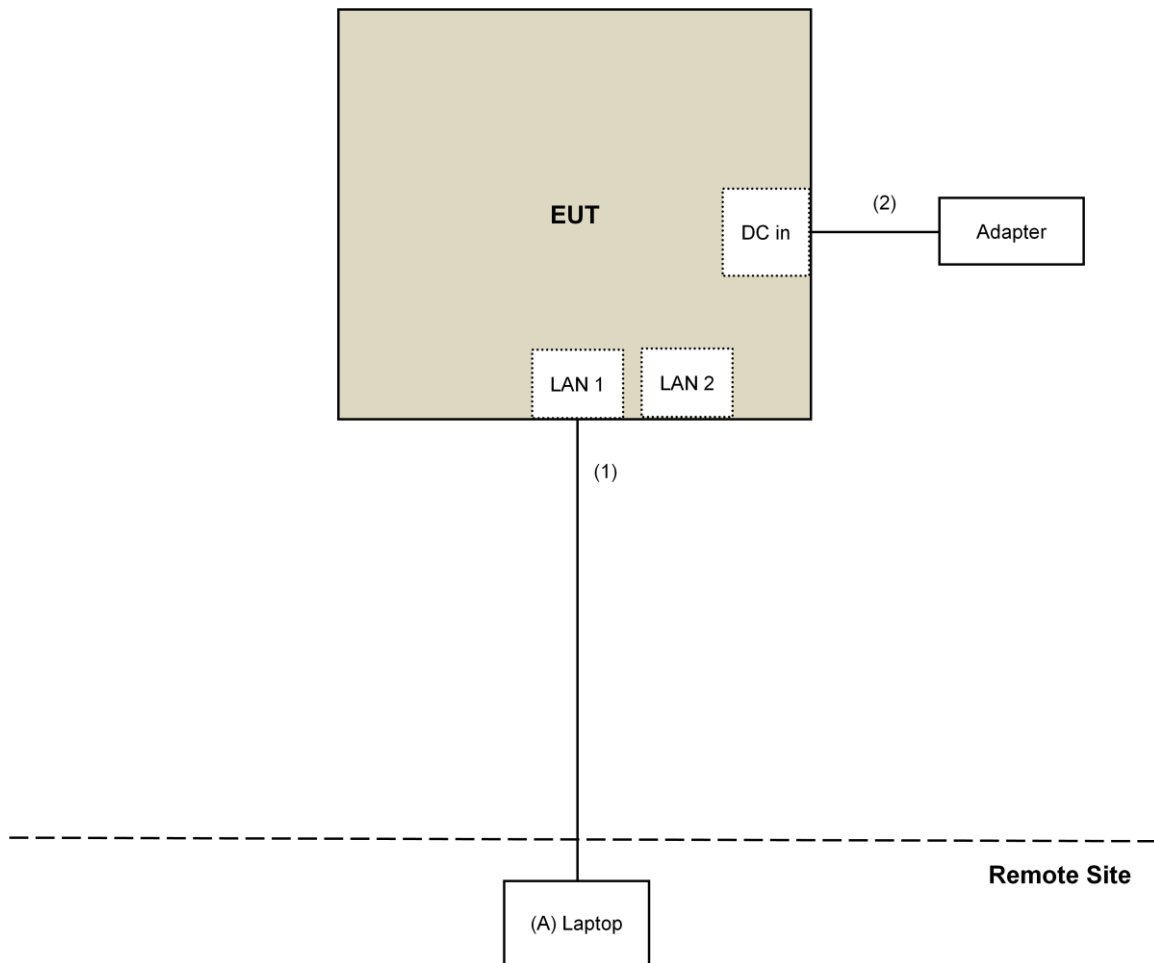

### 3.5 General Description of Applied Standard

The EUT is a RF Product. According to the specifications of the manufacturer, it must comply with the requirements of the following standards:

**FCC Part 15, Subpart E (15.407)**  
**KDB 789033 D02 General UNII Test Procedure New Rules v01r04**  
**KDB 662911 D01 Multiple Transmitter Output v02r01**  
**ANSI C63.10-2013**

All test items have been performed and recorded as per the above standards.

**NOTE:** The EUT has been verified to comply with the requirements of FCC Part 15, Subpart B, Class B (DoC). The test report has been issued separately.

## 4 Test Types and Results

### 4.1 Radiated Emission and Bandedge Measurement

#### 4.1.1 Limits of Radiated Emission and Bandedge Measurement

Radiated emissions which fall in the restricted bands must comply with the radiated emission limits specified as below table.

Frequencies (MHz)	Field Strength (microvolts/meter)	Measurement Distance (meters)
0.009 ~ 0.490	2400/F(kHz)	300
0.490 ~ 1.705	24000/F(kHz)	30
1.705 ~ 30.0	30	30
30 ~ 88	100	3
88 ~ 216	150	3
216 ~ 960	200	3
Above 960	500	3

#### NOTE:

1. The lower limit shall apply at the transition frequencies.
2. Emission level (dBuV/m) = 20 log Emission level (uV/m).
3. For frequencies above 1000MHz, the field strength limits are based on average detector, however, the peak field strength of any emission shall not exceed the maximum permitted average limits, specified above by more than 20dB under any condition of modulation.

Limits of unwanted emission out of the restricted bands

Applicable To		Limit	
789033 D02 General UNII Test Procedure New Rules v01r04		Field Strength at 3m	
		PK:74 (dBuV/m)	AV:54 (dBuV/m)
Frequency Band	Applicable To	EIRP Limit	Equivalent Field Strength at 3m
5150~5250 MHz	15.407(b)(1)	PK:-27 (dBm/MHz)	PK:68.2(dBuV/m)
5250~5350 MHz	15.407(b)(2)		
5470~5725 MHz	15.407(b)(3)		
5725~5850 MHz	<input checked="" type="checkbox"/> 15.407(b)(4)(i)	PK:-27 (dBm/MHz) <sup>*1</sup> PK:10 (dBm/MHz) <sup>*2</sup> PK:15.6 (dBm/MHz) <sup>*3</sup> PK:27 (dBm/MHz) <sup>*4</sup>	PK: 68.2(dBuV/m) <sup>*1</sup> PK:105.2 (dBuV/m) <sup>*2</sup> PK: 110.8(dBuV/m) <sup>*3</sup> PK:122.2 (dBuV/m) <sup>*4</sup>
	<input type="checkbox"/> 15.407(b)(4)(ii)	Emission limits in section 15.247(d)	
<sup>*1</sup> beyond 75 MHz or more above of the band edge.		<sup>*2</sup> below the band edge increasing linearly to 10 dBm/MHz at 25 MHz above.	
<sup>*3</sup> below the band edge increasing linearly to a level of 15.6 dBm/MHz at 5 MHz above.		<sup>*4</sup> from 5 MHz above or below the band edge increasing linearly to a level of 27 dBm/MHz at the band edge.	

#### Note:

The following formula is used to convert the equipment isotropic radiated power (eirp) to field strength:

$$E = \frac{1000000\sqrt{30P}}{3} \mu\text{V/m, where } P \text{ is the eirp (Watts).}$$

#### 4.1.2 Test Instruments

##### For below 1GHz test:

DESCRIPTION & MANUFACTURER	MODEL NO.	SERIAL NO.	CALIBRATED DATE	CALIBRATED UNTIL
Test Receiver Keysight	N9038A	MY54450088	July 08, 2017	July 07, 2018
Pre-Amplifier <sup>(*)</sup> EMCI	EMC001340	980142	Jan. 20, 2016	Jan. 19, 2018
Loop Antenna <sup>(*)</sup> Electro-Metrics	EM-6879	264	Dec. 16, 2016	Dec. 15, 2018
RF Cable	NA	LOOPCAB-001 LOOPCAB-002	Jan. 17, 2017	Jan. 16, 2018
Pre-Amplifier Mini-Circuits	ZFL-1000VH2B	AMP-ZFL-01	Nov. 10, 2016	Nov. 09, 2017
Trilog Broadband Antenna SCHWARZBECK	VULB 9168	9168-406	Dec. 13, 2016	Dec. 12, 2017
RF Cable	8D	966-4-1 966-4-2 966-4-3	Apr. 01, 2017	Mar. 31, 2018
Fixed attenuator Mini-Circuits	UNAT-5+	PAD-3m-4-01	Oct. 05, 2016	Oct. 04, 2017
Software	ADT_Radiated_V8.7.08	NA	NA	NA
Antenna Tower & Turn Table Max-Full	MF-7802	MF780208410	NA	NA

##### Note:

1. The calibration interval of the above test instruments is 12 months and the calibrations are traceable to NML/ROC and NIST/USA.
2. \*The calibration interval of the above test instruments is 24 months and the calibrations are traceable to NML/ROC and NIST/USA.
3. Loop antenna was used for all emissions below 30 MHz.
4. The test was performed in 966 Chamber No. 4.
5. The FCC Designation Number is TW2022. The TW2022 number will be varied with the Lab location and scope as attached.
6. The CANADA Site Registration No. is 20331-2
7. Tested Date: Aug. 09, 2017

**For above 1GHz test:**

DESCRIPTION & MANUFACTURER	MODEL NO.	SERIAL NO.	CALIBRATED DATE	CALIBRATED UNTIL
Test Receiver Keysight	N9038A	MY54450088	July 20, 2016	July 19, 2017
Horn_Antenna SCHWARZBECK	BBHA 9120D	9120D-783	Jan. 19, 2016	Jan. 18, 2017
Pre-Amplifier Agilent	8449B	3008A01922	Sep. 18, 2016	Sep. 17, 2017
RF Cable	EMC104-SM-SM-2000 EMC104-SM-SM-5000 EMC104-SM-SM-5000	150318 150323 150324	Mar. 30, 2016	Mar. 29, 2017
Pre-Amplifier EMCI	EMC184045	980143	Jan. 15, 2016	Jan. 14, 2017
Horn_Antenna SCHWARZBECK	BBHA 9170	BBHA9170608	Jan. 08, 2016	Jan. 07, 2017
RF Cable	SUCOFLEX 102	36432/2 36441/2	Jan. 16, 2016	Jan. 15, 2017
Software	ADT_Radiated_V8.7.08	NA	NA	NA
Antenna Tower & Turn Table Max-Full	MF-7802	MF780208410	NA	NA
Boresight Antenna Fixture	FBA-01	FBA-SIP02	NA	NA

**Note:**

1. The calibration interval of the above test instruments is 12 months and the calibrations are traceable to NML/ROC and NIST/USA.
2. The test was performed in 966 Chamber No. 4.
3. The FCC Designation Number is TW2022. The TW2022 number will be varied with the Lab location and scope as attached.
4. The CANADA Site Registration No. is 20331-2
5. Tested Date: Dec. 24, 2016

#### 4.1.3 Test Procedure

##### **For Radiated emission below 30MHz**

- a. The EUT was placed on the top of a rotating table 0.8 meters above the ground at a 3 meter chamber room. The table was rotated 360 degrees to determine the position of the highest radiation.
- b. The EUT was set 3 meters away from the interference-receiving antenna, which was mounted on the top of a variable-height antenna tower.
- c. Both X and Y axes of the antenna are set to make the measurement.
- d. For each suspected emission, the EUT was arranged to its worst case and the rotatable table was turned from 0 degrees to 360 degrees to find the maximum reading.
- e. The test-receiver system was set to Quasi-Peak Detect Function and Specified Bandwidth with Maximum Hold Mode.

##### **NOTE:**

1. The resolution bandwidth and video bandwidth of test receiver/spectrum analyzer is 9kHz at frequency below 30MHz.

##### **For Radiated emission above 30MHz**

- a. The EUT was placed on the top of a rotating table 0.8 meters (for 30MHz ~ 1GHz) / 1.5 meters (for above 1GHz) above the ground at 3 meter chamber room for test. The table was rotated 360 degrees to determine the position of the highest radiation.
- b. The EUT was set 3 meters away from the interference-receiving antenna, which was mounted on the top of a variable-height antenna tower.
- c. The height of antenna is varied from one meter to four meters above the ground to determine the maximum value of the field strength. Both horizontal and vertical polarizations of the antenna are set to make the measurement.
- d. For each suspected emission, the EUT was arranged to its worst case and then the antenna was tuned to heights from 1 meter to 4 meters and the rotatable table was turned from 0 degrees to 360 degrees to find the maximum reading.
- e. The test-receiver system was set to quasi-peak detect function and specified bandwidth with maximum hold mode when the test frequency is below 1 GHz.
- f. The test-receiver system was set to peak and average detect function and specified bandwidth with maximum hold mode when the test frequency is above 1 GHz. If the peak reading value also meets average limit, measurement with the average detector is unnecessary.

##### **Note:**

1. The resolution bandwidth and video bandwidth of test receiver/spectrum analyzer is 120kHz for Quasi-peak detection (QP) at frequency below 1GHz.
2. The resolution bandwidth of test receiver/spectrum analyzer is 1 MHz and the video bandwidth is 3 MHz for Peak detection (PK) at frequency above 1GHz.
3. The resolution bandwidth of test receiver/spectrum analyzer is 1MHz and the video bandwidth is  $\geq 1/T$  (Duty cycle < 98%) or 10Hz (Duty cycle  $\geq 98\%$ ) for Average detection (AV) at frequency above 1GHz.
4. All modes of operation were investigated and the worst-case emissions are reported.

#### 4.1.4 Deviation from Test Standard

No deviation.

#### 4.1.5 Test Setup

##### For Radiated emission below 30MHz

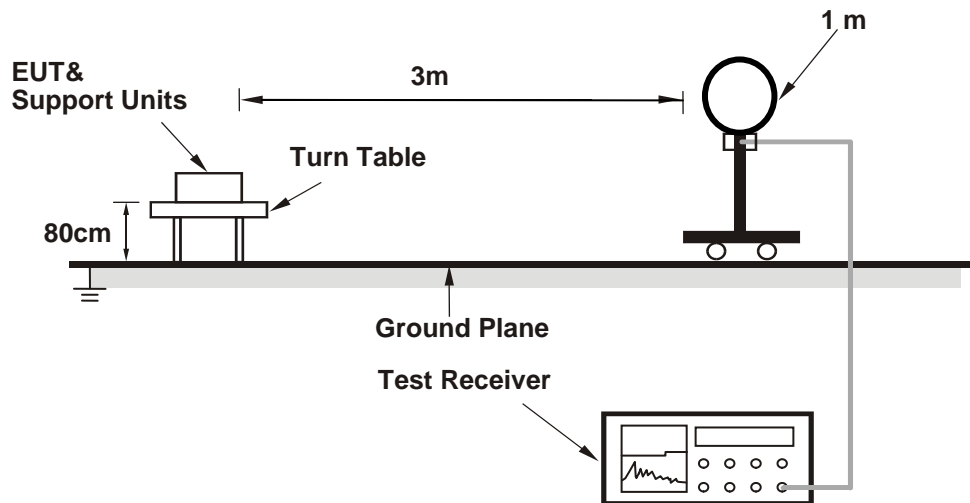

##### For Radiated emission 30MHz to 1GHz

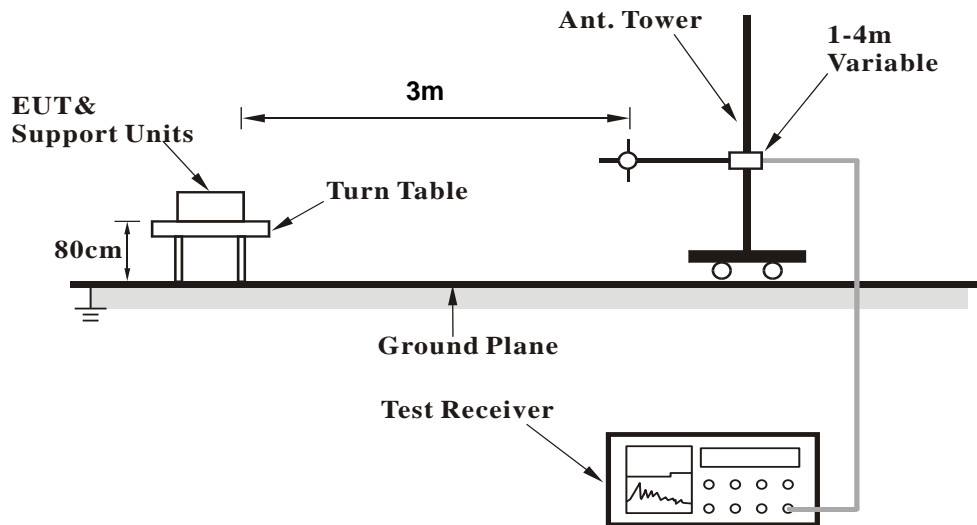

### For Radiated emission above 1GHz

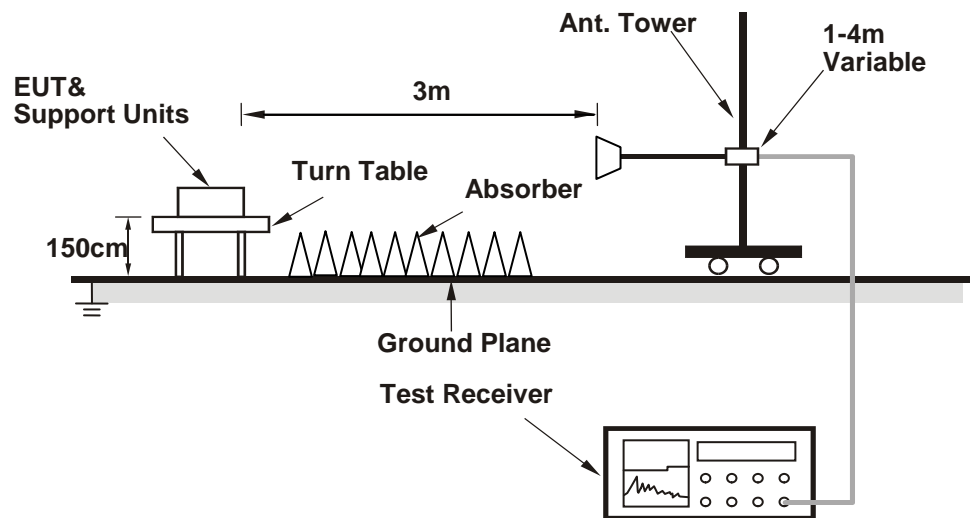

For the actual test configuration, please refer to the attached file (Test Setup Photo).

#### 4.1.6 EUT Operating Condition

- a. Connected the EUT with the Laptop which is placed on remote site.
- b. Controlling software (Quantenna 5G WiFi command.txt) has been activated to set the EUT on specific status.



4.1.7 Test Results

Above 1GHz Data:

CDD Mode

802.11a

<b>CHANNEL</b>	TX Channel 52	<b>DETECTOR FUNCTION</b>	Peak (PK)
<b>FREQUENCY RANGE</b>	1GHz ~ 40GHz		Average (AV)

**ANTENNA POLARITY & TEST DISTANCE: HORIZONTAL AT 3 M**

NO.	FREQ. (MHz)	EMISSION LEVEL (dBuV/m)	LIMIT (dBuV/m)	MARGIN (dB)	ANTENNA HEIGHT (m)	TABLE ANGLE (Degree)	RAW VALUE (dBuV)	CORRECTION FACTOR (dB/m)
1	5150.00	54.4 PK	74.0	-19.6	1.76 H	329	51.4	3.0
2	5150.00	43.1 AV	54.0	-10.9	1.76 H	329	40.1	3.0
3	*5260.00	111.1 PK			1.76 H	329	108.0	3.1
4	*5260.00	102.3 AV			1.76 H	329	99.2	3.1
5	#10520.00	51.5 PK	74.0	-22.5	1.55 H	311	38.6	12.9
6	#10520.00	42.2 AV	54.0	-11.8	1.55 H	311	29.3	12.9
7	15780.00	53.1 PK	74.0	-20.9	2.66 H	81	38.3	14.8
8	15780.00	41.3 AV	54.0	-12.7	2.66 H	81	26.5	14.8

**ANTENNA POLARITY & TEST DISTANCE: VERTICAL AT 3 M**

NO.	FREQ. (MHz)	EMISSION LEVEL (dBuV/m)	LIMIT (dBuV/m)	MARGIN (dB)	ANTENNA HEIGHT (m)	TABLE ANGLE (Degree)	RAW VALUE (dBuV)	CORRECTION FACTOR (dB/m)
1	5150.00	53.8 PK	74.0	-20.2	2.83 V	316	50.8	3.0
2	5150.00	42.0 AV	54.0	-12.0	2.83 V	316	39.0	3.0
3	*5260.00	110.0 PK			2.83 V	316	106.9	3.1
4	*5260.00	101.3 AV			2.83 V	316	98.2	3.1
5	#10520.00	55.0 PK	74.0	-19.0	1.55 V	311	42.1	12.9
6	#10520.00	44.7 AV	54.0	-9.3	1.55 V	311	31.8	12.9
7	15780.00	52.7 PK	74.0	-21.3	2.66 V	81	37.9	14.8
8	15780.00	41.5 AV	54.0	-12.5	2.66 V	81	26.7	14.8

**REMARKS:**

1. Emission Level(dBuV/m) = Raw Value(dBuV) + Correction Factor(dB/m)
2. Correction Factor(dB/m) = Antenna Factor(dB/m) + Cable Factor(dB) – Pre-Amplifier Factor(dB)
3. The other emission levels were very low against the limit.
4. Margin value = Emission Level – Limit value
5. " \* ": Fundamental frequency.
6. " # ": The radiated frequency is out of the restricted band.

<b>CHANNEL</b>	TX Channel 60	<b>DETECTOR FUNCTION</b>	Peak (PK)
<b>FREQUENCY RANGE</b>	1GHz ~ 40GHz		Average (AV)

**ANTENNA POLARITY & TEST DISTANCE: HORIZONTAL AT 3 M**

NO.	FREQ. (MHz)	EMISSION LEVEL (dBuV/m)	LIMIT (dBuV/m)	MARGIN (dB)	ANTENNA HEIGHT (m)	TABLE ANGLE (Degree)	RAW VALUE (dBuV)	CORRECTION FACTOR (dB/m)
1	*5300.00	110.3 PK			1.62 H	327	107.2	3.1
2	*5300.00	102.0 AV			1.62 H	327	98.9	3.1
3	10600.00	51.4 PK	74.0	-22.6	1.53 H	323	38.4	13.0
4	10600.00	42.2 AV	54.0	-11.8	1.53 H	323	29.2	13.0
5	15900.00	52.9 PK	74.0	-21.1	2.67 H	79	38.6	14.3
6	15900.00	41.2 AV	54.0	-12.8	2.67 H	79	26.9	14.3

**ANTENNA POLARITY & TEST DISTANCE: VERTICAL AT 3 M**

NO.	FREQ. (MHz)	EMISSION LEVEL (dBuV/m)	LIMIT (dBuV/m)	MARGIN (dB)	ANTENNA HEIGHT (m)	TABLE ANGLE (Degree)	RAW VALUE (dBuV)	CORRECTION FACTOR (dB/m)
1	*5300.00	109.4 PK			2.77 V	290	106.3	3.1
2	*5300.00	101.3 AV			2.77 V	290	98.2	3.1
3	10600.00	54.7 PK	74.0	-19.3	1.50 V	315	41.7	13.0
4	10600.00	44.6 AV	54.0	-9.4	1.50 V	315	31.6	13.0
5	15900.00	53.5 PK	74.0	-20.5	2.64 V	87	39.2	14.3
6	15900.00	42.0 AV	54.0	-12.0	2.64 V	87	27.7	14.3

**REMARKS:**

1. Emission Level(dBuV/m) = Raw Value(dBuV) + Correction Factor(dB/m)
2. Correction Factor(dB/m) = Antenna Factor(dB/m) + Cable Factor(dB) – Pre-Amplifier Factor(dB)
3. The other emission levels were very low against the limit.
4. Margin value = Emission Level – Limit value
5. " \* ": Fundamental frequency.

<b>CHANNEL</b>	TX Channel 64	<b>DETECTOR FUNCTION</b>	Peak (PK)
<b>FREQUENCY RANGE</b>	1GHz ~ 40GHz		Average (AV)

**ANTENNA POLARITY & TEST DISTANCE: HORIZONTAL AT 3 M**

NO.	FREQ. (MHz)	EMISSION LEVEL (dBuV/m)	LIMIT (dBuV/m)	MARGIN (dB)	ANTENNA HEIGHT (m)	TABLE ANGLE (Degree)	RAW VALUE (dBuV)	CORRECTION FACTOR (dB/m)
1	*5320.00	110.7 PK			2.35 H	275	107.5	3.2
2	*5320.00	102.8 AV			2.35 H	275	99.6	3.2
3	5350.00	59.2 PK	74.0	-14.8	2.35 H	275	56.0	3.2
4	5350.00	48.6 AV	54.0	-5.4	2.35 H	275	45.4	3.2
5	10640.00	51.2 PK	74.0	-22.8	1.50 H	297	38.2	13.0
6	10640.00	41.8 AV	54.0	-12.2	1.50 H	297	28.8	13.0
7	15960.00	52.9 PK	74.0	-21.1	2.65 H	95	38.4	14.5
8	15960.00	41.3 AV	54.0	-12.7	2.65 H	95	26.8	14.5

**ANTENNA POLARITY & TEST DISTANCE: VERTICAL AT 3 M**

NO.	FREQ. (MHz)	EMISSION LEVEL (dBuV/m)	LIMIT (dBuV/m)	MARGIN (dB)	ANTENNA HEIGHT (m)	TABLE ANGLE (Degree)	RAW VALUE (dBuV)	CORRECTION FACTOR (dB/m)
1	*5320.00	109.7 PK			2.93 V	279	106.5	3.2
2	*5320.00	101.9 AV			2.93 V	279	98.7	3.2
3	5350.00	58.0 PK	74.0	-16.0	2.93 V	279	54.8	3.2
4	5350.00	47.8 AV	54.0	-6.2	2.93 V	279	44.6	3.2
5	10640.00	55.3 PK	74.0	-18.7	1.54 V	313	42.3	13.0
6	10640.00	45.1 AV	54.0	-8.9	1.54 V	313	32.1	13.0
7	15960.00	52.9 PK	74.0	-21.1	2.63 V	82	38.4	14.5
8	15960.00	41.7 AV	54.0	-12.3	2.63 V	82	27.2	14.5

**REMARKS:**

1. Emission Level(dBuV/m) = Raw Value(dBuV) + Correction Factor(dB/m)
2. Correction Factor(dB/m) = Antenna Factor(dB/m) + Cable Factor(dB) – Pre-Amplifier Factor(dB)
3. The other emission levels were very low against the limit.
4. Margin value = Emission Level – Limit value
5. " \* ": Fundamental frequency.

<b>CHANNEL</b>	TX Channel 100	<b>DETECTOR FUNCTION</b>	Peak (PK)
<b>FREQUENCY RANGE</b>	1GHz ~ 40GHz		Average (AV)

**ANTENNA POLARITY & TEST DISTANCE: HORIZONTAL AT 3 M**

NO.	FREQ. (MHz)	EMISSION LEVEL (dBuV/m)	LIMIT (dBuV/m)	MARGIN (dB)	ANTENNA HEIGHT (m)	TABLE ANGLE (Degree)	RAW VALUE (dBuV)	CORRECTION FACTOR (dB/m)
1	#5470.00	57.0 PK	74.0	-17.0	2.86 H	273	53.5	3.5
2	#5470.00	46.4 AV	54.0	-7.6	2.86 H	273	42.9	3.5
3	*5500.00	110.2 PK			2.86 H	273	106.7	3.5
4	*5500.00	101.5 AV			2.86 H	273	98.0	3.5
5	11000.00	51.9 PK	74.0	-22.1	1.50 H	312	38.2	13.7
6	11000.00	42.5 AV	54.0	-11.5	1.50 H	312	28.8	13.7
7	#16500.00	53.4 PK	74.0	-20.6	2.69 H	86	36.9	16.5
8	#16500.00	41.7 AV	54.0	-12.3	2.69 H	86	25.2	16.5

**ANTENNA POLARITY & TEST DISTANCE: VERTICAL AT 3 M**

NO.	FREQ. (MHz)	EMISSION LEVEL (dBuV/m)	LIMIT (dBuV/m)	MARGIN (dB)	ANTENNA HEIGHT (m)	TABLE ANGLE (Degree)	RAW VALUE (dBuV)	CORRECTION FACTOR (dB/m)
1	#5470.00	56.0 PK	74.0	-18.0	2.79 V	296	52.5	3.5
2	#5470.00	45.5 AV	54.0	-8.5	2.79 V	296	42.0	3.5
3	*5500.00	109.1 PK			2.79 V	296	105.6	3.5
4	*5500.00	100.5 AV			2.79 V	296	97.0	3.5
5	11000.00	54.9 PK	74.0	-19.1	1.53 V	298	41.2	13.7
6	11000.00	44.4 AV	54.0	-9.6	1.53 V	298	30.7	13.7
7	#16500.00	52.7 PK	74.0	-21.3	2.63 V	81	36.2	16.5
8	#16500.00	41.3 AV	54.0	-12.7	2.63 V	81	24.8	16.5

**REMARKS:**

1. Emission Level(dBuV/m) = Raw Value(dBuV) + Correction Factor(dB/m)
2. Correction Factor(dB/m) = Antenna Factor(dB/m) + Cable Factor(dB) – Pre-Amplifier Factor(dB)
3. The other emission levels were very low against the limit.
4. Margin value = Emission Level – Limit value
5. " \* ": Fundamental frequency.
6. " # ": The radiated frequency is out of the restricted band.

<b>CHANNEL</b>	TX Channel 116	<b>DETECTOR FUNCTION</b>	Peak (PK)
<b>FREQUENCY RANGE</b>	1GHz ~ 40GHz		Average (AV)

**ANTENNA POLARITY & TEST DISTANCE: HORIZONTAL AT 3 M**

NO.	FREQ. (MHz)	EMISSION LEVEL (dBuV/m)	LIMIT (dBuV/m)	MARGIN (dB)	ANTENNA HEIGHT (m)	TABLE ANGLE (Degree)	RAW VALUE (dBuV)	CORRECTION FACTOR (dB/m)
1	#5470.00	55.8 PK	74.0	-18.2	2.40 H	344	52.3	3.5
2	#5470.00	45.9 AV	54.0	-8.1	2.40 H	344	42.4	3.5
3	*5580.00	110.9 PK			2.40 H	344	107.2	3.7
4	*5580.00	102.0 AV			2.40 H	344	98.3	3.7
5	11160.00	51.9 PK	74.0	-22.1	1.50 H	303	38.1	13.8
6	11160.00	42.6 AV	54.0	-11.4	1.50 H	303	28.8	13.8
7	#16740.00	53.3 PK	74.0	-20.7	2.68 H	81	35.8	17.5
8	#16740.00	41.5 AV	54.0	-12.5	2.68 H	81	24.0	17.5

**ANTENNA POLARITY & TEST DISTANCE: VERTICAL AT 3 M**

NO.	FREQ. (MHz)	EMISSION LEVEL (dBuV/m)	LIMIT (dBuV/m)	MARGIN (dB)	ANTENNA HEIGHT (m)	TABLE ANGLE (Degree)	RAW VALUE (dBuV)	CORRECTION FACTOR (dB/m)
1	#5470.00	54.9 PK	74.0	-19.1	2.85 V	311	51.4	3.5
2	#5470.00	44.7 AV	54.0	-9.3	2.85 V	311	41.2	3.5
3	*5580.00	109.7 PK			2.85 V	311	106.0	3.7
4	*5580.00	101.2 AV			2.85 V	311	97.5	3.7
5	11160.00	55.1 PK	74.0	-18.9	1.57 V	315	41.3	13.8
6	11160.00	44.7 AV	54.0	-9.3	1.57 V	315	30.9	13.8
7	#16740.00	52.8 PK	74.0	-21.2	2.67 V	70	35.3	17.5
8	#16740.00	41.5 AV	54.0	-12.5	2.67 V	70	24.0	17.5

**REMARKS:**

1. Emission Level(dBuV/m) = Raw Value(dBuV) + Correction Factor(dB/m)
2. Correction Factor(dB/m) = Antenna Factor(dB/m) + Cable Factor(dB) – Pre-Amplifier Factor(dB)
3. The other emission levels were very low against the limit.
4. Margin value = Emission Level – Limit value
5. " \* ": Fundamental frequency.
6. " # ": The radiated frequency is out of the restricted band.

<b>CHANNEL</b>	TX Channel 140	<b>DETECTOR FUNCTION</b>	Peak (PK)
<b>FREQUENCY RANGE</b>	1GHz ~ 40GHz		Average (AV)

**ANTENNA POLARITY & TEST DISTANCE: HORIZONTAL AT 3 M**

NO.	FREQ. (MHz)	EMISSION LEVEL (dBuV/m)	LIMIT (dBuV/m)	MARGIN (dB)	ANTENNA HEIGHT (m)	TABLE ANGLE (Degree)	RAW VALUE (dBuV)	CORRECTION FACTOR (dB/m)
1	*5700.00	110.8 PK			2.80 H	275	106.8	4.0
2	*5700.00	102.1 AV			2.80 H	275	98.1	4.0
3	#5725.00	56.9 PK	74.0	-17.1	2.80 H	275	52.9	4.0
4	#5725.00	46.3 AV	54.0	-7.7	2.80 H	275	42.3	4.0
5	11400.00	52.0 PK	74.0	-22.0	1.50 H	323	38.2	13.8
6	11400.00	42.4 AV	54.0	-11.6	1.50 H	323	28.6	13.8
7	#17100.00	52.9 PK	74.0	-21.1	2.68 H	66	33.8	19.1
8	#17100.00	41.4 AV	54.0	-12.6	2.68 H	66	22.3	19.1

**ANTENNA POLARITY & TEST DISTANCE: VERTICAL AT 3 M**

NO.	FREQ. (MHz)	EMISSION LEVEL (dBuV/m)	LIMIT (dBuV/m)	MARGIN (dB)	ANTENNA HEIGHT (m)	TABLE ANGLE (Degree)	RAW VALUE (dBuV)	CORRECTION FACTOR (dB/m)
1	*5700.00	109.6 PK			2.91 V	299	105.6	4.0
2	*5700.00	101.4 AV			2.91 V	299	97.4	4.0
3	#5725.00	55.8 PK	74.0	-18.2	2.91 V	299	51.8	4.0
4	#5725.00	45.6 AV	54.0	-8.4	2.91 V	299	41.6	4.0
5	11400.00	55.0 PK	74.0	-19.0	1.54 V	296	41.2	13.8
6	11400.00	44.9 AV	54.0	-9.1	1.54 V	296	31.1	13.8
7	#17100.00	53.0 PK	74.0	-21.0	2.64 V	84	33.9	19.1
8	#17100.00	41.7 AV	54.0	-12.3	2.64 V	84	22.6	19.1

**REMARKS:**

1. Emission Level(dBuV/m) = Raw Value(dBuV) + Correction Factor(dB/m)
2. Correction Factor(dB/m) = Antenna Factor(dB/m) + Cable Factor(dB) – Pre-Amplifier Factor(dB)
3. The other emission levels were very low against the limit.
4. Margin value = Emission Level – Limit value
5. " \* ": Fundamental frequency.
6. " # ": The radiated frequency is out of the restricted band.

<b>CHANNEL</b>	TX Channel 144	<b>DETECTOR FUNCTION</b>	Peak (PK)
<b>FREQUENCY RANGE</b>	1GHz ~ 40GHz		Average (AV)

**ANTENNA POLARITY & TEST DISTANCE: HORIZONTAL AT 3 M**

NO.	FREQ. (MHz)	EMISSION LEVEL (dBuV/m)	LIMIT (dBuV/m)	MARGIN (dB)	ANTENNA HEIGHT (m)	TABLE ANGLE (Degree)	RAW VALUE (dBuV)	CORRECTION FACTOR (dB/m)
1	*5720.00	111.9 PK			1.50 H	337	107.9	4.0
2	*5720.00	103.7 AV			1.50 H	337	99.7	4.0
3	#5850.00	55.9 PK	74.0	-18.1	1.50 H	337	51.9	4.0
4	#5850.00	45.9 AV	54.0	-8.1	1.50 H	337	41.9	4.0
5	11440.00	51.0 PK	74.0	-23.0	1.56 H	309	37.1	13.9
6	11440.00	41.8 AV	54.0	-12.2	1.56 H	309	27.9	13.9
7	#17160.00	53.7 PK	74.0	-20.3	2.72 H	79	34.4	19.3
8	#17160.00	41.7 AV	54.0	-12.3	2.72 H	79	22.4	19.3

**ANTENNA POLARITY & TEST DISTANCE: VERTICAL AT 3 M**

NO.	FREQ. (MHz)	EMISSION LEVEL (dBuV/m)	LIMIT (dBuV/m)	MARGIN (dB)	ANTENNA HEIGHT (m)	TABLE ANGLE (Degree)	RAW VALUE (dBuV)	CORRECTION FACTOR (dB/m)
1	*5720.00	110.7 PK			2.79 V	303	106.7	4.0
2	*5720.00	103.0 AV			2.79 V	303	99.0	4.0
3	#5850.00	54.7 PK	74.0	-19.3	2.79 V	303	50.7	4.0
4	#5850.00	44.8 AV	54.0	-9.2	2.79 V	303	40.8	4.0
5	11440.00	55.1 PK	74.0	-18.9	1.56 V	324	41.2	13.9
6	11440.00	44.6 AV	54.0	-9.4	1.56 V	324	30.7	13.9
7	#17160.00	53.0 PK	74.0	-21.0	2.66 V	82	33.7	19.3
8	#17160.00	41.8 AV	54.0	-12.2	2.66 V	82	22.5	19.3

**REMARKS:**

1. Emission Level(dBuV/m) = Raw Value(dBuV) + Correction Factor(dB/m)
2. Correction Factor(dB/m) = Antenna Factor(dB/m) + Cable Factor(dB) – Pre-Amplifier Factor(dB)
3. The other emission levels were very low against the limit.
4. Margin value = Emission Level – Limit value
5. " \* ": Fundamental frequency.
6. " # ": The radiated frequency is out of the restricted band.

**802.11ac (VHT20)**

<b>CHANNEL</b>	TX Channel 52	<b>DETECTOR FUNCTION</b>	Peak (PK)
<b>FREQUENCY RANGE</b>	1GHz ~ 40GHz		Average (AV)

**ANTENNA POLARITY & TEST DISTANCE: HORIZONTAL AT 3 M**

NO.	FREQ. (MHz)	EMISSION LEVEL (dBuV/m)	LIMIT (dBuV/m)	MARGIN (dB)	ANTENNA HEIGHT (m)	TABLE ANGLE (Degree)	RAW VALUE (dBuV)	CORRECTION FACTOR (dB/m)
1	5150.00	55.3 PK	74.0	-18.7	2.67 H	164	52.3	3.0
2	5150.00	43.9 AV	54.0	-10.1	2.67 H	164	40.9	3.0
3	*5260.00	112.3 PK			2.67 H	164	109.2	3.1
4	*5260.00	102.5 AV			2.67 H	164	99.4	3.1
5	#10520.00	51.5 PK	74.0	-22.5	1.53 H	325	38.6	12.9
6	#10520.00	42.3 AV	54.0	-11.7	1.53 H	325	29.4	12.9
7	15780.00	53.4 PK	74.0	-20.6	2.72 H	95	38.6	14.8
8	15780.00	41.7 AV	54.0	-12.3	2.72 H	95	26.9	14.8

**ANTENNA POLARITY & TEST DISTANCE: VERTICAL AT 3 M**

NO.	FREQ. (MHz)	EMISSION LEVEL (dBuV/m)	LIMIT (dBuV/m)	MARGIN (dB)	ANTENNA HEIGHT (m)	TABLE ANGLE (Degree)	RAW VALUE (dBuV)	CORRECTION FACTOR (dB/m)
1	5150.00	54.5 PK	74.0	-19.5	1.84 V	75	51.5	3.0
2	5150.00	43.0 AV	54.0	-11.0	1.84 V	75	40.0	3.0
3	*5260.00	110.0 PK			1.84 V	75	106.9	3.1
4	*5260.00	101.6 AV			1.84 V	75	98.5	3.1
5	#10520.00	55.1 PK	74.0	-18.9	1.59 V	298	42.2	12.9
6	#10520.00	44.5 AV	54.0	-9.5	1.59 V	298	31.6	12.9
7	15780.00	52.6 PK	74.0	-21.4	2.65 V	93	37.8	14.8
8	15780.00	41.7 AV	54.0	-12.3	2.65 V	93	26.9	14.8

**REMARKS:**

- Emission Level(dBuV/m) = Raw Value(dBuV) + Correction Factor(dB/m)
- Correction Factor(dB/m) = Antenna Factor(dB/m) + Cable Factor(dB) – Pre-Amplifier Factor(dB)
- The other emission levels were very low against the limit.
- Margin value = Emission Level – Limit value
- " \* ": Fundamental frequency.
- " # ": The radiated frequency is out of the restricted band.



<b>CHANNEL</b>	TX Channel 60	<b>DETECTOR FUNCTION</b>	Peak (PK)
<b>FREQUENCY RANGE</b>	1GHz ~ 40GHz		Average (AV)

**ANTENNA POLARITY & TEST DISTANCE: HORIZONTAL AT 3 M**

NO.	FREQ. (MHz)	EMISSION LEVEL (dBuV/m)	LIMIT (dBuV/m)	MARGIN (dB)	ANTENNA HEIGHT (m)	TABLE ANGLE (Degree)	RAW VALUE (dBuV)	CORRECTION FACTOR (dB/m)
1	*5300.00	111.4 PK			2.31 H	179	108.3	3.1
2	*5300.00	101.6 AV			2.31 H	179	98.5	3.1
3	10600.00	51.8 PK	74.0	-22.2	1.55 H	315	38.8	13.0
4	10600.00	42.4 AV	54.0	-11.6	1.55 H	315	29.4	13.0
5	15900.00	53.5 PK	74.0	-20.5	2.65 H	91	39.2	14.3
6	15900.00	41.5 AV	54.0	-12.5	2.65 H	91	27.2	14.3

**ANTENNA POLARITY & TEST DISTANCE: VERTICAL AT 3 M**

NO.	FREQ. (MHz)	EMISSION LEVEL (dBuV/m)	LIMIT (dBuV/m)	MARGIN (dB)	ANTENNA HEIGHT (m)	TABLE ANGLE (Degree)	RAW VALUE (dBuV)	CORRECTION FACTOR (dB/m)
1	*5300.00	109.4 PK			1.92 V	81	106.3	3.1
2	*5300.00	100.8 AV			1.92 V	81	97.7	3.1
3	10600.00	55.3 PK	74.0	-18.7	1.53 V	311	42.3	13.0
4	10600.00	45.2 AV	54.0	-8.8	1.53 V	311	32.2	13.0
5	15900.00	52.6 PK	74.0	-21.4	2.66 V	74	38.3	14.3
6	15900.00	41.6 AV	54.0	-12.4	2.66 V	74	27.3	14.3

**REMARKS:**

1. Emission Level(dBuV/m) = Raw Value(dBuV) + Correction Factor(dB/m)
2. Correction Factor(dB/m) = Antenna Factor(dB/m) + Cable Factor(dB) – Pre-Amplifier Factor(dB)
3. The other emission levels were very low against the limit.
4. Margin value = Emission Level – Limit value
5. " \* ": Fundamental frequency.

<b>CHANNEL</b>	TX Channel 64	<b>DETECTOR FUNCTION</b>	Peak (PK)
<b>FREQUENCY RANGE</b>	1GHz ~ 40GHz		Average (AV)

**ANTENNA POLARITY & TEST DISTANCE: HORIZONTAL AT 3 M**

NO.	FREQ. (MHz)	EMISSION LEVEL (dBuV/m)	LIMIT (dBuV/m)	MARGIN (dB)	ANTENNA HEIGHT (m)	TABLE ANGLE (Degree)	RAW VALUE (dBuV)	CORRECTION FACTOR (dB/m)
1	*5320.00	111.2 PK			2.43 H	167	108.0	3.2
2	*5320.00	101.3 AV			2.43 H	167	98.1	3.2
3	5350.00	60.1 PK	74.0	-13.9	2.43 H	167	56.9	3.2
4	5350.00	46.9 AV	54.0	-7.1	2.43 H	167	43.7	3.2
5	10640.00	51.8 PK	74.0	-22.2	1.50 H	297	38.8	13.0
6	10640.00	42.5 AV	54.0	-11.5	1.50 H	297	29.5	13.0
7	15960.00	53.3 PK	74.0	-20.7	2.71 H	74	38.8	14.5
8	15960.00	41.7 AV	54.0	-12.3	2.71 H	74	27.2	14.5

**ANTENNA POLARITY & TEST DISTANCE: VERTICAL AT 3 M**

NO.	FREQ. (MHz)	EMISSION LEVEL (dBuV/m)	LIMIT (dBuV/m)	MARGIN (dB)	ANTENNA HEIGHT (m)	TABLE ANGLE (Degree)	RAW VALUE (dBuV)	CORRECTION FACTOR (dB/m)
1	*5320.00	109.1 PK			1.96 V	80	105.9	3.2
2	*5320.00	100.5 AV			1.96 V	80	97.3	3.2
3	5350.00	59.3 PK	74.0	-14.7	1.96 V	97	56.1	3.2
4	5350.00	45.8 AV	54.0	-8.2	1.96 V	97	42.6	3.2
5	10640.00	54.9 PK	74.0	-19.1	1.54 V	295	41.9	13.0
6	10640.00	44.8 AV	54.0	-9.2	1.54 V	295	31.8	13.0
7	15960.00	53.0 PK	74.0	-21.0	2.72 V	89	38.5	14.5
8	15960.00	41.6 AV	54.0	-12.4	2.72 V	89	27.1	14.5

**REMARKS:**

1. Emission Level(dBuV/m) = Raw Value(dBuV) + Correction Factor(dB/m)
2. Correction Factor(dB/m) = Antenna Factor(dB/m) + Cable Factor(dB) – Pre-Amplifier Factor(dB)
3. The other emission levels were very low against the limit.
4. Margin value = Emission Level – Limit value
5. " \* ": Fundamental frequency.

<b>CHANNEL</b>	TX Channel 100	<b>DETECTOR FUNCTION</b>	Peak (PK)
<b>FREQUENCY RANGE</b>	1GHz ~ 40GHz		Average (AV)

**ANTENNA POLARITY & TEST DISTANCE: HORIZONTAL AT 3 M**

NO.	FREQ. (MHz)	EMISSION LEVEL (dBuV/m)	LIMIT (dBuV/m)	MARGIN (dB)	ANTENNA HEIGHT (m)	TABLE ANGLE (Degree)	RAW VALUE (dBuV)	CORRECTION FACTOR (dB/m)
1	#5470.00	59.5 PK	74.0	-14.5	2.49 H	166	56.0	3.5
2	#5470.00	47.1 AV	54.0	-6.9	2.49 H	166	43.6	3.5
3	*5500.00	112.1 PK			2.49 H	166	108.6	3.5
4	*5500.00	101.8 AV			2.49 H	166	98.3	3.5
5	11000.00	51.7 PK	74.0	-22.3	1.58 H	304	38.0	13.7
6	11000.00	42.6 AV	54.0	-11.4	1.58 H	304	28.9	13.7
7	#16500.00	53.5 PK	74.0	-20.5	2.63 H	70	37.0	16.5
8	#16500.00	41.7 AV	54.0	-12.3	2.63 H	70	25.2	16.5

**ANTENNA POLARITY & TEST DISTANCE: VERTICAL AT 3 M**

NO.	FREQ. (MHz)	EMISSION LEVEL (dBuV/m)	LIMIT (dBuV/m)	MARGIN (dB)	ANTENNA HEIGHT (m)	TABLE ANGLE (Degree)	RAW VALUE (dBuV)	CORRECTION FACTOR (dB/m)
1	#5470.00	58.7 PK	74.0	-15.3	1.96 V	97	55.2	3.5
2	#5470.00	46.2 AV	54.0	-7.8	1.96 V	97	42.7	3.5
3	*5500.00	110.4 PK			1.96 V	85	106.9	3.5
4	*5500.00	100.9 AV			1.96 V	85	97.4	3.5
5	11000.00	55.3 PK	74.0	-18.7	1.53 V	297	41.6	13.7
6	11000.00	44.8 AV	54.0	-9.2	1.53 V	297	31.1	13.7
7	#16500.00	52.8 PK	74.0	-21.2	2.71 V	79	36.3	16.5
8	#16500.00	41.8 AV	54.0	-12.2	2.71 V	79	25.3	16.5

**REMARKS:**

1. Emission Level(dBuV/m) = Raw Value(dBuV) + Correction Factor(dB/m)
2. Correction Factor(dB/m) = Antenna Factor(dB/m) + Cable Factor(dB) – Pre-Amplifier Factor(dB)
3. The other emission levels were very low against the limit.
4. Margin value = Emission Level – Limit value
5. " \* ": Fundamental frequency.
6. " # ": The radiated frequency is out of the restricted band.

<b>CHANNEL</b>	TX Channel 116	<b>DETECTOR FUNCTION</b>	Peak (PK)
<b>FREQUENCY RANGE</b>	1GHz ~ 40GHz		Average (AV)

**ANTENNA POLARITY & TEST DISTANCE: HORIZONTAL AT 3 M**

NO.	FREQ. (MHz)	EMISSION LEVEL (dBuV/m)	LIMIT (dBuV/m)	MARGIN (dB)	ANTENNA HEIGHT (m)	TABLE ANGLE (Degree)	RAW VALUE (dBuV)	CORRECTION FACTOR (dB/m)
1	*5580.00	113.0 PK			2.88 H	170	109.3	3.7
2	*5580.00	102.9 AV			2.88 H	170	99.2	3.7
3	11160.00	51.6 PK	74.0	-22.4	1.55 H	321	37.8	13.8
4	11160.00	42.1 AV	54.0	-11.9	1.55 H	321	28.3	13.8
5	#16740.00	53.1 PK	74.0	-20.9	2.68 H	93	35.6	17.5
6	#16740.00	41.1 AV	54.0	-12.9	2.68 H	93	23.6	17.5

**ANTENNA POLARITY & TEST DISTANCE: VERTICAL AT 3 M**

NO.	FREQ. (MHz)	EMISSION LEVEL (dBuV/m)	LIMIT (dBuV/m)	MARGIN (dB)	ANTENNA HEIGHT (m)	TABLE ANGLE (Degree)	RAW VALUE (dBuV)	CORRECTION FACTOR (dB/m)
1	*5580.00	111.3 PK			1.93 V	76	107.6	3.7
2	*5580.00	102.2 AV			1.93 V	76	98.5	3.7
3	11160.00	55.2 PK	74.0	-18.8	1.51 V	316	41.4	13.8
4	11160.00	44.7 AV	54.0	-9.3	1.51 V	316	30.9	13.8
5	#16740.00	52.9 PK	74.0	-21.1	2.68 V	77	35.4	17.5
6	#16740.00	41.4 AV	54.0	-12.6	2.68 V	77	23.9	17.5

**REMARKS:**

1. Emission Level(dBuV/m) = Raw Value(dBuV) + Correction Factor(dB/m)
2. Correction Factor(dB/m) = Antenna Factor(dB/m) + Cable Factor(dB) – Pre-Amplifier Factor(dB)
3. The other emission levels were very low against the limit.
4. Margin value = Emission Level – Limit value
5. " \* ": Fundamental frequency.
6. " # ": The radiated frequency is out of the restricted band.

<b>CHANNEL</b>	TX Channel 140	<b>DETECTOR FUNCTION</b>	Peak (PK)
<b>FREQUENCY RANGE</b>	1GHz ~ 40GHz		Average (AV)

**ANTENNA POLARITY & TEST DISTANCE: HORIZONTAL AT 3 M**

NO.	FREQ. (MHz)	EMISSION LEVEL (dBuV/m)	LIMIT (dBuV/m)	MARGIN (dB)	ANTENNA HEIGHT (m)	TABLE ANGLE (Degree)	RAW VALUE (dBuV)	CORRECTION FACTOR (dB/m)
1	*5700.00	113.6 PK			3.26 H	144	109.6	4.0
2	*5700.00	103.4 AV			3.26 H	144	99.4	4.0
3	#5725.00	62.3 PK	74.0	-11.7	3.26 H	144	58.3	4.0
4	#5725.00	49.2 AV	54.0	-4.8	3.26 H	144	45.2	4.0
5	11400.00	51.4 PK	74.0	-22.6	1.56 H	307	37.6	13.8
6	11400.00	42.3 AV	54.0	-11.7	1.56 H	307	28.5	13.8
7	#17100.00	53.1 PK	74.0	-20.9	2.62 H	69	34.0	19.1
8	#17100.00	41.3 AV	54.0	-12.7	2.62 H	69	22.2	19.1

**ANTENNA POLARITY & TEST DISTANCE: VERTICAL AT 3 M**

NO.	FREQ. (MHz)	EMISSION LEVEL (dBuV/m)	LIMIT (dBuV/m)	MARGIN (dB)	ANTENNA HEIGHT (m)	TABLE ANGLE (Degree)	RAW VALUE (dBuV)	CORRECTION FACTOR (dB/m)
1	*5700.00	111.2 PK			1.96 V	97	107.2	4.0
2	*5700.00	102.4 AV			1.96 V	97	98.4	4.0
3	#5725.00	61.5 PK	74.0	-12.5	1.96 V	97	57.5	4.0
4	#5725.00	48.5 AV	54.0	-5.5	1.96 V	97	44.5	4.0
5	11400.00	55.3 PK	74.0	-18.7	1.50 V	307	41.5	13.8
6	11400.00	44.8 AV	54.0	-9.2	1.50 V	307	31.0	13.8
7	#17100.00	52.2 PK	74.0	-21.8	2.67 V	85	33.1	19.1
8	#17100.00	41.1 AV	54.0	-12.9	2.67 V	85	22.0	19.1

**REMARKS:**

1. Emission Level(dBuV/m) = Raw Value(dBuV) + Correction Factor(dB/m)
2. Correction Factor(dB/m) = Antenna Factor(dB/m) + Cable Factor(dB) – Pre-Amplifier Factor(dB)
3. The other emission levels were very low against the limit.
4. Margin value = Emission Level – Limit value
5. " \* ": Fundamental frequency.
6. " # ": The radiated frequency is out of the restricted band.

<b>CHANNEL</b>	TX Channel 144	<b>DETECTOR FUNCTION</b>	Peak (PK)
<b>FREQUENCY RANGE</b>	1GHz ~ 40GHz		Average (AV)

**ANTENNA POLARITY & TEST DISTANCE: HORIZONTAL AT 3 M**

NO.	FREQ. (MHz)	EMISSION LEVEL (dBuV/m)	LIMIT (dBuV/m)	MARGIN (dB)	ANTENNA HEIGHT (m)	TABLE ANGLE (Degree)	RAW VALUE (dBuV)	CORRECTION FACTOR (dB/m)
1	*5720.00	112.5 PK			3.15 H	161	108.5	4.0
2	*5720.00	102.1 AV			3.15 H	161	98.1	4.0
3	#5850.00	56.9 PK	74.0	-17.1	3.15 H	161	52.9	4.0
4	#5850.00	45.5 AV	54.0	-8.5	3.15 H	161	41.5	4.0
5	11440.00	51.3 PK	74.0	-22.7	1.51 H	317	37.4	13.9
6	11440.00	42.1 AV	54.0	-11.9	1.51 H	317	28.2	13.9
7	#17160.00	52.9 PK	74.0	-21.1	2.69 H	66	33.6	19.3
8	#17160.00	41.2 AV	54.0	-12.8	2.69 H	66	21.9	19.3

**ANTENNA POLARITY & TEST DISTANCE: VERTICAL AT 3 M**

NO.	FREQ. (MHz)	EMISSION LEVEL (dBuV/m)	LIMIT (dBuV/m)	MARGIN (dB)	ANTENNA HEIGHT (m)	TABLE ANGLE (Degree)	RAW VALUE (dBuV)	CORRECTION FACTOR (dB/m)
1	*5720.00	110.1 PK			1.95 V	88	106.1	4.0
2	*5720.00	101.2 AV			1.95 V	88	97.2	4.0
3	#5850.00	55.7 PK	74.0	-18.3	1.95 V	88	51.7	4.0
4	#5850.00	44.7 AV	54.0	-9.3	1.95 V	88	40.7	4.0
5	11440.00	55.3 PK	74.0	-18.7	1.53 V	300	41.4	13.9
6	11440.00	44.9 AV	54.0	-9.1	1.53 V	300	31.0	13.9
7	#17160.00	52.1 PK	74.0	-21.9	2.63 V	74	32.8	19.3
8	#17160.00	41.1 AV	54.0	-12.9	2.63 V	74	21.8	19.3

**REMARKS:**

1. Emission Level(dBuV/m) = Raw Value(dBuV) + Correction Factor(dB/m)
2. Correction Factor(dB/m) = Antenna Factor(dB/m) + Cable Factor(dB) – Pre-Amplifier Factor(dB)
3. The other emission levels were very low against the limit.
4. Margin value = Emission Level – Limit value
5. " \* ": Fundamental frequency.
6. " # ": The radiated frequency is out of the restricted band.

802.11ac (VHT40)

<b>CHANNEL</b>	TX Channel 54	<b>DETECTOR FUNCTION</b>	Peak (PK)
<b>FREQUENCY RANGE</b>	1GHz ~ 40GHz		Average (AV)

**ANTENNA POLARITY & TEST DISTANCE: HORIZONTAL AT 3 M**

NO.	FREQ. (MHz)	EMISSION LEVEL (dBuV/m)	LIMIT (dBuV/m)	MARGIN (dB)	ANTENNA HEIGHT (m)	TABLE ANGLE (Degree)	RAW VALUE (dBuV)	CORRECTION FACTOR (dB/m)
1	5150.00	49.8 PK	74.0	-24.2	1.63 H	328	46.8	3.0
2	5150.00	42.1 AV	54.0	-11.9	1.63 H	328	39.1	3.0
3	*5270.00	110.6 PK			1.63 H	328	107.4	3.2
4	*5270.00	101.1 AV			1.63 H	328	97.9	3.2
5	#10540.00	51.0 PK	74.0	-23.0	1.59 H	314	38.1	12.9
6	#10540.00	41.7 AV	54.0	-12.3	1.59 H	314	28.8	12.9
7	15810.00	53.7 PK	74.0	-20.3	2.69 H	78	39.0	14.7
8	15810.00	41.7 AV	54.0	-12.3	2.69 H	78	27.0	14.7

**ANTENNA POLARITY & TEST DISTANCE: VERTICAL AT 3 M**

NO.	FREQ. (MHz)	EMISSION LEVEL (dBuV/m)	LIMIT (dBuV/m)	MARGIN (dB)	ANTENNA HEIGHT (m)	TABLE ANGLE (Degree)	RAW VALUE (dBuV)	CORRECTION FACTOR (dB/m)
1	5150.00	47.6 PK	74.0	-26.4	2.02 V	169	44.6	3.0
2	5150.00	40.6 AV	54.0	-13.4	2.02 V	169	37.6	3.0
3	*5270.00	109.4 PK			2.02 V	169	106.2	3.2
4	*5270.00	100.5 AV			2.02 V	169	97.3	3.2
5	#10540.00	54.9 PK	74.0	-19.1	1.52 V	299	42.0	12.9
6	#10540.00	44.5 AV	54.0	-9.5	1.52 V	299	31.6	12.9
7	15810.00	52.7 PK	74.0	-21.3	2.64 V	70	38.0	14.7
8	15810.00	41.3 AV	54.0	-12.7	2.64 V	70	26.6	14.7

**REMARKS:**

1. Emission Level(dBuV/m) = Raw Value(dBuV) + Correction Factor(dB/m)
2. Correction Factor(dB/m) = Antenna Factor(dB/m) + Cable Factor(dB) – Pre-Amplifier Factor(dB)
3. The other emission levels were very low against the limit.
4. Margin value = Emission Level – Limit value
5. " \* ": Fundamental frequency.
6. " # ": The radiated frequency is out of the restricted band.

<b>CHANNEL</b>	TX Channel 62	<b>DETECTOR FUNCTION</b>	Peak (PK)
<b>FREQUENCY RANGE</b>	1GHz ~ 40GHz		Average (AV)

**ANTENNA POLARITY & TEST DISTANCE: HORIZONTAL AT 3 M**

NO.	FREQ. (MHz)	EMISSION LEVEL (dBuV/m)	LIMIT (dBuV/m)	MARGIN (dB)	ANTENNA HEIGHT (m)	TABLE ANGLE (Degree)	RAW VALUE (dBuV)	CORRECTION FACTOR (dB/m)
1	*5310.00	110.4 PK			1.63 H	330	107.2	3.2
2	*5310.00	100.6 AV			1.63 H	330	97.4	3.2
3	5350.00	65.2 PK	74.0	-8.8	1.63 H	330	62.0	3.2
4	5350.00	52.7 AV	54.0	-1.3	1.63 H	330	49.5	3.2
5	10620.00	51.1 PK	74.0	-22.9	1.52 H	319	38.1	13.0
6	10620.00	42.0 AV	54.0	-12.0	1.52 H	319	29.0	13.0
7	15930.00	53.5 PK	74.0	-20.5	2.70 H	83	39.1	14.4
8	15930.00	41.5 AV	54.0	-12.5	2.70 H	83	27.1	14.4

**ANTENNA POLARITY & TEST DISTANCE: VERTICAL AT 3 M**

NO.	FREQ. (MHz)	EMISSION LEVEL (dBuV/m)	LIMIT (dBuV/m)	MARGIN (dB)	ANTENNA HEIGHT (m)	TABLE ANGLE (Degree)	RAW VALUE (dBuV)	CORRECTION FACTOR (dB/m)
1	*5310.00	109.8 PK			2.82 V	172	106.6	3.2
2	*5310.00	99.8 AV			2.82 V	172	96.6	3.2
3	5350.00	63.0 PK	74.0	-11.0	2.82 V	172	59.8	3.2
4	5350.00	51.0 AV	54.0	-3.0	2.82 V	172	47.8	3.2
5	10620.00	54.8 PK	74.0	-19.2	1.55 V	299	41.8	13.0
6	10620.00	44.2 AV	54.0	-9.8	1.55 V	299	31.2	13.0
7	15930.00	52.4 PK	74.0	-21.6	2.65 V	83	38.0	14.4
8	15930.00	41.4 AV	54.0	-12.6	2.65 V	83	27.0	14.4

**REMARKS:**

1. Emission Level(dBuV/m) = Raw Value(dBuV) + Correction Factor(dB/m)
2. Correction Factor(dB/m) = Antenna Factor(dB/m) + Cable Factor(dB) – Pre-Amplifier Factor(dB)
3. The other emission levels were very low against the limit.
4. Margin value = Emission Level – Limit value
5. " \* ": Fundamental frequency.



<b>CHANNEL</b>	TX Channel 102	<b>DETECTOR FUNCTION</b>	Peak (PK)
<b>FREQUENCY RANGE</b>	1GHz ~ 40GHz		Average (AV)

**ANTENNA POLARITY & TEST DISTANCE: HORIZONTAL AT 3 M**

NO.	FREQ. (MHz)	EMISSION LEVEL (dBuV/m)	LIMIT (dBuV/m)	MARGIN (dB)	ANTENNA HEIGHT (m)	TABLE ANGLE (Degree)	RAW VALUE (dBuV)	CORRECTION FACTOR (dB/m)
1	#5470.00	58.9 PK	74.0	-15.1	1.41 H	329	55.4	3.5
2	#5470.00	47.9 AV	54.0	-6.1	1.41 H	329	44.4	3.5
3	*5510.00	110.4 PK			1.41 H	329	106.9	3.5
4	*5510.00	101.9 AV			1.41 H	329	98.4	3.5
5	11020.00	51.8 PK	74.0	-22.2	1.59 H	305	38.1	13.7
6	11020.00	42.5 AV	54.0	-11.5	1.59 H	305	28.8	13.7
7	#16530.00	52.6 PK	74.0	-21.4	2.60 H	88	35.7	16.9
8	#16530.00	41.0 AV	54.0	-13.0	2.60 H	88	24.1	16.9

**ANTENNA POLARITY & TEST DISTANCE: VERTICAL AT 3 M**

NO.	FREQ. (MHz)	EMISSION LEVEL (dBuV/m)	LIMIT (dBuV/m)	MARGIN (dB)	ANTENNA HEIGHT (m)	TABLE ANGLE (Degree)	RAW VALUE (dBuV)	CORRECTION FACTOR (dB/m)
1	#5470.00	58.0 PK	74.0	-16.0	2.97 V	147	54.5	3.5
2	#5470.00	45.6 AV	54.0	-8.4	2.97 V	147	42.1	3.5
3	*5510.00	108.8 PK			2.97 V	147	105.3	3.5
4	*5510.00	98.0 AV			2.97 V	147	94.5	3.5
5	11020.00	55.2 PK	74.0	-18.8	1.50 V	319	41.5	13.7
6	11020.00	45.1 AV	54.0	-8.9	1.50 V	319	31.4	13.7
7	#16530.00	52.9 PK	74.0	-21.1	2.61 V	78	36.0	16.9
8	#16530.00	41.5 AV	54.0	-12.5	2.61 V	78	24.6	16.9

**REMARKS:**

1. Emission Level(dBuV/m) = Raw Value(dBuV) + Correction Factor(dB/m)
2. Correction Factor(dB/m) = Antenna Factor(dB/m) + Cable Factor(dB) – Pre-Amplifier Factor(dB)
3. The other emission levels were very low against the limit.
4. Margin value = Emission Level – Limit value
5. " \* ": Fundamental frequency.
6. " # ": The radiated frequency is out of the restricted band.

<b>CHANNEL</b>	TX Channel 110	<b>DETECTOR FUNCTION</b>	Peak (PK)
<b>FREQUENCY RANGE</b>	1GHz ~ 40GHz		Average (AV)

**ANTENNA POLARITY & TEST DISTANCE: HORIZONTAL AT 3 M**

NO.	FREQ. (MHz)	EMISSION LEVEL (dBuV/m)	LIMIT (dBuV/m)	MARGIN (dB)	ANTENNA HEIGHT (m)	TABLE ANGLE (Degree)	RAW VALUE (dBuV)	CORRECTION FACTOR (dB/m)
1	*5550.00	110.6 PK			1.50 H	328	106.9	3.7
2	*5550.00	100.4 AV			1.50 H	328	96.7	3.7
3	11100.00	51.2 PK	74.0	-22.8	1.52 H	305	37.6	13.6
4	11100.00	42.0 AV	54.0	-12.0	1.52 H	305	28.4	13.6
5	#16650.00	52.9 PK	74.0	-21.1	2.64 H	84	35.3	17.6
6	#16650.00	41.0 AV	54.0	-13.0	2.64 H	84	23.4	17.6

**ANTENNA POLARITY & TEST DISTANCE: VERTICAL AT 3 M**

NO.	FREQ. (MHz)	EMISSION LEVEL (dBuV/m)	LIMIT (dBuV/m)	MARGIN (dB)	ANTENNA HEIGHT (m)	TABLE ANGLE (Degree)	RAW VALUE (dBuV)	CORRECTION FACTOR (dB/m)
1	*5550.00	109.8 PK			2.91 V	156	106.1	3.7
2	*5550.00	99.6 AV			2.91 V	156	95.9	3.7
3	11100.00	55.4 PK	74.0	-18.6	1.52 V	321	41.8	13.6
4	11100.00	45.1 AV	54.0	-8.9	1.52 V	321	31.5	13.6
5	#16650.00	52.4 PK	74.0	-21.6	2.62 V	71	34.8	17.6
6	#16650.00	41.3 AV	54.0	-12.7	2.62 V	71	23.7	17.6

**REMARKS:**

1. Emission Level(dBuV/m) = Raw Value(dBuV) + Correction Factor(dB/m)
2. Correction Factor(dB/m) = Antenna Factor(dB/m) + Cable Factor(dB) – Pre-Amplifier Factor(dB)
3. The other emission levels were very low against the limit.
4. Margin value = Emission Level – Limit value
5. " \* ": Fundamental frequency.
6. " # ": The radiated frequency is out of the restricted band.

<b>CHANNEL</b>	TX Channel 134	<b>DETECTOR FUNCTION</b>	Peak (PK)
<b>FREQUENCY RANGE</b>	1GHz ~ 40GHz		Average (AV)

**ANTENNA POLARITY & TEST DISTANCE: HORIZONTAL AT 3 M**

NO.	FREQ. (MHz)	EMISSION LEVEL (dBuV/m)	LIMIT (dBuV/m)	MARGIN (dB)	ANTENNA HEIGHT (m)	TABLE ANGLE (Degree)	RAW VALUE (dBuV)	CORRECTION FACTOR (dB/m)
1	*5670.00	111.2 PK			1.26 H	331	107.3	3.9
2	*5670.00	101.1 AV			1.26 H	331	97.2	3.9
3	#5725.00	57.2 PK	74.0	-16.8	1.26 H	331	53.2	4.0
4	#5725.00	44.7 AV	54.0	-9.3	1.26 H	331	40.7	4.0
5	11340.00	51.9 PK	74.0	-22.1	1.51 H	320	37.8	14.1
6	11340.00	42.5 AV	54.0	-11.5	1.51 H	320	28.4	14.1
7	#17010.00	52.7 PK	74.0	-21.3	2.66 H	66	33.4	19.3
8	#17010.00	41.1 AV	54.0	-12.9	2.66 H	66	21.8	19.3

**ANTENNA POLARITY & TEST DISTANCE: VERTICAL AT 3 M**

NO.	FREQ. (MHz)	EMISSION LEVEL (dBuV/m)	LIMIT (dBuV/m)	MARGIN (dB)	ANTENNA HEIGHT (m)	TABLE ANGLE (Degree)	RAW VALUE (dBuV)	CORRECTION FACTOR (dB/m)
1	*5670.00	110.6 PK			1.89 V	151	106.7	3.9
2	*5670.00	100.3 AV			1.89 V	151	96.4	3.9
3	#5725.00	55.1 PK	74.0	-18.9	2.89 V	151	51.1	4.0
4	#5725.00	43.2 AV	54.0	-10.8	2.89 V	151	39.2	4.0
5	11340.00	55.2 PK	74.0	-18.8	1.57 V	305	41.1	14.1
6	11340.00	45.1 AV	54.0	-8.9	1.57 V	305	31.0	14.1
7	#17010.00	52.3 PK	74.0	-21.7	2.64 V	74	33.0	19.3
8	#17010.00	41.2 AV	54.0	-12.8	2.64 V	74	21.9	19.3

**REMARKS:**

1. Emission Level(dBuV/m) = Raw Value(dBuV) + Correction Factor(dB/m)
2. Correction Factor(dB/m) = Antenna Factor(dB/m) + Cable Factor(dB) – Pre-Amplifier Factor(dB)
3. The other emission levels were very low against the limit.
4. Margin value = Emission Level – Limit value
5. " \* ": Fundamental frequency.
6. " # ": The radiated frequency is out of the restricted band.

<b>CHANNEL</b>	TX Channel 142	<b>DETECTOR FUNCTION</b>	Peak (PK)
<b>FREQUENCY RANGE</b>	1GHz ~ 40GHz		Average (AV)

**ANTENNA POLARITY & TEST DISTANCE: HORIZONTAL AT 3 M**

NO.	FREQ. (MHz)	EMISSION LEVEL (dBuV/m)	LIMIT (dBuV/m)	MARGIN (dB)	ANTENNA HEIGHT (m)	TABLE ANGLE (Degree)	RAW VALUE (dBuV)	CORRECTION FACTOR (dB/m)
1	*5710.00	109.0 PK			1.31 H	339	105.0	4.0
2	*5710.00	101.2 AV			1.31 H	339	97.2	4.0
3	#5850.00	55.9 PK	74.0	-18.1	1.31 H	339	51.9	4.0
4	#5850.00	45.6 AV	54.0	-8.4	1.31 H	339	41.6	4.0
5	11420.00	51.0 PK	74.0	-23.0	1.52 H	306	37.1	13.9
6	11420.00	41.9 AV	54.0	-12.1	1.52 H	306	28.0	13.9
7	#17130.00	53.1 PK	74.0	-20.9	2.65 H	84	33.9	19.2
8	#17130.00	41.3 AV	54.0	-12.7	2.65 H	84	22.1	19.2

**ANTENNA POLARITY & TEST DISTANCE: VERTICAL AT 3 M**

NO.	FREQ. (MHz)	EMISSION LEVEL (dBuV/m)	LIMIT (dBuV/m)	MARGIN (dB)	ANTENNA HEIGHT (m)	TABLE ANGLE (Degree)	RAW VALUE (dBuV)	CORRECTION FACTOR (dB/m)
1	*5710.00	108.3 PK			1.77 V	160	104.3	4.0
2	*5710.00	100.1 AV			1.77 V	160	96.1	4.0
3	#5850.00	53.7 PK	74.0	-20.3	1.77 V	160	49.7	4.0
4	#5850.00	43.8 AV	54.0	-10.2	1.77 V	160	39.8	4.0
5	11420.00	55.1 PK	74.0	-18.9	1.50 V	310	41.2	13.9
6	11420.00	45.0 AV	54.0	-9.0	1.50 V	310	31.1	13.9
7	#17130.00	52.6 PK	74.0	-21.4	2.61 V	72	33.4	19.2
8	#17130.00	41.3 AV	54.0	-12.7	2.61 V	72	22.1	19.2

**REMARKS:**

1. Emission Level(dBuV/m) = Raw Value(dBuV) + Correction Factor(dB/m)
2. Correction Factor(dB/m) = Antenna Factor(dB/m) + Cable Factor(dB) – Pre-Amplifier Factor(dB)
3. The other emission levels were very low against the limit.
4. Margin value = Emission Level – Limit value
5. " \* ": Fundamental frequency.
6. " # ": The radiated frequency is out of the restricted band.

**802.11ac (VHT80)**

<b>CHANNEL</b>	TX Channel 58	<b>DETECTOR FUNCTION</b>	Peak (PK)
<b>FREQUENCY RANGE</b>	1GHz ~ 40GHz		Average (AV)

**ANTENNA POLARITY & TEST DISTANCE: HORIZONTAL AT 3 M**

NO.	FREQ. (MHz)	EMISSION LEVEL (dBuV/m)	LIMIT (dBuV/m)	MARGIN (dB)	ANTENNA HEIGHT (m)	TABLE ANGLE (Degree)	RAW VALUE (dBuV)	CORRECTION FACTOR (dB/m)
1	5150.00	55.6 PK	74.0	-18.4	1.70 H	328	52.6	3.0
2	5150.00	42.9 AV	54.0	-11.1	1.70 H	328	39.9	3.0
3	*5290.00	107.0 PK			1.70 H	328	103.9	3.1
4	*5290.00	97.2 AV			1.70 H	328	94.1	3.1
5	5350.00	65.7 PK	74.0	-8.3	1.70 H	328	62.5	3.2
<b>6</b>	<b>5350.00</b>	<b>53.5 AV</b>	<b>54.0</b>	<b>-0.5</b>	<b>1.70 H</b>	<b>328</b>	<b>50.3</b>	<b>3.2</b>
7	#10580.00	51.0 PK	74.0	-23.0	1.52 H	324	38.1	12.9
8	#10580.00	41.8 AV	54.0	-12.2	1.52 H	324	28.9	12.9
9	15870.00	53.5 PK	74.0	-20.5	2.69 H	80	39.1	14.4
10	15870.00	41.7 AV	54.0	-12.3	2.69 H	80	27.3	14.4

**ANTENNA POLARITY & TEST DISTANCE: VERTICAL AT 3 M**

NO.	FREQ. (MHz)	EMISSION LEVEL (dBuV/m)	LIMIT (dBuV/m)	MARGIN (dB)	ANTENNA HEIGHT (m)	TABLE ANGLE (Degree)	RAW VALUE (dBuV)	CORRECTION FACTOR (dB/m)
1	5150.00	54.6 PK	74.0	-19.4	2.70 V	172	51.6	3.0
2	5150.00	42.1 AV	54.0	-11.9	2.70 V	172	39.1	3.0
3	*5290.00	106.8 PK			2.70 V	172	103.7	3.1
4	*5290.00	96.1 AV			2.70 V	172	93.0	3.1
5	5350.00	65.5 PK	74.0	-8.5	2.70 V	172	62.3	3.2
6	5350.00	53.3 AV	54.0	-0.7	2.70 V	172	50.1	3.2
7	#10580.00	55.3 PK	74.0	-18.7	1.49 V	305	42.4	12.9
8	#10580.00	45.1 AV	54.0	-8.9	1.49 V	305	32.2	12.9
9	15870.00	53.0 PK	74.0	-21.0	2.71 V	78	38.6	14.4
10	15870.00	41.5 AV	54.0	-12.5	2.71 V	78	27.1	14.4

**REMARKS:**

- Emission Level(dBuV/m) = Raw Value(dBuV) + Correction Factor(dB/m)
- Correction Factor(dB/m) = Antenna Factor(dB/m) + Cable Factor(dB) – Pre-Amplifier Factor(dB)
- The other emission levels were very low against the limit.
- Margin value = Emission Level – Limit value
- " \* ": Fundamental frequency.
- " # ": The radiated frequency is out of the restricted band.

<b>CHANNEL</b>	TX Channel 106	<b>DETECTOR FUNCTION</b>	Peak (PK)
<b>FREQUENCY RANGE</b>	1GHz ~ 40GHz		Average (AV)

**ANTENNA POLARITY & TEST DISTANCE: HORIZONTAL AT 3 M**

NO.	FREQ. (MHz)	EMISSION LEVEL (dBuV/m)	LIMIT (dBuV/m)	MARGIN (dB)	ANTENNA HEIGHT (m)	TABLE ANGLE (Degree)	RAW VALUE (dBuV)	CORRECTION FACTOR (dB/m)
1	#5470.00	64.2 PK	74.0	-9.8	1.57 H	331	60.7	3.5
2	#5470.00	52.7 AV	54.0	-1.3	1.57 H	331	49.2	3.5
3	*5530.00	106.8 PK			1.57 H	331	103.2	3.6
4	*5530.00	97.6 AV			1.57 H	331	94.0	3.6
5	#5725.00	55.2 PK	74.0	-18.8	1.57 H	331	51.2	4.0
6	#5725.00	43.5 AV	54.0	-10.5	1.57 H	331	39.5	4.0
7	11060.00	51.2 PK	74.0	-22.8	1.56 H	319	37.5	13.7
8	11060.00	41.9 AV	54.0	-12.1	1.56 H	319	28.2	13.7
9	#16590.00	53.6 PK	74.0	-20.4	2.62 H	75	35.9	17.7
10	#16590.00	41.5 AV	54.0	-12.5	2.62 H	75	23.8	17.7

**ANTENNA POLARITY & TEST DISTANCE: VERTICAL AT 3 M**

NO.	FREQ. (MHz)	EMISSION LEVEL (dBuV/m)	LIMIT (dBuV/m)	MARGIN (dB)	ANTENNA HEIGHT (m)	TABLE ANGLE (Degree)	RAW VALUE (dBuV)	CORRECTION FACTOR (dB/m)
1	#5470.00	61.6 PK	74.0	-12.4	2.32 V	173	58.1	3.5
2	#5470.00	50.6 AV	54.0	-3.4	2.32 V	173	47.1	3.5
3	*5530.00	105.2 PK			2.32 V	173	101.6	3.6
4	*5530.00	95.7 AV			2.32 V	173	92.1	3.6
5	#5725.00	54.5 PK	74.0	-19.5	2.32 V	173	50.5	4.0
6	#5725.00	43.2 AV	54.0	-10.8	2.32 V	173	39.2	4.0
7	11060.00	55.3 PK	74.0	-18.7	1.53 V	307	41.6	13.7
8	11060.00	45.1 AV	54.0	-8.9	1.53 V	307	31.4	13.7
9	#16590.00	52.4 PK	74.0	-21.6	2.62 V	83	34.7	17.7
10	#16590.00	41.3 AV	54.0	-12.7	2.62 V	83	23.6	17.7

**REMARKS:**

1. Emission Level(dBuV/m) = Raw Value(dBuV) + Correction Factor(dB/m)
2. Correction Factor(dB/m) = Antenna Factor(dB/m) + Cable Factor(dB) – Pre-Amplifier Factor(dB)
3. The other emission levels were very low against the limit.
4. Margin value = Emission Level – Limit value
5. " \* ": Fundamental frequency.
6. " # ": The radiated frequency is out of the restricted band.

<b>CHANNEL</b>	TX Channel 122	<b>DETECTOR FUNCTION</b>	Peak (PK)
<b>FREQUENCY RANGE</b>	1GHz ~ 40GHz		Average (AV)

**ANTENNA POLARITY & TEST DISTANCE: HORIZONTAL AT 3 M**

NO.	FREQ. (MHz)	EMISSION LEVEL (dBuV/m)	LIMIT (dBuV/m)	MARGIN (dB)	ANTENNA HEIGHT (m)	TABLE ANGLE (Degree)	RAW VALUE (dBuV)	CORRECTION FACTOR (dB/m)
1	*5610.00	108.7 PK			1.61 H	335	104.9	3.8
2	*5610.00	98.8 AV			1.61 H	335	95.0	3.8
3	#5725.00	55.8 PK	74.0	-18.2	1.61 H	335	51.8	4.0
4	#5725.00	44.6 AV	54.0	-9.4	1.61 H	335	40.6	4.0
5	11220.00	51.5 PK	74.0	-22.5	1.60 H	321	37.6	13.9
6	11220.00	41.9 AV	54.0	-12.1	1.60 H	321	28.0	13.9
7	#16830.00	53.6 PK	74.0	-20.4	2.66 H	78	35.6	18.0
8	#16830.00	41.6 AV	54.0	-12.4	2.66 H	78	23.6	18.0

**ANTENNA POLARITY & TEST DISTANCE: VERTICAL AT 3 M**

NO.	FREQ. (MHz)	EMISSION LEVEL (dBuV/m)	LIMIT (dBuV/m)	MARGIN (dB)	ANTENNA HEIGHT (m)	TABLE ANGLE (Degree)	RAW VALUE (dBuV)	CORRECTION FACTOR (dB/m)
1	*5610.00	107.4 PK			2.14 V	279	103.6	3.8
2	*5610.00	97.1 AV			2.14 V	279	93.3	3.8
3	#5725.00	55.2 PK	74.0	-18.8	2.14 V	279	51.2	4.0
4	#5725.00	44.1 AV	54.0	-9.9	2.14 V	279	40.1	4.0
5	11220.00	55.0 PK	74.0	-19.0	1.56 V	308	41.1	13.9
6	11220.00	44.6 AV	54.0	-9.4	1.56 V	308	30.7	13.9
7	#16830.00	53.2 PK	74.0	-20.8	2.65 V	87	35.2	18.0
8	#16830.00	41.9 AV	54.0	-12.1	2.65 V	87	23.9	18.0

**REMARKS:**

1. Emission Level(dBuV/m) = Raw Value(dBuV) + Correction Factor(dB/m)
2. Correction Factor(dB/m) = Antenna Factor(dB/m) + Cable Factor(dB) – Pre-Amplifier Factor(dB)
3. The other emission levels were very low against the limit.
4. Margin value = Emission Level – Limit value
5. " \* ": Fundamental frequency.
6. " # ": The radiated frequency is out of the restricted band.

<b>CHANNEL</b>	TX Channel 138	<b>DETECTOR FUNCTION</b>	Peak (PK)
<b>FREQUENCY RANGE</b>	1GHz ~ 40GHz		Average (AV)

**ANTENNA POLARITY & TEST DISTANCE: HORIZONTAL AT 3 M**

NO.	FREQ. (MHz)	EMISSION LEVEL (dBuV/m)	LIMIT (dBuV/m)	MARGIN (dB)	ANTENNA HEIGHT (m)	TABLE ANGLE (Degree)	RAW VALUE (dBuV)	CORRECTION FACTOR (dB/m)
1	*5690.00	107.3 PK			1.35 H	334	103.3	4.0
2	*5690.00	98.1 AV			1.35 H	334	94.1	4.0
3	#5850.00	56.0 PK	74.0	-18.0	1.35 H	334	52.0	4.0
4	#5850.00	45.3 AV	54.0	-8.7	1.35 H	334	41.3	4.0
5	11380.00	51.0 PK	74.0	-23.0	1.59 H	308	37.1	13.9
6	11380.00	42.0 AV	54.0	-12.0	1.59 H	308	28.1	13.9
7	#17070.00	52.9 PK	74.0	-21.1	2.68 H	94	33.6	19.3
8	#17070.00	40.9 AV	54.0	-13.1	2.68 H	94	21.6	19.3

**ANTENNA POLARITY & TEST DISTANCE: VERTICAL AT 3 M**

NO.	FREQ. (MHz)	EMISSION LEVEL (dBuV/m)	LIMIT (dBuV/m)	MARGIN (dB)	ANTENNA HEIGHT (m)	TABLE ANGLE (Degree)	RAW VALUE (dBuV)	CORRECTION FACTOR (dB/m)
1	*5690.00	106.1 PK			2.21 V	184	102.1	4.0
2	*5690.00	96.6 AV			2.21 V	184	92.6	4.0
3	#5850.00	55.2 PK	74.0	-18.8	2.21 V	184	51.2	4.0
4	#5850.00	44.9 AV	54.0	-9.1	2.21 V	184	40.9	4.0
5	11380.00	54.4 PK	74.0	-19.6	1.59 V	313	40.5	13.9
6	11380.00	44.3 AV	54.0	-9.7	1.59 V	313	30.4	13.9
7	#17070.00	52.5 PK	74.0	-21.5	2.69 V	85	33.2	19.3
8	#17070.00	41.1 AV	54.0	-12.9	2.69 V	85	21.8	19.3

**REMARKS:**

1. Emission Level(dBuV/m) = Raw Value(dBuV) + Correction Factor(dB/m)
2. Correction Factor(dB/m) = Antenna Factor(dB/m) + Cable Factor(dB) – Pre-Amplifier Factor(dB)
3. The other emission levels were very low against the limit.
4. Margin value = Emission Level – Limit value
5. " \* ": Fundamental frequency.
6. " # ": The radiated frequency is out of the restricted band.



## Beamforming Mode

### 802.11ac (VHT20)

<b>CHANNEL</b>	TX Channel 52	<b>DETECTOR FUNCTION</b>	Peak (PK)
<b>FREQUENCY RANGE</b>	1GHz ~ 40GHz		Average (AV)

#### ANTENNA POLARITY & TEST DISTANCE: HORIZONTAL AT 3 M

NO.	FREQ. (MHz)	EMISSION LEVEL (dBuV/m)	LIMIT (dBuV/m)	MARGIN (dB)	ANTENNA HEIGHT (m)	TABLE ANGLE (Degree)	RAW VALUE (dBuV)	CORRECTION FACTOR (dB/m)
1	5150.00	54.0 PK	74.0	-20.0	2.04 H	346	51.0	3.0
2	5150.00	43.0 AV	54.0	-11.0	2.04 H	346	40.0	3.0
3	*5260.00	112.3 PK			2.01 H	69	109.2	3.1
4	*5260.00	101.4 AV			2.01 H	69	98.3	3.1
5	#10520.00	51.6 PK	74.0	-22.4	1.65 H	343	38.7	12.9
6	#10520.00	39.1 AV	54.0	-14.9	1.65 H	343	26.2	12.9
7	15780.00	54.2 PK	74.0	-19.8	2.70 H	139	39.4	14.8
8	15780.00	40.7 AV	54.0	-13.3	2.70 H	139	25.9	14.8

#### ANTENNA POLARITY & TEST DISTANCE: VERTICAL AT 3 M

NO.	FREQ. (MHz)	EMISSION LEVEL (dBuV/m)	LIMIT (dBuV/m)	MARGIN (dB)	ANTENNA HEIGHT (m)	TABLE ANGLE (Degree)	RAW VALUE (dBuV)	CORRECTION FACTOR (dB/m)
1	5150.00	52.7 PK	74.0	-21.3	2.35 V	189	49.7	3.0
2	5150.00	42.8 AV	54.0	-11.2	2.35 V	189	39.8	3.0
3	*5260.00	111.5 PK			2.37 V	209	108.4	3.1
4	*5260.00	99.2 AV			2.37 V	209	96.1	3.1
5	#10520.00	50.8 PK	74.0	-23.2	2.20 V	305	37.9	12.9
6	#10520.00	38.9 AV	54.0	-15.1	2.20 V	305	26.0	12.9
7	15780.00	53.3 PK	74.0	-20.7	1.18 V	135	38.5	14.8
8	15780.00	40.2 AV	54.0	-13.8	1.18 V	135	25.4	14.8

#### REMARKS:

1. Emission Level(dBuV/m) = Raw Value(dBuV) + Correction Factor(dB/m)
2. Correction Factor(dB/m) = Antenna Factor(dB/m) + Cable Factor(dB) – Pre-Amplifier Factor(dB)
3. The other emission levels were very low against the limit.
4. Margin value = Emission Level – Limit value
5. " \* ": Fundamental frequency.
6. " # ": The radiated frequency is out of the restricted band.

<b>CHANNEL</b>	TX Channel 60	<b>DETECTOR FUNCTION</b>	Peak (PK)
<b>FREQUENCY RANGE</b>	1GHz ~ 40GHz		Average (AV)

**ANTENNA POLARITY & TEST DISTANCE: HORIZONTAL AT 3 M**

NO.	FREQ. (MHz)	EMISSION LEVEL (dBuV/m)	LIMIT (dBuV/m)	MARGIN (dB)	ANTENNA HEIGHT (m)	TABLE ANGLE (Degree)	RAW VALUE (dBuV)	CORRECTION FACTOR (dB/m)
1	*5300.00	111.6 PK			1.94 H	72	108.5	3.1
2	*5300.00	101.1 AV			1.94 H	72	98.0	3.1
3	10600.00	51.0 PK	74.0	-23.0	1.60 H	318	38.0	13.0
4	10600.00	38.7 AV	54.0	-15.3	1.60 H	318	25.7	13.0
5	15900.00	54.2 PK	74.0	-19.8	2.69 H	141	39.9	14.3
6	15900.00	40.8 AV	54.0	-13.2	2.69 H	141	26.5	14.3

**ANTENNA POLARITY & TEST DISTANCE: VERTICAL AT 3 M**

NO.	FREQ. (MHz)	EMISSION LEVEL (dBuV/m)	LIMIT (dBuV/m)	MARGIN (dB)	ANTENNA HEIGHT (m)	TABLE ANGLE (Degree)	RAW VALUE (dBuV)	CORRECTION FACTOR (dB/m)
1	*5300.00	111.2 PK			2.40 V	196	108.1	3.1
2	*5300.00	98.8 AV			2.40 V	196	95.7	3.1
3	10600.00	51.9 PK	74.0	-22.1	2.28 V	285	38.9	13.0
4	10600.00	39.4 AV	54.0	-14.6	2.28 V	285	26.4	13.0
5	15900.00	53.6 PK	74.0	-20.4	1.29 V	130	39.3	14.3
6	15900.00	40.6 AV	54.0	-13.4	1.29 V	130	26.3	14.3

**REMARKS:**

1. Emission Level(dBuV/m) = Raw Value(dBuV) + Correction Factor(dB/m)
2. Correction Factor(dB/m) = Antenna Factor(dB/m) + Cable Factor(dB) – Pre-Amplifier Factor(dB)
3. The other emission levels were very low against the limit.
4. Margin value = Emission Level – Limit value
5. " \* ": Fundamental frequency.

<b>CHANNEL</b>	TX Channel 64	<b>DETECTOR FUNCTION</b>	Peak (PK)
<b>FREQUENCY RANGE</b>	1GHz ~ 40GHz		Average (AV)

**ANTENNA POLARITY & TEST DISTANCE: HORIZONTAL AT 3 M**

NO.	FREQ. (MHz)	EMISSION LEVEL (dBuV/m)	LIMIT (dBuV/m)	MARGIN (dB)	ANTENNA HEIGHT (m)	TABLE ANGLE (Degree)	RAW VALUE (dBuV)	CORRECTION FACTOR (dB/m)
1	*5320.00	112.1 PK			2.00 H	76	108.9	3.2
2	*5320.00	101.3 AV			2.00 H	76	98.1	3.2
3	5350.00	57.9 PK	74.0	-16.1	2.00 H	76	54.7	3.2
4	5350.00	45.6 AV	54.0	-8.4	2.00 H	76	42.4	3.2
5	10640.00	51.3 PK	74.0	-22.7	1.69 H	346	38.3	13.0
6	10640.00	39.2 AV	54.0	-14.8	1.69 H	346	26.2	13.0
7	15960.00	54.2 PK	74.0	-19.8	2.72 H	127	39.7	14.5
8	15960.00	40.6 AV	54.0	-13.4	2.72 H	127	26.1	14.5

**ANTENNA POLARITY & TEST DISTANCE: VERTICAL AT 3 M**

NO.	FREQ. (MHz)	EMISSION LEVEL (dBuV/m)	LIMIT (dBuV/m)	MARGIN (dB)	ANTENNA HEIGHT (m)	TABLE ANGLE (Degree)	RAW VALUE (dBuV)	CORRECTION FACTOR (dB/m)
1	*5320.00	111.7 PK			2.35 V	198	108.5	3.2
2	*5320.00	99.1 AV			2.35 V	198	95.9	3.2
3	5350.00	58.5 PK	74.0	-15.5	2.35 V	198	55.3	3.2
4	5350.00	46.1 AV	54.0	-7.9	2.35 V	198	42.9	3.2
5	10640.00	51.5 PK	74.0	-22.5	2.25 V	298	38.5	13.0
6	10640.00	39.3 AV	54.0	-14.7	2.25 V	298	26.3	13.0
7	15960.00	53.6 PK	74.0	-20.4	1.24 V	138	39.1	14.5
8	15960.00	40.6 AV	54.0	-13.4	1.24 V	138	26.1	14.5

**REMARKS:**

1. Emission Level(dBuV/m) = Raw Value(dBuV) + Correction Factor(dB/m)
2. Correction Factor(dB/m) = Antenna Factor(dB/m) + Cable Factor(dB) – Pre-Amplifier Factor(dB)
3. The other emission levels were very low against the limit.
4. Margin value = Emission Level – Limit value
5. " \* ": Fundamental frequency.

<b>CHANNEL</b>	TX Channel 100	<b>DETECTOR FUNCTION</b>	Peak (PK)
<b>FREQUENCY RANGE</b>	1GHz ~ 40GHz		Average (AV)

**ANTENNA POLARITY & TEST DISTANCE: HORIZONTAL AT 3 M**

NO.	FREQ. (MHz)	EMISSION LEVEL (dBuV/m)	LIMIT (dBuV/m)	MARGIN (dB)	ANTENNA HEIGHT (m)	TABLE ANGLE (Degree)	RAW VALUE (dBuV)	CORRECTION FACTOR (dB/m)
1	#5470.00	57.3 PK	74.0	-16.7	2.01 H	81	53.8	3.5
2	#5470.00	45.1 AV	54.0	-8.9	2.01 H	81	41.6	3.5
3	*5500.00	112.6 PK			2.05 H	71	109.1	3.5
4	*5500.00	101.7 AV			2.05 H	71	98.2	3.5
5	11000.00	51.2 PK	74.0	-22.8	1.64 H	338	37.5	13.7
6	11000.00	39.2 AV	54.0	-14.8	1.64 H	338	25.5	13.7
7	#16500.00	54.1 PK	74.0	-19.9	2.67 H	134	37.6	16.5
8	#16500.00	40.5 AV	54.0	-13.5	2.67 H	134	24.0	16.5

**ANTENNA POLARITY & TEST DISTANCE: VERTICAL AT 3 M**

NO.	FREQ. (MHz)	EMISSION LEVEL (dBuV/m)	LIMIT (dBuV/m)	MARGIN (dB)	ANTENNA HEIGHT (m)	TABLE ANGLE (Degree)	RAW VALUE (dBuV)	CORRECTION FACTOR (dB/m)
1	#5470.00	58.0 PK	74.0	-16.0	2.29 V	201	54.5	3.5
2	#5470.00	45.8 AV	54.0	-8.2	2.29 V	201	42.3	3.5
3	*5500.00	112.0 PK			2.40 V	188	108.5	3.5
4	*5500.00	99.2 AV			2.40 V	188	95.7	3.5
5	11000.00	51.8 PK	74.0	-22.2	2.25 V	310	38.1	13.7
6	11000.00	39.4 AV	54.0	-14.6	2.25 V	310	25.7	13.7
7	#16500.00	53.4 PK	74.0	-20.6	1.27 V	145	36.9	16.5
8	#16500.00	40.3 AV	54.0	-13.7	1.27 V	145	23.8	16.5

**REMARKS:**

1. Emission Level(dBuV/m) = Raw Value(dBuV) + Correction Factor(dB/m)
2. Correction Factor(dB/m) = Antenna Factor(dB/m) + Cable Factor(dB) – Pre-Amplifier Factor(dB)
3. The other emission levels were very low against the limit.
4. Margin value = Emission Level – Limit value
5. " \* ": Fundamental frequency.
6. " # ": The radiated frequency is out of the restricted band.

<b>CHANNEL</b>	TX Channel 116	<b>DETECTOR FUNCTION</b>	Peak (PK)
<b>FREQUENCY RANGE</b>	1GHz ~ 40GHz		Average (AV)

**ANTENNA POLARITY & TEST DISTANCE: HORIZONTAL AT 3 M**

NO.	FREQ. (MHz)	EMISSION LEVEL (dBuV/m)	LIMIT (dBuV/m)	MARGIN (dB)	ANTENNA HEIGHT (m)	TABLE ANGLE (Degree)	RAW VALUE (dBuV)	CORRECTION FACTOR (dB/m)
1	*5580.00	112.3 PK			2.05 H	79	108.6	3.7
2	*5580.00	101.4 AV			2.05 H	79	97.7	3.7
3	11160.00	51.6 PK	74.0	-22.4	1.69 H	356	37.8	13.8
4	11160.00	39.4 AV	54.0	-14.6	1.69 H	356	25.6	13.8
5	#16740.00	54.2 PK	74.0	-19.8	2.68 H	132	36.7	17.5
6	#16740.00	40.3 AV	54.0	-13.7	2.68 H	132	22.8	17.5

**ANTENNA POLARITY & TEST DISTANCE: VERTICAL AT 3 M**

NO.	FREQ. (MHz)	EMISSION LEVEL (dBuV/m)	LIMIT (dBuV/m)	MARGIN (dB)	ANTENNA HEIGHT (m)	TABLE ANGLE (Degree)	RAW VALUE (dBuV)	CORRECTION FACTOR (dB/m)
1	*5580.00	111.3 PK			2.37 V	203	107.6	3.7
2	*5580.00	98.9 AV			2.37 V	203	95.2	3.7
3	11160.00	51.3 PK	74.0	-22.7	2.31 V	304	37.5	13.8
4	11160.00	39.3 AV	54.0	-14.7	2.31 V	304	25.5	13.8
5	#16740.00	53.9 PK	74.0	-20.1	1.20 V	131	36.4	17.5
6	#16740.00	40.6 AV	54.0	-13.4	1.20 V	131	23.1	17.5

**REMARKS:**

1. Emission Level(dBuV/m) = Raw Value(dBuV) + Correction Factor(dB/m)
2. Correction Factor(dB/m) = Antenna Factor(dB/m) + Cable Factor(dB) – Pre-Amplifier Factor(dB)
3. The other emission levels were very low against the limit.
4. Margin value = Emission Level – Limit value
5. " \* ": Fundamental frequency.
6. " # ": The radiated frequency is out of the restricted band.

<b>CHANNEL</b>	TX Channel 140	<b>DETECTOR FUNCTION</b>	Peak (PK)
<b>FREQUENCY RANGE</b>	1GHz ~ 40GHz		Average (AV)

**ANTENNA POLARITY & TEST DISTANCE: HORIZONTAL AT 3 M**

NO.	FREQ. (MHz)	EMISSION LEVEL (dBuV/m)	LIMIT (dBuV/m)	MARGIN (dB)	ANTENNA HEIGHT (m)	TABLE ANGLE (Degree)	RAW VALUE (dBuV)	CORRECTION FACTOR (dB/m)
1	*5700.00	111.7 PK			1.97 H	67	107.7	4.0
2	*5700.00	101.0 AV			1.97 H	67	97.0	4.0
3	#5725.00	58.3 PK	74.0	-15.7	2.18 H	72	54.3	4.0
4	#5725.00	45.7 AV	54.0	-8.3	2.18 H	72	41.7	4.0
5	11400.00	51.0 PK	74.0	-23.0	1.69 H	331	37.2	13.8
6	11400.00	39.2 AV	54.0	-14.8	1.69 H	331	25.4	13.8
7	#17100.00	54.2 PK	74.0	-19.8	2.75 H	129	35.1	19.1
8	#17100.00	40.4 AV	54.0	-13.6	2.75 H	129	21.3	19.1

**ANTENNA POLARITY & TEST DISTANCE: VERTICAL AT 3 M**

NO.	FREQ. (MHz)	EMISSION LEVEL (dBuV/m)	LIMIT (dBuV/m)	MARGIN (dB)	ANTENNA HEIGHT (m)	TABLE ANGLE (Degree)	RAW VALUE (dBuV)	CORRECTION FACTOR (dB/m)
1	*5700.00	111.5 PK			2.33 V	206	107.5	4.0
2	*5700.00	99.1 AV			2.33 V	206	95.1	4.0
3	#5725.00	60.0 PK	74.0	-14.0	2.30 V	195	56.0	4.0
4	#5725.00	46.3 AV	54.0	-7.7	2.30 V	195	42.3	4.0
5	11400.00	51.5 PK	74.0	-22.5	2.24 V	300	37.7	13.8
6	11400.00	39.1 AV	54.0	-14.9	2.24 V	300	25.3	13.8
7	#17100.00	54.0 PK	74.0	-20.0	1.25 V	139	34.9	19.1
8	#17100.00	40.8 AV	54.0	-13.2	1.25 V	139	21.7	19.1

**REMARKS:**

1. Emission Level(dBuV/m) = Raw Value(dBuV) + Correction Factor(dB/m)
2. Correction Factor(dB/m) = Antenna Factor(dB/m) + Cable Factor(dB) – Pre-Amplifier Factor(dB)
3. The other emission levels were very low against the limit.
4. Margin value = Emission Level – Limit value
5. " \* ": Fundamental frequency.
6. " # ": The radiated frequency is out of the restricted band.

<b>CHANNEL</b>	TX Channel 144	<b>DETECTOR FUNCTION</b>	Peak (PK)
<b>FREQUENCY RANGE</b>	1GHz ~ 40GHz		Average (AV)

**ANTENNA POLARITY & TEST DISTANCE: HORIZONTAL AT 3 M**

NO.	FREQ. (MHz)	EMISSION LEVEL (dBuV/m)	LIMIT (dBuV/m)	MARGIN (dB)	ANTENNA HEIGHT (m)	TABLE ANGLE (Degree)	RAW VALUE (dBuV)	CORRECTION FACTOR (dB/m)
1	*5720.00	111.9 PK			1.94 H	62	107.9	4.0
2	*5720.00	100.9 AV			1.94 H	62	96.9	4.0
3	#5850.00	57.9 PK	74.0	-16.1	2.16 H	58	53.9	4.0
4	#5850.00	45.3 AV	54.0	-8.7	2.16 H	58	41.3	4.0
5	11440.00	51.3 PK	74.0	-22.7	1.73 H	338	37.4	13.9
6	11440.00	39.0 AV	54.0	-15.0	1.73 H	338	25.1	13.9
7	#17160.00	54.9 PK	74.0	-19.1	2.70 H	141	35.6	19.3
8	#17160.00	41.0 AV	54.0	-13.0	2.70 H	141	21.7	19.3

**ANTENNA POLARITY & TEST DISTANCE: VERTICAL AT 3 M**

NO.	FREQ. (MHz)	EMISSION LEVEL (dBuV/m)	LIMIT (dBuV/m)	MARGIN (dB)	ANTENNA HEIGHT (m)	TABLE ANGLE (Degree)	RAW VALUE (dBuV)	CORRECTION FACTOR (dB/m)
1	*5720.00	111.3 PK			2.35 V	198	107.3	4.0
2	*5720.00	98.9 AV			2.35 V	198	94.9	4.0
3	#5850.00	58.9 PK	74.0	-15.1	2.26 V	187	54.9	4.0
4	#5850.00	45.8 AV	54.0	-8.2	2.26 V	187	41.8	4.0
5	11440.00	52.0 PK	74.0	-22.0	2.24 V	295	38.1	13.9
6	11440.00	39.8 AV	54.0	-14.2	2.24 V	295	25.9	13.9
7	#17160.00	53.4 PK	74.0	-20.6	1.29 V	140	34.1	19.3
8	#17160.00	40.5 AV	54.0	-13.5	1.29 V	140	21.2	19.3

**REMARKS:**

1. Emission Level(dBuV/m) = Raw Value(dBuV) + Correction Factor(dB/m)
2. Correction Factor(dB/m) = Antenna Factor(dB/m) + Cable Factor(dB) – Pre-Amplifier Factor(dB)
3. The other emission levels were very low against the limit.
4. Margin value = Emission Level – Limit value
5. " \* ": Fundamental frequency.
6. " # ": The radiated frequency is out of the restricted band.

**802.11ac (VHT40)**

<b>CHANNEL</b>	TX Channel 54	<b>DETECTOR FUNCTION</b>	Peak (PK)
<b>FREQUENCY RANGE</b>	1GHz ~ 40GHz		Average (AV)

**ANTENNA POLARITY & TEST DISTANCE: HORIZONTAL AT 3 M**

NO.	FREQ. (MHz)	EMISSION LEVEL (dBuV/m)	LIMIT (dBuV/m)	MARGIN (dB)	ANTENNA HEIGHT (m)	TABLE ANGLE (Degree)	RAW VALUE (dBuV)	CORRECTION FACTOR (dB/m)
1	5150.00	53.8 PK	74.0	-20.2	1.99 H	335	50.8	3.0
2	5150.00	42.8 AV	54.0	-11.2	1.99 H	335	39.8	3.0
3	*5270.00	109.4 PK			1.99 H	335	106.2	3.2
4	*5270.00	98.3 AV			1.99 H	335	95.1	3.2
5	#10540.00	51.3 PK	74.0	-22.7	1.70 H	343	38.4	12.9
6	#10540.00	39.2 AV	54.0	-14.8	1.70 H	343	26.3	12.9
7	15810.00	54.7 PK	74.0	-19.3	2.78 H	137	40.0	14.7
8	15810.00	40.8 AV	54.0	-13.2	2.78 H	137	26.1	14.7

**ANTENNA POLARITY & TEST DISTANCE: VERTICAL AT 3 M**

NO.	FREQ. (MHz)	EMISSION LEVEL (dBuV/m)	LIMIT (dBuV/m)	MARGIN (dB)	ANTENNA HEIGHT (m)	TABLE ANGLE (Degree)	RAW VALUE (dBuV)	CORRECTION FACTOR (dB/m)
1	5150.00	53.2 PK	74.0	-20.8	2.33 V	193	50.2	3.0
2	5150.00	43.1 AV	54.0	-10.9	2.33 V	193	40.1	3.0
3	*5270.00	108.3 PK			2.33 V	193	105.1	3.2
4	*5270.00	95.6 AV			2.33 V	193	92.4	3.2
5	#10540.00	51.4 PK	74.0	-22.6	2.28 V	294	38.5	12.9
6	#10540.00	39.4 AV	54.0	-14.6	2.28 V	294	26.5	12.9
7	15810.00	53.5 PK	74.0	-20.5	1.25 V	138	38.8	14.7
8	15810.00	40.4 AV	54.0	-13.6	1.25 V	138	25.7	14.7

**REMARKS:**

- Emission Level(dBuV/m) = Raw Value(dBuV) + Correction Factor(dB/m)
- Correction Factor(dB/m) = Antenna Factor(dB/m) + Cable Factor(dB) – Pre-Amplifier Factor(dB)
- The other emission levels were very low against the limit.
- Margin value = Emission Level – Limit value
- " \* ": Fundamental frequency.
- " # ": The radiated frequency is out of the restricted band.



<b>CHANNEL</b>	TX Channel 62	<b>DETECTOR FUNCTION</b>	Peak (PK)
<b>FREQUENCY RANGE</b>	1GHz ~ 40GHz		Average (AV)

**ANTENNA POLARITY & TEST DISTANCE: HORIZONTAL AT 3 M**

NO.	FREQ. (MHz)	EMISSION LEVEL (dBuV/m)	LIMIT (dBuV/m)	MARGIN (dB)	ANTENNA HEIGHT (m)	TABLE ANGLE (Degree)	RAW VALUE (dBuV)	CORRECTION FACTOR (dB/m)
1	*5310.00	109.0 PK			2.00 H	325	105.8	3.2
2	*5310.00	98.0 AV			2.00 H	325	94.8	3.2
3	5350.00	63.4 PK	74.0	-10.6	2.00 H	325	60.2	3.2
4	5350.00	50.3 AV	54.0	-3.7	2.00 H	325	47.1	3.2
5	10620.00	50.8 PK	74.0	-23.2	1.68 H	333	37.8	13.0
6	10620.00	38.9 AV	54.0	-15.1	1.68 H	333	25.9	13.0
7	15930.00	54.2 PK	74.0	-19.8	2.72 H	129	39.8	14.4
8	15930.00	40.8 AV	54.0	-13.2	2.72 H	129	26.4	14.4

**ANTENNA POLARITY & TEST DISTANCE: VERTICAL AT 3 M**

NO.	FREQ. (MHz)	EMISSION LEVEL (dBuV/m)	LIMIT (dBuV/m)	MARGIN (dB)	ANTENNA HEIGHT (m)	TABLE ANGLE (Degree)	RAW VALUE (dBuV)	CORRECTION FACTOR (dB/m)
1	*5310.00	108.8 PK			2.31 V	179	105.6	3.2
2	*5310.00	96.0 AV			2.31 V	179	92.8	3.2
3	5350.00	63.7 PK	74.0	-10.3	2.31 V	179	60.5	3.2
4	5350.00	51.1 AV	54.0	-2.9	2.31 V	179	47.9	3.2
5	10620.00	51.3 PK	74.0	-22.7	2.27 V	298	38.3	13.0
6	10620.00	39.0 AV	54.0	-15.0	2.27 V	298	26.0	13.0
7	15930.00	53.3 PK	74.0	-20.7	1.18 V	148	38.9	14.4
8	15930.00	40.5 AV	54.0	-13.5	1.18 V	148	26.1	14.4

**REMARKS:**

1. Emission Level(dBuV/m) = Raw Value(dBuV) + Correction Factor(dB/m)
2. Correction Factor(dB/m) = Antenna Factor(dB/m) + Cable Factor(dB) – Pre-Amplifier Factor(dB)
3. The other emission levels were very low against the limit.
4. Margin value = Emission Level – Limit value
5. " \* ": Fundamental frequency.

<b>CHANNEL</b>	TX Channel 102	<b>DETECTOR FUNCTION</b>	Peak (PK)
<b>FREQUENCY RANGE</b>	1GHz ~ 40GHz		Average (AV)

**ANTENNA POLARITY & TEST DISTANCE: HORIZONTAL AT 3 M**

NO.	FREQ. (MHz)	EMISSION LEVEL (dBuV/m)	LIMIT (dBuV/m)	MARGIN (dB)	ANTENNA HEIGHT (m)	TABLE ANGLE (Degree)	RAW VALUE (dBuV)	CORRECTION FACTOR (dB/m)
1	#5470.00	63.9 PK	74.0	-10.1	2.16 H	76	60.4	3.5
2	#5470.00	50.9 AV	54.0	-3.1	2.16 H	76	47.4	3.5
3	*5510.00	109.7 PK			2.16 H	76	106.2	3.5
4	*5510.00	98.3 AV			2.16 H	76	94.8	3.5
5	11020.00	51.1 PK	74.0	-22.9	1.66 H	346	37.4	13.7
6	11020.00	39.1 AV	54.0	-14.9	1.66 H	346	25.4	13.7
7	#16530.00	54.0 PK	74.0	-20.0	2.70 H	118	37.1	16.9
8	#16530.00	40.4 AV	54.0	-13.6	2.70 H	118	23.5	16.9

**ANTENNA POLARITY & TEST DISTANCE: VERTICAL AT 3 M**

NO.	FREQ. (MHz)	EMISSION LEVEL (dBuV/m)	LIMIT (dBuV/m)	MARGIN (dB)	ANTENNA HEIGHT (m)	TABLE ANGLE (Degree)	RAW VALUE (dBuV)	CORRECTION FACTOR (dB/m)
1	#5470.00	64.1 PK	74.0	-9.9	2.35 V	194	60.6	3.5
2	#5470.00	51.3 AV	54.0	-2.7	2.35 V	194	47.8	3.5
3	*5510.00	108.7 PK			2.35 V	194	105.2	3.5
4	*5510.00	96.0 AV			2.35 V	194	92.5	3.5
5	11020.00	51.9 PK	74.0	-22.1	2.25 V	295	38.2	13.7
6	11020.00	39.5 AV	54.0	-14.5	2.25 V	295	25.8	13.7
7	#16530.00	53.3 PK	74.0	-20.7	1.26 V	127	36.4	16.9
8	#16530.00	40.2 AV	54.0	-13.8	1.26 V	127	23.3	16.9

**REMARKS:**

1. Emission Level(dBuV/m) = Raw Value(dBuV) + Correction Factor(dB/m)
2. Correction Factor(dB/m) = Antenna Factor(dB/m) + Cable Factor(dB) – Pre-Amplifier Factor(dB)
3. The other emission levels were very low against the limit.
4. Margin value = Emission Level – Limit value
5. " \* ": Fundamental frequency.
6. " # ": The radiated frequency is out of the restricted band.

<b>CHANNEL</b>	TX Channel 110	<b>DETECTOR FUNCTION</b>	Peak (PK)
<b>FREQUENCY RANGE</b>	1GHz ~ 40GHz		Average (AV)

**ANTENNA POLARITY & TEST DISTANCE: HORIZONTAL AT 3 M**

NO.	FREQ. (MHz)	EMISSION LEVEL (dBuV/m)	LIMIT (dBuV/m)	MARGIN (dB)	ANTENNA HEIGHT (m)	TABLE ANGLE (Degree)	RAW VALUE (dBuV)	CORRECTION FACTOR (dB/m)
1	*5550.00	110.0 PK			2.14 H	82	106.3	3.7
2	*5550.00	98.4 AV			2.14 H	82	94.7	3.7
3	11100.00	51.7 PK	74.0	-22.3	1.70 H	360	38.1	13.6
4	11100.00	39.7 AV	54.0	-14.3	1.70 H	360	26.1	13.6
5	#16650.00	54.5 PK	74.0	-19.5	2.70 H	118	36.9	17.6
6	#16650.00	40.8 AV	54.0	-13.2	2.70 H	118	23.2	17.6

**ANTENNA POLARITY & TEST DISTANCE: VERTICAL AT 3 M**

NO.	FREQ. (MHz)	EMISSION LEVEL (dBuV/m)	LIMIT (dBuV/m)	MARGIN (dB)	ANTENNA HEIGHT (m)	TABLE ANGLE (Degree)	RAW VALUE (dBuV)	CORRECTION FACTOR (dB/m)
1	*5550.00	109.2 PK			2.30 V	192	105.5	3.7
2	*5550.00	96.4 AV			2.30 V	192	92.7	3.7
3	11100.00	52.1 PK	74.0	-21.9	2.22 V	284	38.5	13.6
4	11100.00	39.6 AV	54.0	-14.4	2.22 V	284	26.0	13.6
5	#16650.00	53.4 PK	74.0	-20.6	1.19 V	151	35.8	17.6
6	#16650.00	40.3 AV	54.0	-13.7	1.19 V	151	22.7	17.6

**REMARKS:**

1. Emission Level(dBuV/m) = Raw Value(dBuV) + Correction Factor(dB/m)
2. Correction Factor(dB/m) = Antenna Factor(dB/m) + Cable Factor(dB) – Pre-Amplifier Factor(dB)
3. The other emission levels were very low against the limit.
4. Margin value = Emission Level – Limit value
5. " \* ": Fundamental frequency.
6. " # ": The radiated frequency is out of the restricted band.

<b>CHANNEL</b>	TX Channel 134	<b>DETECTOR FUNCTION</b>	Peak (PK)
<b>FREQUENCY RANGE</b>	1GHz ~ 40GHz		Average (AV)

**ANTENNA POLARITY & TEST DISTANCE: HORIZONTAL AT 3 M**

NO.	FREQ. (MHz)	EMISSION LEVEL (dBuV/m)	LIMIT (dBuV/m)	MARGIN (dB)	ANTENNA HEIGHT (m)	TABLE ANGLE (Degree)	RAW VALUE (dBuV)	CORRECTION FACTOR (dB/m)
1	*5670.00	110.7 PK			2.16 H	76	106.8	3.9
2	*5670.00	98.3 AV			2.16 H	76	94.4	3.9
3	#5725.00	58.5 PK	74.0	-15.5	2.16 H	76	54.5	4.0
4	#5725.00	45.7 AV	54.0	-8.3	2.16 H	76	41.7	4.0
5	11340.00	51.9 PK	74.0	-22.1	1.68 H	344	37.8	14.1
6	11340.00	39.7 AV	54.0	-14.3	1.68 H	344	25.6	14.1
7	#17010.00	53.9 PK	74.0	-20.1	2.70 H	113	34.6	19.3
8	#17010.00	40.6 AV	54.0	-13.4	2.70 H	113	21.3	19.3

**ANTENNA POLARITY & TEST DISTANCE: VERTICAL AT 3 M**

NO.	FREQ. (MHz)	EMISSION LEVEL (dBuV/m)	LIMIT (dBuV/m)	MARGIN (dB)	ANTENNA HEIGHT (m)	TABLE ANGLE (Degree)	RAW VALUE (dBuV)	CORRECTION FACTOR (dB/m)
1	*5670.00	108.6 PK			2.30 V	184	104.7	3.9
2	*5670.00	96.5 AV			2.30 V	184	92.6	3.9
3	#5725.00	59.3 PK	74.0	-14.7	2.30 V	202	55.3	4.0
4	#5725.00	45.9 AV	54.0	-8.1	2.30 V	202	41.9	4.0
5	11340.00	52.0 PK	74.0	-22.0	2.24 V	299	37.9	14.1
6	11340.00	39.7 AV	54.0	-14.3	2.24 V	299	25.6	14.1
7	#17010.00	53.3 PK	74.0	-20.7	1.23 V	126	34.0	19.3
8	#17010.00	40.2 AV	54.0	-13.8	1.23 V	126	20.9	19.3

**REMARKS:**

1. Emission Level(dBuV/m) = Raw Value(dBuV) + Correction Factor(dB/m)
2. Correction Factor(dB/m) = Antenna Factor(dB/m) + Cable Factor(dB) – Pre-Amplifier Factor(dB)
3. The other emission levels were very low against the limit.
4. Margin value = Emission Level – Limit value
5. " \* ": Fundamental frequency.
6. " # ": The radiated frequency is out of the restricted band.

<b>CHANNEL</b>	TX Channel 142	<b>DETECTOR FUNCTION</b>	Peak (PK)
<b>FREQUENCY RANGE</b>	1GHz ~ 40GHz		Average (AV)

**ANTENNA POLARITY & TEST DISTANCE: HORIZONTAL AT 3 M**

NO.	FREQ. (MHz)	EMISSION LEVEL (dBuV/m)	LIMIT (dBuV/m)	MARGIN (dB)	ANTENNA HEIGHT (m)	TABLE ANGLE (Degree)	RAW VALUE (dBuV)	CORRECTION FACTOR (dB/m)
1	*5710.00	111.3 PK			2.18 H	73	107.3	4.0
2	*5710.00	98.7 AV			2.18 H	73	94.7	4.0
3	#5850.00	58.0 PK	74.0	-16.0	2.18 H	73	54.0	4.0
4	#5850.00	45.3 AV	54.0	-8.7	2.18 H	73	41.3	4.0
5	11420.00	50.9 PK	74.0	-23.1	1.65 H	350	37.0	13.9
6	11420.00	38.8 AV	54.0	-15.2	1.65 H	350	24.9	13.9
7	#17130.00	54.6 PK	74.0	-19.4	2.67 H	119	35.4	19.2
8	#17130.00	40.8 AV	54.0	-13.2	2.67 H	119	21.6	19.2

**ANTENNA POLARITY & TEST DISTANCE: VERTICAL AT 3 M**

NO.	FREQ. (MHz)	EMISSION LEVEL (dBuV/m)	LIMIT (dBuV/m)	MARGIN (dB)	ANTENNA HEIGHT (m)	TABLE ANGLE (Degree)	RAW VALUE (dBuV)	CORRECTION FACTOR (dB/m)
1	*5710.00	109.0 PK			2.27 V	179	105.0	4.0
2	*5710.00	96.9 AV			2.27 V	179	92.9	4.0
3	#5850.00	59.7 PK	74.0	-14.3	2.27 V	179	55.7	4.0
4	#5850.00	46.4 AV	54.0	-7.6	2.27 V	179	42.4	4.0
5	11420.00	51.5 PK	74.0	-22.5	2.29 V	295	37.6	13.9
6	11420.00	39.2 AV	54.0	-14.8	2.29 V	295	25.3	13.9
7	#17130.00	53.1 PK	74.0	-20.9	1.28 V	124	33.9	19.2
8	#17130.00	40.2 AV	54.0	-13.8	1.28 V	124	21.0	19.2

**REMARKS:**

1. Emission Level(dBuV/m) = Raw Value(dBuV) + Correction Factor(dB/m)
2. Correction Factor(dB/m) = Antenna Factor(dB/m) + Cable Factor(dB) – Pre-Amplifier Factor(dB)
3. The other emission levels were very low against the limit.
4. Margin value = Emission Level – Limit value
5. " \* ": Fundamental frequency.
6. " # ": The radiated frequency is out of the restricted band.

**802.11ac (VHT80)**

<b>CHANNEL</b>	TX Channel 58	<b>DETECTOR FUNCTION</b>	Peak (PK)
<b>FREQUENCY RANGE</b>	1GHz ~ 40GHz		Average (AV)

**ANTENNA POLARITY & TEST DISTANCE: HORIZONTAL AT 3 M**

NO.	FREQ. (MHz)	EMISSION LEVEL (dBuV/m)	LIMIT (dBuV/m)	MARGIN (dB)	ANTENNA HEIGHT (m)	TABLE ANGLE (Degree)	RAW VALUE (dBuV)	CORRECTION FACTOR (dB/m)
1	5150.00	53.7 PK	74.0	-20.3	1.38 H	332	50.7	3.0
2	5150.00	42.5 AV	54.0	-11.5	1.38 H	332	39.5	3.0
3	*5290.00	105.7 PK			1.38 H	332	102.6	3.1
4	*5290.00	96.8 AV			1.38 H	332	93.7	3.1
5	5350.00	63.2 PK	74.0	-10.8	1.38 H	332	60.0	3.2
6	5350.00	53.2 AV	54.0	-0.8	1.38 H	332	50.0	3.2
7	#10580.00	52.1 PK	74.0	-21.9	1.66 H	349	39.2	12.9
8	#10580.00	39.7 AV	54.0	-14.3	1.66 H	349	26.8	12.9
9	15870.00	53.7 PK	74.0	-20.3	2.77 H	138	39.3	14.4
10	15870.00	40.2 AV	54.0	-13.8	2.77 H	138	25.8	14.4

**ANTENNA POLARITY & TEST DISTANCE: VERTICAL AT 3 M**

NO.	FREQ. (MHz)	EMISSION LEVEL (dBuV/m)	LIMIT (dBuV/m)	MARGIN (dB)	ANTENNA HEIGHT (m)	TABLE ANGLE (Degree)	RAW VALUE (dBuV)	CORRECTION FACTOR (dB/m)
1	5150.00	53.4 PK	74.0	-20.6	2.27 V	180	50.4	3.0
2	5150.00	43.1 AV	54.0	-10.9	2.27 V	180	40.1	3.0
3	*5290.00	106.7 PK			2.27 V	180	103.6	3.1
4	*5290.00	97.0 AV			2.27 V	180	93.9	3.1
5	5350.00	62.8 PK	74.0	-11.2	2.27 V	180	59.6	3.2
6	5350.00	51.6 AV	54.0	-2.4	2.27 V	180	48.4	3.2
7	#10580.00	52.0 PK	74.0	-22.0	2.22 V	306	39.1	12.9
8	#10580.00	39.7 AV	54.0	-14.3	2.22 V	306	26.8	12.9
9	15870.00	54.0 PK	74.0	-20.0	1.23 V	134	39.6	14.4
10	15870.00	40.8 AV	54.0	-13.2	1.23 V	134	26.4	14.4

**REMARKS:**

- Emission Level(dBuV/m) = Raw Value(dBuV) + Correction Factor(dB/m)
- Correction Factor(dB/m) = Antenna Factor(dB/m) + Cable Factor(dB) – Pre-Amplifier Factor(dB)
- The other emission levels were very low against the limit.
- Margin value = Emission Level – Limit value
- " \* ": Fundamental frequency.
- " # ": The radiated frequency is out of the restricted band.

<b>CHANNEL</b>	TX Channel 106	<b>DETECTOR FUNCTION</b>	Peak (PK)
<b>FREQUENCY RANGE</b>	1GHz ~ 40GHz		Average (AV)

**ANTENNA POLARITY & TEST DISTANCE: HORIZONTAL AT 3 M**

NO.	FREQ. (MHz)	EMISSION LEVEL (dBuV/m)	LIMIT (dBuV/m)	MARGIN (dB)	ANTENNA HEIGHT (m)	TABLE ANGLE (Degree)	RAW VALUE (dBuV)	CORRECTION FACTOR (dB/m)
1	5460.00	65.1 PK	74.0	-8.9	1.50 H	330	61.6	3.5
2	5460.00	52.7 AV	54.0	-1.3	1.50 H	330	49.2	3.5
3	#5470.00	67.1 PK	68.2	-1.1	1.50 H	330	63.6	3.5
4	*5530.00	109.6 PK			1.50 H	330	106.0	3.6
5	*5530.00	98.3 AV			1.50 H	330	94.7	3.6
6	11060.00	51.7 PK	74.0	-22.3	1.70 H	336	38.0	13.7
7	11060.00	39.6 AV	54.0	-14.4	1.70 H	336	25.9	13.7
8	#16590.00	54.5 PK	68.2	-13.7	2.70 H	134	36.8	17.7

**ANTENNA POLARITY & TEST DISTANCE: VERTICAL AT 3 M**

NO.	FREQ. (MHz)	EMISSION LEVEL (dBuV/m)	LIMIT (dBuV/m)	MARGIN (dB)	ANTENNA HEIGHT (m)	TABLE ANGLE (Degree)	RAW VALUE (dBuV)	CORRECTION FACTOR (dB/m)
1	5460.00	63.9 PK	74.0	-10.1	2.00 V	360	60.4	3.5
2	5460.00	52.5 AV	54.0	-1.5	2.00 V	360	49.0	3.5
3	#5470.00	68.0 PK	68.2	-0.2	2.00 V	360	64.5	3.5
4	*5530.00	109.6 PK			2.00 V	360	106.0	3.6
5	*5530.00	98.1 AV			2.00 V	360	94.5	3.6
6	11060.00	51.1 PK	74.0	-22.9	2.23 V	300	37.4	13.7
7	11060.00	39.0 AV	54.0	-15.0	2.23 V	300	25.3	13.7
8	#16590.00	54.1 PK	68.2	-14.1	1.22 V	123	36.4	17.7

**REMARKS:**

1. Emission Level(dBuV/m) = Raw Value(dBuV) + Correction Factor(dB/m)
2. Correction Factor(dB/m) = Antenna Factor(dB/m) + Cable Factor(dB) – Pre-Amplifier Factor(dB)
3. The other emission levels were very low against the limit.
4. Margin value = Emission Level – Limit value
5. " \* ": Fundamental frequency.
6. " # ": The radiated frequency is out of the restricted band.

<b>CHANNEL</b>	TX Channel 122	<b>DETECTOR FUNCTION</b>	Peak (PK)
<b>FREQUENCY RANGE</b>	1GHz ~ 40GHz		Average (AV)

**ANTENNA POLARITY & TEST DISTANCE: HORIZONTAL AT 3 M**

NO.	FREQ. (MHz)	EMISSION LEVEL (dBuV/m)	LIMIT (dBuV/m)	MARGIN (dB)	ANTENNA HEIGHT (m)	TABLE ANGLE (Degree)	RAW VALUE (dBuV)	CORRECTION FACTOR (dB/m)
1	*5610.00	109.6 PK			1.55 H	339	105.8	3.8
2	*5610.00	98.4 AV			1.55 H	339	94.6	3.8
3	#5725.00	56.6 PK	74.0	-17.4	1.55 H	339	52.6	4.0
4	#5725.00	44.5 AV	54.0	-9.5	1.55 H	339	40.5	4.0
5	11220.00	51.5 PK	74.0	-22.5	1.69 H	337	37.6	13.9
6	11220.00	39.5 AV	54.0	-14.5	1.69 H	337	25.6	13.9
7	#16830.00	54.7 PK	74.0	-19.3	2.67 H	111	36.7	18.0
8	#16830.00	41.0 AV	54.0	-13.0	2.67 H	111	23.0	18.0

**ANTENNA POLARITY & TEST DISTANCE: VERTICAL AT 3 M**

NO.	FREQ. (MHz)	EMISSION LEVEL (dBuV/m)	LIMIT (dBuV/m)	MARGIN (dB)	ANTENNA HEIGHT (m)	TABLE ANGLE (Degree)	RAW VALUE (dBuV)	CORRECTION FACTOR (dB/m)
1	*5610.00	109.9 PK			1.95 V	3	106.1	3.8
2	*5610.00	97.8 AV			1.95 V	3	94.0	3.8
3	#5725.00	56.8 PK	74.0	-17.2	1.95 V	3	52.8	4.0
4	#5725.00	44.8 AV	54.0	-9.2	1.95 V	3	40.8	4.0
5	11220.00	51.3 PK	74.0	-22.7	2.25 V	312	37.4	13.9
6	11220.00	38.9 AV	54.0	-15.1	2.25 V	312	25.0	13.9
7	#16830.00	53.2 PK	74.0	-20.8	1.27 V	123	35.2	18.0
8	#16830.00	40.5 AV	54.0	-13.5	1.27 V	123	22.5	18.0

**REMARKS:**

1. Emission Level(dBuV/m) = Raw Value(dBuV) + Correction Factor(dB/m)
2. Correction Factor(dB/m) = Antenna Factor(dB/m) + Cable Factor(dB) – Pre-Amplifier Factor(dB)
3. The other emission levels were very low against the limit.
4. Margin value = Emission Level – Limit value
5. " \* ": Fundamental frequency.
6. " # ": The radiated frequency is out of the restricted band.



<b>CHANNEL</b>	TX Channel 138	<b>DETECTOR FUNCTION</b>	Peak (PK)
<b>FREQUENCY RANGE</b>	1GHz ~ 40GHz		Average (AV)

**ANTENNA POLARITY & TEST DISTANCE: HORIZONTAL AT 3 M**

NO.	FREQ. (MHz)	EMISSION LEVEL (dBuV/m)	LIMIT (dBuV/m)	MARGIN (dB)	ANTENNA HEIGHT (m)	TABLE ANGLE (Degree)	RAW VALUE (dBuV)	CORRECTION FACTOR (dB/m)
1	*5690.00	109.7 PK			1.46 H	335	105.7	4.0
2	*5690.00	98.5 AV			1.46 H	335	94.5	4.0
3	#5850.00	57.0 PK	74.0	-17.0	1.46 H	335	53.0	4.0
4	#5850.00	44.8 AV	54.0	-9.2	1.46 H	335	40.8	4.0
5	11380.00	51.7 PK	74.0	-22.3	1.67 H	344	37.8	13.9
6	11380.00	39.6 AV	54.0	-14.4	1.67 H	344	25.7	13.9
7	#17070.00	54.0 PK	74.0	-20.0	2.66 H	118	34.7	19.3
8	#17070.00	40.2 AV	54.0	-13.8	2.66 H	118	20.9	19.3

**ANTENNA POLARITY & TEST DISTANCE: VERTICAL AT 3 M**

NO.	FREQ. (MHz)	EMISSION LEVEL (dBuV/m)	LIMIT (dBuV/m)	MARGIN (dB)	ANTENNA HEIGHT (m)	TABLE ANGLE (Degree)	RAW VALUE (dBuV)	CORRECTION FACTOR (dB/m)
1	*5690.00	110.0 PK			1.89 V	17	106.0	4.0
2	*5690.00	97.9 AV			1.89 V	17	93.9	4.0
3	#5850.00	56.9 PK	74.0	-17.1	1.92 V	6	52.9	4.0
4	#5850.00	44.7 AV	54.0	-9.3	1.92 V	6	40.7	4.0
5	11380.00	52.2 PK	74.0	-21.8	2.27 V	308	38.3	13.9
6	11380.00	39.8 AV	54.0	-14.2	2.27 V	308	25.9	13.9
7	#17070.00	53.9 PK	74.0	-20.1	1.28 V	143	34.6	19.3
8	#17070.00	41.1 AV	54.0	-12.9	1.28 V	143	21.8	19.3

**REMARKS:**

1. Emission Level(dBuV/m) = Raw Value(dBuV) + Correction Factor(dB/m)
2. Correction Factor(dB/m) = Antenna Factor(dB/m) + Cable Factor(dB) – Pre-Amplifier Factor(dB)
3. The other emission levels were very low against the limit.
4. Margin value = Emission Level – Limit value
5. " \* ": Fundamental frequency.
6. " # ": The radiated frequency is out of the restricted band.

Below 1GHz Data:

802.11ac (VHT40)

<b>CHANNEL</b>	TX Channel 54	<b>DETECTOR FUNCTION</b>	Quasi-Peak (QP)
<b>FREQUENCY RANGE</b>	9kHz ~ 1GHz		

ANTENNA POLARITY & TEST DISTANCE: HORIZONTAL AT 3 M								
NO.	FREQ. (MHz)	EMISSION LEVEL (dBuV/m)	LIMIT (dBuV/m)	MARGIN (dB)	ANTENNA HEIGHT (m)	TABLE ANGLE (Degree)	RAW VALUE (dBuV)	CORRECTION FACTOR (dB/m)
1	35.63	31.2 QP	40.0	-8.8	3.00 H	0	40.5	-9.3
2	137.96	30.0 QP	43.5	-13.5	2.00 H	76	38.2	-8.2
3	224.00	35.7 QP	46.0	-10.3	1.00 H	293	47.4	-11.7
4	240.00	33.3 QP	46.0	-12.7	1.50 H	0	43.3	-10.0
5	625.02	31.1 QP	46.0	-14.9	1.50 H	241	31.2	-0.1
6	725.00	37.6 QP	46.0	-8.4	2.00 H	108	36.4	1.2

**REMARKS:**

1. Emission Level(dBuV/m) = Raw Value(dBuV) + Correction Factor(dB/m)
2. Correction Factor(dB/m) = Antenna Factor(dB/m) + Cable Factor(dB) – Pre-Amplifier Factor(dB)
3. The other emission levels were very low against the limit.
4. Margin value = Emission Level – Limit value

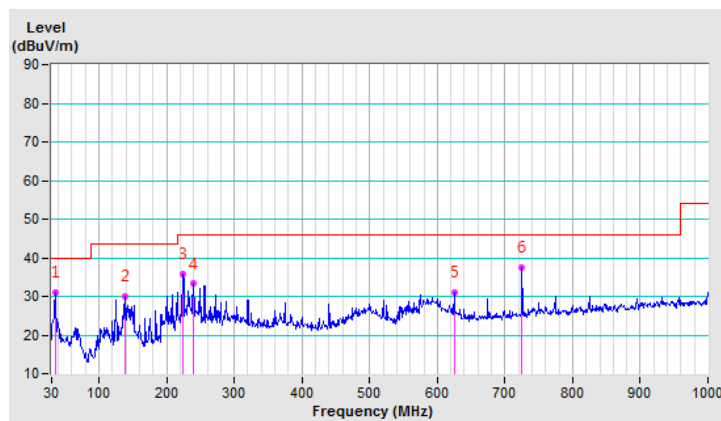

<b>CHANNEL</b>	TX Channel 54	<b>DETECTOR FUNCTION</b>	Quasi-Peak (QP)
<b>FREQUENCY RANGE</b>	9kHz ~ 1GHz		

**ANTENNA POLARITY & TEST DISTANCE: VERTICAL AT 3 M**

NO.	FREQ. (MHz)	EMISSION LEVEL (dBuV/m)	LIMIT (dBuV/m)	MARGIN (dB)	ANTENNA HEIGHT (m)	TABLE ANGLE (Degree)	RAW VALUE (dBuV)	CORRECTION FACTOR (dB/m)
1	40.69	33.8 QP	40.0	-6.2	1.00 V	287	42.3	-8.5
2	53.55	34.7 QP	40.0	-5.3	1.00 V	56	42.6	-7.9
3	109.32	29.7 QP	43.5	-13.8	1.00 V	220	40.8	-11.1
4	224.00	29.8 QP	46.0	-16.2	1.00 V	240	41.5	-11.7
5	574.99	32.5 QP	46.0	-13.5	1.00 V	82	33.8	-1.3
6	725.00	33.9 QP	46.0	-12.1	1.00 V	328	32.7	1.2

**REMARKS:**

1. Emission Level(dBuV/m) = Raw Value(dBuV) + Correction Factor(dB/m)
2. Correction Factor(dB/m) = Antenna Factor(dB/m) + Cable Factor(dB) – Pre-Amplifier Factor(dB)
3. The other emission levels were very low against the limit.
4. Margin value = Emission Level – Limit value

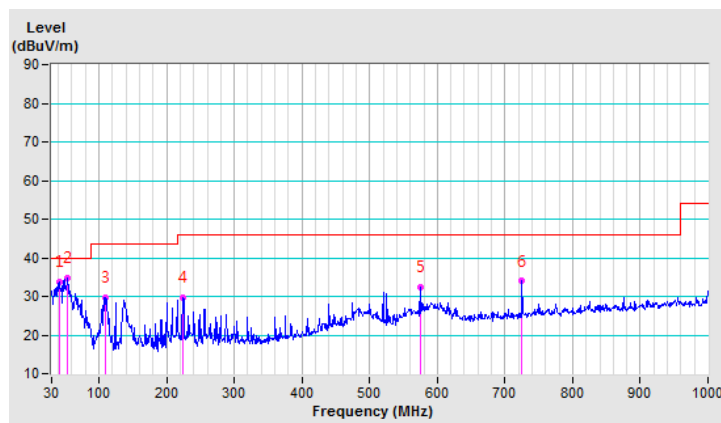

## 4.2 Conducted Emission Measurement

### 4.2.1 Limits of Conducted Emission Measurement

Frequency (MHz)	Conducted Limit (dBuV)	
	Quasi-peak	Average
0.15 - 0.5	66 - 56	56 - 46
0.50 - 5.0	56	46
5.0 - 30.0	60	50

Note: 1. The lower limit shall apply at the transition frequencies.

2. The limit decreases in line with the logarithm of the frequency in the range of 0.15 to 0.50MHz.

### 4.2.2 Test Instruments

DESCRIPTION & MANUFACTURER	MODEL NO.	SERIAL NO.	CALIBRATED DATE	CALIBRATED UNTIL
Test Receiver R&S	ESCS 30	847124/029	Oct. 24, 2016	Oct. 23, 2017
Line-Impedance Stabilization Network (for EUT) R&S	ESH3-Z5	848773/004	Oct. 26, 2016	Oct. 25, 2017
Line-Impedance Stabilization Network (for Peripheral) R&S	ENV216	100072	June 03, 2017	June 02, 2018
50 ohms Terminator	N/A	EMC-02	Sep. 29, 2016	Sep. 28, 2017
RF Cable	5D-FB	COCCAB-001	Sep. 30, 2016	Sep. 29, 2017
10 dB PAD Mini-Circuits	HAT-10+	CONATT-004	June 18, 2017	June 17, 2018
Software BVADT	BVADT_Cond_ V7.3.7.4	NA	NA	NA

**Note:**

1. The calibration interval of the above test instruments are 12 months and the calibrations are traceable to NML/ROC and NIST/USA.
2. The test was performed in Shielded Room No. 1.
3. Tested Date: Aug. 10, 2017

#### 4.2.3 Test Procedure

- The EUT was placed 0.4 meters from the conducting wall of the shielded room with EUT being connected to the power mains through a line impedance stabilization network (LISN). Other support units were connected to the power mains through another LISN. The two LISNs provide 50 ohm/ 50uH of coupling impedance for the measuring instrument.
- Both lines of the power mains connected to the EUT were checked for maximum conducted interference.
- The frequency range from 150kHz to 30MHz was searched. Emission levels under (Limit - 20dB) was not recorded.

**NOTE:** All modes of operation were investigated and the worst-case emissions are reported.

#### 4.2.4 Deviation from Test Standard

No deviation.

#### 4.2.5 Test Setup

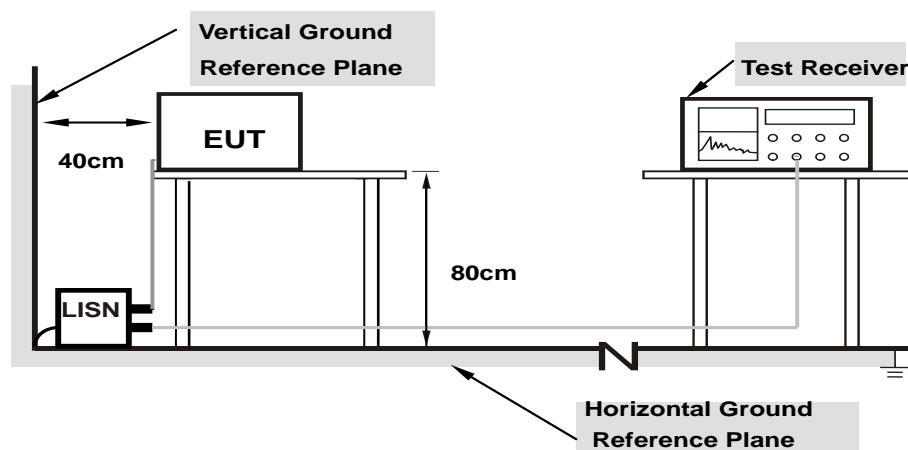

**Note: 1.Support units were connected to second LISN.**

For the actual test configuration, please refer to the attached file (Test Setup Photo).

#### 4.2.6 EUT Operating Condition

Same as 4.1.6.

#### 4.2.7 Test Results

Phase	Line (L)	Detector Function	Quasi-Peak (QP) / Average (AV)
-------	----------	-------------------	--------------------------------

No	Freq. [MHz]	Corr.	Reading Value		Emission Level		Limit		Margin	
		Factor (dB)	[dB (uV)]		[dB (uV)]		[dB (uV)]		(dB)	
			Q.P.	AV.	Q.P.	AV.	Q.P.	AV.	Q.P.	AV.
1	0.15000	10.08	35.38	22.57	45.46	32.65	66.00	56.00	-20.54	-23.35
<b>2</b>	<b>0.25156</b>	<b>10.08</b>	<b>41.03</b>	<b>35.60</b>	<b>51.11</b>	<b>45.68</b>	<b>61.71</b>	<b>51.71</b>	<b>-10.60</b>	<b>-6.03</b>
3	1.05469	10.16	25.72	21.67	35.88	31.83	56.00	46.00	-20.12	-14.17
4	2.45703	10.22	21.36	16.12	31.58	26.34	56.00	46.00	-24.42	-19.66
5	3.98047	10.37	19.18	14.25	29.55	24.62	56.00	46.00	-26.45	-21.38
6	8.84375	10.70	13.98	9.61	24.68	20.31	60.00	50.00	-35.32	-29.69

#### REMARKS:

1. Q.P. and AV. are abbreviations of quasi-peak and average individually.
2. The emission levels of other frequencies were very low against the limit.
3. Margin value = Emission level - Limit value
4. Correction factor = Insertion loss + Cable loss
5. Emission Level = Correction Factor + Reading Value.

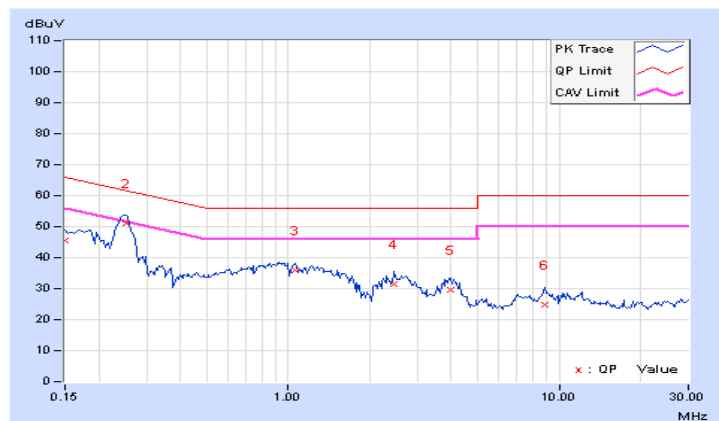

Phase	Neutral (N)	Detector Function	Quasi-Peak (QP) / Average (AV)
-------	-------------	-------------------	--------------------------------

No	Freq. [MHz]	Corr. Factor	Reading Value [dB (uV)]		Emission Level [dB (uV)]		Limit [dB (uV)]		Margin (dB)	
		(dB)	Q.P.	AV.	Q.P.	AV.	Q.P.	AV.	Q.P.	AV.
	1	0.15000	10.07	35.34	22.49	45.41	32.56	66.00	56.00	-20.59
2	0.18516	10.05	35.02	26.27	45.07	36.32	64.25	54.25	-19.18	-17.93
3	0.25156	10.06	40.40	34.83	50.46	44.89	61.71	51.71	-11.25	-6.82
4	1.38672	10.15	23.61	19.11	33.76	29.26	56.00	46.00	-22.24	-16.74
5	2.49219	10.22	22.34	17.54	32.56	27.76	56.00	46.00	-23.44	-18.24
6	11.66797	10.80	12.36	7.07	23.16	17.87	60.00	50.00	-36.84	-32.13

#### REMARKS:

1. Q.P. and AV. are abbreviations of quasi-peak and average individually.
2. The emission levels of other frequencies were very low against the limit.
3. Margin value = Emission level - Limit value
4. Correction factor = Insertion loss + Cable loss
5. Emission Level = Correction Factor + Reading Value.

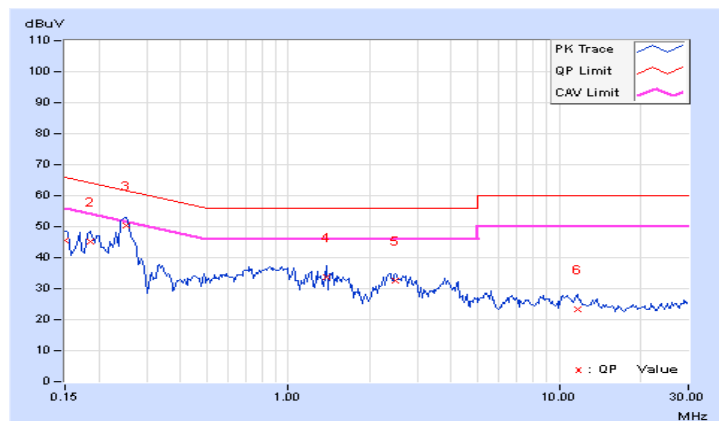

### 4.3 Transmit Power Measurement

#### 4.3.1 Limits of Transmit Power Measurement

Operation Band	EUT Category		Limit
U-NII-1		Outdoor Access Point	1 Watt (30 dBm) (Max. e.i.r.p $\leq$ 125mW(21 dBm) at any elevation angle above 30 degrees as measured from the horizon)
		Fixed point-to-point Access Point	1 Watt (30 dBm)
		Indoor Access Point	1 Watt (30 dBm)
		Mobile and Portable client device	250mW (24 dBm)
U-NII-2A		√	250mW (24 dBm) or 11 dBm+10 log B*
U-NII-2C		√	250mW (24 dBm) or 11 dBm+10 log B*
U-NII-3		√	1 Watt (30 dBm)

\*B is the 26 dB emission bandwidth in megahertz

Per KDB 662911 Method of conducted output power measurement on IEEE 802.11 devices,

Array Gain = 0 dB (i.e., no array gain) for  $N_{ANT} \leq 4$ ;

Array Gain = 0 dB (i.e., no array gain) for channel widths  $\geq 40$  MHz for any  $N_{ANT}$ ;

Array Gain =  $5 \log(N_{ANT}/N_{SS})$  dB or 3 dB, whichever is less for 20-MHz channel widths with  $N_{ANT} \geq 5$ .

For power measurements on all other devices: Array Gain =  $10 \log(N_{ANT}/N_{SS})$  dB.



#### 4.3.2 Test Setup

##### FOR POWER OUTPUT MEASUREMENT

For channel straddling 5725MHz:

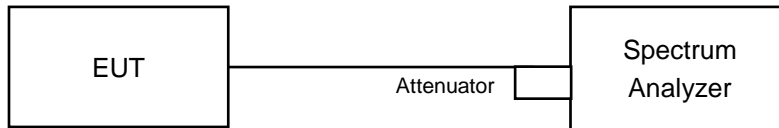

For other channels:

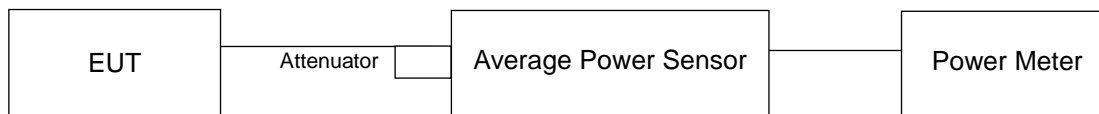

##### FOR 26dB OCCUPIED BANDWIDTH

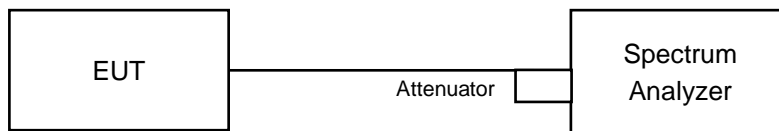

#### 4.3.3 Test Instruments

##### FOR POWER OUTPUT MEASUREMENT

For channel straddling 5725MHz:

DESCRIPTION & MANUFACTURER	MODEL NO.	SERIAL NO.	CALIBRATED DATE	CALIBRATED UNTIL
Spectrum Analyzer R&S	FSv40	100964	June 28, 2016	June 27, 2017

- NOTE:**
1. The test was performed in Oven room 2.
  2. The calibration interval of the above test instruments is 12 months and the calibrations are traceable to NML/ROC and NIST/USA.
  3. Tested Date: Jan 05, 2017

For other channels:

DESCRIPTION & MANUFACTURER	MODEL NO.	SERIAL NO.	CALIBRATED DATE	CALIBRATED UNTIL
Power meter Anritsu	ML2495A	1014008	May 5, 2016	May 4, 2017
Power sensor Anritsu	MA2411B	0917122	May 5, 2016	May 4, 2017

- NOTE:**
1. The test was performed in Oven room 2.
  2. The calibration interval of the above test instruments is 12 months and the calibrations are traceable to NML/ROC and NIST/USA.
  3. Tested Date: Jan 05, 2017

## FOR 26dB OCCUPIED BANDWIDTH

DESCRIPTION & MANUFACTURER	MODEL NO.	SERIAL NO.	CALIBRATED DATE	CALIBRATED UNTIL
Spectrum Analyzer R&S	FSv40	100964	June 28, 2016	June 27, 2017

- NOTE:**
1. The test was performed in Oven room 2.
  2. The calibration interval of the above test instruments is 12 months and the calibrations are traceable to NML/ROC and NIST/USA.
  3. Tested Date: Jan 05, 2017

### 4.3.4 Test Procedure

#### For Average Power Measurement For channel straddling 5725MHz:

##### 802.11a

##### Method SA-2

1. Set span to encompass the emission bandwidth (EBW) of the signal.
2. Set RBW =1MHz.
3. Set the VBW  $\geq 3 \times$  RBW.
4. Number of points in sweep  $\geq 2$  Span / RBW.
5. Sweep time = auto.
6. Detector = RMS.
7. Trace average at least 100 traces in power averaging mode
8. Compute power by integrating the spectrum across the 26 dB EBW of the signal.
9. Duty factor need added to measured value (duty cycle < 98 percent).

##### Other Modulation mode

##### Method SA-1

1. Set span to encompass the entire emission bandwidth (EBW) of the signal.
2. Set RBW =1MHz.
3. Set the VBW  $\geq 3 \times$  RBW.
4. Number of points in sweep  $\geq 2$  Span / RBW.
5. Sweep time = auto.
6. Set trigger to free run (duty cycle  $\geq 98$  percent)
7. Detector = RMS.
8. Trace average at least 100 traces in power averaging mode
9. Compute power by integrating the spectrum across the 26 dB EBW of the signal.

##### For other channels:

Method PM is used to perform output power measurement, trigger and gating function of wide band power meter is enabled to measure max output power of TX on burst. Duty factor is not added to measured value.

## FOR 26dB OCCUPIED BANDWIDTH

1. Set RBW = approximately 1% of the emission bandwidth.
2. Set the VBW > RBW.
3. Detector = Peak.
4. Trace mode = max hold.
5. Measure the maximum width of the emission that is 26 dB down from the peak of the emission. Compare this with the RBW setting of the analyzer. Readjust RBW and repeat measurement as needed until the RBW/EBW ratio is approximately 1%.

#### 4.3.5 Deviation from Test Standard

No deviation.

#### 4.3.6 EUT Operating Condition

The software provided by client to enable the EUT under transmission condition continuously at lowest, middle and highest channel frequencies individually.

#### 4.3.7 Test Result

#### CDD Mode

#### 802.11a

#### Power Output:

Chan.	Chan. Freq. (MHz)	Maximum Conducted Power (dBm)				Total Power (mW)	Total Power (dBm)	Limit (dBm)	Pass / Fail
		Chain 0	Chain 1	Chain 2	Chain 3				
52	5260	17.80	17.54	17.75	17.57	233.724	23.69	23.89	Pass
60	5300	17.61	17.35	17.32	17.36	220.403	23.43	23.82	Pass
64	5320	17.53	17.37	17.19	17.29	217.14	23.37	24.00	Pass
100	5500	16.91	16.46	16.55	16.27	180.9	22.57	23.20	Pass
116	5580	17.02	16.51	16.33	16.21	179.858	22.55	23.23	Pass
140	5700	16.89	16.33	16.27	16.24	176.256	22.46	23.63	Pass
*144 (UNII-2C Band)	5720	11.92	11.50	11.34	11.93	60.604	17.83	22.78	Pass
*144 (UNII-3 Band)	5720	6.22	6.11	5.94	5.75	16.418	12.15	29.60	Pass

Note: \* Test was performed in accordance with Measurement follow FCC KDB 789033 UNII test procedure Method SA-2 and use spectrum analyzer test.

The Total Power for the straddle channel:

Chan.	Chan. Freq. (MHz)	Average Power (mW)	Average Power (dBm)
144	5720	77.022	18.87

Note: The total power was calculated through formula and record the value for reference only.

- Note:**
1. For CH52 : The directional gain is 6.11dBi > 6dBi , so the power limit shall be reduced to  $24-(6.11-6) = 23.89\text{dBm}$ .
  2. For CH60 : The directional gain is 6.18dBi > 6dBi , so the power limit shall be reduced to  $24-(6.18-6) = 23.82\text{dBm}$ .
  3. For CH64 : The directional gain is 5.98dBi < 6dBi , so the power limit shall not be reduced.
  4. For CH100 : The directional gain is 6.80dBi > 6dBi , so the power limit shall be reduced to  $24-(6.80-6) = 23.20\text{dBm}$ .
  5. For CH116 : The directional gain is 6.77dBi > 6dBi , so the power limit shall be reduced to  $24-(6.77-6) = 23.23\text{dBm}$ .
  6. For CH140 : The directional gain is 6.37dBi > 6dBi , so the power limit shall be reduced to  $24-(6.37-6) = 23.63\text{dBm}$ .
  7. For CH144 (UNII-2C) : The directional gain is 6.40dBi > 6dBi , so the power limit shall be reduced to  $23.18-(6.40-6) = 23.60\text{dBm}$ .
  8. For CH144 (UNII-3) : The directional gain is 6.40dBi > 6dBi , so the power limit shall be reduced to  $30-(6.40-6) = 29.60\text{dBm}$ .

**26dB BANDWIDTH:**

Channel	Frequency (MHz)	26dBc Bandwidth (MHz)			
		Chain 0	Chain 1	Chain 2	Chain 3
52	5260	23.25	23.50	22.95	23.42
60	5300	23.37	23.53	23.28	23.53
64	5320	23.45	23.37	23.32	23.50
100	5500	23.05	23.47	23.34	23.48
116	5580	22.95	23.56	23.14	23.63
140	5700	23.36	23.78	23.12	23.64
144 (UNII-2C Band)	5720	16.82	16.77	16.62	16.54

**Note: For U-NII-2A, U-NII-2C Band output power limitation is determined based on 26dBc bandwidth**

Power Limit = 11dBm + 10logB < U-NII-2A, U-NII-2C >			
Channel Number	Freq.(MHz)	Min. B(MHz)	Determined Conducted Limit (dBm)
52	5260	22.95	24.6 > 24
60	5300	23.28	24.66 > 24
64	5320	23.32	24.67 > 24
100	5500	23.05	24.62 > 24
116	5580	22.95	24.6 > 24
140	5700	23.12	24.63 > 24
144 (UNII-2C Band)	5720	16.54	23.18 < 24

**CDD Mode / Beamforming Mode (Nss=1)**
**802.11ac (VHT20)**
**Power Output:**

Chan.	Chan. Freq. (MHz)	Maximum Conducted Power (dBm)				Total Power (mW)	Total Power (dBm)	Limit (dBm)	Pass / Fail
		Chain 0	Chain 1	Chain 2	Chain 3				
52	5260	17.62	17.65	17.30	17.32	223.674	23.50	23.89	Pass
60	5300	17.53	17.61	17.26	17.22	220.235	23.43	23.82	Pass
64	5320	17.49	17.55	17.21	17.19	217.952	23.38	24.00	Pass
100	5500	16.56	16.57	16.26	16.67	179.403	22.54	23.20	Pass
116	5580	16.47	16.52	16.21	16.69	177.685	22.50	23.23	Pass
140	5700	16.44	16.19	16.31	16.58	173.901	22.40	23.63	Pass
*144 (UNII-2C Band)	5720	12.45	12.02	12.04	12.89	68.951	18.39	22.84	Pass
*144 (UNII-3 Band)	5720	7.41	6.87	6.99	7.14	20.548	13.13	29.60	Pass

Note: \* Test was performed in accordance with Measurement follow FCC KDB 789033 UNII test procedure Method SA-1 and use spectrum analyzer test.

The Total Power for the straddle channel:

Chan.	Chan. Freq. (MHz)	Average Power (mW)	Average Power (dBm)
144	5720	89.499	19.52

Note: The total power was calculated through formula and record the value for reference only.

- Note:**
1. For CH52 : The directional gain is 6.11dBi > 6dBi , so the power limit shall be reduced to  $24-(6.11-6) = 23.89\text{dBm}$ .
  2. For CH60 : The directional gain is 6.18dBi > 6dBi , so the power limit shall be reduced to  $24-(6.18-6) = 23.82\text{dBm}$ .
  3. For CH64 : The directional gain is 5.98dBi < 6dBi , so the power limit shall not be reduced.
  4. For CH100 : The directional gain is 6.80dBi > 6dBi , so the power limit shall be reduced to  $24-(6.80-6) = 23.20\text{dBm}$ .
  5. For CH116 : The directional gain is 6.77dBi > 6dBi , so the power limit shall be reduced to  $24-(6.77-6) = 23.23\text{dBm}$ .
  6. For CH140 : The directional gain is 6.37dBi > 6dBi , so the power limit shall be reduced to  $24-(6.37-6) = 23.63\text{dBm}$ .
  7. For CH144 (UNII-2C) : The directional gain is 6.40dBi > 6dBi , so the power limit shall be reduced to  $23.24-(6.40-6) = 23.60\text{dBm}$ .
  8. For CH144 (UNII-3) : The directional gain is 6.40dBi > 6dBi , so the power limit shall be reduced to  $30-(6.40-6) = 29.60\text{dBm}$ .

**26dB BANDWIDTH:**

Channel	Frequency (MHz)	26dBc Bandwidth (MHz)			
		Chain 0	Chain 1	Chain 2	Chain 3
52	5260	24.96	24.92	24.64	24.21
60	5300	25.23	24.92	24.63	24.28
64	5320	25.12	24.87	24.34	24.30
100	5500	25.12	25.21	24.23	24.30
116	5580	24.92	24.81	24.30	24.03
140	5700	24.92	24.77	24.64	24.14
144 (UNII-2C Band)	5720	17.83	17.43	17.38	17.18

**Note: For U-NII-2A, U-NII-2C Band output power limitation is determined based on 26dBc bandwidth**

Power Limit = 11dBm + 10logB < U-NII-2A, U-NII-2C >			
Channel Number	Freq.(MHz)	Min. B(MHz)	Determined Conducted Limit (dBm)
52	5260	24.21	24.83 > 24
60	5300	24.28	24.85 > 24
64	5320	24.30	24.85 > 24
100	5500	24.23	24.84 > 24
116	5580	24.03	24.8 > 24
140	5700	24.14	24.82 > 24
144 (UNII-2C Band)	5720	17.18	23.24 < 24

**802.11ac (VHT40)**

Chan.	Chan. Freq. (MHz)	Maximum Conducted Power (dBm)				Total Power (mW)	Total Power (dBm)	Limit (dBm)	Pass / Fail
		Chain 0	Chain 1	Chain 2	Chain 3				
54	5270	17.44	17.58	17.88	17.95	236.492	23.74	23.90	Pass
62	5310	17.53	17.45	17.79	18.02	235.718	23.72	24.00	Pass
102	5510	16.68	16.67	16.98	16.93	192.216	22.84	23.23	Pass
110	5550	16.89	16.79	16.68	16.96	192.836	22.85	23.45	Pass
134	5670	16.92	16.59	16.74	16.86	190.543	22.80	23.50	Pass
*142 (UNII-2C Band)	5710	13.50	12.69	12.86	13.17	81.034	19.09	23.34	Pass
*142 (UNII-3 Band)	5710	3.53	2.48	2.53	3.32	7.963	9.01	29.34	Pass

Note: \* Test was performed in accordance with Measurement follow FCC KDB 789033 UNII test procedure Method SA-1 and use spectrum analyzer test.

The Total Power for the straddle channel:

Chan.	Chan. Freq. (MHz)	Average Power (mW)	Average Power (dBm)
142	5710	88.997	19.49

Note: The total power was calculated through formula and record the value for reference only.

- Note:**
1. For CH54 : The directional gain is 6.10dBi > 6dBi , so the power limit shall be reduced to  $24-(6.10-6) = 23.90\text{dBm}$ .
  2. For CH62 : The directional gain is 5.96dBi < 6dBi , so the power limit shall not be reduced.
  3. For CH102 : The directional gain is 6.77dBi > 6dBi , , so the power limit shall be reduced to  $24-(6.77-6) = 23.23\text{dBm}$ .
  4. For CH110 : The directional gain is 6.55dBi > 6dBi , so the power limit shall be reduced to  $24-(6.55-6) = 23.45\text{dBm}$ .
  5. For CH134 : The directional gain is 6.50dBi > 6dBi , so the power limit shall be reduced to  $24-(6.50-6) = 23.50\text{dBm}$ .
  6. For CH142 (UNII-2C): The directional gain is 6.66dBi > 6dBi , so the power limit shall be reduced to  $24-(6.66-6) = 23.34\text{dBm}$ .
  7. For CH142 (UNII-3): The directional gain is 6.66dBi > 6dBi , so the power limit shall be reduced to  $30-(6.66-6) = 29.34\text{dBm}$ .



**26dB BANDWIDTH:**

Channel	Frequency (MHz)	26dBc Bandwidth (MHz)			
		Chain 0	Chain 1	Chain 2	Chain 3
54	5270	44.28	44.19	44.25	43.72
62	5310	44.33	44.34	44.00	43.93
102	5510	44.33	44.36	43.98	44.14
110	5550	44.26	44.34	44.11	44.13
134	5670	44.28	44.37	44.02	43.93
142 (UNII-2C Band)	5710	37.17	37.19	37.08	37.01

**Note: For U-NII-2A, U-NII-2C Band output power limitation is determined based on 26dBc bandwidth**

Power Limit = 11dBm + 10logB < U-NII-2A, U-NII-2C >			
Channel Number	Freq.(MHz)	Min. B(MHz)	Determined Conducted Limit (dBm)
54	5270	43.72	27.4 > 24
62	5310	43.93	27.42 > 24
102	5510	43.98	27.43 > 24
110	5550	44.11	27.44 > 24
134	5670	43.93	27.42 > 24
142 (UNII-2C Band)	5710	37.01	26.68 > 24

**802.11ac (VHT80)**

Chan.	Chan. Freq. (MHz)	Maximum Conducted Power (dBm)				Total Power (mW)	Total Power (dBm)	Limit (dBm)	Pass / Fail
		Chain 0	Chain 1	Chain 2	Chain 3				
58	5290	16.59	16.26	16.56	16.39	176.712	22.47	23.81	Pass
106	5530	15.66	15.32	15.36	15.31	139.173	21.44	22.98	Pass
122	5610	16.79	16.40	16.35	16.47	178.918	22.53	23.45	Pass
*138 (UNII-2C Band)	5690	14.32	13.09	13.43	13.48	91.723	19.62	23.66	Pass
*138 (UNII-3 Band)	5690	0.38	-0.44	-0.97	-0.52	3.682	5.66	29.66	Pass

Note: \* Test was performed in accordance with Measurement follow FCC KDB 789033 UNII test procedure Method SA-1 and use spectrum analyzer test.

The Total Power for the straddle channel:

Chan.	Chan. Freq. (MHz)	Average Power (mW)	Average Power (dBm)
138	5690	95.405	19.8

Note: The total power was calculated through formula and record the value for reference only.

- Note:**
1. For CH58 : The directional gain is 6.19dBi > 6dBi , so the power limit shall be reduced to  $24-(6.19-6) = 23.81\text{dBm}$ .
  2. For CH106 : The directional gain is 7.02dBi > 6dBi , , so the power limit shall be reduced to  $24-(7.02-6) = 22.98\text{dBm}$ .
  3. For CH122 : The directional gain is 6.55dBi > 6dBi , , so the power limit shall be reduced to  $24-(6.55-6) = 23.45\text{dBm}$ .
  4. For CH138 (UNII-2C): The directional gain is 6.34dBi > 6dBi , so the power limit shall be reduced to  $24-(6.34-6) = 23.66\text{dBm}$ .
  5. For CH138 (UNII-3): The directional gain is 6.34dBi > 6dBi , so the power limit shall be reduced to  $30-(6.34-6) = 29.66\text{dBm}$ .

### 26dB OCCUPIED BANDWIDTH

Channel	Frequency (MHz)	26dBc Bandwidth (MHz)			
		Chain 0	Chain 1	Chain 2	Chain 3
58	5290	83.24	83.40	83.59	82.49
106	5530	83.71	83.62	82.65	82.95
122	5610	82.85	82.83	81.90	82.32
138 (UNII-2C Band)	5690	76.65	76.62	76.46	76.46

**Note: For U-NII-2A, U-NII-2C Band output power limitation is determined based on 26dBc bandwidth**

Power Limit = 11dBm + 10logB < U-NII-2A, U-NII-2C >			
Channel Number	Freq.(MHz)	Min. B(MHz)	Determined Conducted Limit (dBm)
58	5290	82.49	30.16 > 24
106	5530	82.65	30.17 > 24
122	5610	81.90	30.13 > 24
138 (UNII-2C Band)	5690	76.46	29.83 > 24

Spectrum Plot of Worst Value

802.11a\_Chain 3 / CH144 (UNII-2C)

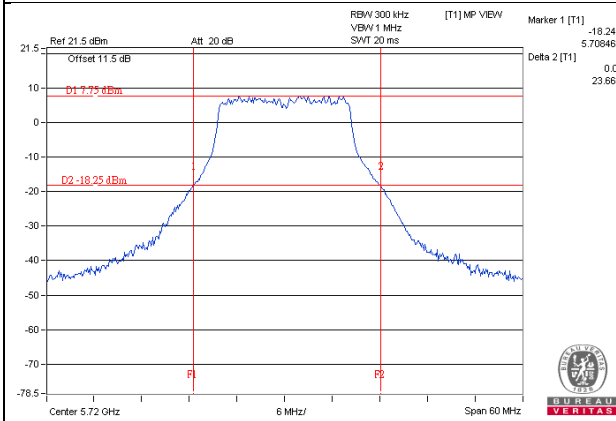

802.11ac (VHT20)\_Chain 1 / CH144 (UNII-2C)

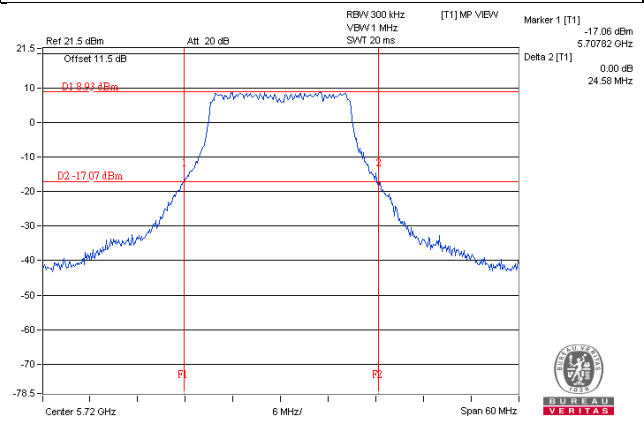

802.11ac (VHT40)\_Chain 3 / CH142 (UNII-2C)

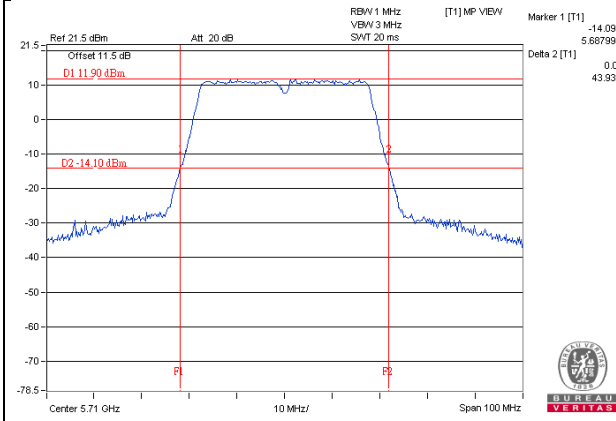

802.11ac (VHT80)\_Chain 2 / CH138 (UNII-2C)

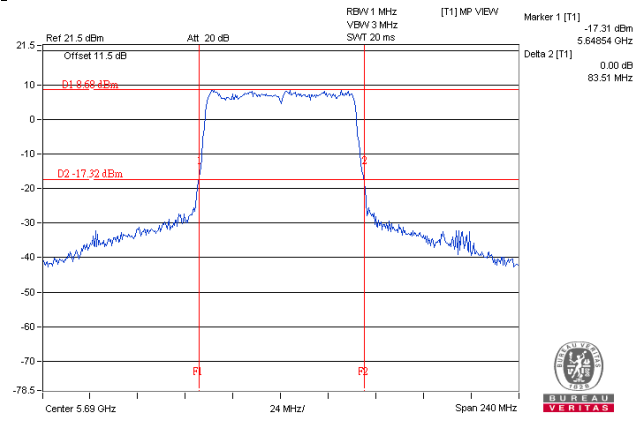

**NOTE:**

- For CH144 (U\_NII-2C) = 5725MHz - Marker 1
- For CH142 (U\_NII-2C) = 5725MHz - Marker 1
- For CH138 (U\_NII-2C) = 5725MHz - Marker 1

## Beamforming Mode (Nss=2)

### 802.11ac (VHT20)

#### Power Output:

Chan.	Chan. Freq. (MHz)	Maximum Conducted Power (dBm)				Total Power (mW)	Total Power (dBm)	Limit (dBm)	Pass / Fail
		Chain 0	Chain 1	Chain 2	Chain 3				
52	5260	17.62	17.65	17.30	17.32	223.674	23.50	24.00	Pass
60	5300	17.53	17.61	17.26	17.22	220.235	23.43	24.00	Pass
64	5320	17.49	17.55	17.21	17.19	217.952	23.38	24.00	Pass
100	5500	17.75	17.61	17.48	17.54	229.973	23.62	24.00	Pass
116	5580	17.88	17.68	17.56	17.62	234.816	23.71	24.00	Pass
140	5700	17.70	17.59	17.39	17.45	226.714	23.55	24.00	Pass
*144 (UNII-2C Band)	5720	13.78	13.02	13.38	13.94	90.474	19.57	23.35	Pass
*144 (UNII-3 Band)	5720	8.79	8.14	8.40	8.44	27.984	14.47	30.00	Pass

Note: \* Test was performed in accordance with Measurement follow FCC KDB 789033 UNII test procedure Method SA-1 and use spectrum analyzer test.

The Total Power for the straddle channel:

Chan.	Chan. Freq. (MHz)	Average Power (mW)	Average Power (dBm)
144	5720	118.458	20.74

Note: The total power was calculated through formula and record the value for reference only.

- Note:**
1. For CH52 : The directional gain is 3.10dBi < 6dBi , so the power limit shall not be reduced.
  2. For CH60 : The directional gain is 3.17dBi < 6dBi , so the power limit shall not be reduced.
  3. For CH64 : The directional gain is 2.97dBi < 6dBi , so the power limit shall not be reduced.
  4. For CH100 : The directional gain is 3.79dBi < 6dBi , so the power limit shall not be reduced.
  5. For CH116 : The directional gain is 3.76dBi < 6dBi , so the power limit shall not be reduced.
  6. For CH140 : The directional gain is 3.36dBi < 6dBi , so the power limit shall not be reduced.
  7. For CH144 (UNII-2C): The directional gain is 3.39dBi < 6dBi , so the power limit shall not be reduced.
  8. For CH144 (UNII-3): The directional gain is 3.39dBi < 6dBi , so the power limit shall not be reduced.

**26dB BANDWIDTH:**

Channel	Frequency (MHz)	26dBc Bandwidth (MHz)			
		Chain 0	Chain 1	Chain 2	Chain 3
52	5260	24.96	24.92	24.64	24.21
60	5300	25.23	24.92	24.63	24.28
64	5320	25.12	24.87	24.34	24.30
100	5500	25.12	25.21	24.23	24.30
116	5580	24.92	24.81	24.30	24.03
140	5700	24.92	24.77	24.64	24.14
144 (UNII-2C Band)	5720	17.83	17.43	17.38	17.18

**Note: For U-NII-2A, U-NII-2C Band output power limitation is determined based on 26dBc bandwidth**

Power Limit = 11dBm + 10logB < U-NII-2A, U-NII-2C >			
Channel Number	Freq.(MHz)	Min. B(MHz)	Determined Conducted Limit (dBm)
52	5260	24.21	24.83 > 24
60	5300	24.28	24.85 > 24
64	5320	24.30	24.85 > 24
100	5500	24.23	24.84 > 24
116	5580	24.03	24.8 > 24
140	5700	24.14	24.82 > 24
144 (UNII-2C Band)	5720	17.18	23.35 < 24

**802.11ac (VHT40)**

Chan.	Chan. Freq. (MHz)	Maximum Conducted Power (dBm)				Total Power (mW)	Total Power (dBm)	Limit (dBm)	Pass / Fail
		Chain 0	Chain 1	Chain 2	Chain 3				
54	5270	17.44	17.58	17.88	17.95	236.492	23.74	24.00	Pass
62	5310	17.53	17.45	17.79	18.02	235.718	23.72	24.00	Pass
102	5510	17.61	17.50	17.42	17.33	223.194	23.49	24.00	Pass
110	5550	17.69	17.32	17.32	17.29	220.231	23.43	24.00	Pass
134	5670	17.71	17.62	17.52	17.39	228.152	23.58	24.00	Pass
*142 (UNII-2C Band)	5710	14.34	14.20	13.96	14.49	106.475	20.27	24.00	Pass
*142 (UNII-3 Band)	5710	4.32	3.97	3.69	4.50	10.356	10.15	30.00	Pass

Note: \* Test was performed in accordance with Measurement follow FCC KDB 789033 UNII test procedure Method SA-1 and use spectrum analyzer test.

The Total Power for the straddle channel:

Chan.	Chan. Freq. (MHz)	Average Power (mW)	Average Power (dBm)
142	5710	116.831	20.68

Note: The total power was calculated through formula and record the value for reference only.

- Note:**
1. For CH54 : The directional gain is 3.09dBi < 6dBi , so the power limit shall not be reduced.
  2. For CH62 : The directional gain is 2.95dBi < 6dBi , so the power limit shall not be reduced.
  3. For CH102 : The directional gain is 3.76dBi < 6dBi , so the power limit shall not be reduced.
  4. For CH110 : The directional gain is 3.54dBi < 6dBi , so the power limit shall not be reduced.
  5. For CH134 : The directional gain is 3.49dBi < 6dBi , so the power limit shall not be reduced.
  6. For CH142 (UNII-2C): The directional gain is 3.65dBi < 6dBi, so the power limit shall not be reduced.
  7. For CH142 (UNII-3): The directional gain is 3.65dBi < 6dBi, so the power limit shall not be reduced.

**26dB BANDWIDTH:**

Channel	Frequency (MHz)	26dBc Bandwidth (MHz)			
		Chain 0	Chain 1	Chain 2	Chain 3
54	5270	44.28	44.19	44.25	43.72
62	5310	44.33	44.34	44.00	43.93
102	5510	44.33	44.36	43.98	44.14
110	5550	44.26	44.34	44.11	44.13
134	5670	44.28	44.37	44.02	43.93
142 (UNII-2C Band)	5710	37.17	37.19	37.08	37.01

**Note: For U-NII-2A, U-NII-2C Band output power limitation is determined based on 26dBc bandwidth**

Power Limit = 11dBm + 10logB < U-NII-2A, U-NII-2C >			
Channel Number	Freq.(MHz)	Min. B(MHz)	Determined Conducted Limit (dBm)
54	5270	43.72	27.4 > 24
62	5310	43.93	27.42 > 24
102	5510	43.98	27.43 > 24
110	5550	44.11	27.44 > 24
134	5670	43.93	27.42 > 24
142 (UNII-2C Band)	5710	37.01	26.68 > 24



### 802.11ac (VHT80)

Chan.	Chan. Freq. (MHz)	Maximum Conducted Power (dBm)				Total Power (mW)	Total Power (dBm)	Limit (dBm)	Pass / Fail
		Chain 0	Chain 1	Chain 2	Chain 3				
58	5290	16.59	16.26	16.56	16.39	176.712	22.47	24.00	Pass
106	5530	17.56	17.32	17.36	17.31	219.244	23.41	24.00	Pass
122	5610	17.39	17.38	17.59	17.62	224.752	23.52	24.00	Pass
*138 (UNII-2C Band)	5690	14.97	14.73	14.23	14.78	117.668	20.71	24.00	Pass
*138 (UNII-3 Band)	5690	1.09	0.58	-0.53	0.74	4.4991	6.53	30.00	Pass

Note: \* Test was performed in accordance with Measurement follow FCC KDB 789033 UNII test procedure Method SA-1 and use spectrum analyzer test.

The Total Power for the straddle channel:

Chan.	Chan. Freq. (MHz)	Average Power (mW)	Average Power (dBm)
138	5690	122.1671	20.87

Note: The total power was calculated through formula and record the value for reference only.

- Note:**
1. For CH58 : The directional gain is 3.18dBi < 6dBi, so the power limit shall not be reduced.
  2. For CH106 : The directional gain is 4.01dBi < 6dBi, so the power limit shall not be reduced.
  3. For CH122 : The directional gain is 3.54dBi < 6dBi, so the power limit shall not be reduced.
  4. For CH138 (UNII-2C): The directional gain is 3.33dBi < 6dBi, so the power limit shall not be reduced.
  5. For CH138 (UNII-3): The directional gain is 3.33dBi < 6dBi, so the power limit shall not be reduced.

### 26dB OCCUPIED BANDWIDTH

Channel	Frequency (MHz)	26dBc Bandwidth (MHz)			
		Chain 0	Chain 1	Chain 2	Chain 3
58	5290	83.24	83.40	83.59	82.49
106	5530	83.71	83.62	82.65	82.95
122	5610	82.85	82.83	81.90	82.32
138 (UNII-2C Band)	5690	76.65	76.62	76.46	76.46

**Note: For U-NII-2A, U-NII-2C Band output power limitation is determined based on 26dBc bandwidth**

Power Limit = 11dBm + 10logB < U-NII-2A, U-NII-2C >			
Channel Number	Freq.(MHz)	Min. B(MHz)	Determined Conducted Limit (dBm)
58	5290	82.49	30.16 > 24
106	5530	82.65	30.17 > 24
122	5610	81.90	30.13 > 24
138 (UNII-2C Band)	5690	76.46	29.83 > 24

Spectrum Plot of Worst Value

802.11ac (VHT20)\_Chain 1 / CH144 (UNII-2C)

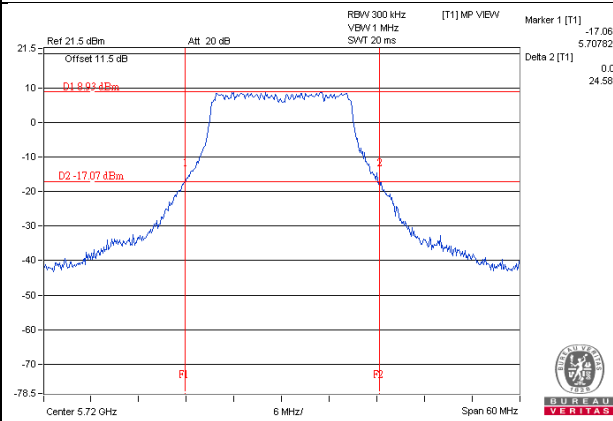

802.11ac (VHT40)\_Chain 3 / CH142 (UNII-2C)

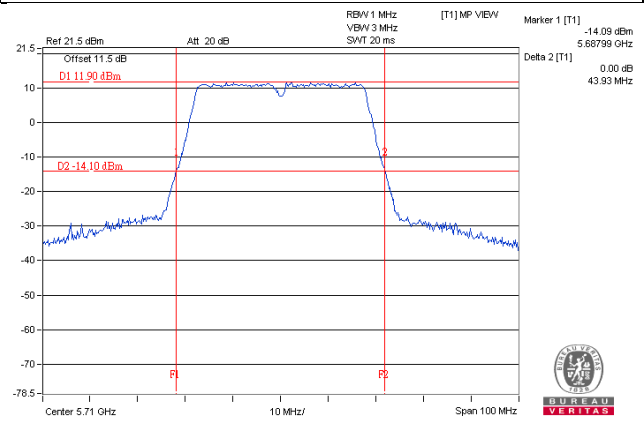

802.11ac (VHT80)\_Chain 2 / CH138 (UNII-2C)

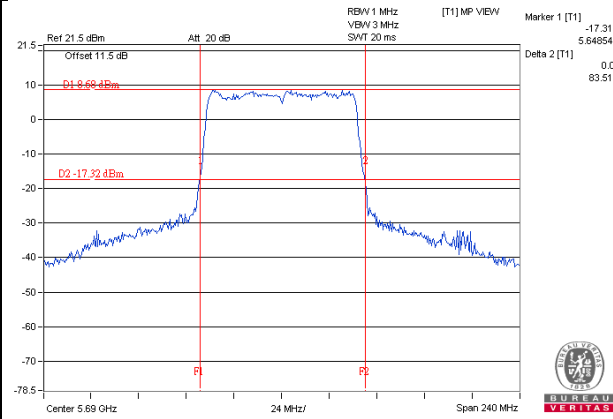

802.11ac (VHT80)\_Chain 2 / CH138 (UNII-2C)

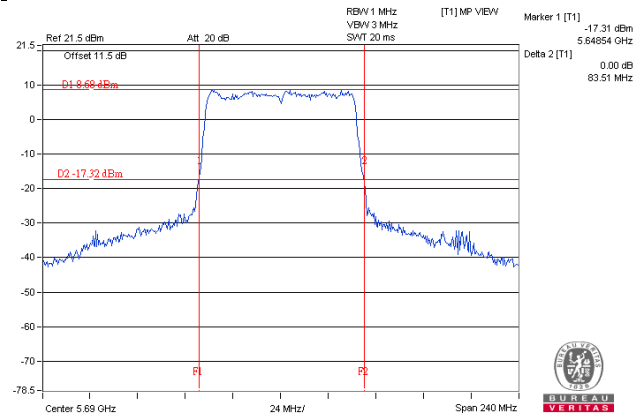

#### 4.4 Occupied Bandwidth Measurement

##### 4.4.1 Test Setup

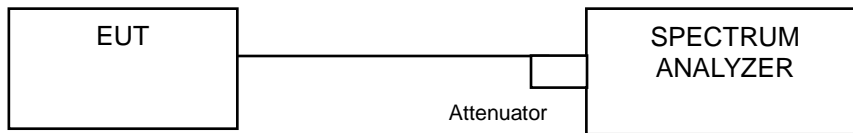

##### 4.4.2 Test Instruments

DESCRIPTION & MANUFACTURER	MODEL NO.	SERIAL NO.	CALIBRATED DATE	CALIBRATED UNTIL
Spectrum Analyzer R&S	FSv40	100964	June 28, 2016	June 27, 2017

- NOTE:**
1. The test was performed in Oven room 2.
  2. The calibration interval of the above test instruments is 12 months and the calibrations are traceable to NML/ROC and NIST/USA.
  3. Tested Date: Jan 05, 2017

##### 4.4.3 Test Procedure

The transmitter output was connected to the spectrum analyzer through an attenuator. The bandwidth of the fundamental frequency was measured by spectrum analyzer with resolution bandwidth in the range of 1% to 5% of the anticipated emission bandwidth, and a video bandwidth at least 3x the resolution bandwidth and set the detector to SAMPLE. The width of a frequency band such that, below the lower and above the upper frequency limits, the mean powers emitted are each equal to a specified percentage 0.5 %of the total mean power of a given emission.

#### 4.4.4 Test Results

##### CDD Mode

##### 802.11a

Channel	Channel Frequency (MHz)	Occupied Bandwidth (MHz)			
		CHAIN 0	CHAIN 1	CHAIN 2	CHAIN 3
52	5260	16.92	17.04	16.80	17.04
60	5300	16.80	16.92	16.92	16.92
64	5320	16.80	16.92	16.92	17.04
100	5500	16.92	17.04	16.92	17.04
116	5580	16.92	17.04	16.92	17.04
140	5700	16.80	16.92	16.92	16.92
144 (UNII-2C Band)	5720	13.52	13.64	13.52	13.52
144 (UNII-3 Band)	5720	3.40	3.40	3.28	3.40

##### Beamforming Mode

##### 802.11ac (VHT20)

Channel	Channel Frequency (MHz)	Occupied Bandwidth (MHz)			
		CHAIN 0	CHAIN 1	CHAIN 2	CHAIN 3
52	5260	18.12	18.12	18.12	18.12
60	5300	18.24	18.12	18.12	18.00
64	5320	18.24	18.00	18.00	18.00
100	5500	18.12	18.12	18.24	18.00
116	5580	18.24	18.12	18.00	18.00
140	5700	18.12	18.24	18.12	18.00
144 (UNII-2C Band)	5720	14.12	14.24	14.12	14.12
144 (UNII-3 Band)	5720	4.00	4.00	4.00	3.88

##### 802.11ac (VHT40)

Channel	Channel Frequency (MHz)	Occupied Bandwidth (MHz)			
		CHAIN 0	CHAIN 1	CHAIN 2	CHAIN 3
54	5270	36.72	36.72	36.72	36.72
62	5310	36.72	36.96	36.96	36.96
102	5510	36.72	36.96	36.72	36.72
110	5550	36.72	36.96	36.72	36.72
134	5670	36.72	36.72	36.96	36.72
142 (UNII-2C Band)	5710	33.80	33.60	33.60	33.60
142 (UNII-3 Band)	5710	3.20	3.20	3.20	3.20

**802.11ac (VHT80)**

Channel	Channel Frequency (MHz)	Occupied Bandwidth (MHz)			
		CHAIN 0	CHAIN 1	CHAIN 2	CHAIN 3
58	5290	75.36	75.36	75.36	75.36
106	5530	75.36	75.36	75.36	75.36
122	5610	75.36	75.36	75.84	75.36
138 (UNII-2C Band)	5690	72.92	72.92	72.92	73.40
138 (UNII-3 Band)	5690	2.44	2.44	2.44	2.44

### Spectrum Plot of Worst Value

**802.11a\_Chain1 / CH52**

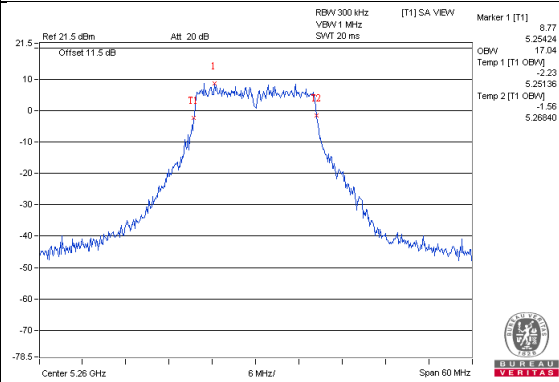

**802.11ac (VHT20)\_Chain0 / CH60**

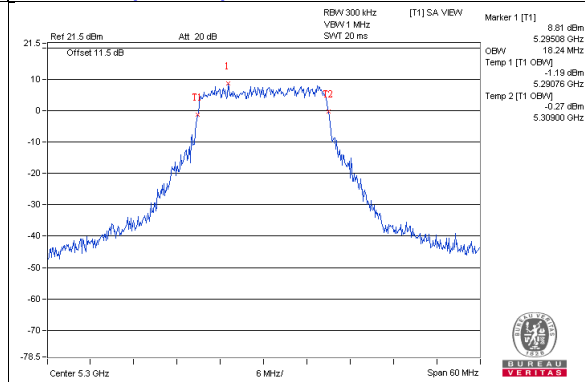

**802.11ac (VHT40)\_Chain1 / CH62**

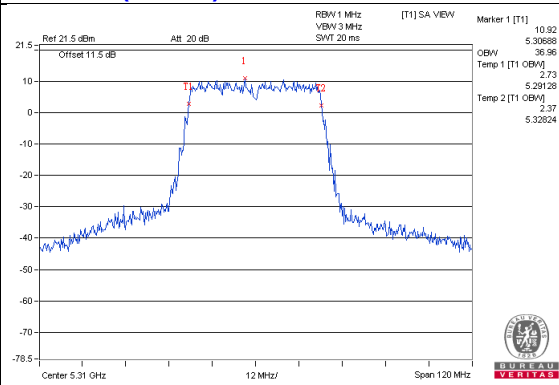

**802.11ac (VHT80)\_Chain2 / CH122**

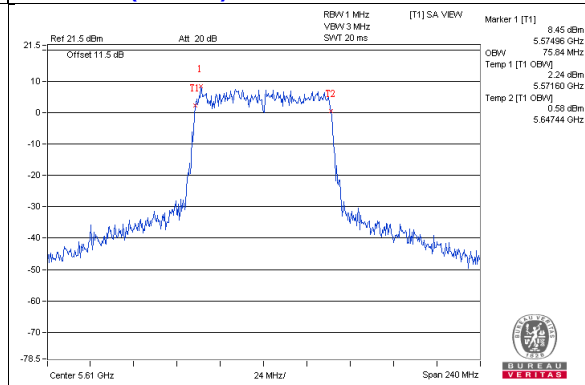

## 4.5 Peak Power Spectral Density Measurement

### 4.5.1 Limits of Peak Power Spectral Density Measurement

Operation Band	EUT Category		Limit
U-NII-1		Outdoor Access Point	17dBm/ MHz
		Fixed point-to-point Access Point	
		Indoor Access Point	
		Mobile and Portable client device	11dBm/ MHz
U-NII-2A	√		11dBm/ MHz
U-NII-2C	√		11dBm/ MHz
U-NII-3	√		30dBm/ 500kHz

### 4.5.2 Test Setup



### 4.5.3 Test Instruments

DESCRIPTION & MANUFACTURER	MODEL NO.	SERIAL NO.	CALIBRATED DATE	CALIBRATED UNTIL
Spectrum Analyzer R&S	FSv40	100964	June 28, 2016	June 27, 2017

- NOTE:**
1. The test was performed in Oven room 2.
  2. The calibration interval of the above test instruments is 12 months and the calibrations are traceable to NML/ROC and NIST/USA.
  3. Tested Date: Jan 05, 2017



#### 4.5.4 Test Procedure

##### **802.11ac (VHT20), 802.11ac (VHT40), 802.11ac (VHT80)**

##### **For U-NII-2A, UNII-2C:**

Using method SA-1

1. Set span to encompass the entire emission bandwidth (EBW) of the signal.
2. Set RBW = 1 MHz, Set VBW  $\geq$  3 MHz, Detector = RMS
3. Sweep time = auto, trigger set to "free run".
4. Trace average at least 100 traces in power averaging mode.
5. Record the max value

##### **For U-NII-3:**

1. Set span to encompass the entire emission bandwidth (EBW) of the signal.
2. Set RBW = 300 kHz, Set VBW  $\geq$  1 MHz, Detector = RMS
3. Use the peak marker function to determine the maximum power level in any 300 kHz band segment within the fundamental EBW.
4. Scale the observed power level to an equivalent value in 500 kHz by adjusting (reducing) the measured power by a bandwidth correction factor (BWCF) where  $BWCF = 10\log(500 \text{ kHz}/300\text{kHz})$
5. Sweep time = auto, trigger set to "free run".
6. Trace average at least 100 traces in power averaging mode.
7. Record the max value

##### **802.11a**

##### **For U-NII-2A, UNII-2C:**

Using method SA-2

1. Set span to encompass the entire emission bandwidth (EBW) of the signal.
2. Set RBW = 1 MHz, Set VBW  $\geq$  3 MHz, Detector = RMS
3. Sweep time = auto, trigger set to "free run".
4. Trace average at least 100 traces in power averaging mode.
5. Record the max value and add  $10 \log (1/\text{duty cycle})$

##### **For U-NII-3:**

1. Set span to encompass the entire emission bandwidth (EBW) of the signal.
2. Set RBW = 300 kHz, Set VBW  $\geq$  1 MHz, Detector = RMS
3. Use the peak marker function to determine the maximum power level in any 300 kHz band segment within the fundamental EBW.
4. Scale the observed power level to an equivalent value in 500 kHz by adjusting (reducing) the measured power by a bandwidth correction factor (BWCF) where  $BWCF = 10\log(500 \text{ kHz}/300\text{kHz})$
5. Sweep time = auto, trigger set to "free run".
6. Trace average at least 100 traces in power averaging mode.
7. Record the max value and add  $10 \log (1/\text{duty cycle})$

#### 4.5.5 Deviation from Test Standard

No deviation.

#### 4.5.6 EUT Operating Condition

Same as Item 4.3.6.

#### 4.5.7 Test Results

#### For U-NII-2A, UNII-2C:

#### CDD Mode

#### 802.11a

Chan.	Chan. Freq. (MHz)	PSD W/O Duty Factor (dBm/MHz)				Duty Factor (dB)	Total PSD With Duty Factor (dBm/MHz)	MAX. Limit (dBm/MHz)	Pass / Fail
		Chain 0	Chain 1	Chain 2	Chain 3				
52	5260	4.88	3.40	3.66	3.55	0.12	10.06	10.89	Pass
60	5300	4.37	3.19	4.15	3.86	0.12	10.06	10.82	Pass
64	5320	4.03	3.03	3.44	4.21	0.12	9.85	11.00	Pass
100	5500	3.49	2.86	2.82	2.70	0.12	9.12	10.20	Pass
116	5580	3.91	2.61	3.28	2.81	0.12	9.33	10.23	Pass
140	5700	2.95	2.43	2.00	2.07	0.12	8.52	10.63	Pass
144 (UNII-2C Band)	5720	2.17	1.74	1.28	2.32	0.12	8.04	10.60	Pass

- Note:**
- Method a) of power density measurement of KDB 662911 is using for calculating total power density. Total power density is summing entire spectra across corresponding frequency bins on the various outputs by computer.
  - For CH52 : The directional gain is 6.11dBi > 6dBi , so the power density limit shall be reduced to  $11-(6.11-6) = 10.89\text{dBm}$ .
  - For CH60 : The directional gain is 6.18dBi > 6dBi , so the power density limit shall be reduced to  $11-(6.18-6) = 10.82\text{dBm}$ .
  - For CH64 : The directional gain is 5.98dBi < 6dBi , so the power density limit shall not be reduced.
  - For CH100 : The directional gain is 6.80dBi > 6dBi , so the power density limit shall be reduced to  $11-(6.80-6) = 10.20\text{dBm}$ .
  - For CH116 : The directional gain is 6.77dBi > 6dBi , so the power density limit shall be reduced to  $11-(6.77-6) = 10.23\text{dBm}$ .
  - For CH140 : The directional gain is 6.37dBi > 6dBi , so the power density limit shall be reduced to  $11-(6.37-6) = 10.63\text{dBm}$ .
  - For CH144 : The directional gain is 6.40dBi > 6dBi , so the power density limit shall be reduced to  $11-(6.40-6) = 10.60\text{dBm}$ .
  - Refer to section 3.3 for duty cycle spectrum plot.

### 802.11ac (VHT20)

Chan.	Chan. Freq. (MHz)	PSD (dBm/MHz)				Total Power Density (dBm/MHz)	MAX. Limit (dBm/MHz)	Pass / Fail
		Chain 0	Chain 1	Chain 2	Chain 3			
52	5260	4.53	3.67	4.22	3.53	10.03	10.89	Pass
60	5300	4.34	2.92	3.64	3.52	9.66	10.82	Pass
64	5320	4.28	3.05	3.59	3.44	9.63	11.00	Pass
100	5500	3.00	2.63	2.73	2.54	8.75	10.20	Pass
116	5580	3.40	2.26	3.42	3.42	9.17	10.23	Pass
140	5700	2.09	1.57	1.75	2.24	7.94	10.63	Pass
144 (UNII-2C Band)	5720	2.17	1.57	2.04	2.00	7.97	10.60	Pass

- Note:**
- Method a) of power density measurement of KDB 662911 is using for calculating total power density. Total power density is summing entire spectra across corresponding frequency bins on the various outputs by computer.
  - For CH52 : The directional gain is 6.11dBi > 6dBi , so the power density limit shall be reduced to  $11-(6.11-6) = 10.89\text{dBm}$ .
  - For CH60 : The directional gain is 6.18dBi > 6dBi , so the power density limit shall be reduced to  $11-(6.18-6) = 10.82\text{dBm}$ .
  - For CH64 : The directional gain is 5.98dBi < 6dBi , so the power density limit shall not be reduced.
  - For CH100 : The directional gain is 6.80dBi > 6dBi , so the power density limit shall be reduced to  $11-(6.80-6) = 10.20\text{dBm}$ .
  - For CH116 : The directional gain is 6.77dBi > 6dBi , so the power density limit shall be reduced to  $11-(6.77-6) = 10.23\text{dBm}$ .
  - For CH140 : The directional gain is 6.37dBi > 6dBi , so the power density limit shall be reduced to  $11-(6.37-6) = 10.63\text{dBm}$ .
  - For CH144 : The directional gain is 6.40dBi > 6dBi , so the power density limit shall be reduced to  $11-(6.40-6) = 10.60\text{dBm}$ .

### 802.11ac (VHT40)

Chan.	Chan. Freq. (MHz)	PSD (dBm/MHz)				Total Power Density (dBm/MHz)	MAX. Limit (dBm/MHz)	Pass / Fail
		Chain 0	Chain 1	Chain 2	Chain 3			
54	5270	1.42	1.60	1.05	0.44	7.17	10.90	Pass
62	5310	1.10	1.04	0.89	0.16	6.83	11.00	Pass
102	5510	0.99	0.95	0.99	0.51	6.89	10.23	Pass
110	5550	1.60	1.11	1.16	1.20	7.29	10.45	Pass
134	5670	0.93	0.76	0.41	0.69	6.72	10.50	Pass
142 (UNII-2C Band)	5710	0.54	0.46	0.25	0.22	5.26	10.34	Pass

- Note:**
- Method a) of power density measurement of KDB 662911 is using for calculating total power density. Total power density is summing entire spectra across corresponding frequency bins on the various outputs by computer.
  - For CH54 : The directional gain is 6.10dBi > 6dBi , so the power limit shall be reduced to  $11-(6.10-6) = 10.90\text{dBm}$ .
  - For CH62 : The directional gain is 5.96dBi < 6dBi , so the power limit shall not be reduced.
  - For CH102 : The directional gain is 6.77dBi > 6dBi , , so the power limit shall be reduced to  $11-(6.77-6) = 10.23\text{dBm}$ .
  - For CH110 : The directional gain is 6.55dBi > 6dBi , so the power limit shall be reduced to  $11-(6.55-6) = 10.45\text{dBm}$ .
  - For CH134 : The directional gain is 6.50dBi > 6dBi , so the power limit shall be reduced to  $11-(6.50-6) = 10.50\text{dBm}$ .
  - For CH142: The directional gain is 6.66dBi > 6dBi , so the power limit shall be reduced to  $11-(6.66-6) = 10.34\text{dBm}$ .

### 802.11ac (VHT80)

Chan.	Chan. Freq. (MHz)	PSD (dBm/MHz)				Total Power Density (dBm/MHz)	MAX. Limit (dBm/MHz)	Pass / Fail
		Chain 0	Chain 1	Chain 2	Chain 3			
58	5290	-2.63	-2.45	-2.60	-4.20	3.11	10.81	Pass
106	5530	-2.20	-1.68	-2.43	-1.10	4.20	9.98	Pass
122	5610	-1.02	-0.53	-1.55	-1.19	4.96	10.45	Pass
138 (UNII-2C Band)	5690	-0.97	-1.28	-2.73	-2.16	4.29	10.66	Pass

**Note:** 1. Method a) of power density measurement of KDB 662911 is using for calculating total power density. Total power density is summing entire spectra across corresponding frequency bins on the various outputs by computer.

1. For CH58 : The directional gain is 6.19dBi > 6dBi , so the power limit shall be reduced to 11-(6.19-6) = 10.81dBm.
2. For CH106 : The directional gain is 7.02dBi > 6dBi , , so the power limit shall be reduced to 11-(7.02-6) = 9.98dBm.
3. For CH122 : The directional gain is 6.55dBi > 6dBi , , so the power limit shall be reduced to 11-(6.55-6) = 10.45dBm.
4. For CH138: The directional gain is 6.34dBi > 6dBi , so the power limit shall be reduced to 11-(6.34-6) = 10.66dBm.

Spectrum Plot of Worst Value

802.11a\_Chain 0 / CH52

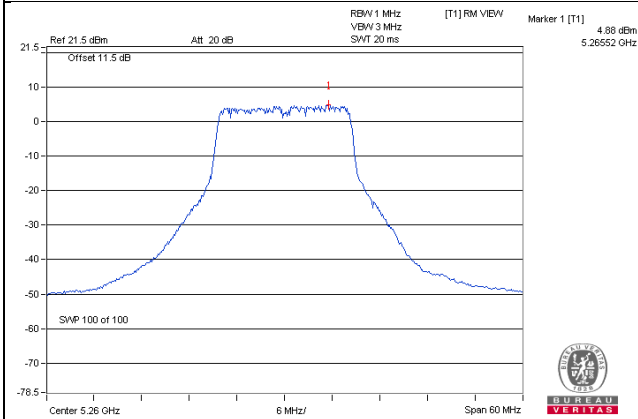

802.11ac (VHT20)\_Chain 0 / CH52

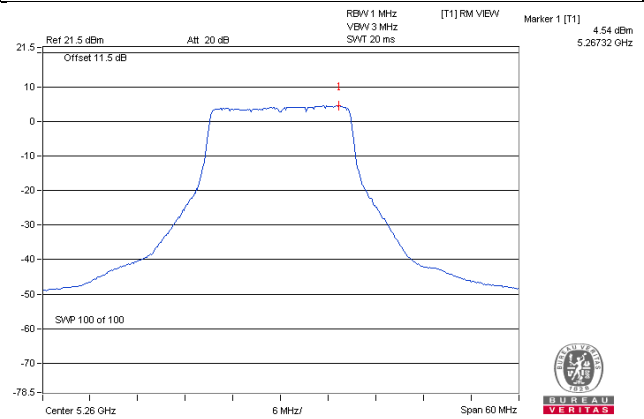

802.11ac (VHT40)\_Chain 1 / CH54

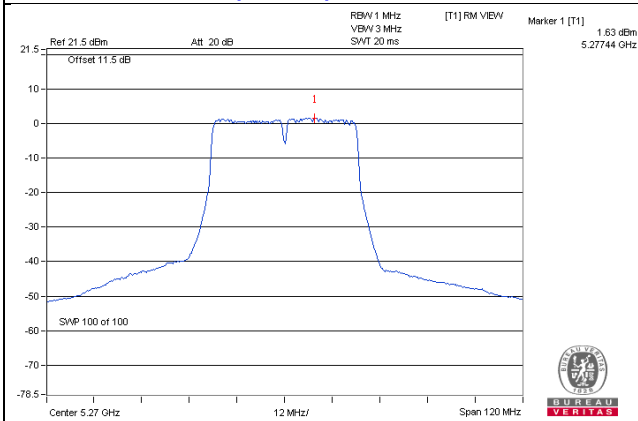

802.11ac (VHT80)\_Chain 1 / CH122

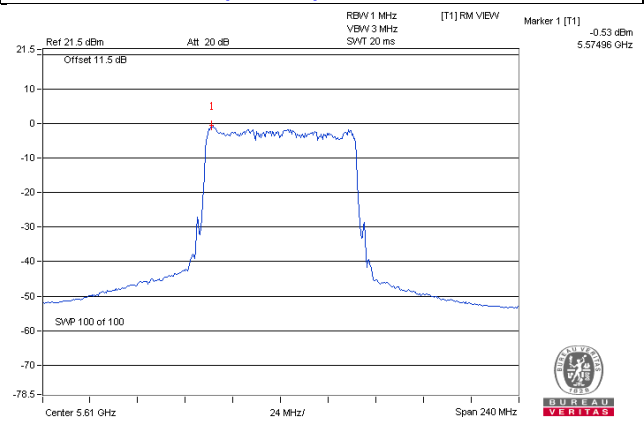

## Beamforming Mode

### 802.11ac (VHT20)

Chan.	Chan. Freq. (MHz)	PSD (dBm/MHz)				Total Power Density (dBm/MHz)	MAX. Limit (dBm/MHz)	Pass / Fail
		Chain 0	Chain 1	Chain 2	Chain 3			
52	5260	4.53	3.67	4.22	3.53	10.03	11.00	Pass
60	5300	4.34	2.92	3.64	3.52	9.66	11.00	Pass
64	5320	4.28	3.05	3.59	3.44	9.63	11.00	Pass
100	5500	3.90	3.70	3.52	3.90	9.78	11.00	Pass
116	5580	4.71	4.31	4.17	4.50	10.45	11.00	Pass
140	5700	3.30	3.29	3.23	3.74	9.42	11.00	Pass
144 (UNII-2C Band)	5720	3.57	2.99	3.43	3.44	9.38	11.00	Pass

- Note:**
- Method a) of power density measurement of KDB 662911 is using for calculating total power density. Total power density is summing entire spectra across corresponding frequency bins on the various outputs by computer.
  - For CH52 : The directional gain is 3.10dBi < 6dBi , so the power density limit shall not be reduced.
  - For CH60 : The directional gain is 3.17dBi < 6dBi , so the power density limit shall not be reduced.
  - For CH64 : The directional gain is 2.97dBi < 6dBi , so the power density limit shall not be reduced.
  - For CH100 : The directional gain is 3.79dBi < 6dBi , so the power density limit shall not be reduced.
  - For CH116 : The directional gain is 3.76dBi < 6dBi , so the power density limit shall not be reduced.
  - For CH140 : The directional gain is 3.36dBi < 6dBi , so the power density limit shall not be reduced.
  - For CH144 (UNII-2A): The directional gain is 3.39dBi < 6dBi , so the power density limit shall not be reduced.

### 802.11ac (VHT40)

Chan.	Chan. Freq. (MHz)	PSD (dBm/MHz)				Total Power Density (dBm/MHz)	MAX. Limit (dBm/MHz)	Pass / Fail
		Chain 0	Chain 1	Chain 2	Chain 3			
54	5270	1.42	1.60	1.05	0.44	7.17	11.00	Pass
62	5310	1.10	1.04	0.89	0.16	6.83	11.00	Pass
102	5510	0.99	0.95	0.99	0.51	6.89	11.00	Pass
110	5550	1.60	1.11	1.16	1.20	7.29	11.00	Pass
134	5670	0.93	0.76	0.41	0.69	6.72	11.00	Pass
142 (UNII-2C Band)	5710	0.54	0.46	0.25	0.22	6.39	11.00	Pass

- Note:**
- Method a) of power density measurement of KDB 662911 is using for calculating total power density. Total power density is summing entire spectra across corresponding frequency bins on the various outputs by computer.
  - For CH54 : The directional gain is 3.09dBi < 6dBi , so the power density limit shall not be reduced.
  - For CH62 : The directional gain is 2.95dBi < 6dBi , so the power density limit shall not be reduced.
  - For CH102 : The directional gain is 3.76dBi < 6dBi , so the power density limit shall not be reduced.
  - For CH110 : The directional gain is 3.54dBi < 6dBi , so the power density limit shall not be reduced.
  - For CH134 : The directional gain is 3.49dBi < 6dBi , so the power density limit shall not be reduced.
  - For CH142: The directional gain is 3.65dBi < 6dBi, so the power density limit shall not be reduced.



### 802.11ac (VHT80)

Chan.	Chan. Freq. (MHz)	PSD (dBm/MHz)				Total Power Density (dBm/MHz)	MAX. Limit (dBm/MHz)	Pass / Fail
		Chain 0	Chain 1	Chain 2	Chain 3			
58	5290	-2.63	-2.45	-2.60	-4.20	3.11	11.00	Pass
106	5530	-2.20	-1.68	-2.43	-1.10	4.20	11.00	Pass
122	5610	-1.02	-0.53	-1.55	-1.19	4.96	11.00	Pass
138 (UNII-2C Band)	5690	-0.97	-1.28	-2.73	-2.16	4.29	11.00	Pass

- Note:**
- Method a) of power density measurement of KDB 662911 is using for calculating total power density. Total power density is summing entire spectra across corresponding frequency bins on the various outputs by computer.
  - For CH58 : The directional gain is 3.18dBi < 6dBi, so the power density limit shall not be reduced.
  - For CH106 : The directional gain is 4.01dBi < 6dBi, so the power density limit shall not be reduced.
  - For CH122 : The directional gain is 3.54dBi < 6dBi, so the power density limit shall not be reduced.
  - For CH138: The directional gain is 3.33dBi < 6dBi, so the power density limit shall not be reduced.

Spectrum Plot of Worst Value

802.11ac (VHT20)\_Chain 0 / CH116

802.11ac (VHT40)\_Chain 1 / CH54

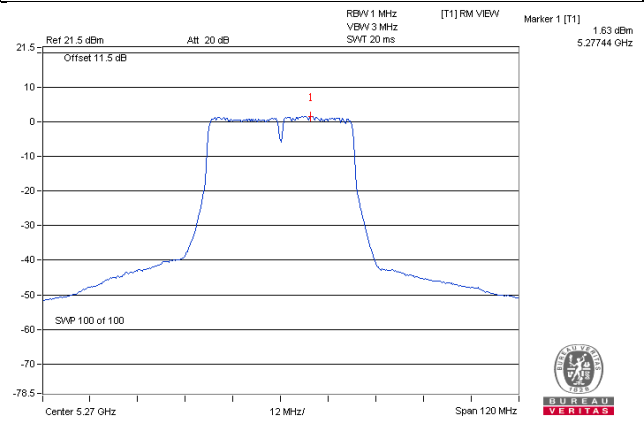
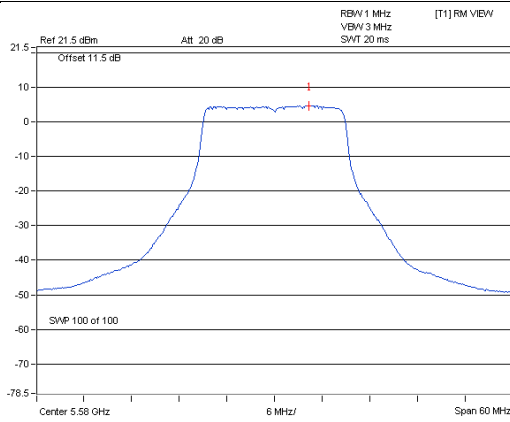

802.11ac (VHT80)\_Chain 1 / CH122

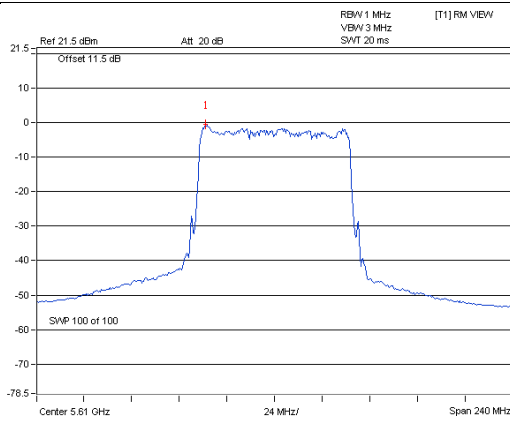

**For U-NII-3:**
**CDD Mode**
**802.11a**

TX chain	Chan.	Chan. Freq. (MHz)	PSD W/O Duty Factor		10 log (N=4) dB	Duty Factor (dB)	Total PSD With Duty Factor (dBm/500kHz)	Limit (dBm/500kHz)	Pass /Fail
			(dBm/300kHz)	(dBm/500kHz)					
0	144 (UNII-3 Band)	5720	-5.67	-3.45	6.02	0.12	2.69	29.60	Pass
1	144 (UNII-3 Band)	5720	-5.65	-3.43	6.02	0.12	2.71	29.60	Pass
2	144 (UNII-3 Band)	5720	-6.10	-3.88	6.02	0.12	2.26	29.60	Pass
3	144 (UNII-3 Band)	5720	-6.07	-3.85	6.02	0.12	2.29	29.60	Pass

Note: 1. Directional gain = 6.40dBi > 6dBi , so the power density limit shall be reduced to  $30-(6.40-6) = 29.60$ dBm.

**802.11ac (VHT20)**

TX chain	Channel	Freq. (MHz)	PSD (dBm/300kHz)	PSD (dBm/500kHz)	10 log (N=4) dB	Total PSD (dBm/500k Hz)	Limit (dBm/500kHz)	Pass /Fail
0	144 (UNII-3 Band)	5720	-5.59	-3.37	6.02	2.65	29.60	Pass
1	144 (UNII-3 Band)	5720	-6.37	-4.15	6.02	1.87	29.60	Pass
2	144 (UNII-3 Band)	5720	-5.95	-3.73	6.02	2.29	29.60	Pass
3	144 (UNII-3 Band)	5720	-6.16	-3.94	6.02	2.08	29.60	Pass

Note: 1. Directional gain = 6.40dBi > 6dBi, so the power density limit shall be reduced to  $30-(6.40-6) = 29.60$ dBm.

**802.11ac (VHT40)**

TX chain	Channel	Freq. (MHz)	PSD (dBm/300kHz)	PSD (dBm/500kHz)	10 log (N=4) dB	Total PSD (dBm/500k Hz)	Limit (dBm/500k Hz)	Pass /Fail
0	142 (UNII-3 Band)	5710	-9.05	-6.83	6.02	-0.81	29.34	Pass
1	142 (UNII-3 Band)	5710	-9.67	-7.45	6.02	-1.43	29.34	Pass
2	142 (UNII-3 Band)	5710	-9.81	-7.59	6.02	-1.57	29.34	Pass
3	142 (UNII-3 Band)	5710	-8.95	-6.73	6.02	-0.71	29.34	Pass

Note: 1. Directional gain = 6.66dBi > 6dBi, so the power density limit shall be reduced to  $30-(6.66-6) = 29.34$ dBm.

### 802.11ac (VHT80)

TX chain	Channel	Freq. (MHz)	PSD (dBm/300kHz)	PSD (dBm/500kHz)	10 log (N=4) dB	Total PSD (dBm/500k Hz)	Limit (dBm/500k Hz)	Pass /Fail
0	138 (UNII-3 Band)	5690	-11.33	-9.11	6.02	-3.09	29.66	Pass
1	138 (UNII-3 Band)	5690	-11.98	-9.76	6.02	-3.74	29.66	Pass
2	138 (UNII-3 Band)	5690	-12.40	-10.18	6.02	-4.16	29.66	Pass
3	138 (UNII-3 Band)	5690	-12.08	-9.86	6.02	-3.84	29.66	Pass

Note: 1. Directional gain = 6.34dBi > 6dBi, so the power density limit shall be reduced to  $30 - (6.34 - 6) = 29.66$ dBm.

### Spectrum Plot of Worst Value

**802.11a – Chain 1: CH 144(UNII-3)**

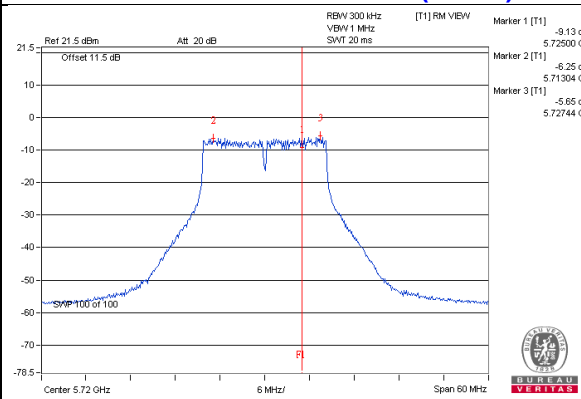

**802.11ac (VHT20) – Chain 0: CH 144(UNII-3)**

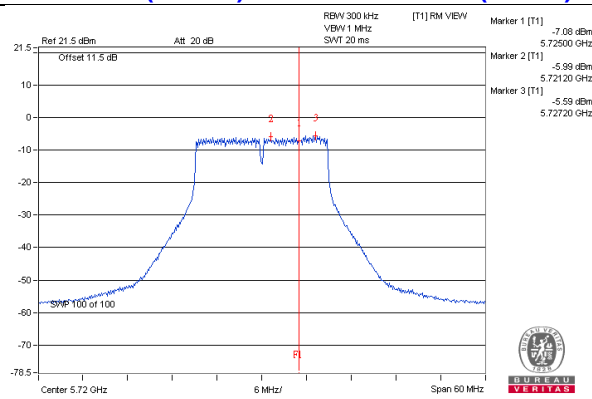

**802.11ac (VHT40) – Chain 3: CH 142**

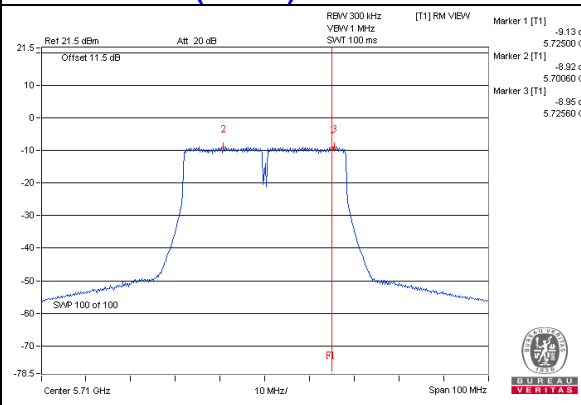

**802.11ac (VHT80) – Chain 0: CH 138**

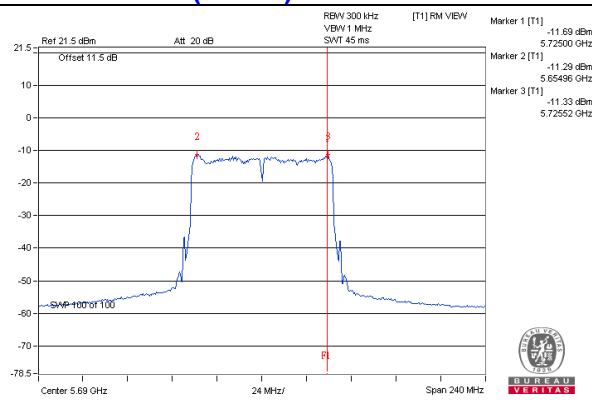

## Beamforming Mode

### 802.11ac (VHT20)

TX chain	Channel	Freq. (MHz)	PSD (dBm/300kHz)	PSD (dBm/500kHz)	10 log (N=4) dB	Total PSD (dBm/500k Hz)	Limit (dBm/500k Hz)	Pass /Fail
0	144 (UNII-3 Band)	5720	-4.44	-2.22	6.02	3.80	30.00	Pass
1	144 (UNII-3 Band)	5720	-5.01	-2.79	6.02	3.23	30.00	Pass
2	144 (UNII-3 Band)	5720	-4.73	-2.51	6.02	3.51	30.00	Pass
3	144 (UNII-3 Band)	5720	-4.54	-2.32	6.02	3.70	30.00	Pass

Note: 1. Directional gain = 3.39dBi < 6dBi , so the power density limit shall not be reduced .

### 802.11ac (VHT40)

TX chain	Channel	Freq. (MHz)	PSD (dBm/300kHz)	PSD (dBm/500kHz)	10 log (N=4) dB	Total PSD (dBm/500k Hz)	Limit (dBm/500k Hz)	Pass /Fail
0	142 (UNII-3 Band)	5710	-8.08	-5.86	6.02	0.16	30.00	Pass
1	142 (UNII-3 Band)	5710	-8.12	-5.90	6.02	0.12	30.00	Pass
2	142 (UNII-3 Band)	5710	-8.69	-6.47	6.02	-0.45	30.00	Pass
3	142 (UNII-3 Band)	5710	-7.67	-5.45	6.02	0.57	30.00	Pass

Note: 1. Directional gain = 3.65dBi < 6dBi , so the power density limit shall not be reduced .

### 802.11ac (VHT80)

TX chain	Channel	Freq. (MHz)	PSD (dBm/300kHz)	PSD (dBm/500kHz)	10 log (N=4) dB	Total PSD (dBm/500k Hz)	Limit (dBm/500k Hz)	Pass /Fail
0	138 (UNII-3 Band)	5690	-10.32	-8.10	6.02	-2.08	30.00	Pass
1	138 (UNII-3 Band)	5690	-10.64	-8.42	6.02	-2.40	30.00	Pass
2	138 (UNII-3 Band)	5690	-11.65	-9.43	6.02	-3.41	30.00	Pass
3	138 (UNII-3 Band)	5690	-11.02	-8.80	6.02	-2.78	30.00	Pass

Note: 1. Directional gain = 3.33dBi < 6dBi , so the power density limit shall not be reduced .

### Spectrum Plot of Worst Value

#### 802.11ac (VHT20) – Chain 0: CH 144

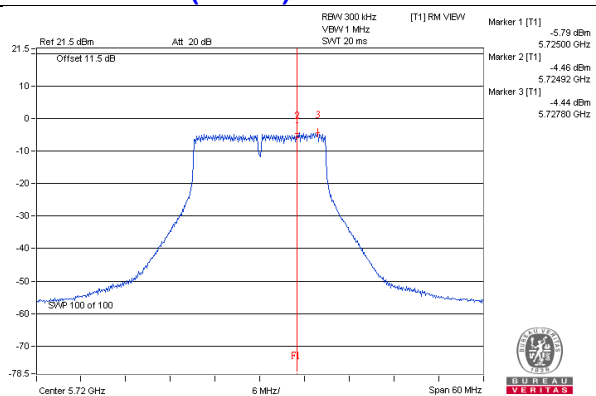

#### 802.11ac (VHT40) – Chain 3: CH 142

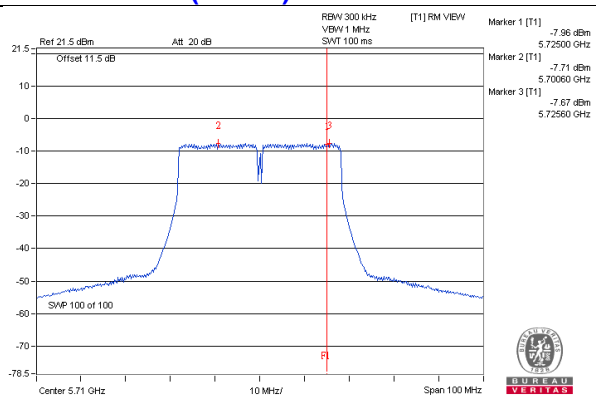

#### 802.11ac (VHT80) – Chain 0: CH 138

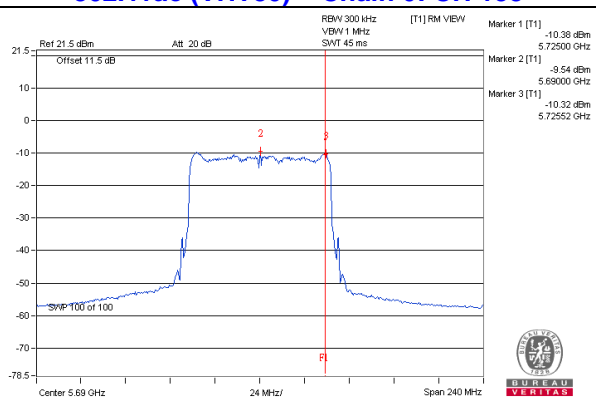

## 4.6 Frequency Stability Measurement

### 4.6.1 Limits of Frequency Stability Measurement

The frequency of the carrier signal shall be maintained within band of operation

### 4.6.2 Test Setup

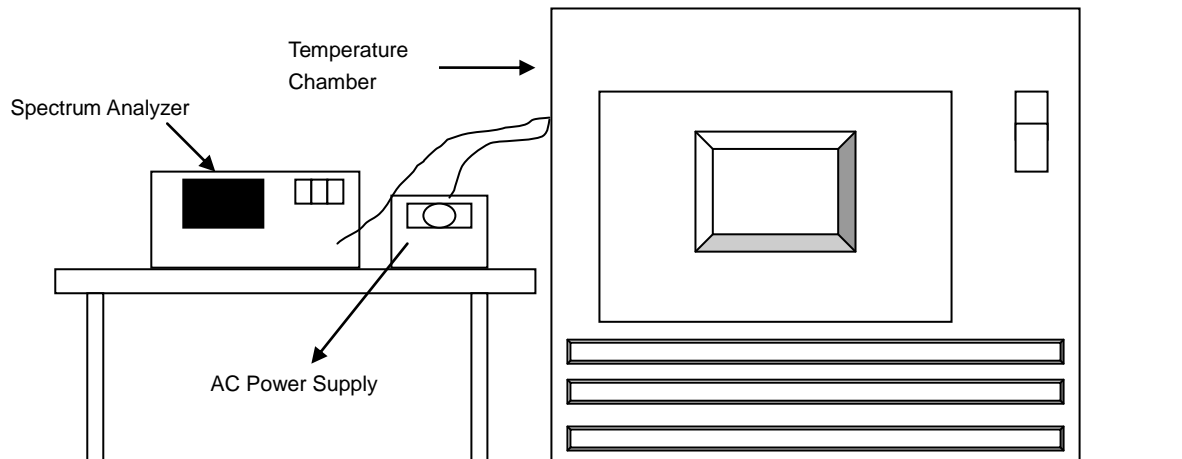

### 4.6.3 Test Instruments

DESCRIPTION & MANUFACTURER	MODEL NO.	SERIAL NO.	CALIBRATED DATE	CALIBRATED UNTIL
Spectrum Analyzer R&S	FSv40	100964	June 28, 2016	June 27, 2017
AC Power Source Extech Electronics	6205	1440452	NA	NA
Temperature & Humidity Chamber Giant Force	GTH-150-40-SP-AR	MAA0812-008	Jan. 15, 2016	Jan. 14, 2017
Digital Multimeter FLUKE	87III	73680266	Nov. 10, 2016	Nov. 09, 2017

- NOTE:**
1. The test was performed in Oven room 2.
  2. The calibration interval of the above test instruments is 12 months and the calibrations are traceable to NML/ROC and NIST/USA.
  3. Tested Date: Jan 05, 2017



#### 4.6.4 Test Procedure

- a. The EUT was placed inside the environmental test chamber and powered by nominal AC voltage.
- b. Turn the EUT on and couple its output to a spectrum analyzer.
- c. Turn the EUT off and set the chamber to the highest temperature specified.
- d. Allow sufficient time (approximately 30 min) for the temperature of the chamber to stabilize, turn the EUT on and measure the operating frequency after 2, 5, and 10 Minutes.
- e. Repeat step 2 and 3 with the temperature chamber set to the lowest temperature.
- f. The test chamber was allowed to stabilize at +20 degree C for a minimum of 30 Minutes. The supply voltage was then adjusted on the EUT from 85% to 115% and the frequency record.

#### 4.6.5 Deviation from Test Standard

No deviation.

#### 4.6.6 EUT Operating Condition

Set the EUT transmit at un-modulation mode to test frequency stability.

## 4.6.7 Test Results

Frequency Stability Versus Temp.									
Operating Frequency: 5260 MHz									
TEMP. (°C)	Power Supply (Vac)	0 Minute		2 Minute		5 Minute		10 Minute	
		Measured Frequency (MHz)	Pass/Fail	Measured Frequency (MHz)	Pass/Fail	Measured Frequency (MHz)	Pass/Fail	Measured Frequency (MHz)	Pass/Fail
50	120	5260.0186	Pass	5260.019	Pass	5260.0204	Pass	5260.0214	Pass
40	120	5260.0246	Pass	5260.0271	Pass	5260.0263	Pass	5260.0222	Pass
30	120	5260.0252	Pass	5260.0256	Pass	5260.0223	Pass	5260.0223	Pass
20	120	5259.9791	Pass	5259.9783	Pass	5259.98	Pass	5259.978	Pass
10	120	5259.9778	Pass	5259.9792	Pass	5259.978	Pass	5259.98	Pass
0	120	5259.998	Pass	5259.9957	Pass	5259.9962	Pass	5259.9968	Pass
-10	120	5260.0159	Pass	5260.0177	Pass	5260.0164	Pass	5260.0182	Pass
-20	120	5259.9825	Pass	5259.9791	Pass	5259.9812	Pass	5259.9796	Pass
-30	120	5260.0238	Pass	5260.0248	Pass	5260.0235	Pass	5260.025	Pass

Frequency Stability Versus Voltage									
Operating Frequency: 5260 MHz									
TEMP. (°C)	Power Supply (Vac)	0 Minute		2 Minute		5 Minute		10 Minute	
		Measured Frequency (MHz)	Pass/Fail	Measured Frequency (MHz)	Pass/Fail	Measured Frequency (MHz)	Pass/Fail	Measured Frequency (MHz)	Pass/Fail
20	138	5259.9794	Pass	5259.9776	Pass	5259.9809	Pass	5259.9784	Pass
	120	5259.9791	Pass	5259.9783	Pass	5259.98	Pass	5259.978	Pass
	102	5259.9782	Pass	5259.9793	Pass	5259.9791	Pass	5259.9771	Pass

## 4.7 6dB Bandwidth Measurement

### 4.7.1 Limits of 6dB Bandwidth Measurement

The minimum of 6dB Bandwidth Measurement is 0.5MHz.

### 4.7.2 Test Setup

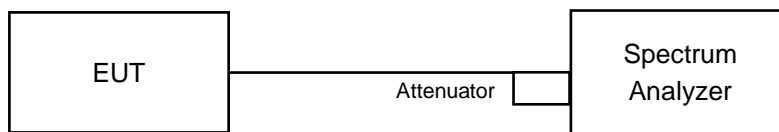

### 4.7.3 Test Instruments

DESCRIPTION & MANUFACTURER	MODEL NO.	SERIAL NO.	CALIBRATED DATE	CALIBRATED UNTIL
Spectrum Analyzer R&S	FSv40	100964	June 28, 2016	June 27, 2017

- NOTE:**
1. The test was performed in Oven room 2.
  2. The calibration interval of the above test instruments is 12 months and the calibrations are traceable to NML/ROC and NIST/USA.
  3. Tested Date: Jan 05, 2017

### 4.7.4 Test Procedure

#### MEASUREMENT PROCEDURE REF

- a. Set resolution bandwidth (RBW) = 100kHz
- b. Set the video bandwidth (VBW)  $\geq 3 \times$  RBW, Detector = Peak.
- c. Trace mode = max hold.
- d. Sweep = auto couple.
- e. Measure the maximum width of the emission that is constrained by the frequencies associated with the two amplitude points (upper and lower) that are attenuated by 6 dB relative to the maximum level measured in the fundamental emission

### 4.7.5 Deviation from Test Standard

No deviation.

### 4.7.6 EUT Operating Condition

The software provided by client to enable the EUT under transmission condition continuously at lowest, middle and highest channel frequencies individually.

#### 4.7.7 Test Results

##### CDD Mode

##### 802.11a

Channel	Frequency (MHz)	6dB Bandwidth (MHz)				Minimum Limit (MHz)	Pass / Fail
		Chain 0	Chain 1	Chain 2	Chain 3		
144 (UNII-3 Band)	5720	3.12	3.13	3.13	3.14	0.5	Pass

Note: The 6dB bandwidth above 5725MHz = Marker 1 + Delta 2 - 5725MHz

##### Beamforming Mode

##### 802.11ac (VHT20)

Channel	Frequency (MHz)	6dB Bandwidth (MHz)				Minimum Limit (MHz)	Pass / Fail
		Chain 0	Chain 1	Chain 2	Chain 3		
144 (UNII-3 Band)	5720	3.77	3.77	3.78	3.77	0.5	Pass

Note: The 6dB bandwidth above 5725MHz = Marker 1 + Delta 2 - 5725MHz

##### 802.11ac (VHT40)

Channel	Frequency (MHz)	6dB Bandwidth (MHz)				Minimum Limit (MHz)	Pass / Fail
		Chain 0	Chain 1	Chain 2	Chain 3		
142 (UNII-3 Band)	5710	3.15	3.12	3.12	3.15	0.5	Pass

Note: The 6dB bandwidth above 5725MHz = Marker 1 + Delta 2 - 5725MHz

##### 802.11ac (VHT80)

Channel	Frequency (MHz)	6dB Bandwidth (MHz)				Minimum Limit (MHz)	Pass / Fail
		Chain 0	Chain 1	Chain 2	Chain 3		
138 (UNII-3 Band)	5690	2.67	1.76	2.71	2.71	0.5	Pass

Note: The 6dB bandwidth above 5725MHz = Marker 1 + Delta 2 - 5725MHz

Spectrum Plot of Worst Value

802.11a\_Chain 0 / CH144(UNII-3)

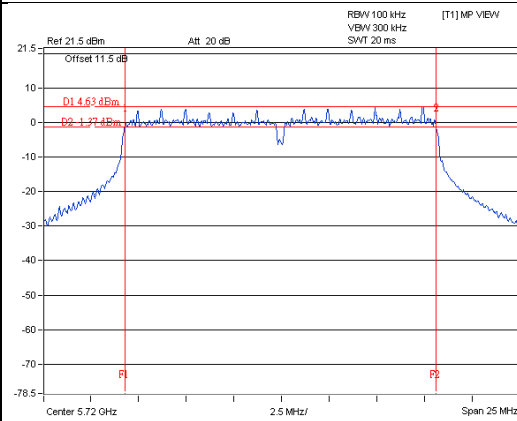

802.11ac (VHT20)\_Chain 1 / CH144(UNII-3)

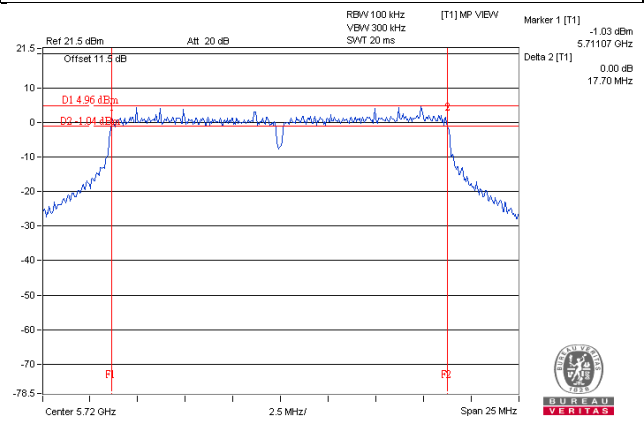

802.11ac (VHT40)\_Chain 1 / CH142(UNII-3)

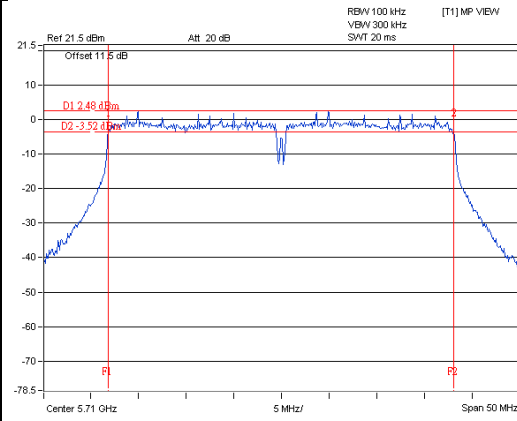

802.11ac (VHT80)\_Chain 1 / CH138(UNII-3)

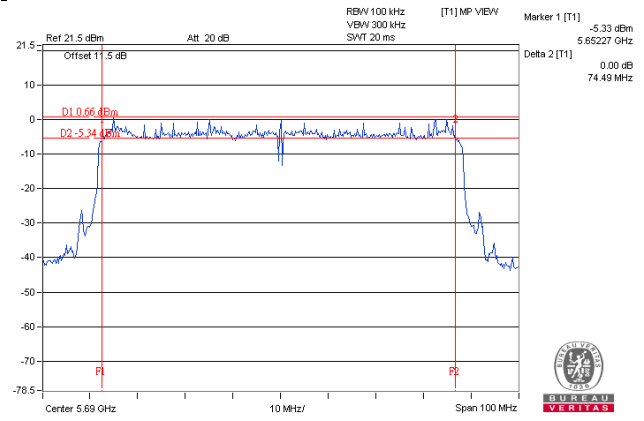

## 5 Pictures of Test Arrangements

Please refer to the attached file (Test Setup Photo).

## Appendix – Information on the Testing Laboratories

We, Bureau Veritas Consumer Products Services (H.K.) Ltd., Taoyuan Branch, were founded in 1988 to provide our best service in EMC, Radio, Telecom and Safety consultation. Our laboratories are FCC recognized accredited test firms and accredited according to ISO/IEC 17025.

If you have any comments, please feel free to contact us at the following:

**Linko EMC/RF Lab**

Tel: 886-2-26052180

Fax: 886-2-26051924

**Hsin Chu EMC/RF/Telecom Lab**

Tel: 886-3-6668565

Fax: 886-3-6668323

**Hwa Ya EMC/RF/Safety Lab**

Tel: 886-3-3183232

Fax: 886-3-3270892

**Email:** [service.adt@tw.bureauveritas.com](mailto:service.adt@tw.bureauveritas.com)

**Web Site:** [www.bureauveritas-adt.com](http://www.bureauveritas-adt.com)

The address and road map of all our labs can be found in our web site also.

--- END ---