

FCC Test Report

Report No.: RF170714E03-1

FCC ID: I88WAP6804

Test Model: WAP6804

Received Date: Apr. 20, 2016

Test Date: May 03 to 05, 2016 ; Aug. 09 to 10, 2017

Issued Date: Sep. 05, 2017

Applicant: Zyxel Communications Corporation

Address: No.2 Industry East RD. IX, Hsinchu Science Park, Hsinchu 30075, Taiwan

Issued By: Bureau Veritas Consumer Products Services (H.K.) Ltd., Taoyuan Branch
Hsin Chu Laboratory

Lab Address: E-2, No.1, Li Hsin 1st Road, Hsinchu Science Park, Hsinchu City 300,
Taiwan R.O.C.

Test Location (1): E-2, No.1, Li Hsin 1st Road, Hsinchu Science Park, Hsinchu City 300,
Taiwan R.O.C.

Test Location (2): No. 49, Ln. 206, Wende Rd., Shangshan Tsuen, Chiung Lin Hsiang, Hsin
Chu Hsien 307, Taiwan R.O.C.



This report is for your exclusive use. Any copying or replication of this report to or for any other person or entity, or use of our name or trademark, is permitted only with our prior written permission. This report sets forth our findings solely with respect to the test samples identified herein. The results set forth in this report are not indicative or representative of the quality or characteristics of the lot from which a test sample was taken or any similar or identical product unless specifically and expressly noted. Our report includes all of the tests requested by you and the results thereof based upon the information that you provided to us. You have 60 days from date of issuance of this report to notify us of any material error or omission caused by our negligence, provided, however, that such notice shall be in writing and shall specifically address the issue you wish to raise. A failure to raise such issue within the prescribed time shall constitute your unqualified acceptance of the completeness of this report, the tests conducted and the correctness of the report contents. Unless specific mention, the uncertainty of measurement has been explicitly taken into account to declare the compliance or non-compliance to the specification. The report must not be used by the client to claim product certification, approval, or endorsement by TAF or any government agencies.

Table of Contents

Release Control Record	4
1 Certificate of Conformity	5
2 Summary of Test Results	6
2.1 Measurement Uncertainty	6
2.2 Modification Record	6
3 General Information	7
3.1 General Description of EUT	7
3.2 Description of Test Modes	12
3.2.1 Test Mode Applicability and Tested Channel Detail	13
3.3 Duty Cycle of Test Signal	15
3.4 Description of Support Units	16
3.4.1 Configuration of System under Test	17
3.5 General Description of Applied Standard	18
4 Test Types and Results	19
4.1 Radiated Emission and Bandedge Measurement	19
4.1.1 Limits of Radiated Emission and Bandedge Measurement	19
4.1.2 Test Instruments	20
4.1.3 Test Procedure	22
4.1.4 Deviation from Test Standard	22
4.1.5 Test Setup	23
4.1.6 EUT Operating Condition	24
4.1.7 Test Results	25
4.2 Conducted Emission Measurement	45
4.2.1 Limits of Conducted Emission Measurement	45
4.2.2 Test Instruments	45
4.2.3 Test Procedure	46
4.2.4 Deviation from Test Standard	46
4.2.5 Test Setup	46
4.2.6 EUT Operating Condition	46
4.2.7 Test Results	47
4.3 Transmit Power Measurement	49
4.3.1 Limits of Transmit Power Measurement	49
4.3.2 Test Setup	49
4.3.3 Test Instruments	49
4.3.4 Test Procedure	49
4.3.5 Deviation from Test Standard	49
4.3.6 EUT Operating Condition	49
4.3.7 Test Result	50
4.4 Occupied Bandwidth Measurement	60
4.4.1 Test Setup	60
4.4.2 Test Instruments	60
4.4.3 Test Procedure	60
4.4.4 Test Results	61
4.5 Peak Power Spectral Density Measurement	69
4.5.1 Limits of Peak Power Spectral Density Measurement	69
4.5.2 Test Setup	69
4.5.3 Test Instruments	69
4.5.4 Test Procedure	70
4.5.5 Deviation from Test Standard	70
4.5.6 EUT Operating Condition	70
4.5.7 Test Results	71
4.6 Frequency Stability Measurement	81
4.6.1 Limits of Frequency Stability Measurement	81

4.6.2 Test Setup.....	81
4.6.3 Test Instruments	81
4.6.4 Test Procedure	81
4.6.5 Deviation from Test Standard	81
4.6.6 EUT Operating Condition	81
4.6.7 Test Results	82
4.7 6dB Bandwidth Measurement	83
4.7.1 Limits of 6dB Bandwidth Measurement.....	83
4.7.2 Test Setup.....	83
4.7.3 Test Instruments	83
4.7.4 Test Procedure	83
4.7.5 Deviation from Test Standard	83
4.7.6 EUT Operating Condition	83
4.7.7 Test Results	84
5 Pictures of Test Arrangements.....	86
Annex A- Radiated Out of Band Emisison (OOBE) Measurement (For U-NII-3 band)	87
Appendix – Information on the Testing Laboratories	90

Release Control Record

Issue No.	Description	Date Issued
RF170714E03-1	Original release.	Sep. 05, 2017

1 Certificate of Conformity

Product: Dual-Band AC2100 Gigabit Wireless Bridge

Brand: ZYXEL

Test Model: WAP6804

Sample Status: ENGINEERING SAMPLE

Applicant: Zyxel Communications Corporation

Test Date: May 03 to 05, 2016 ; Aug. 09 to 10., 2017

Standard: 47 CFR FCC Part 15, Subpart E (Section 15.407)
ANSI C63.10: 2013

The above equipment has been tested by **Bureau Veritas Consumer Products Services (H.K.) Ltd., Taoyuan Branch**, and found compliance with the requirement of the above standards. The test record, data evaluation & Equipment Under Test (EUT) configurations represented herein are true and accurate accounts of the measurements of the sample's EMC characteristics under the conditions specified in this report.

Prepared by : Wendy Wu , **Date:** Sep. 05, 2017
Wendy Wu / Specialist

Approved by : May Chen , **Date:** Sep. 05, 2017
May Chen / Manager

2 Summary of Test Results

47 CFR FCC Part 15, Subpart E (SECTION 15.407)			
FCC Clause	Test Item	Result	Remarks
15.407(b)(6)	AC Power Conducted Emissions	PASS	Meet the requirement of limit. Minimum passing margin is -5.96dB at 0.24766MHz.
15.407(b) (1/2/3/4(i/ii)/6)	Radiated Emissions & Band Edge Measurement	PASS	Meet the requirement of limit. Minimum passing margin is -0.1dB at 5150.00MHz.
15.407(a)(1/2/3)	Max Average Transmit Power	PASS	Meet the requirement of limit.
---	Occupied Bandwidth Measurement	-	Reference only.
15.407(a)(1/2/3)	Peak Power Spectral Density	PASS	Meet the requirement of limit.
15.407(e)	6dB bandwidth	PASS	Meet the requirement of limit. (U-NII-3 Band only)
15.407(g)	Frequency Stability	PASS	Meet the requirement of limit.
15.203	Antenna Requirement	PASS	Antenna connector is i-pex not a standard connector.

*For U-NII-3 band compliance with rule part 15.407(b)(i), the OOB test plots were recorded in Annex A.

2.1 Measurement Uncertainty

Where relevant, the following measurement uncertainty levels have been estimated for tests performed on the EUT as specified in CISPR 16-4-2:

Measurement	Frequency	Expanded Uncertainty (k=2) (\pm)
Conducted Emissions at mains ports	150kHz ~ 30MHz	1.84 dB
Radiated Emissions up to 1 GHz	30MHz ~ 1GHz	5.30 dB
Radiated Emissions above 1 GHz	1GHz ~ 6GHz	3.43 dB
	6GHz ~ 18GHz	3.49 dB
	18GHz ~ 40GHz	4.11 dB

2.2 Modification Record

There were no modifications required for compliance.

3 General Information

3.1 General Description of EUT

Product	Dual-Band AC2100 Gigabit Wireless Bridge
Brand	ZYXEL
Test Model	WAP6804
RF CPU Model No.	QT3860BC
RF Chip Model No.	2.4GHz: RTL8192EE 5GHz: QT2518B
FW	1.00(ABKH.0)b3_20170630
Status of EUT	ENGINEERING SAMPLE
Power Supply Rating	DC 12V from power adapter
Modulation Type	CCK, DQPSK, DBPSK for DSSS 64QAM, 16QAM, QPSK, BPSK for OFDM 256QAM for OFDM in 11ac mode only
Modulation Technology	DSSS, OFDM
Transfer Rate	802.11b: up to 11Mbps 802.11a/g: up to 54Mbps 802.11n: up to 600Mbps 802.11ac: up to 1733.3Mbps
Operating Frequency	2.4GHz: 2.412 ~ 2.462GHz 5GHz: 5.18~ 5.24GHz, 5.745 ~ 5.825GHz
Number of Channel	2.4GHz: 802.11b, 802.11g, 802.11n (HT20): 11 802.11n (HT40): 7 5GHz: 802.11a, 802.11n (HT20), 802.11ac (VHT20): 9 802.11n (HT40), 802.11ac (VHT40): 4 802.11ac (VHT80): 2
Output Power	2.412 ~ 2.462GHz: 484.921mW 5.18 ~ 5.24GHz CDD Mode / Beamforming Mode (Nss=1) 769.216mW Beamforming Mode (Nss=2) 769.216mW 5.745 ~ 5.825GHz CDD Mode / Beamforming Mode (Nss=1) 792.287mW Beamforming Mode (Nss=2) 792.287mW
Antenna Type	2.4GHz: Printed antenna 5GHz: PCB antenna
Antenna Connector	2.4GHz: NA 5GHz: i-pex
Accessory Device	Adapter x 1
Data Cable Supplied	Ethernet cable x 1 (Unshielded, 1.8m)

Note:

1. Simultaneously transmission condition.

Condition	Technology	
1	WLAN 2.4GHz	WLAN 5GHz

Note: The emission of the simultaneous operation has been evaluated and no non-compliance was found.

2. The EUT power needs to be supplied from power adapter, the information is as below table:

Brand	Model No.	Spec.
UMEC	UP0181D-12PA	Input: 100-240V, 0.4A, 50/60Hz (MAX) Output: 12V, 1.5A DC Cable (unshielded, 1.5m)

3. The antennas provided to the EUT, please refer to the following table:

Frequency (MHz)	For 2.4GHz					
	Antenna Gain (dBi)					
	ANT_0			ANT_1		
2400-2483.5	2.46			2.7		
Frequency (MHz)	For 5GHz					
	Antenna Gain (dBi)					
	ANT_0			ANT_1		
	20 MHz	40 MHz	80 MHz	20 MHz	40 MHz	80 MHz
5180	2.52	--	--	3.13	--	--
5190	--	2.49	--	--	3.33	--
5200	2.92	--	--	3.33	--	--
5210	--	--	2.77	--	--	3.48
5230	--	2.27	--	--	2.91	--
5240	1.96	--	--	2.66	--	--
5745	3.46	--	--	3.46	--	--
5755	--	3.31	--	--	3.23	--
5775	--	--	3.3	--	--	2.7
5785	3.42	--	--	2.69	--	--
5795	--	3.55	--	--	2.47	--
5825	3.33	--	--	2.92	--	--
Frequency (MHz)	Antenna Gain (dBi)					
	ANT_2					
	ANT_2			ANT_3		
	20 MHz	40 MHz	80 MHz	20 MHz	40 MHz	80 MHz
5180	2.55	--	--	3.03	--	--
5190	--	2.35	--	--	3.18	--
5200	2.69	--	--	3.39	--	--
5210	--	--	3.27	--	--	3.15
5230	--	2.86	--	--	2.77	--
5240	2.92	--	--	2.89	--	--
5745	4.51	--	--	3.12	--	--
5755	--	3.83	--	--	3	--
5775	--	--	3.11	--	--	3.24
5785	3.2	--	--	3.26	--	--
5795	--	3.35	--	--	2.9	--
5825	3.96	--	--	2.92	--	--

4. The Directional gain table:

Frequency	Max Gain (dBi)			Max Gain (dBi)		
	4TX Nss=1 for CDD and TX BF			4TX Nss=2 for TX BF		
	20 MHz	40 MHz	80 MHz	20 MHz	40 MHz	80 MHz
5180	6.83	--	--	3.82	--	--
5190	--	6.65	--	--	3.64	--
5200	6.8	--	--	3.79	--	--
5210	--	--	6.81	--	--	3.8
5230	--	6.41	--	--	3.4	--
5240	6.19	--	--	3.18	--	--
5745	6.61	--	--	3.6	--	--
5755	--	6.4	--	--	3.39	--
5775	--	--	6.01	--	--	3
5785	6.38	--	--	3.37	--	--
5795	--	6.5	--	--	3.49	--
5825	6.27	--	--	3.26	--	--

Note:

1. Non-TxBF mode & TxBF mode antenna gain refer to KDB 662911 F 2) f) (ii)

$$DirectionalGain = 10 \cdot \log \left[\frac{\sum_{j=1}^{N_{SS}} \left\{ \sum_{k=1}^{N_{ANT}} g_{j,k} \right\}^2}{N_{ANT}} \right]$$

where

Each antenna is driven by no more than one spatial stream;

 N_{SS} = the number of independent spatial streams of data;

 N_{ANT} = the total number of antennas

 $g_{j,k} = 10^{G_k/20}$ if the k th antenna is being fed by spatial stream j , or zero if it is not;

 G_k is the gain in dBi of the k th antenna.

5. The EUT incorporates a MIMO function.

For 2.4GHz					
MODULATION MODE	DATA RATE (MCS)	TX & RX CONFIGURATION		NON-TXBF Mode	TXBF Mode
802.11b	1 ~ 11Mbps	2TX	2RX	v	-
802.11g	6 ~ 54Mbps	2TX	2RX	v	-
802.11n (HT20)	MCS 0~7	2TX	2RX	v	-
	MCS 8~15	2TX	2RX	v	-
802.11n (HT40)	MCS 0~7	2TX	2RX	v	-
	MCS 8~15	2TX	2RX	v	-
For 5GHz					
MODULATION MODE	DATA RATE (MCS)	TX & RX CONFIGURATION		NON-TXBF Mode	TXBF Mode
802.11a	6 ~ 54Mbps	4TX	4RX	v	-
802.11n (HT20)	MCS 0~7	4TX	4RX	v	v
	MCS 8~15	4TX	4RX	v	v
	MCS 16~23	4TX	4RX	v	v
	MCS 24~31	4TX	4RX	v	v
802.11n (HT40)	MCS 0~7	4TX	4RX	v	v
	MCS 8~15	4TX	4RX	v	v
	MCS 16~23	4TX	4RX	v	v
	MCS 24~31	4TX	4RX	v	v
802.11ac (VHT20)	MCS0~8 Nss=1	4TX	4RX	v	v
	MCS0~8 Nss=2	4TX	4RX	v	v
	MCS0~9 Nss=3	4TX	4RX	v	v
	MCS0~8 Nss=4	4TX	4RX	v	v
802.11ac (VHT40)	MCS0~9 Nss=1	4TX	4RX	v	v
	MCS0~9 Nss=2	4TX	4RX	v	v
	MCS0~9 Nss=3	4TX	4RX	v	v
	MCS0~9 Nss=4	4TX	4RX	v	v
802.11ac (VHT80)	MCS0~9 Nss=1	4TX	4RX	v	v
	MCS0~9 Nss=2	4TX	4RX	v	v
	MCS0~9 Nss=3	4TX	4RX	v	v
	MCS0~9 Nss=4	4TX	4RX	v	v

Note:

- All of modulation mode support beamforming function except 2.4GHz & 802.11a modulation mode.
- The EUT support Beamforming and CDD mode, therefore both mode were investigated and the worst case scenario was identified. The worst case data were presented in test report.
- The modulation and bandwidth are similar for 802.11n mode for 20MHz (40MHz) and 802.11ac mode for 20MHz (40MHz), therefore investigated worst case to representative mode in test report. (Final test mode refer section 3.2.1)

6. The power setting are list as below:

Master Mode			
Modulation Mode	Frequency (MHz)	Power Setting (CDD / Beamforming NSS=1)	Power Setting (Beamforming NSS=2)
802.11a	5180	21	-
	5200	23	-
	5240	23	-
	5745	23	-
	5785	23	-
	5825	23	-
802.11ac (VHT20)	5180	21	21
	5200	23	23
	5240	23	23
	5745	23	23
	5785	23	23
	5825	23	23
802.11ac (VHT40)	5190	18	18
	5230	23	23
	5755	23	23
	5795	23	23
802.11ac (VHT80)	5210	18	18
	5775	23	23
Client Mode			
Modulation Mode	Frequency (MHz)	Power Setting (CDD / Beamforming NSS=1)	Power Setting (Beamforming NSS=2)
802.11a	5180	17	-
	5200	17	-
	5240	17	-
802.11ac (VHT20)	5180	17	17
	5200	17	17
	5240	17	17
802.11ac (VHT40)	5190	17	17
	5230	17	17
802.11ac (VHT80)	5210	17	17

7. The above EUT information is declared by manufacturer and for more detailed features description, please refer to the manufacturer's specifications or user's manual.

3.2 Description of Test Modes

FOR 5180 ~ 5240MHz

4 channels are provided for 802.11a, 802.11n (HT20), 802.11ac (VHT20):

Channel	Frequency	Channel	Frequency
36	5180 MHz	44	5220 MHz
40	5200 MHz	48	5240 MHz

2 channels are provided for 802.11n (HT40), 802.11ac (VHT40):

Channel	Frequency	Channel	Frequency
38	5190 MHz	46	5230 MHz

1 channel is provided for 802.11ac (VHT80):

Channel	Frequency
42	5210MHz

FOR 5745 ~ 5825MHz:

5 channels are provided for 802.11a, 802.11n (HT20), 802.11ac (VHT20):

Channel	Frequency	Channel	Frequency
149	5745MHz	161	5805MHz
153	5765MHz	165	5825MHz
157	5785MHz		

2 channels are provided for 802.11n (HT40), 802.11ac (VHT40):

Channel	Frequency	Channel	Frequency
151	5755MHz	159	5795MHz

1 channel is provided for 802.11ac (VHT80):

Channel	Frequency
155	5775MHz

3.2.1 Test Mode Applicability and Tested Channel Detail

EUT CONFIGURE MODE	APPLICABLE TO				DESCRIPTION
	RE≥1G	RE<1G	PLC	APCM	
-	√	√	√	√	-

Where **RE≥1G**: Radiated Emission above 1GHz **RE<1G**: Radiated Emission below 1GHz
PLC: Power Line Conducted Emission **APCM**: Antenna Port Conducted Measurement

NOTE:

1. The EUT had been pre-tested on the positioned of each 2 axis. The worst case was found when positioned on **Y-plane**.

Radiated Emission Test (Above 1GHz):

- Pre-Scan has been conducted to determine the worst-case mode from all possible combinations between available modulations, data rates and antenna ports (if EUT with antenna diversity architecture).
- Following channel(s) was (were) selected for the final test as listed below.

CDD Mode						
MODE	FREQ. BAND (MHz)	AVAILABLE CHANNEL	TESTED CHANNEL	MODULATION TECHNOLOGY	MODULATION TYPE	DATA RATE (Mbps)
802.11a	5180-5240	36 to 48	36, 40, 48	OFDM	BPSK	6
802.11ac (VHT20)		36 to 48	36, 40, 48	OFDM	BPSK	6.5
802.11ac (VHT40)		38 to 46	38, 46	OFDM	BPSK	13.5
802.11ac (VHT80)		42	42	OFDM	BPSK	29.3
802.11a	5745-5825	149 to 165	149, 157, 165	OFDM	BPSK	6
802.11ac (VHT20)		149 to 165	149, 157, 165	OFDM	BPSK	6.5
802.11ac (VHT40)		151 to 159	151, 159	OFDM	BPSK	13.5
802.11ac (VHT80)		155	155	OFDM	BPSK	29.3

Radiated Emission Test (Below 1GHz):

- Pre-Scan has been conducted to determine the worst-case mode from all possible combinations between available modulations, data rates and antenna ports (if EUT with antenna diversity architecture).
- Following channel(s) was (were) selected for the final test as listed below.

CDD Mode						
MODE	FREQ. BAND (MHz)	AVAILABLE CHANNEL	TESTED CHANNEL	MODULATION TECHNOLOGY	MODULATION TYPE	DATA RATE (Mbps)
802.11ac (VHT20)	5745-5825	149 to 165	157	OFDM	BPSK	6.5

Power Line Conducted Emission Test:

- Pre-Scan has been conducted to determine the worst-case mode from all possible combinations between available modulations, data rates and antenna ports (if EUT with antenna diversity architecture).
- Following channel(s) was (were) selected for the final test as listed below.

CDD Mode						
MODE	FREQ. BAND (MHz)	AVAILABLE CHANNEL	TESTED CHANNEL	MODULATION TECHNOLOGY	MODULATION TYPE	DATA RATE (Mbps)
802.11ac (VHT20)	5745-5825	149 to 165	157	OFDM	BPSK	6.5

Antenna Port Conducted Measurement:

- This item includes all test value of each mode, but only includes spectrum plot of worst value of each mode.
- Pre-Scan has been conducted to determine the worst-case mode from all possible combinations between available modulations, data rates and antenna ports (if EUT with antenna diversity architecture).
- Following channel(s) was (were) selected for the final test as listed below.

CDD Mode						
MODE	FREQ. BAND (MHz)	AVAILABLE CHANNEL	TESTED CHANNEL	MODULATION TECHNOLOGY	MODULATION TYPE	DATA RATE (Mbps)
802.11a	5180-5240	36 to 48	36, 40, 48	OFDM	BPSK	6
802.11a	5745-5825	149 to 165	149, 157, 165	OFDM	BPSK	6
CDD Mode / Beamforming Mode (Nss=1) (Output power only)						
MODE	FREQ. BAND (MHz)	AVAILABLE CHANNEL	TESTED CHANNEL	MODULATION TECHNOLOGY	MODULATION TYPE	DATA RATE (Mbps)
802.11ac (VHT20)	5180-5240	36 to 48	36, 40, 48	OFDM	BPSK	6.5
802.11ac (VHT40)		38 to 46	38, 46	OFDM	BPSK	13.5
802.11ac (VHT80)		42	42	OFDM	BPSK	29.3
802.11ac (VHT20)	5745-5825	149 to 165	149, 157, 165	OFDM	BPSK	6.5
802.11ac (VHT40)		151 to 159	151, 159	OFDM	BPSK	13.5
802.11ac (VHT80)		155	155	OFDM	BPSK	29.3
Beamforming Mode (Nss=2)						
MODE	FREQ. BAND (MHz)	AVAILABLE CHANNEL	TESTED CHANNEL	MODULATION TECHNOLOGY	MODULATION TYPE	DATA RATE (Mbps)
802.11ac (VHT20)	5180-5240	36 to 48	36, 40, 48	OFDM	BPSK	13
802.11ac (VHT40)		38 to 46	38, 46	OFDM	BPSK	27
802.11ac (VHT80)		42	42	OFDM	BPSK	58.5
802.11ac (VHT20)	5745-5825	149 to 165	149, 157, 165	OFDM	BPSK	13
802.11ac (VHT40)		151 to 159	151, 159	OFDM	BPSK	27
802.11ac (VHT80)		155	155	OFDM	BPSK	58.5

Test Condition:

APPLICABLE TO	ENVIRONMENTAL CONDITIONS	INPUT POWER	TESTED BY
RE≥1G	23deg. C, 73%RH	120Vac, 60Hz	Gary Cheng
RE<1G	23deg. C, 68%RH	120Vac, 60Hz	Rey Chen
PLC	25deg. C, 75%RH	120Vac, 60Hz	Andy Ho
APCM	25deg. C, 60%RH	120Vac, 60Hz	Gary Cheng

3.3 Duty Cycle of Test Signal

Duty cycle of test signal is $\geq 98\%$, duty factor is not required.

802.11a: Duty cycle = $3.359 \text{ ms} / 3.405 \text{ ms} = 0.986$

802.11ac (VHT20): Duty cycle = $4.978 \text{ ms} / 5.021 \text{ ms} = 0.991$

802.11ac (VHT40): Duty cycle = $5.967 \text{ ms} / 6.024 \text{ ms} = 0.991$

802.11ac (VHT80): Duty cycle = $6.88 \text{ ms} / 6.939 \text{ ms} = 0.991$

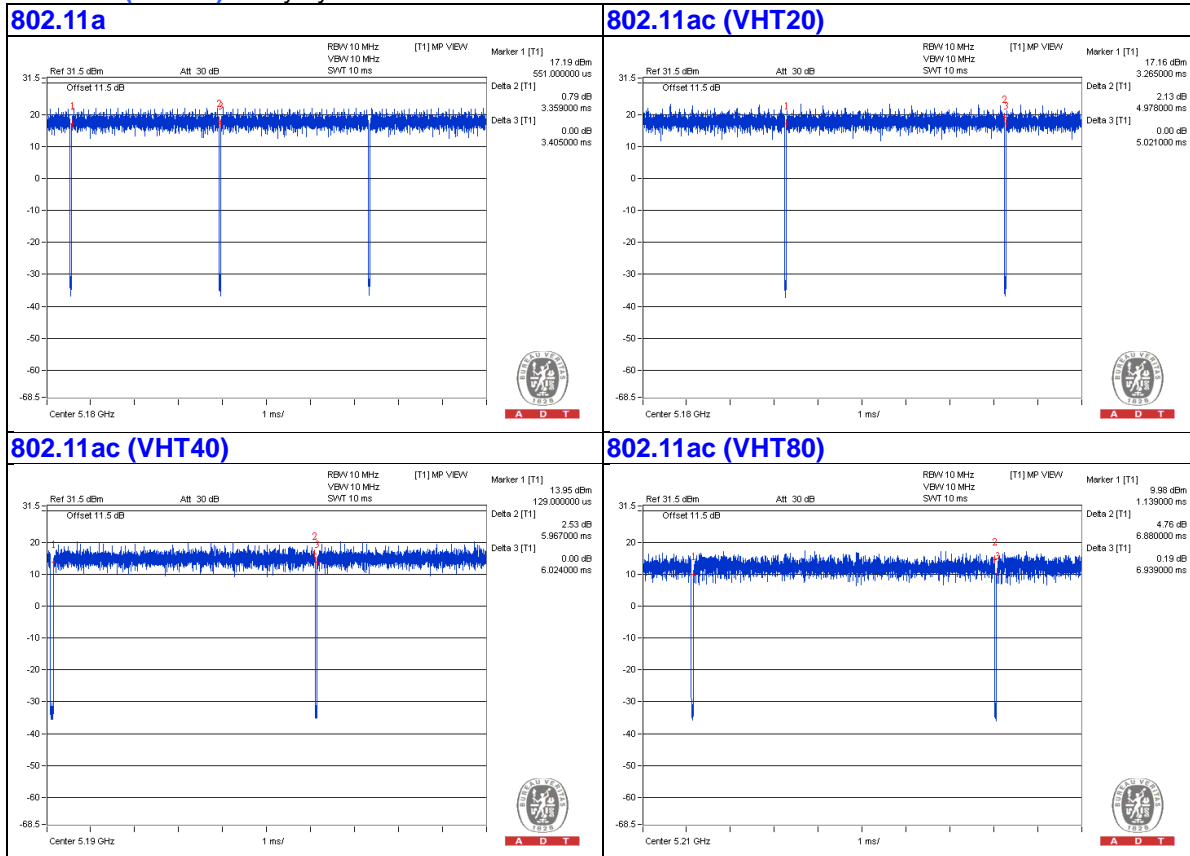

3.4 Description of Support Units

The EUT has been tested as an independent unit together with other necessary accessories or support units. The following support units or accessories were used to form a representative test configuration during the tests.

ID	Product	Brand	Model No.	Serial No.	FCC ID	Remarks
A.	Laptop	DELL	E5430	HYV4VY1	FCC DoC	Provided by Lab

Note:

1. All power cords of the above support units are non-shielded (1.8m).

ID	Descriptions	Qty.	Length (m)	Shielding (Yes/No)	Cores (Qty.)	Remarks
1.	RJ-45 Cable	1	10	No	0	Provided by Lab
2.	DC Cable	1	1.5	No	0	Supplied by client

3.4.1 Configuration of System under Test

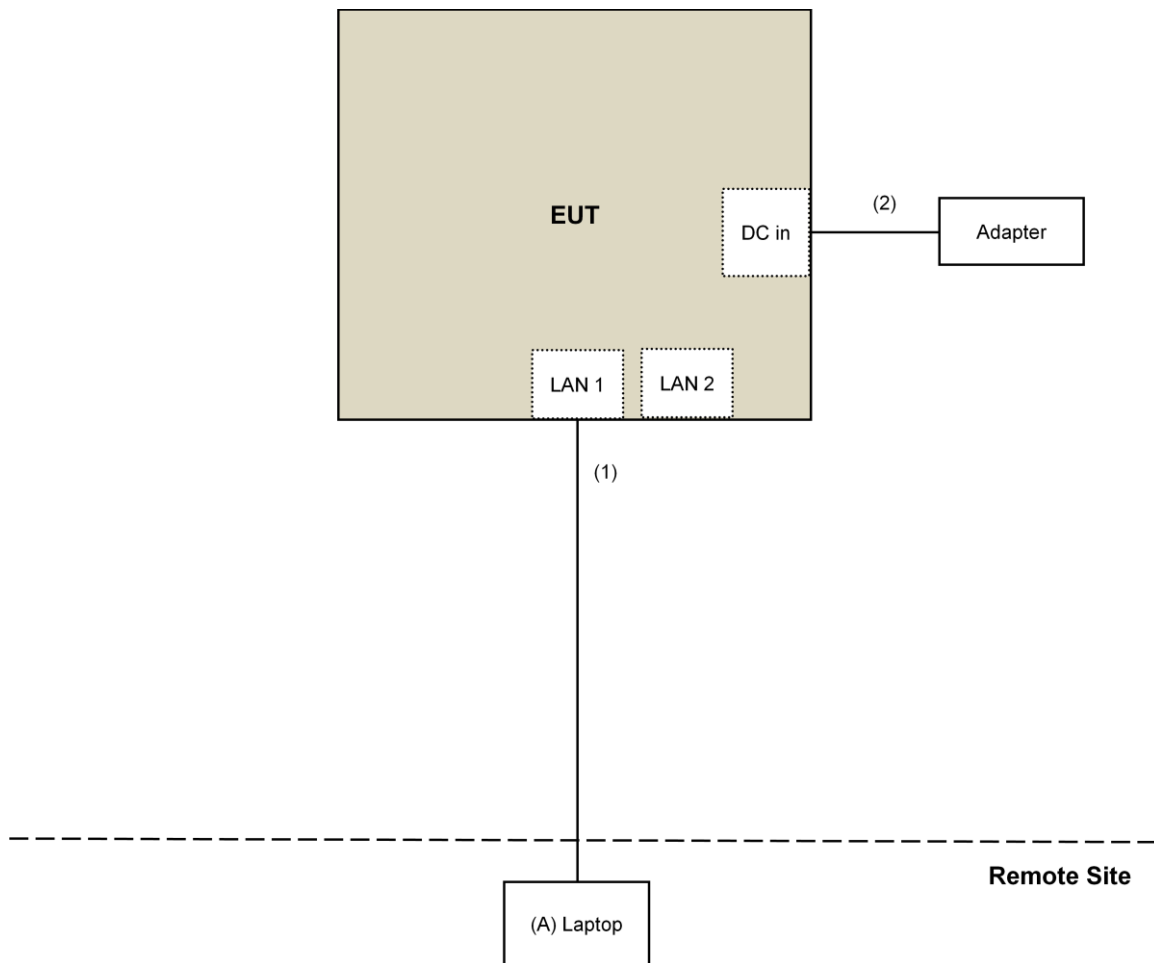

3.5 General Description of Applied Standard

The EUT is a RF Product. According to the specifications of the manufacturer, it must comply with the requirements of the following standards:

FCC Part 15, Subpart E (15.407)

KDB 789033 D02 General UNII Test Procedure New Rules v01r04

KDB 662911 D01 Multiple Transmitter Output v02r01

ANSI C63.10-2013

All test items have been performed and recorded as per the above standards.

NOTE: The EUT has been verified to comply with the requirements of FCC Part 15, Subpart B, Class B (DoC). The test report has been issued separately.

4 Test Types and Results

4.1 Radiated Emission and Bandedge Measurement

4.1.1 Limits of Radiated Emission and Bandedge Measurement

Radiated emissions which fall in the restricted bands must comply with the radiated emission limits specified as below table.

Frequencies (MHz)	Field Strength (microvolts/meter)	Measurement Distance (meters)
0.009 ~ 0.490	2400/F(kHz)	300
0.490 ~ 1.705	24000/F(kHz)	30
1.705 ~ 30.0	30	30
30 ~ 88	100	3
88 ~ 216	150	3
216 ~ 960	200	3
Above 960	500	3

NOTE:

1. The lower limit shall apply at the transition frequencies.
2. Emission level (dBuV/m) = 20 log Emission level (uV/m).
3. For frequencies above 1000MHz, the field strength limits are based on average detector, however, the peak field strength of any emission shall not exceed the maximum permitted average limits, specified above by more than 20dB under any condition of modulation.

Limits of unwanted emission out of the restricted bands

Applicable To		Limit	
789033 D02 General UNII Test Procedure New Rules v01r04		Field Strength at 3m	
		PK:74 (dBµV/m)	AV:54 (dBµV/m)
Frequency Band	Applicable To	EIRP Limit	Equivalent Field Strength at 3m
5150~5250 MHz	15.407(b)(1)	PK:-27 (dBm/MHz)	PK:68.2(dBµV/m)
5250~5350 MHz	15.407(b)(2)		
5470~5725 MHz	15.407(b)(3)		
5725~5850 MHz	<input checked="" type="checkbox"/> 15.407(b)(4)(i)	PK:-27 (dBm/MHz) ^{*1} PK:10 (dBm/MHz) ^{*2} PK:15.6 (dBm/MHz) ^{*3} PK:27 (dBm/MHz) ^{*4}	PK: 68.2(dBµV/m) ^{*1} PK:105.2 (dBµV/m) ^{*2} PK: 110.8(dBµV/m) ^{*3} PK:122.2 (dBµV/m) ^{*4}
	<input type="checkbox"/> 15.407(b)(4)(ii)	Emission limits in section 15.247(d)	
^{*1} beyond 75 MHz or more above of the band edge.		^{*2} below the band edge increasing linearly to 10 dBm/MHz at 25 MHz above.	
^{*3} below the band edge increasing linearly to a level of 15.6 dBm/MHz at 5 MHz above.		^{*4} from 5 MHz above or below the band edge increasing linearly to a level of 27 dBm/MHz at the band edge.	

Note:

The following formula is used to convert the equipment isotropic radiated power (eirp) to field strength:

$$E = \frac{1000000\sqrt{30P}}{3} \mu\text{V/m, where P is the eirp (Watts).}$$

4.1.2 Test Instruments

For below 1GHz test:

DESCRIPTION & MANUFACTURER	MODEL NO.	SERIAL NO.	CALIBRATED DATE	CALIBRATED UNTIL
Test Receiver Keysight	N9038A	MY54450088	July 08, 2017	July 07, 2018
Pre-Amplifier ^(*) EMCI	EMC001340	980142	Jan. 20, 2016	Jan. 19, 2018
Loop Antenna ^(*) Electro-Metrics	EM-6879	264	Dec. 16, 2016	Dec. 15, 2018
RF Cable	NA	LOOPCAB-001 LOOPCAB-002	Jan. 17, 2017	Jan. 16, 2018
Pre-Amplifier Mini-Circuits	ZFL-1000VH2B	AMP-ZFL-01	Nov. 10, 2016	Nov. 09, 2017
Trilog Broadband Antenna SCHWARZBECK	VULB 9168	9168-406	Dec. 13, 2016	Dec. 12, 2017
RF Cable	8D	966-4-1 966-4-2 966-4-3	Apr. 01, 2017	Mar. 31, 2018
Fixed attenuator Mini-Circuits	UNAT-5+	PAD-3m-4-01	Oct. 05, 2016	Oct. 04, 2017
Software	ADT_Radiated_V8.7.08	NA	NA	NA
Antenna Tower & Turn Table Max-Full	MF-7802	MF780208410	NA	NA

Note:

1. The calibration interval of the above test instruments is 12 months and the calibrations are traceable to NML/ROC and NIST/USA.
2. *The calibration interval of the above test instruments is 24 months and the calibrations are traceable to NML/ROC and NIST/USA.
3. Loop antenna was used for all emissions below 30 MHz.
4. The test was performed in 966 Chamber No. 4.
5. The CANADA Site Registration No. is 20331-2
6. Tested Date: Aug. 09, 2017

For other test:

DESCRIPTION & MANUFACTURER	MODEL NO.	SERIAL NO.	CALIBRATED DATE	CALIBRATED UNTIL
Horn_Antenna SCHWARZBECK	BBHA 9120D	9120D-783	Jan. 19, 2016	Jan. 18, 2017
Pre-Amplifier Agilent	8449B	3008A01922	Sep. 19, 2015	Sep. 18, 2016
RF Cable	EMC104-SM-SM-2000 EMC104-SM-SM-5000 EMC104-SM-SM-5000	150318 150323 150324	Mar. 30, 2016	Mar. 29, 2017
Pre-Amplifier EMCI	EMC184045	980143	Jan. 15, 2016	Jan. 14, 2017
Horn_Antenna SCHWARZBECK	BBHA 9170	BBHA9170608	Jan. 08, 2016	Jan. 07, 2017
RF Cable	SUCOFLEX 102	36432/2 36441/2	Jan. 16, 2016	Jan. 15, 2017
Software	ADT_Radiated_V8.7.07	NA	NA	NA
Antenna Tower & Turn Table CT	NA	NA	NA	NA
Boresight Antenna Fixture	NA	NA	NA	NA
SPECTRUM ANALYZER R&S	FSP 40	100036	Jan. 27, 2016	Jan. 26, 2017
Power meter Anritsu	ML2495A	0824006	May 25, 2015	May 24, 2016
Power sensor Anritsu	MA2411B	0738172	May 25, 2015	May 24, 2016
Temperature & Humidity Chamber GIANTFORCE	GTH-150-40-SP-AR	MAA0812-008	Jan. 15, 2016	Jan. 14, 2017
AC Power Source EXTECH Electronics	6205	1440452	NA	NA

Note:

1. The calibration interval of the above test instruments is 12 months and the calibrations are traceable to NML/ROC and NIST/USA.
2. *The calibration interval of the above test instruments is 24 months and the calibrations are traceable to NML/ROC and NIST/USA.
3. Loop antenna was used for all emissions below 30 MHz.
4. The test was performed in 966 Chamber No. 4.
5. The CANADA Site Registration No. is 20331-2
6. Tested Date: May 03 to 05, 2016

4.1.3 Test Procedure

For Radiated emission below 30MHz

- a. The EUT was placed on the top of a rotating table 0.8 meters above the ground at a 3 meter chamber room. The table was rotated 360 degrees to determine the position of the highest radiation.
- b. The EUT was set 3 meters away from the interference-receiving antenna, which was mounted on the top of a variable-height antenna tower.
- c. Both X and Y axes of the antenna are set to make the measurement.
- d. For each suspected emission, the EUT was arranged to its worst case and the rotatable table was turned from 0 degrees to 360 degrees to find the maximum reading.
- e. The test-receiver system was set to Quasi-Peak Detect Function and Specified Bandwidth with Maximum Hold Mode.

NOTE:

1. The resolution bandwidth and video bandwidth of test receiver/spectrum analyzer is 9kHz at frequency below 30MHz.

For Radiated emission above 30MHz

- a. The EUT was placed on the top of a rotating table 0.8 meters (for 30MHz ~ 1GHz) / 1.5 meters (for above 1GHz) above the ground at 3 meter chamber room for test. The table was rotated 360 degrees to determine the position of the highest radiation.
- b. The EUT was set 3 meters away from the interference-receiving antenna, which was mounted on the top of a variable-height antenna tower.
- c. The height of antenna is varied from one meter to four meters above the ground to determine the maximum value of the field strength. Both horizontal and vertical polarizations of the antenna are set to make the measurement.
- d. For each suspected emission, the EUT was arranged to its worst case and then the antenna was tuned to heights from 1 meter to 4 meters and the rotatable table was turned from 0 degrees to 360 degrees to find the maximum reading.
- e. The test-receiver system was set to quasi-peak detect function and specified bandwidth with maximum hold mode when the test frequency is below 1 GHz.
- f. The test-receiver system was set to peak and average detect function and specified bandwidth with maximum hold mode when the test frequency is above 1 GHz. If the peak reading value also meets average limit, measurement with the average detector is unnecessary.

Note:

1. The resolution bandwidth and video bandwidth of test receiver/spectrum analyzer is 120kHz for Quasi-peak detection (QP) at frequency below 1GHz.
2. The resolution bandwidth of test receiver/spectrum analyzer is 1 MHz and the video bandwidth is 3 MHz for Peak detection (PK) at frequency above 1GHz.
3. The resolution bandwidth of test receiver/spectrum analyzer is 1MHz and the video bandwidth is $\geq 1/T$ (Duty cycle $< 98\%$) or 10Hz (Duty cycle $\geq 98\%$) for Average detection (AV) at frequency above 1GHz.
4. All modes of operation were investigated and the worst-case emissions are reported.

4.1.4 Deviation from Test Standard

No deviation.

4.1.5 Test Setup

For Radiated emission below 30MHz

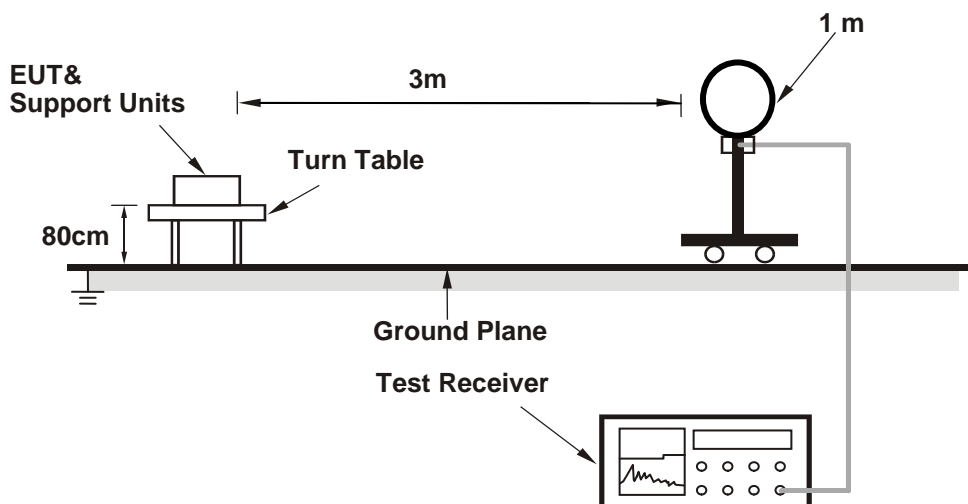

For Radiated emission 30MHz to 1GHz

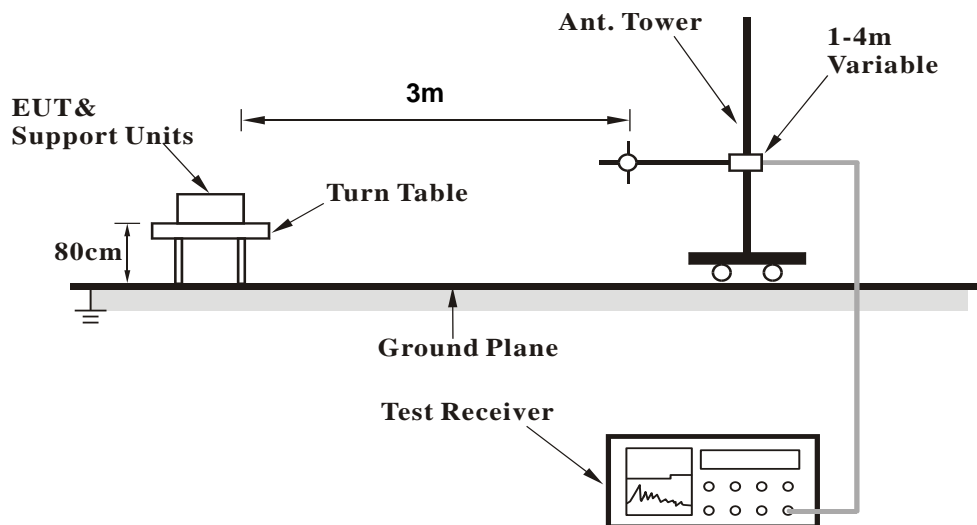

For Radiated emission above 1GHz

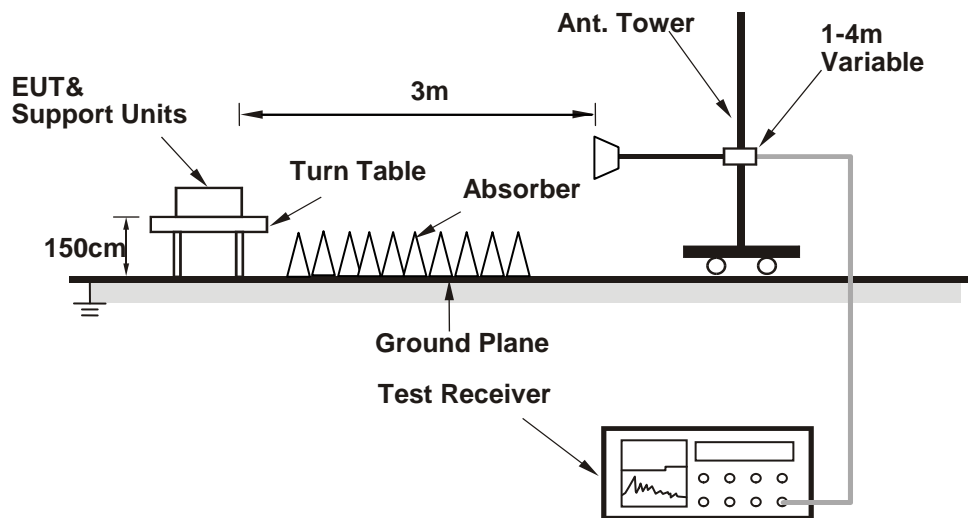

For the actual test configuration, please refer to the attached file (Test Setup Photo).

4.1.6 EUT Operating Condition

- a. Connected the EUT with the Laptop which is placed on remote site.
- b. Controlling software (Quantenna 5G WiFi command.txt) has been activated to set the EUT on specific status.

4.1.7 Test Results

Above 1GHz Data:

802.11a

CHANNEL	TX Channel 36	DETECTOR FUNCTION	Peak (PK)
FREQUENCY RANGE	1GHz ~ 40GHz		Average (AV)

ANTENNA POLARITY & TEST DISTANCE: HORIZONTAL AT 3 M

NO.	FREQ. (MHz)	EMISSION LEVEL (dBuV/m)	LIMIT (dBuV/m)	MARGIN (dB)	ANTENNA HEIGHT (m)	TABLE ANGLE (Degree)	RAW VALUE (dBuV)	CORRECTION FACTOR (dB/m)
1	5150.00	66.6 PK	74.0	-7.4	1.54 H	31	65.03	1.57
2	5150.00	52.7 AV	54.0	-1.3	1.54 H	31	51.13	1.57
3	*5180.00	116.6 PK			1.54 H	31	114.92	1.68
4	*5180.00	107.6 AV			1.54 H	31	105.92	1.68
5	#10360.00	57.9 PK	74.0	-16.1	3.48 H	301	46.18	11.72
6	#10360.00	48.7 AV	54.0	-5.3	3.48 H	301	36.98	11.72
7	15540.00	51.1 PK	74.0	-22.9	3.02 H	248	37.80	13.30
8	15540.00	43.9 AV	54.0	-10.1	3.02 H	248	30.60	13.30

ANTENNA POLARITY & TEST DISTANCE: VERTICAL AT 3 M

NO.	FREQ. (MHz)	EMISSION LEVEL (dBuV/m)	LIMIT (dBuV/m)	MARGIN (dB)	ANTENNA HEIGHT (m)	TABLE ANGLE (Degree)	RAW VALUE (dBuV)	CORRECTION FACTOR (dB/m)
1	5150.00	67.3 PK	74.0	-6.7	2.15 V	180	65.73	1.57
2	5150.00	53.9 AV	54.0	-0.1	2.15 V	180	52.33	1.57
3	*5180.00	117.2 PK			2.15 V	180	115.52	1.68
4	*5180.00	108.5 AV			2.15 V	180	106.82	1.68
5	#10360.00	63.4 PK	74.0	-10.6	2.25 V	85	51.68	11.72
6	#10360.00	51.2 AV	54.0	-2.8	2.25 V	85	39.48	11.72
7	15540.00	55.4 PK	74.0	-18.6	1.99 V	280	42.10	13.30
8	15540.00	43.7 AV	54.0	-10.3	1.99 V	280	30.40	13.30

REMARKS:

1. Emission Level(dBuV/m) = Raw Value(dBuV) + Correction Factor(dB/m)
2. Correction Factor(dB/m) = Antenna Factor(dB/m) + Cable Factor(dB) – Pre-Amplifier Factor(dB)
3. The other emission levels were very low against the limit.
4. Margin value = Emission Level – Limit value
5. " * ": Fundamental frequency.
6. " # ": The radiated frequency is out of the restricted band.

CHANNEL	TX Channel 40	DETECTOR FUNCTION	Peak (PK)
FREQUENCY RANGE	1GHz ~ 40GHz		Average (AV)

ANTENNA POLARITY & TEST DISTANCE: HORIZONTAL AT 3 M

NO.	FREQ. (MHz)	EMISSION LEVEL (dBuV/m)	LIMIT (dBuV/m)	MARGIN (dB)	ANTENNA HEIGHT (m)	TABLE ANGLE (Degree)	RAW VALUE (dBuV)	CORRECTION FACTOR (dB/m)
1	5150.00	58.9 PK	74.0	-15.1	1.52 H	16	57.33	1.57
2	5150.00	47.4 AV	54.0	-6.6	1.52 H	16	45.83	1.57
3	*5200.00	118.7 PK			1.52 H	16	116.96	1.74
4	*5200.00	109.7 AV			1.52 H	16	107.96	1.74
5	5350.00	61.9 PK	74.0	-12.1	1.52 H	16	59.79	2.11
6	5350.00	50.4 AV	54.0	-3.6	1.52 H	16	48.29	2.11
7	#10400.00	58.3 PK	74.0	-15.7	3.44 H	315	46.38	11.92
8	#10400.00	48.9 AV	54.0	-5.1	3.44 H	315	36.98	11.92
9	15600.00	51.2 PK	74.0	-22.8	3.02 H	253	37.90	13.30
10	15600.00	44.2 AV	54.0	-9.8	3.02 H	253	30.90	13.30

ANTENNA POLARITY & TEST DISTANCE: VERTICAL AT 3 M

NO.	FREQ. (MHz)	EMISSION LEVEL (dBuV/m)	LIMIT (dBuV/m)	MARGIN (dB)	ANTENNA HEIGHT (m)	TABLE ANGLE (Degree)	RAW VALUE (dBuV)	CORRECTION FACTOR (dB/m)
1	5150.00	59.6 PK	74.0	-14.4	2.18 V	165	58.03	1.57
2	5150.00	48.6 AV	54.0	-5.4	2.18 V	165	47.03	1.57
3	*5200.00	119.3 PK			2.18 V	165	117.56	1.74
4	*5200.00	110.6 AV			2.18 V	165	108.86	1.74
5	5350.00	62.6 PK	74.0	-11.4	2.18 V	165	60.49	2.11
6	5350.00	51.6 AV	54.0	-2.4	2.18 V	165	49.49	2.11
7	#10400.00	62.8 PK	74.0	-11.2	2.24 V	77	50.88	11.92
8	#10400.00	50.7 AV	54.0	-3.3	2.24 V	77	38.78	11.92
9	15600.00	55.6 PK	74.0	-18.4	2.00 V	266	42.30	13.30
10	15600.00	43.9 AV	54.0	-10.1	2.00 V	266	30.60	13.30

REMARKS:

1. Emission Level(dBuV/m) = Raw Value(dBuV) + Correction Factor(dB/m)
2. Correction Factor(dB/m) = Antenna Factor(dB/m) + Cable Factor(dB) – Pre-Amplifier Factor(dB)
3. The other emission levels were very low against the limit.
4. Margin value = Emission Level – Limit value
5. " * ": Fundamental frequency.
6. " # ": The radiated frequency is out of the restricted band.

CHANNEL	TX Channel 48	DETECTOR FUNCTION	Peak (PK)
FREQUENCY RANGE	1GHz ~ 40GHz		Average (AV)

ANTENNA POLARITY & TEST DISTANCE: HORIZONTAL AT 3 M

NO.	FREQ. (MHz)	EMISSION LEVEL (dBuV/m)	LIMIT (dBuV/m)	MARGIN (dB)	ANTENNA HEIGHT (m)	TABLE ANGLE (Degree)	RAW VALUE (dBuV)	CORRECTION FACTOR (dB/m)
1	*5240.00	118.9 PK			1.55 H	18	117.05	1.85
2	*5240.00	109.8 AV			1.55 H	18	107.95	1.85
3	5350.00	60.6 PK	74.0	-13.4	1.55 H	18	58.49	2.11
4	5350.00	49.8 AV	54.0	-4.2	1.55 H	18	47.69	2.11
5	#10480.00	58.4 PK	74.0	-15.6	3.42 H	315	46.14	12.26
6	#10480.00	48.9 AV	54.0	-5.1	3.42 H	315	36.64	12.26
7	15720.00	51.8 PK	74.0	-22.2	3.00 H	268	38.62	13.18
8	15720.00	44.6 AV	54.0	-9.4	3.00 H	268	31.42	13.18

ANTENNA POLARITY & TEST DISTANCE: VERTICAL AT 3 M

NO.	FREQ. (MHz)	EMISSION LEVEL (dBuV/m)	LIMIT (dBuV/m)	MARGIN (dB)	ANTENNA HEIGHT (m)	TABLE ANGLE (Degree)	RAW VALUE (dBuV)	CORRECTION FACTOR (dB/m)
1	*5240.00	119.5 PK			2.29 V	182	117.65	1.85
2	*5240.00	110.7 AV			2.29 V	182	108.85	1.85
3	5350.00	61.3 PK	74.0	-12.7	2.29 V	182	59.19	2.11
4	5350.00	51.0 AV	54.0	-3.0	2.29 V	182	48.89	2.11
5	#10480.00	62.5 PK	74.0	-11.5	2.22 V	74	50.24	12.26
6	#10480.00	50.6 AV	54.0	-3.4	2.22 V	74	38.34	12.26
7	15720.00	55.4 PK	74.0	-18.6	2.01 V	269	42.22	13.18
8	15720.00	43.8 AV	54.0	-10.2	2.01 V	269	30.62	13.18

REMARKS:

1. Emission Level(dBuV/m) = Raw Value(dBuV) + Correction Factor(dB/m)
2. Correction Factor(dB/m) = Antenna Factor(dB/m) + Cable Factor(dB) – Pre-Amplifier Factor(dB)
3. The other emission levels were very low against the limit.
4. Margin value = Emission Level – Limit value
5. " * ": Fundamental frequency.
6. " # ": The radiated frequency is out of the restricted band.

CHANNEL	TX Channel 149	DETECTOR FUNCTION	Peak (PK)
FREQUENCY RANGE	1GHz ~ 40GHz		Average (AV)

ANTENNA POLARITY & TEST DISTANCE: HORIZONTAL AT 3 M

NO.	FREQ. (MHz)	EMISSION LEVEL (dBuV/m)	LIMIT (dBuV/m)	MARGIN (dB)	ANTENNA HEIGHT (m)	TABLE ANGLE (Degree)	RAW VALUE (dBuV)	CORRECTION FACTOR (dB/m)
1	#5556.18	60.5 PK	68.2	-7.7	1.49 H	24	58.04	2.44
2	*5745.00	117.4 PK			1.49 H	24	114.58	2.82
3	*5745.00	108.4 AV			1.49 H	24	105.58	2.82
4	#5986.05	60.6 PK	68.2	-7.6	1.49 H	24	57.31	3.30
5	11490.00	59.8 PK	74.0	-14.2	3.71 H	132	46.34	13.46
6	11490.00	47.8 AV	54.0	-6.2	3.71 H	132	34.34	13.46
7	#17235.00	67.3 PK	68.2	-0.9	3.33 H	273	48.85	18.45

ANTENNA POLARITY & TEST DISTANCE: VERTICAL AT 3 M

NO.	FREQ. (MHz)	EMISSION LEVEL (dBuV/m)	LIMIT (dBuV/m)	MARGIN (dB)	ANTENNA HEIGHT (m)	TABLE ANGLE (Degree)	RAW VALUE (dBuV)	CORRECTION FACTOR (dB/m)
1	#5608.90	62.2 PK	68.2	-6.0	2.38 V	257	59.67	2.56
2	*5745.00	118.0 PK			2.38 V	257	115.18	2.82
3	*5745.00	109.3 AV			2.38 V	257	106.48	2.82
4	#5963.25	61.6 PK	68.2	-6.6	2.38 V	257	58.41	3.21
5	11490.00	59.8 PK	74.0	-14.2	2.10 V	291	46.34	13.46
6	11490.00	47.8 AV	54.0	-6.2	2.10 V	291	34.34	13.46
7	#17235.00	65.3 PK	68.2	-2.9	1.94 V	271	46.85	18.45

REMARKS:

1. Emission Level(dBuV/m) = Raw Value(dBuV) + Correction Factor(dB/m)
2. Correction Factor(dB/m) = Antenna Factor(dB/m) + Cable Factor(dB) – Pre-Amplifier Factor(dB)
3. The other emission levels were very low against the limit.
4. Margin value = Emission Level – Limit value
5. " * ": Fundamental frequency.
6. " # ": The radiated frequency is out of the restricted band.

CHANNEL	TX Channel 157	DETECTOR FUNCTION	Peak (PK)
FREQUENCY RANGE	1GHz ~ 40GHz		Average (AV)

ANTENNA POLARITY & TEST DISTANCE: HORIZONTAL AT 3 M

NO.	FREQ. (MHz)	EMISSION LEVEL (dBuV/m)	LIMIT (dBuV/m)	MARGIN (dB)	ANTENNA HEIGHT (m)	TABLE ANGLE (Degree)	RAW VALUE (dBuV)	CORRECTION FACTOR (dB/m)
1	#5627.90	59.9 PK	68.2	-8.3	1.44 H	25	57.33	2.59
2	*5785.00	117.9 PK			1.44 H	25	115.01	2.89
3	*5785.00	108.8 AV			1.44 H	25	105.91	2.89
4	#5952.32	60.7 PK	68.2	-7.5	1.44 H	25	57.51	3.17
5	11570.00	59.9 PK	74.0	-14.1	3.66 H	128	46.66	13.24
6	11570.00	47.8 AV	54.0	-6.2	3.66 H	128	34.56	13.24
7	#17355.00	68.0 PK	68.2	-0.2	3.28 H	273	48.90	19.10

ANTENNA POLARITY & TEST DISTANCE: VERTICAL AT 3 M

NO.	FREQ. (MHz)	EMISSION LEVEL (dBuV/m)	LIMIT (dBuV/m)	MARGIN (dB)	ANTENNA HEIGHT (m)	TABLE ANGLE (Degree)	RAW VALUE (dBuV)	CORRECTION FACTOR (dB/m)
1	#5583.73	61.9 PK	68.2	-6.3	2.33 V	299	59.36	2.50
2	*5785.00	117.9 PK			2.38 V	299	115.01	2.89
3	*5785.00	109.2 AV			2.38 V	299	106.31	2.89
4	#5938.55	62.4 PK	68.2	-5.8	2.33 V	299	59.31	3.11
5	11570.00	59.5 PK	74.0	-14.5	2.16 V	290	46.26	13.24
6	11570.00	47.6 AV	54.0	-6.4	2.16 V	290	34.36	13.24
7	#17355.00	65.3 PK	68.2	-2.9	1.93 V	284	46.20	19.10

REMARKS:

- Emission Level(dBuV/m) = Raw Value(dBuV) + Correction Factor(dB/m)
- Correction Factor(dB/m) = Antenna Factor(dB/m) + Cable Factor(dB) – Pre-Amplifier Factor(dB)
- The other emission levels were very low against the limit.
- Margin value = Emission Level – Limit value
- " * ": Fundamental frequency.
- " # ": The radiated frequency is out of the restricted band.

CHANNEL	TX Channel 165	DETECTOR FUNCTION	Peak (PK)
FREQUENCY RANGE	1GHz ~ 40GHz		Average (AV)

ANTENNA POLARITY & TEST DISTANCE: HORIZONTAL AT 3 M

NO.	FREQ. (MHz)	EMISSION LEVEL (dBuV/m)	LIMIT (dBuV/m)	MARGIN (dB)	ANTENNA HEIGHT (m)	TABLE ANGLE (Degree)	RAW VALUE (dBuV)	CORRECTION FACTOR (dB/m)
1	#5588.00	60.0 PK	68.2	-8.2	1.51 H	40	57.52	2.52
2	*5825.00	117.2 PK			1.51 H	40	114.26	2.94
3	*5825.00	108.1 AV			1.51 H	40	105.16	2.94
4	#5947.10	61.8 PK	68.2	-6.4	1.51 H	40	58.64	3.14
5	11650.00	59.9 PK	74.0	-14.1	3.67 H	116	46.69	13.21
6	11650.00	47.8 AV	54.0	-6.2	3.67 H	116	34.59	13.21
7	#17475.00	68.0 PK	68.2	-0.2	3.52 H	272	48.57	19.43

ANTENNA POLARITY & TEST DISTANCE: VERTICAL AT 3 M

NO.	FREQ. (MHz)	EMISSION LEVEL (dBuV/m)	LIMIT (dBuV/m)	MARGIN (dB)	ANTENNA HEIGHT (m)	TABLE ANGLE (Degree)	RAW VALUE (dBuV)	CORRECTION FACTOR (dB/m)
1	#5578.50	60.7 PK	68.2	-7.5	2.23 V	269	58.23	2.50
2	*5825.00	117.6 PK			2.23 V	269	114.66	2.94
3	*5825.00	109.4 AV			2.23 V	269	106.46	2.94
4	#5979.88	62.8 PK	68.2	-5.4	2.23 V	269	59.53	3.27
5	11650.00	59.3 PK	74.0	-14.7	2.16 V	295	46.09	13.21
6	11650.00	47.6 AV	54.0	-6.4	2.16 V	295	34.39	13.21
7	#17475.00	65.0 PK	68.2	-3.2	1.94 V	275	45.57	19.43

REMARKS:

1. Emission Level(dBuV/m) = Raw Value(dBuV) + Correction Factor(dB/m)
2. Correction Factor(dB/m) = Antenna Factor(dB/m) + Cable Factor(dB) – Pre-Amplifier Factor(dB)
3. The other emission levels were very low against the limit.
4. Margin value = Emission Level – Limit value
5. " * ": Fundamental frequency.
6. " # ": The radiated frequency is out of the restricted band.

802.11ac (VHT20)

CHANNEL	TX Channel 36	DETECTOR FUNCTION	Peak (PK)
FREQUENCY RANGE	1GHz ~ 40GHz		Average (AV)

ANTENNA POLARITY & TEST DISTANCE: HORIZONTAL AT 3 M								
NO.	FREQ. (MHz)	EMISSION LEVEL (dBuV/m)	LIMIT (dBuV/m)	MARGIN (dB)	ANTENNA HEIGHT (m)	TABLE ANGLE (Degree)	RAW VALUE (dBuV)	CORRECTION FACTOR (dB/m)
1	5150.00	67.0 PK	74.0	-7.0	1.53 H	55	65.43	1.57
2	5150.00	52.6 AV	54.0	-1.4	1.53 H	55	51.03	1.57
3	*5180.00	116.9 PK			1.53 H	55	115.22	1.68
4	*5180.00	108.1 AV			1.53 H	55	106.42	1.68
5	#10360.00	58.8 PK	74.0	-15.2	3.41 H	308	47.08	11.72
6	#10360.00	49.1 AV	54.0	-4.9	3.41 H	308	37.38	11.72
7	15540.00	51.4 PK	74.0	-22.6	3.05 H	242	38.10	13.30
8	15540.00	44.5 AV	54.0	-9.5	3.05 H	242	31.20	13.30

ANTENNA POLARITY & TEST DISTANCE: VERTICAL AT 3 M								
NO.	FREQ. (MHz)	EMISSION LEVEL (dBuV/m)	LIMIT (dBuV/m)	MARGIN (dB)	ANTENNA HEIGHT (m)	TABLE ANGLE (Degree)	RAW VALUE (dBuV)	CORRECTION FACTOR (dB/m)
1	5150.00	67.7 PK	74.0	-6.3	1.46 V	179	66.13	1.57
2	5150.00	53.8 AV	54.0	-0.2	1.46 V	179	52.23	1.57
3	*5180.00	117.5 PK			1.46 V	179	115.82	1.68
4	*5180.00	109.0 AV			1.46 V	179	107.32	1.68
5	#10360.00	62.8 PK	74.0	-11.2	2.24 V	80	51.08	11.72
6	#10360.00	51.1 AV	54.0	-2.9	2.24 V	80	39.38	11.72
7	15540.00	55.5 PK	74.0	-18.5	2.01 V	261	42.20	13.30
8	15540.00	43.8 AV	54.0	-10.2	2.01 V	261	30.50	13.30

REMARKS:

- Emission Level(dBuV/m) = Raw Value(dBuV) + Correction Factor(dB/m)
- Correction Factor(dB/m) = Antenna Factor(dB/m) + Cable Factor(dB) – Pre-Amplifier Factor(dB)
- The other emission levels were very low against the limit.
- Margin value = Emission Level – Limit value
- " * ": Fundamental frequency.
- " # ": The radiated frequency is out of the restricted band.

CHANNEL	TX Channel 40	DETECTOR FUNCTION	Peak (PK)
FREQUENCY RANGE	1GHz ~ 40GHz		Average (AV)

ANTENNA POLARITY & TEST DISTANCE: HORIZONTAL AT 3 M

NO.	FREQ. (MHz)	EMISSION LEVEL (dBuV/m)	LIMIT (dBuV/m)	MARGIN (dB)	ANTENNA HEIGHT (m)	TABLE ANGLE (Degree)	RAW VALUE (dBuV)	CORRECTION FACTOR (dB/m)
1	5150.00	62.5 PK	74.0	-11.5	1.48 H	43	60.93	1.57
2	5150.00	49.9 AV	54.0	-4.1	1.48 H	43	48.33	1.57
3	*5200.00	118.6 PK			1.48 H	43	116.86	1.74
4	*5200.00	109.1 AV			1.48 H	43	107.36	1.74
5	#10400.00	58.8 PK	74.0	-15.2	3.41 H	306	46.88	11.92
6	#10400.00	49.2 AV	54.0	-4.8	3.41 H	306	37.28	11.92
7	15600.00	51.3 PK	74.0	-22.7	3.01 H	256	38.00	13.30
8	15600.00	44.2 AV	54.0	-9.8	3.01 H	256	30.90	13.30

ANTENNA POLARITY & TEST DISTANCE: VERTICAL AT 3 M

NO.	FREQ. (MHz)	EMISSION LEVEL (dBuV/m)	LIMIT (dBuV/m)	MARGIN (dB)	ANTENNA HEIGHT (m)	TABLE ANGLE (Degree)	RAW VALUE (dBuV)	CORRECTION FACTOR (dB/m)
1	5150.00	63.2 PK	74.0	-10.8	2.23 V	176	61.63	1.57
2	5150.00	51.1 AV	54.0	-2.9	2.23 V	176	49.53	1.57
3	*5200.00	119.2 PK			2.23 V	176	117.46	1.74
4	*5200.00	110.0 AV			2.23 V	176	108.26	1.74
5	#10400.00	62.9 PK	74.0	-11.1	2.25 V	79	50.98	11.92
6	#10400.00	51.0 AV	54.0	-3.0	2.25 V	79	39.08	11.92
7	15600.00	55.8 PK	74.0	-18.2	2.03 V	268	42.50	13.30
8	15600.00	44.1 AV	54.0	-9.9	2.03 V	268	30.80	13.30

REMARKS:

1. Emission Level(dBuV/m) = Raw Value(dBuV) + Correction Factor(dB/m)
2. Correction Factor(dB/m) = Antenna Factor(dB/m) + Cable Factor(dB) – Pre-Amplifier Factor(dB)
3. The other emission levels were very low against the limit.
4. Margin value = Emission Level – Limit value
5. " * ": Fundamental frequency.
6. " # ": The radiated frequency is out of the restricted band.

CHANNEL	TX Channel 48	DETECTOR FUNCTION	Peak (PK)
FREQUENCY RANGE	1GHz ~ 40GHz		Average (AV)

ANTENNA POLARITY & TEST DISTANCE: HORIZONTAL AT 3 M

NO.	FREQ. (MHz)	EMISSION LEVEL (dBuV/m)	LIMIT (dBuV/m)	MARGIN (dB)	ANTENNA HEIGHT (m)	TABLE ANGLE (Degree)	RAW VALUE (dBuV)	CORRECTION FACTOR (dB/m)
1	*5240.00	118.9 PK			1.46 H	51	117.05	1.85
2	*5240.00	109.7 AV			1.46 H	51	107.85	1.85
3	5350.00	61.2 PK	74.0	-12.8	1.46 H	51	59.09	2.11
4	5350.00	50.2 AV	54.0	-3.8	1.46 H	51	48.09	2.11
5	#10480.00	59.4 PK	74.0	-14.6	3.39 H	294	47.14	12.26
6	#10480.00	49.7 AV	54.0	-4.3	3.39 H	294	37.44	12.26
7	15720.00	51.9 PK	74.0	-22.1	3.00 H	243	38.72	13.18
8	15720.00	44.7 AV	54.0	-9.3	3.00 H	243	31.52	13.18

ANTENNA POLARITY & TEST DISTANCE: VERTICAL AT 3 M

NO.	FREQ. (MHz)	EMISSION LEVEL (dBuV/m)	LIMIT (dBuV/m)	MARGIN (dB)	ANTENNA HEIGHT (m)	TABLE ANGLE (Degree)	RAW VALUE (dBuV)	CORRECTION FACTOR (dB/m)
1	*5240.00	119.5 PK			2.24 V	171	117.65	1.85
2	*5240.00	110.6 AV			2.24 V	171	108.75	1.85
3	5350.00	61.9 PK	74.0	-12.1	2.24 V	171	59.79	2.11
4	5350.00	51.4 AV	54.0	-2.6	2.24 V	171	49.29	2.11
5	#10480.00	62.5 PK	74.0	-11.5	2.26 V	84	50.24	12.26
6	#10480.00	50.8 AV	54.0	-3.2	2.26 V	84	38.54	12.26
7	15720.00	55.2 PK	74.0	-18.8	2.07 V	278	42.02	13.18
8	15720.00	43.7 AV	54.0	-10.3	2.07 V	278	30.52	13.18

REMARKS:

- Emission Level(dBuV/m) = Raw Value(dBuV) + Correction Factor(dB/m)
- Correction Factor(dB/m) = Antenna Factor(dB/m) + Cable Factor(dB) – Pre-Amplifier Factor(dB)
- The other emission levels were very low against the limit.
- Margin value = Emission Level – Limit value
- " * ": Fundamental frequency.
- " # ": The radiated frequency is out of the restricted band.

CHANNEL	TX Channel 149	DETECTOR FUNCTION	Peak (PK)
FREQUENCY RANGE	1GHz ~ 40GHz		Average (AV)

ANTENNA POLARITY & TEST DISTANCE: HORIZONTAL AT 3 M

NO.	FREQ. (MHz)	EMISSION LEVEL (dBuV/m)	LIMIT (dBuV/m)	MARGIN (dB)	ANTENNA HEIGHT (m)	TABLE ANGLE (Degree)	RAW VALUE (dBuV)	CORRECTION FACTOR (dB/m)
1	#5636.93	60.6 PK	68.2	-7.6	1.65 H	30	58.03	2.61
2	*5745.00	117.1 PK			1.65 H	30	114.28	2.82
3	*5745.00	108.3 AV			1.65 H	30	105.48	2.82
4	#5949.48	60.6 PK	68.2	-7.6	1.65 H	30	57.45	3.14
5	11490.00	56.2 PK	74.0	-17.8	2.09 H	196	42.74	13.46
6	11490.00	46.3 AV	54.0	-7.7	2.09 H	196	32.84	13.46
7	#17235.00	67.6 PK	68.2	-0.6	2.11 H	281	49.15	18.45

ANTENNA POLARITY & TEST DISTANCE: VERTICAL AT 3 M

NO.	FREQ. (MHz)	EMISSION LEVEL (dBuV/m)	LIMIT (dBuV/m)	MARGIN (dB)	ANTENNA HEIGHT (m)	TABLE ANGLE (Degree)	RAW VALUE (dBuV)	CORRECTION FACTOR (dB/m)
1	#5608.90	60.7 PK	68.2	-7.6	2.28 V	192	58.09	2.56
2	*5745.00	116.7 PK			2.28 V	192	113.88	2.82
3	*5745.00	109.2 AV			2.28 V	192	106.38	2.82
4	#5966.10	62.1 PK	68.2	-6.1	2.28 V	192	58.92	3.22
5	11490.00	56.0 PK	74.0	-18.0	2.14 V	297	42.54	13.46
6	11490.00	46.1 AV	54.0	-7.9	2.14 V	297	32.64	13.46
7	#17235.00	64.6 PK	68.2	-3.6	1.94 V	274	46.15	18.45

REMARKS:

1. Emission Level(dBuV/m) = Raw Value(dBuV) + Correction Factor(dB/m)
2. Correction Factor(dB/m) = Antenna Factor(dB/m) + Cable Factor(dB) – Pre-Amplifier Factor(dB)
3. The other emission levels were very low against the limit.
4. Margin value = Emission Level – Limit value
5. " * ": Fundamental frequency.
6. " # ": The radiated frequency is out of the restricted band.

CHANNEL	TX Channel 157	DETECTOR FUNCTION	Peak (PK)
FREQUENCY RANGE	1GHz ~ 40GHz		Average (AV)

ANTENNA POLARITY & TEST DISTANCE: HORIZONTAL AT 3 M

NO.	FREQ. (MHz)	EMISSION LEVEL (dBuV/m)	LIMIT (dBuV/m)	MARGIN (dB)	ANTENNA HEIGHT (m)	TABLE ANGLE (Degree)	RAW VALUE (dBuV)	CORRECTION FACTOR (dB/m)
1	#5604.62	60.7 PK	68.2	-7.5	1.38 H	23	58.15	2.56
2	*5785.00	117.2 PK			1.38 H	23	114.31	2.89
3	*5785.00	108.0 AV			1.38 H	23	105.11	2.89
4	#6022.15	61.3 PK	68.2	-6.9	1.38 H	23	57.92	3.41
5	11570.00	56.4 PK	74.0	-17.6	2.04 H	193	43.16	13.24
6	11570.00	46.7 AV	54.0	-7.3	2.04 H	193	33.46	13.24
7	#17355.00	67.5 PK	68.2	-0.7	2.14 H	281	48.40	19.10

ANTENNA POLARITY & TEST DISTANCE: VERTICAL AT 3 M

NO.	FREQ. (MHz)	EMISSION LEVEL (dBuV/m)	LIMIT (dBuV/m)	MARGIN (dB)	ANTENNA HEIGHT (m)	TABLE ANGLE (Degree)	RAW VALUE (dBuV)	CORRECTION FACTOR (dB/m)
1	#5592.75	60.7 PK	68.2	-7.5	2.25 V	182	58.19	2.52
2	*5785.00	116.4 PK			2.25 V	182	113.51	2.89
3	*5785.00	108.9 AV			2.25 V	182	106.01	2.89
4	#5962.30	61.6 PK	68.2	-6.6	2.25 V	182	58.39	3.21
5	11570.00	56.1 PK	74.0	-17.9	2.09 V	283	42.86	13.24
6	11570.00	46.5 AV	54.0	-7.5	2.09 V	283	33.26	13.24
7	#17355.00	65.0 PK	68.2	-3.2	1.90 V	284	45.90	19.10

REMARKS:

1. Emission Level(dBuV/m) = Raw Value(dBuV) + Correction Factor(dB/m)
2. Correction Factor(dB/m) = Antenna Factor(dB/m) + Cable Factor(dB) – Pre-Amplifier Factor(dB)
3. The other emission levels were very low against the limit.
4. Margin value = Emission Level – Limit value
5. " * ": Fundamental frequency.
6. " # ": The radiated frequency is out of the restricted band.

CHANNEL	TX Channel 165	DETECTOR FUNCTION	Peak (PK)
FREQUENCY RANGE	1GHz ~ 40GHz		Average (AV)

ANTENNA POLARITY & TEST DISTANCE: HORIZONTAL AT 3 M

NO.	FREQ. (MHz)	EMISSION LEVEL (dBuV/m)	LIMIT (dBuV/m)	MARGIN (dB)	ANTENNA HEIGHT (m)	TABLE ANGLE (Degree)	RAW VALUE (dBuV)	CORRECTION FACTOR (dB/m)
1	#5641.20	59.7 PK	68.2	-8.5	1.50 H	23	57.11	2.63
2	*5825.00	116.4 PK			1.50 H	23	113.46	2.94
3	*5825.00	107.6 AV			1.50 H	23	104.66	2.94
4	#5935.70	61.0 PK	68.2	-7.2	1.50 H	23	57.94	3.09
5	11650.00	55.9 PK	74.0	-18.1	2.07 H	208	42.69	13.21
6	11650.00	46.2 AV	54.0	-7.8	2.07 H	208	32.99	13.21
7	#17475.00	67.7 PK	68.2	-0.5	2.06 H	283	48.27	19.43

ANTENNA POLARITY & TEST DISTANCE: VERTICAL AT 3 M

NO.	FREQ. (MHz)	EMISSION LEVEL (dBuV/m)	LIMIT (dBuV/m)	MARGIN (dB)	ANTENNA HEIGHT (m)	TABLE ANGLE (Degree)	RAW VALUE (dBuV)	CORRECTION FACTOR (dB/m)
1	#5585.62	60.6 PK	68.2	-7.6	2.23 V	201	58.10	2.51
2	*5825.00	116.7 PK			2.23 V	201	113.76	2.94
3	*5825.00	109.4 AV			2.23 V	201	106.46	2.94
4	#5970.85	61.1 PK	68.2	-7.1	2.23 V	201	57.87	3.24
5	11650.00	55.6 PK	74.0	-18.4	2.14 V	296	42.39	13.21
6	11650.00	46.1 AV	54.0	-7.9	2.14 V	296	32.89	13.21
7	#17475.00	65.2 PK	68.2	-3.0	1.87 V	280	45.77	19.43

REMARKS:

1. Emission Level(dBuV/m) = Raw Value(dBuV) + Correction Factor(dB/m)
2. Correction Factor(dB/m) = Antenna Factor(dB/m) + Cable Factor(dB) – Pre-Amplifier Factor(dB)
3. The other emission levels were very low against the limit.
4. Margin value = Emission Level – Limit value
5. " * ": Fundamental frequency.
6. " # ": The radiated frequency is out of the restricted band.

802.11ac (VHT40)

CHANNEL	TX Channel 38	DETECTOR FUNCTION	Peak (PK)
FREQUENCY RANGE	1GHz ~ 40GHz		Average (AV)

ANTENNA POLARITY & TEST DISTANCE: HORIZONTAL AT 3 M

NO.	FREQ. (MHz)	EMISSION LEVEL (dBuV/m)	LIMIT (dBuV/m)	MARGIN (dB)	ANTENNA HEIGHT (m)	TABLE ANGLE (Degree)	RAW VALUE (dBuV)	CORRECTION FACTOR (dB/m)
1	5150.00	64.4 PK	74.0	-9.6	1.51 H	32	62.83	1.57
2	5150.00	52.0 AV	54.0	-2.0	1.51 H	32	50.43	1.57
3	*5190.00	109.2 PK			1.51 H	32	107.49	1.71
4	*5190.00	98.9 AV			1.51 H	32	97.19	1.71
5	5350.00	57.6 PK	74.0	-16.4	1.51 H	32	55.49	2.11
6	5350.00	44.7 AV	54.0	-9.3	1.51 H	32	42.59	2.11
7	#10380.00	59.3 PK	74.0	-14.7	3.37 H	292	47.48	11.82
8	#10380.00	49.7 AV	54.0	-4.3	3.37 H	292	37.88	11.82
9	15570.00	52.1 PK	74.0	-21.9	3.02 H	240	38.80	13.30
10	15570.00	44.7 AV	54.0	-9.3	3.02 H	240	31.40	13.30

ANTENNA POLARITY & TEST DISTANCE: VERTICAL AT 3 M

NO.	FREQ. (MHz)	EMISSION LEVEL (dBuV/m)	LIMIT (dBuV/m)	MARGIN (dB)	ANTENNA HEIGHT (m)	TABLE ANGLE (Degree)	RAW VALUE (dBuV)	CORRECTION FACTOR (dB/m)
1	5150.00	65.1 PK	74.0	-8.9	2.03 V	179	63.53	1.57
2	5150.00	53.2 AV	54.0	-0.8	2.03 V	179	51.63	1.57
3	*5190.00	109.8 PK			2.03 V	179	108.09	1.71
4	*5190.00	99.8 AV			2.03 V	179	98.09	1.71
5	5350.00	58.3 PK	74.0	-15.7	2.03 V	179	56.19	2.11
6	5350.00	45.9 AV	54.0	-8.1	2.03 V	179	43.79	2.11
7	#10380.00	62.4 PK	74.0	-11.6	2.24 V	78	50.58	11.82
8	#10380.00	50.8 AV	54.0	-3.2	2.24 V	78	38.98	11.82
9	15570.00	55.4 PK	74.0	-18.6	2.06 V	259	42.10	13.30
10	15570.00	43.7 AV	54.0	-10.3	2.06 V	259	30.40	13.30

REMARKS:

- Emission Level(dBuV/m) = Raw Value(dBuV) + Correction Factor(dB/m)
- Correction Factor(dB/m) = Antenna Factor(dB/m) + Cable Factor(dB) – Pre-Amplifier Factor(dB)
- The other emission levels were very low against the limit.
- Margin value = Emission Level – Limit value
- " * ": Fundamental frequency.
- " # ": The radiated frequency is out of the restricted band.

CHANNEL	TX Channel 46	DETECTOR FUNCTION	Peak (PK)
FREQUENCY RANGE	1GHz ~ 40GHz		Average (AV)

ANTENNA POLARITY & TEST DISTANCE: HORIZONTAL AT 3 M

NO.	FREQ. (MHz)	EMISSION LEVEL (dBuV/m)	LIMIT (dBuV/m)	MARGIN (dB)	ANTENNA HEIGHT (m)	TABLE ANGLE (Degree)	RAW VALUE (dBuV)	CORRECTION FACTOR (dB/m)
1	5150.00	60.0 PK	74.0	-14.0	1.46 H	31	58.43	1.57
2	5150.00	46.2 AV	54.0	-7.8	1.46 H	31	44.63	1.57
3	*5230.00	115.7 PK			1.46 H	31	113.87	1.83
4	*5230.00	105.2 AV			1.46 H	31	103.37	1.83
5	5350.00	59.9 PK	74.0	-14.1	1.46 H	31	57.79	2.11
6	5350.00	48.0 AV	54.0	-6.0	1.46 H	31	45.89	2.11
7	#10460.00	59.3 PK	74.0	-14.7	3.32 H	301	47.12	12.18
8	#10460.00	49.7 AV	54.0	-4.3	3.32 H	301	37.52	12.18
9	15690.00	52.3 PK	74.0	-21.7	3.04 H	247	39.08	13.22
10	15690.00	45.0 AV	54.0	-9.0	3.04 H	247	31.78	13.22

ANTENNA POLARITY & TEST DISTANCE: VERTICAL AT 3 M

NO.	FREQ. (MHz)	EMISSION LEVEL (dBuV/m)	LIMIT (dBuV/m)	MARGIN (dB)	ANTENNA HEIGHT (m)	TABLE ANGLE (Degree)	RAW VALUE (dBuV)	CORRECTION FACTOR (dB/m)
1	5150.00	60.7 PK	74.0	-13.3	2.16 V	180	59.13	1.57
2	5150.00	47.4 AV	54.0	-6.6	2.16 V	180	45.83	1.57
3	*5230.00	116.3 PK			2.16 V	180	114.47	1.83
4	*5230.00	106.1 AV			2.16 V	180	104.27	1.83
5	5350.00	60.6 PK	74.0	-13.4	2.16 V	180	58.49	2.11
6	5350.00	49.2 AV	54.0	-4.8	2.16 V	180	47.09	2.11
7	#10460.00	62.2 PK	74.0	-11.8	2.26 V	69	50.02	12.18
8	#10460.00	50.3 AV	54.0	-3.7	2.26 V	69	38.12	12.18
9	15690.00	54.7 PK	74.0	-19.3	2.11 V	253	41.48	13.22
10	15690.00	43.3 AV	54.0	-10.7	2.11 V	253	30.08	13.22

REMARKS:

- Emission Level(dBuV/m) = Raw Value(dBuV) + Correction Factor(dB/m)
- Correction Factor(dB/m) = Antenna Factor(dB/m) + Cable Factor(dB) – Pre-Amplifier Factor(dB)
- The other emission levels were very low against the limit.
- Margin value = Emission Level – Limit value
- " * ": Fundamental frequency.
- " # ": The radiated frequency is out of the restricted band.

CHANNEL	TX Channel 151	DETECTOR FUNCTION	Peak (PK)
FREQUENCY RANGE	1GHz ~ 40GHz		Average (AV)

ANTENNA POLARITY & TEST DISTANCE: HORIZONTAL AT 3 M

NO.	FREQ. (MHz)	EMISSION LEVEL (dBuV/m)	LIMIT (dBuV/m)	MARGIN (dB)	ANTENNA HEIGHT (m)	TABLE ANGLE (Degree)	RAW VALUE (dBuV)	CORRECTION FACTOR (dB/m)
1	#5610.80	60.5 PK	68.2	-7.8	1.24 H	24	57.89	2.56
2	*5755.00	114.9 PK			1.24 H	24	112.06	2.84
3	*5755.00	105.9 AV			1.24 H	24	103.06	2.84
4	#5935.70	61.1 PK	68.2	-7.1	1.24 H	24	58.03	3.09
5	11510.00	56.3 PK	74.0	-17.7	2.03 H	187	42.87	13.43
6	11510.00	46.8 AV	54.0	-7.2	2.03 H	187	33.37	13.43
7	#17265.00	64.2 PK	74.0	-9.8	2.12 H	278	45.64	18.56
8	#17265.00	53.0 AV	54.0	-1.0	2.12 H	278	34.44	18.56

ANTENNA POLARITY & TEST DISTANCE: VERTICAL AT 3 M

NO.	FREQ. (MHz)	EMISSION LEVEL (dBuV/m)	LIMIT (dBuV/m)	MARGIN (dB)	ANTENNA HEIGHT (m)	TABLE ANGLE (Degree)	RAW VALUE (dBuV)	CORRECTION FACTOR (dB/m)
1	#5610.32	62.2 PK	68.2	-6.0	2.08 V	169	59.64	2.56
2	*5755.00	116.2 PK			2.08 V	169	113.36	2.84
3	*5755.00	105.8 AV			2.08 V	169	102.96	2.84
4	#5984.62	61.9 PK	68.2	-6.4	2.08 V	169	58.56	3.29
5	11510.00	56.1 PK	74.0	-17.9	2.19 V	303	42.67	13.43
6	11510.00	46.4 AV	54.0	-7.6	2.19 V	303	32.97	13.43
7	#17265.00	61.2 PK	74.0	-12.8	1.90 V	268	42.64	18.56
8	#17265.00	51.8 AV	54.0	-2.2	1.90 V	268	33.24	18.56

REMARKS:

1. Emission Level(dBuV/m) = Raw Value(dBuV) + Correction Factor(dB/m)
2. Correction Factor(dB/m) = Antenna Factor(dB/m) + Cable Factor(dB) – Pre-Amplifier Factor(dB)
3. The other emission levels were very low against the limit.
4. Margin value = Emission Level – Limit value
5. " * ": Fundamental frequency.
6. " # ": The radiated frequency is out of the restricted band.

CHANNEL	TX Channel 159	DETECTOR FUNCTION	Peak (PK)
FREQUENCY RANGE	1GHz ~ 40GHz		Average (AV)

ANTENNA POLARITY & TEST DISTANCE: HORIZONTAL AT 3 M

NO.	FREQ. (MHz)	EMISSION LEVEL (dBuV/m)	LIMIT (dBuV/m)	MARGIN (dB)	ANTENNA HEIGHT (m)	TABLE ANGLE (Degree)	RAW VALUE (dBuV)	CORRECTION FACTOR (dB/m)
1	#5577.07	60.6 PK	68.2	-7.6	1.25 H	22	58.08	2.48
2	*5795.00	114.5 PK			1.25 H	22	111.58	2.92
3	*5795.00	105.6 AV			1.25 H	22	102.68	2.92
4	#5946.15	61.4 PK	68.2	-6.8	1.25 H	22	58.25	3.14
5	11590.00	56.5 PK	74.0	-17.5	2.07 H	180	43.32	13.18
6	11590.00	47.2 AV	54.0	-6.8	2.07 H	180	34.02	13.18
7	#17385.00	64.3 PK	74.0	-9.7	2.13 H	282	44.98	19.32
8	#17385.00	52.9 AV	54.0	-1.1	2.13 H	282	33.58	19.32

ANTENNA POLARITY & TEST DISTANCE: VERTICAL AT 3 M

NO.	FREQ. (MHz)	EMISSION LEVEL (dBuV/m)	LIMIT (dBuV/m)	MARGIN (dB)	ANTENNA HEIGHT (m)	TABLE ANGLE (Degree)	RAW VALUE (dBuV)	CORRECTION FACTOR (dB/m)
1	#5599.40	62.1 PK	68.2	-6.1	2.24 V	172	59.55	2.54
2	*5795.00	116.0 PK			2.24 V	172	113.08	2.92
3	*5795.00	105.8 AV			2.24 V	172	102.88	2.92
4	#5981.77	62.6 PK	68.2	-5.6	2.24 V	172	59.31	3.28
5	11590.00	56.2 PK	74.0	-17.8	2.24 V	302	43.02	13.18
6	11590.00	47.0 AV	54.0	-7.0	2.24 V	302	33.82	13.18
7	#17385.00	60.8 PK	74.0	-13.2	1.86 V	258	41.48	19.32
8	#17385.00	51.3 AV	54.0	-2.7	1.86 V	258	31.98	19.32

REMARKS:

1. Emission Level(dBuV/m) = Raw Value(dBuV) + Correction Factor(dB/m)
2. Correction Factor(dB/m) = Antenna Factor(dB/m) + Cable Factor(dB) – Pre-Amplifier Factor(dB)
3. The other emission levels were very low against the limit.
4. Margin value = Emission Level – Limit value
5. " * ": Fundamental frequency.
6. " # ": The radiated frequency is out of the restricted band.

802.11ac (VHT80)

CHANNEL	TX Channel 42	DETECTOR FUNCTION	Peak (PK)
FREQUENCY RANGE	1GHz ~ 40GHz		Average (AV)

ANTENNA POLARITY & TEST DISTANCE: HORIZONTAL AT 3 M

NO.	FREQ. (MHz)	EMISSION LEVEL (dBuV/m)	LIMIT (dBuV/m)	MARGIN (dB)	ANTENNA HEIGHT (m)	TABLE ANGLE (Degree)	RAW VALUE (dBuV)	CORRECTION FACTOR (dB/m)
1	5150.00	67.0 PK	74.0	-7.0	1.27 H	37	65.43	1.57
2	5150.00	52.6 AV	54.0	-1.4	1.27 H	37	51.03	1.57
3	*5210.00	117.6 PK			1.27 H	37	115.83	1.77
4	*5210.00	97.2 AV			1.27 H	37	95.43	1.77
5	5350.00	57.4 PK	74.0	-16.6	1.27 H	37	55.29	2.11
6	5350.00	44.5 AV	54.0	-9.5	1.27 H	37	42.39	2.11
7	#10420.00	58.7 PK	74.0	-15.3	3.32 H	315	46.69	12.01
8	#10420.00	49.3 AV	54.0	-4.7	3.32 H	315	37.29	12.01
9	15630.00	52.7 PK	74.0	-21.3	3.09 H	260	39.43	13.27
10	15630.00	45.4 AV	54.0	-8.6	3.09 H	260	32.13	13.27

ANTENNA POLARITY & TEST DISTANCE: VERTICAL AT 3 M

NO.	FREQ. (MHz)	EMISSION LEVEL (dBuV/m)	LIMIT (dBuV/m)	MARGIN (dB)	ANTENNA HEIGHT (m)	TABLE ANGLE (Degree)	RAW VALUE (dBuV)	CORRECTION FACTOR (dB/m)
1	5150.00	67.7 PK	74.0	-6.3	2.25 V	189	66.13	1.57
2	5150.00	53.8 AV	54.0	-0.2	2.25 V	189	52.23	1.57
3	*5210.00	118.2 PK			2.25 V	189	116.43	1.77
4	*5210.00	98.1 AV			2.25 V	189	96.33	1.77
5	5350.00	58.1 PK	74.0	-15.9	2.25 V	189	55.99	2.11
6	5350.00	45.7 AV	54.0	-8.3	2.25 V	189	43.59	2.11
7	#10420.00	62.5 PK	74.0	-11.5	2.21 V	64	50.49	12.01
8	#10420.00	50.7 AV	54.0	-3.3	2.21 V	64	38.69	12.01
9	15630.00	54.9 PK	74.0	-19.1	2.12 V	250	41.63	13.27
10	15630.00	43.6 AV	54.0	-10.4	2.12 V	250	30.33	13.27

REMARKS:

- Emission Level(dBuV/m) = Raw Value(dBuV) + Correction Factor(dB/m)
- Correction Factor(dB/m) = Antenna Factor(dB/m) + Cable Factor(dB) – Pre-Amplifier Factor(dB)
- The other emission levels were very low against the limit.
- Margin value = Emission Level – Limit value
- " * ": Fundamental frequency.
- " # ": The radiated frequency is out of the restricted band.

CHANNEL	TX Channel 155	DETECTOR FUNCTION	Peak (PK)
FREQUENCY RANGE	1GHz ~ 40GHz		Average (AV)

ANTENNA POLARITY & TEST DISTANCE: HORIZONTAL AT 3 M

NO.	FREQ. (MHz)	EMISSION LEVEL (dBuV/m)	LIMIT (dBuV/m)	MARGIN (dB)	ANTENNA HEIGHT (m)	TABLE ANGLE (Degree)	RAW VALUE (dBuV)	CORRECTION FACTOR (dB/m)
1	#5631.23	62.3 PK	68.2	-5.9	1.24 H	24	59.72	2.61
2	*5775.00	112.8 PK			1.24 H	24	109.92	2.88
3	*5775.00	103.4 AV			1.24 H	24	100.52	2.88
4	#5990.80	61.8 PK	68.2	-6.4	1.24 H	24	58.49	3.32
5	11550.00	56.7 PK	74.0	-17.3	2.09 H	174	43.40	13.30
6	11550.00	47.4 AV	54.0	-6.6	2.09 H	174	34.10	13.30
7	#17325.00	63.9 PK	74.0	-10.1	2.10 H	286	45.02	18.88
8	#17325.00	52.2 AV	54.0	-1.8	2.10 H	286	33.32	18.88

ANTENNA POLARITY & TEST DISTANCE: VERTICAL AT 3 M

NO.	FREQ. (MHz)	EMISSION LEVEL (dBuV/m)	LIMIT (dBuV/m)	MARGIN (dB)	ANTENNA HEIGHT (m)	TABLE ANGLE (Degree)	RAW VALUE (dBuV)	CORRECTION FACTOR (dB/m)
1	#5601.30	63.4 PK	68.2	-4.8	2.15 V	216	60.81	2.55
2	*5775.00	114.6 PK			2.15 V	216	111.72	2.88
3	*5775.00	104.8 AV			2.15 V	216	101.92	2.88
4	#5928.10	63.5 PK	68.2	-4.7	2.15 V	216	60.46	3.06
5	11550.00	56.0 PK	74.0	-18.0	2.24 V	292	42.70	13.30
6	11550.00	46.3 AV	54.0	-7.7	2.24 V	292	33.00	13.30
7	#17325.00	61.0 PK	74.0	-13.0	1.93 V	278	42.12	18.88
8	#17325.00	51.3 AV	54.0	-2.7	1.93 V	278	32.42	18.88

REMARKS:

1. Emission Level(dBuV/m) = Raw Value(dBuV) + Correction Factor(dB/m)
2. Correction Factor(dB/m) = Antenna Factor(dB/m) + Cable Factor(dB) – Pre-Amplifier Factor(dB)
3. The other emission levels were very low against the limit.
4. Margin value = Emission Level – Limit value
5. " * ": Fundamental frequency.
6. " # ": The radiated frequency is out of the restricted band.

Below 1GHz Data:

802.11ac (VHT20)

CHANNEL	TX Channel 157	DETECTOR FUNCTION	Quasi-Peak (QP)
FREQUENCY RANGE	9kHz ~ 1GHz		

ANTENNA POLARITY & TEST DISTANCE: HORIZONTAL AT 3 M								
NO.	FREQ. (MHz)	EMISSION LEVEL (dBuV/m)	LIMIT (dBuV/m)	MARGIN (dB)	ANTENNA HEIGHT (m)	TABLE ANGLE (Degree)	RAW VALUE (dBuV)	CORRECTION FACTOR (dB/m)
1	36.21	30.9 QP	40.0	-9.1	3.00 H	82	40.2	-9.3
2	125.01	32.1 QP	43.5	-11.4	1.50 H	68	41.7	-9.6
3	224.02	36.6 QP	46.0	-9.4	1.50 H	286	48.3	-11.7
4	499.99	29.2 QP	46.0	-16.8	1.50 H	142	32.0	-2.8
5	574.99	30.6 QP	46.0	-15.4	1.50 H	124	31.9	-1.3
6	725.00	37.8 QP	46.0	-8.2	2.00 H	105	36.6	1.2

REMARKS:

1. Emission Level(dBuV/m) = Raw Value(dBuV) + Correction Factor(dB/m)
2. Correction Factor(dB/m) = Antenna Factor(dB/m) + Cable Factor(dB) – Pre-Amplifier Factor(dB)
3. The other emission levels were very low against the limit.
4. Margin value = Emission Level – Limit value

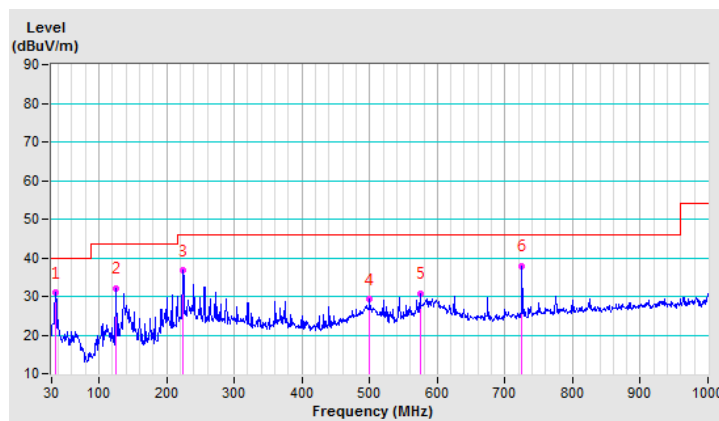

CHANNEL	TX Channel 157	DETECTOR FUNCTION	Quasi-Peak (QP)
FREQUENCY RANGE	9kHz ~ 1GHz		

ANTENNA POLARITY & TEST DISTANCE: VERTICAL AT 3 M

NO.	FREQ. (MHz)	EMISSION LEVEL (dBuV/m)	LIMIT (dBuV/m)	MARGIN (dB)	ANTENNA HEIGHT (m)	TABLE ANGLE (Degree)	RAW VALUE (dBuV)	CORRECTION FACTOR (dB/m)
1	48.87	34.7 QP	40.0	-5.3	2.00 V	360	42.5	-7.8
2	137.94	31.3 QP	43.5	-12.2	1.00 V	166	39.5	-8.2
3	224.02	30.5 QP	46.0	-15.5	1.00 V	213	42.2	-11.7
4	520.00	33.5 QP	46.0	-12.5	1.00 V	193	35.8	-2.3
5	574.99	34.3 QP	46.0	-11.7	1.00 V	78	35.6	-1.3
6	725.00	36.3 QP	46.0	-9.7	1.00 V	338	35.1	1.2

REMARKS:

1. Emission Level(dBuV/m) = Raw Value(dBuV) + Correction Factor(dB/m)
2. Correction Factor(dB/m) = Antenna Factor(dB/m) + Cable Factor(dB) – Pre-Amplifier Factor(dB)
3. The other emission levels were very low against the limit.
4. Margin value = Emission Level – Limit value

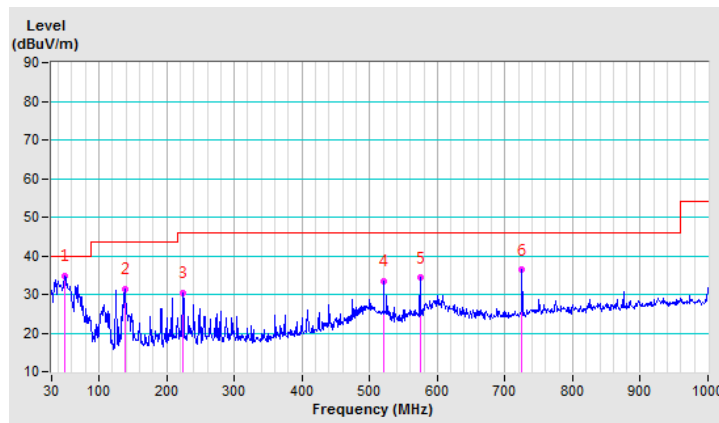

4.2 Conducted Emission Measurement

4.2.1 Limits of Conducted Emission Measurement

Frequency (MHz)	Conducted Limit (dBuV)	
	Quasi-peak	Average
0.15 - 0.5	66 - 56	56 - 46
0.50 - 5.0	56	46
5.0 - 30.0	60	50

Note: 1. The lower limit shall apply at the transition frequencies.

2. The limit decreases in line with the logarithm of the frequency in the range of 0.15 to 0.50MHz.

4.2.2 Test Instruments

DESCRIPTION & MANUFACTURER	MODEL NO.	SERIAL NO.	CALIBRATED DATE	CALIBRATED UNTIL
Test Receiver R&S	ESCS 30	847124/029	Oct. 24, 2016	Oct. 23, 2017
Line-Impedance Stabilization Network (for EUT) R&S	ESH3-Z5	848773/004	Oct. 26, 2016	Oct. 25, 2017
Line-Impedance Stabilization Network (for Peripheral) R&S	ENV216	100072	June 03, 2017	June 02, 2018
50 ohms Terminator	N/A	EMC-02	Sep. 29, 2016	Sep. 28, 2017
RF Cable	5D-FB	COCCAB-001	Sep. 30, 2016	Sep. 29, 2017
10 dB PAD Mini-Circuits	HAT-10+	CONATT-004	June 18, 2017	June 17, 2018
Software BVADT	BVADT_Cond_ V7.3.7.4	NA	NA	NA

Note:

1. The calibration interval of the above test instruments are 12 months and the calibrations are traceable to NML/ROC and NIST/USA.
2. The test was performed in Shielded Room No. 1.
3. Tested Date: Aug. 10, 2017

4.2.3 Test Procedure

- The EUT was placed 0.4 meters from the conducting wall of the shielded room with EUT being connected to the power mains through a line impedance stabilization network (LISN). Other support units were connected to the power mains through another LISN. The two LISNs provide 50 ohm/ 50uH of coupling impedance for the measuring instrument.
- Both lines of the power mains connected to the EUT were checked for maximum conducted interference.
- The frequency range from 150kHz to 30MHz was searched. Emission levels under (Limit - 20dB) was not recorded.

NOTE: All modes of operation were investigated and the worst-case emissions are reported.

4.2.4 Deviation from Test Standard

No deviation.

4.2.5 Test Setup

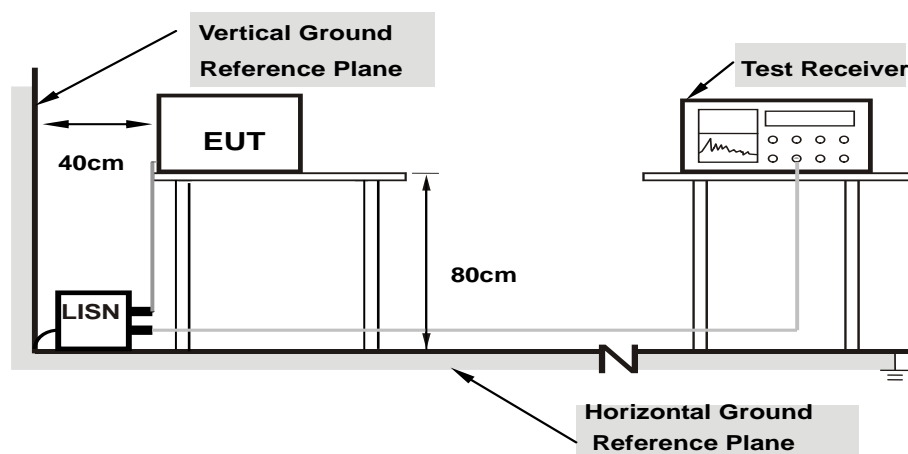

Note: 1.Support units were connected to second LISN.

For the actual test configuration, please refer to the attached file (Test Setup Photo).

4.2.6 EUT Operating Condition

Same as 4.1.6.

4.2.7 Test Results

Phase	Line (L)	Detector Function	Quasi-Peak (QP) / Average (AV)
-------	----------	-------------------	--------------------------------

No	Freq. [MHz]	Corr.	Reading Value		Emission Level		Limit		Margin	
		Factor (dB)	[dB (uV)]		[dB (uV)]		[dB (uV)]		(dB)	
		Q.P.	AV.	Q.P.	AV.	Q.P.	AV.	Q.P.	AV.	
1	0.16562	10.08	35.88	24.13	45.96	34.21	65.18	55.18	-19.22	-20.97
2	0.24766	10.08	40.89	35.80	50.97	45.88	61.84	51.84	-10.87	-5.96
3	0.94688	10.16	24.91	21.00	35.07	31.16	56.00	46.00	-20.93	-14.84
4	1.30078	10.16	25.12	20.97	35.28	31.13	56.00	46.00	-20.72	-14.87
5	3.92969	10.36	19.39	14.24	29.75	24.60	56.00	46.00	-26.25	-21.40
6	11.90625	10.94	12.55	7.17	23.49	18.11	60.00	50.00	-36.51	-31.89

REMARKS:

1. Q.P. and AV. are abbreviations of quasi-peak and average individually.
2. The emission levels of other frequencies were very low against the limit.
3. Margin value = Emission level - Limit value
4. Correction factor = Insertion loss + Cable loss
5. Emission Level = Correction Factor + Reading Value

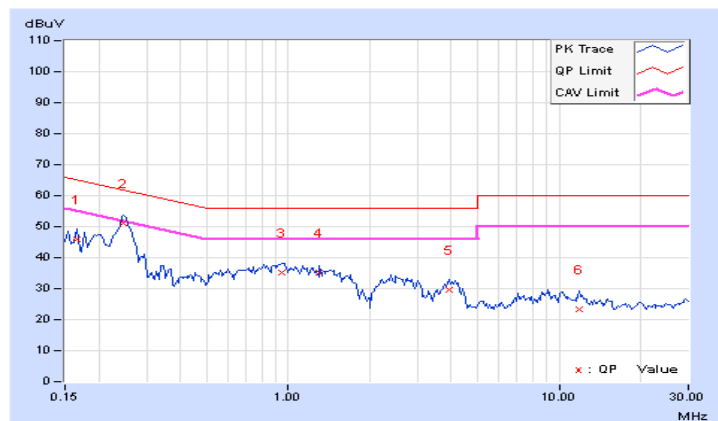

Phase	Neutral (N)	Detector Function	Quasi-Peak (QP) / Average (AV)
-------	-------------	-------------------	--------------------------------

No	Freq. [MHz]	Corr.	Reading Value		Emission Level		Limit		Margin	
		Factor	[dB (uV)]		[dB (uV)]		[dB (uV)]		(dB)	
		(dB)	Q.P.	AV.	Q.P.	AV.	Q.P.	AV.	Q.P.	AV.
1	0.16953	10.06	35.74	25.39	45.80	35.45	64.98	54.98	-19.18	-19.53
2	0.25156	10.06	41.03	35.58	51.09	45.64	61.71	51.71	-10.62	-6.07
3	1.05469	10.12	25.69	21.72	35.81	31.84	56.00	46.00	-20.19	-14.16
4	2.49219	10.22	21.88	16.87	32.10	27.09	56.00	46.00	-23.90	-18.91
5	4.07031	10.28	19.31	14.24	29.59	24.52	56.00	46.00	-26.41	-21.48
6	8.97266	10.63	14.60	9.57	25.23	20.20	60.00	50.00	-34.77	-29.80

REMARKS:

1. Q.P. and AV. are abbreviations of quasi-peak and average individually.
2. The emission levels of other frequencies were very low against the limit.
3. Margin value = Emission level - Limit value
4. Correction factor = Insertion loss + Cable loss
5. Emission Level = Correction Factor + Reading Value

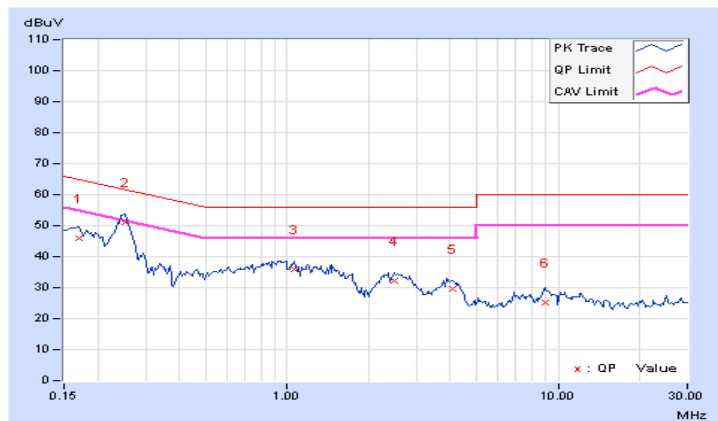

4.3 Transmit Power Measurement

4.3.1 Limits of Transmit Power Measurement

Operation Band	EUT Category		Limit
U-NII-1		Outdoor Access Point	1 Watt (30 dBm) (Max. e.i.r.p \leq 125mW(21 dBm) at any elevation angle above 30 degrees as measured from the horizon)
		Fixed point-to-point Access Point	1 Watt (30 dBm)
	√	Indoor Access Point	1 Watt (30 dBm)
	√	Mobile and Portable client device	250mW (24 dBm)
U-NII-2A			250mW (24 dBm) or 11 dBm+10 log B*
U-NII-2C			250mW (24 dBm) or 11 dBm+10 log B*
U-NII-3		√	1 Watt (30 dBm)

*B is the 26 dB emission bandwidth in megahertz

Per KDB 662911 Method of conducted output power measurement on IEEE 802.11 devices,

Array Gain = 0 dB (i.e., no array gain) for $N_{ANT} \leq 4$;

Array Gain = 0 dB (i.e., no array gain) for channel widths ≥ 40 MHz for any N_{ANT} ;

Array Gain = $5 \log(N_{ANT}/N_{SS})$ dB or 3 dB, whichever is less for 20-MHz channel widths with $N_{ANT} \geq 5$.

For power measurements on all other devices: Array Gain = $10 \log(N_{ANT}/N_{SS})$ dB.

4.3.2 Test Setup

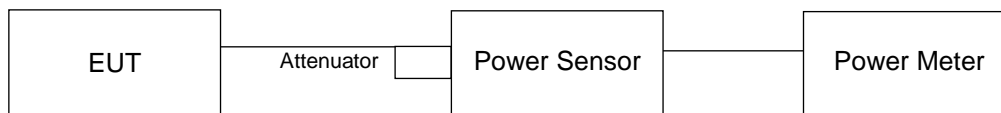

4.3.3 Test Instruments

Refer to section 4.1.2 to get information of above instrument.

4.3.4 Test Procedure

Method PM is used to perform output power measurement, trigger and gating function of wide band power meter is enabled to measure max output power of TX on burst. Duty factor is not added to measured value.

4.3.5 Deviation from Test Standard

No deviation.

4.3.6 EUT Operating Condition

The software provided by client to enable the EUT under transmission condition continuously at lowest, middle and highest channel frequencies individually.

4.3.7 Test Result

Master

CDD Mode

802.11a

Chan.	Chan. Freq. (MHz)	Maximum Conducted Power (dBm)				Total Power (mW)	Total Power (dBm)	Limit (dBm)	Pass / Fail
		Chain 0	Chain 1	Chain 2	Chain 3				
36	5180	21.52	21.10	21.02	21.13	526.923	27.22	29.17	Pass
40	5200	22.88	22.76	22.88	22.80	767.523	28.85	29.2	Pass
48	5240	22.75	22.36	22.65	22.61	727.019	28.62	29.81	Pass
149	5745	22.96	22.65	22.75	22.93	766.475	28.84	29.39	Pass
157	5785	22.91	22.69	22.64	22.49	742.287	28.71	29.62	Pass
165	5825	22.79	22.73	22.69	22.59	744.939	28.72	29.73	Pass

- Note:**
1. For CH36 : The directional gain is 6.83dBi > 6dBi , so the power limit shall be reduced to $30-(6.83-6) = 29.17\text{dBm}$.
 2. For CH40 : The directional gain is 6.8dBi > 6dBi , so the power limit shall be reduced to $30-(6.8-6) = 29.2\text{dBm}$.
 3. For CH48 : The directional gain is 6.19dBi > 6dBi , so the power limit shall be reduced to $30-(6.19-6) = 29.81\text{dBm}$.
 4. For CH149 : The directional gain is 6.61dBi > 6dBi , so the power limit shall be reduced to $30-(6.61-6) = 29.39\text{dBm}$.
 5. For CH157 : The directional gain is 6.38dBi > 6dBi , so the power limit shall be reduced to $30-(6.38-6) = 29.62\text{dBm}$.
 6. For CH165 : The directional gain is 6.27dBi > 6dBi , so the power limit shall be reduced to $30-(6.27-6) = 29.73\text{dBm}$.

CDD Mode / Beamforming Mode (Nss=1)
802.11ac (VHT20)

Chan.	Chan. Freq. (MHz)	Maximum Conducted Power (dBm)				Total Power (mW)	Total Power (dBm)	Limit (dBm)	Pass / Fail
		Chain 0	Chain 1	Chain 2	Chain 3				
36	5180	21.18	21.17	21.22	21.25	527.924	27.23	29.17	Pass
40	5200	22.69	22.31	22.69	23.10	745.95	28.73	29.2	Pass
48	5240	22.77	22.61	22.57	22.48	729.352	28.63	29.81	Pass
149	5745	22.72	22.64	22.57	23.04	752.811	28.77	29.39	Pass
157	5785	22.93	23.01	22.86	23.07	792.287	28.99	29.62	Pass
165	5825	22.26	22.57	22.58	22.61	712.508	28.53	29.73	Pass

- Note:**
1. For CH36 : The directional gain is 6.83dBi > 6dBi , so the power limit shall be reduced to $30-(6.83-6) = 29.17\text{dBm}$.
 2. For CH40 : The directional gain is 6.8dBi > 6dBi , so the power limit shall be reduced to $30-(6.8-6) = 29.2\text{dBm}$.
 3. For CH48 : The directional gain is 6.19dBi > 6dBi , so the power limit shall be reduced to $30-(6.19-6) = 29.81\text{dBm}$.
 4. For CH149 : The directional gain is 6.61dBi > 6dBi , so the power limit shall be reduced to $30-(6.61-6) = 29.39\text{dBm}$.
 5. For CH157 : The directional gain is 6.38dBi > 6dBi , so the power limit shall be reduced to $30-(6.38-6) = 29.62\text{dBm}$.
 6. For CH165 : The directional gain is 6.27dBi > 6dBi , so the power limit shall be reduced to $30-(6.27-6) = 29.73\text{dBm}$.

802.11ac (VHT40)

Chan.	Chan. Freq. (MHz)	Maximum Conducted Power (dBm)				Total Power (mW)	Total Power (dBm)	Limit (dBm)	Pass / Fail
		Chain 0	Chain 1	Chain 2	Chain 3				
38	5190	18.07	18.16	18.04	18.12	258.128	24.12	29.35	Pass
46	5230	22.61	22.64	22.84	23.24	769.216	28.86	29.59	Pass
151	5755	22.63	22.61	22.19	22.38	704.18	28.48	29.60	Pass
159	5795	22.14	22.16	22.45	22.36	676.098	28.30	29.50	Pass

- Note:**
1. For CH38 : The directional gain is 6.65dBi > 6dBi , so the power limit shall be reduced to $30-(6.65-6) = 29.35\text{dBm}$.
 2. For CH46 : The directional gain is 6.41dBi > 6dBi , so the power limit shall be reduced to $30-(6.41-6) = 29.59\text{dBm}$.
 3. For CH151 : The directional gain is 6.4dBi > 6dBi , so the power limit shall be reduced to $30-(6.4-6) = 29.6\text{dBm}$.
 4. For CH159 : The directional gain is 6.5dBi > 6dBi , so the power limit shall be reduced to $30-(6.5-6) = 29.5\text{dBm}$.

802.11ac (VHT80)

Chan.	Chan. Freq. (MHz)	Maximum Conducted Power (dBm)				Total Power (mW)	Total Power (dBm)	Limit (dBm)	Pass / Fail
		Chain 0	Chain 1	Chain 2	Chain 3				
42	5210	18.05	18.09	18.15	18.07	257.677	24.11	29.19	Pass
155	5775	22.42	22.67	22.38	22.26	700.758	28.46	29.99	Pass

- Note:**
1. For CH42 : The directional gain is 6.81dBi > 6dBi , so the power limit shall be reduced to $30-(6.81-6) = 29.19\text{dBm}$.
 2. For CH155 : The directional gain is 6.01dBi > 6dBi , so the power limit shall be reduced to $30-(6.01-6) = 29.99\text{dBm}$.

Master - Beamforming Mode (Nss=2)

802.11ac (VHT20)

Chan.	Chan. Freq. (MHz)	Maximum Conducted Power (dBm)				Total Power (mW)	Total Power (dBm)	Limit (dBm)	Pass / Fail
		Chain 0	Chain 1	Chain 2	Chain 3				
36	5180	21.18	21.17	21.22	21.25	527.924	27.23	30.00	Pass
40	5200	22.69	22.31	22.69	23.10	745.95	28.73	30.00	Pass
48	5240	22.77	22.61	22.57	22.48	729.352	28.63	30.00	Pass
149	5745	22.72	22.64	22.57	23.04	752.811	28.77	30.00	Pass
157	5785	22.93	23.01	22.86	23.07	792.287	28.99	30.00	Pass
165	5825	22.26	22.57	22.58	22.61	712.508	28.53	30.00	Pass

- Note:**
1. For CH36: The directional gain is 3.82dBi < 6dBi , so the power limit shall not be reduced.
 2. For CH40: The directional gain is 3.79dBi < 6dBi , so the power limit shall not be reduced.
 3. For CH48: The directional gain is 3.18dBi < 6dBi , so the power limit shall not be reduced.
 4. For CH149: The directional gain is 3.6dBi < 6dBi , so the power limit shall not be reduced.
 5. For CH157: The directional gain is 3.37dBi < 6dBi , so the power limit shall not be reduced.
 6. For CH165: The directional gain is 3.26dBi < 6dBi , so the power limit shall not be reduced.

802.11ac (VHT40)

Chan.	Chan. Freq. (MHz)	Maximum Conducted Power (dBm)				Total Power (mW)	Total Power (dBm)	Limit (dBm)	Pass / Fail
		Chain 0	Chain 1	Chain 2	Chain 3				
38	5190	18.07	18.16	18.04	18.12	258.128	24.12	30.00	Pass
46	5230	22.61	22.64	22.84	23.24	769.216	28.86	30.00	Pass
151	5755	22.63	22.61	22.19	22.38	704.18	28.48	30.00	Pass
159	5795	22.14	22.16	22.45	22.36	676.098	28.30	30.00	Pass

- Note:**
1. For CH38: The directional gain is 3.64dBi < 6dBi , so the power limit shall not be reduced.
 2. For CH46: The directional gain is 3.4dBi < 6dBi , so the power limit shall not be reduced.
 3. For CH151: The directional gain is 3.39dBi < 6dBi , so the power limit shall not be reduced.
 4. For CH159: The directional gain is 3.49dBi < 6dBi , so the power limit shall not be reduced.

802.11ac (VHT80)

Chan.	Chan. Freq. (MHz)	Maximum Conducted Power (dBm)				Total Power (mW)	Total Power (dBm)	Limit (dBm)	Pass / Fail
		Chain 0	Chain 1	Chain 2	Chain 3				
42	5210	18.05	18.09	18.15	18.07	257.677	24.11	30.00	Pass
155	5775	22.42	22.67	22.38	22.26	700.758	28.46	30.00	Pass

- Note:** 1. For CH42: The directional gain is 3.8dBi < 6dBi , so the power limit shall not be reduced.
 2. For CH155: The directional gain is 3.0dBi < 6dBi , so the power limit shall not be reduced.

Client - CDD Mode / Beamforming Mode (Nss=1)
802.11a

Chan.	Chan. Freq. (MHz)	Maximum Conducted Power (dBm)				Total Power (mW)	Total Power (dBm)	Limit (dBm)	Pass / Fail
		Chain 0	Chain 1	Chain 2	Chain 3				
36	5180	17.12	17.20	16.98	17.23	206.737	23.15	23.17	Pass
40	5200	17.06	17.16	17.00	17.20	205.416	23.13	23.2	Pass
48	5240	17.10	17.15	16.92	17.31	206.197	23.14	23.81	Pass

- Note:**
1. For CH36 : The directional gain is 6.83dBi > 6dBi , so the power limit shall be reduced to $24-(6.83-6) = 23.17\text{dBm}$.
 2. For CH40 : The directional gain is 6.8dBi > 6dBi , so the power limit shall be reduced to $24-(6.8-6) = 23.2\text{dBm}$.
 3. For CH48 : The directional gain is 6.19dBi > 6dBi , so the power limit shall be reduced to $24-(6.19-6) = 23.81\text{dBm}$.

802.11ac (VHT20)

Chan.	Chan. Freq. (MHz)	Maximum Conducted Power (dBm)				Total Power (mW)	Total Power (dBm)	Limit (dBm)	Pass / Fail
		Chain 0	Chain 1	Chain 2	Chain 3				
36	5180	17.10	17.19	17.00	17.21	206.367	23.15	23.17	Pass
40	5200	17.21	17.17	16.82	17.16	204.805	23.11	23.2	Pass
48	5240	17.18	17.20	17.00	17.06	205.656	23.13	23.81	Pass

- Note:**
1. For CH36 : The directional gain is 6.83dBi > 6dBi , so the power limit shall be reduced to $24-(6.83-6) = 23.17\text{dBm}$.
 2. For CH40 : The directional gain is 6.8dBi > 6dBi , so the power limit shall be reduced to $24-(6.8-6) = 23.2\text{dBm}$.
 3. For CH48 : The directional gain is 6.19dBi > 6dBi , so the power limit shall be reduced to $24-(6.19-6) = 23.81\text{dBm}$.

802.11ac (VHT40)

Chan.	Chan. Freq. (MHz)	Maximum Conducted Power (dBm)				Total Power (mW)	Total Power (dBm)	Limit (dBm)	Pass / Fail
		Chain 0	Chain 1	Chain 2	Chain 3				
38	5190	17.08	17.15	17.16	17.10	206.216	23.14	23.35	Pass
46	5230	17.75	17.56	17.12	17.76	227.809	23.58	23.59	Pass

- Note:**
1. For CH38 : The directional gain is 6.65dBi > 6dBi , so the power limit shall be reduced to $24-(6.65-6) = 23.35\text{dBm}$.
 2. For CH46 : The directional gain is 6.41dBi > 6dBi , so the power limit shall be reduced to $24-(6.41-6) = 23.59\text{dBm}$.

802.11ac (VHT80)

Chan.	Chan. Freq. (MHz)	Maximum Conducted Power (dBm)				Total Power (mW)	Total Power (dBm)	Limit (dBm)	Pass / Fail
		Chain 0	Chain 1	Chain 2	Chain 3				
42	5210	17.20	17.07	17.19	17.05	206.473	23.15	23.19	Pass

- Note:**
1. For CH42 : The directional gain is 6.81dBi > 6dBi , so the power limit shall be reduced to $24-(6.81-6) = 23.19\text{dBm}$.

Client - Beamforming Mode (Nss=2)
802.11ac (VHT20)

Chan.	Chan. Freq. (MHz)	Maximum Conducted Power (dBm)				Total Power (mW)	Total Power (dBm)	Limit (dBm)	Pass / Fail
		Chain 0	Chain 1	Chain 2	Chain 3				
36	5180	17.10	17.19	17.00	17.21	206.367	23.15	24.00	Pass
40	5200	17.21	17.17	16.82	17.16	204.805	23.11	24.00	Pass
48	5240	17.18	17.20	17.00	17.06	205.656	23.13	24.00	Pass

- Note:** 1. For CH36: The directional gain is 3.82dBi < 6dBi , so the power limit shall not be reduced.
 2. For CH40: The directional gain is 3.79dBi < 6dBi , so the power limit shall not be reduced.
 3. For CH48: The directional gain is 3.18dBi < 6dBi , so the power limit shall not be reduced.

802.11ac (VHT40)

Chan.	Chan. Freq. (MHz)	Maximum Conducted Power (dBm)				Total Power (mW)	Total Power (dBm)	Limit (dBm)	Pass / Fail
		Chain 0	Chain 1	Chain 2	Chain 3				
38	5190	17.08	17.15	17.16	17.10	206.216	23.14	24.00	Pass
46	5230	17.75	17.56	17.12	17.76	227.809	23.58	24.00	Pass

- Note:** 1. For CH38: The directional gain is 3.64dBi < 6dBi , so the power limit shall not be reduced.
 2. For CH46: The directional gain is 3.4dBi < 6dBi , so the power limit shall not be reduced.

802.11ac (VHT80)

Chan.	Chan. Freq. (MHz)	Maximum Conducted Power (dBm)				Total Power (mW)	Total Power (dBm)	Limit (dBm)	Pass / Fail
		Chain 0	Chain 1	Chain 2	Chain 3				
42	5210	17.20	17.07	17.19	17.05	206.473	23.15	24.00	Pass

- Note:** 1. For CH42: The directional gain is 3.8dBi < 6dBi , so the power limit shall not be reduced.

4.4 Occupied Bandwidth Measurement

4.4.1 Test Setup

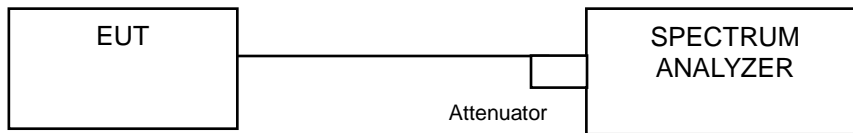

4.4.2 Test Instruments

Refer to section 4.1.2 to get information of above instrument.

4.4.3 Test Procedure

The transmitter output was connected to the spectrum analyzer through an attenuator. The bandwidth of the fundamental frequency was measured by spectrum analyzer with resolution bandwidth in the range of 1% to 5% of the anticipated emission bandwidth, and a video bandwidth at least 3x the resolution bandwidth and set the detector to SAMPLE. The width of a frequency band such that, below the lower and above the upper frequency limits, the mean powers emitted are each equal to a specified percentage 0.5 %of the total mean power of a given emission.

4.4.4 Test Results

Master – CDD Mode

802.11a

Channel	Channel Frequency (MHz)	Occupied Bandwidth (MHz)			
		Chain 0	Chain 1	Chain 2	Chain 3
36	5180	16.92	16.92	16.92	16.92
40	5200	16.92	16.80	16.92	17.04
48	5240	16.92	17.04	16.80	16.92
149	5745	16.80	17.16	16.92	17.04
157	5785	16.92	17.04	16.92	16.92
165	5825	16.92	17.04	17.04	17.04

802.11ac (VHT20)

Channel	Channel Frequency (MHz)	Occupied Bandwidth (MHz)			
		Chain 0	Chain 1	Chain 2	Chain 3
36	5180	18.24	18.00	18.12	18.00
40	5200	18.12	18.12	18.00	17.88
48	5240	18.12	18.12	18.12	18.12
149	5745	18.24	18.12	18.12	18.24
157	5785	18.24	18.24	18.12	18.36
165	5825	18.24	18.36	18.00	18.12

802.11ac (VHT40)

Channel	Channel Frequency (MHz)	Occupied Bandwidth (MHz)			
		Chain 0	Chain 1	Chain 2	Chain 3
38	5190	36.72	36.96	36.72	36.72
46	5230	36.72	36.72	36.96	36.72
151	5755	37.20	36.96	36.96	37.20
159	5795	36.72	36.72	36.96	37.44

802.11ac (VHT80)

Channel	Channel Frequency (MHz)	Occupied Bandwidth (MHz)			
		Chain 0	Chain 1	Chain 2	Chain 3
42	5210	75.36	75.84	75.84	75.84
155	5775	75.84	75.36	75.36	75.84

Spectrum Plot of Worst Value

802.11a / Chain 1 : CH149

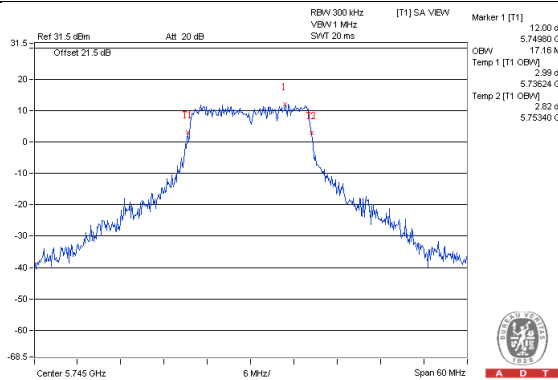

802.11a (VHT20) / Chain 1 : CH165

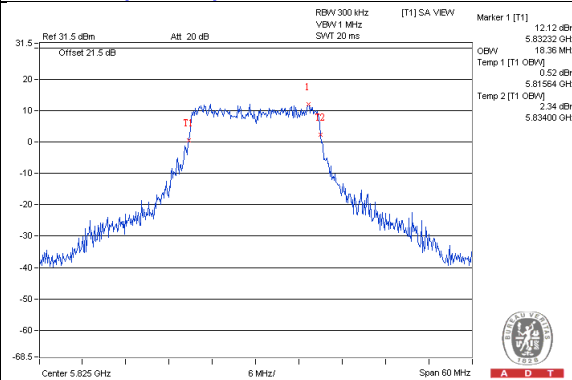

802.11ac (VHT40) / Chain 3: CH159

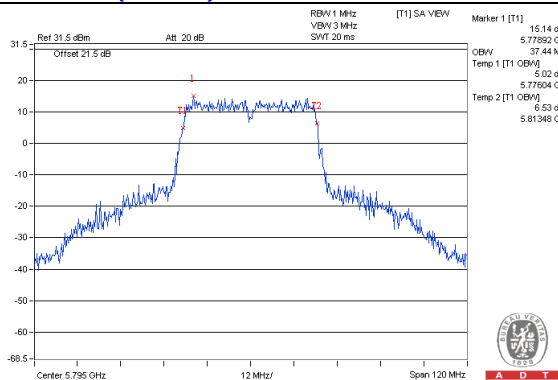

802.11ac (VHT80) / Chain 0 : CH155

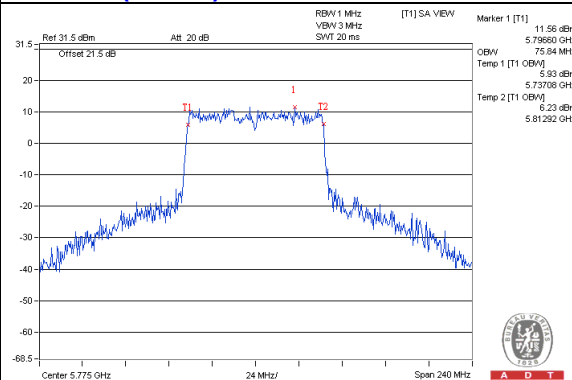

Client – CDD Mode
802.11a

Channel	Channel Frequency (MHz)	Occupied Bandwidth (MHz)			
		Chain 0	Chain 1	Chain 2	Chain 3
36	5180	16.92	17.04	16.92	16.92
40	5200	16.92	16.92	16.80	16.92
48	5240	16.92	16.92	16.92	16.92

802.11ac (VHT20)

Channel	Channel Frequency (MHz)	Occupied Bandwidth (MHz)			
		Chain 0	Chain 1	Chain 2	Chain 3
36	5180	18.12	18.24	18.24	18.12
40	5200	18.12	18.24	18.12	18.00
48	5240	18.24	18.12	18.12	18.00

802.11ac (VHT40)

Channel	Channel Frequency (MHz)	Occupied Bandwidth (MHz)			
		Chain 0	Chain 1	Chain 2	Chain 3
38	5190	37.20	36.96	37.20	36.96
46	5230	36.72	36.72	36.72	36.72

802.11ac (VHT80)

Channel	Channel Frequency (MHz)	Occupied Bandwidth (MHz)			
		Chain 0	Chain 1	Chain 2	Chain 3
42	5210	75.36	75.84	75.36	75.84

Spectrum Plot of Worst Value

802.11a / Chain 1 : CH36

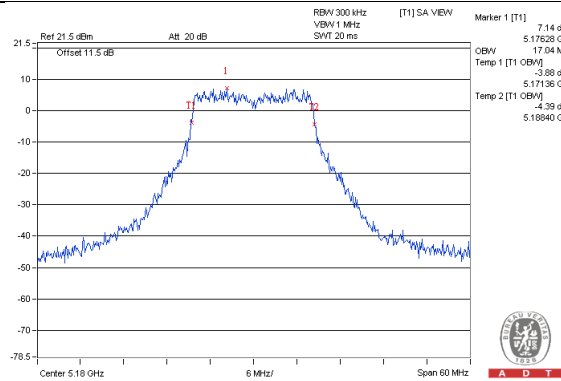

802.11ac (VHT20) / Chain 0 : CH48

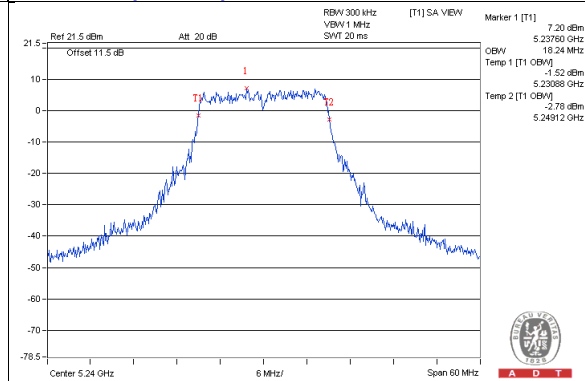

802.11ac (VHT40) / Chain 0: CH38

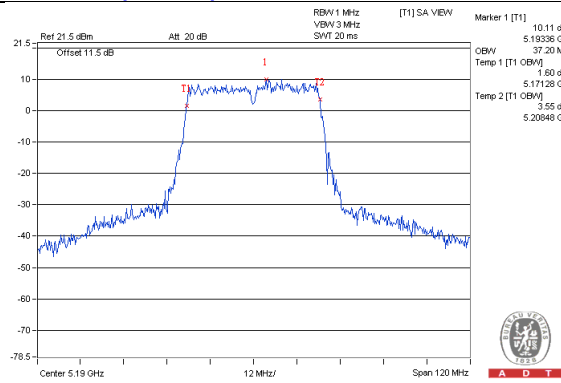

802.11ac (VHT80) / Chain 1 : CH42

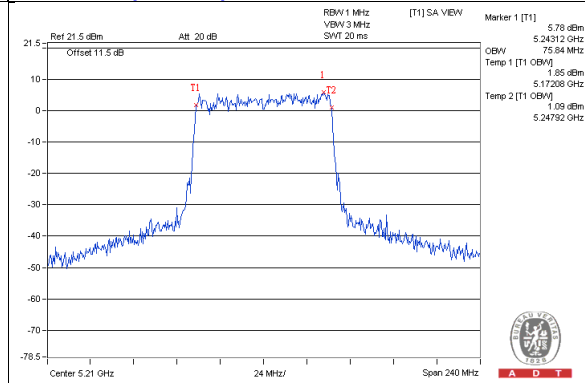

Spectrum Plot for near by DFS band (DFS is required, if 99% OCP straddle into U-NII-2A band)

802.11a / Chain 0 : CH48

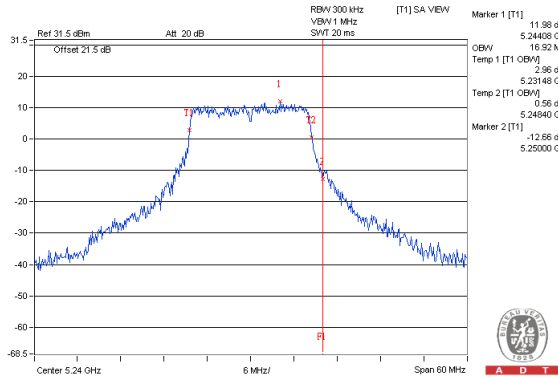

802.11a / Chain 1 : CH48

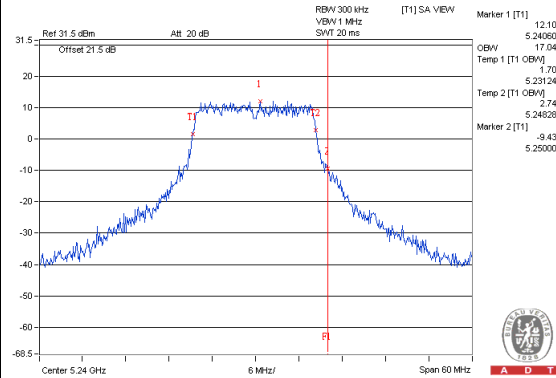

802.11a / Chain 2 : CH48

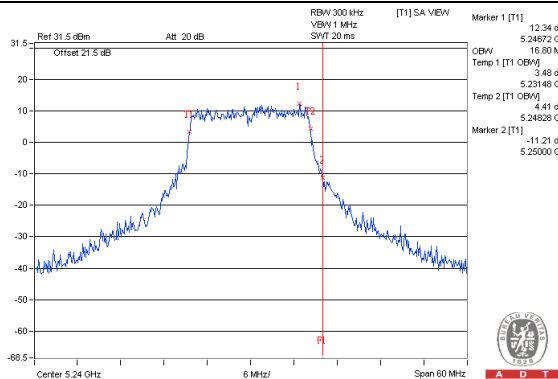

802.11a / Chain 3 : CH48

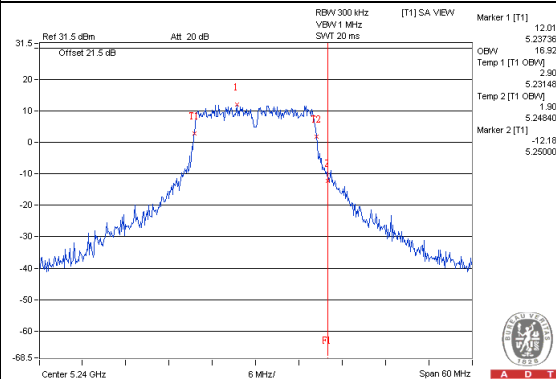

802.11ac (VHT20) / Chain 0 : CH48

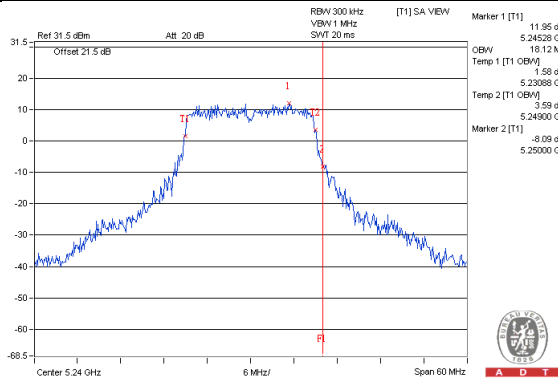

802.11ac (VHT20) / Chain 1 : CH48

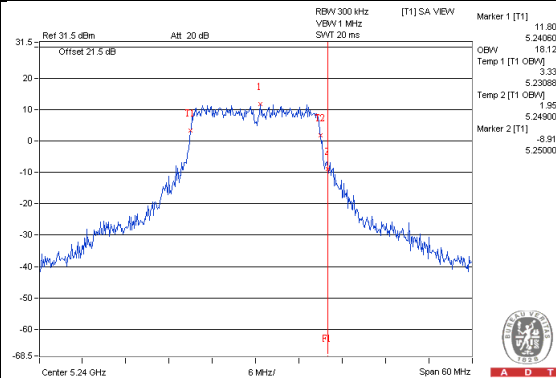

802.11ac (VHT20) / Chain 2 : CH48

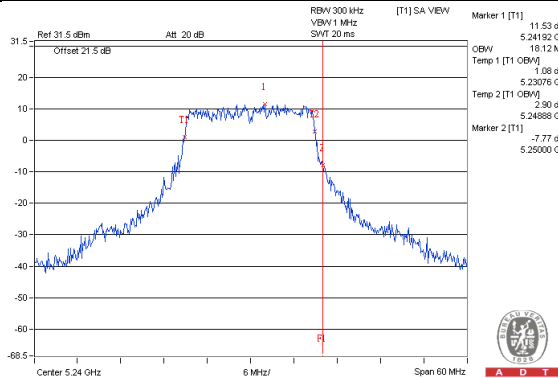

802.11ac (VHT20) / Chain 3 : CH48

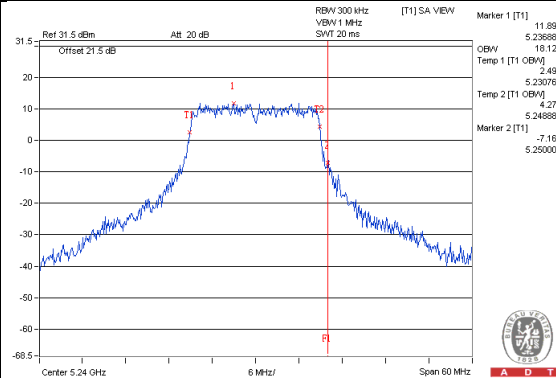

Spectrum Plot for near by DFS band (DFS is required, if 99% OCP straddle into U-NII-2A band)

802.11ac (VHT40) / Chain 0 : CH46

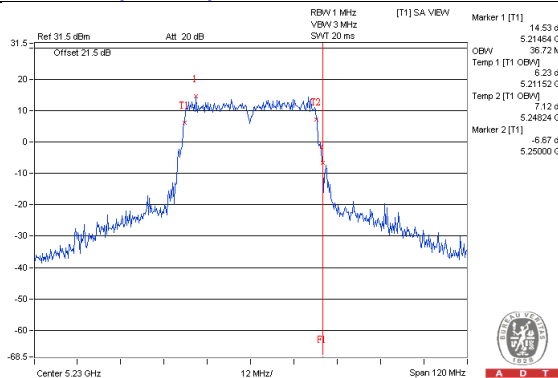

802.11ac (VHT40) / Chain 1 : CH46

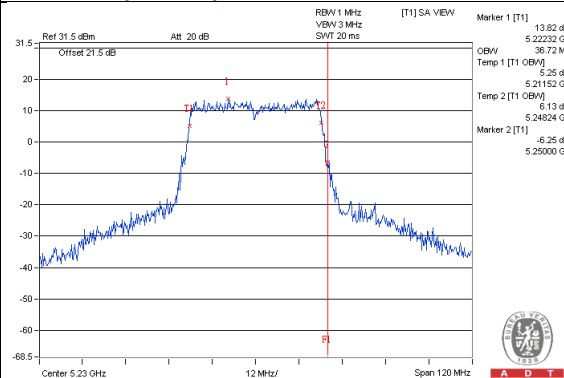

802.11ac (VHT40) / Chain 2 : CH46

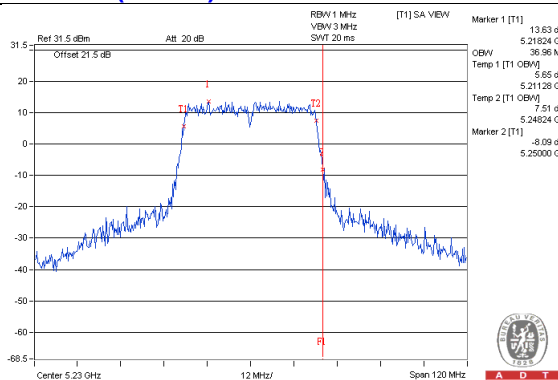

802.11ac (VHT40) / Chain 3 : CH46

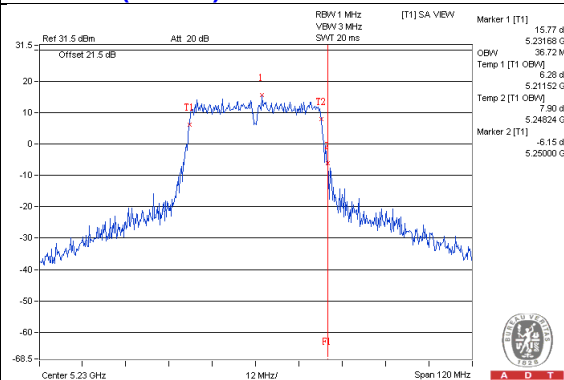

802.11ac (VHT80) / Chain 0 : CH42

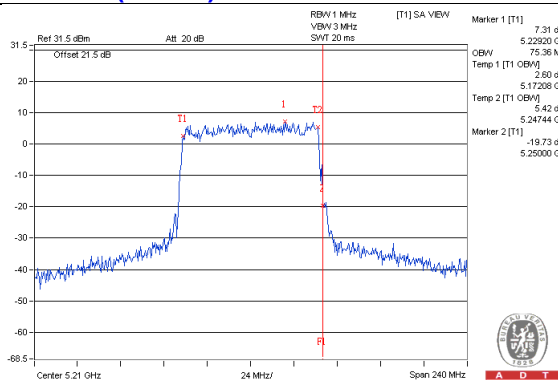

802.11ac (VHT80) / Chain 1 : CH42

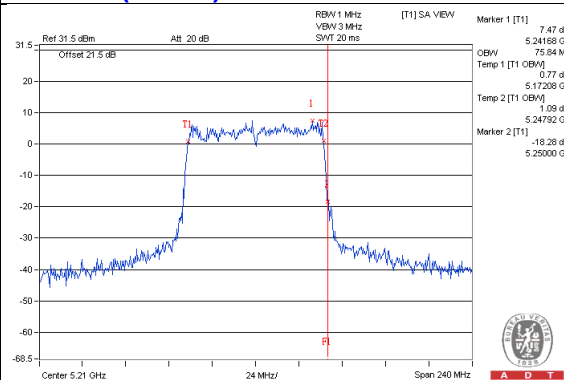

802.11ac (VHT80) / Chain 2 : CH42

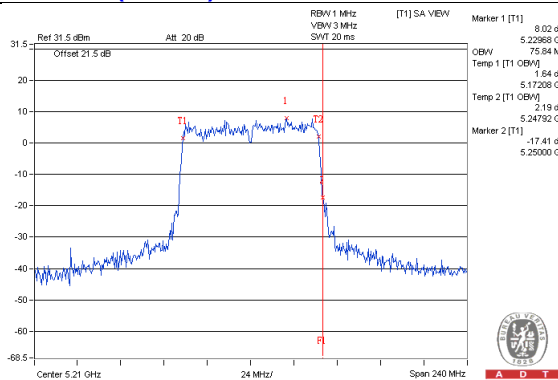

802.11ac (VHT80) / Chain 3 : CH42

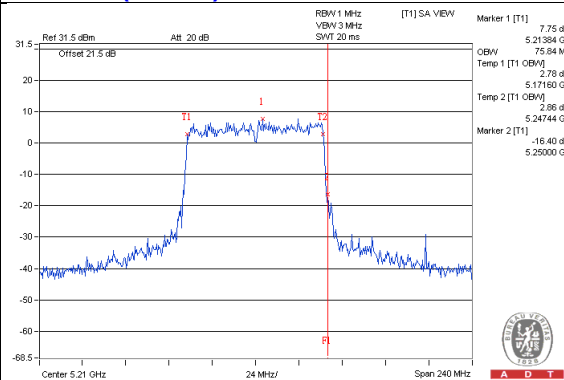

Spectrum Plot for near by DFS band (DFS is required, if 99% OCP straddle into U-NII-2C band)

802.11a / Chain 0 : CH149

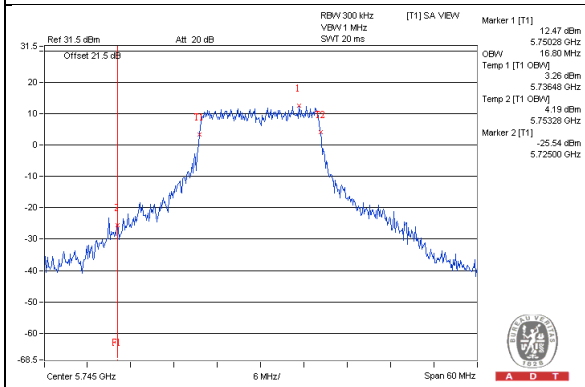

802.11a / Chain 1 : CH149

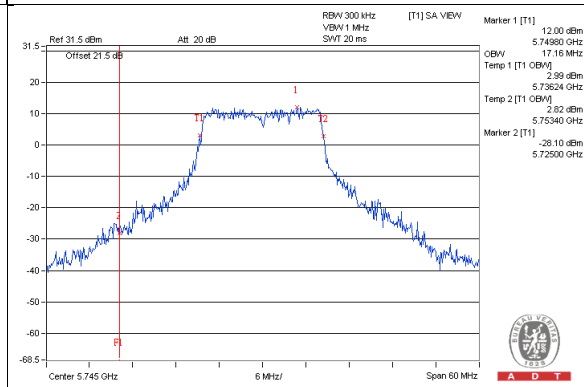

802.11a / Chain 2 : CH149

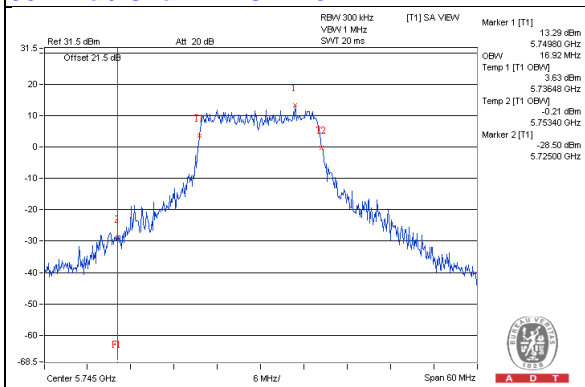

802.11a / Chain 3 : CH149

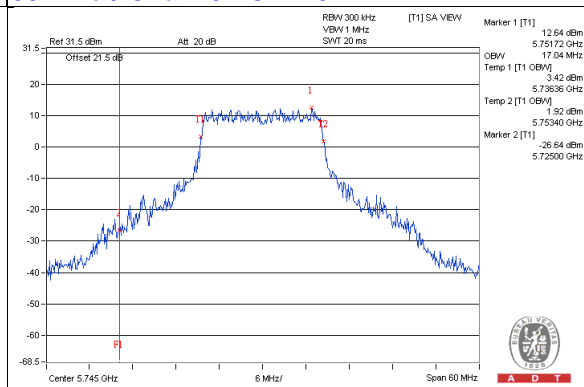

802.11ac (VHT20) / Chain 0 : CH149

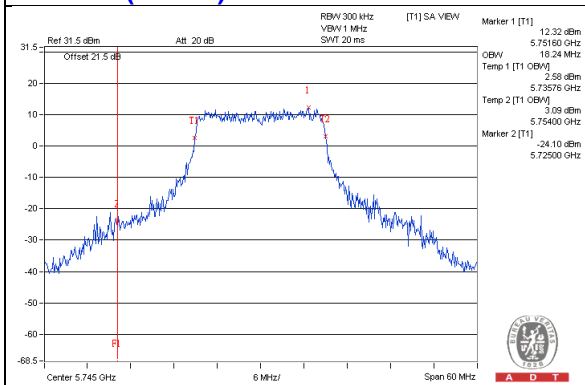

802.11ac (VHT20) / Chain 1 : CH149

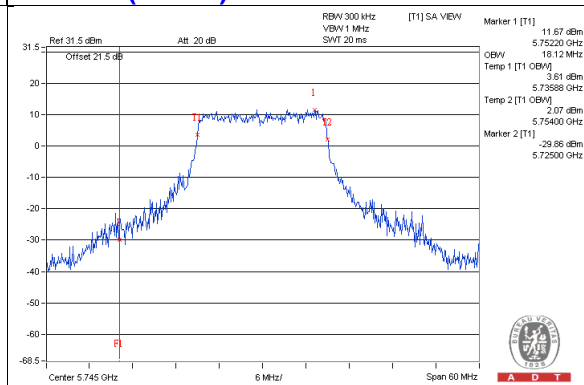

802.11ac (VHT20) / Chain 2 : CH149

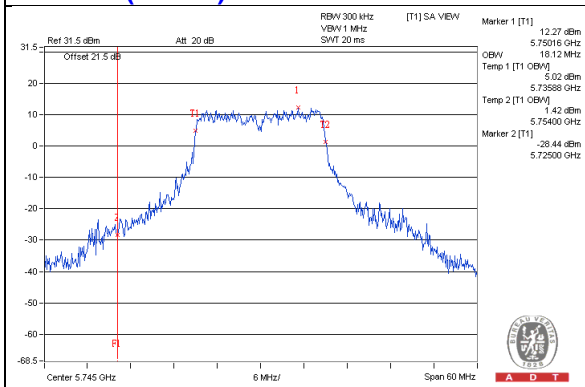

802.11ac (VHT20) / Chain 3 : CH149

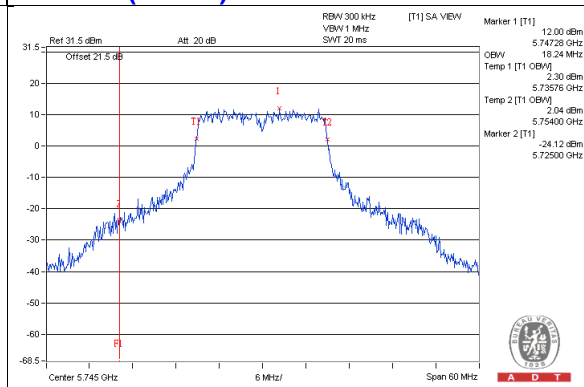

Spectrum Plot for near by DFS band (DFS is required, if 99% OCP straddle into U-NII-2C band)

802.11ac (VHT40) / Chain 0 : CH151

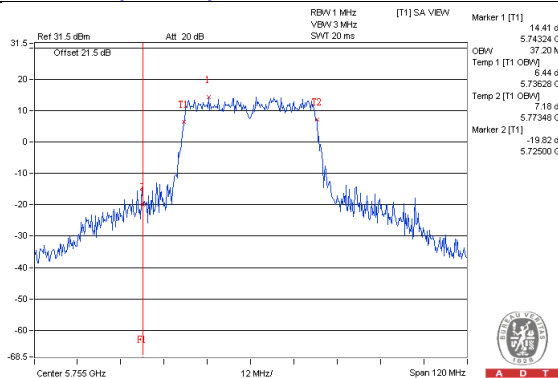

802.11ac (VHT40) / Chain 1 : CH151

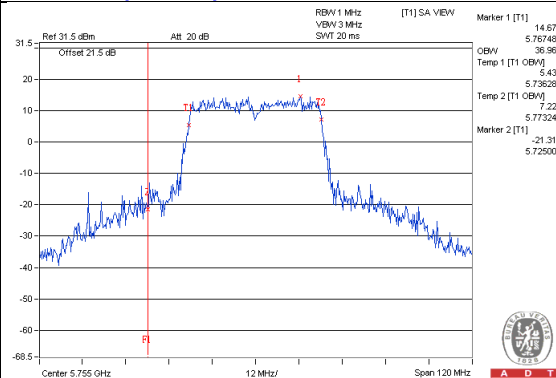

802.11ac (VHT40) / Chain 2 : CH151

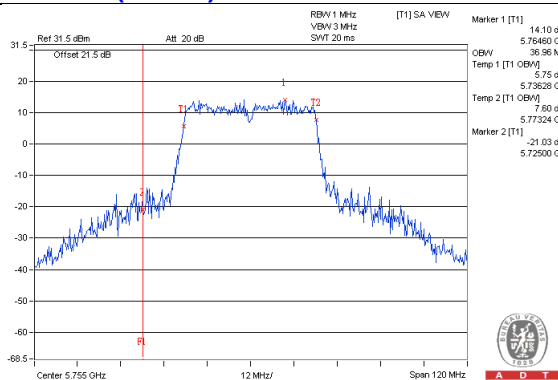

802.11ac (VHT40) / Chain 3 : CH151

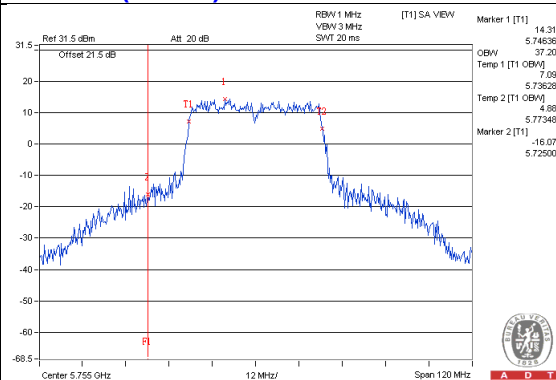

802.11ac (VHT80) / Chain 0 : CH155

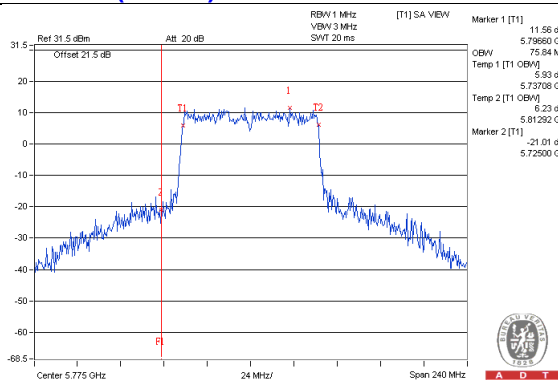

802.11ac (VHT80) / Chain 1 : CH155

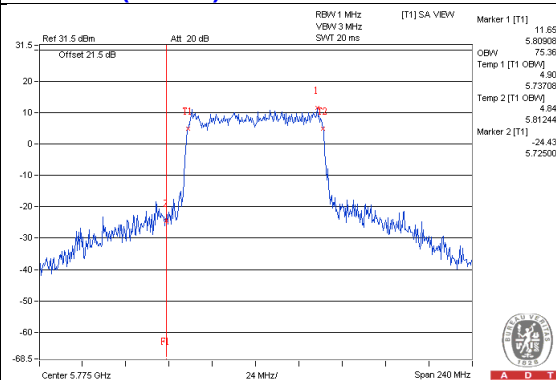

802.11ac (VHT80) / Chain 2 : CH155

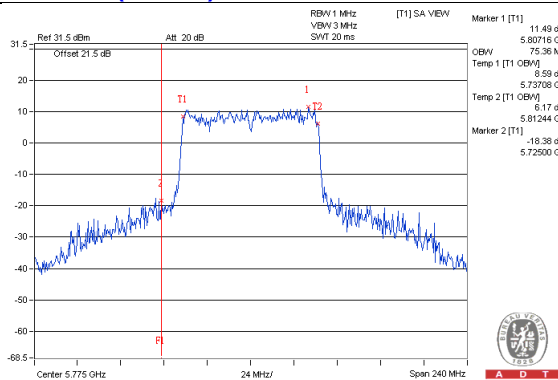

802.11ac (VHT80) / Chain 3 : CH155

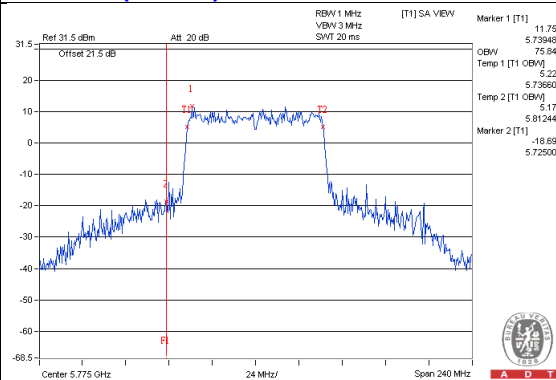

4.5 Peak Power Spectral Density Measurement

4.5.1 Limits of Peak Power Spectral Density Measurement

Operation Band	EUT Category		Limit
U-NII-1		Outdoor Access Point	17dBm/ MHz
		Fixed point-to-point Access Point	
	√	Indoor Access Point	11dBm/ MHz
	√	Mobile and Portable client device	
U-NII-2A			11dBm/ MHz
U-NII-2C			11dBm/ MHz
U-NII-3	√		30dBm/ 500kHz

4.5.2 Test Setup

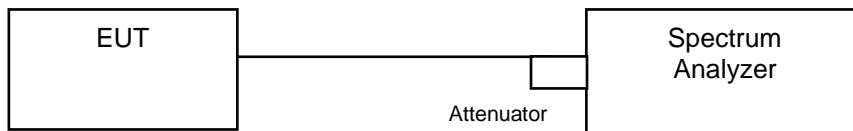

4.5.3 Test Instruments

Refer to section 4.1.2 to get information of above instrument.

4.5.4 Test Procedure

For U-NII-1:

Using method SA-1

1. Set span to encompass the entire emission bandwidth (EBW) of the signal.
2. Set RBW = 1 MHz, Set VBW \geq 3 MHz, Detector = RMS
3. Sweep time = auto, trigger set to "free run".
4. Trace average at least 100 traces in power averaging mode.
5. Record the max value

For U-NII-3:

1. Set span to encompass the entire emission bandwidth (EBW) of the signal.
2. Set RBW = 300 kHz, Set VBW \geq 1 MHz, Detector = RMS
3. Use the peak marker function to determine the maximum power level in any 300 kHz band segment within the fundamental EBW.
4. Scale the observed power level to an equivalent value in 500 kHz by adjusting (reducing) the measured power by a bandwidth correction factor (BWCF) where $BWCF = 10\log(500 \text{ kHz}/300\text{kHz})$
5. Sweep time = auto, trigger set to "free run".
6. Trace average at least 100 traces in power averaging mode.
7. Record the max value

4.5.5 Deviation from Test Standard

No deviation.

4.5.6 EUT Operating Condition

Same as Item 4.3.6.

4.5.7 Test Results

For U-NII-1:

Master – CDD Mode

802.11a

Chan.	Chan. Freq. (MHz)	PSD (dBm/MHz)				Total Power Density (dBm/MHz)	MAX. Limit (dBm/MHz)	Pass / Fail
		Chain 0	Chain 1	Chain 2	Chain 3			
36	5180	4.66	5.96	6.49	6.40	11.96	16.17	Pass
40	5200	7.89	6.90	7.69	7.62	13.56	16.2	Pass
48	5240	7.90	7.21	7.42	7.62	13.57	16.81	Pass

- Note:**
- Method a) of power density measurement of KDB 662911 is using for calculating total power density. Total power density is summing entire spectra across corresponding frequency bins on the various outputs by computer.
 - For CH36 : The directional gain is 6.83dBi > 6dBi , so the power density limit shall be reduced to $17-(6.83-6) = 16.17\text{dBm}$.
 - For CH40 : The directional gain is 6.8dBi > 6dBi , so the power density limit shall be reduced to $17-(6.8-6) = 16.2\text{dBm}$.
 - For CH48 : The directional gain is 6.19dBi > 6dBi , so the power density limit shall be reduced to $17-(6.19-6) = 16.81\text{dBm}$.

802.11ac (VHT20)

Chan.	Chan. Freq. (MHz)	PSD (dBm/MHz)				Total Power Density (dBm/MHz)	MAX. Limit (dBm/MHz)	Pass / Fail
		Chain 0	Chain 1	Chain 2	Chain 3			
36	5180	6.16	5.73	6.46	6.40	12.22	16.17	Pass
40	5200	3.95	6.89	7.20	7.32	12.56	16.2	Pass
48	5240	7.30	7.15	7.23	7.62	13.35	16.81	Pass

- Note:**
- Method a) of power density measurement of KDB 662911 is using for calculating total power density. Total power density is summing entire spectra across corresponding frequency bins on the various outputs by computer.
 - For CH36 : The directional gain is 6.83dBi > 6dBi , so the power density limit shall be reduced to $17-(6.83-6) = 16.17\text{dBm}$.
 - For CH40 : The directional gain is 6.8dBi > 6dBi , so the power density limit shall be reduced to $17-(6.8-6) = 16.2\text{dBm}$.
 - For CH48 : The directional gain is 6.19dBi > 6dBi , so the power density limit shall be reduced to $17-(6.19-6) = 16.81\text{dBm}$.

802.11ac (VHT40)

Chan.	Chan. Freq. (MHz)	PSD (dBm/MHz)				Total Power Density (dBm/MHz)	MAX. Limit (dBm/MHz)	Pass / Fail
		Chain 0	Chain 1	Chain 2	Chain 3			
38	5190	1.26	1.34	0.69	0.94	7.09	16.35	Pass
46	5230	4.01	4.38	3.55	4.48	10.14	16.59	Pass

- Note:**
- Method a) of power density measurement of KDB 662911 is using for calculating total power density. Total power density is summing entire spectra across corresponding frequency bins on the various outputs by computer.
 - For CH38 : The directional gain is 6.65dBi > 6dBi , so the power density limit shall be reduced to $17-(6.65-6) = 16.35\text{dBm}$.
 - For CH46 : The directional gain is 6.41dBi > 6dBi , so the power density limit shall be reduced to $17-(6.41-6) = 16.59\text{dBm}$.

802.11ac (VHT80)

Chan.	Chan. Freq. (MHz)	PSD (dBm/MHz)				Total Power Density (dBm/MHz)	MAX. Limit (dBm/MHz)	Pass / Fail
		Chain 0	Chain 1	Chain 2	Chain 3			
42	5210	-1.21	-0.92	-1.64	-1.14	4.80	16.19	Pass

- Note:**
- Method a) of power density measurement of KDB 662911 is using for calculating total power density. Total power density is summing entire spectra across corresponding frequency bins on the various outputs by computer.
 - For CH42 : The directional gain is 6.81dBi > 6dBi , so the power density limit shall be reduced to $17-(6.81-6) = 16.19\text{dBm}$.

Spectrum Plot of Worst Value

802.11a_Chain 0 / CH48

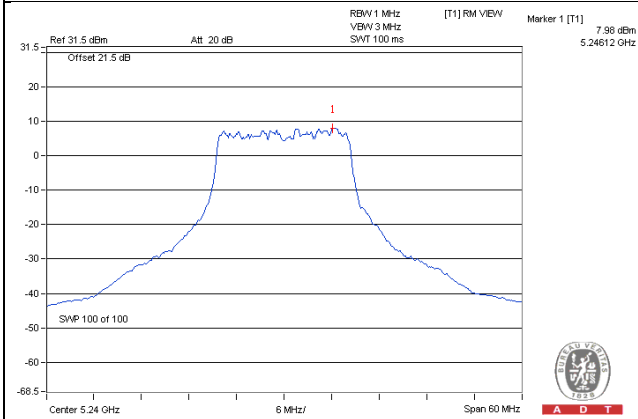

802.11ac (VHT20)_Chain 3 / CH48

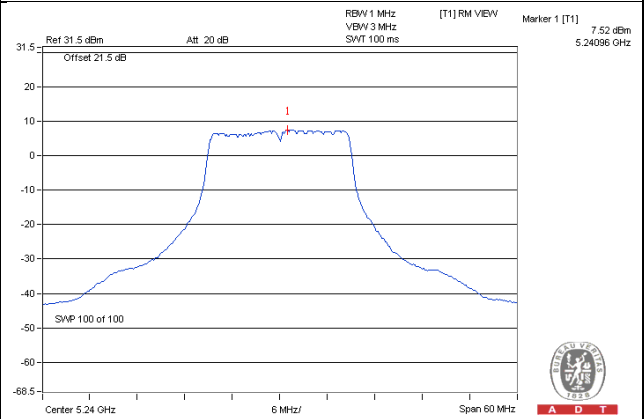

802.11ac (VHT40)_Chain 3 / CH46

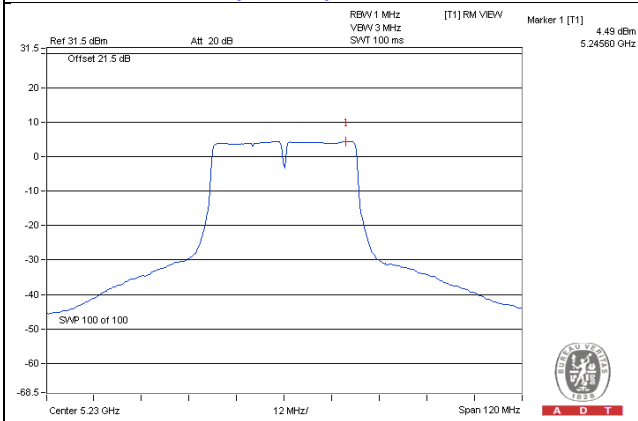

802.11ac (VHT80)_Chain 1 / CH42

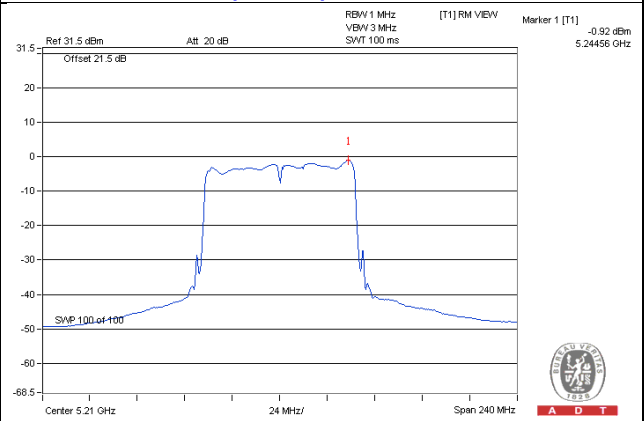

Client – CDD Mode
802.11a

Chan.	Chan. Freq. (MHz)	PSD (dBm/MHz)				Total Power Density (dBm/MHz)	MAX. Limit (dBm/MHz)	Pass / Fail
		Chain 0	Chain 1	Chain 2	Chain 3			
36	5180	3.20	2.72	2.88	2.64	8.89	10.17	Pass
40	5200	3.26	2.48	2.69	2.73	8.82	10.2	Pass
48	5240	3.56	2.27	3.18	3.16	9.09	10.81	Pass

- Note:**
1. Method a) of power density measurement of KDB 662911 is using for calculating total power density. Total power density is summing entire spectra across corresponding frequency bins on the various outputs by computer.
 2. For CH36 : The directional gain is 6.83dBi > 6dBi , so the power density limit shall be reduced to $11-(6.83-6) = 10.17\text{dBm}$.
 3. For CH40 : The directional gain is 6.8dBi > 6dBi , so the power density limit shall be reduced to $11-(6.8-6) = 10.2\text{dBm}$.
 4. For CH48 : The directional gain is 6.19dBi > 6dBi , so the power density limit shall be reduced to $11-(6.19-6) = 10.81\text{dBm}$.

802.11ac (VHT20)

Chan.	Chan. Freq. (MHz)	PSD (dBm/MHz)				Total Power Density (dBm/MHz)	MAX. Limit (dBm/MHz)	Pass / Fail
		Chain 0	Chain 1	Chain 2	Chain 3			
36	5180	2.53	1.94	2.14	2.13	8.21	10.17	Pass
40	5200	2.73	2.27	2.64	2.51	8.56	10.2	Pass
48	5240	3.33	1.89	2.97	2.83	8.81	10.81	Pass

- Note:**
1. Method a) of power density measurement of KDB 662911 is using for calculating total power density. Total power density is summing entire spectra across corresponding frequency bins on the various outputs by computer.
 2. For CH36 : The directional gain is 6.83dBi > 6dBi , so the power density limit shall be reduced to $11-(6.83-6) = 10.17\text{dBm}$.
 3. For CH40 : The directional gain is 6.8dBi > 6dBi , so the power density limit shall be reduced to $11-(6.8-6) = 10.2\text{dBm}$.
 4. For CH48 : The directional gain is 6.19dBi > 6dBi , so the power density limit shall be reduced to $11-(6.19-6) = 10.81\text{dBm}$.

802.11ac (VHT40)

Chan.	Chan. Freq. (MHz)	PSD (dBm/MHz)				Total Power Density (dBm/MHz)	MAX. Limit (dBm/MHz)	Pass / Fail
		Chain 0	Chain 1	Chain 2	Chain 3			
38	5190	-0.03	0.25	-1.01	-0.30	5.77	10.35	Pass
46	5230	-0.02	0.42	-0.46	0.04	6.03	10.59	Pass

- Note:**
- Method a) of power density measurement of KDB 662911 is using for calculating total power density. Total power density is summing entire spectra across corresponding frequency bins on the various outputs by computer.
 - For CH38 : The directional gain is 6.65dBi > 6dBi , so the power density limit shall be reduced to $11-(6.65-6) = 10.35\text{dBm}$.
 - For CH46 : The directional gain is 6.41dBi > 6dBi , so the power density limit shall be reduced to $11-(6.41-6) = 10.59\text{dBm}$.

802.11ac (VHT80)

Chan.	Chan. Freq. (MHz)	PSD (dBm/MHz)				Total Power Density (dBm/MHz)	MAX. Limit (dBm/MHz)	Pass / Fail
		Chain 0	Chain 1	Chain 2	Chain 3			
42	5210	-1.38	-1.87	-2.35	-2.46	4.03	10.19	Pass

- Note:**
- Method a) of power density measurement of KDB 662911 is using for calculating total power density. Total power density is summing entire spectra across corresponding frequency bins on the various outputs by computer.
 - For CH42 : The directional gain is 6.81dBi > 6dBi , so the power density limit shall be reduced to $11-(6.81-6) = 10.19\text{ dBm}$.

Spectrum Plot of Worst Value

802.11a_Chain 0 / CH48

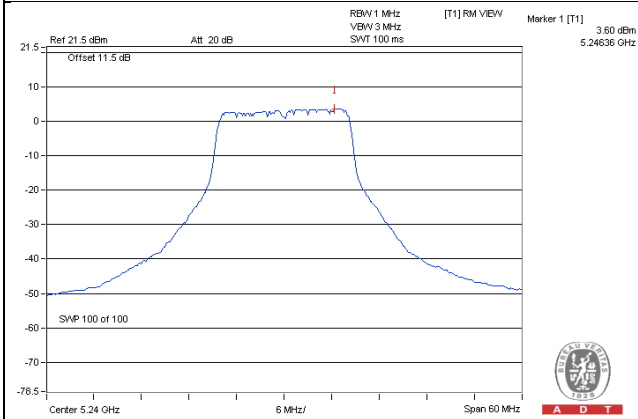

802.11ac (VHT20)_Chain 0 / CH48

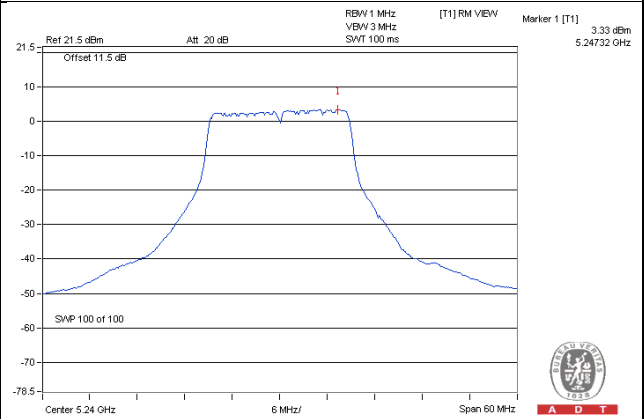

802.11ac (VHT40)_Chain 1 / CH46

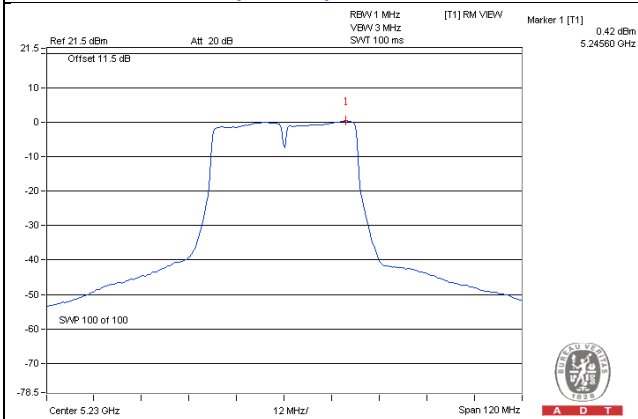

802.11ac (VHT80)_Chain 0 / CH42

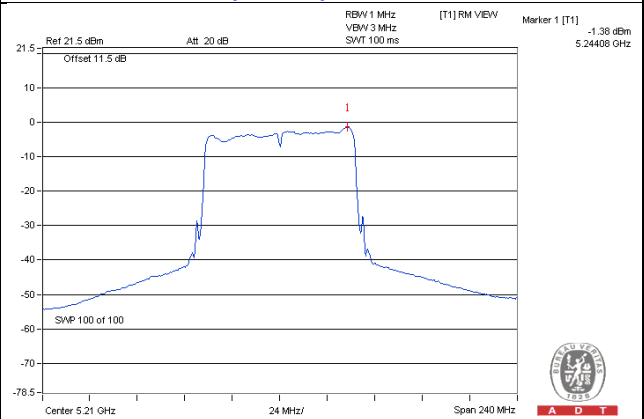

For U-NII-3:

CDD Mode

802.11a

TX chain	Channel	Freq. (MHz)	PSD (dBm/300kHz)	PSD (dBm/500kHz)	10 log (N=4) dB	Total PSD (dBm/500kHz)	Limit (dBm/500kHz)	Pass /Fail
0	149	5745	0.52	2.74	6.02	8.76	29.39	Pass
	157	5785	0.81	3.03	6.02	9.05	29.62	Pass
	165	5825	1.28	3.50	6.02	9.52	29.73	Pass
1	149	5745	0.39	2.61	6.02	8.63	29.39	Pass
	157	5785	0.80	3.02	6.02	9.04	29.62	Pass
	165	5825	1.04	3.26	6.02	9.28	29.73	Pass
2	149	5745	0.43	2.65	6.02	8.67	29.39	Pass
	157	5785	0.26	2.48	6.02	8.50	29.62	Pass
	165	5825	0.86	3.08	6.02	9.10	29.73	Pass
3	149	5745	0.48	2.70	6.02	8.72	29.39	Pass
	157	5785	0.44	2.66	6.02	8.68	29.62	Pass
	165	5825	0.64	2.86	6.02	8.88	29.73	Pass

- Note: 1. For CH149 : The directional gain is 6.61dBi > 6dBi , so the power density limit shall be reduced to $30-(6.61-6) = 29.39\text{dBm}$.
2. For CH157 : The directional gain is 6.38dBi > 6dBi , so the power density limit shall be reduced to $30-(6.38-6) = 29.62\text{dBm}$.
3. For CH165 : The directional gain is 6.27dBi > 6dBi , so the power density limit shall be reduced to $30-(6.27-6) = 29.73\text{dBm}$.

802.11ac (VHT20)

TX chain	Channel	Freq. (MHz)	PSD (dBm/300kHz)	PSD (dBm/500kHz)	10 log (N=4) dB	Total PSD (dBm/500kHz)	Limit (dBm/500kHz)	Pass /Fail
0	149	5745	-0.28	1.94	6.02	7.96	29.39	Pass
	157	5785	0.27	2.49	6.02	8.51	29.62	Pass
	165	5825	0.62	2.84	6.02	8.86	29.73	Pass
1	149	5745	0.52	2.74	6.02	8.76	29.39	Pass
	157	5785	0.66	2.88	6.02	8.90	29.62	Pass
	165	5825	0.54	2.76	6.02	8.78	29.73	Pass
2	149	5745	0.34	2.56	6.02	8.58	29.39	Pass
	157	5785	0.50	2.72	6.02	8.74	29.62	Pass
	165	5825	0.95	3.17	6.02	9.19	29.73	Pass
3	149	5745	0.15	2.37	6.02	8.39	29.39	Pass
	157	5785	0.47	2.69	6.02	8.71	29.62	Pass
	165	5825	0.65	2.87	6.02	8.89	29.73	Pass

- Note: 1. For CH149 : The directional gain is 6.61dBi > 6dBi , so the power density limit shall be reduced to $30-(6.61-6) = 29.39\text{dBm}$.
2. For CH157 : The directional gain is 6.38dBi > 6dBi , so the power density limit shall be reduced to $30-(6.38-6) = 29.62\text{dBm}$.
3. For CH165 : The directional gain is 6.27dBi > 6dBi , so the power density limit shall be reduced to $30-(6.27-6) = 29.73\text{dBm}$.

802.11ac (VHT40)

TX chain	Channel	Freq. (MHz)	PSD (dBm/300kHz)	PSD (dBm/500kHz)	10 log (N=4) dB	Total PSD (dBm/500kHz)	Limit (dBm/500kHz)	Pass /Fail
0	151	5755	-3.52	-1.30	6.02	4.72	29.6	Pass
	159	5795	-3.19	-0.97	6.02	5.05	29.5	Pass
1	151	5755	-3.08	-0.86	6.02	5.16	29.6	Pass
	159	5795	-2.73	-0.51	6.02	5.51	29.5	Pass
2	151	5755	-3.44	-1.22	6.02	4.80	29.6	Pass
	159	5795	-3.34	-1.12	6.02	4.90	29.5	Pass
3	151	5755	-3.61	-1.39	6.02	4.63	29.6	Pass
	159	5795	-3.64	-1.42	6.02	4.60	29.5	Pass

- Note: 1. For CH151 : The directional gain is 6.4dBi > 6dBi , so the power density limit shall be reduced to $30-(6.4-6) = 29.6\text{dBm}$.
2. For CH159 : The directional gain is 6.5dBi > 6dBi , so the power density limit shall be reduced to $30-(6.5-6) = 29.5\text{dBm}$.

802.11ac (VHT80)

TX chain	Channel	Freq. (MHz)	PSD (dBm/300kHz)	PSD (dBm/500kHz)	10 log (N=2) dB	Total PSD (dBm/500kHz)	Limit (dBm/500kHz)	Pass /Fail
0	155	5775	-5.75	-3.53	6.02	2.49	29.99	Pass
1	155	5775	-5.50	-3.28	6.02	2.74	29.99	Pass
2	155	5775	-6.49	-4.27	6.02	1.75	29.99	Pass
3	155	5775	-6.42	-4.20	6.02	1.82	29.99	Pass

Note: 1. For CH155 : The directional gain is 6.01dBi > 6dBi , so the power density limit shall be reduced to $30-(6.01-6) = 29.99\text{dBm}$.

Spectrum Plot of Worst Value

802.11a – Chain 0: CH 165

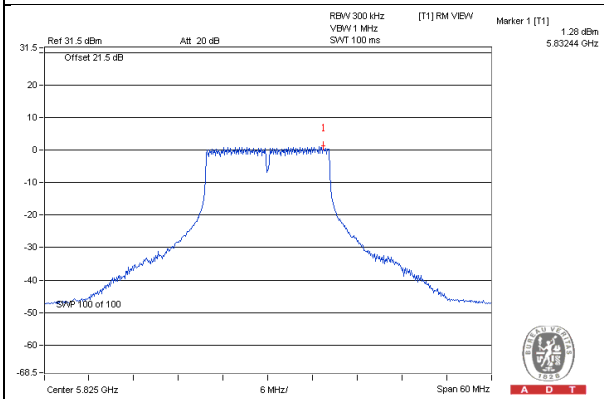

802.11ac (VHT20) – Chain 2: CH 165

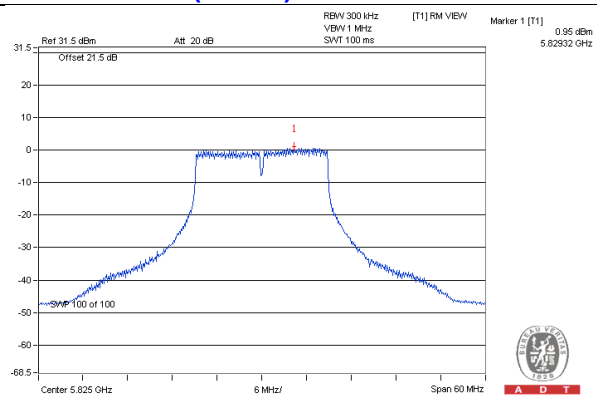

802.11ac (VHT40) – Chain 1: CH 159

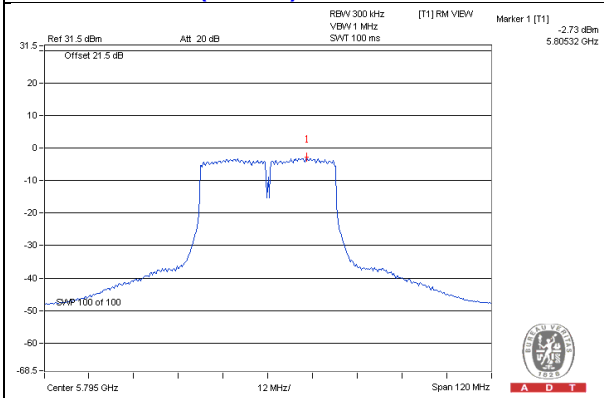

802.11ac (VHT80) – Chain 1: CH 155

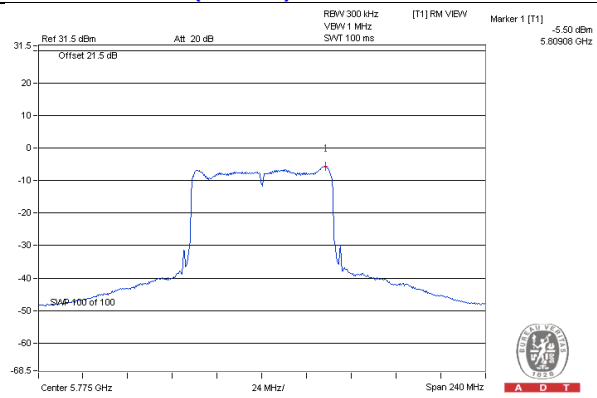

4.6 Frequency Stability Measurement

4.6.1 Limits of Frequency Stability Measurement

The frequency of the carrier signal shall be maintained within band of operation

4.6.2 Test Setup

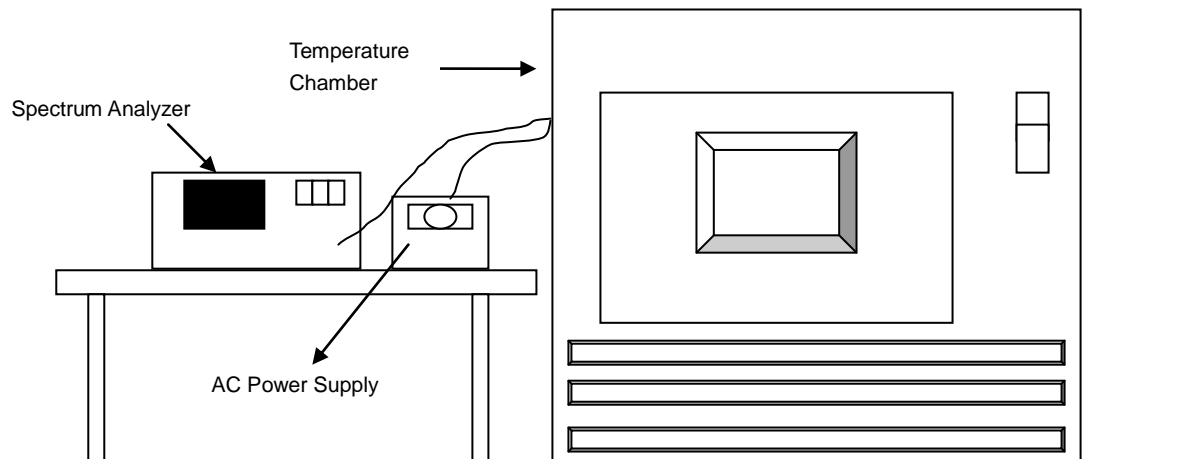

4.6.3 Test Instruments

Refer to section 4.1.2 to get information of above instrument.

4.6.4 Test Procedure

- The EUT was placed inside the environmental test chamber and powered by nominal AC voltage.
- Turn the EUT on and couple its output to a spectrum analyzer.
- Turn the EUT off and set the chamber to the highest temperature specified.
- Allow sufficient time (approximately 30 min) for the temperature of the chamber to stabilize, turn the EUT on and measure the operating frequency after 2, 5, and 10 minutes.
- Repeat step 2 and 3 with the temperature chamber set to the lowest temperature.
- The test chamber was allowed to stabilize at +20 degree C for a minimum of 30 minutes. The supply voltage was then adjusted on the EUT from 85% to 115% and the frequency record.

4.6.5 Deviation from Test Standard

No deviation.

4.6.6 EUT Operating Condition

Set the EUT transmit at un-modulation mode to test frequency stability.

4.6.7 Test Results

Frequency Stability Versus Temp.									
Operating Frequency: 5180 MHz									
TEMP. (°C)	Power Supply (Vac)	0 Minute		2 Minute		5 Minute		10 Minute	
		Measured Frequency (MHz)	Pass/Fail	Measured Frequency (MHz)	Pass/Fail	Measured Frequency (MHz)	Pass/Fail	Measured Frequency (MHz)	Pass/Fail
50	120	5179.9776	Pass	5179.9772	Pass	5179.9762	Pass	5179.9788	Pass
40	120	5180.0011	Pass	5180.0003	Pass	5180.0029	Pass	5179.9992	Pass
30	120	5179.9836	Pass	5179.9838	Pass	5179.9831	Pass	5179.9807	Pass
20	120	5180.0023	Pass	5180.0029	Pass	5180.0023	Pass	5180.0032	Pass
10	120	5179.9863	Pass	5179.9864	Pass	5179.9867	Pass	5179.9871	Pass
0	120	5180.0235	Pass	5180.0248	Pass	5180.0232	Pass	5180.0258	Pass
-10	120	5180.0139	Pass	5180.0136	Pass	5180.0116	Pass	5180.0117	Pass
-20	120	5180.0247	Pass	5180.023	Pass	5180.0223	Pass	5180.0235	Pass
-30	120	5179.978	Pass	5179.9804	Pass	5179.979	Pass	5179.9797	Pass

Frequency Stability Versus Voltage									
Operating Frequency: 5180 MHz									
TEMP. (°C)	Power Supply (Vac)	0 Minute		2 Minute		5 Minute		10 Minute	
		Measured Frequency (MHz)	Pass/Fail	Measured Frequency (MHz)	Pass/Fail	Measured Frequency (MHz)	Pass/Fail	Measured Frequency (MHz)	Pass/Fail
20	138	5180.0031	Pass	5180.0019	Pass	5180.0017	Pass	5180.0039	Pass
	120	5180.0023	Pass	5180.0029	Pass	5180.0023	Pass	5180.0032	Pass
	102	5180.0024	Pass	5180.0038	Pass	5180.0026	Pass	5180.0026	Pass

4.7 6dB Bandwidth Measurement

4.7.1 Limits of 6dB Bandwidth Measurement

The minimum of 6dB Bandwidth Measurement is 0.5MHz.

4.7.2 Test Setup

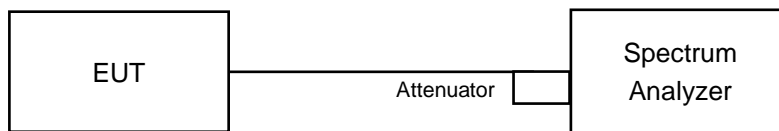

4.7.3 Test Instruments

Refer to section 4.1.2 to get information of above instrument.

4.7.4 Test Procedure

MEASUREMENT PROCEDURE REF

- Set resolution bandwidth (RBW) = 100kHz
- Set the video bandwidth (VBW) $\geq 3 \times$ RBW, Detector = Peak.
- Trace mode = max hold.
- Sweep = auto couple.
- Measure the maximum width of the emission that is constrained by the frequencies associated with the two amplitude points (upper and lower) that are attenuated by 6 dB relative to the maximum level measured in the fundamental emission

4.7.5 Deviation from Test Standard

No deviation.

4.7.6 EUT Operating Condition

The software provided by client to enable the EUT under transmission condition continuously at lowest, middle and highest channel frequencies individually.

4.7.7 Test Results

802.11a

Channel	Frequency (MHz)	6dB Bandwidth (MHz)				Minimum Limit (MHz)	Pass / Fail
		Chain 0	Chain 1	Chain 2	Chain 3		
149	5745	16.42	16.42	16.41	16.43	0.5	Pass
157	5785	16.41	16.42	16.41	16.42	0.5	Pass
165	5825	16.41	16.43	16.41	16.42	0.5	Pass

802.11ac (VHT20)

Channel	Frequency (MHz)	6dB Bandwidth (MHz)				Minimum Limit (MHz)	Pass / Fail
		Chain 0	Chain 1	Chain 2	Chain 3		
149	5745	17.62	17.66	17.66	17.67	0.5	Pass
157	5785	17.64	17.65	17.62	17.65	0.5	Pass
165	5825	17.67	17.68	17.68	17.65	0.5	Pass

802.11ac (VHT40)

Channel	Frequency (MHz)	6dB Bandwidth (MHz)				Minimum Limit (MHz)	Pass / Fail
		Chain 0	Chain 1	Chain 2	Chain 3		
151	5755	36.40	36.47	36.41	36.44	0.5	Pass
159	5795	36.46	36.40	36.36	36.39	0.5	Pass

802.11ac (VHT80)

Channel	Frequency (MHz)	6dB Bandwidth (MHz)				Minimum Limit (MHz)	Pass / Fail
		Chain 0	Chain 1	Chain 2	Chain 3		
155	5755	75.40	75.54	75.01	75.33	0.5	Pass

Spectrum Plot of Worst Value

802.11a_Chain 0 / CH157

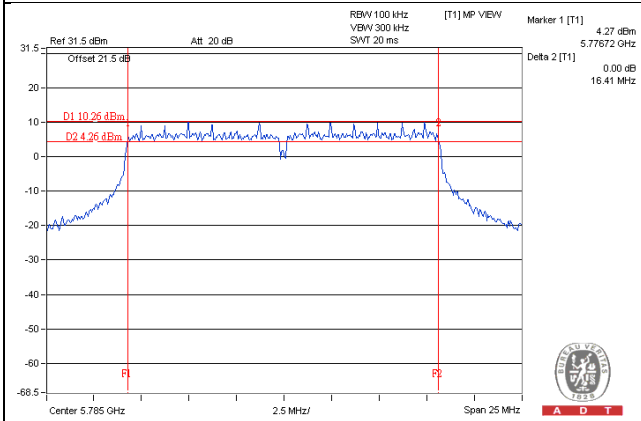

802.11ac (VHT20)_Chain 2 / CH157

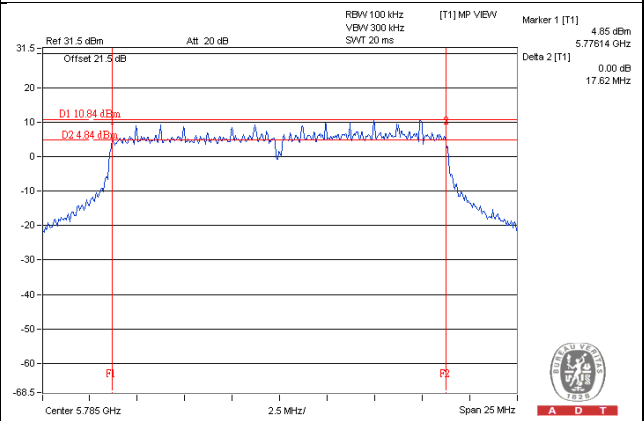

802.11ac (VHT40)_Chain 2 / CH159

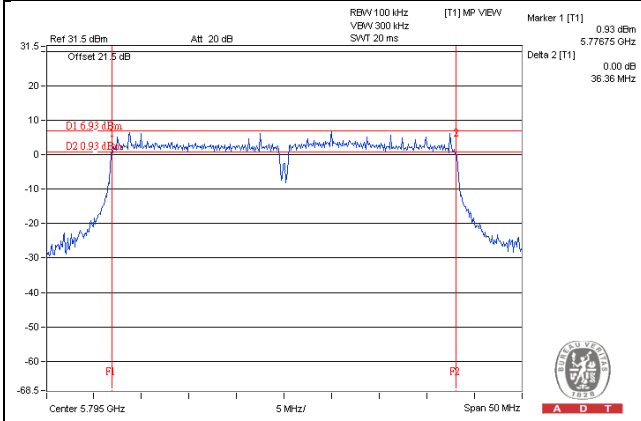

802.11ac (VHT80)_Chain 2 / CH155

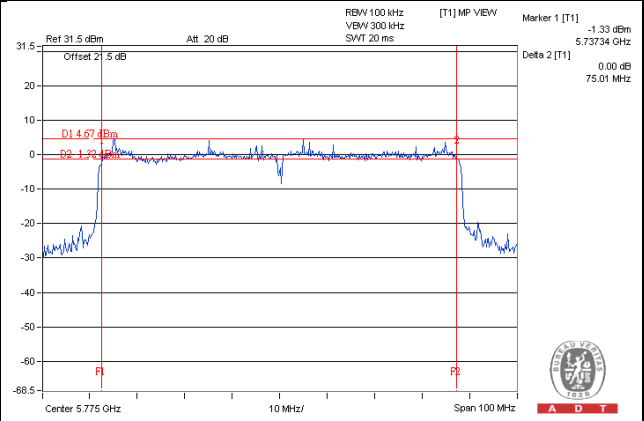

5 Pictures of Test Arrangements

Please refer to the attached file (Test Setup Photo).

Annex A- Radiated Out of Band Emisison (OOBE) Measurement (For U-NII-3 band)

802.11a

CH149

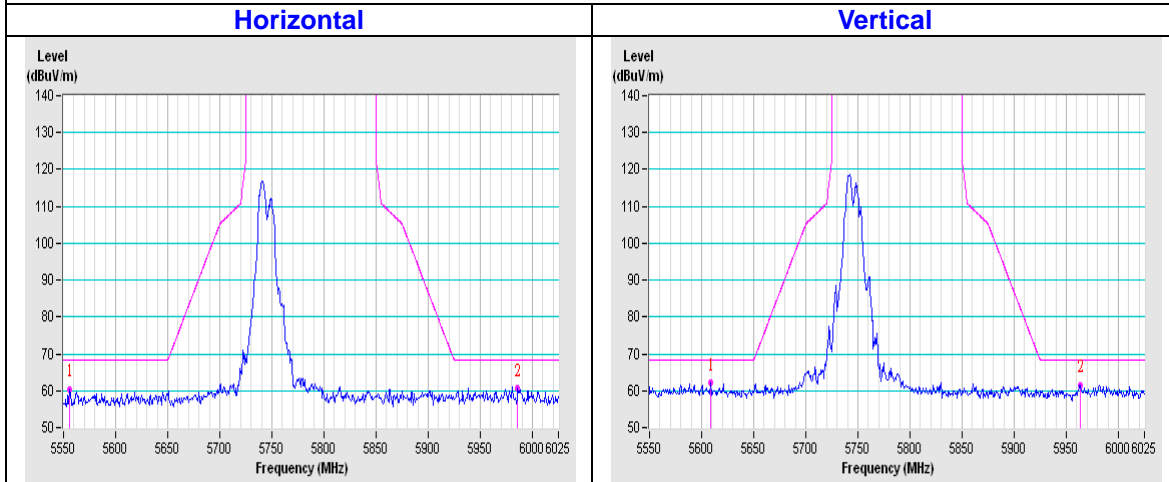

CH157

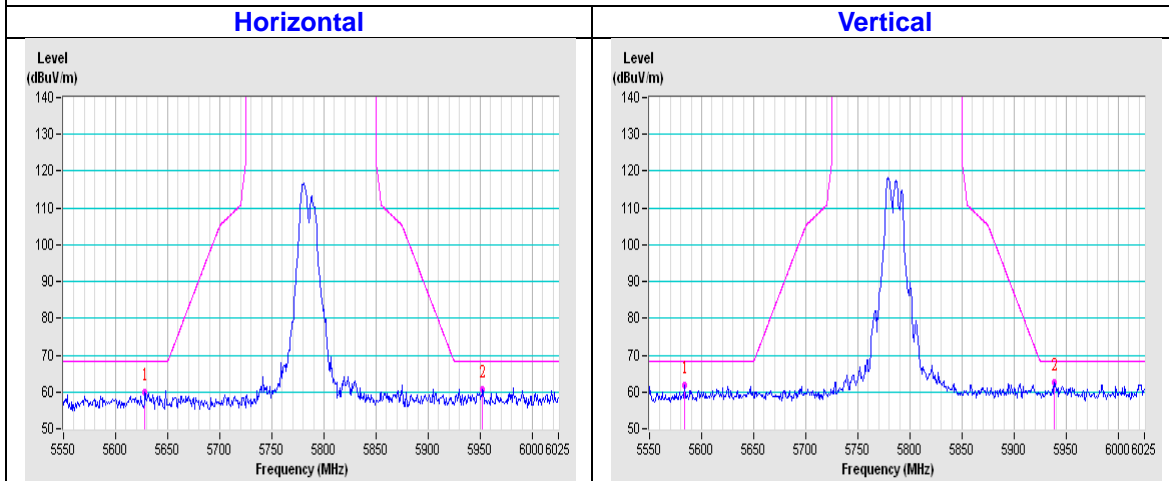

CH165

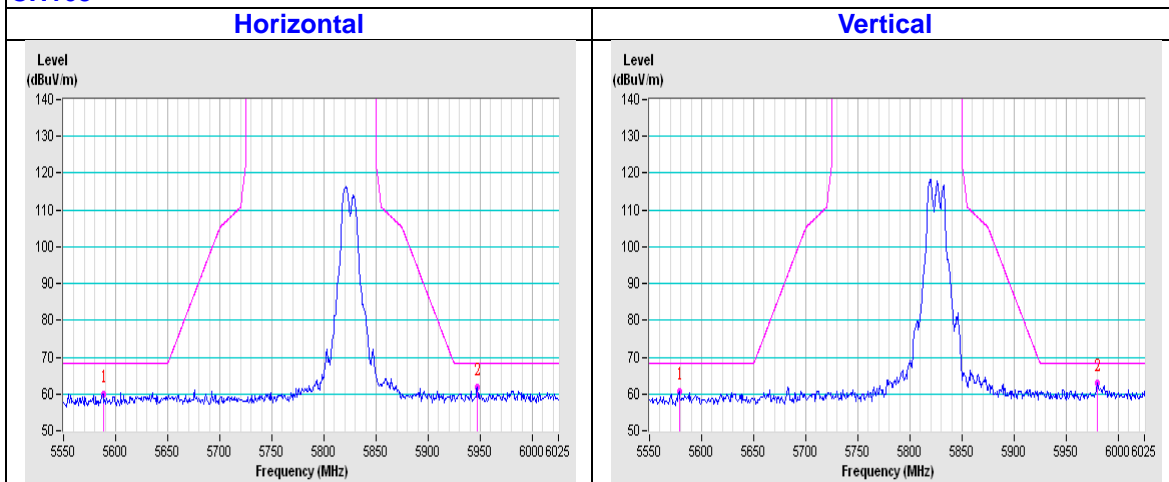

802.11ac (VHT20)

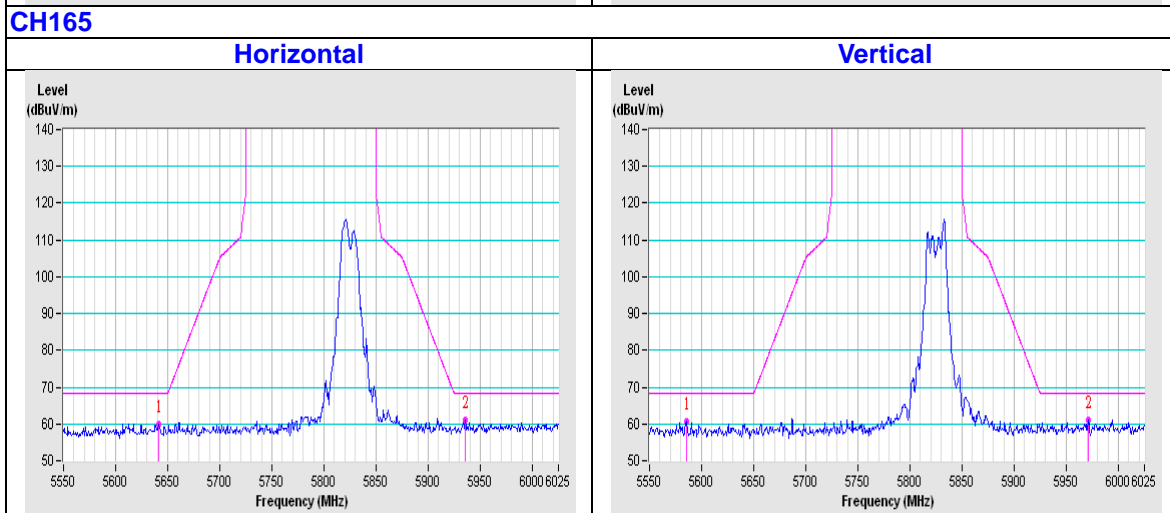
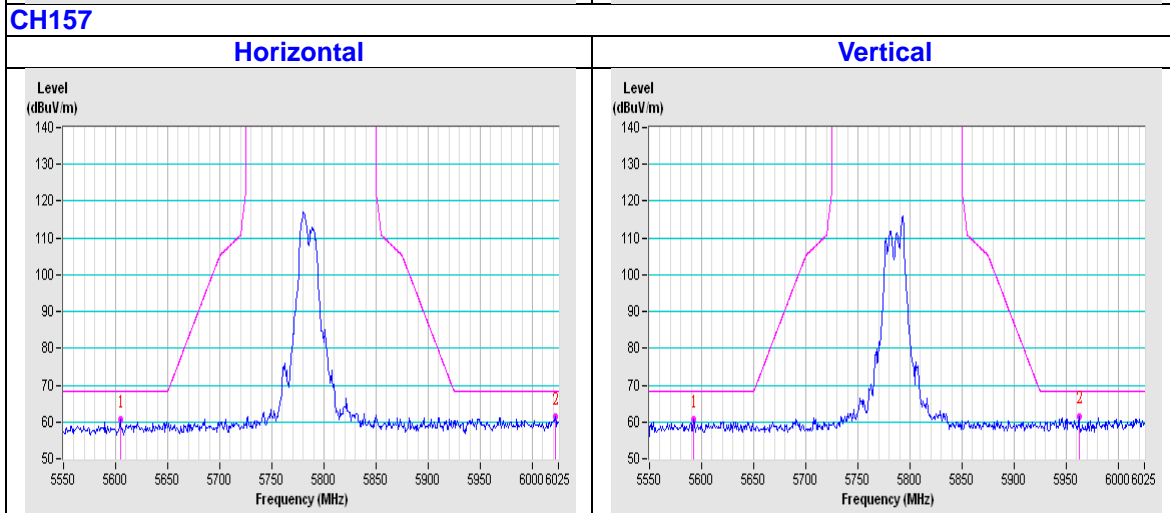
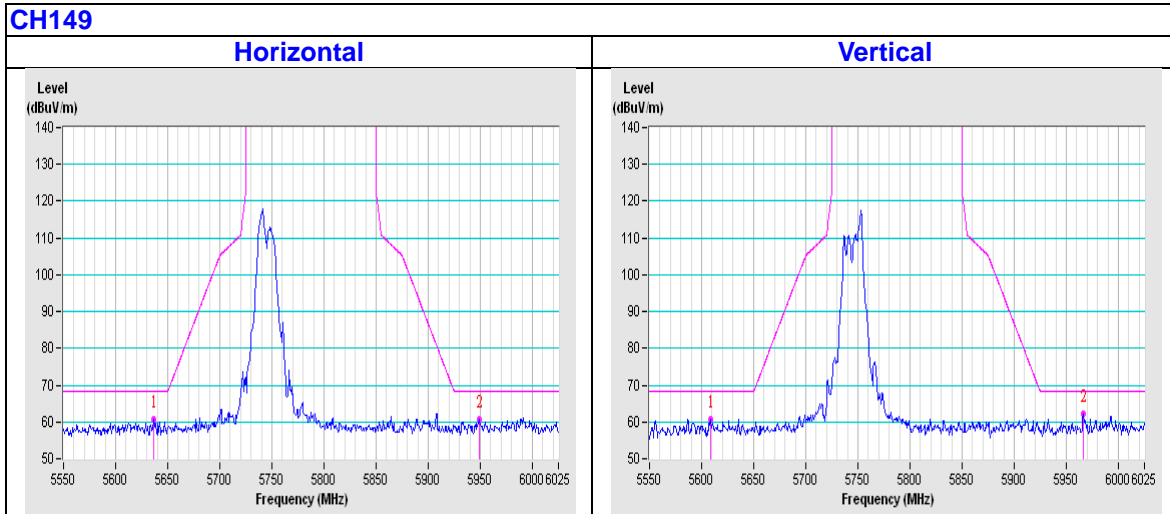

802.11ac (VHT40)

CH151

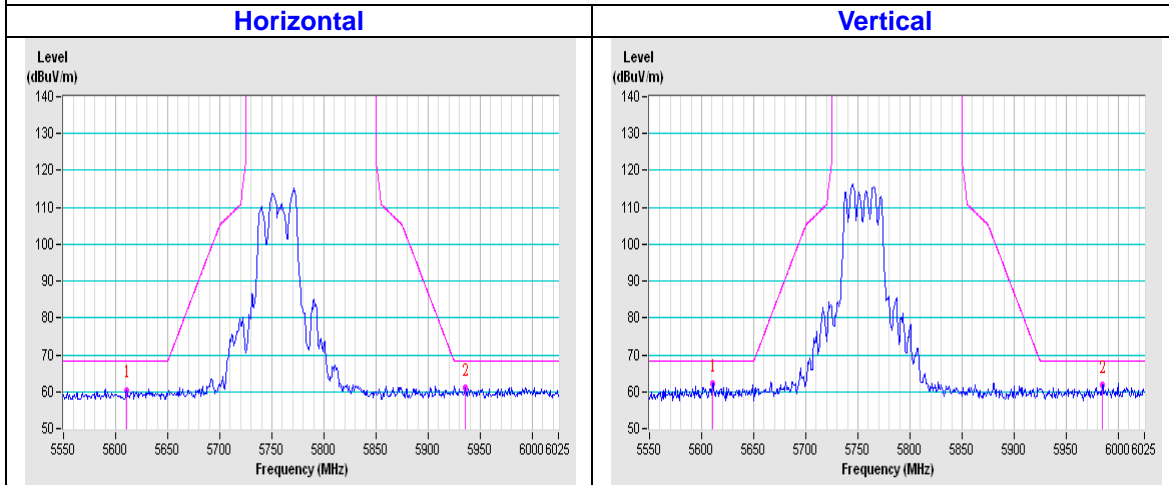

CH159

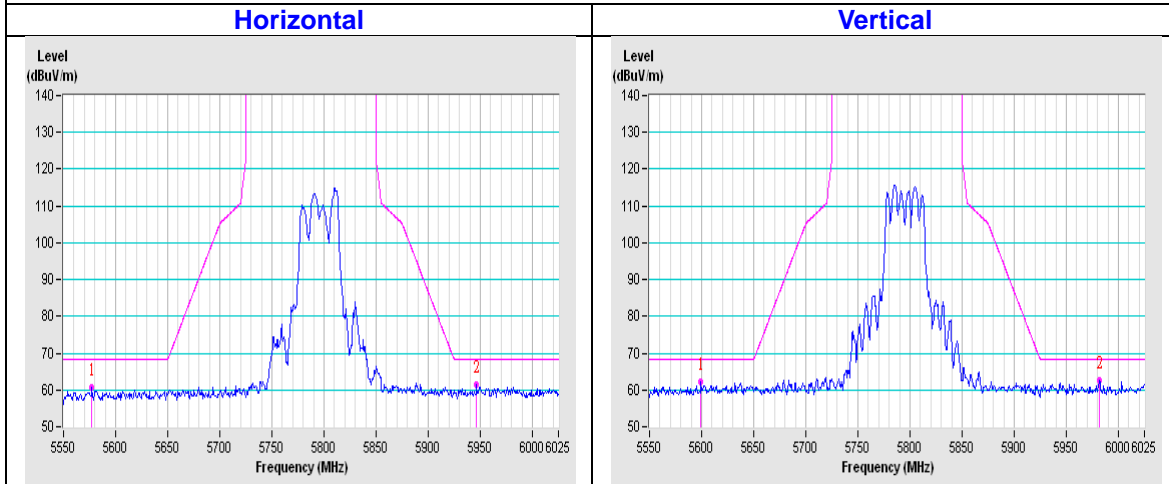

802.11ac (VHT80)

CH155

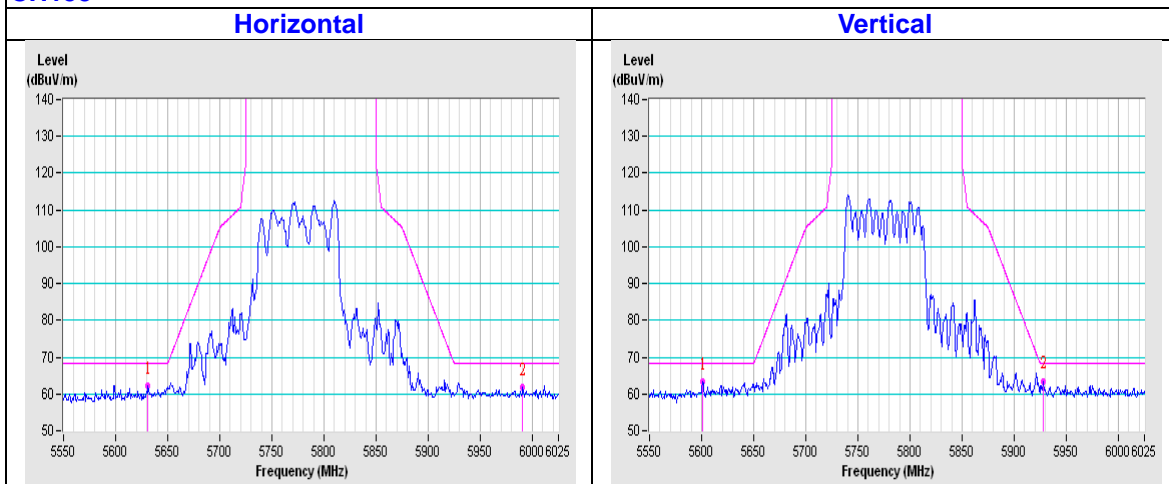

Appendix – Information on the Testing Laboratories

We, Bureau Veritas Consumer Products Services (H.K.) Ltd., Taoyuan Branch, were founded in 1988 to provide our best service in EMC, Radio, Telecom and Safety consultation. Our laboratories are FCC recognized accredited test firms and accredited according to ISO/IEC 17025.

If you have any comments, please feel free to contact us at the following:

Linko EMC/RF Lab

Tel: 886-2-26052180

Fax: 886-2-26051924

Hsin Chu EMC/RF/Telecom Lab

Tel: 886-3-6668565

Fax: 886-3-6668323

Hwa Ya EMC/RF/Safety Lab

Tel: 886-3-3183232

Fax: 886-3-3270892

Email: service.adt@tw.bureauveritas.com

Web Site: www.bureauveritas-adt.com

The address and road map of all our labs can be found in our web site also.

--- END ---