

# User's Guide

## NWA/WAC Series

802.11 a/b/g/n/ac Unified Access Point

### Default Login Details

LAN IP Address	DHCP-assigned OR <a href="http://192.168.1.2">http://192.168.1.2</a>
User Name	admin
Password	1234

Version 5.10 Edition 1, 10/2017

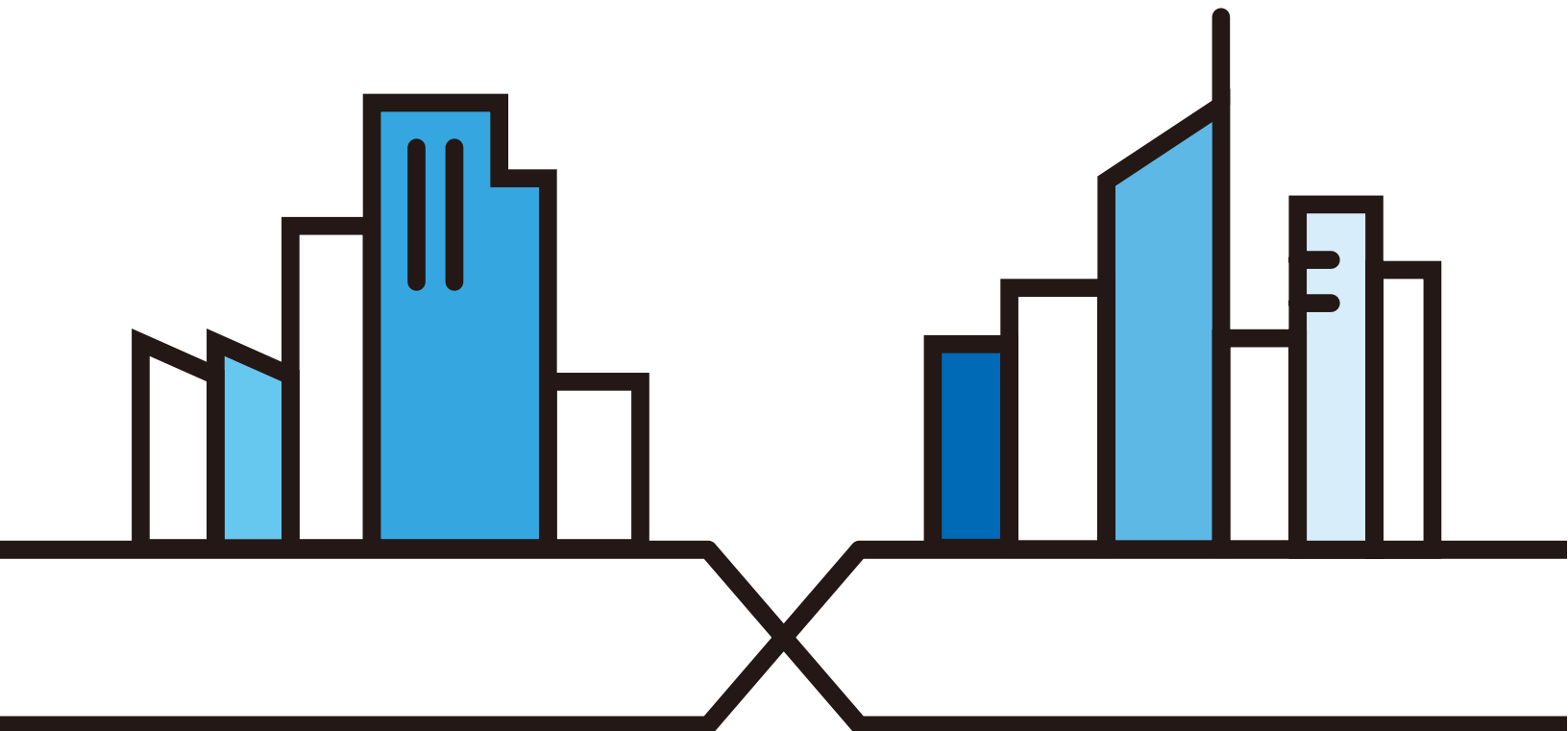

---

## IMPORTANT!

READ CAREFULLY BEFORE USE.

KEEP THIS GUIDE FOR FUTURE REFERENCE.

This is a User's Guide for a series of products. Not all products support all firmware features. Screenshots and graphics in this book may differ slightly from your product due to differences in your product firmware or your computer operating system. Every effort has been made to ensure that the information in this manual is accurate.

### Related Documentation

- Quick Start Guide

The Quick Start Guide shows how to connect the NWA/WAC and access the Web Configurator.

- CLI Reference Guide

The CLI Reference Guide explains how to use the Command-Line Interface (CLI) and CLI commands to configure the NWA/WAC.

Note: It is recommended you use the Web Configurator to configure the NWA/WAC.

- Web Configurator Online Help

Click the help icon in any screen for help in configuring that screen and supplementary information.

- More Information

Go to [support.zyxel.com](http://support.zyxel.com) to find other information on the NWA/WAC.



# Document Conventions

## Warnings and Notes

These are how warnings and notes are shown in this guide.

**Warnings tell you about things that could harm you or your device.**









Note: Notes tell you other important information (for example, other things you may need to configure or helpful tips) or recommendations.

## Syntax Conventions

- All models in this series may be referred to as the “NWA/WAC” in this guide.
- Product labels, screen names, field labels and field choices are all in **bold** font.
- A right angle bracket ( > ) within a screen name denotes a mouse click. For example, **Configuration > Network > IP Setting** means you first click **Configuration** in the navigation panel, then the **Network** sub menu and finally the **IP Setting** tab to get to that screen.

## Icons Used in Figures

Figures in this guide may use the following generic icons. The NWA/WAC icon is not an exact representation of your device.

NWA/WAC 	Router 	Switch 	Internet 
Server 	Desktop 	Laptop 	AP Controller 

# Contents Overview

<b>User's Guide</b> .....	<b>12</b>
Introduction .....	13
The Web Configurator .....	35
Setup Wizard .....	47
<b>Technical Reference</b> .....	<b>53</b>
Dashboard .....	54
Monitor .....	60
Network .....	75
Wireless .....	84
Bluetooth .....	97
User .....	100
AP Profile .....	107
MON Profile .....	126
WDS Profile .....	130
Certificates .....	132
System .....	148
Log and Report .....	173
File Manager .....	185
Diagnostics .....	196
LEDs .....	198
Antenna Switch .....	200
Reboot .....	202
Shutdown .....	203
Troubleshooting .....	204

# Table of Contents

<b>Document Conventions .....</b>	<b>3</b>
<b>Contents Overview .....</b>	<b>4</b>
<b>Table of Contents .....</b>	<b>5</b>
<b>Part I: User's Guide.....</b>	<b>12</b>
<b>Chapter 1</b>	
<b>Introduction.....</b>	<b>13</b>
1.1 Overview .....	13
1.1.1 Management Mode .....	17
1.1.2 MBSSID .....	18
1.1.3 Dual-Radio .....	19
1.1.4 Root AP .....	19
1.1.5 Repeater .....	20
1.2 Ways to Manage the NWA/WAC .....	21
1.3 Good Habits for Managing the NWA/WAC .....	22
1.4 Hardware Connections .....	22
1.5 NWA5301-NJ Hardware .....	22
1.5.1 110 Punch-Down Block .....	22
1.5.2 Phone Port .....	24
1.5.3 Console Port .....	24
1.6 LEDs .....	25
1.6.1 WAC6502D-E, WAC6502D-S, and WAC6503D-S .....	25
1.6.2 NWA1123-AC PRO and WAC6103D-I .....	27
1.6.3 NWA5301-NJ .....	29
1.6.4 NWA1123-ACv2, NWA5121-N, NWA5121-NI, NWA5123-AC and NWA5123-NI .....	30
1.6.5 WAC5302D-S .....	31
1.6.6 NWA1123-AC HD, NWA5123-AC HD and WAC6303D-S .....	32
1.7 Starting and Stopping the NWA/WAC .....	33
<b>Chapter 2</b>	
<b>The Web Configurator.....</b>	<b>35</b>
2.1 Overview .....	35
2.2 Accessing the Web Configurator .....	35
2.3 Navigating the Web Configurator .....	36
2.3.1 Title Bar .....	37

2.3.2 Navigation Panel .....	40
2.3.3 Warning Messages .....	43
2.3.4 Tables and Lists .....	43
<b>Chapter 3</b>	
<b>Setup Wizard.....</b>	<b>47</b>
3.1 Accessing the Wizard .....	47
3.2 Using the Wizard .....	47
3.2.1 Country Code .....	47
3.2.2 Time Zone .....	48
3.2.3 Uplink .....	48
3.2.4 Radio .....	49
3.2.5 SSID .....	50
3.2.6 Summary .....	52
<b>Part II: Technical Reference.....</b>	<b>53</b>
<b>Chapter 4</b>	
<b>Dashboard.....</b>	<b>54</b>
4.1 Overview .....	54
4.1.1 What You Can Do in this Chapter .....	54
4.2 Dashboard .....	54
4.2.1 CPU Usage .....	58
4.2.2 Memory Usage .....	59
<b>Chapter 5</b>	
<b>Monitor.....</b>	<b>60</b>
5.1 Overview .....	60
5.1.1 What You Can Do in this Chapter .....	60
5.2 What You Need to Know .....	60
5.3 Network Status .....	61
5.3.1 Port Statistics Graph .....	63
5.4 Radio List .....	64
5.4.1 AP Mode Radio Information .....	65
5.5 Station List .....	67
5.6 WDS Link Info .....	68
5.7 Detected Device .....	69
5.8 View Log .....	72
<b>Chapter 6</b>	
<b>Network.....</b>	<b>75</b>

6.1 Overview .....	75
6.1.1 Management Mode .....	75
6.1.2 What You Can Do in this Chapter .....	77
6.2 IP Setting .....	78
6.3 VLAN .....	79
6.4 AC (AP Controller) Discovery .....	82
<b>Chapter 7</b>	
<b>Wireless .....</b>	<b>84</b>
7.1 Overview .....	84
7.1.1 What You Can Do in this Chapter .....	84
7.1.2 What You Need to Know .....	85
7.2 AP Management .....	85
7.3 Rogue AP .....	88
7.3.1 Add/Edit Rogue/Friendly List .....	90
7.4 Load Balancing .....	91
7.4.1 Disassociating and Delaying Connections .....	93
7.5 DCS .....	94
7.6 Technical Reference .....	94
<b>Chapter 8</b>	
<b>Bluetooth.....</b>	<b>97</b>
8.1 Overview .....	97
8.1.1 What You Need To Know .....	97
8.2 Bluetooth Advertising Settings .....	97
8.2.1 Edit Advertising Settings .....	98
<b>Chapter 9</b>	
<b>User.....</b>	<b>100</b>
9.1 Overview .....	100
9.1.1 What You Can Do in this Chapter .....	100
9.1.2 What You Need To Know .....	100
9.2 User Summary .....	101
9.2.1 Add/Edit User .....	101
9.3 Setting .....	103
9.3.1 Edit User Authentication Timeout Settings .....	105
<b>Chapter 10</b>	
<b>AP Profile.....</b>	<b>107</b>
10.1 Overview .....	107
10.1.1 What You Can Do in this Chapter .....	107
10.1.2 What You Need To Know .....	107
10.2 Radio .....	108

---

10.2.1 Add/Edit Radio Profile .....	109
10.3 SSID .....	114
10.3.1 SSID List .....	114
10.3.2 Add/Edit SSID Profile .....	115
10.4 Security List .....	118
10.4.1 Add/Edit Security Profile .....	118
10.5 MAC Filter List .....	121
10.5.1 Add/Edit MAC Filter Profile .....	122
10.6 Layer-2 Isolation List .....	123
10.6.1 Add/Edit Layer-2 Isolation Profile .....	124
<b>Chapter 11</b>	
<b>MON Profile.....</b>	<b>126</b>
11.1 Overview .....	126
11.1.1 What You Can Do in this Chapter .....	126
11.2 MON Profile .....	126
11.2.1 Add/Edit MON Profile .....	127
11.3 Technical Reference .....	128
<b>Chapter 12</b>	
<b>WDS Profile.....</b>	<b>130</b>
12.1 Overview .....	130
12.1.1 What You Can Do in this Chapter .....	130
12.2 WDS Profile .....	130
12.2.1 Add/Edit WDS Profile .....	131
<b>Chapter 13</b>	
<b>Certificates .....</b>	<b>132</b>
13.1 Overview .....	132
13.1.1 What You Can Do in this Chapter .....	132
13.1.2 What You Need to Know .....	132
13.1.3 Verifying a Certificate .....	134
13.2 My Certificates .....	135
13.2.1 Add My Certificates .....	136
13.2.2 Edit My Certificates .....	138
13.2.3 Import Certificates .....	141
13.3 Trusted Certificates .....	142
13.3.1 Edit Trusted Certificates .....	143
13.3.2 Import Trusted Certificates .....	146
13.4 Technical Reference .....	147
<b>Chapter 14</b>	
<b>System.....</b>	<b>148</b>



14.1 Overview .....	148
14.1.1 What You Can Do in this Chapter .....	148
14.2 Host Name .....	148
14.3 Date and Time .....	149
14.3.1 Pre-defined NTP Time Servers List .....	152
14.3.2 Time Server Synchronization .....	152
14.4 WWW Overview .....	153
14.4.1 Service Access Limitations .....	153
14.4.2 System Timeout .....	153
14.4.3 HTTPS .....	154
14.4.4 Configuring WWW Service Control .....	154
14.4.5 HTTPS Example .....	155
14.5 SSH .....	163
14.5.1 How SSH Works .....	163
14.5.2 SSH Implementation on the NWA/WAC .....	164
14.5.3 Requirements for Using SSH .....	165
14.5.4 Configuring SSH .....	165
14.5.5 Examples of Secure Telnet Using SSH .....	165
14.6 Telnet .....	167
14.7 FTP .....	167
14.8 SNMP .....	168
14.8.1 Supported MIBs .....	169
14.8.2 SNMP Traps .....	170
14.8.3 Configuring SNMP .....	170
14.8.4 Adding or Editing an SNMPv3 User Profile .....	171

## Chapter 15

### Log and Report.....173

15.1 Overview .....	173
15.1.1 What You Can Do In this Chapter .....	173
15.2 Email Daily Report .....	173
15.3 Log Setting .....	175
15.3.1 Log Setting Screen .....	176
15.3.2 Edit System Log Settings .....	177
15.3.3 Edit Remote Server .....	181
15.3.4 Active Log Summary .....	182

## Chapter 16

### File Manager .....185

16.1 Overview .....	185
16.1.1 What You Can Do in this Chapter .....	185
16.1.2 What you Need to Know .....	185
16.2 Configuration File .....	186

---

16.2.1 Example of Configuration File Download Using FTP .....	190
16.3 Firmware Package .....	191
16.3.1 Example of Firmware Upload Using FTP .....	192
16.4 Shell Script .....	193
<b>Chapter 17</b>	
<b>Diagnostics .....</b>	<b>196</b>
17.1 Overview .....	196
17.1.1 What You Can Do in this Chapter .....	196
17.2 Diagnostics .....	196
<b>Chapter 18</b>	
<b>LEDs .....</b>	<b>198</b>
18.1 Overview .....	198
18.1.1 What You Can Do in this Chapter .....	198
18.2 Suppression Screen .....	198
18.3 Locator Screen .....	199
<b>Chapter 19</b>	
<b>Antenna Switch .....</b>	<b>200</b>
19.1 Overview .....	200
19.1.1 What You Need To Know .....	200
19.2 Antenna Switch Screen .....	200
<b>Chapter 20</b>	
<b>Reboot.....</b>	<b>202</b>
20.1 Overview .....	202
20.1.1 What You Need To Know .....	202
20.2 Reboot .....	202
<b>Chapter 21</b>	
<b>Shutdown .....</b>	<b>203</b>
21.1 Overview .....	203
21.1.1 What You Need To Know .....	203
21.2 Shutdown .....	203
<b>Chapter 22</b>	
<b>Troubleshooting.....</b>	<b>204</b>
22.1 Overview .....	204
22.2 Power, Hardware Connections, and LED .....	204
22.3 NWA/WAC Access and Login .....	205
22.4 Internet Access .....	206
22.5 Wireless Connections .....	207

22.6 Resetting the NWA/WAC .....	212
22.7 Getting More Troubleshooting Help .....	213
Appendix A Importing Certificates .....	214
Appendix B IPv6.....	227
Appendix C Customer Support .....	235
Appendix D Legal Information .....	241
<b>Index .....</b>	<b>254</b>

---

# PART I

## User's Guide

---

# CHAPTER 1

## Introduction

### 1.1 Overview

This User's Guide covers the following models: NWA1123-ACv2, NWA1123-AC PRO, NWA1123-AC HD, NWA5121-N, NWA5121-NI, NWA5123-AC, NWA5123-AC HD, NWA5123-NI, NWA5301-NJ, WAC5302D-S, WAC6103D-I, WAC6303D-S, WAC6502D-E, WAC6502D-S, WAC6503D-S, and WAC6553D-E. Your NWA/WAC is a wireless AP (Access Point). It extends the range of your existing wired network without additional wiring, providing easy network access to mobile users.

Table 1 NWA1123 Series Comparison Table

FEATURES	NWA1123-ACv2	NWA1123-AC PRO	NWA1123-AC HD
Supported Wireless Standards	IEEE 802.11a IEEE 802.11b IEEE 802.11g IEEE 802.11n IEEE 802.11ac	IEEE 802.11a IEEE 802.11b IEEE 802.11g IEEE 802.11n IEEE 802.11ac	IEEE 802.11a IEEE 802.11b IEEE 802.11g IEEE 802.11n IEEE 802.11ac
Supported Frequency Bands	2.4 GHz 5 GHz	2.4 GHz 5 GHz	2.4 GHz 5 GHz
Available Security Modes	None WEP WPA2 WPA2-MIX WPA2-PSK WPA2-PSK-MIX	None WEP WPA2 WPA2-MIX WPA2-PSK WPA2-PSK-MIX	None WEP WPA2 WPA2-MIX WPA2-PSK WPA2-PSK-MIX
Number of SSID Profiles	64	64	64
Number of Wireless Radios	2	2	2
Monitor Mode & Rogue APs Containment	Yes	Yes	No
Rogue APs Detection	Yes	Yes	Yes
WDS (Wireless Distribution System) - Root AP & Repeater Modes	Yes	Yes	No
Tunnel Forwarding Mode	No	No	No
Layer-2 Isolation	Yes	Yes	Yes
Power Detection	No	No	No
External Antennas	No	No	No
Internal Antennas	Yes	Yes	Yes
Antenna Switch	No	Yes	No
LED Locator	No	Yes	Yes

Table 1 NWA1123 Series Comparison Table

FEATURES	NWA1123-ACv2	NWA1123-AC PRO	NWA1123-AC HD
CAPWAP Managed AP Mode	No	No	No
AC (AP Controller) Discovery	No	No	No
802.11r Fast Roaming Support in Managed AP Mode	No	No	No
Bluetooth Low Energy (BLE)	No	No	No
Maximum number of log messages	512 event logs or 1024 debug logs		

Table 2 NWA5000 Series Comparison Table

FEATURES	NWA5121-N	NWA5121-NI	NWA5123-AC	NWA5123-AC HD	NWA5123-NI	NWA5301-NJ
Supported Wireless Standards	IEEE 802.11b IEEE 802.11g IEEE 802.11n	IEEE 802.11b IEEE 802.11g IEEE 802.11n	IEEE 802.11a IEEE 802.11b IEEE 802.11g IEEE 802.11n IEEE 802.11ac	IEEE 802.11a IEEE 802.11b IEEE 802.11g IEEE 802.11n IEEE 802.11ac	IEEE 802.11a IEEE 802.11b IEEE 802.11g IEEE 802.11n	IEEE 802.11b IEEE 802.11g IEEE 802.11n
Supported Frequency Bands	2.4 GHz	2.4 GHz	2.4 GHz 5 GHz	2.4 GHz 5 GHz	2.4 GHz 5 GHz	2.4 GHz
Available Security Modes	None WEP WPA2 WPA2-MIX WPA2-PSK WPA2-PSK-MIX	None WEP WPA2 WPA2-MIX WPA2-PSK WPA2-PSK-MIX	None WEP WPA2 WPA2-MIX WPA2-PSK WPA2-PSK-MIX	None WEP WPA2 WPA2-MIX WPA2-PSK WPA2-PSK-MIX	None WEP WPA2 WPA2-MIX WPA2-PSK WPA2-PSK-MIX	None WEP WPA2 WPA2-MIX WPA2-PSK WPA2-PSK-MIX
Number of SSID Profiles	64	64	64	64	64	64
Number of Wireless Radios	1	1	2	2	2	1
Monitor Mode & Rogue APs Containment	Yes	Yes	Yes	No	Yes	No
Rogue APs Detection	Yes	Yes	Yes	Yes	Yes	Yes
WDS (Wireless Distribution System) - Root AP & Repeater Modes	Yes	Yes	Yes	No	Yes	Yes
Tunnel Forwarding Mode	No	No	No	No	No	No
Layer-2 Isolation	Yes	Yes	Yes	Yes	Yes	Yes
Power Detection	No	No	No	No	No	No
External Antennas	Yes	No	No	No	No	No
Internal Antennas	No	Yes	Yes	Yes	Yes	Yes
Antenna Switch	No	No	No	No	No	No
LED Locator	No	No	No	Yes	No	No
CAPWAP Managed AP Mode	Yes	Yes	Yes	Yes	Yes	Yes

Table 2 NWA5000 Series Comparison Table

FEATURES	NWA5121-N	NWA5121-NI	NWA5123-AC	NWA5123-AC HD	NWA5123-NI	NWA5301-NJ
AC (AP Controller) Discovery	Yes	Yes	Yes	Yes	Yes	Yes
802.11r Fast Roaming Support in Managed AP Mode	Yes	Yes	Yes	Yes	Yes	Yes
Bluetooth Low Energy (BLE)	No	No	No	No	No	No
Maximum number of log messages	256 event logs or 1 debug logs	256 event logs or 1 debug logs	512 event logs or 1024 debug logs	512 event logs or 1024 debug logs	256 event logs or 1 debug logs	256 event logs or 1 debug logs

Table 3 WAC5000/6000 Series Comparison Table

FEATURES	WAC5302D-S	WAC6103D-I	WAC6303D-S
Supported Wireless Standards	IEEE 802.11a IEEE 802.11b IEEE 802.11g IEEE 802.11n IEEE 802.11ac	IEEE 802.11a IEEE 802.11b IEEE 802.11g IEEE 802.11n IEEE 802.11ac	IEEE 802.11a IEEE 802.11b IEEE 802.11g IEEE 802.11n IEEE 802.11ac
Supported Frequency Bands	2.4 GHz 5 GHz	2.4 GHz 5 GHz	2.4 GHz 5 GHz
Available Security Modes	None WEP WPA2 WPA2-MIX WPA2-PSK WPA2-PSK-MIX	None WEP WPA2 WPA2-MIX WPA2-PSK WPA2-PSK-MIX	None WEP WPA2 WPA2-MIX WPA2-PSK WPA2-PSK-MIX
Number of SSID Profiles	64	64	64
Number of Wireless Radios	2	2	2
Monitor Mode & Rogue APs Containment	No	Yes	No
Rogue APs Detection	Yes	Yes	Yes
WDS (Wireless Distribution System) - Root AP & Repeater Modes	No	Yes	Yes
Tunnel Forwarding Mode	No	Yes	Yes
Layer-2 Isolation	Yes	Yes	Yes
Power Detection	Yes	No	Yes
External Antennas	No	No	No
Internal Antennas	Yes	Yes	Yes
Antenna Switch	No	Yes	No
LED Locator	No	Yes	Yes
CAPWAP Managed AP Mode	Yes	Yes	Yes
AC (AP Controller) Discovery	Yes	Yes	Yes

Table 3 WAC5000/6000 Series Comparison Table

FEATURES	WAC5302D-S	WAC6103D-I	WAC6303D-S
802.11r Fast Roaming Support in Managed AP Mode	No	Yes	Yes
Bluetooth Low Energy (BLE)	Yes	No	Yes
Maximum number of log messages	256 event logs or 1 debug logs	512 event logs or 1024 debug logs	512 event logs or 1024 debug logs

Table 4 WAC6500 Series Comparison Table

FEATURES	WAC6502D-E	WAC6502D-S	WAC6503D-S	WAC6553D-E
Supported Wireless Standards	IEEE 802.11a IEEE 802.11b IEEE 802.11g IEEE 802.11n IEEE 802.11ac	IEEE 802.11a IEEE 802.11b IEEE 802.11g IEEE 802.11n IEEE 802.11ac	IEEE 802.11a IEEE 802.11b IEEE 802.11g IEEE 802.11n IEEE 802.11ac	IEEE 802.11a IEEE 802.11b IEEE 802.11g IEEE 802.11n IEEE 802.11ac
Supported Frequency Bands	2.4 GHz 5 GHz	2.4 GHz 5 GHz	2.4 GHz 5 GHz	2.4 GHz 5 GHz
Available Security Modes	None WEP WPA2 WPA2-MIX WPA2-PSK WPA2-PSK-MIX	None WEP WPA2 WPA2-MIX WPA2-PSK WPA2-PSK-MIX	None WEP WPA2 WPA2-MIX WPA2-PSK WPA2-PSK-MIX	None WEP WPA2 WPA2-MIX WPA2-PSK WPA2-PSK-MIX
Number of SSID Profiles	64	64	64	64
Number of Wireless Radios	2	2	2	2
Monitor Mode & Rogue APs Containment	Yes	Yes	Yes	Yes
Rogue APs Detection	Yes	Yes	Yes	Yes
WDS (Wireless Distribution System) - Root AP & Repeater Modes	Yes	Yes	Yes	Yes
Tunnel Forwarding Mode	Yes	Yes	Yes	Yes
Layer-2 Isolation	Yes	Yes	Yes	Yes
Power Detection	Yes	Yes	Yes	Yes
External Antennas	Yes	No	No	Yes
Internal Antennas	No	Yes	Yes	No
Antenna Switch	No	No	No	No
LED Locator	Yes	Yes	Yes	Yes
CAPWAP Managed AP Mode	Yes	Yes	Yes	Yes
AC (AP Controller) Discovery	Yes	Yes	Yes	Yes
802.11r Fast Roaming Support in Managed AP Mode	Yes	Yes	Yes	Yes



Table 4 WAC6500 Series Comparison Table

FEATURES	WAC6502D-E	WAC6502D-S	WAC6503D-S	WAC6553D-E
Bluetooth Low Energy (BLE)	No	No	No	No
Maximum number of log messages	512 event logs or 1024 debug logs			

You can set the NWA/WAC to operate in either standalone AP or managed AP mode. When the NWA/WAC is in standalone AP mode, it can serve as a normal AP, as an RF monitor to search for rogue APs to help eliminate network threats (if it supports monitor mode and rogue APs detection/containment), or even as a root AP or a wireless repeater to establish wireless links with other APs in a WDS (Wireless Distribution System). A WDS is a wireless connection between two or more APs.

Your NWA/WAC's business-class reliability, SMB features, and centralized wireless management make it ideally suited for advanced service delivery in mission-critical networks. It uses Multiple BSSID and VLAN to provide simultaneous independent virtual APs. Additionally, innovations in roaming technology and QoS features eliminate voice call disruptions.

The NWA/WAC controls network access with Media Access Control (MAC) address filtering, and rogue Access Point (AP) detection. It also provides a high level of network traffic security, supporting IEEE 802.1x, Wi-Fi Protected Access 2 and Wired Equivalent Privacy (WEP) data encryption.

Your NWA/WAC is easy to install, configure and use. The embedded Web-based configurator enables simple, straightforward management and maintenance. See the Quick Start Guide for how to make hardware connections.

## 1.1.1 Management Mode

The NWA/WAC is a unified AP and can work either in standalone AP mode or in managed AP mode. If the NWA/WAC and a Zyxel AP controller, such as the NXC2500 or NXC5500, are in the same subnet, it will be managed by the controller automatically.

An AP controller uses Control And Provisioning of Wireless Access Points (CAPWAP, see RFC 5415) to discover and configure multiple managed APs.

To set the NWA/WAC to be managed by an AP controller in a different subnet or change between management modes, use the **AC (AP Controller) Discovery** screen (see [Section 6.4 on page 82](#)).

Table 5 NWA/WAC Management Mode Comparison

MANAGEMENT MODE	DEFAULT IP ADDRESS	UPLOAD FIRMWARE VIA
Standalone AP	Dynamic or Static (192.168.1.2)	Web Configurator or FTP
Managed AP	Dynamic	CAPWAP or FTP

When the NWA/WAC is in standalone AP mode and connects to a DHCP server, it uses the IP address assigned by the DHCP server. Otherwise, the NWA/WAC uses the default static management IP address (192.168.1.2). You can use the **AC Discovery** screen to have the NWA/WAC work as a managed AP.

When the NWA/WAC is in managed AP mode, it acts as a DHCP client and obtains an IP address from the AP controller. It can be configured ONLY by the AP controller. To change the NWA/WAC back to standalone AP mode, use the **Reset** button to restore the default configuration. Alternatively, you need to check the AP controller for the NWA/WAC's IP address and use FTP to upload the default configuration file at conf/system-default.conf to the NWA/WAC and reboot the device.

## 1.1.2 MBSSID

A Basic Service Set (BSS) is the set of devices forming a single wireless network (usually an access point and one or more wireless clients). The Service Set Identifier (SSID) is the name of a BSS. In Multiple BSS (MBSSID) mode, the NWA/WAC provides multiple virtual APs, each forming its own BSS and using its own individual SSID profile.

You can configure multiple SSID profiles, and have all of them active at any one time.

You can assign different wireless and security settings to each SSID profile. This allows you to compartmentalize groups of users, set varying access privileges, and prioritize network traffic to and from certain BSSs.

To the wireless clients in the network, each SSID appears to be a different access point. As in any wireless network, clients can associate only with the SSIDs for which they have the correct security settings.

For example, you might want to set up a wireless network in your office where Internet telephony (VoIP) users have priority. You also want a regular wireless network for standard users, as well as a 'guest' wireless network for visitors. In the following figure, **VoIP\_SSID** users have QoS priority, **SSID01** is the wireless network for standard users, and **Guest\_SSID** is the wireless network for guest users. In this example, the guest user is forbidden access to the wired Land Area Network (LAN) behind the AP and can access only the Internet.

**Figure 1** Multiple BSSs

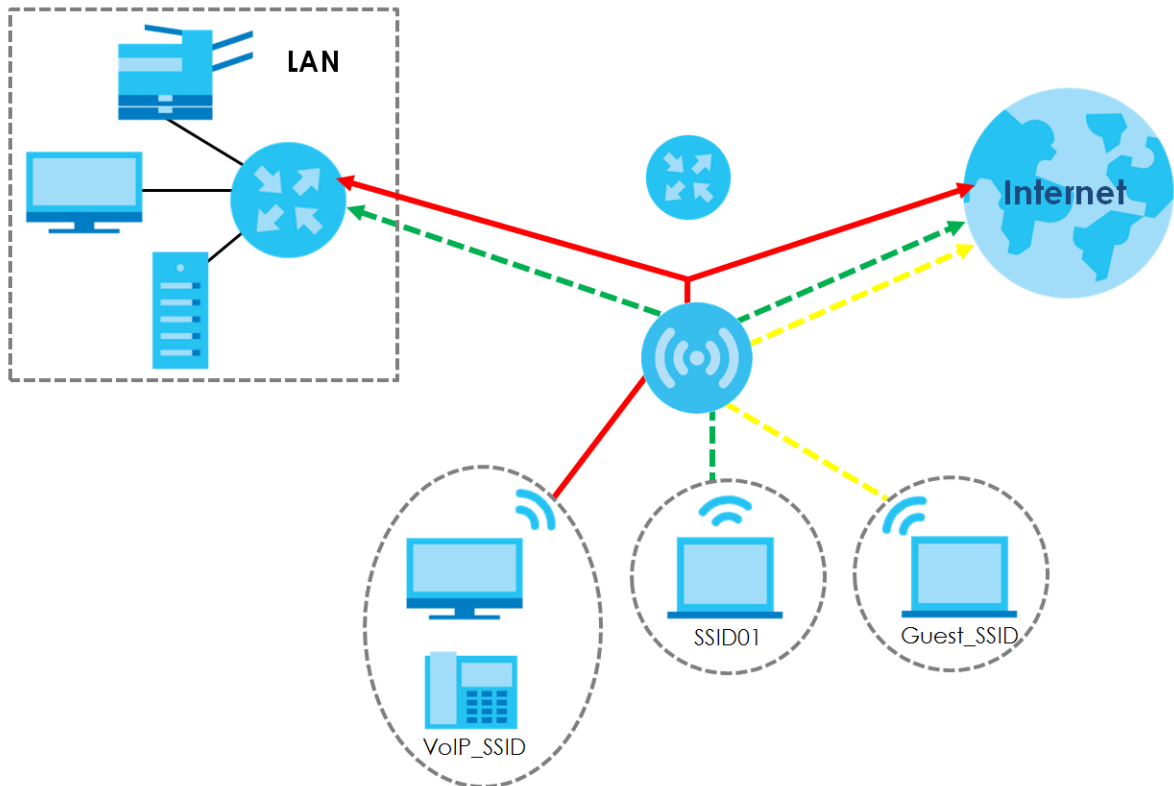

### 1.1.3 Dual-Radio

Some of the NWA/WAC models are equipped with dual wireless radios. This means you can configure two different wireless networks to operate simultaneously.

Note: A different channel should be configured for each WLAN interface to reduce the effects of radio interference.

You could use the 2.4 GHz band for regular Internet surfing and downloading while using the 5 GHz band for time sensitive traffic like high-definition video, music, and gaming.

**Figure 2** Dual-Radio Application

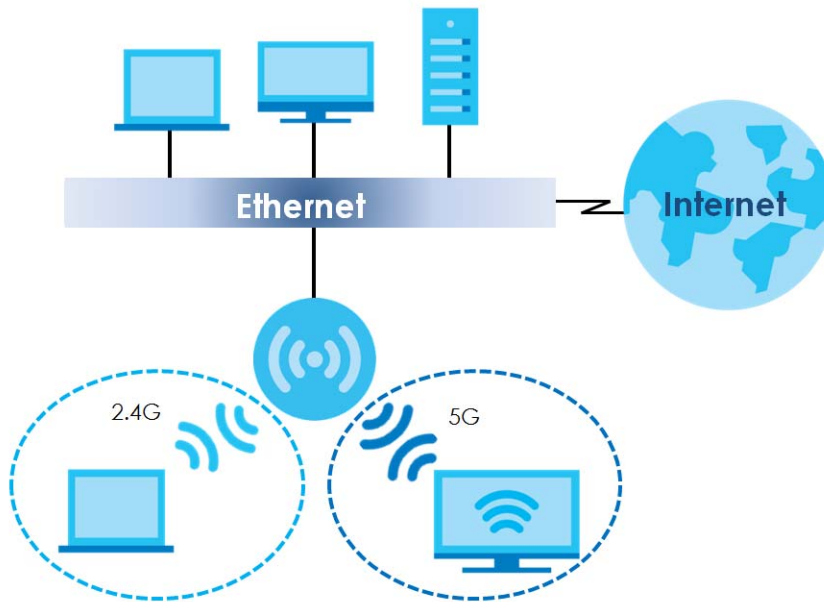

### 1.1.4 Root AP

In Root AP mode, the NWA/WAC (Z) can act as the root AP in a wireless network and also allow repeaters (X and Y) to extend the range of its wireless network at the same time. In the figure below, both clients A, B and C can access the wired network through the root AP.

Figure 3 Root AP Application

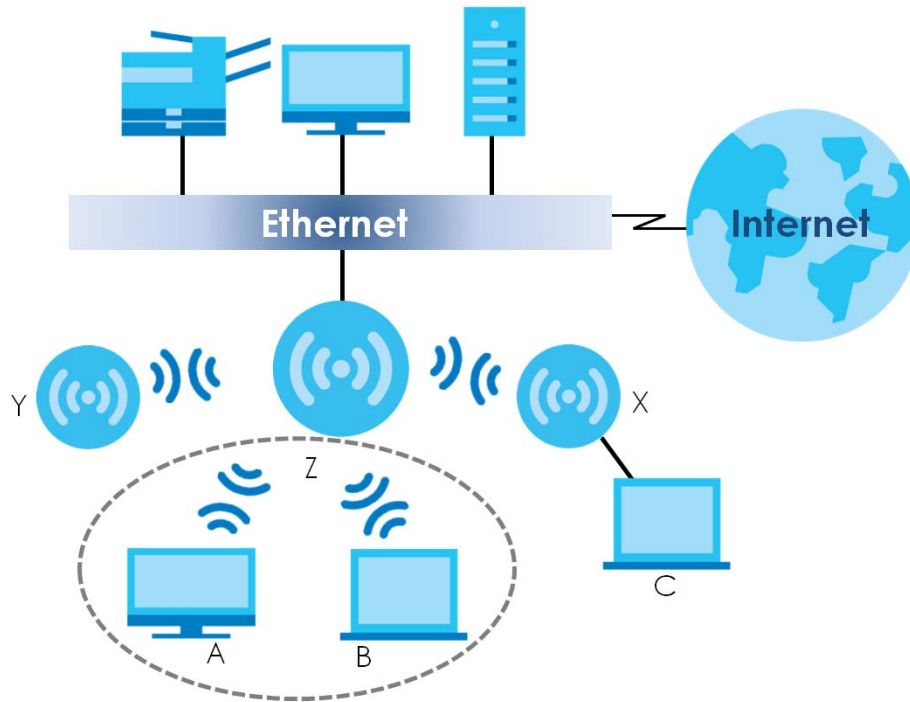

On the NWA/WAC in Root AP mode, you can have multiple SSIDs active for regular wireless connections and one SSID for the connection with a repeater (repeater SSID). Wireless clients can use either SSID to associate with the NWA/WAC in Root AP mode. A repeater must use the repeater SSID to connect to the NWA/WAC in Root AP mode.

When the NWA/WAC is in Root AP mode, repeater security between the NWA/WAC and other repeater is independent of the security between the wireless clients and the AP or repeater. When repeater security is enabled, both APs and repeaters must use the same pre-shared key. See [Section 7.2 on page 85](#) and [Section 12.2 on page 130](#) for more details.

Unless specified, the term "security settings" refers to the traffic between the wireless clients and the AP. At the time of writing, repeater security is compatible with the NWA/WAC only.

## 1.1.5 Repeater

The NWA/WAC can act as a wireless network repeater to extend a root AP's wireless network range, and also establish wireless connections with wireless clients.

Using Repeater mode, your NWA/WAC can extend the range of the WLAN. In the figure below, the NWA/WAC in Repeater mode (**Z**) has a wireless connection to the NWA/WAC in Root AP mode (**X**) which is connected to a wired network and also has a wireless connection to another NWA/WAC in Repeater mode (**Y**) at the same time. **Z** and **Y** act as repeaters that forward traffic between associated wireless clients and the wired LAN. Clients **A** and **B** access the AP and the wired network behind the AP through repeaters **Z** and **Y**.

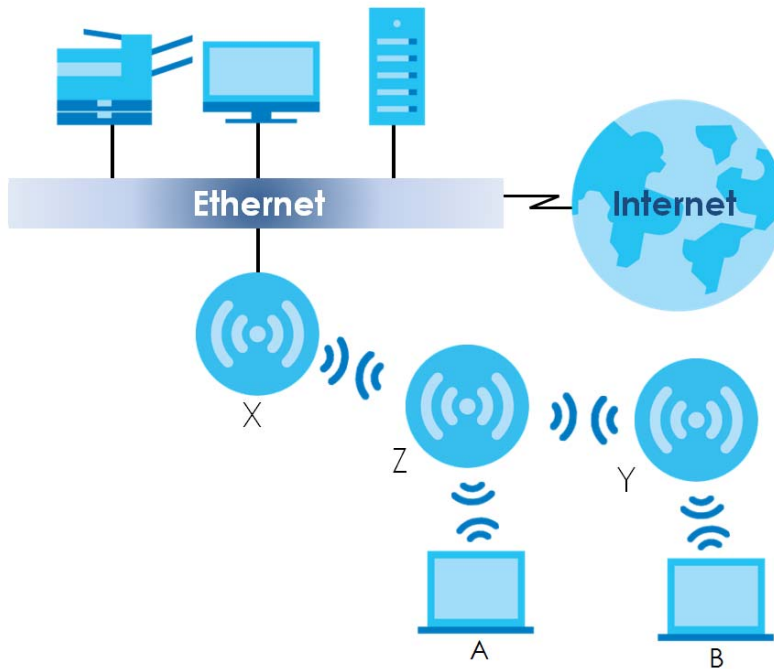
**Figure 4** Repeater Application

When the NWA/WAC is in Repeater mode, repeater security between the NWA/WAC and other repeater is independent of the security between the wireless clients and the AP or repeater. When repeater security is enabled, both APs and repeaters must use the same pre-shared key. See [Section 7.2 on page 85](#) and [Section 12.2 on page 130](#) for more details.

Once the security settings of peer sides match one another, the connection between devices is made.

At the time of writing, repeater security is compatible with the NWA/WAC only.

## 1.2 Ways to Manage the NWA/WAC

You can use the following ways to manage the NWA/WAC.

### Web Configurator

The Web Configurator allows easy NWA/WAC setup and management using an Internet browser. This User's Guide provides information about the Web Configurator.

### Command-Line Interface (CLI)

The CLI allows you to use text-based commands to configure the NWA/WAC. You can access it using remote management (for example, SSH or Telnet). See the Command Reference Guide for more information.

### File Transfer Protocol (FTP)

This protocol can be used for firmware upgrades and configuration backup and restore.

## Simple Network Management Protocol (SNMP)

The NWA/WAC can be monitored by an SNMP manager. See the SNMP chapter in this User's Guide.

## 1.3 Good Habits for Managing the NWA/WAC

Do the following things regularly to make the NWA/WAC more secure and to manage it more effectively.

- Change the password often. Use a password that's not easy to guess and that consists of different types of characters, such as numbers and letters.
- Write down the password and put it in a safe place.
- Back up the configuration (and make sure you know how to restore it). Restoring an earlier working configuration may be useful if the device becomes unstable or even crashes. If you forget your password, you will have to reset the NWA/WAC to its factory default settings. If you backed up an earlier configuration file, you won't have to totally re-configure the NWA/WAC; you can simply restore your last configuration.

## 1.4 Hardware Connections

See your Quick Start Guide for information on making hardware connections.

## 1.5 NWA5301-NJ Hardware

### 1.5.1 110 Punch-Down Block

This section shows you how to use a punch-down tool to seat an 8-wire Ethernet cable to the 110 punch-down block. You can connect a PoE switch to the 110 punch-down block to provide power and Internet access to the NWA through this connection. An 8-pin Ethernet cable has four pairs of color coded wires.

- 1 Cut out one and a half inches of the jacket from the Ethernet cable to expose the wires.
- 2 Untwist the wire pairs no more than one inch.
- 3 Match each wire to the correct slot according to the color codes for wiring shown below.

**NWA Rear Panel**

Table 6 Color Codes for 110 Punch Down Block Wiring

PIN#	WIRE COLOR
1	White/Orange
2	Orange
3	White/Green
4	Blue
5	White/Blue
6	Green
7	White/Brown
8	Brown

- 4 Use a punch-down tool to seat the wires down properly into the slot.

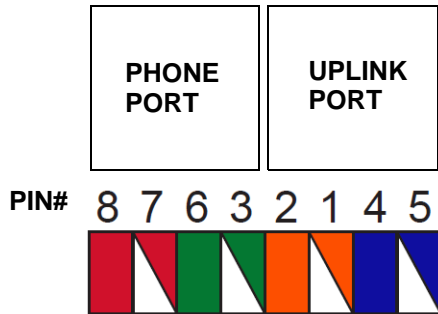
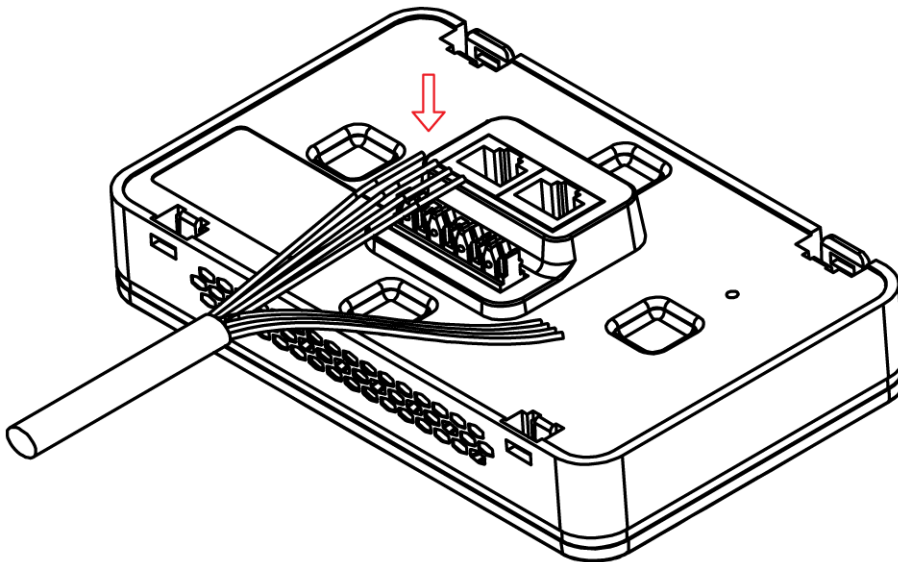

- 5 Trim any excess wires. Place the dust caps over the terminated wires.

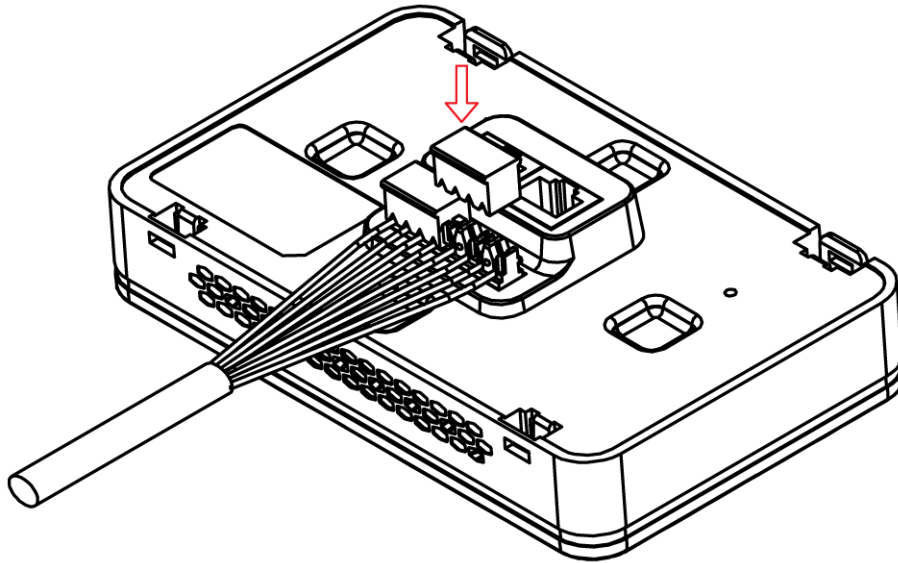

## 1.5.2 Phone Port

Connect a digital telephone to the RJ-45 **PHONE** port at the bottom of the NWA to forward voice traffic to/from the telephone switchboard that is connected to the RJ-45 **PHONE** port on the back of the NWA. The NWA does not support VoIP (Voice over Internet Protocol) and the **PHONE** port is NOT for making calls over the regular networking network (PSTN), either.

## 1.5.3 Console Port

To use the CLI commands to configure the NWA, connect an RJ-45-to-DB-9 cable to the **PHONE** port at the bottom of the NWA.

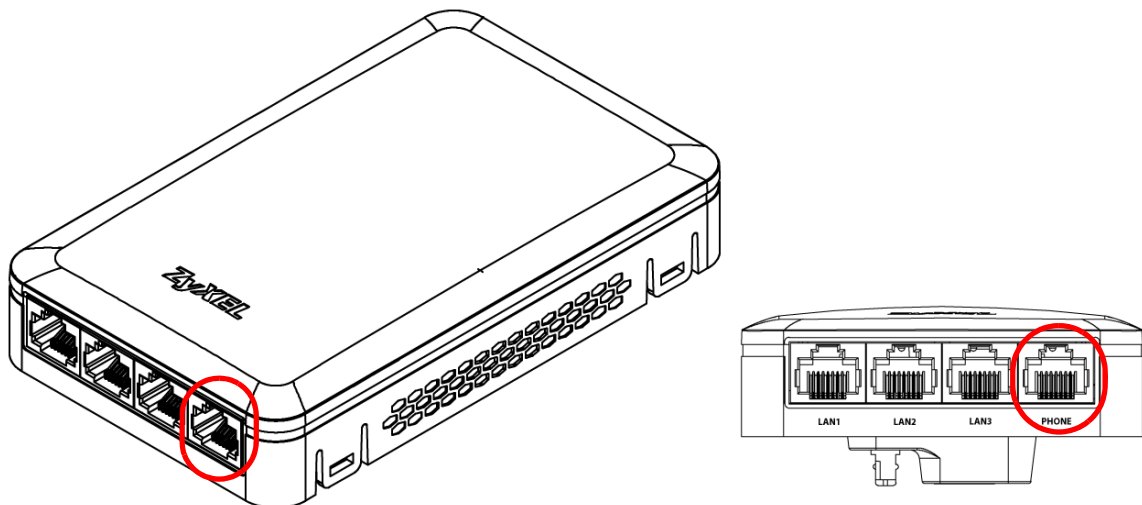

For local management, you can use a computer with terminal emulation software configured to the following parameters:

- VT100 terminal emulation



- 115200 bps
- No parity, 8 data bits, 1 stop bit
- No flow control

The following table shows you the wire color codes and pin assignment for the console cable.

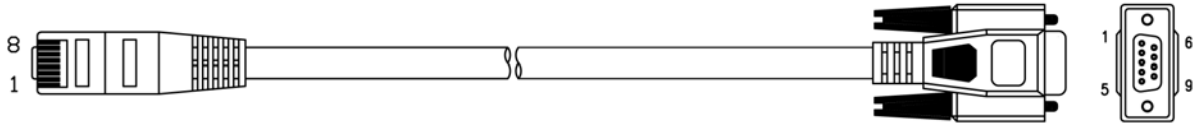

Table 7 RJ45-to-DB-9 Console Cable Color Codes

RJ45 PIN#	WIRE COLOR	DB-9 PIN#
1	Black	1
7	Brown	2
2	Blue	3
8	Purple	5

## 1.6 LEDs

The LEDs of your WAC6500 and NWA5301 can be controlled by using the Suppression feature such that the LEDs stay lit (ON) or OFF after the device is ready.

The WAC6500 also features Locator LED which allows you to see the actual location of the WAC6500 between several devices in the network.

Following are LED descriptions for the NWA/WAC series models.

### 1.6.1 WAC6502D-E, WAC6502D-S, and WAC6503D-S

The LEDs will stay ON when the WAC6500 Series is ready. You can change this setting in the **Maintenance > LEDs > Suppression** screen.

Figure 5 WAC6500 Series LEDs



The following table describes the LEDs.

Table 8 WAC6500 Series LEDs



LED	COLOR	STATUS	DESCRIPTION
PWR/SYS 	Red	Slow Blinking (On for 1s, Off for 1s)	The WAC is booting up.
	Green	On	
	Red	Off	The WAC is ready for use.
	Green	On	
	Red	On	There is system error and the WAC cannot boot up, or the WAC suffered a system failure.
	Green	Off	
	Red	Fast Blinking (on for 50ms, Off for 50ms)	The WAC is doing firmware upgrade.
	Green	Off	
	Red	Slow Blinking (blink for 3 times, Off for 3s)	The Uplink port is disconnected.
	Green	Off	
	Red	Slow Blinking (blink for 2 times, Off for 3s)	The wireless module of the WAC is disabled or failed.
Green	Off		
Management 	Green	On	The WAC AP is managed by a controller.
		Slow Blinking (blink for 3 times, Off for 3s)	The WAC AP is searching (discovery) for a controller.
		Off	The WAC AP is in standalone mode.
WLAN 	Green	On	The 2.4 GHz WLAN is active.
		Off	The 2.4 GHz WLAN is not active.

Table 8 WAC6500 Series LEDs (continued)

LED	COLOR	STATUS	DESCRIPTION
WLAN (i) 5G	Green	On	The 5 GHz WLAN is active.
		Off	The 5 GHz WLAN is not active.
UPLINK ↻	Amber/ Green	On	Amber - The port is operating as a 100-Mbps connection. Green - The port is operating as a Gigabit connection (1000 Mbps).
		Blinking	The WAC is sending/receiving data through the port.
		Off	The port is not connected.
LAN ↻	Amber/ Green	On	Amber - The port is operating as a 100-Mbps connection. Green - The port is operating as a Gigabit connection (1000 Mbps).
		Blinking	The LAN port is sending/receiving data through the port.
		Off	The LAN port is not connected.
Locator ☀	White	Blinking	The Locator is activated and will show the actual location of the WAC between several devices in the network.
		Off	The Locator function is off.

## 1.6.2 NWA1123-AC PRO and WAC6103D-I

The LEDs will stay ON when the NWA1123-AC PRO or WAC6103D-I is ready. You can change this setting in the **Maintenance > LEDs > Suppression** screen.

Figure 6 NWA1123-AC PRO and WAC6103D-I LEDs

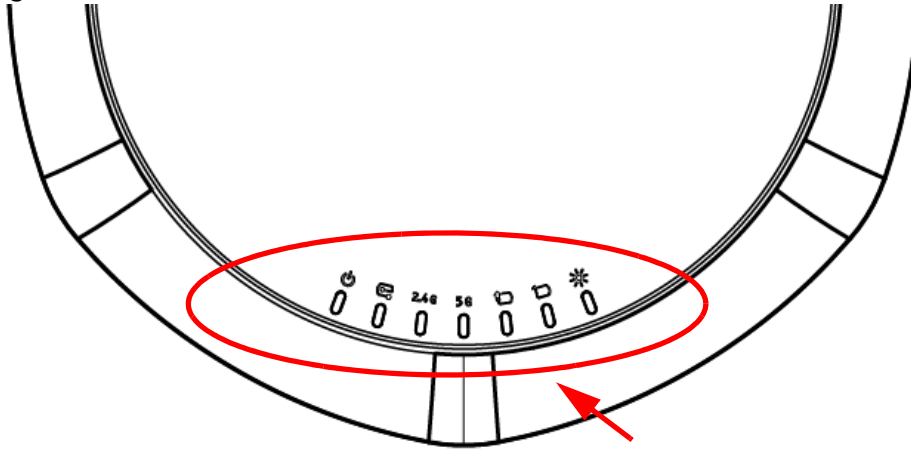

The following table describes the LEDs.

Table 9 NWA1123-AC PRO and WAC6103D-I LEDs





LED	COLOR	STATUS	DESCRIPTION
PWR/SYS 	Red	Slow Blinking (On for 1s, Off for 1s)	The NWA/WAC is booting up.
	Green	On	
	Red	Off	The NWA/WAC is ready for use.
	Green	On	
	Red	On	There is system error and the NWA/WAC cannot boot up, or the NWA/WAC suffered a system failure.
	Green	Off	
	Red	Fast Blinking (on for 50ms, Off for 50ms)	The NWA/WAC is doing firmware upgrade.
	Green	Off	
	Red	Slow Blinking (blink for 3 times, Off for 3s)	The <b>Uplink</b> port is disconnected.
	Green	Off	
Management 	Green	On	The NWA/WAC is managed by a controller.
		Slow Blinking (blink for 3 times, Off for 3s)	The NWA/WAC is searching (discovery) for a controller.
		Off	The NWA/WAC is in standalone mode.
WLAN <b>2.4G</b>	Green	On	The antenna switch is set to "Ceiling" for the radio. The 2.4 GHz WLAN is active.
	Amber	On	The antenna switch is set to "Wall" for the radio. The 2.4 GHz WLAN is active.
		Off	The 2.4 GHz WLAN is not active.
WLAN <b>5G</b>	Green	On	The antenna switch is set to "Ceiling" for the radio. The 5 GHz WLAN is active.
	Amber	On	The antenna switch is set to "Wall" for the radio. The 5 GHz WLAN is active.
		Off	The 5 GHz WLAN is not active.
UPLINK 	Amber/ Green	On	Amber - The port is operating as a 100-Mbps connection. Green - The port is operating as a Gigabit connection (1000 Mbps).
		Blinking	The NWA/WAC is sending/receiving data through the port.
		Off	The port is not connected.
LAN 	Amber/ Green	On	Amber - The port is operating as a 100-Mbps connection. Green - The port is operating as a Gigabit connection (1000 Mbps).
		Blinking	The LAN port is sending/receiving data through the port.
		Off	The LAN port is not connected.

Table 9 NWA1123-AC PRO and WAC6103D-I LEDs (continued)

LED	COLOR	STATUS	DESCRIPTION
Locator 	White	Blinking	The Locator is activated and will show the actual location of the NWA/WAC between several devices in the network.
		Off	The Locator function is off.

### 1.6.3 NWA5301-NJ

The LEDs automatically turn off when the NWA5301-NJ is ready. You can press the **LED ON** button for one second to turn on the LEDs again. The LEDs will blink and turn off after two minutes.

Figure 7 NWA5301-NJ LEDs



The following are the LED descriptions for your NWA5301-NJ.

Table 10 NWA5301-NJ LEDs





LABEL	COLOR	STATUS	DESCRIPTION
PWR/SYS 	Amber	Slow Blinking (On for 1s, Off for 1s)	The NWA is booting up.
	Green	On	
	Amber	Off	The NWA is ready for use.
	Green	On	
	Amber	Slow Blinking (blink for 3 times, Off for 3s)	The NWA is discovering an AP controller
	Green	On	
	Amber	On	The NWA failed to boot up or is experiencing system failure.
	Green	Off	
	Amber	Fast Blinking (On for 50ms times, Off for 50ms)	The NWA is undergoing firmware upgrade.
	Green	Off	
	Amber	Slow Blinking (blink for 3 times, Off for 3s)	The Uplink port is disconnected.
	Green	Off	
Amber	Slow Blinking (blink for 2 times, Off for 3s)	The wireless module of the WAC is disabled or failed.	
Green	Off		
PoE 	Green	On	Power is supplied to the yellow PoE Ethernet port (LAN1).
		Off	There is no power supply.

Table 10 NWA5301-NJ LEDs (continued)

LABEL	COLOR	STATUS	DESCRIPTION
WLAN 	Green	On	The WLAN is active.
		Off	The WLAN is not active.
UPLINK 	Green	On	The port is connected.
		Blinking	The NWA is sending/receiving data through the port.
		Off	The port is not connected.
LAN1-3 	Green	On	The port is connected.
		Blinking	The NWA is sending/receiving data through the port.
		Off	The port is not connected.

## 1.6.4 NWA1123-ACv2, NWA5121-N, NWA5121-NI, NWA5123-AC and NWA5123-NI

The following are the LED descriptions for your NWA1123/5120 series.

Figure 8 NWA1123/5120 Series LED



The following are the LED descriptions for your NWA1123/5120 series.

Table 11 NWA1123/5120 Series LED

COLOR	STATUS	DESCRIPTION
Amber	Slow Blinking (On for 1s, Off for 1s)	The NWA is booting up.
Green	On	

Table 11 NWA1123/5120 Series LED (continued)

COLOR	STATUS	DESCRIPTION
Amber	Off	The NWA is ready for use.
Green	On	
Amber	Off	The NWA's wireless interface is activated.
Green	On	
Amber	Slow Blinking (blink for 3 times, Off for 3s)	The NWA is discovering an AP controller.
Green	On	
Amber	On	The NWA failed to boot up or is experience system failure.
Green	Off	
Amber	Fast Blinking (On for 50ms, Off for 50ms)	The NWA is undergoing firmware upgrade.
Green	Off	
Amber	Slow Blinking (blink for 3 times, Off for 3s)	The Uplink port is disconnected.
Green	Off	
Amber	Slow Blinking (blink for 2 times, Off for 3s)	The wireless LAN is disabled or fails.
Green	Off	

## 1.6.5 WAC5302D-S





The LEDs automatically turn off when the WAC5302D-S is ready. You can press the **LED ON** button for one second to turn on the LEDs again. The LEDs will blink and turn off after two minutes.

Figure 9 WAC5302D-S LEDs



The following table describes the LEDs.

Table 12 WAC5302D-S LEDs

LED	COLOR	STATUS	DESCRIPTION
PWR/SYS 	Red	Slow Blinking (On for 1s, Off for 1s)	The WAC is booting up.
	Green	On	
	Red	Off	The WAC is ready for use.
	Green	On	
	Red	On	There is system error and the WAC cannot boot up, or the WAC suffered a system failure.
	Green	Off	
	Red	Fast Blinking (on for 50ms, Off for 50ms)	The WAC is doing firmware upgrade.
	Green	Off	
	Red	Slow Blinking (blink for 3 times, Off for 3s)	The Uplink port is disconnected.
	Green	Off	
	Red	Slow Blinking (blink for 2 times, Off for 3s)	The wireless module of the WAC is disabled or failed.
Green	Off		
Management 	Green	On	The WAC AP is managed by a controller.
		Slow Blinking (blink for 3 times, Off for 3s)	The WAC AP is searching (discovery) for a controller.
		Off	The WAC AP is in standalone mode.
UPLINK 	Amber/ Green	On	Amber - The port is operating as a 10/100-Mbps connection.  Green - The port is operating as a Gigabit connection (1000 Mbps).
		Blinking	The WAC is sending/receiving data through the port.
		Off	The port is not connected.
WLAN 	Green	On	The 2.4 GHz WLAN is active.
		Off	The 2.4 GHz WLAN is not active.
WLAN 	Green	On	The 5 GHz WLAN is active.
		Off	The 5 GHz WLAN is not active.
LAN 	Amber/ Green	On	Amber - The port is operating as a 10/100-Mbps connection.  Green - The port is operating as a Gigabit connection (1000 Mbps).
		Blinking	The LAN port is sending/receiving data through the port.
		Off	The LAN port is not connected.

## 1.6.6 NWA1123-AC HD, NWA5123-AC HD and WAC6303D-S

The following are the LED descriptions for your NWA/WAC.



**Figure 10** NWA1123-AC HD, NWA5123-AC HD and WAC6303D-S LED

The following are the LED descriptions for your NWA/WAC.

**Table 13** NWA1123-AC HD, NWA5123-AC HD and WAC6303D-S LED

COLOR	STATUS	DESCRIPTION
Amber	Slow Blinking (On for 1s, Off for 1s)	The NWA/WAC is booting up.
Green	On	
Amber	Slow Blinking (blink for 3 times, Off for 3s)	The NWA/WAC is discovering an AP controller.
Green	On	
Green	On	The NWA/WAC is ready for use, the NWA/WAC's wireless interface is activated, and/or wireless clients are connected to the NWA/WAC.
Bright Blue	On	The NWA/WAC's wireless interface is activated, but there are no wireless clients connected.
Red	On	The NWA/WAC failed to boot up or is experience system failure.
Red	Fast Blinking (On for 50ms, Off for 50ms)	The NWA/WAC is undergoing firmware upgrade.
Red	Slow Blinking (blink for 3 times, Off for 3s)	The Uplink port is disconnected.
Green	Slow Blinking (blink for 1 time, Off for 1s)	The wireless LAN is disabled or fails.
Blue	Slow Blinking (blink for 1 time, Off for 1s)	The NWA/WAC is checking for an available 5GHz channel.

## 1.7 Starting and Stopping the NWA/WAC

Here are some of the ways to start and stop the NWA/WAC.

**Always use Maintenance > Shutdown or the `shutdown` command before you turn off the NWA/WAC or remove the power. Not doing so can cause the firmware to become corrupt.**

Table 14 Starting and Stopping the NWA/WAC

METHOD	DESCRIPTION
Turning on the power	A cold start occurs when you turn on the power to the NWA/WAC. The NWA/WAC powers up, checks the hardware, and starts the system processes.
Rebooting the NWA/WAC	A warm start (without powering down and powering up again) occurs when you use the <b>Reboot</b> button in the <b>Reboot</b> screen or when you use the <code>reboot</code> command. The NWA/WAC writes all cached data to the local storage, stops the system processes, and then does a warm start.
Using the RESET button	If you press the <b>RESET</b> button on the back of the NWA/WAC, the NWA/WAC sets the configuration to its default values and then reboots. See <a href="#">Section 22.6 on page 212</a> for more information.
Clicking <b>Maintenance &gt; Shutdown &gt; Shutdown</b> or using the <code>shutdown</code> command	Clicking <b>Maintenance &gt; Shutdown &gt; Shutdown</b> or using the <code>shutdown</code> command writes all cached data to the local storage and stops the system processes. Wait for the device to shut down and then manually turn off or remove the power. It does not turn off the power.
Disconnecting the power	Power off occurs when you turn off the power to the NWA/WAC. The NWA/WAC simply turns off. It does not stop the system processes or write cached data to local storage.

The NWA/WAC does not stop or start the system processes when you apply configuration files or run shell scripts although you may temporarily lose access to network resources.

# CHAPTER 2

## The Web Configurator

### 2.1 Overview

The NWA/WAC Web Configurator allows easy management using an Internet browser. Browsers supported are:

- Firefox 36.0.1 or later
- Chrome 41.0 or later
- IE 10 or later

The recommended screen resolution is 1024 x 768 pixels and higher.

### 2.2 Accessing the Web Configurator

- 1 Make sure your NWA/WAC is working in standalone AP mode (see [Section 1.1.1 on page 17](#)) and hardware is properly connected. See the Quick Start Guide.
- 2 If the NWA/WAC and your computer are not connected to a DHCP server, make sure your computer's IP address is in the range between "192.168.1.3" and "192.168.1.254".
- 3 Browse to the NWA/WAC's DHCP-assigned IP address or <http://192.168.1.2>. The **Login** screen appears.

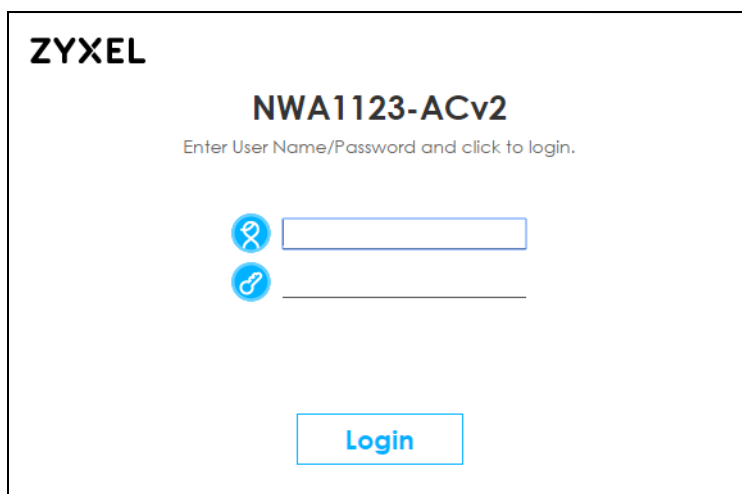

**ZYXEL**

**NWA1123-ACv2**

Enter User Name/Password and click to login.

**Login**

- 4 Enter the user name (default: "admin") and password (default: "1234"). Click **Login**.

- 5 If you logged in using the default user name and password, the **Update Admin Info** screen appears. Otherwise, the dashboard appears.

**ZYXEL**

**NWA1123-ACv2**

**Update Admin Info**

As a security precaution, it is highly recommended that you change the admin password.

New Password

Retype to Confirm

( max. 63 alphanumeric, printable characters and no spaces )

**Apply** **Ignore**

The **Update Admin Info** screen appears every time you log in using the default user name and default password. If you change the password for the default user account, this screen does not appear anymore.

## 2.3 Navigating the Web Configurator

The following summarizes how to navigate the web configurator from the **Dashboard** screen. This guide uses the NWA1123-ACv2 screens as an example. The screens may vary slightly for different models.

Figure 11 The Web Configurator's Main Screen

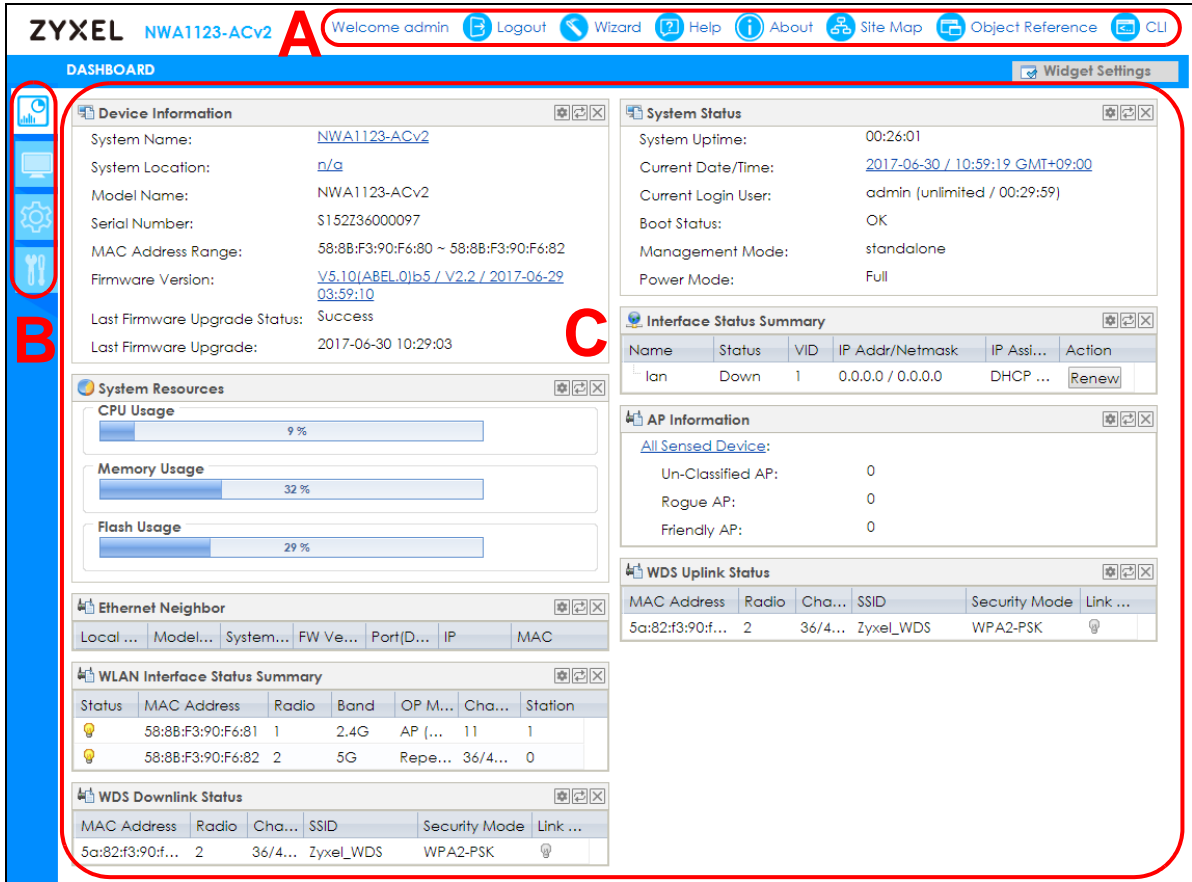

The Web Configurator's main screen is divided into these parts:

- A - Title Bar
- B - Navigation Panel
- C - Main Window

### 2.3.1 Title Bar

The title bar provides some useful links that always appear over the screens below, regardless of how deep into the Web Configurator you navigate.

Figure 12 Title Bar



The icons provide the following functions.

Table 15 Title Bar: Web Configurator Icons

LABEL	DESCRIPTION
Logout	Click this to log out of the Web Configurator.
Wizard	Click this to open the wizard. See <a href="#">Chapter 3 on page 47</a> for more information.
Help	Click this to open the help page for the current screen.

Table 15 Title Bar: Web Configurator Icons (continued)

LABEL	DESCRIPTION
About	Click this to display basic information about the NWA/WAC.
Site Map	Click this to see an overview of links to the Web Configurator screens.
Object Reference	Click this to open a screen where you can check which configuration items reference an object.
CLI	Click this to open a popup window that displays the CLI commands sent by the Web Configurator.

## About

Click **About** to display basic information about the NWA/WAC.

Figure 13 About

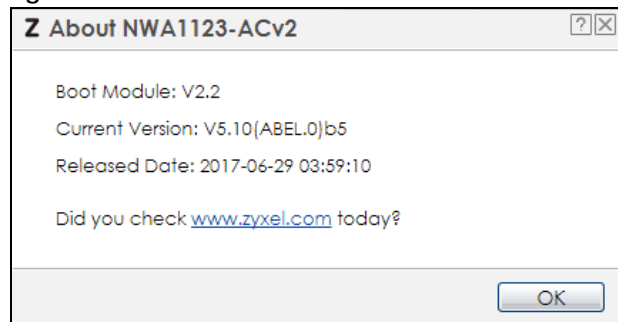

The following table describes labels that can appear in this screen.

Table 16 About

LABEL	DESCRIPTION
Boot Module	This shows the version number of the software that handles the booting process of the NWA/WAC.
Current Version	This shows the firmware version of the NWA/WAC.
Released Date	This shows the date (yyyy-mm-dd) and time (hh:mm:ss) when the firmware is released.
OK	Click this to close the screen.

## Site Map

Click **Site MAP** to see an overview of links to the Web Configurator screens. Click a screen's link to go to that screen.

Figure 14 Site Map

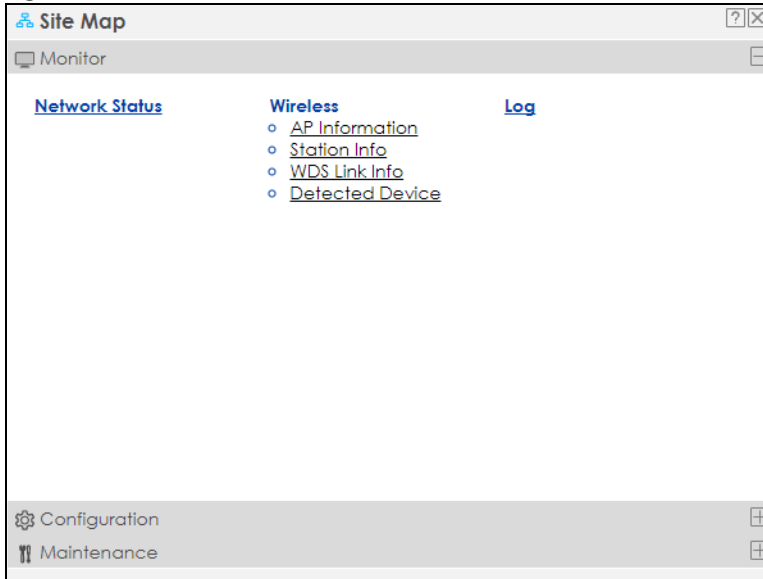

## Object Reference

Click **Object Reference** to open the **Object Reference** screen. Select the type of object and the individual object and click **Refresh** to show which configuration settings reference the object.

Figure 15 Object Reference

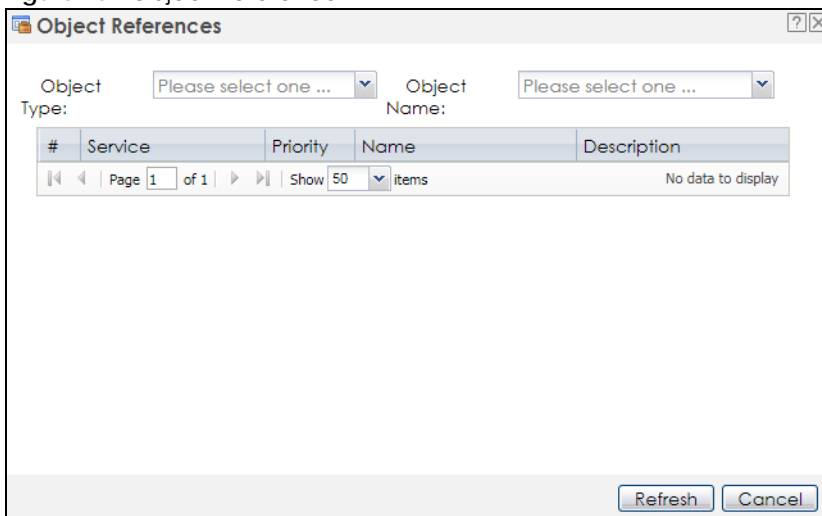

The fields vary with the type of object. The following table describes labels that can appear in this screen.

Table 17 Object References

LABEL	DESCRIPTION
Object Name	This identifies the object for which the configuration settings that use it are displayed. Click the object's name to display the object's configuration screen in the main window.
#	This field is a sequential value, and it is not associated with any entry.
Service	This is the type of setting that references the selected object. Click a service's name to display the service's configuration screen in the main window.

Table 17 Object References (continued)

LABEL	DESCRIPTION
Priority	If it is applicable, this field lists the referencing configuration item's position in its list, otherwise <b>N/A</b> displays.
Name	This field identifies the configuration item that references the object.
Description	If the referencing configuration item has a description configured, it displays here.
Refresh	Click this to update the information in this screen.
Cancel	Click <b>Cancel</b> to close the screen.

## CLI Messages

Click **CLI** to look at the CLI commands sent by the Web Configurator. These commands appear in a popup window, such as the following.

Figure 16 CLI Messages

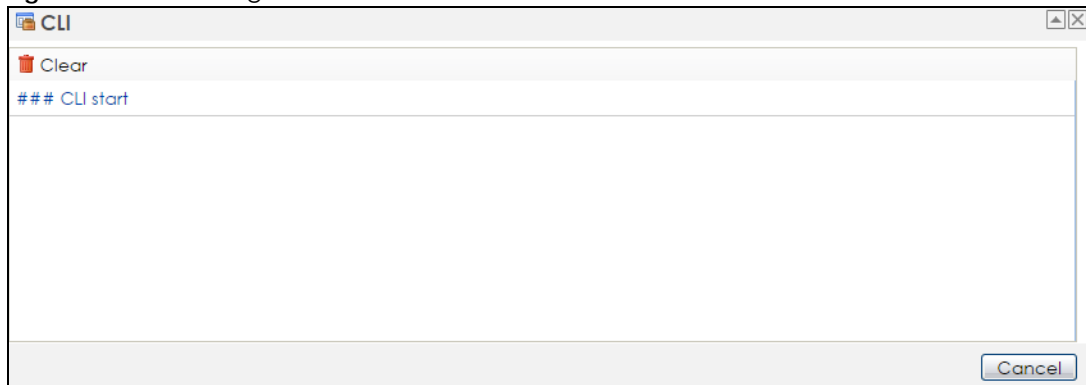

Click **Clear** to remove the currently displayed information.

Note: See the Command Reference Guide for information about the commands.

## 2.3.2 Navigation Panel

Use the menu items on the navigation panel to open screens to configure NWA/WAC features. Click the arrow in the middle of the right edge of the navigation panel to hide the navigation panel menus or drag it to resize them. The following sections introduce the NWA/WAC's navigation panel menus and their screens.



Figure 17 Navigation Panel

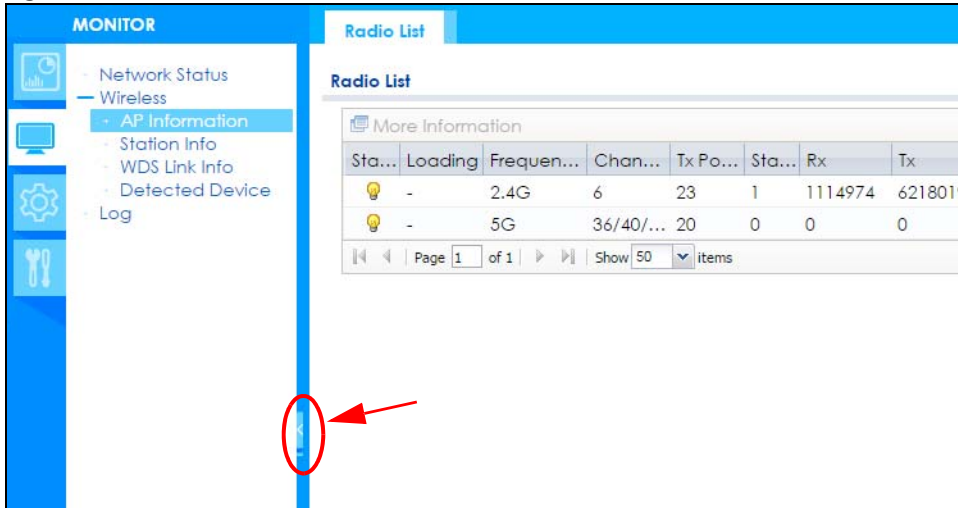

## Dashboard

The dashboard displays general device information, system status, system resource usage, and interface status in widgets that you can re-arrange to suit your needs.

For details on the Dashboard's features, see [Chapter 4 on page 54](#).

## Monitor Menu

The monitor menu screens display status and statistics information.

Table 18 Monitor Menu Screens Summary

FOLDER OR LINK	TAB	FUNCTION
Network Status	Network Status	Display general LAN interface information and packet statistics.
Wireless		
AP Information	Radio List	Display information about the radios of the connected APs.
Station Info	Station List	Display information about the connected stations.
WDS Link Info	WDS Link Info	Display statistics about the NWA/WAC's WDS (Wireless Distribution System) connections.
Detected Device	Detected Device	Display information about suspected rogue APs.
Log	View Log	Display log entries for the NWA/WAC.

## Configuration Menu

Use the configuration menu screens to configure the NWA/WAC's features.

Table 19 Configuration Menu Screens Summary

FOLDER OR LINK	TAB	FUNCTION
Network	IP Setting	Configure the IP address for the NWA/WAC Ethernet interface.
	VLAN	Manage the Ethernet interface VLAN settings.
	AC Discovery	Configures the NWA/WAC's AP Controller settings.

Table 19 Configuration Menu Screens Summary (continued)

FOLDER OR LINK	TAB	FUNCTION
Wireless		
AP Management	WLAN Setting	Manage the NWA/WAC's general wireless settings.
Rogue AP	Rogue/Friendly AP List	Configure how the NWA/WAC monitors for rogue APs.
Load Balancing	Load Balancing	Configure load balancing for traffic moving to and from wireless clients.
DCS	DCS	Configure dynamic wireless channel selection.
Bluetooth	Advertising Settings	Configure the beacon ID(s) to be included in the Bluetooth advertising packet.
Object		
User	User	Create and manage users.
	Setting	Manage default settings for all users, general settings for user sessions, and rules to force user authentication.
AP Profile	Radio	Create and manage wireless radio settings files that can be associated with different APs.
	SSID	Create and manage wireless SSID, security, MAC filtering, and layer-2 isolation files that can be associated with different APs.
MON Profile	MON Profile	Create and manage rogue AP monitoring files that can be associated with different APs.
WDS Profile	WDS	Create and manage WDS profiles that can be used to connect to different APs in WDS.
Certificate	My Certificates	Create and manage the NWA/WAC's certificates.
	Trusted Certificates	Import and manage certificates from trusted sources.
System		
Host Name	Host Name	Configure the system and domain name for the NWA/WAC.
Date/Time	Date/Time	Configure the current date, time, and time zone in the NWA/WAC.
WWW	Service Control	Configure HTTP, HTTPS, and general authentication.
SSH	SSH	Configure SSH server and SSH service settings.
TELNET	TELNET	Configure telnet server settings for the NWA/WAC.
FTP	FTP	Configure FTP server settings.
SNMP	SNMP	Configure SNMP communities and services.
Log & Report		
Email Daily Report	Email Daily Report	Configure where and how to send daily reports and what reports to send.
Log Setting	Log Setting	Configure the system log, e-mail logs, and remote syslog servers.

## Maintenance Menu

Use the maintenance menu screens to manage configuration and firmware files, run diagnostics, and reboot or shut down the NWA/WAC.

Table 20 Maintenance Menu Screens Summary

FOLDER OR LINK	TAB	FUNCTION
File Manager	Configuration File	Manage and upload configuration files for the NWA/WAC.
	Firmware Package	View the current firmware version and to upload firmware.
	Shell Script	Manage and run shell script files for the NWA/WAC.
Diagnostics	Diagnostics	Collect diagnostic information.
LEDs	Suppression	Enable this feature to keep the LEDs off after the NWA/WAC starts.
	Locator	Enable this feature to see the actual location of the NWA/WAC between several devices in the network.
Antenna	Antenna Switch	Change antenna orientation for the radios.
Reboot	Reboot	Restart the NWA/WAC.
Shutdown	Shutdown	Turn off the NWA/WAC.

### 2.3.3 Warning Messages

Warning messages, such as those resulting from misconfiguration, display in a pop up window.

Figure 18 Warning Message

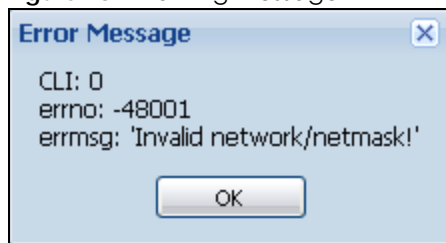

### 2.3.4 Tables and Lists

The Web Configurator tables and lists are quite flexible and provide several options for how to display their entries.

#### 2.3.4.1 Manipulating Table Display

Here are some of the ways you can manipulate the Web Configurator tables.

- 1 Click a column heading to sort the table's entries according to that column's criteria.

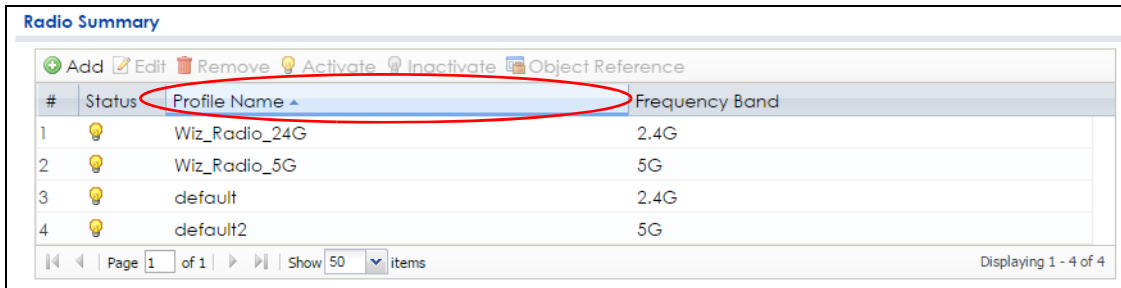

- 2 Click the down arrow next to a column heading for more options about how to display the entries. The options available vary depending on the type of fields in the column. Here are some examples of what you can do:
  - Sort in ascending alphabetical order
  - Sort in descending (reverse) alphabetical order
  - Select which columns to display
  - Group entries by field
  - Show entries in groups
  - Filter by mathematical operators (<, >, or =) or searching for text.

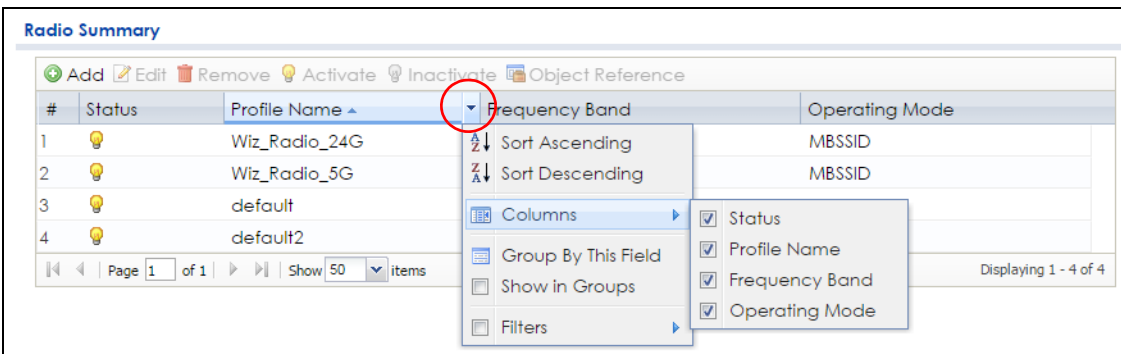

- 3 Select a column heading cell's right border and drag to re-size the column.

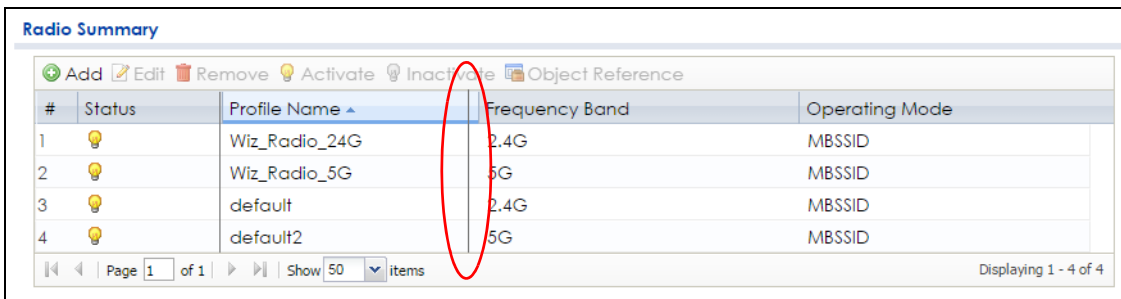

- 4 Select a column heading and drag and drop it to change the column order. A green check mark displays next to the column's title when you drag the column to a valid new location.

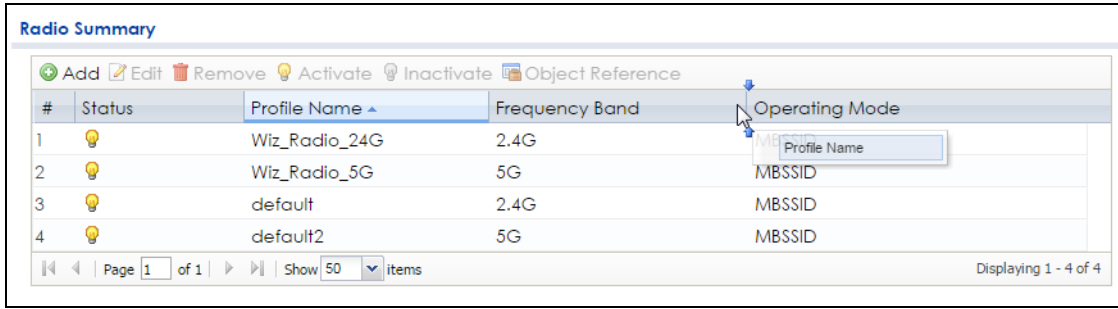

- 5 Use the icons and fields at the bottom of the table to navigate to different pages of entries and control how many entries display at a time.

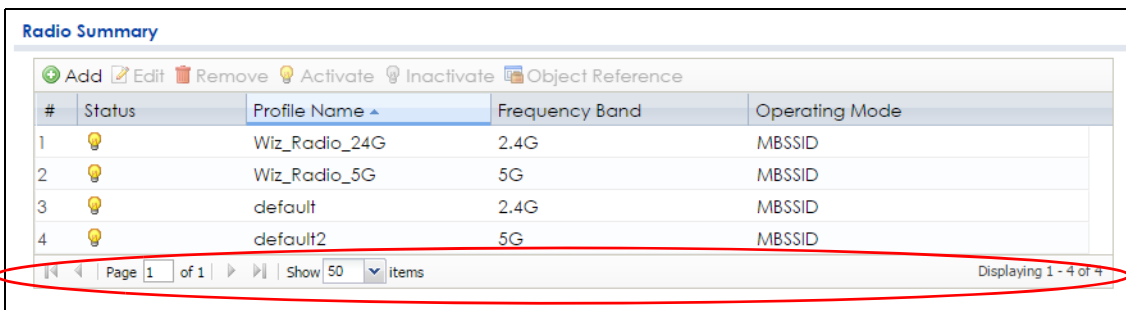

### 2.3.4.2 Working with Table Entries

The tables have icons for working with table entries. A sample is shown next. You can often use the [Shift] or [Ctrl] key to select multiple entries to remove, activate, or deactivate.

Table 21 Common Table Icons

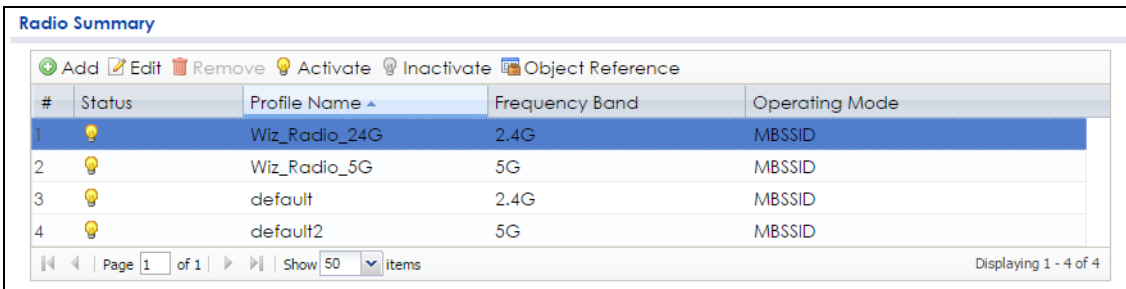

Here are descriptions for the most common table icons.

Table 22 Common Table Icons

LABEL	DESCRIPTION
Add	Click this to create a new entry. For features where the entry's position in the numbered list is important (features where the NWA/WAC applies the table's entries in order like the firewall for example), you can select an entry and click <b>Add</b> to create a new entry after the selected entry.
Edit	Double-click an entry or select it and click <b>Edit</b> to open a screen where you can modify the entry's settings. In some tables you can just click a table entry and edit it directly in the table. For those types of tables small red triangles display for table entries with changes that you have not yet applied.

Table 22 Common Table Icons (continued)

LABEL	DESCRIPTION
Remove	To remove an entry, select it and click <b>Remove</b> . The NWA/WAC confirms you want to remove it before doing so.
Activate	To turn on an entry, select it and click <b>Activate</b> .
Inactivate	To turn off an entry, select it and click <b>Inactivate</b> .
Object Reference	Select an entry and click <b>Object Reference</b> to open a screen that shows which settings use the entry.

# CHAPTER 3

## Setup Wizard

### 3.1 Accessing the Wizard

When you log into the Web Configurator for the first time or when you reset the NWA/WAC to its default configuration, the wizard screen displays.

Note: If you have already configured the wizard screens and want to open it again, click the **Wizard** icon on the upper right corner of any Web Configurator screen.

### 3.2 Using the Wizard

This wizard helps you configure the NWA/WAC IP address, change time zone, daylight saving and radio settings, and edit an SSID profile to change general wireless and wireless security settings.

#### 3.2.1 Country Code

The welcome screen displays. Select the country where the NWA/WAC is located and click **Next**.

Note: You cannot change the country code if the NWA/WAC products comply with the U.S. laws, policies and regulations and are to be sold to the U.S. market.

Figure 19 Wizard: Country Code

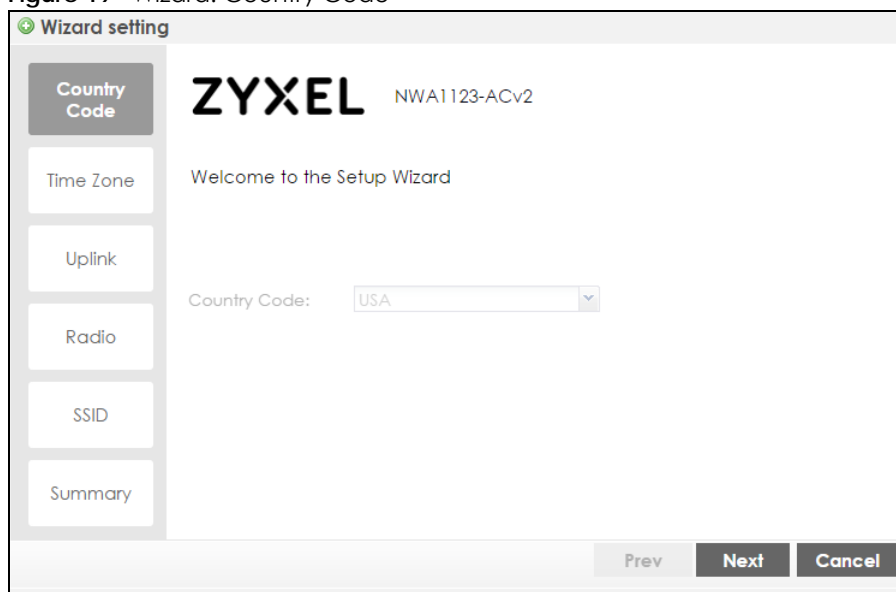

The screenshot shows the 'Wizard setting' window for a ZyXEL NWA1123-ACv2 device. On the left is a vertical sidebar with menu items: 'Country Code' (highlighted), 'Time Zone', 'Uplink', 'Radio', 'SSID', and 'Summary'. The main area displays 'ZYXEL NWA1123-ACv2' and 'Welcome to the Setup Wizard'. Below this, the 'Country Code:' label is followed by a dropdown menu currently set to 'USA'. At the bottom right, there are three buttons: 'Prev', 'Next', and 'Cancel'.

## 3.2.2 Time Zone

Use this screen to configure the NWA/WAC's time zone and daylight saving time.

- **Time Zone:** Select the time zone of your location. This will set the time difference between your time zone and Greenwich Mean Time (GMT).
- **Enable Daylight Saving:** Select the option if you use Daylight Saving Time. Configure the day and time when Daylight Saving Time starts and ends.
- **Offset** allows you to specify how much the clock changes when daylight saving begins and ends. Enter a number from 1 to 5.5 (by 0.5 increments).

Click **Prev** to return to the previous screen. Click **Next** to proceed. Click **Cancel** to close the wizard without saving.

Figure 20 Wizard: Time Zone

The screenshot shows the 'Wizard setting' window for a ZyXEL NWA1123-ACv2 device. On the left is a sidebar with navigation buttons: 'Country Code', 'Time Zone' (highlighted), 'Uplink', 'Radio', 'SSID', and 'Summary'. The main area displays the device name 'ZYXEL NWA1123-ACv2'. Under 'Time Zone', there is a dropdown menu set to '(GMT+08:00) Beijing, Hong Kong, Perth, Singapore'. Below this is a checked checkbox for 'Enable Daylight Saving'. The 'Start Date' is configured as 'Second Sunday of March at 12:00'. The 'End Date' is configured as 'First Sunday of November at 12:00'. The 'Offset' is set to '1 Hours'. At the bottom right are three buttons: 'Prev', 'Next', and 'Cancel'.

## 3.2.3 Uplink

Use this screen to configure the NWA/WAC's IP address.

**Uplink Connection:** Select **Auto (DHCP)** if the NWA/WAC is connected to a router with the DHCP server enabled. You then need to check the router for the IP address assigned to the NWA/WAC in order to access the NWA/WAC's web configurator again.

Otherwise, select **Static IP** when the NWA/WAC is NOT connected to a router or you want to assign it a fixed IP address. You will need to manually enter:

- the NWA/WAC's IP address and subnet mask.
- the IP address of the router that helps forward traffic.
- a DNS server's IP address. The Domain Name System (DNS) maps a domain name to an IP address and vice versa. The DNS server is extremely important because without it, you must know the IP address of a computer before you can access it.



Click **Prev** to return to the previous screen. Click **Next** to proceed. Click **Cancel** to close the wizard without saving.

**Figure 21** Wizard: Uplink

The screenshot shows the 'Wizard setting' window for a ZyXEL NWA1123-ACv2 device. On the left is a vertical sidebar with buttons for 'Country Code', 'Time Zone', 'Uplink' (which is highlighted), 'Radio', 'SSID', and 'Summary'. The main area displays the device name 'ZYXEL' and model 'NWA1123-ACv2'. Below this, the 'Uplink Connection' is set to 'Static IP' via a dropdown menu. There are five input fields for 'IP Address', 'Subnet Mask', 'Gateway', and 'DNS Server', all of which currently contain '0.0.0.0'. At the bottom right of the window are three buttons: 'Prev', 'Next', and 'Cancel'.

### 3.2.4 Radio

Use this screen to configure the NWA/WAC's radio transmitter(s).

- **Channel Selection:** Select **Auto** to have the NWA/WAC automatically choose a radio channel that has least interference. Otherwise, select **Manual** and specify a channel the NWA/WAC will use in the 2.4GHz or 5GHz wireless LAN. The options vary depending on the frequency band and the country you are in.
- **Maximum Output Power:** Enter the maximum output power of the NWA/WAC. If there is a high density of APs in an area, decrease the output power of the NWA/WAC to reduce interference with other APs.

Note: Reducing the output power also reduces the NWA/WAC's effective broadcast radius.

Click **Prev** to return to the previous screen. Click **Next** to proceed. Click **Cancel** to close the wizard without saving.

Figure 22 Wizard: Radio

**Wizard setting**

Country Code: **ZYXEL** NWA1123-ACv2

Time Zone

Uplink

**Radio**

SSID

Summary

**Radio 1**

Band: 2.4GHz

Channel Width: 20MHz

Channel Selection:  Auto  Manual 6

Maximum Output Power: 30 dBm(0~30)

**Radio 2**

Band: 5GHz

Channel Width: 20/40/80MHz

Channel Selection:  Auto  Manual 36

Maximum Output Power: 20 dBm(0~30)

Prev Next Cancel

### 3.2.5 SSID

Use this screen to enable, disable or edit an SSID profile.

Select an SSID profile and click the **Activate** icon to turn it on or click the **Inactivate** icon to turn it off. To change an SSID profile's settings, such as the SSID (WiFi network name) and WiFi password, select the SSID profile from the list and click the **Edit** icon. See [Section 3.2.5.1 on page 50](#) for more information.

Note: You cannot add or remove an SSID profile after running the setup wizard.

Figure 23 Wizard: SSID

**Wizard setting**

Country Code: **ZYXEL** NWA1123-ACv2

Time Zone

Uplink

Radio

**SSID**

Summary

Edit Activate Inactivate

#	Status	SSID	Security Mode	Band Mo...	VLAN ID
1		Zyxel	WPA2-PSK	Dual Band	1
2		Zyxel	WPA2-PSK	Dual Band	1
3		Zyxel	WPA2-PSK	Dual Band	1
4		Zyxel	WPA2-PSK	Dual Band	1
5		Zyxel	WPA2-PSK	Dual Band	1
6		Zyxel	WPA2-PSK	Dual Band	1
7		Zyxel	WPA2-PSK	Dual Band	1
8		Zyxel	WPA2-PSK	Dual Band	1

Prev Next Cancel

#### 3.2.5.1 Edit SSID Profile

Use this screen to configure an SSID profile.

The screen varies depending on the security type you selected.

- **SSID** - Enter a descriptive name of up to 32 printable characters for the wireless LAN.
- **VLAN ID**: Enter a VLAN ID for the NWA/WAC to use to tag traffic originating from this SSID.
- **Band Mode**: Select the wireless band which this profile should use. 2.4 GHz is the frequency used by IEEE 802.11b/g/n wireless clients. 5 GHz is the frequency used by IEEE 802.11ac/a/n wireless clients.  
Not all NWA/WACs support both 2.4 GHz and 5 GHz frequency bands.
- **Security Type**: Select **WPA2** to add security on this wireless network. Otherwise, select **OPEN** to allow any wireless client to associate this network without authentication.
- **PSK (Pre-shared Key)**: If you set **Security Type** to **wpa2** and select **PSK**, enter a pre-shared key of between 8 and 63 case-sensitive ASCII characters (including spaces and symbols) or 64 hexadecimal characters.
- **802.1x**: Select **802.1x** and the **Primary / Secondary Radius Server** check box to have the NWA/WAC use the specified RADIUS server. You have to enter the IP address, port number and shared secret password of the RADIUS server to be used for authentication.

Click **OK** to proceed. Click **Cancel** to close the screen without saving.

**Figure 24** Wizard: SSID: Edit (WPA2)

The screenshot shows a dialog box titled "Edit SSID Profile". The fields and options are as follows:

- SSID: Zyxel
- VLAN Tag
- VLAN ID: 1 (1~4094)
- Band Mode:  Dual Band  2.4GHz  5GHz
- Security Type: WPA2 (dropdown menu)
- PSK
- Secret: 12345678
- 802.1X

At the bottom right, there are "OK" and "Cancel" buttons.

Figure 25 Wizard: SSID: Edit (802.1x)

**Edit SSID Profile**

SSID:

VLAN Tag  
 VLAN ID:  (1~4094)

Band Mode:  Dual Band  2.4GHz  5GHz

Security Type:

PSK  
 802.1X

Primary RADIUS Server  
 RADIUS Server IP Address:   
 RADIUS Server Port:  (1~65535)  
 RADIUS Server Secret:

Secondary RADIUS Server  
 RADIUS Server IP Address:   
 RADIUS Server Port:   
 RADIUS Server Secret:

### 3.2.6 Summary

Use this screen to check whether what you have configured is correct. Click **Save** to apply your settings and complete the wizard setup. Otherwise, click **Prev** to return to the previous screen or click **Cancel** to close the wizard without saving.

Figure 26 Wizard: Summary

**Wizard setting**

Country Code: **ZYXEL** NWA1123-ACv2

Country Code: USA  
 Time Zone: (GMT+08:00) Beijing, Hong Kong, Perth, Singapore, Taipei  
 Daylight Saving: Enable  
 Management IP: DHCP  
 2.4G Radio: DCS  
 5G Radio: DCS  
 SSID:

#	Status	SSID	Security Mode	Band Mo...	VLAN ID
1	🔴	Zyxel	WPA2-PSK	Dual Band	1
2	🔴	Zyxel	WPA2-PSK	Dual Band	1
3	🔴	Zyxel	WPA2-PSK	Dual Band	1
4	🔴	Zyxel	WPA2-PSK	Dual Band	1