

瀚霖科技股份有限公司

Handlink Technologies Inc.

- 工程料號申請單
- 正式料號申請單
- 料號規格變更申請單
- 料號補規格申請單
- 零件作廢申請單

料號	5	8	7	1	3	0	6	—	2100G	申請人		日期: 14年4月16日	
廠商	天凱(TSKY)								供應商料號	A8-A003-00110			
品名	申請者填寫		ANTENNA 2.4GHz 2dbi(黑色)										
規格	申請者填寫		硬式(1套1支)										
附件	<input type="checkbox"/> 無 <input checked="" type="checkbox"/> 規格書 <input checked="" type="checkbox"/> 樣品 <input type="checkbox"/> PCB底片 <input type="checkbox"/> 色板 <input type="checkbox"/> 磁片 <input type="checkbox"/> 其它:												
原因:	2dbi 2.4G 硬式 Antenna(黑色) 承認												
項目	分發單位												
	文管室	品保	硬體	資材	製造	物料	行企	廠商					
申請單	✓	✓											
規格書	✓	✓											
樣品	✓	✓											
色板													
PCB底片													
磁片													
光碟													
備註:	缺 RoHS report 黃見志												
PE	QA	PA	PM	研發主管	資料建檔								
	黃見志	楊文	陳順	張	鍾芳宜 4/17								

表單編號: HQR3715 V1.3

承認書

SPECIFICATION FOR APPROVAL

樣品承認
 新品承認
 規格/材質變更承認

客戶名稱(Customer):	瀚霖科技股份有限公司		
客戶料號(Customer P/N):	5871306-2100G		
產品料號(Product No.):	A8-A003-00110		
產品品名(Product Name):	DIP 11b/g/n 2dbi d13 BLACK SMA MALE-RP		
文件編號(Approved No):			
日期(Issued Date):	2015 年 04 月 13 日		
客戶承認簽章 Customer Approval Signature	In Charge	Checked	Approval
			

TSKY™ 天凱科技股份有限公司 TSKY CO., LTD.

新竹縣竹北市自強南路8號15F-1 Tel:03-5502626 Fax:03-5503131
 15F-1, No.8, Ziqiang S. Rd., Zhubei City, Hsinchu County 30264, Taiwan (R.O.C.)

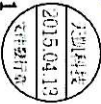

業務	核准	審核	主辦員

Contents

Item	Description	Page
1.	Cover	1
2.	Contents	2
3.	Specification	3
4.	Drawing	4
5.	Test Report	5~12
6.	包裝規範	13
7.	RoHS	14~26



Specification

• Electrical Properties :

1. Frequency : 2.4GHz ~ 2.5GHz
2. Impedance : 50Ω
3. Return Loss : $\leq -10\text{dB}$
4. Peak Gain : 2dBi

• Physical Properties :

1. Antenna Cover : TPEE
2. Antenna Base : PBT+PC
3. Connector : SMA MALE-RP
4. Operation temperature : $-20^{\circ}\text{C} \sim +65^{\circ}\text{C}$
5. Storage temperature : $-30^{\circ}\text{C} \sim +75^{\circ}\text{C}$

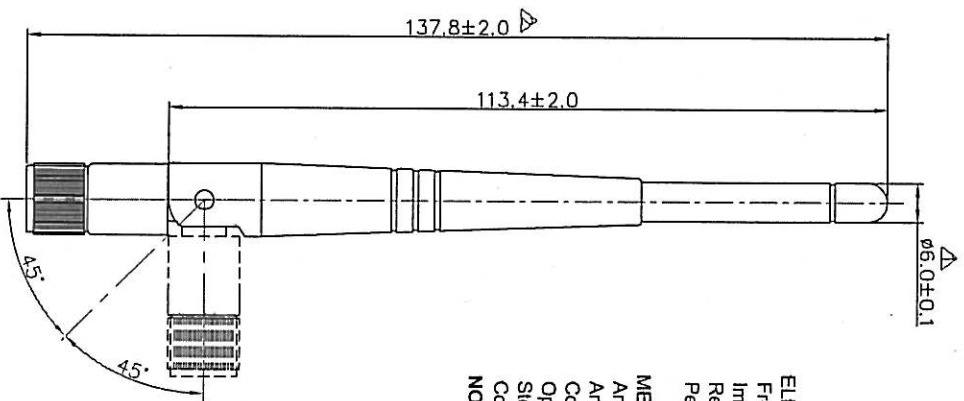

ELECTRICAL:
 Frequency: 2.4GHz-2.5GHz
 Impedance: 50Ω
 Return Loss : $\leq -10\text{dB}$
 Peak Gain: 2dBi

MECHANICAL:
 Antenna Cover: TPEE
 Antenna Base: PBT+PC
 Color: BLACK
 Operating Temperature: $-20^{\circ}\text{C} \sim +65^{\circ}\text{C}$
 Storage Temperature: $-30^{\circ}\text{C} \sim +75^{\circ}\text{C}$
 Connector: SMA MALE-RP
 NOTE: Δ ~ \triangle 為重點量測尺寸

REV	ECN NO.	DESCRIPTION	DRAWING	DESIGNED	CONCURRED	APPROVED	DATE
A		初版發行	Nydia				2015/03/31

TOLERANCE UNLESS OTHERWISE SPECIFIED				CONFIDENTIAL FINISH:				INITIAL MODEL	
DIMENSION		ANGLES		DRAWING		DESIGNED		CONCURRED	
.X±	0.2	X.±	0.5	SIZE:	A4	UNIT:	MM	SCALE:	1:1
.XX±	0.1	X.±	0.02	DRAWING	Nydia	CONCURRED		APPROVED	Jose
.XXX±	0.05							PART NO.	AB-A003-00110
								REV.	A
								SH-T	1/1

TSKY CO., LTD.

PART NAME
DIP 11b/g/n 2dBi d13
BLACK SMA MALE-RP



Return Loss & VSWR

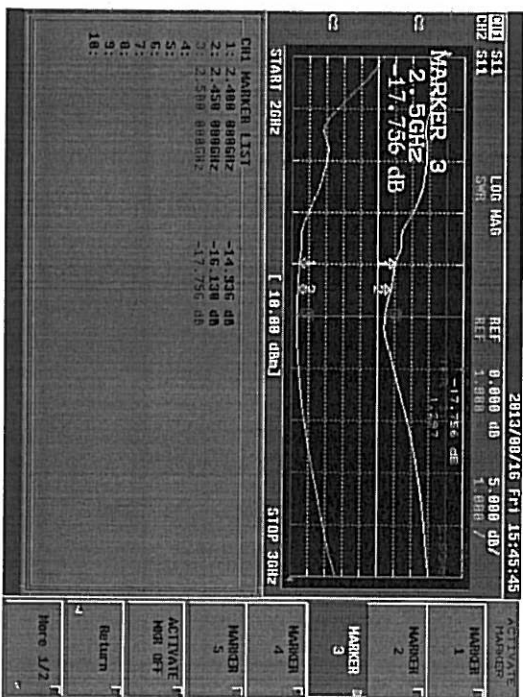

2dBi Dipole antenna 塑膠頭

2015.04.10.



Gain Pattern

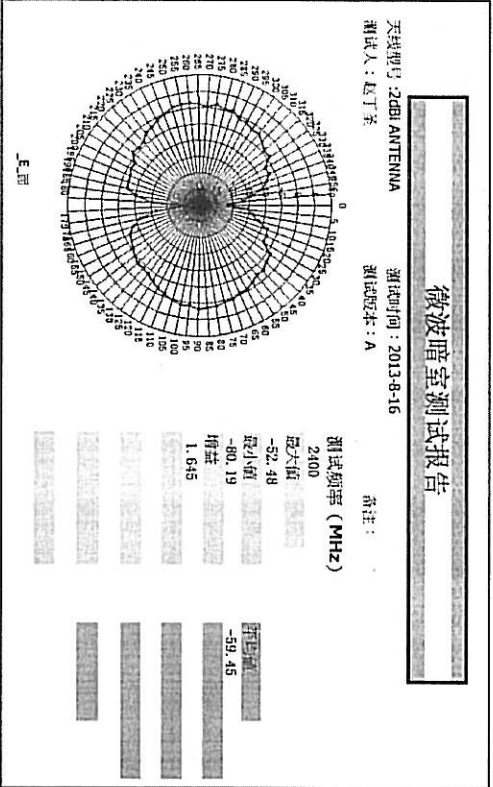

Gain Pattern

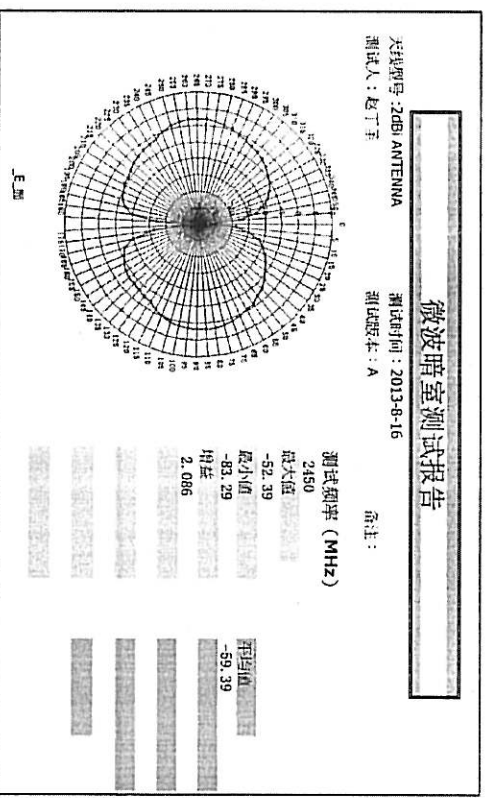



Gain Pattern

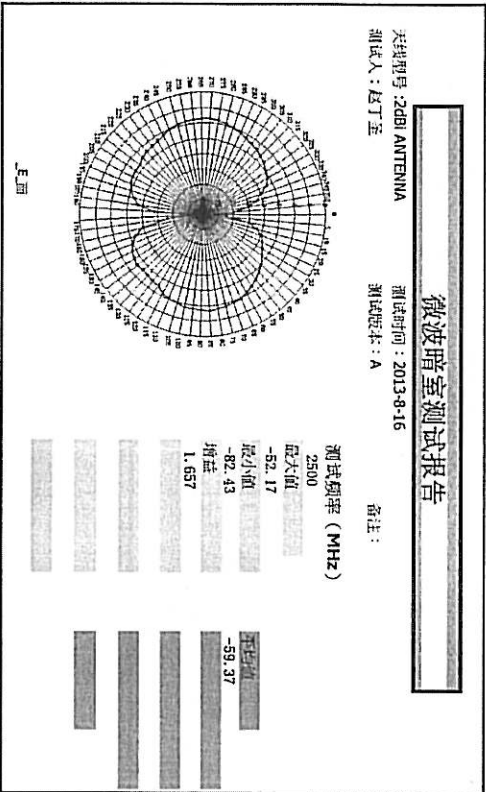

Gain Pattern

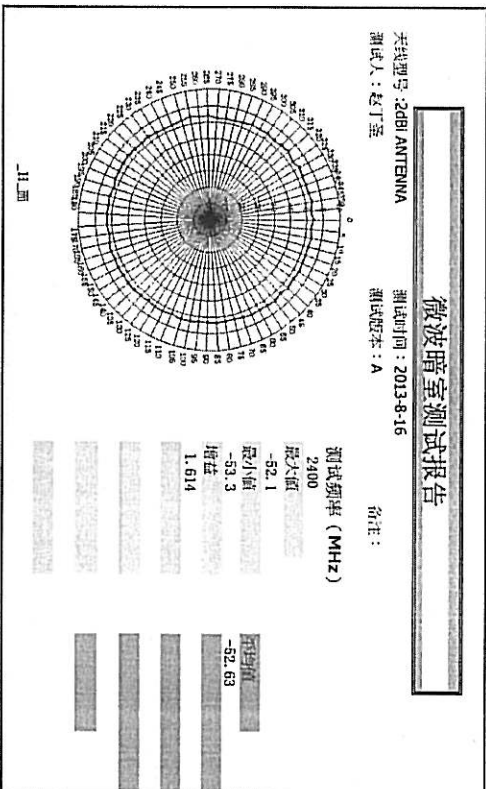

Gain Pattern



Gain Pattern

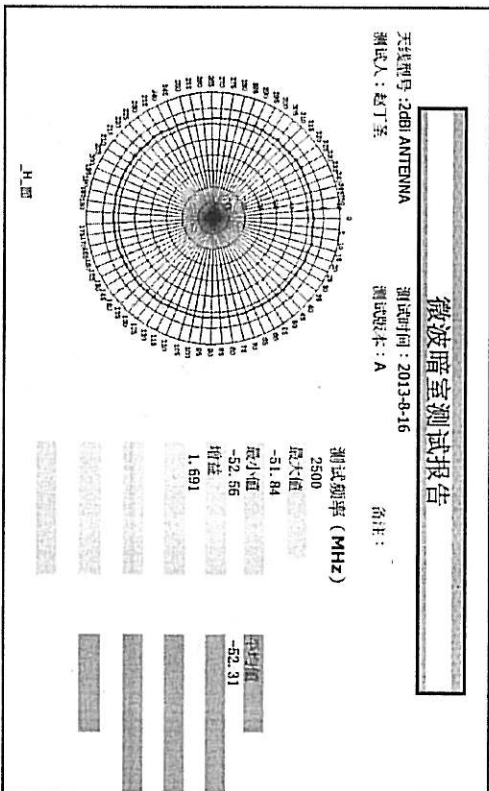
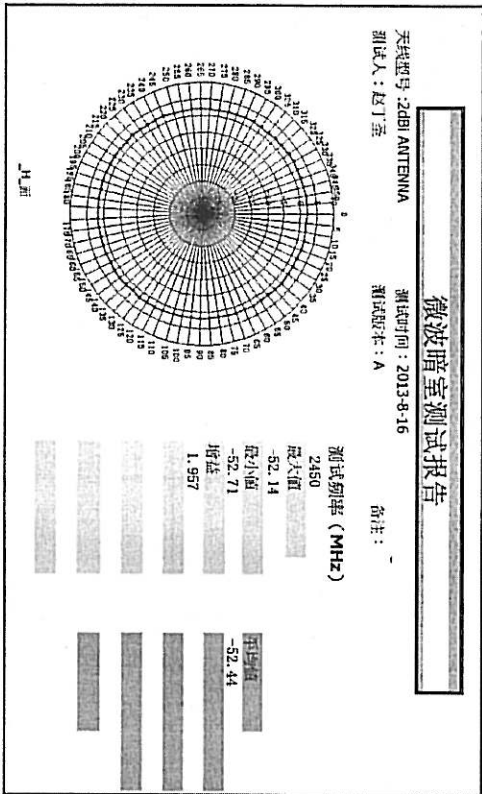

包裝方式

1. 每PCS裝PE袋，用熱封機封口。(圖一)
2. 每25PE袋裝一夾鏈袋，封口后需要貼IPCS環保標籤。(圖二)
3. 每20夾鏈袋裝一箱，然後在箱外貼pcs的外箱標籤再在外箱標籤上貼IPCS環保標籤。(圖三)

