



FCC TEST REPORT (15.247)

REPORT NO.: RF971002H04

MODEL NO.: NWD672NU

RECEIVED: Oct. 02, 2008

TESTED: Oct. 18 to Nov. 24, 2008

ISSUED: Dec. 09, 2008

APPLICANT: ZyXEL Communications Corporation

ADDRESS: No. 6, Innovation Road II, Science-Park,
Hsin-Chu, 300, Taiwan

ISSUED BY: Bureau Veritas Consumer Products Services
(H.K.) Ltd., Taoyuan Branch

TEST LOCATION: No. 81-1, Lu Liao Keng, 9th Ling,Wu Lung
Tsuen, Chiung Lin Hsiang, Hsin Chu Hsien
307, Taiwan

This test report consists of 221 pages in total. It may be duplicated completely for legal use with the approval of the applicant. It should not be reproduced except in full, without the written approval of our laboratory. The client should not use it to claim product endorsement by TAF or any government agencies. The test results in the report only apply to the tested sample.



Table of Contents

1.	CERTIFICATION	6
2.	SUMMARY OF TEST RESULTS	7
2.1	MEASUREMENT UNCERTAINTY	9
3.	GENERAL INFORMATION	10
3.1	GENERAL DESCRIPTION OF EUT	10
3.2	DESCRIPTION OF TEST MODES	13
3.2.1	TEST MODE APPLICABILITY AND TESTED CHANNEL DETAIL:	14
3.3	GENERAL DESCRIPTION OF APPLIED STANDARDS	18
3.4	DESCRIPTION OF SUPPORT UNITS.....	19
3.5	CONFIGURATION OF SYSTEM UNDER TEST	19
4.	TEST TYPES AND RESULTS (802.11B & G, 2400 ~ 2483.5MHZ BAND).....	20
4.1	CONDUCTED EMISSION MEASUREMENT	20
4.1.1	LIMITS OF CONDUCTED EMISSION MEASUREMENT	20
4.1.2	TEST INSTRUMENTS.....	20
4.1.3	TEST PROCEDURES	21
4.1.4	DEVIATION FROM TEST STANDARD	21
4.1.5	TEST SETUP	22
4.1.6	EUT OPERATING CONDITIONS	22
4.1.7	TEST RESULTS	23
4.2	RADIATED EMISSION MEASUREMENT	25
4.2.1	LIMITS OF RADIATED EMISSION MEASUREMENT	25
4.2.2	TEST INSTRUMENTS.....	26
4.2.3	TEST PROCEDURES	27
4.2.4	DEVIATION FROM TEST STANDARD	27
4.2.5	TEST SETUP	28
4.2.6	EUT OPERATING CONDITIONS	28
	BELOW 1GHZ TEST DATA.....	29
4.2.7	TEST RESULTS – DIPOLE ANTENNA.....	29
	ABOVE 1GHZ TEST DATA	30
4.2.8	TEST RESULTS – DIPOLE ANTENNA.....	30
	BELOW 1GHZ TEST DATA.....	58
4.2.9	TEST RESULTS – MONOPOLES WITH REFLECTORS ANTENNA	58
	ABOVE 1GHZ TEST DATA	59
4.2.10	TEST RESULTS – MONOPOLES WITH REFLECTORS ANTENNA	59
4.3	6DB BANDWIDTH MEASUREMENT	87
4.3.1	LIMITS OF 6DB BANDWIDTH MEASUREMENT	87
4.3.2	TEST INSTRUMENTS.....	87
4.3.3	TEST PROCEDURE.....	88



4.3.4	DEVIATION FROM TEST STANDARD	88
4.3.5	TEST SETUP	88
4.3.6	EUT OPERATING CONDITIONS	88
4.3.7	TEST RESULTS	89
4.4	MAXIMUM PEAK OUTPUT POWER.....	105
4.4.1	LIMITS OF MAXIMUM PEAK OUTPUT POWER MEASUREMENT	105
4.4.2	INSTRUMENTS.....	105
4.4.3	TEST PROCEDURES	105
4.4.4	DEVIATION FROM TEST STANDARD	105
4.4.5	TEST SETUP	105
4.4.6	EUT OPERATING CONDITIONS	105
4.4.7	TEST RESULTS	106
4.5	POWER SPECTRAL DENSITY MEASUREMENT.....	108
4.5.1	LIMITS OF POWER SPECTRAL DENSITY MEASUREMENT	108
4.5.2	TEST INSTRUMENTS.....	108
4.5.3	TEST PROCEDURE.....	108
4.5.4	DEVIATION FROM TEST STANDARD.....	108
4.5.5	TEST SETUP	108
4.5.6	EUT OPERATING CONDITION.....	108
4.5.7	TEST RESULTS	109
4.6	CONDUCTED OUT-BAND EMISSION MEASUREMENT.....	125
4.6.1	LIMITS OF CONDUCTED OUT-BAND EMISSION MEASUREMENT.....	125
4.6.2	TEST INSTRUMENTS.....	125
4.6.3	TEST PROCEDURE.....	125
4.6.4	DEVIATION FROM TEST STANDARD.....	125
4.6.5	EUT OPERATING CONDITION.....	125
4.6.6	TEST RESULTS	125
4.7	ANTENNA REQUIREMENT	142
4.7.1	STANDARD APPLICABLE.....	142
4.7.2	ANTENNA CONNECTED CONSTRUCTION.....	142
5.	TEST TYPES AND RESULTS (802.11A, 5725~5850MHZ BAND)	143
5.1	CONDUCTED EMISSION MEASUREMENT	143
5.1.1	LIMITS OF CONDUCTED EMISSION MEASUREMENT	143
5.1.2	TEST INSTRUMENTS.....	143
5.1.3	TEST PROCEDURES	144
5.1.4	DEVIATION FROM TEST STANDARD	144
5.1.5	TEST SETUP	145
5.1.6	EUT OPERATING CONDITIONS	145
5.1.7	TEST RESULTS	146
5.2	RADIATED EMISSION MEASUREMENT	148
5.2.1	LIMITS OF RADIATED EMISSION MEASUREMENT.....	148



5.2.2	TEST INSTRUMENTS.....	149
5.2.3	TEST PROCEDURES	150
5.2.4	DEVIATION FROM TEST STANDARD	150
5.2.5	TEST SETUP	151
5.2.6	EUT OPERATING CONDITIONS	151
	BELOW 1GHZ TEST DATA.....	152
5.2.7	TEST RESULTS – DIPOLE ANTENNA.....	152
	ABOVE 1GHZ TEST DATA	153
5.2.8	TEST RESULTS –DIPOLE ANTENNA.....	153
	BELOW 1GHZ TEST DATA.....	161
5.2.9	TEST RESULTS – MONOPOLES WITH REFLECTORS ANTENNA	161
	ABOVE 1GHZ TEST DATA	162
5.2.10	TEST RESULTS –MONOPOLES WITH REFLECTORS ANTENNA	162
5.3	6DB BANDWIDTH MEASUREMENT	170
5.3.1	LIMITS OF 6DB BANDWIDTH MEASUREMENT	170
5.3.2	TEST INSTRUMENTS.....	170
5.3.3	TEST PROCEDURE.....	170
5.3.4	DEVIATION FROM TEST STANDARD	170
5.3.5	TEST SETUP	170
5.3.6	EUT OPERATING CONDITIONS	170
5.3.7	TEST RESULTS	171
5.4	MAXIMUM PEAK OUTPUT POWER.....	183
5.4.1	LIMITS OF MAXIMUM PEAK OUTPUT POWER MEASUREMENT	183
5.4.2	INSTRUMENTS.....	183
5.4.3	TEST PROCEDURES	184
5.4.4	DEVIATION FROM TEST STANDARD	184
5.4.5	TEST SETUP	184
5.4.6	EUT OPERATING CONDITIONS	184
5.4.7	TEST RESULTS	185
5.5	POWER SPECTRAL DENSITY MEASUREMENT.....	189
5.5.1	LIMITS OF POWER SPECTRAL DENSITY MEASUREMENT	189
5.5.2	TEST INSTRUMENTS.....	189
5.5.3	TEST PROCEDURE.....	190
5.5.4	DEVIATION FROM TEST STANDARD	190
5.5.5	TEST SETUP	190
5.5.6	EUT OPERATING CONDITION.....	190
5.5.7	TEST RESULTS	191
5.6	CONDUCTED OUT-BAND EMISSION MEASUREMENT.....	203
5.6.1	LIMITS OF CONDUCTED OUT-BAND EMISSION MEASUREMENT.....	203
5.6.2	TEST INSTRUMENTS.....	203
5.6.3	TEST PROCEDURE.....	204



5.6.4	DEVIATION FROM TEST STANDARD	204
5.6.5	EUT OPERATING CONDITION.....	204
5.6.6	TEST RESULTS	204
5.7	ANTENNA REQUIREMENT	219
5.7.1	STANDARD APPLICABLE.....	219
5.7.2	ANTENNA CONNECTED CONSTRUCTION.....	219
6.	INFORMATION ON THE TESTING LABORATORIES	220
7.	APPENDIX-A- MODIFICATIONS RECORDERS FOR ENGINEERING CHANGES TO THE EUT BY THE LAB.....	221



A D T

1. CERTIFICATION

PRODUCT: Wireless N Dual-band WLAN Mini-PCI Adapter
BRAND NAME: ZyXEL
MODEL NO.: NWD672NU
TEST SAMPLE: ENGINEERING SAMPLE
TESTED: Oct. 18 to Nov. 24, 2008
APPLICANT: ZyXEL Communications Corporation
STANDARDS: FCC Part 15, Subpart C (Section 15.247),
ANSI C63.4-2003

The above equipment (Model: NWD672NU) has been tested by **Bureau Veritas Consumer Products Services (H.K.) Ltd., Taoyuan Branch**, and found compliance with the requirement of the above standards. The test record, data evaluation & Equipment Under Test (EUT) configurations represented herein are true and accurate accounts of the measurements of the sample's EMC characteristics under the conditions specified in this report.

PREPARED BY :  , **DATE:** Dec. 09, 2008
(Claire Kuan, Specialist)

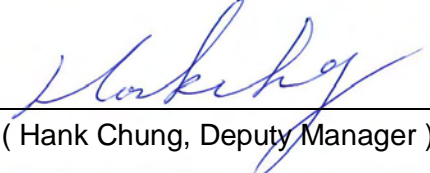
TECHNICAL ACCEPTANCE :  , **DATE:** Dec. 09, 2008
Responsible for RF (Hank Chung, Deputy Manager)

APPROVED BY :  , **DATE:** Dec. 09, 2008
(May Chen, Deputy Manager)



2. SUMMARY OF TEST RESULTS

The EUT has been tested according to the following specifications:

For 802.11b & g, 2412~2462MHz Band

APPLIED STANDARD: FCC Part 15, Subpart C (Section 15.247)			
Standard Section	Test Type and Limit	Result	Remark
15.207	AC Power Conducted Emission	PASS	Meet the requirement of limit. Minimum passing margin is -16.25dB at 0.150MHz
15.247(a)(2)	Spectrum Bandwidth of a Direct Sequence Spread Spectrum System Limit: min. 500kHz	PASS	Meet the requirement of limit.
15.247(b)	Maximum Peak Output Power Limit: max. 30dBm	PASS	Meet the requirement of limit.
15.247(d)	Radiated Emissions Limit: Table 15.209	PASS	Meet the requirement of limit. Minimum passing margin is -0.55dB at 2483.50MHz
15.247(e)	Power Spectral Density Limit: max. 8dBm	PASS	Meet the requirement of limit.
15.247(d)	Band Edge Measurement Limit: 20dB less than the peak value of fundamental frequency	PASS	Meet the requirement of limit.



A D T

For 802.11a, 5725~5850MHz Band

APPLIED STANDARD: FCC Part 15, Subpart C (Section 15.247)			
Standard Section	Test Type and Limit	Result	Remark
15.207	AC Power Conducted Emission	PASS	Meet the requirement of limit. Minimum passing margin is -15.04dB at 0.173MHz
15.247(a)(2)	Spectrum Bandwidth of a Direct Sequence Spread Spectrum System Limit: min. 500kHz	PASS	Meet the requirement of limit.
15.247(b)	Maximum Peak Output Power Limit: max. 30dBm	PASS	Meet the requirement of limit.
15.247(d)	Radiated Emissions Limit: Table 15.209	PASS	Meet the requirement of limit. Minimum passing margin is -3.40dB at 166.52MHz
15.247(e)	Power Spectral Density Limit: max. 8dBm	PASS	Meet the requirement of limit.
15.247(d)	Band Edge Measurement Limit: 20dB less than the peak value of fundamental frequency	PASS	Meet the requirement of limit.

NOTE:

1. The EUT was operating in 2400 ~ 2483.5MHz, 5.15~5.35GHz and 5.725~5.850GHz frequencies band. This report was recorded the RF parameters including 2400 ~ 2483.5MHz and 5.725~5.850GHz. For the 5.15~5.35GHz RF parameters was recorded in another test report.



2.1 MEASUREMENT UNCERTAINTY

Where relevant, the following measurement uncertainty levels have been estimated for tests performed on the EUT as specified in CISPR 16-4:

This uncertainty represents an expanded uncertainty expressed at approximately the 95% confidence level using a coverage factor of $k=2$.

Measurement	Value
Conducted emissions	2.44 dB
Radiated emissions (30MHz-1GHz)	3.94 dB
Radiated emissions (1GHz -18GHz)	2.33 dB
Radiated emissions (18GHz -40GHz)	2.56 dB



3. GENERAL INFORMATION

3.1 GENERAL DESCRIPTION OF EUT

PRODUCT	Wireless N Dual-band WLAN Mini-PCI Adapter
MODEL NO.	NWD672NU
FCC ID	I88NWD672NU
POWER SUPPLY	DC 3.3V ± 5% from host equipment
MODULATION TYPE	CCK, DQPSK, DBPSK for DSSS 64QAM, 16QAM, QPSK, BPSK for OFDM
MODULATION TECHNOLOGY	DSSS, OFDM
TRANSFER RATE	802.11b: 11 / 5.5 / 2 / 1Mbps 802.11g: 54 / 48 / 36 / 24 / 18 / 12 / 9 / 6Mbps 802.11a: 54 / 48 / 36 / 24 / 18 / 12 / 9 / 6Mbps HT20 MCS0~7 (400ns GI): 72.2 / 65 / 57.8 / 43.3 / 28.9 / 21.7 / 14.4 / 7.2Mbps. HT20 MCS8~15 (400ns GI): 144.444 / 130 / 115.556 / 86.667 / 57.778 / 43.333 / 28.889 / 14.444Mbps. HT40 MCS0~7 (400ns GI): 150 / 135 / 120 / 90 / 60 / 45 / 30 / 15Mbps. HT40 MCS8~15 (400ns GI): 300 / 270 / 240 / 180 / 120 / 90 / 60 / 30Mbps.
FREQUENCY RANGE	For 15.407 802.11a: 5.18 ~ 5.24GHz For 15.247 802.11b & 802.11g: 2412 ~ 2462MHz 802.11a: 5.745 ~ 5.825GHz
NUMBER OF CHANNEL	For 15.407 4 for 802.11a, draft 802.11n (20MHz) 2 for draft 802.11n (40MHz) For 15.247(2.4GHz) 11 for 802.11b, 802.11g, draft 802.11n (20MHz) 7 for draft 802.11n (40MHz) For 15.247(5GHz) 5 for 802.11a, draft 802.11n (20MHz) 2 for draft 802.11n (40MHz)



MAXIMUM OUTPUT POWER	<p>For 15.407 802.11a: 16.255mW draft 802.11n (20MHz): 28.202mW draft 802.11n (40MHz): 45.916mW</p> <p>For 15.247(2.4GHz) 802.11b: 97.724mW 802.11g: 196.789mW draft 802.11n (20MHz): 406.532mW draft 802.11n (40MHz): 340.424mW</p> <p>For 15.247(5GHz) 802.11a: 578.096mW draft 802.11n (20MHz): 484.552mW draft 802.11n (40MHz): 540.282mW</p>
ANTENNA TYPE	Please see note 1
DATA CABLE	NA
INTERFACE	USB
ASSOCIATED DEVICES	NA

NOTE:

1. There are two antennas provided to this EUT, please refer to the following table:

No	Model No.	Antenna Gain	For 2.4GHz Gain (dBi)	For 5.15~5.25GHz Gain (dBi)	For 5.725~5.850GHz Gain (dBi)	Antenna Type	Connector
1	C034-510656-A (SSR-72241)	Gain (dBi)	3.66	2.61	2.91	Dipole	SMA Plug Reverse
		Cable Loss (dB)	1.18	2.06	2.56		
		Net Gain (dB)	2.48	0.55	0.35		
2	N2480-100C	Gain (dBi)	6.00	5.10	8.00	Monopoles with reflectors	I-PEX
		Cable Loss (dB)	1.00	1.00	1.00		
		Net Gain (dB)	5.00	4.10	7.00		

2. The EUT incorporates a MIMO function with 802.11a, 802.11b, 802.11g, draft 802.11n. Physically, the EUT provides three completed transmit and three completed receivers.

3. The EUT is 3 * 3 spatial MIMO (3Tx & 3Rx) without beam forming function. The antenna configurations are three transmitter antennas and three receiver antennas, as there are three dipole antennas and three Monopoles with reflectors antennas. Spatial multiplexing modes for simultaneous transmission using 3 antennas, and for simultaneous receiver using 3 antennas. The 11a and 11bg legacy mode is limited to single transmitter only.



4. When the EUT operating in draft 802.11n, the software operation, which is defined by manufacturer, MCS (Modulation and Coding Schemes) from 0 to 15.
5. The EUT complies with draft 802.11n standards and backwards compatible with 802.11a, 802.11b, 802.11g products.
6. The above EUT information was declared by manufacturer and for more detailed features description, please refer to the manufacturer's specifications or user's manual.



3.2 DESCRIPTION OF TEST MODES

Operated in 2400 ~ 2483.5MHz band:

Eleven channels are provided for 802.11b, 802.11g, draft 802.11n (20MHz):

CHANNEL	FREQUENCY	CHANNEL	FREQUENCY
1	2412MHz	7	2442MHz
2	2417MHz	8	2447MHz
3	2422MHz	9	2452MHz
4	2427MHz	10	2457MHz
5	2432MHz	11	2462MHz
6	2437MHz		

Seven channels are provided for draft 802.11n (40MHz):

CHANNEL	FREQUENCY	CHANNEL	FREQUENCY
1	2422MHz	5	2442MHz
2	2427MHz	6	2447MHz
3	2432MHz	7	2452MHz
4	2437MHz		

Operated in 5725 ~ 5850MHz band:

Five channels are provided for 802.11a, draft 802.11n (20MHz):

CHANNEL	FREQUENCY	CHANNEL	FREQUENCY
1	5745 MHz	4	5805 MHz
2	5765 MHz	5	5825 MHz
3	5785 MHz		

Two channels are provided for draft 802.11n (40MHz):

CHANNEL	FREQUENCY
1	5755 MHz
2	5795 MHz



3.2.1 TEST MODE APPLICABILITY AND TESTED CHANNEL DETAIL:

EUT CONFIGURE MODE	APPLICABLE TO				DESCRIPTION
	PLC	RE < 1G	RE ≥ 1G	APCM	
-	√	√	√	√	-

Where PLC: Power Line Conducted Emission

RE < 1G: Radiated Emission below 1GHz

RE ≥ 1G: Radiated Emission above 1GHz

APCM: Antenna Port Conducted Measurement

ANTENNA COMBINATION MODE:

COMBINATION MODE	OPERATION MODE	CHAIN(0) (TX)	CHAIN(1) (TX)	CHAIN(2) (TX)
A	802.11a	√		
B	802.11b	√		
C	802.11g	√		
D	DRAFT 802.11n(20MHz)	√	√	√
E	DRAFT 802.11n(40MHz)	√	√	√

Note:

1. The above information was declared by manufacturer and for more detailed features description, please refer to the manufacturer's specifications or user's manual.
2. Antenna 1 is Dipole antenna & Antenna 2 is Monopoles with reflectors antenna.



POWER LINE CONDUCTED EMISSION TEST:

- Pre-Scan has been conducted to determine the worst-case mode from all possible combinations between available modulations, data rates and antenna ports (if EUT with antenna diversity architecture).
- Following channel(s) was (were) selected for the final test as listed below.

MODE	AVAILABLE CHANNEL	TESTED CHANNEL	MODULATION TECHNOLOGY	MODULATION TYPE	DATA RATE (Mbps)	TX COMBINATION
For 2.4 GHz Draft 802.11n (20MHz)	1 to 11	6	OFDM	BPSK	14.444	D
For 5 GHz 802.11a	1 to 5	1	OFDM	BPSK	6	A

RADIATED EMISSION TEST (BELOW 1 GHz):

- Pre-Scan has been conducted to determine the worst-case mode from all possible combinations between available modulations, data rates and antenna ports (if EUT with antenna diversity architecture).
- Following channel(s) was (were) selected for the final test as listed below.

MODE	AVAILABLE CHANNEL	TESTED CHANNEL	MODULATION TECHNOLOGY	MODULATION TYPE	DATA RATE (Mbps)	TX COMBINATION
For 2.4 GHz 802.11b	1 to 11	1	DSSS	DBPSK	1	B
For 5 GHz 802.11a	1 to 5	1	OFDM	BPSK	6	A

- The EUT was tested as the following test modes:

Test Mode	Description
Mode 1	Antenna 1
Mode 2	Antenna 2

**RADIATED EMISSION TEST (ABOVE 1 GHz):**

- Pre-Scan has been conducted to determine the worst-case mode from all possible combinations between available modulations, data rates and antenna ports (if EUT with antenna diversity architecture).
- Following channel(s) was (were) selected for the final test as listed below.

MODE	AVAILABLE CHANNEL	TESTED CHANNEL	MODULATION TECHNOLOGY	MODULATION TYPE	DATA RATE (Mbps)	TX COMBINATION
802.11b	1 to 11	1, 6, 11	DSSS	DBPSK	1	B
802.11g	1 to 11	1, 6, 11	OFDM	BPSK	6	C
For 2.4 GHz Draft 802.11n (20MHz)	1 to 11	1, 6, 11	OFDM	BPSK	14.444	D
For 2.4 GHz Draft 802.11n (40MHz)	1 to 7	1, 4, 7	OFDM	BPSK	30	E
802.11a	1 to 5	1,3, 5	OFDM	BPSK	6	A
For 5 GHz Draft 802.11n (20MHz)	1 to 5	1,3, 5	OFDM	BPSK	14.444	D
For 5 GHz Draft 802.11n (40MHz)	1 to 2	1, 2	OFDM	BPSK	30	E

- The EUT was tested as the following test modes:

Test Mode	Description
Mode 1	Antenna 1
Mode 2	Antenna 2

CONDUCTED OUT-BAND EMISSION MEASUREMENT:

- Pre-Scan has been conducted to determine the worst-case mode from all possible combinations between available modulations, data rates and antenna ports (if EUT with antenna diversity architecture).
- Following channel(s) was (were) selected for the final test as listed below.

MODE	AVAILABLE CHANNEL	TESTED CHANNEL	MODULATION TECHNOLOGY	MODULATION TYPE	DATA RATE (Mbps)	TX COMBINATION
802.11b	1 to 11	1, 11	DSSS	DBPSK	1	B
802.11g	1 to 11	1, 11	OFDM	BPSK	6	C
For 2.4 GHz Draft 802.11n (20MHz)	1 to 11	1, 11	OFDM	BPSK	14.444	D
For 2.4 GHz Draft 802.11n (40MHz)	1 to 7	1, 7	OFDM	BPSK	30	E
802.11a	1 to 5	1, 5	OFDM	BPSK	6	A
For 5 GHz Draft 802.11n (20MHz)	1 to 5	1, 5	OFDM	BPSK	14.444	D
For 5 GHz Draft 802.11n (40MHz)	1 to 2	1, 2	OFDM	BPSK	30	E



ANTENNA PORT CONDUCTED MEASUREMENT:

- Pre-Scan has been conducted to determine the worst-case mode from all possible combinations between available modulations, data rates and antenna ports (if EUT with antenna diversity architecture).
- Following channel(s) was (were) selected for the final test as listed below.

MODE	AVAILABLE CHANNEL	TESTED CHANNEL	MODULATION TECHNOLOGY	MODULATION TYPE	DATA RATE (Mbps)	TX COMBINATION
802.11b	1 to 11	1, 6, 11	DSSS	DBPSK	1	B
802.11g	1 to 11	1, 6, 11	OFDM	BPSK	6	C
For 2.4 GHz Draft 802.11n (20MHz)	1 to 11	1, 6, 11	OFDM	BPSK	14.444	D
For 2.4 GHz Draft 802.11n (40MHz)	1 to 7	1, 4, 7	OFDM	BPSK	30	E
802.11a	1 to 5	1,3, 5	OFDM	BPSK	6	A
For 5 GHz Draft 802.11n (20MHz)	1 to 5	1,3, 5	OFDM	BPSK	14.444	D
For 5 GHz Draft 802.11n (40MHz)	1 to 2	1, 2	OFDM	BPSK	30	E



3.3 GENERAL DESCRIPTION OF APPLIED STANDARDS

The EUT is a Wireless N Dual-band WLAN Mini-PCI Adapter. According to the specifications of the manufacturer, it must comply with the requirements of the following standards:

FCC Part 15, Subpart C. (15.247)

ANSI C63.4-2003

All test items have been performed and recorded as per the above standards.

NOTE: The EUT is also considered as a kind of computer peripheral, because the connection to computer is necessary for typical use. It has been verified to comply with the requirements of FCC Part 15, Subpart B, Class B (DoC). The test report has been issued separately.



3.4 DESCRIPTION OF SUPPORT UNITS

The EUT has been tested as an independent unit together with other necessary accessories or support units. The following support units or accessories were used to form a representative test configuration during the tests.

NO.	PRODUCT	BRAND	MODEL NO.	SERIAL NO.	FCC ID
1	NOTEBOOK COMPUTER	HP	HSTNN-S19C	WFY93-WQ98K-BH 87F-KD366-RB773	FCC DoC

NO.	SIGNAL CABLE DESCRIPTION OF THE ABOVE SUPPORT UNITS
1	NA

NOTE: All power cords of the above support units are non shielded (1.8m).

3.5 CONFIGURATION OF SYSTEM UNDER TEST

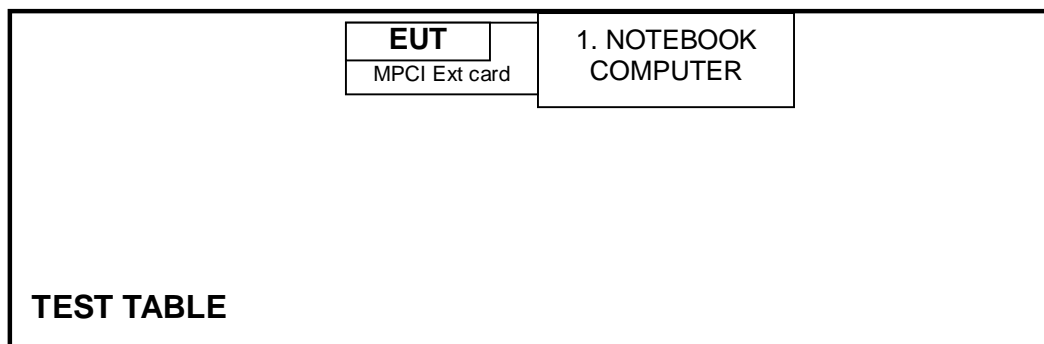



4. TEST TYPES AND RESULTS (802.11b & g, 2400 ~ 2483.5MHz Band)

4.1 CONDUCTED EMISSION MEASUREMENT

4.1.1 LIMITS OF CONDUCTED EMISSION MEASUREMENT

FREQUENCY OF EMISSION (MHz)	CONDUCTED LIMIT (dB μ V)	
	Quasi-peak	Average
0.15-0.5	66 to 56	56 to 46
0.5-5	56	46
5-30	60	50

- NOTE:**
1. The lower limit shall apply at the transition frequencies.
 2. The limit decreases in line with the logarithm of the frequency in the range of 0.15 to 0.50 MHz.
 3. All emanations from a class A/B digital device or system, including any network of conductors and apparatus connected thereto, shall not exceed the level of field strengths specified above.

4.1.2 TEST INSTRUMENTS

DESCRIPTION & MANUFACTURER	MODEL NO.	SERIAL NO.	CALIBRATED DATE	CALIBRATED UNTIL
Test Receiver	ESCS 30	847124/029	Feb. 29, 2008	Feb. 28, 2009
Line-Impedance Stabilization Network(for EUT)	ENV-216	100071	Nov. 27, 2007	Nov. 26, 2008
Line-Impedance Stabilization Network(for Peripheral)	ESH3-Z5	848773/004	Nov. 08, 2008	Nov. 07, 2009
RF Cable (JYEBAO)	5DFB	COBCAB-001	July 24, 2008	July 23, 2009
50 ohms Terminator	50	3	Nov. 15, 2008	Nov. 15, 2009
Software	BV ADT_Cond_V7.3.6	NA	NA	NA

Note:

1. The calibration interval of the above test instruments is 12 months and the calibrations are traceable to NML/ROC and NIST/USA.
2. The test was performed in Shielded Room No. B.
3. The VCCI Con B Registration No. is C-2193.



4.1.3 TEST PROCEDURES

- a. The EUT was placed 0.4 meters from the conducting wall of the shielded room with EUT being connected to the power mains through a line impedance stabilization network (LISN). Other support units were connected to the power mains through another LISN. The two LISNs provide 50 ohm/ 50uH of coupling impedance for the measuring instrument.
- b. Both lines of the power mains connected to the EUT were checked for maximum conducted interference.
- c. The frequency range from 150kHz to 30MHz was searched. Emission levels under (Limit - 20dB) were not recorded.

4.1.4 DEVIATION FROM TEST STANDARD

No deviation

4.1.5 TEST SETUP

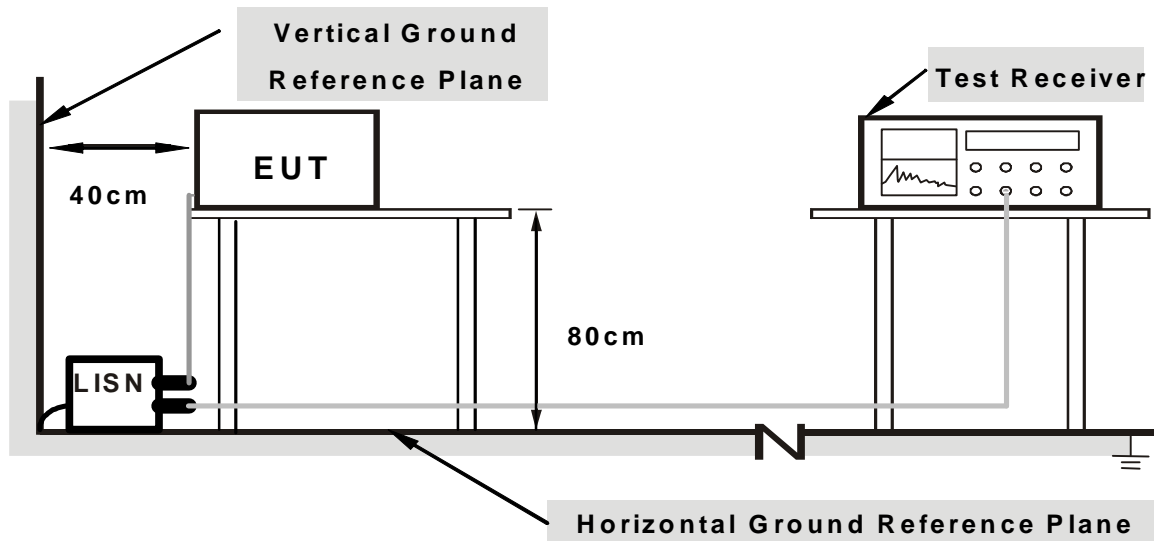

Note: 1.Support units were connected to second LISN.

2.Both of LISNs (AMN) are 80 cm from EUT and at least 80 from other units and other metal planes

For the actual test configuration, please refer to the related item – Photographs of the Test Configuration.

4.1.6 EUT OPERATING CONDITIONS

- a. Plug the EUT into test board and placed on the testing table.
- b. The support unit 1 (Notebook computer) ran a test program “ART_v0_5_B26all” to enable EUT under transmission condition continuously.

4.1.7 TEST RESULTS

802.11g OFDM MODULATION :

EUT TEST CONDITION		MEASUREMENT DETAIL	
CHANNEL	Channel 6	PHASE	Line (L)
MODULATION TYPE	BPSK	6dB BANDWIDTH	9 kHz
TRANSFER RATE	6Mbps	INPUT POWER (SYSTEM)	120Vac, 60 Hz
ENVIRONMENTAL CONDITIONS	25deg. C, 65%RH, 965hPa	TESTED BY	Phoenix Huang

No	Freq. [MHz]	Corr. Factor (dB)	Reading Value [dB (uV)]		Emission Level [dB (uV)]		Limit [dB (uV)]		Margin (dB)	
			Q.P.	AV.	Q.P.	AV.	Q.P.	AV.	Q.P.	AV.
	1	0.150	9.67	40.08	-	49.75	-	66.00	56.00	-16.25
2	0.177	9.69	38.03	-	47.72	-	64.61	54.61	-16.89	-
3	0.232	9.74	32.53	-	42.27	-	62.38	52.38	-20.11	-
4	3.676	9.75	27.95	-	37.70	-	56.00	46.00	-18.30	-
5	3.762	9.76	26.89	-	36.65	-	56.00	46.00	-19.35	-
6	11.086	9.86	19.11	-	28.97	-	60.00	50.00	-31.03	-

- REMARKS:**
1. Q.P. and AV. are abbreviations of quasi-peak and average individually.
 2. "-": The Quasi-peak reading value also meets average limit and measurement with the average detector is unnecessary.
 3. The emission levels of other frequencies were very low against the limit.
 4. Margin value = Emission level - Limit value
 5. Correction factor = Insertion loss + Cable loss
 6. Emission Level = Correction Factor + Reading Value.

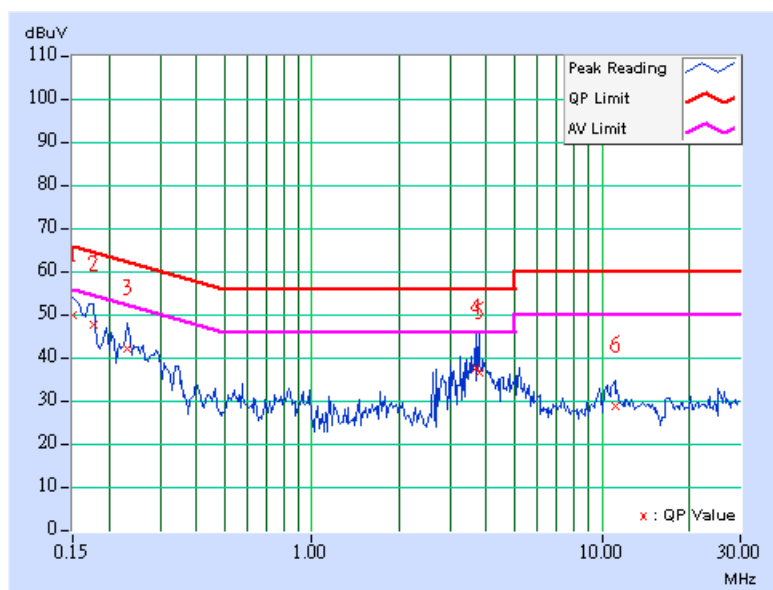



EUT TEST CONDITION		MEASUREMENT DETAIL	
CHANNEL	Channel 6	PHASE	Neutral (N)
MODULATION TYPE	BPSK	6dB BANDWIDTH	9 kHz
TRANSFER RATE	6Mbps	INPUT POWER (SYSTEM)	120Vac, 60 Hz
ENVIRONMENTAL CONDITIONS	25deg. C, 65%RH, 965hPa	TESTED BY	Phoenix Huang

No	Freq. [MHz]	Corr. Factor (dB)	Reading Value [dB (uV)]		Emission Level [dB (uV)]		Limit [dB (uV)]		Margin (dB)	
			Q.P.	AV.	Q.P.	AV.	Q.P.	AV.	Q.P.	AV.
	1	0.150	9.67	39.88	-	49.55	-	66.00	56.00	-16.45
2	0.170	9.68	38.37	-	48.05	-	64.98	54.98	-16.93	-
3	0.232	9.74	31.64	-	41.38	-	62.38	52.38	-21.00	-
4	3.301	9.75	22.87	-	32.62	-	56.00	46.00	-23.38	-
5	3.848	9.76	24.60	-	34.36	-	56.00	46.00	-21.64	-
6	11.219	9.90	14.78	-	24.68	-	60.00	50.00	-35.32	-

- REMARKS:**
1. Q.P. and AV. are abbreviations of quasi-peak and average individually.
 2. "-": The Quasi-peak reading value also meets average limit and measurement with the average detector is unnecessary.
 3. The emission levels of other frequencies were very low against the limit.
 4. Margin value = Emission level - Limit value
 5. Correction factor = Insertion loss + Cable loss
 6. Emission Level = Correction Factor + Reading Value.

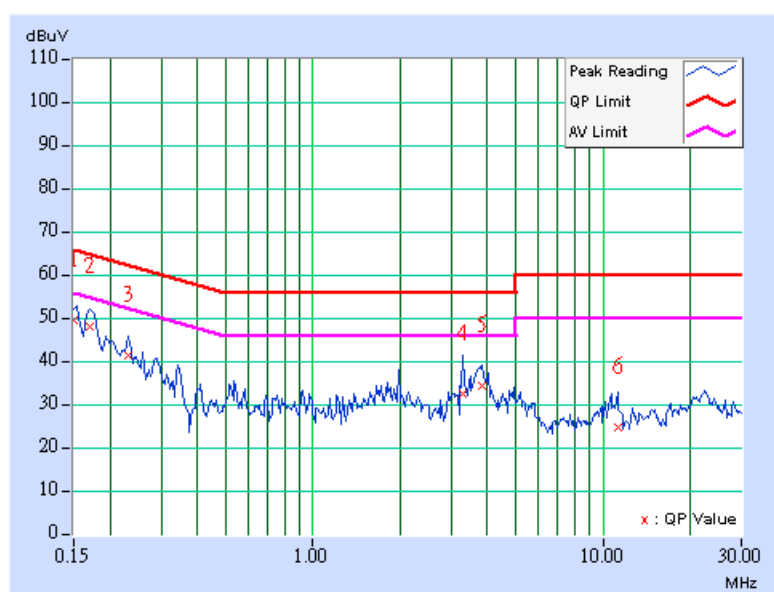



4.2 RADIATED EMISSION MEASUREMENT

4.2.1 LIMITS OF RADIATED EMISSION MEASUREMENT

Emissions radiated outside of the specified bands, shall be according to the general radiated limits in 15.209 as following:

Frequencies (MHz)	Field strength (microvolts/meter)	Measurement distance (meters)
0.009-0.490	2400/F(kHz)	300
0.490-1.705	24000/F(kHz)	30
1.705-30.0	30	30
30-88	100	3
88-216	150	3
216-960	200	3
Above 960	500	3

NOTE:

1. The lower limit shall apply at the transition frequencies.
2. Emission level (dBuV/m) = 20 log Emission level (uV/m).
3. As shown in 15.35(b), for frequencies above 1000MHz, the field strength limits are based on average detector, however, the peak field strength of any emission shall not exceed the maximum permitted average limits, specified above by more than 20dB under any condition of modulation.



A D T

4.2.2 TEST INSTRUMENTS

DESCRIPTION & MANUFACTURER	MODEL NO.	SERIAL NO.	CALIBRATED DATE	CALIBRATED UNTIL
ADVANTEST Spectrum Analyzer	R3271A	85060311	July 16, 2008	July 15, 2009
HP Pre_Amplifier	8449B	3008A0192 2	Sep. 25, 2008	Sep. 24, 2009
ROHDE & SCHWARZ Test Receiver	ESCS30	100375	April 01, 2008	Mar. 31, 2009
SCHWARZBECK TRILOG Broadband Antenna	VULB 9168	138	April 30, 2008	April 29, 2009
Schwarzbeck Horn_Antenna	BBHA9120	D124	Dec. 17, 2007	Dec. 16, 2008
Schwarzbeck Horn_Antenna	BBHA 9170	BBHA91701 53	Jan. 28, 2008	Jan. 27, 2009
R&S Loop Antenna	HFH2-Z2	100070	Jan. 14, 2008	Jan. 13, 2009
RF Switches	EMH-011	08009	Oct. 07, 2008	Oct. 06, 2009
RF CABLE (Chaintek)	SF102	22054-2	Dec. 07, 2007	Dec. 06, 2008
RF Cable	8DFB	STCCAB-30 M-1GHz	Oct. 07, 2008	Oct. 06, 2009
Software	ADT_Radiated _V7.6.15.9.2	NA	NA	NA
CT Antenna Tower & Turn Table	NA	NA	NA	NA

- Note: 1. The calibration interval of the above test instruments is 12 months and the calibrations are traceable to NML/ROC and NIST/USA.
2. The horn antenna, HP preamplifier (model: 8449B) and Spectrum Analyzer (model: R3271A) are used only for the measurement of emission frequency above 1GHz if tested.
3. The test was performed in Open Site No. C.
4. The FCC Site Registration No. is 656396.
5. The VCCI Site Registration No. is R-1626.
6. The CANADA Site Registration No. is IC 7450G-3.



4.2.3 TEST PROCEDURES

- a. The EUT was placed on the top of a rotating table 0.8 meters above the ground at a 10 meter open area test site. The table was rotated 360 degrees to determine the position of the highest radiation.
- b. The EUT was set 3 meters away from the interference-receiving antenna, which was mounted on the top of a variable-height antenna tower.
- c. The antenna is a broadband antenna, and its height is varied from one meter to four meters above the ground to determine the maximum value of the field strength. Both horizontal and vertical polarizations of the antenna are set to make the measurement.
- d. For each suspected emission, the EUT was arranged to its worst case and then the antenna was tuned to heights from 1 meter to 4 meters and the rotatable table was turned from 0 degrees to 360 degrees to find the maximum reading.
- e. The test-receiver system was set to Peak Detect Function and Specified Bandwidth with Maximum Hold Mode.
- f. If the emission level of the EUT in peak mode was 10dB lower than the limit specified, then testing could be stopped and the peak values of the EUT would be reported. Otherwise the emissions that did not have 10dB margin would be re-tested one by one using peak, quasi-peak or average method as specified and then reported in a data sheet.

NOTE:

1. The resolution bandwidth and video bandwidth of test receiver/spectrum analyzer is 120kHz for Peak detection (PK) and Quasi-peak detection (QP) at frequency below 1GHz.
2. The resolution bandwidth of test receiver/spectrum analyzer is 1 MHz and the video bandwidth is 3 MHz for Peak detection (PK) at frequency above 1GHz.
3. The resolution bandwidth of test receiver/spectrum analyzer is 1 MHz and the video bandwidth is 10 Hz for Average detection (AV) at frequency above 1GHz.

4.2.4 DEVIATION FROM TEST STANDARD

No deviation

4.2.5 TEST SETUP

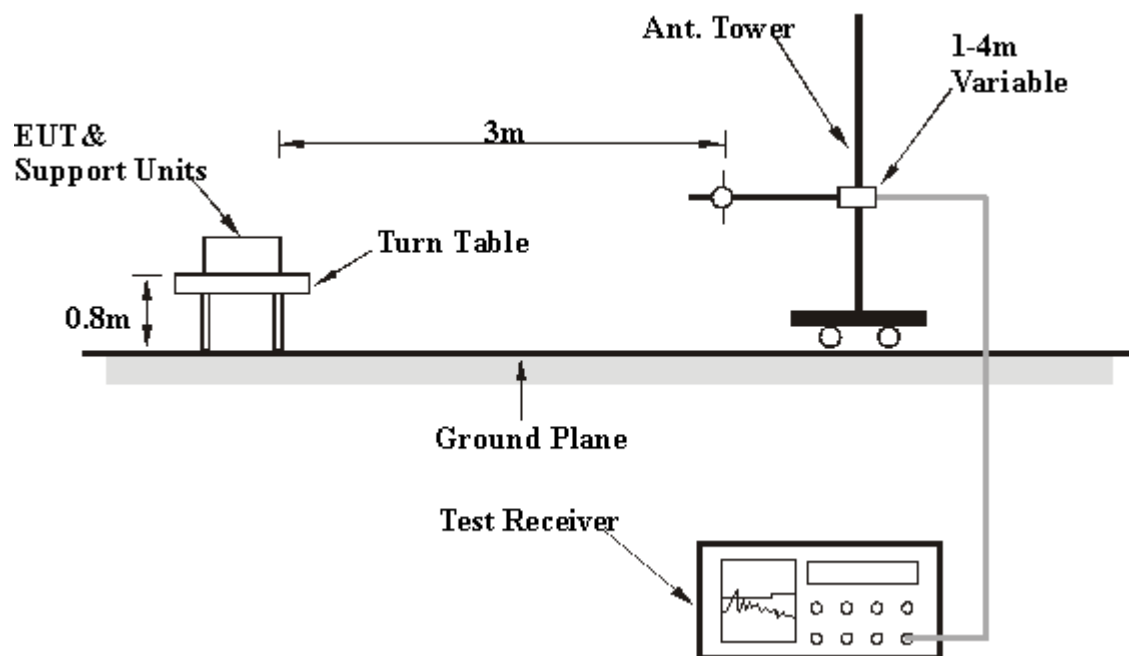

For the actual test configuration, please refer to the related item – Photographs of the Test Configuration.

4.2.6 EUT OPERATING CONDITIONS

Same as the 4.1.6



A D T

Below 1GHz Test Data

4.2.7 TEST RESULTS –DIPOLE ANTENNA

BELOW 1GHz WORST-CASE DATA : 802.11b DSSS MODULATION

EUT TEST CONDITION		MEASUREMENT DETAIL	
CHANNEL	Channel 1	FREQUENCY RANGE	Below 1000MHz
INPUT POWER (SYSTEM)	120Vac, 60 Hz	DETECTOR FUNCTION	Quasi-Peak
ENVIRONMENTAL CONDITIONS	25deg. C, 65%RH 965hPa	TESTED BY	Eric Lin

ANTENNA POLARITY & TEST DISTANCE: HORIZONTAL AT 3 M								
NO.	FREQ. (MHz)	EMISSION LEVEL (dBuV/m)	LIMIT (dBuV/m)	MARGIN (dB)	ANTENNA HEIGHT (m)	TABLE ANGLE (Degree)	RAW VALUE (dBuV)	CORRECTION FACTOR (dB/m)
1	133.34	34.34 QP	43.50	-9.16	1.05 H	3	19.74	14.60
2	166.53	39.57 QP	43.50	-3.93	1.54 H	256	24.16	15.41
3	266.34	42.63 QP	46.00	-3.37	2.03 H	326	26.67	15.96
4	298.84	42.64 QP	46.00	-3.36	1.44 H	281	25.66	16.98
5	333.00	40.91 QP	46.00	-5.09	2.10 H	221	22.54	18.37
6	399.76	36.84 QP	46.00	-9.16	2.00 H	54	15.71	21.13
7	433.02	27.46 QP	46.00	-18.54	1.65 H	32	5.82	21.64
8	500.00	28.03 QP	46.00	-17.97	1.33 H	283	5.37	22.66
9	651.49	35.78 QP	46.00	-10.22	1.98 H	222	9.84	25.94

ANTENNA POLARITY & TEST DISTANCE: VERTICAL AT 3 M								
NO.	FREQ. (MHz)	EMISSION LEVEL (dBuV/m)	LIMIT (dBuV/m)	MARGIN (dB)	ANTENNA HEIGHT (m)	TABLE ANGLE (Degree)	RAW VALUE (dBuV)	CORRECTION FACTOR (dB/m)
1	133.52	32.14 QP	43.50	-11.36	1.20 V	325	17.53	14.61
2	166.60	32.65 QP	43.50	-10.85	1.08 V	2	17.25	15.40
3	199.92	25.13 QP	43.50	-18.37	1.52 V	100	12.14	12.99
4	213.78	25.48 QP	43.50	-18.02	1.82 V	54	11.83	13.65
5	233.52	27.69 QP	46.00	-18.31	2.22 V	293	13.07	14.62
6	266.98	37.12 QP	46.00	-8.88	1.80 V	326	21.14	15.98
7	333.10	25.44 QP	46.00	-20.56	1.52 V	89	7.07	18.37
8	396.66	33.53 QP	46.00	-12.47	1.41 V	201	12.53	21.00
9	401.00	30.19 QP	46.00	-15.81	1.98 V	247	9.03	21.16

REMARKS: 1. Emission level (dBuV/m) = Raw Value (dBuV) + Correction Factor (dB/m).

2. Correction Factor (dB/m) = Antenna Factor (dB/m) + Cable Factor (dB).

3. The other emission levels were very low against the limit.

4. Margin value = Emission level – Limit value.



Above 1GHz Test Data

4.2.8 TEST RESULTS – DIPOLE ANTENNA

802.11b DSSS MODULATION

EUT TEST CONDITION		MEASUREMENT DETAIL	
CHANNEL	Channel 1	FREQUENCY RANGE	1 ~ 25GHz
INPUT POWER (SYSTEM)	120Vac, 60 Hz	DETECTOR FUNCTION	Peak (PK) Average (AV)
ENVIRONMENTAL CONDITIONS	27deg. C, %RH 965hPa	TESTED BY	Frank Liu

ANTENNA POLARITY & TEST DISTANCE: HORIZONTAL AT 3 M								
NO.	FREQ. (MHz)	EMISSION LEVEL (dBuV/m)	LIMIT (dBuV/m)	MARGIN (dB)	ANTENNA HEIGHT (m)	TABLE ANGLE (Degree)	RAW VALUE (dBuV)	CORRECTION FACTOR (dB/m)
1	2389.68	55.00 PK	74.00	-19.00	1.35 H	60	24.94	30.06
2	2389.68	43.07 AV	54.00	-10.93	1.35 H	60	13.01	30.06
3	*2412.00	101.52 PK			1.33 H	183	71.37	30.15
4	*2412.00	91.71 AV			1.33 H	183	61.56	30.15
5	4824.00	49.86 PK	74.00	-24.14	1.49 H	113	14.40	35.46
6	4824.00	44.24 AV	54.00	-9.76	1.49 H	113	8.78	35.46
7	#7236.00	51.10 PK	81.52	-30.42	1.40 H	102	9.25	41.85
8	#7236.00	38.10 AV	71.71	-33.61	1.40 H	102	-3.75	41.85
ANTENNA POLARITY & TEST DISTANCE: VERTICAL AT 3 M								
NO.	FREQ. (MHz)	EMISSION LEVEL (dBuV/m)	LIMIT (dBuV/m)	MARGIN (dB)	ANTENNA HEIGHT (m)	TABLE ANGLE (Degree)	RAW VALUE (dBuV)	CORRECTION FACTOR (dB/m)
1	2386.64	58.28 PK	74.00	-15.72	1.41 V	81	28.23	30.05
2	2386.64	45.77 AV	54.00	-8.23	1.41 V	81	15.72	30.05
3	*2412.00	110.84 PK			1.42 V	279	80.69	30.15
4	*2412.00	100.02 AV			1.42 V	279	69.87	30.15
5	4824.00	54.30 PK	74.00	-19.70	1.29 V	140	18.84	35.46
6	4824.00	50.63 AV	54.00	-3.37	1.29 V	140	15.17	35.46
7	#7236.00	51.73 PK	90.84	-39.11	1.42 V	188	9.88	41.85
8	#7236.00	38.23 AV	80.02	-41.79	1.42 V	188	-3.62	41.85

- REMARKS:**
1. Emission level (dBuV/m) = Raw Value (dBuV) + Correction Factor (dB/m).
 2. Correction Factor (dB/m) = Antenna Factor (dB/m) + Cable Factor (dB).
 3. The other emission levels were very low against the limit.
 4. Margin value = Emission level – Limit value.
 5. “ * “: Fundamental frequency.
 6. "#":The radiated frequency is out the restricted band.



A D T

EUT TEST CONDITION		MEASUREMENT DETAIL	
CHANNEL	Channel 6	FREQUENCY RANGE	1 ~ 25GHz
INPUT POWER (SYSTEM)	120Vac, 60 Hz	DETECTOR FUNCTION	Peak (PK) Average (AV)
ENVIRONMENTAL CONDITIONS	27deg. C, %RH 965hPa	TESTED BY	Frank Liu

ANTENNA POLARITY & TEST DISTANCE: HORIZONTAL AT 3 M								
NO.	FREQ. (MHz)	EMISSION LEVEL (dBuV/m)	LIMIT (dBuV/m)	MARGIN (dB)	ANTENNA HEIGHT (m)	TABLE ANGLE (Degree)	RAW VALUE (dBuV)	CORRECTION FACTOR (dB/m)
1	*2437.00	100.40 PK			1.32 H	173	70.16	30.24
2	*2437.00	90.80 AV			1.32 H	173	60.56	30.24
3	4874.00	47.90 PK	74.00	-26.10	1.47 H	121	12.35	35.55
4	4874.00	42.10 AV	54.00	-11.90	1.47 H	121	6.55	35.55
5	7311.00	50.80 PK	74.00	-23.20	1.37 H	104	8.76	42.04
6	7311.00	37.10 AV	54.00	-16.90	1.37 H	104	-4.94	42.04
ANTENNA POLARITY & TEST DISTANCE: VERTICAL AT 3 M								
NO.	FREQ. (MHz)	EMISSION LEVEL (dBuV/m)	LIMIT (dBuV/m)	MARGIN (dB)	ANTENNA HEIGHT (m)	TABLE ANGLE (Degree)	RAW VALUE (dBuV)	CORRECTION FACTOR (dB/m)
1	*2437.00	110.50 PK			1.44 V	28	80.26	30.24
2	*2437.00	99.93 AV			1.44 V	28	69.69	30.24
3	4874.00	52.10 PK	74.00	-21.90	1.44 V	28	16.55	35.55
4	4874.00	48.30 AV	54.00	-5.70	1.44 V	28	12.75	35.55
5	7311.00	51.20 PK	74.00	-22.80	1.43 V	172	9.16	42.04
6	7311.00	37.40 AV	54.00	-16.60	1.43 V	172	-4.64	42.04

- REMARKS:**
1. Emission level (dBuV/m) = Raw Value (dBuV) + Correction Factor (dB/m).
 2. Correction Factor (dB/m) = Antenna Factor (dB/m) + Cable Factor (dB).
 3. The other emission levels were very low against the limit.
 4. Margin value = Emission level – Limit value.
 5. “ * “: Fundamental frequency.



A D T

EUT TEST CONDITION		MEASUREMENT DETAIL	
CHANNEL	Channel 11	FREQUENCY RANGE	1 ~ 25GHz
INPUT POWER (SYSTEM)	120Vac, 60 Hz	DETECTOR FUNCTION	Peak (PK) Average (AV)
ENVIRONMENTAL CONDITIONS	27deg. C, %RH 965hPa	TESTED BY	Frank Liu

ANTENNA POLARITY & TEST DISTANCE: HORIZONTAL AT 3 M								
NO.	FREQ. (MHz)	EMISSION LEVEL (dBuV/m)	LIMIT (dBuV/m)	MARGIN (dB)	ANTENNA HEIGHT (m)	TABLE ANGLE (Degree)	RAW VALUE (dBuV)	CORRECTION FACTOR (dB/m)
1	*2462.00	100.10 PK			1.31 H	178	69.76	30.34
2	*2462.00	90.60 AV			1.31 H	178	60.26	30.34
3	2483.50	54.46 PK	74.00	-19.54	1.50 H	317	24.03	30.43
4	2483.50	42.89 AV	54.00	-11.11	1.50 H	317	12.46	30.43
5	4924.00	46.10 PK	74.00	-27.90	1.39 H	124	10.47	35.63
6	4924.00	40.30 AV	54.00	-13.70	1.39 H	124	4.67	35.63
7	7386.00	49.80 PK	74.00	-24.20	1.36 H	101	7.57	42.23
8	7386.00	36.20 AV	54.00	-17.80	1.36 H	101	-6.03	42.23
ANTENNA POLARITY & TEST DISTANCE: VERTICAL AT 3 M								
NO.	FREQ. (MHz)	EMISSION LEVEL (dBuV/m)	LIMIT (dBuV/m)	MARGIN (dB)	ANTENNA HEIGHT (m)	TABLE ANGLE (Degree)	RAW VALUE (dBuV)	CORRECTION FACTOR (dB/m)
1	*2462.00	110.30 PK			1.37 V	81	79.96	30.34
2	*2462.00	99.80 AV			1.37 V	81	69.46	30.34
3	2487.65	59.87 PK	74.00	-14.13	1.36 V	65	29.43	30.44
4	2487.65	46.09 AV	54.00	-7.91	1.36 V	65	15.65	30.44
5	4924.00	51.06 PK	74.00	-22.94	1.24 V	355	15.43	35.63
6	4924.00	46.00 AV	54.00	-8.00	1.24 V	355	10.37	35.63
7	7386.00	50.60 PK	74.00	-23.40	1.43 V	192	8.37	42.23
8	7386.00	36.20 AV	54.00	-17.80	1.43 V	192	-6.03	42.23

- REMARKS:**
1. Emission level (dBuV/m) = Raw Value (dBuV) + Correction Factor (dB/m).
 2. Correction Factor (dB/m) = Antenna Factor (dB/m) + Cable Factor (dB).
 3. The other emission levels were very low against the limit.
 4. Margin value = Emission level – Limit value.
 5. “ * “: Fundamental frequency.



A D T

RESTRICTED BANDEDGE (802.11b MODE,CH1, HORIZONTAL)

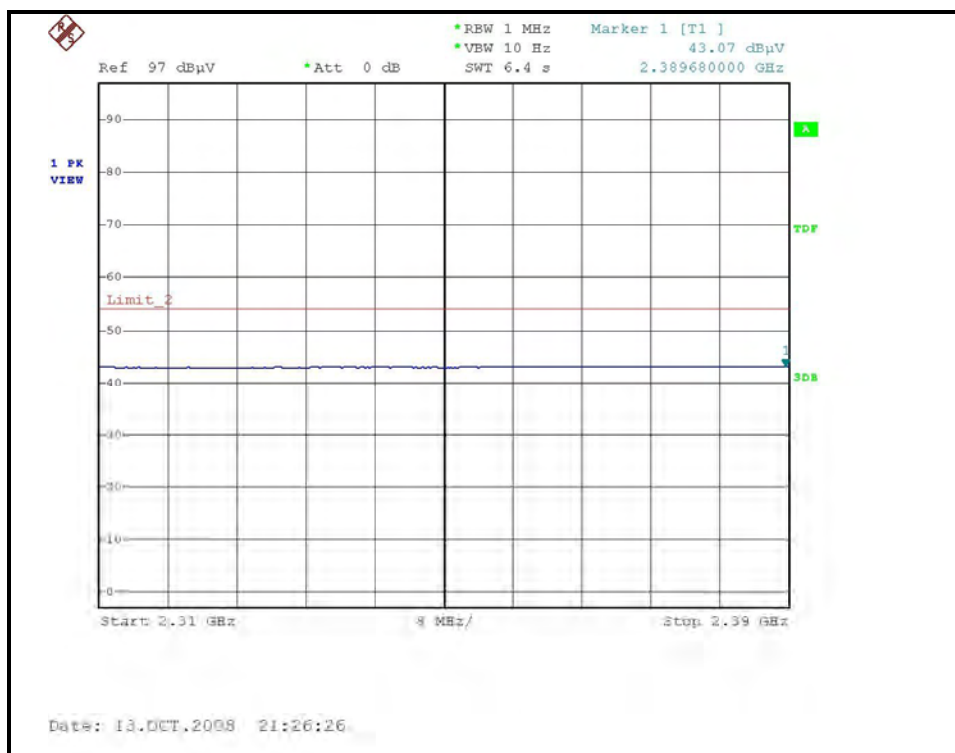
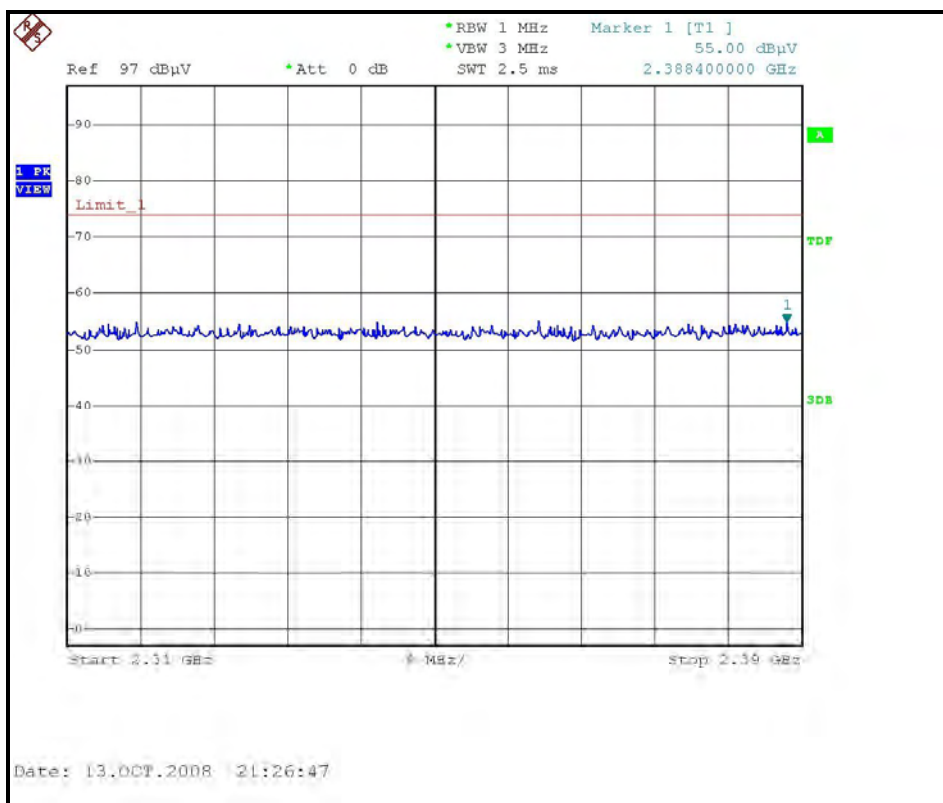



A D T

RESTRICTED BANDEDGE (802.11b MODE, CH1, VERTICAL)

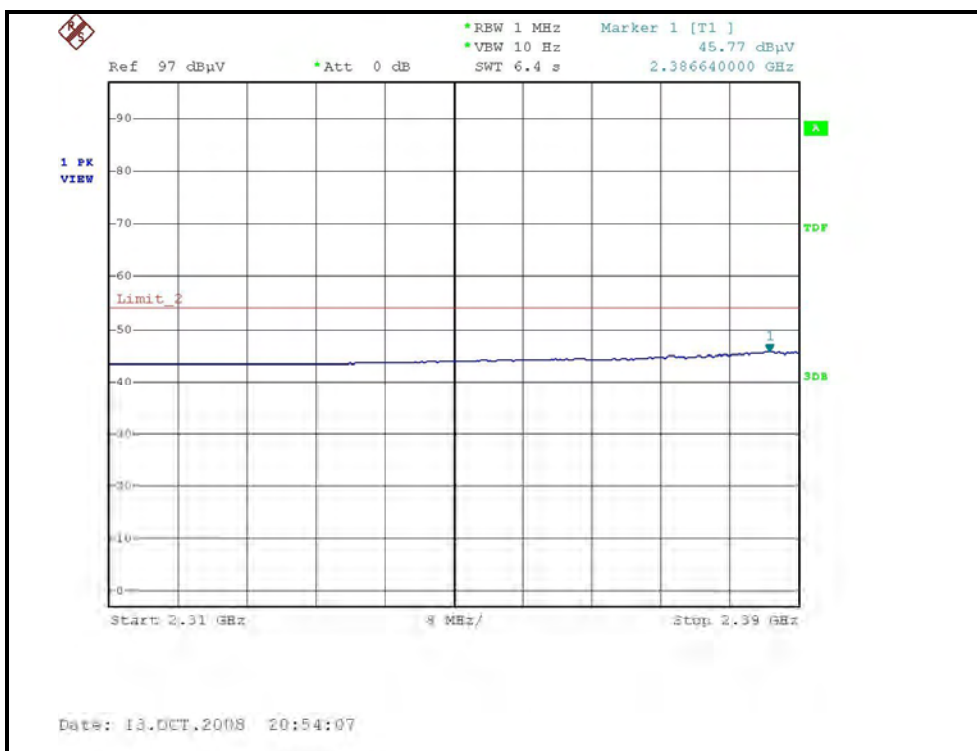
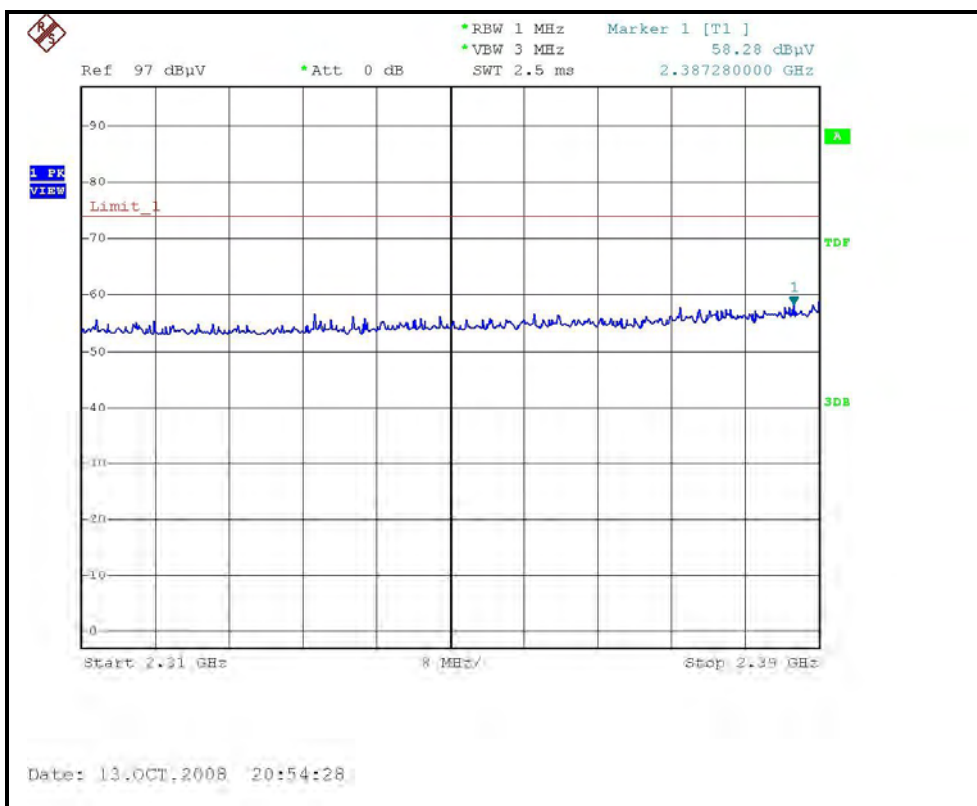



A D T

RESTRICTED BANDEDGE (802.11b MODE,CH11, HORIZONTAL)

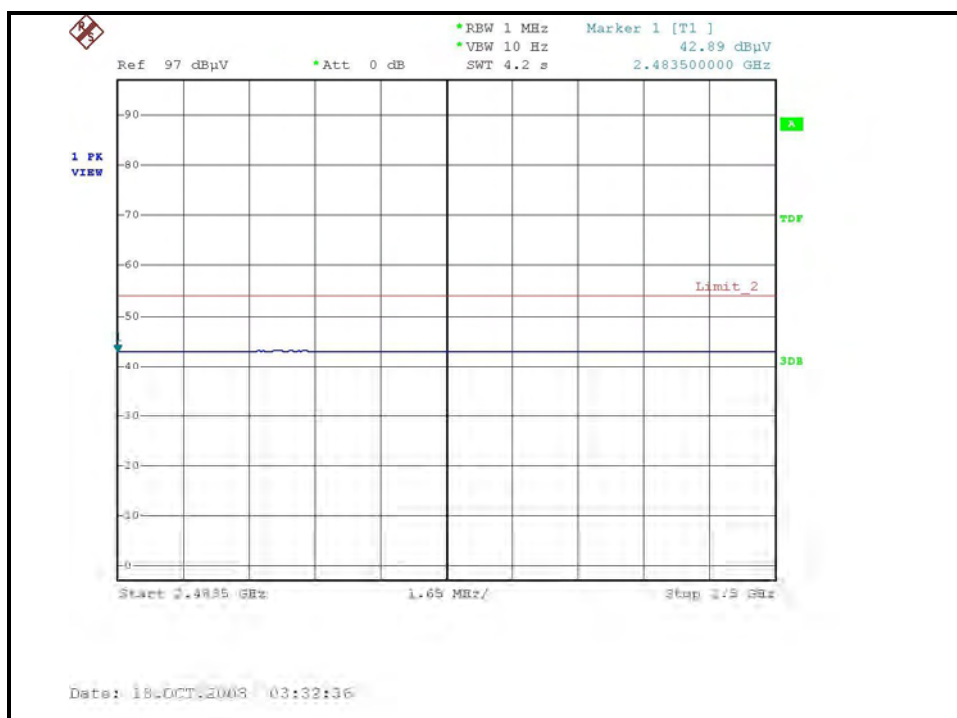
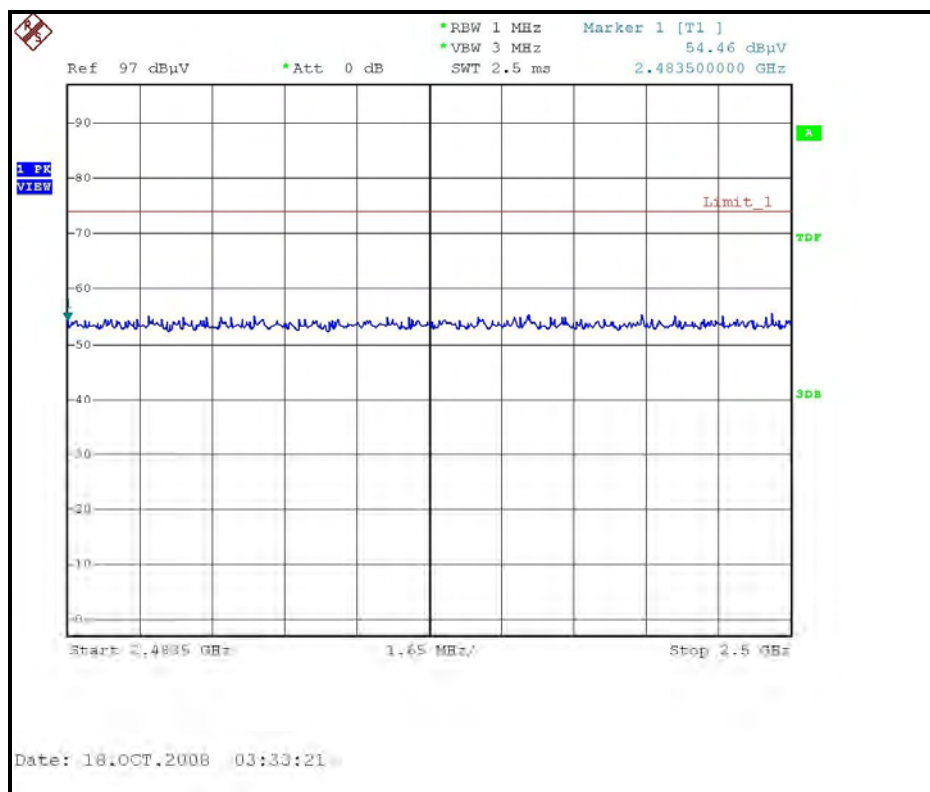



A D T

RESTRICTED BANDEDGE (802.11b MODE, CH11, VERTICAL)

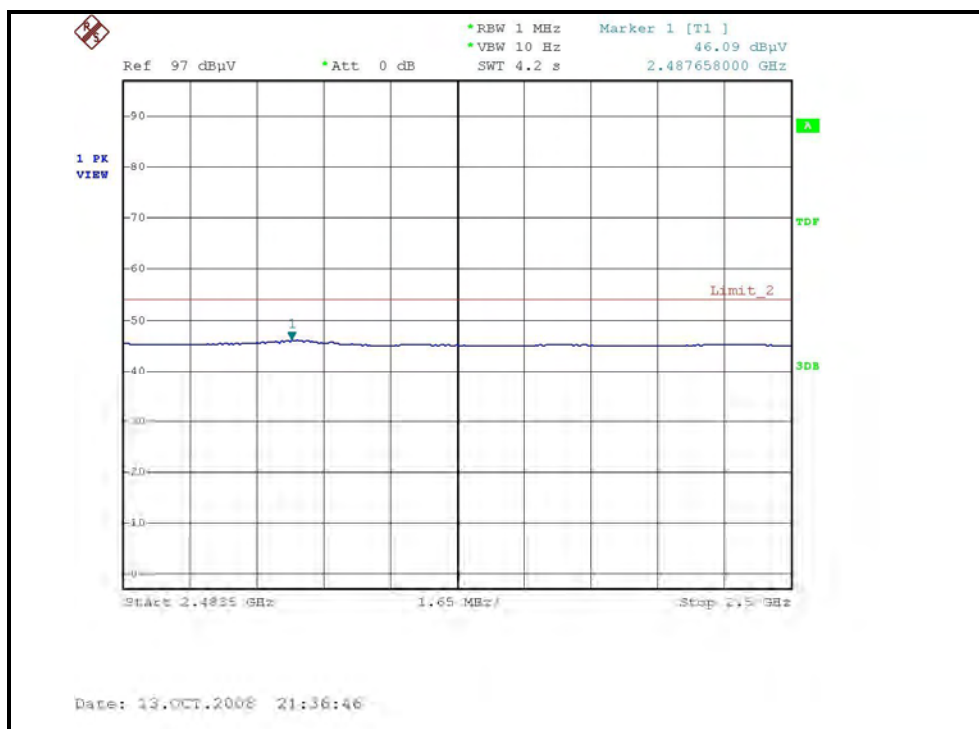
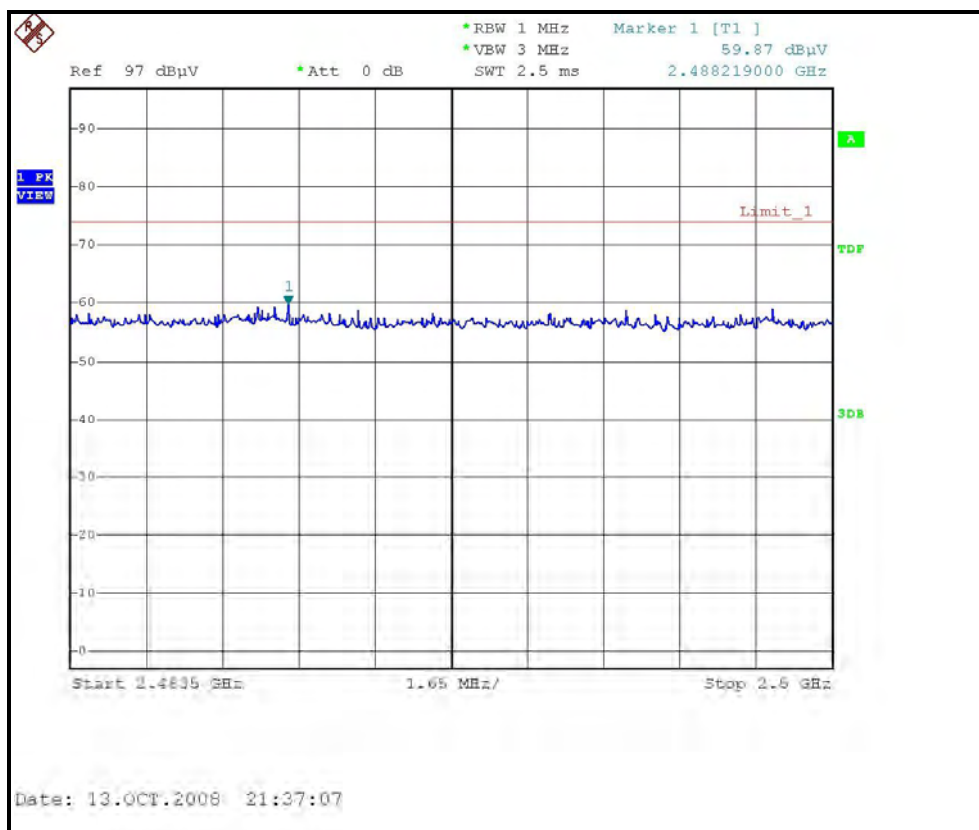



802.11g OFDM MODULATION

EUT TEST CONDITION		MEASUREMENT DETAIL	
CHANNEL	Channel 1	FREQUENCY RANGE	1 ~ 25GHz
INPUT POWER (SYSTEM)	120Vac, 60 Hz	DETECTOR FUNCTION	Peak (PK) Average (AV)
ENVIRONMENTAL CONDITIONS	27deg. C, %RH 965hPa	TESTED BY	Frank Liu

ANTENNA POLARITY & TEST DISTANCE: HORIZONTAL AT 3 M								
NO.	FREQ. (MHz)	EMISSION LEVEL (dBuV/m)	LIMIT (dBuV/m)	MARGIN (dB)	ANTENNA HEIGHT (m)	TABLE ANGLE (Degree)	RAW VALUE (dBuV)	CORRECTION FACTOR (dB/m)
1	2390.00	56.77 PK	74.00	-17.23	1.49 H	299	26.71	30.06
2	2390.00	43.64 AV	54.00	-10.36	1.49 H	299	13.58	30.06
3	*2412.00	98.30 PK			1.50 H	314	68.15	30.15
4	*2412.00	86.20 AV			1.50 H	314	56.05	30.15
5	4824.00	45.30 PK	74.00	-28.70	1.44 H	112	9.84	35.46
6	4824.00	30.20 AV	54.00	-23.80	1.44 H	112	-5.26	35.46
7	#7236.00	51.30 PK	78.30	-27.00	1.44 H	103	9.45	41.85
8	#7236.00	37.20 AV	66.20	-29.00	1.44 H	103	-4.65	41.85
ANTENNA POLARITY & TEST DISTANCE: VERTICAL AT 3 M								
NO.	FREQ. (MHz)	EMISSION LEVEL (dBuV/m)	LIMIT (dBuV/m)	MARGIN (dB)	ANTENNA HEIGHT (m)	TABLE ANGLE (Degree)	RAW VALUE (dBuV)	CORRECTION FACTOR (dB/m)
1	2390.00	69.02 PK	74.00	-4.98	1.48 V	278	38.96	30.06
2	2390.00	51.10 AV	54.00	-2.90	1.48 V	278	21.04	30.06
3	*2412.00	111.60 PK			1.43 V	279	81.45	30.15
4	*2412.00	100.30 AV			1.43 V	279	70.15	30.15
5	4824.00	46.40 PK	74.00	-27.60	1.29 V	4	10.94	35.46
6	4824.00	32.80 AV	54.00	-21.20	1.29 V	4	-2.66	35.46
7	#7236.00	51.60 PK	91.60	-40.00	1.43 V	185	9.75	41.85
8	#7236.00	38.40 AV	80.30	-41.90	1.43 V	185	-3.45	41.85

- REMARKS:**
1. Emission level (dBuV/m) = Raw Value (dBuV) + Correction Factor (dB/m).
 2. Correction Factor (dB/m) = Antenna Factor (dB/m) + Cable Factor (dB).
 3. The other emission levels were very low against the limit.
 4. Margin value = Emission level – Limit value.
 5. “ * “: Fundamental frequency.
 6. “#”:The radiated frequency is out the restricted band.



A D T

EUT TEST CONDITION		MEASUREMENT DETAIL	
CHANNEL	Channel 6	FREQUENCY RANGE	1 ~ 25GHz
INPUT POWER (SYSTEM)	120Vac, 60 Hz	DETECTOR FUNCTION	Peak (PK) Average (AV)
ENVIRONMENTAL CONDITIONS	27deg. C, %RH 965hPa	TESTED BY	Frank Liu

ANTENNA POLARITY & TEST DISTANCE: HORIZONTAL AT 3 M								
NO.	FREQ. (MHz)	EMISSION LEVEL (dBuV/m)	LIMIT (dBuV/m)	MARGIN (dB)	ANTENNA HEIGHT (m)	TABLE ANGLE (Degree)	RAW VALUE (dBuV)	CORRECTION FACTOR (dB/m)
1	*2437.00	98.80 PK			1.44 H	312	68.56	30.24
2	*2437.00	86.50 AV			1.44 H	312	56.26	30.24
3	4874.00	44.10 PK	74.00	-29.90	1.42 H	117	8.55	35.55
4	4874.00	29.80 AV	54.00	-24.20	1.42 H	117	-5.75	35.55
5	7311.00	51.00 PK	74.00	-23.00	1.42 H	105	8.96	42.04
6	7311.00	37.10 AV	54.00	-16.90	1.42 H	105	-4.94	42.04
ANTENNA POLARITY & TEST DISTANCE: VERTICAL AT 3 M								
NO.	FREQ. (MHz)	EMISSION LEVEL (dBuV/m)	LIMIT (dBuV/m)	MARGIN (dB)	ANTENNA HEIGHT (m)	TABLE ANGLE (Degree)	RAW VALUE (dBuV)	CORRECTION FACTOR (dB/m)
1	*2437.00	111.80 PK			1.44 V	281	81.56	30.24
2	*2437.00	100.40 AV			1.44 V	281	70.16	30.24
3	4874.00	46.70 PK	74.00	-27.30	1.26 V	2	11.15	35.55
4	4874.00	32.40 AV	54.00	-21.60	1.26 V	2	-3.15	35.55
5	7311.00	51.20 PK	74.00	-22.80	1.41 V	187	9.16	42.04
6	7311.00	38.10 AV	54.00	-15.90	1.41 V	187	-3.94	42.04

- REMARKS:**
1. Emission level (dBuV/m) = Raw Value (dBuV) + Correction Factor (dB/m).
 2. Correction Factor (dB/m) = Antenna Factor (dB/m) + Cable Factor (dB).
 3. The other emission levels were very low against the limit.
 4. Margin value = Emission level – Limit value.
 5. “ * “: Fundamental frequency.



A D T

EUT TEST CONDITION		MEASUREMENT DETAIL	
CHANNEL	Channel 11	FREQUENCY RANGE	1 ~ 25GHz
INPUT POWER (SYSTEM)	120Vac, 60 Hz	DETECTOR FUNCTION	Peak (PK) Average (AV)
ENVIRONMENTAL CONDITIONS	27deg. C, %RH 965hPa	TESTED BY	Frank Liu

ANTENNA POLARITY & TEST DISTANCE: HORIZONTAL AT 3 M								
NO.	FREQ. (MHz)	EMISSION LEVEL (dBuV/m)	LIMIT (dBuV/m)	MARGIN (dB)	ANTENNA HEIGHT (m)	TABLE ANGLE (Degree)	RAW VALUE (dBuV)	CORRECTION FACTOR (dB/m)
1	*2462.00	98.70 PK			1.50 H	311	68.36	30.34
2	*2462.00	87.87 AV			1.50 H	311	57.53	30.34
3	2483.50	58.56 PK	74.00	-15.44	1.52 H	312	28.13	30.43
4	2483.50	44.36 AV	54.00	-9.64	1.52 H	312	13.93	30.43
5	4924.00	45.80 PK	74.00	-28.20	1.43 H	119	10.17	35.63
6	4924.00	30.60 AV	54.00	-23.40	1.43 H	119	-5.03	35.63
7	7386.00	51.10 PK	74.00	-22.90	1.33 H	184	8.87	42.23
8	7386.00	37.80 AV	54.00	-16.20	1.33 H	184	-4.43	42.23
ANTENNA POLARITY & TEST DISTANCE: VERTICAL AT 3 M								
NO.	FREQ. (MHz)	EMISSION LEVEL (dBuV/m)	LIMIT (dBuV/m)	MARGIN (dB)	ANTENNA HEIGHT (m)	TABLE ANGLE (Degree)	RAW VALUE (dBuV)	CORRECTION FACTOR (dB/m)
1	*2462.00	110.08 PK			1.35 V	283	79.74	30.34
2	*2462.00	98.90 AV			1.35 V	283	68.56	30.34
3	2483.50	69.29 PK	74.00	-4.71	1.35 V	283	38.86	30.43
4	2483.50	49.40 AV	54.00	-4.60	1.35 V	283	18.97	30.43
5	4924.00	46.80 PK	74.00	-27.20	1.24 V	3	11.17	35.63
6	4924.00	32.70 AV	54.00	-21.30	1.24 V	3	-2.93	35.63
7	7386.00	51.30 PK	74.00	-22.70	1.24 V	191	9.07	42.23
8	7386.00	38.30 AV	54.00	-15.70	1.24 V	191	-3.93	42.23

- REMARKS:**
1. Emission level (dBuV/m) = Raw Value (dBuV) + Correction Factor (dB/m).
 2. Correction Factor (dB/m) = Antenna Factor (dB/m) + Cable Factor (dB).
 3. The other emission levels were very low against the limit.
 4. Margin value = Emission level – Limit value.
 5. “ * “: Fundamental frequency.



A D T

RESTRICTED BANDEDGE (802.11g MODE, CH1, HORIZONTAL)

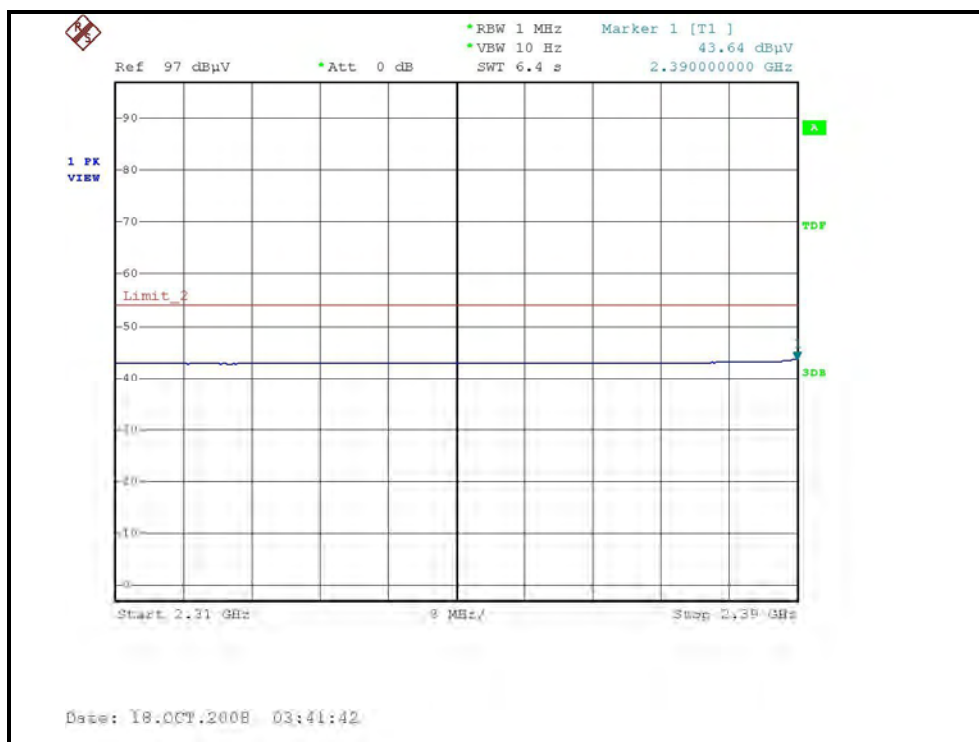
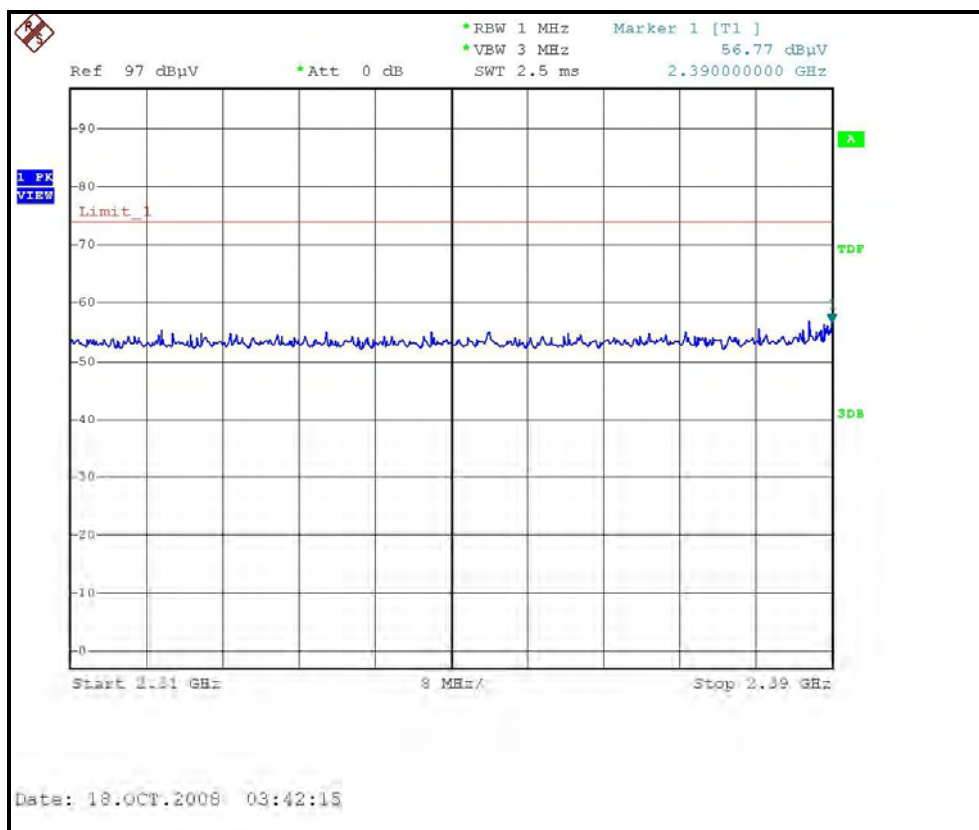



A D T

RESTRICTED BANDEDGE (802.11g MODE, CH1, VERTICAL)

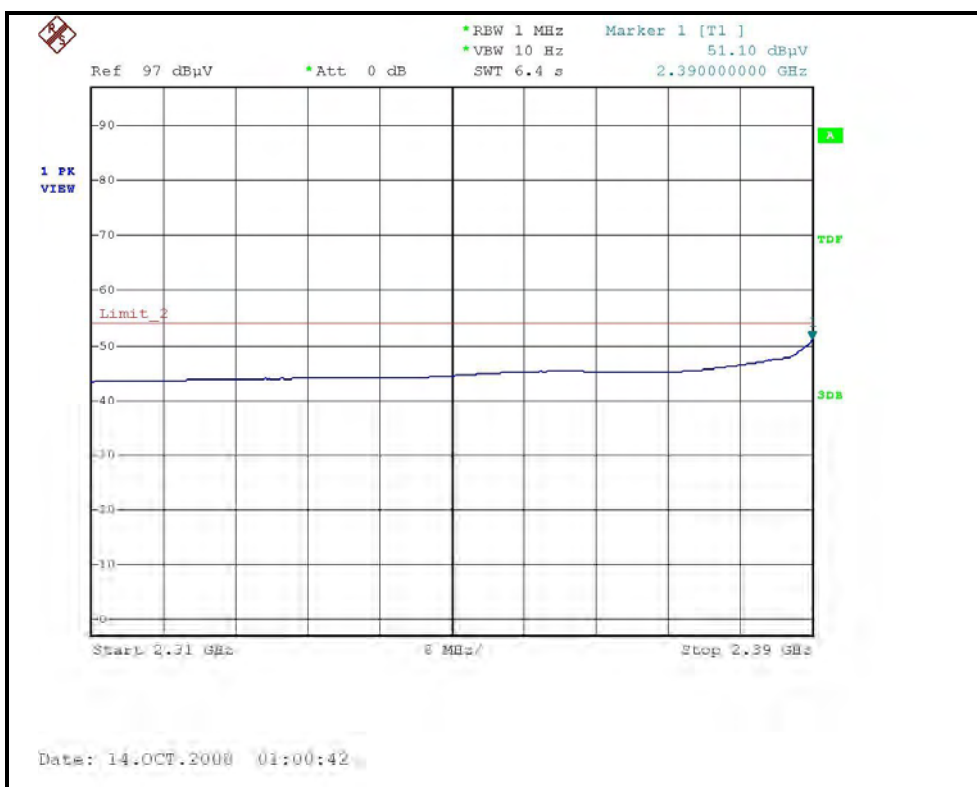
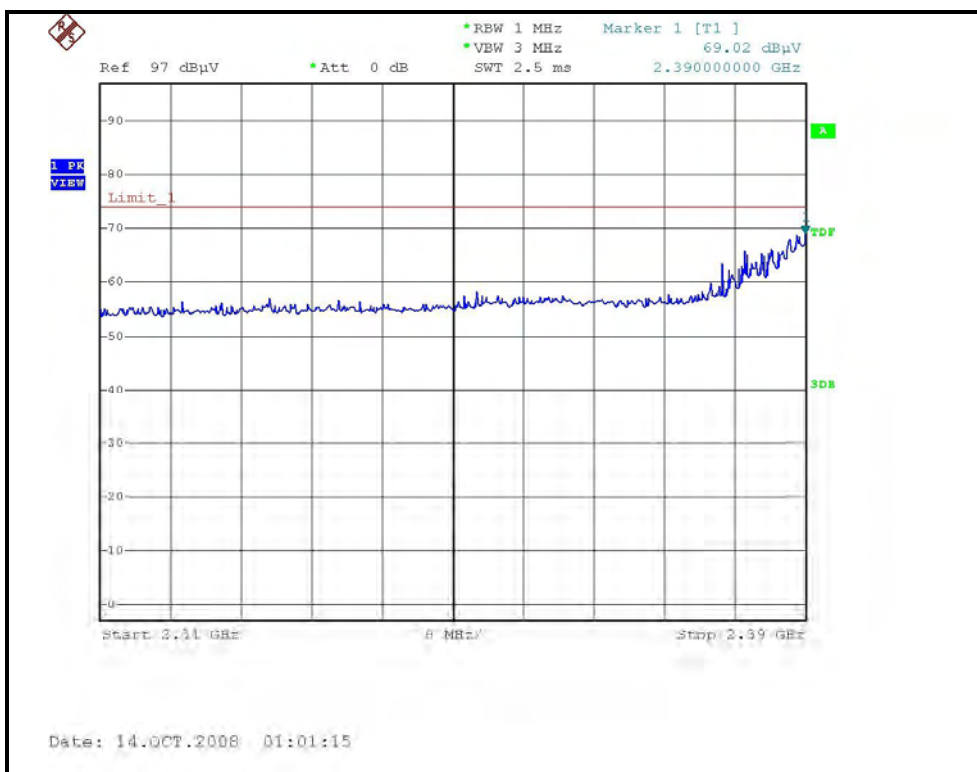



A D T

RESTRICTED BANDEDGE (802.11g MODE, CH11, HORIZONTAL)

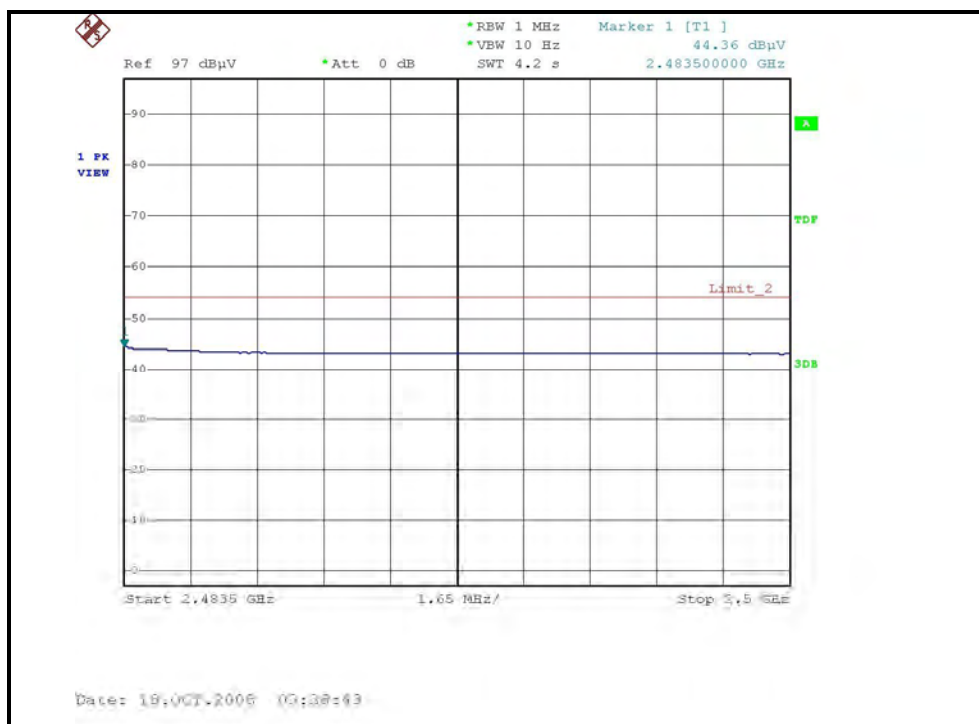
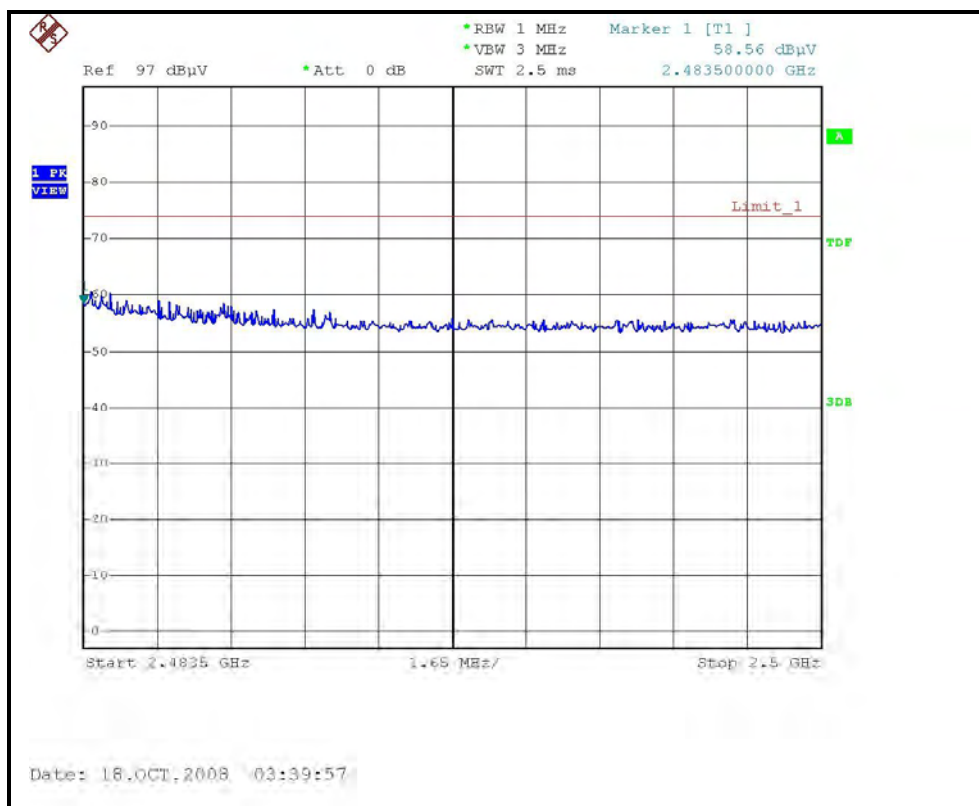



A D T

RESTRICTED BANDEDGE (802.11g MODE, CH11, VERTICAL)

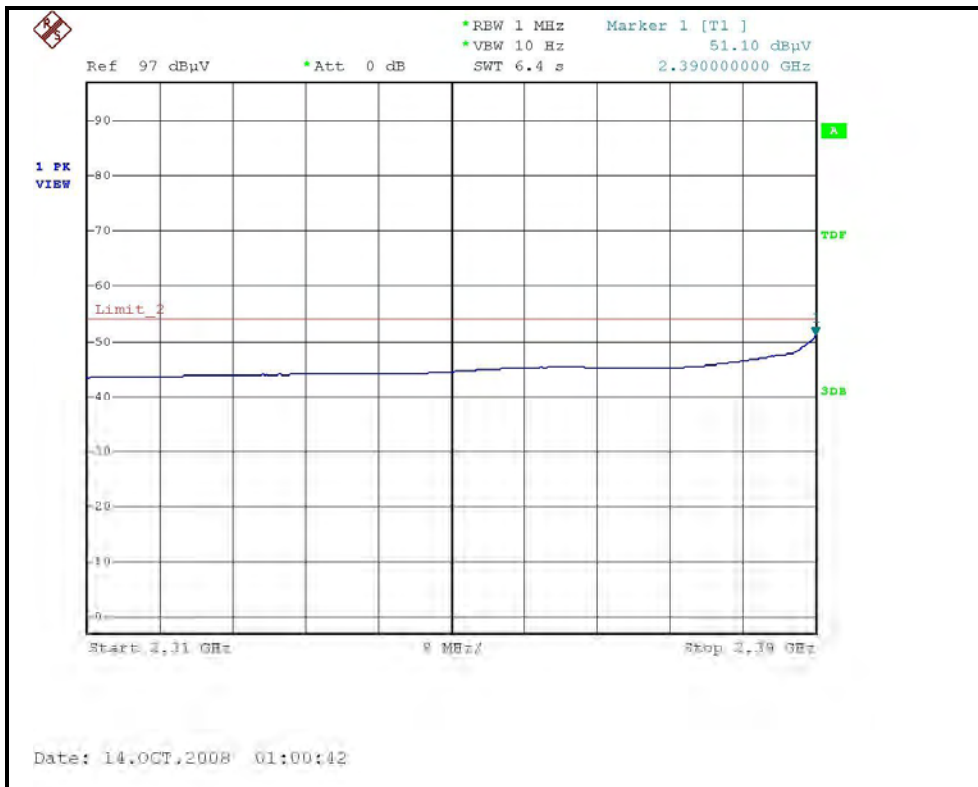
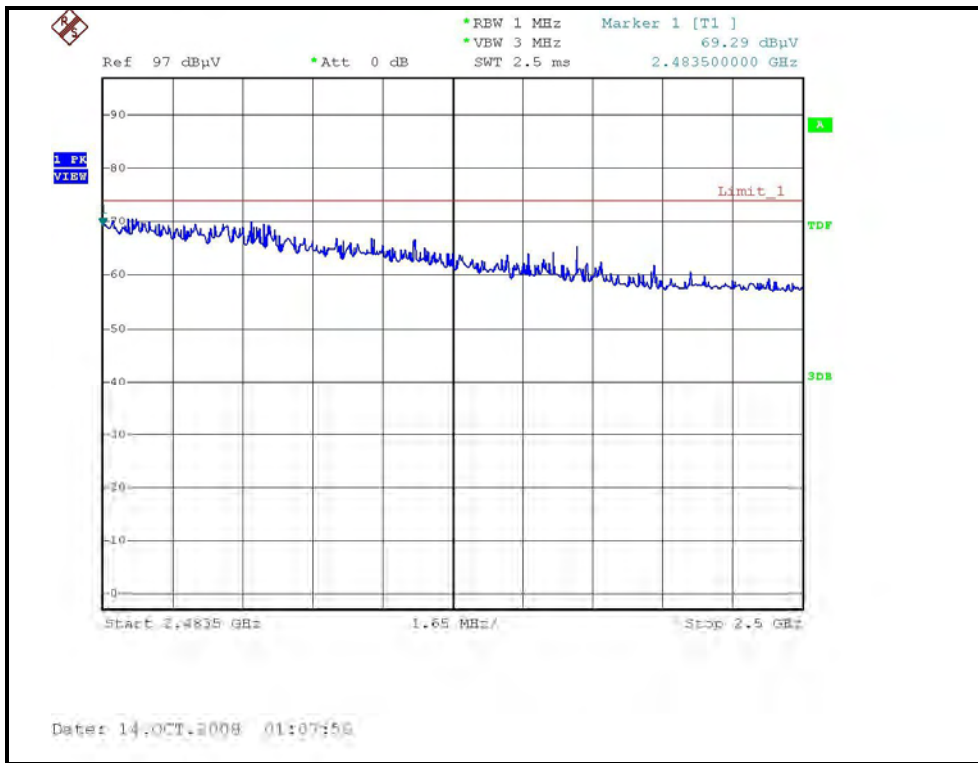

**DRAFT 802.11n (20MHz) OFDM MODULATION**

EUT TEST CONDITION		MEASUREMENT DETAIL	
CHANNEL	Channel 1	FREQUENCY RANGE	1 ~ 25GHz
INPUT POWER (SYSTEM)	120Vac, 60 Hz	DETECTOR FUNCTION	Peak (PK) Average (AV)
ENVIRONMENTAL CONDITIONS	27deg. C, %RH 965hPa	TESTED BY	Frank Liu

ANTENNA POLARITY & TEST DISTANCE: HORIZONTAL AT 3 M								
NO.	FREQ. (MHz)	EMISSION LEVEL (dBuV/m)	LIMIT (dBuV/m)	MARGIN (dB)	ANTENNA HEIGHT (m)	TABLE ANGLE (Degree)	RAW VALUE (dBuV)	CORRECTION FACTOR (dB/m)
1	2390.00	55.34 PK	74.00	-18.66	1.52 H	312	25.28	30.06
2	2390.00	43.73 AV	54.00	-10.27	1.52 H	312	13.67	30.06
3	*2412.00	100.90 PK			1.49 H	303	70.75	30.15
4	*2412.00	88.00 AV			1.49 H	303	57.85	30.15
5	4824.00	44.20 PK	74.00	-29.80	1.34 H	268	8.74	35.46
6	4824.00	31.30 AV	54.00	-22.70	1.34 H	268	-4.16	35.46
7	#7236.00	50.10 PK	80.90	-30.80	1.22 H	291	8.25	41.85
8	#7236.00	37.20 AV	68.00	-30.80	1.22 H	291	-4.65	41.85
ANTENNA POLARITY & TEST DISTANCE: VERTICAL AT 3 M								
NO.	FREQ. (MHz)	EMISSION LEVEL (dBuV/m)	LIMIT (dBuV/m)	MARGIN (dB)	ANTENNA HEIGHT (m)	TABLE ANGLE (Degree)	RAW VALUE (dBuV)	CORRECTION FACTOR (dB/m)
1	2390.00	71.94 PK	74.00	-2.06	1.33 V	264	41.88	30.06
2	2390.00	51.92 AV	54.00	-2.08	1.33 V	264	21.86	30.06
3	*2412.00	115.20 PK			1.43 V	278	85.05	30.15
4	*2412.00	101.90 AV			1.43 V	278	71.75	30.15
5	4824.00	46.20 PK	74.00	-27.80	1.33 V	264	10.74	35.46
6	4824.00	33.10 AV	54.00	-20.90	1.33 V	264	-2.36	35.46
7	#7236.00	50.40 PK	95.20	-44.80	1.32 V	269	8.55	41.85
8	#7236.00	37.10 AV	81.90	-44.80	1.32 V	269	-4.75	41.85

- REMARKS:**
1. Emission level (dBuV/m) = Raw Value (dBuV) + Correction Factor (dB/m).
 2. Correction Factor (dB/m) = Antenna Factor (dB/m) + Cable Factor (dB).
 3. The other emission levels were very low against the limit.
 4. Margin value = Emission level – Limit value.
 5. “ * “: Fundamental frequency.
 6. “#”:The radiated frequency is out the restricted band.



A D T

EUT TEST CONDITION		MEASUREMENT DETAIL	
CHANNEL	Channel 6	FREQUENCY RANGE	1 ~ 25GHz
INPUT POWER (SYSTEM)	120Vac, 60 Hz	DETECTOR FUNCTION	Peak (PK) Average (AV)
ENVIRONMENTAL CONDITIONS	27deg. C, %RH 965hPa	TESTED BY	Frank Liu

ANTENNA POLARITY & TEST DISTANCE: HORIZONTAL AT 3 M								
NO.	FREQ. (MHz)	EMISSION LEVEL (dBuV/m)	LIMIT (dBuV/m)	MARGIN (dB)	ANTENNA HEIGHT (m)	TABLE ANGLE (Degree)	RAW VALUE (dBuV)	CORRECTION FACTOR (dB/m)
1	*2437.00	101.30 PK			1.44 H	312	71.06	30.24
2	*2437.00	88.30 AV			1.44 H	312	58.06	30.24
3	4874.00	44.60 PK	74.00	-29.40	1.37 H	264	9.05	35.55
4	4874.00	30.90 AV	54.00	-23.10	1.37 H	264	-4.65	35.55
5	7311.00	50.60 PK	74.00	-23.40	1.32 H	298	8.56	42.04
6	7311.00	37.40 AV	54.00	-16.60	1.32 H	298	-4.64	42.04
ANTENNA POLARITY & TEST DISTANCE: VERTICAL AT 3 M								
NO.	FREQ. (MHz)	EMISSION LEVEL (dBuV/m)	LIMIT (dBuV/m)	MARGIN (dB)	ANTENNA HEIGHT (m)	TABLE ANGLE (Degree)	RAW VALUE (dBuV)	CORRECTION FACTOR (dB/m)
1	*2437.00	114.90 PK			1.42 V	274	84.66	30.24
2	*2437.00	101.70 AV			1.42 V	274	71.46	30.24
3	4874.00	45.30 PK	74.00	-28.70	1.32 V	267	9.75	35.55
4	4874.00	32.40 AV	54.00	-21.60	1.32 V	267	-3.15	35.55
5	7311.00	50.10 PK	74.00	-23.90	1.31 V	266	8.06	42.04
6	7311.00	37.00 AV	54.00	-17.00	1.31 V	266	-5.04	42.04

- REMARKS:**
1. Emission level (dBuV/m) = Raw Value (dBuV) + Correction Factor (dB/m).
 2. Correction Factor (dB/m) = Antenna Factor (dB/m) + Cable Factor (dB).
 3. The other emission levels were very low against the limit.
 4. Margin value = Emission level – Limit value.
 5. “ * “: Fundamental frequency.



A D T

EUT TEST CONDITION		MEASUREMENT DETAIL	
CHANNEL	Channel 11	FREQUENCY RANGE	1 ~ 25GHz
INPUT POWER (SYSTEM)	120Vac, 60 Hz	DETECTOR FUNCTION	Peak (PK) Average (AV)
ENVIRONMENTAL CONDITIONS	27deg. C, %RH 965hPa	TESTED BY	Frank Liu

ANTENNA POLARITY & TEST DISTANCE: HORIZONTAL AT 3 M								
NO.	FREQ. (MHz)	EMISSION LEVEL (dBuV/m)	LIMIT (dBuV/m)	MARGIN (dB)	ANTENNA HEIGHT (m)	TABLE ANGLE (Degree)	RAW VALUE (dBuV)	CORRECTION FACTOR (dB/m)
1	*2462.00	101.90 PK			1.50 H	34	71.56	30.34
2	*2462.00	89.40 AV			1.50 H	34	59.06	30.34
3	2483.50	57.62 PK	74.00	-16.38	1.51 H	312	27.19	30.43
4	2483.50	44.33 AV	54.00	-9.67	1.51 H	312	13.90	30.43
5	4924.00	44.90 PK	74.00	-29.10	1.34 H	268	9.27	35.63
6	4924.00	31.20 AV	54.00	-22.80	1.34 H	268	-4.43	35.63
7	7386.00	50.10 PK	74.00	-23.90	1.33 H	294	7.87	42.23
8	7386.00	37.00 AV	54.00	-17.00	1.33 H	294	-5.23	42.23
ANTENNA POLARITY & TEST DISTANCE: VERTICAL AT 3 M								
NO.	FREQ. (MHz)	EMISSION LEVEL (dBuV/m)	LIMIT (dBuV/m)	MARGIN (dB)	ANTENNA HEIGHT (m)	TABLE ANGLE (Degree)	RAW VALUE (dBuV)	CORRECTION FACTOR (dB/m)
1	*2462.00	114.30 PK			1.38 V	281	83.96	30.34
2	*2462.00	101.50 AV			1.38 V	281	71.16	30.34
3	2483.50	73.45 PK	74.00	-0.55	1.36 V	279	43.02	30.43
4	2483.50	52.48 AV	54.00	-1.52	1.36 V	279	22.05	30.43
5	4924.00	45.70 PK	74.00	-28.30	1.36 V	256	10.07	35.63
6	4924.00	32.90 AV	54.00	-21.10	1.36 V	256	-2.73	35.63
7	7386.00	50.30 PK	74.00	-23.70	1.32 V	267	8.07	42.23
8	7386.00	37.20 AV	54.00	-16.80	1.32 V	267	-5.03	42.23

- REMARKS:**
1. Emission level (dBuV/m) = Raw Value (dBuV) + Correction Factor (dB/m).
 2. Correction Factor (dB/m) = Antenna Factor (dB/m) + Cable Factor (dB).
 3. The other emission levels were very low against the limit.
 4. Margin value = Emission level – Limit value.
 5. “ * “: Fundamental frequency.



A D T

RESTRICTED BANDEDGE (DRAFT 802.11n (20MHz) MODE,CH1, HORIZONTAL)

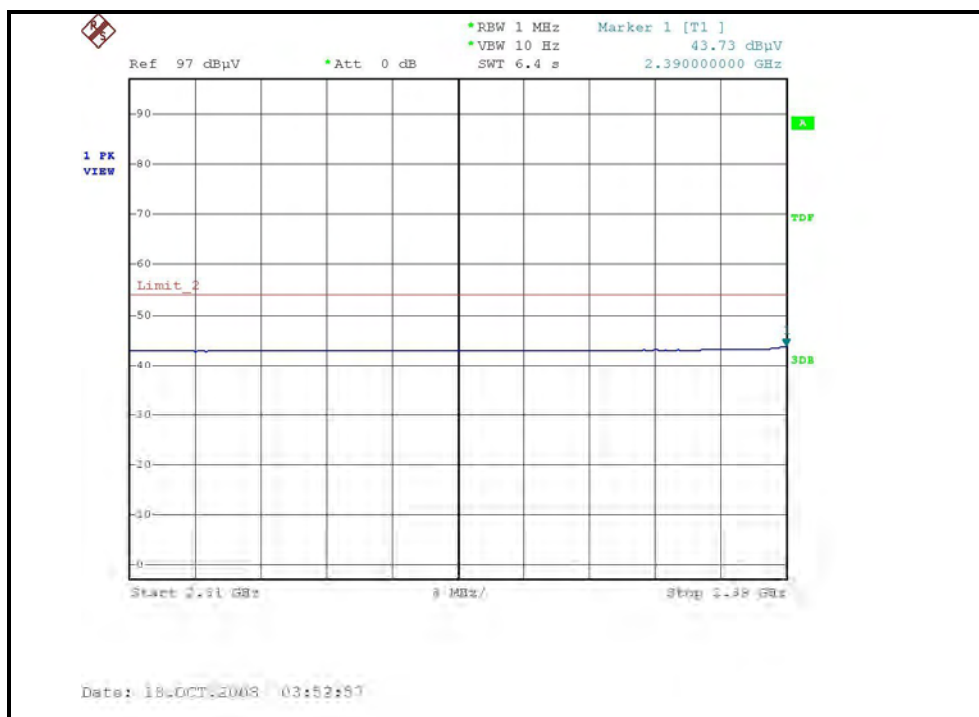
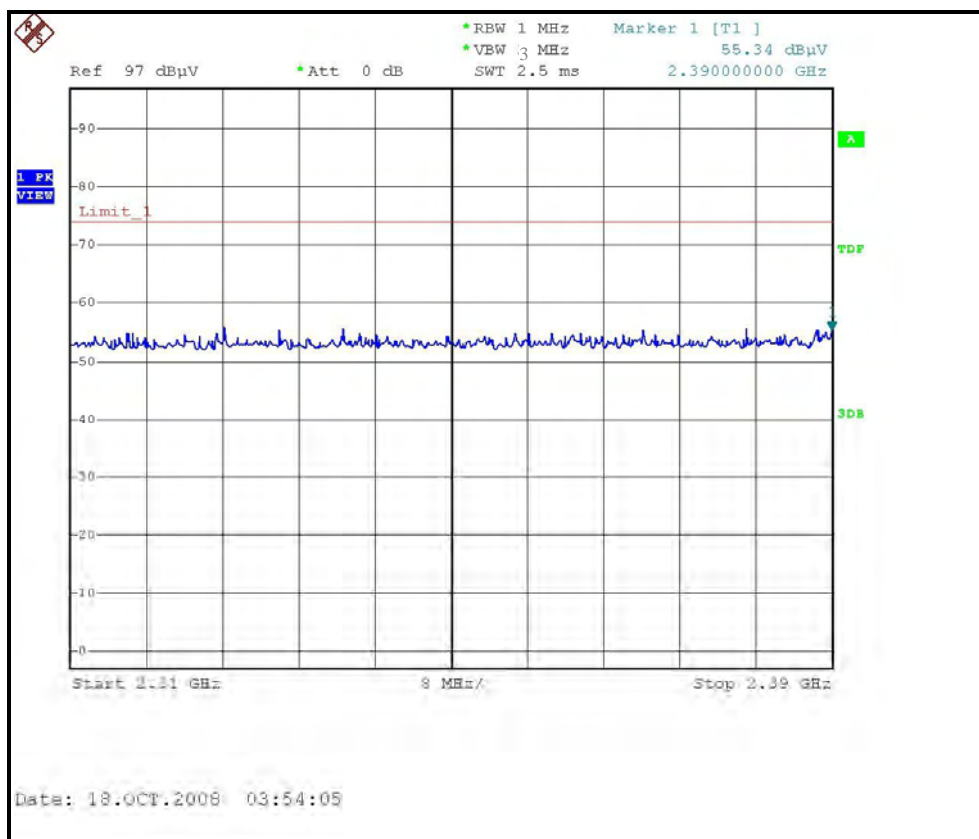



A D T

RESTRICTED BANDEDGE (DRAFT 802.11n (20MHz) MODE,CH1, VERTICAL)

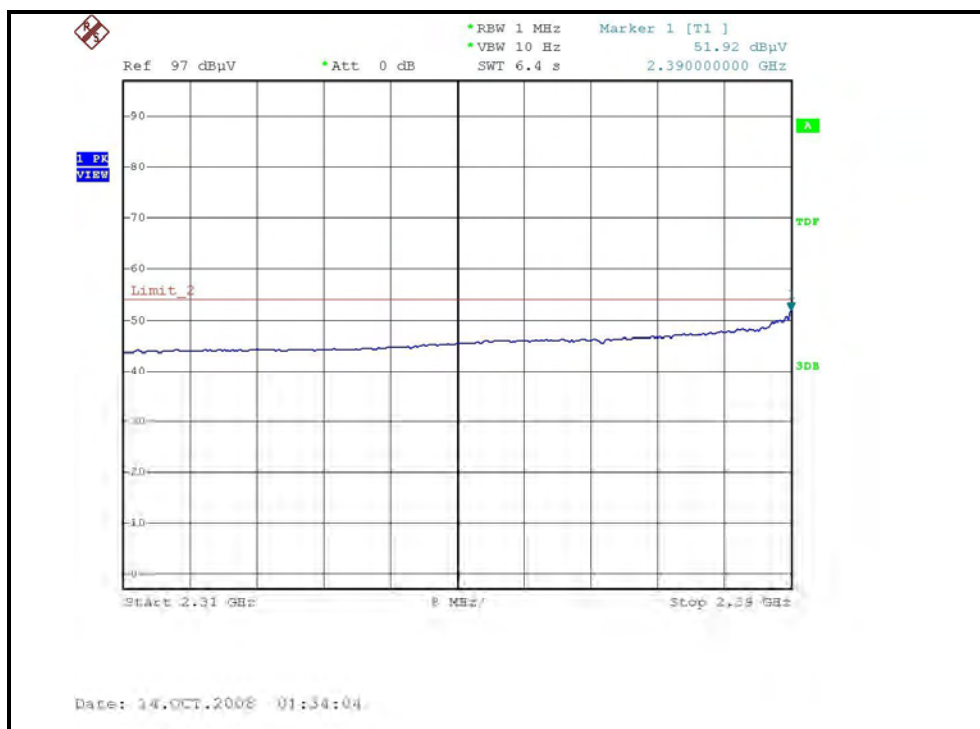
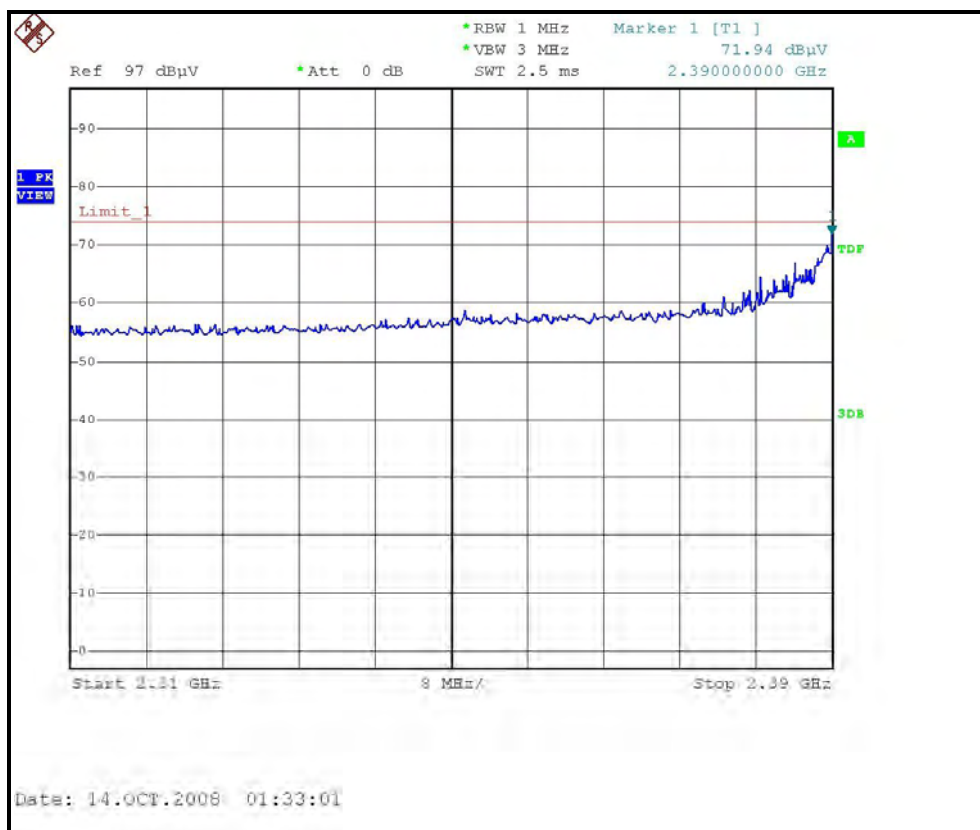



A D T

RESTRICTED BANDEDGE (DRAFT 802.11n (20MHz) MODE, CH11, HORIZONTAL)

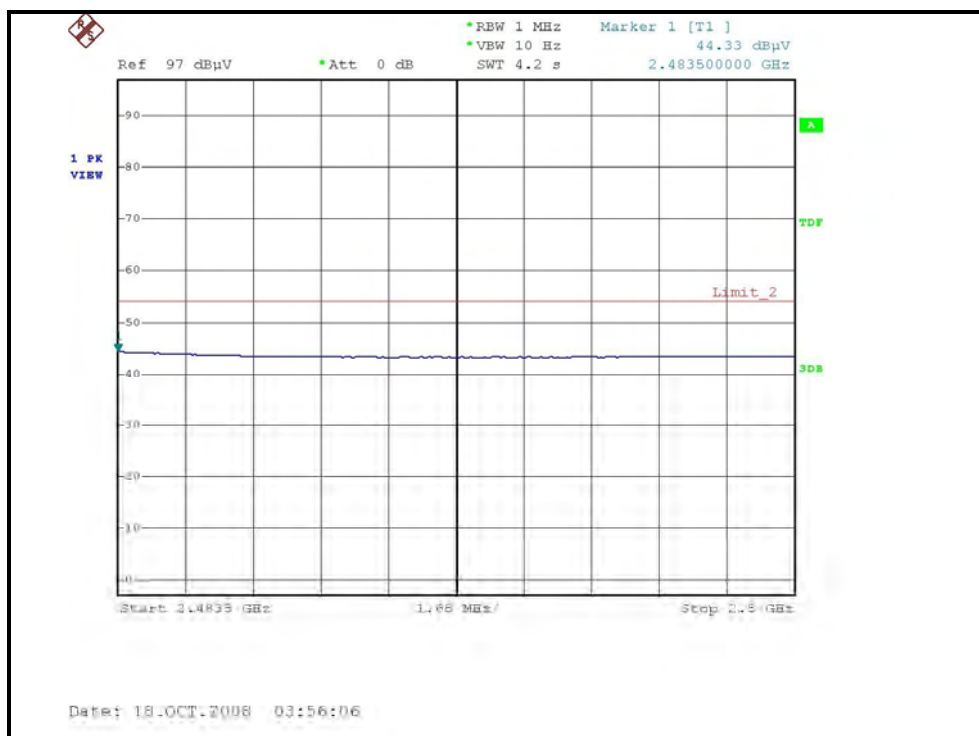
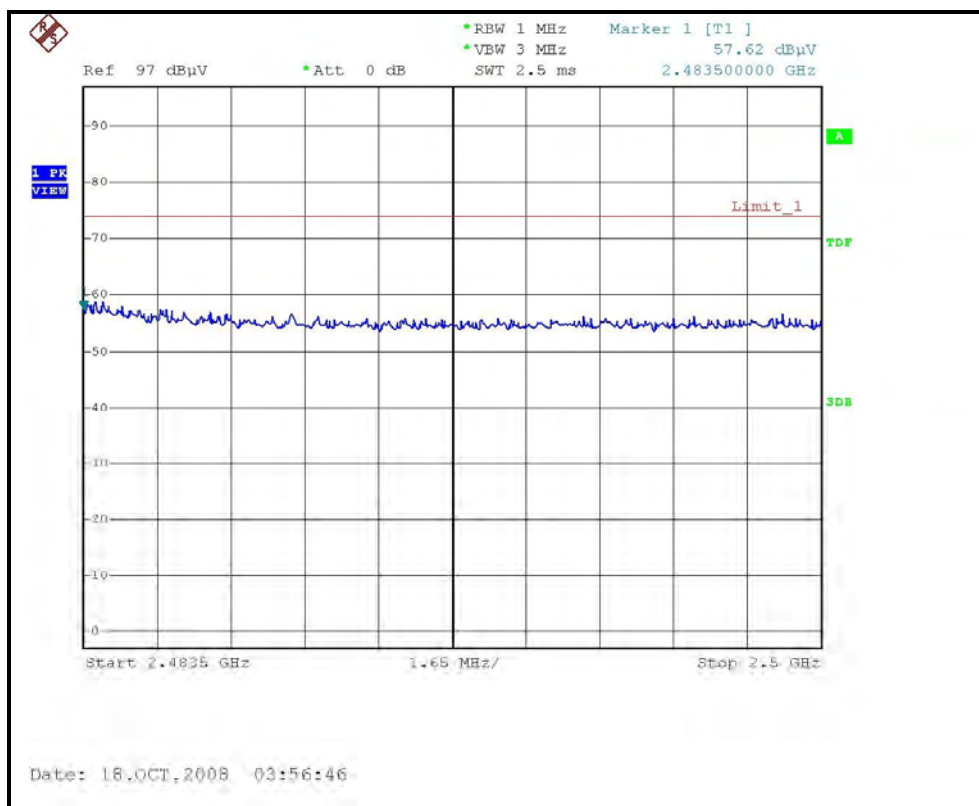



A D T

RESTRICTED BANDEDGE (DRAFT 802.11n (20MHz) MODE,CH11, VERTICAL)

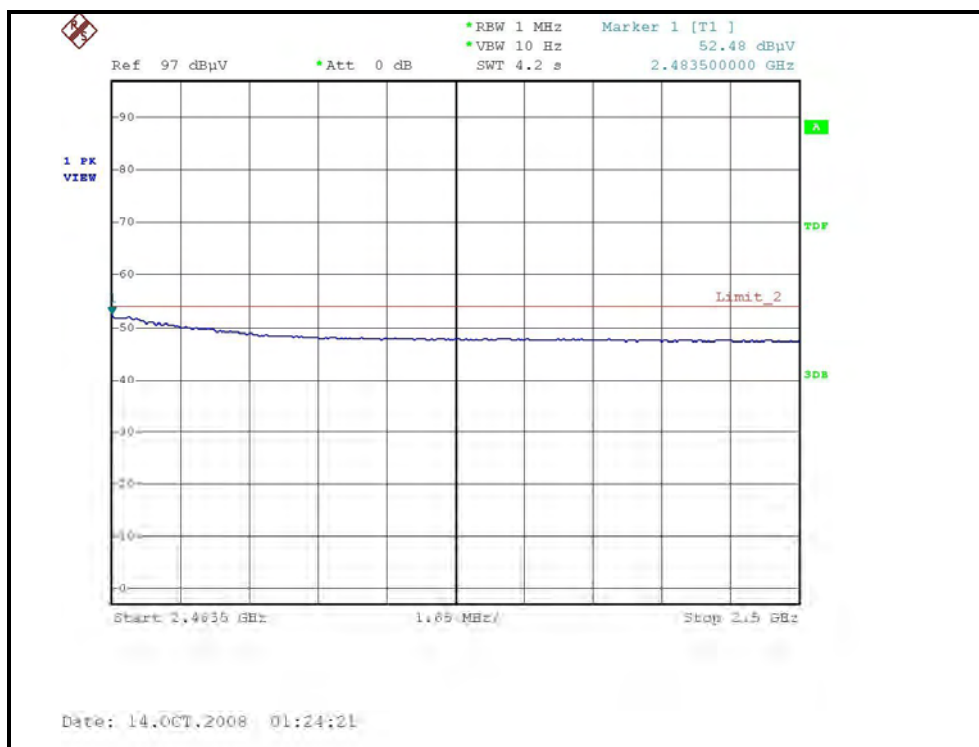
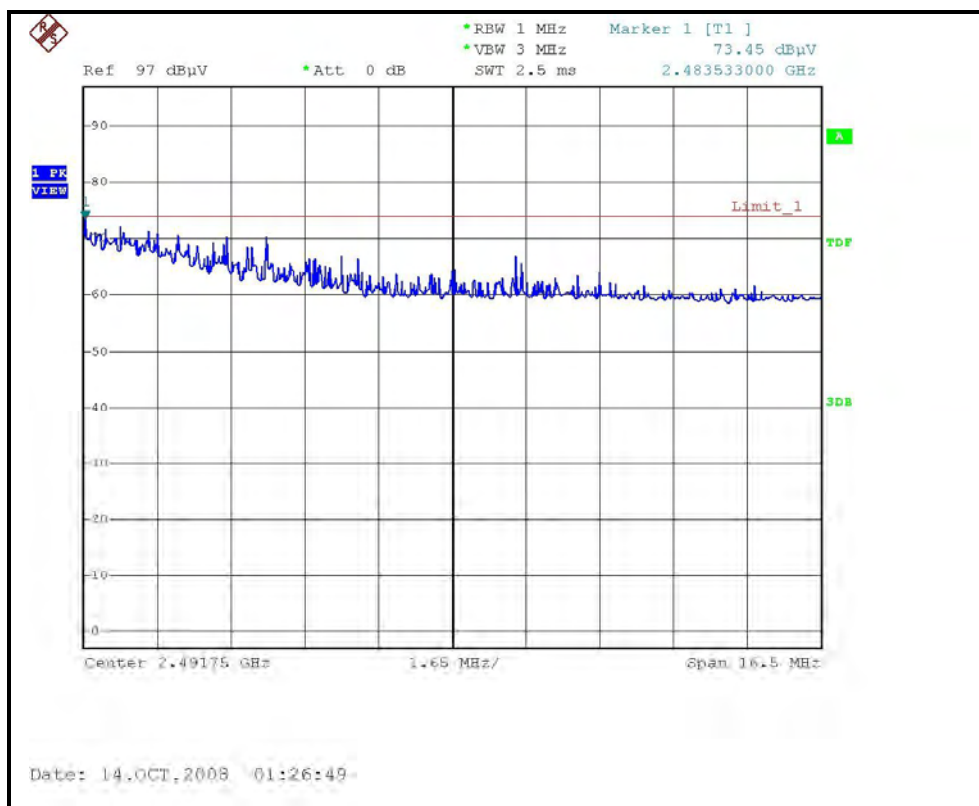



A D T

DRAFT 802.11n (40MHz) OFDM MODULATION

EUT TEST CONDITION		MEASUREMENT DETAIL	
CHANNEL	Channel 1	FREQUENCY RANGE	1 ~ 25GHz
INPUT POWER (SYSTEM)	120Vac, 60 Hz	DETECTOR FUNCTION	Peak (PK) Average (AV)
ENVIRONMENTAL CONDITIONS	27deg. C, %RH 965hPa	TESTED BY	Frank Liu

ANTENNA POLARITY & TEST DISTANCE: HORIZONTAL AT 3 M								
NO.	FREQ. (MHz)	EMISSION LEVEL (dBuV/m)	LIMIT (dBuV/m)	MARGIN (dB)	ANTENNA HEIGHT (m)	TABLE ANGLE (Degree)	RAW VALUE (dBuV)	CORRECTION FACTOR (dB/m)
1	2390.00	56.89 PK	74.00	-17.11	1.52 H	300	26.83	30.06
2	2390.00	44.31 AV	54.00	-9.69	1.52 H	300	14.25	30.06
3	*2422.00	94.90 PK			1.50 H	302	64.71	30.19
4	*2422.00	82.00 AV			1.50 H	302	51.81	30.19
5	4844.00	42.10 PK	74.00	-31.90	1.37 H	264	6.60	35.50
6	4844.00	29.80 AV	54.00	-24.20	1.37 H	264	-5.70	35.50
7	7266.00	50.40 PK	74.00	-23.60	1.31 H	251	8.47	41.93
8	7266.00	37.10 AV	54.00	-16.90	1.31 H	251	-4.83	41.93
ANTENNA POLARITY & TEST DISTANCE: VERTICAL AT 3 M								
NO.	FREQ. (MHz)	EMISSION LEVEL (dBuV/m)	LIMIT (dBuV/m)	MARGIN (dB)	ANTENNA HEIGHT (m)	TABLE ANGLE (Degree)	RAW VALUE (dBuV)	CORRECTION FACTOR (dB/m)
1	2390.00	69.60 PK	74.00	-4.40	1.44 V	278	39.54	30.06
2	2390.00	50.90 AV	54.00	-3.10	1.44 V	278	20.84	30.06
3	*2422.00	106.50 PK			1.39 V	265	76.31	30.19
4	*2422.00	92.60 AV			1.39 V	265	62.41	30.19
5	4844.00	44.30 PK	74.00	-29.70	1.31 V	269	8.80	35.50
6	4844.00	31.20 AV	54.00	-22.80	1.31 V	269	-4.30	35.50
7	7266.00	50.80 PK	74.00	-23.20	1.32 V	261	8.87	41.93
8	7266.00	37.40 AV	54.00	-16.60	1.32 V	261	-4.53	41.93

- REMARKS:**
1. Emission level (dBuV/m) = Raw Value (dBuV) + Correction Factor (dB/m).
 2. Correction Factor (dB/m) = Antenna Factor (dB/m) + Cable Factor (dB).
 3. The other emission levels were very low against the limit.
 4. Margin value = Emission level – Limit value.
 5. “ * “: Fundamental frequency.



A D T

EUT TEST CONDITION		MEASUREMENT DETAIL	
CHANNEL	Channel 4	FREQUENCY RANGE	1 ~ 25GHz
INPUT POWER (SYSTEM)	120Vac, 60 Hz	DETECTOR FUNCTION	Peak (PK) Average (AV)
ENVIRONMENTAL CONDITIONS	27deg. C, %RH 965hPa	TESTED BY	Frank Liu

ANTENNA POLARITY & TEST DISTANCE: HORIZONTAL AT 3 M								
NO.	FREQ. (MHz)	EMISSION LEVEL (dBuV/m)	LIMIT (dBuV/m)	MARGIN (dB)	ANTENNA HEIGHT (m)	TABLE ANGLE (Degree)	RAW VALUE (dBuV)	CORRECTION FACTOR (dB/m)
1	*2437.00	95.10 PK			1.48 H	313	64.86	30.24
2	*2437.00	82.40 AV			1.48 H	313	52.16	30.24
3	4874.00	41.60 PK	74.00	-32.40	1.33 H	251	6.05	35.55
4	4874.00	29.40 AV	54.00	-24.60	1.33 H	251	-6.15	35.55
5	7311.00	50.70 PK	74.00	-23.30	1.32 H	264	8.66	42.04
6	7311.00	37.20 AV	54.00	-16.80	1.32 H	264	-4.84	42.04
ANTENNA POLARITY & TEST DISTANCE: VERTICAL AT 3 M								
NO.	FREQ. (MHz)	EMISSION LEVEL (dBuV/m)	LIMIT (dBuV/m)	MARGIN (dB)	ANTENNA HEIGHT (m)	TABLE ANGLE (Degree)	RAW VALUE (dBuV)	CORRECTION FACTOR (dB/m)
1	*2437.00	106.80 PK			1.34 V	271	76.56	30.24
2	*2437.00	93.10 AV			1.34 V	271	62.86	30.24
3	4874.00	43.90 PK	74.00	-30.10	1.32 V	251	8.35	35.55
4	4874.00	30.80 AV	54.00	-23.20	1.32 V	251	-4.75	35.55
5	7311.00	51.20 PK	74.00	-22.80	1.33 V	354	9.16	42.04
6	7311.00	37.60 AV	54.00	-16.40	1.33 V	354	-4.44	42.04

- REMARKS:**
1. Emission level (dBuV/m) = Raw Value (dBuV) + Correction Factor (dB/m).
 2. Correction Factor (dB/m) = Antenna Factor (dB/m) + Cable Factor (dB).
 3. The other emission levels were very low against the limit.
 4. Margin value = Emission level – Limit value.
 5. “ * “: Fundamental frequency.



A D T

EUT TEST CONDITION		MEASUREMENT DETAIL	
CHANNEL	Channel 7	FREQUENCY RANGE	1 ~ 25GHz
INPUT POWER (SYSTEM)	120Vac, 60 Hz	DETECTOR FUNCTION	Peak (PK) Average (AV)
ENVIRONMENTAL CONDITIONS	27deg. C, %RH 965hPa	TESTED BY	Frank Liu

ANTENNA POLARITY & TEST DISTANCE: HORIZONTAL AT 3 M								
NO.	FREQ. (MHz)	EMISSION LEVEL (dBuV/m)	LIMIT (dBuV/m)	MARGIN (dB)	ANTENNA HEIGHT (m)	TABLE ANGLE (Degree)	RAW VALUE (dBuV)	CORRECTION FACTOR (dB/m)
1	*2452.00	94.90 PK			1.52 H	304	64.60	30.30
2	*2452.00	82.00 AV			1.52 H	304	51.70	30.30
3	2483.50	56.10 PK	74.00	-17.90	1.50 H	302	25.67	30.43
4	2483.50	43.53 AV	54.00	-10.47	1.50 H	302	13.10	30.43
5	4904.00	42.10 PK	74.00	-31.90	1.33 H	254	6.50	35.60
6	4904.00	29.90 AV	54.00	-24.10	1.33 H	254	-5.70	35.60
7	7356.00	51.30 PK	74.00	-22.70	1.34 H	265	9.14	42.16
8	7356.00	37.40 AV	54.00	-16.60	1.34 H	265	-4.76	42.16
ANTENNA POLARITY & TEST DISTANCE: VERTICAL AT 3 M								
NO.	FREQ. (MHz)	EMISSION LEVEL (dBuV/m)	LIMIT (dBuV/m)	MARGIN (dB)	ANTENNA HEIGHT (m)	TABLE ANGLE (Degree)	RAW VALUE (dBuV)	CORRECTION FACTOR (dB/m)
1	*2452.00	107.20 PK			1.38 V	275	76.90	30.30
2	*2452.00	93.70 AV			1.38 V	275	63.40	30.30
3	2483.50	68.20 PK	74.00	-5.80	1.38 V	277	37.77	30.43
4	2483.50	49.28 AV	54.00	-4.72	1.38 V	277	18.85	30.43
5	4904.00	42.70 PK	74.00	-31.30	1.38 V	277	7.10	35.60
6	4904.00	30.40 AV	54.00	-23.60	1.38 V	277	-5.20	35.60
7	7356.00	51.30 PK	74.00	-22.70	1.32 V	251	9.14	42.16
8	7356.00	37.80 AV	54.00	-16.20	1.32 V	251	-4.36	42.16

- REMARKS:**
1. Emission level (dBuV/m) = Raw Value (dBuV) + Correction Factor (dB/m).
 2. Correction Factor (dB/m) = Antenna Factor (dB/m) + Cable Factor (dB).
 3. The other emission levels were very low against the limit.
 4. Margin value = Emission level – Limit value.
 5. “ * “: Fundamental frequency.



A D T

RESTRICTED BANDEDGE (DRAFT 802.11n (40MHz) MODE, CH1, HORIZONTAL)

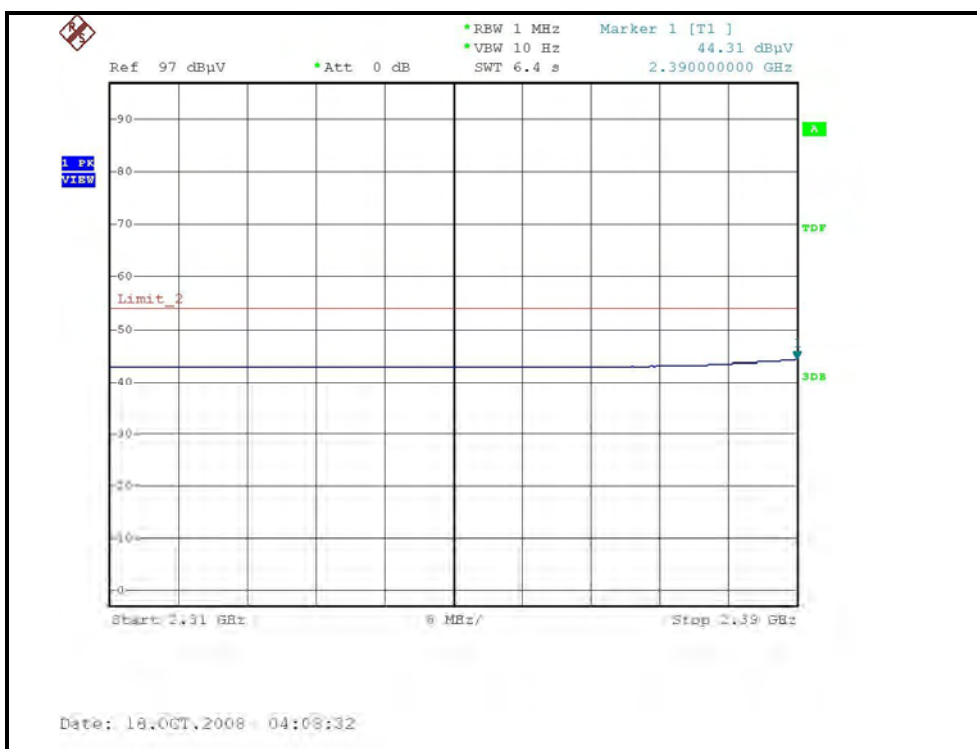
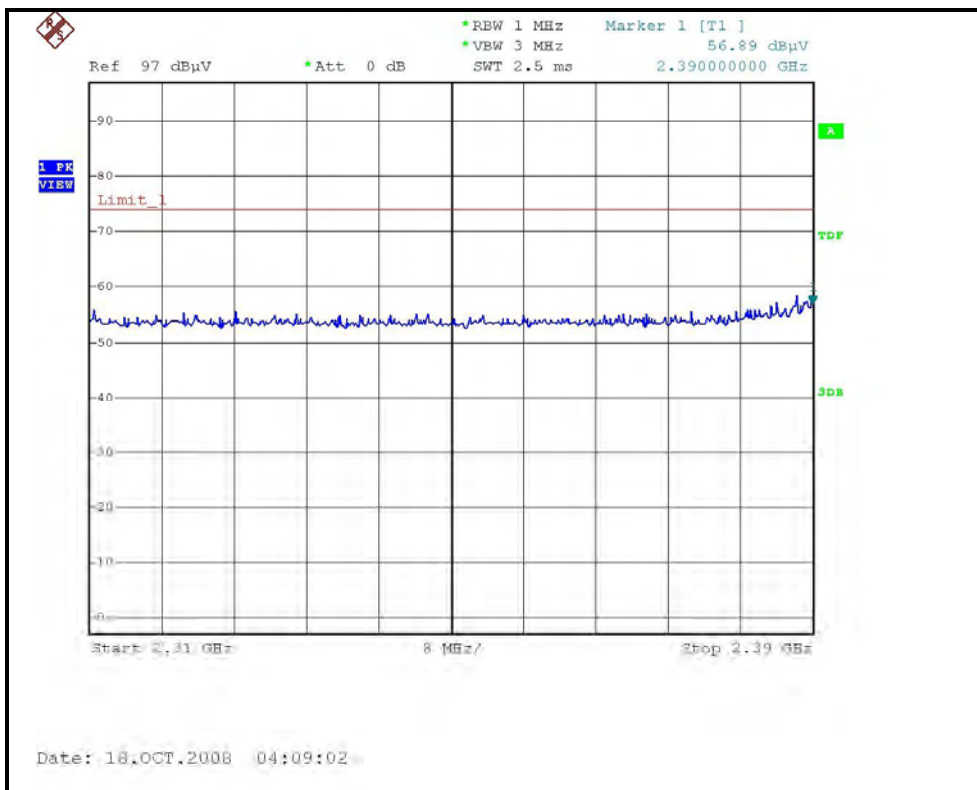



A D T

RESTRICTED BANDEDGE (DRAFT 802.11n (40MHz) MODE,CH1, VERTICAL)

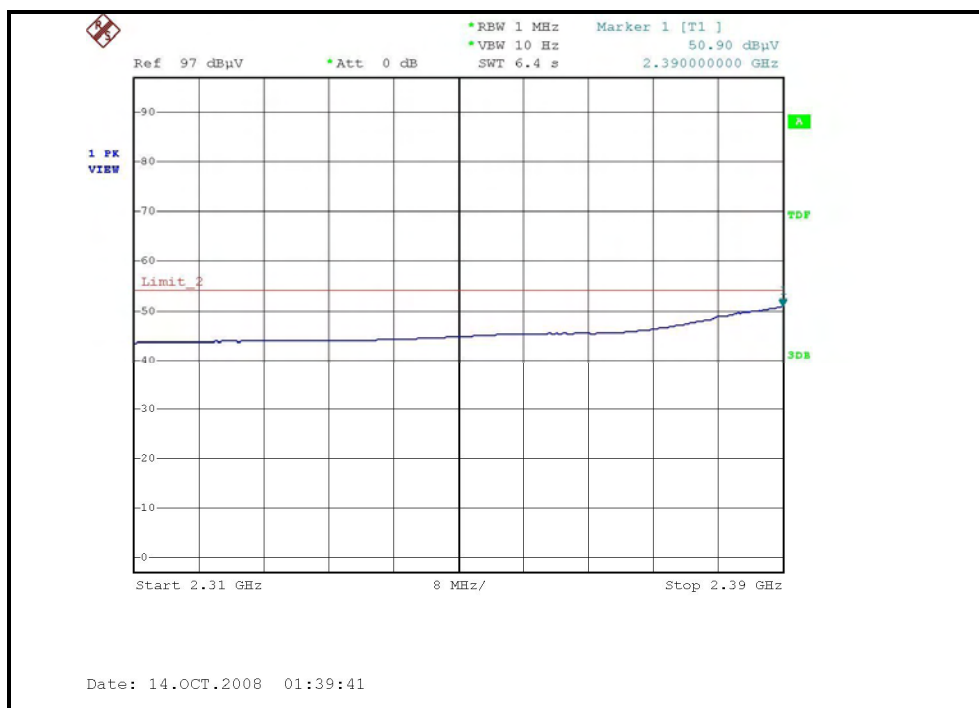
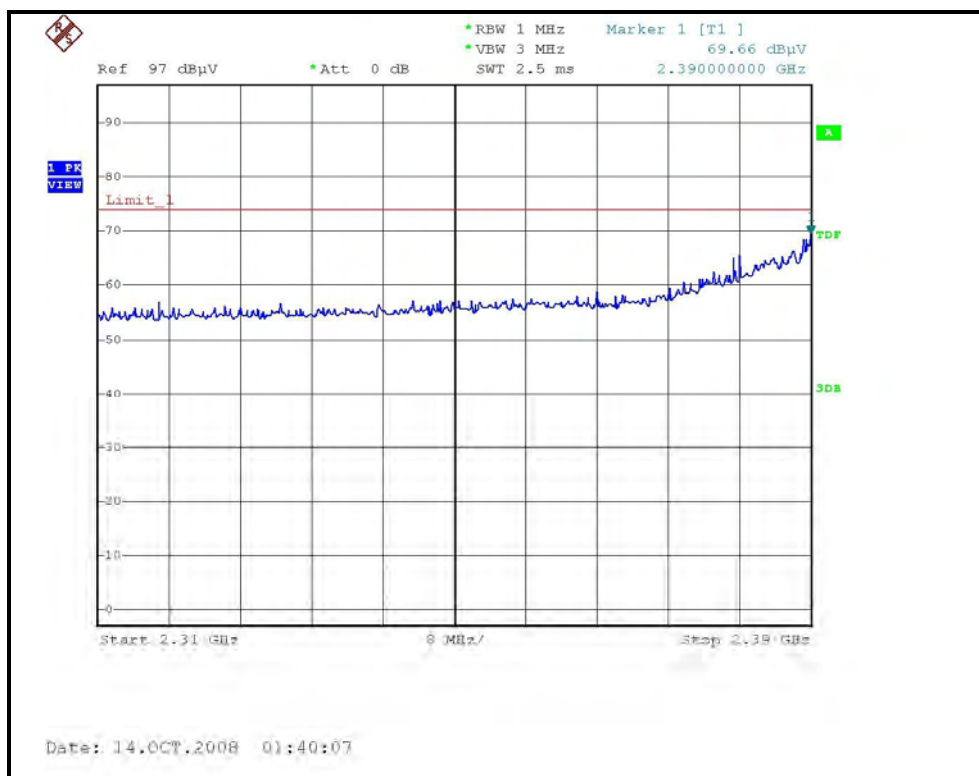



A D T

RESTRICTED BANDEDGE (DRAFT 802.11n (40MHz) MODE,CH7, HORIZONTAL)

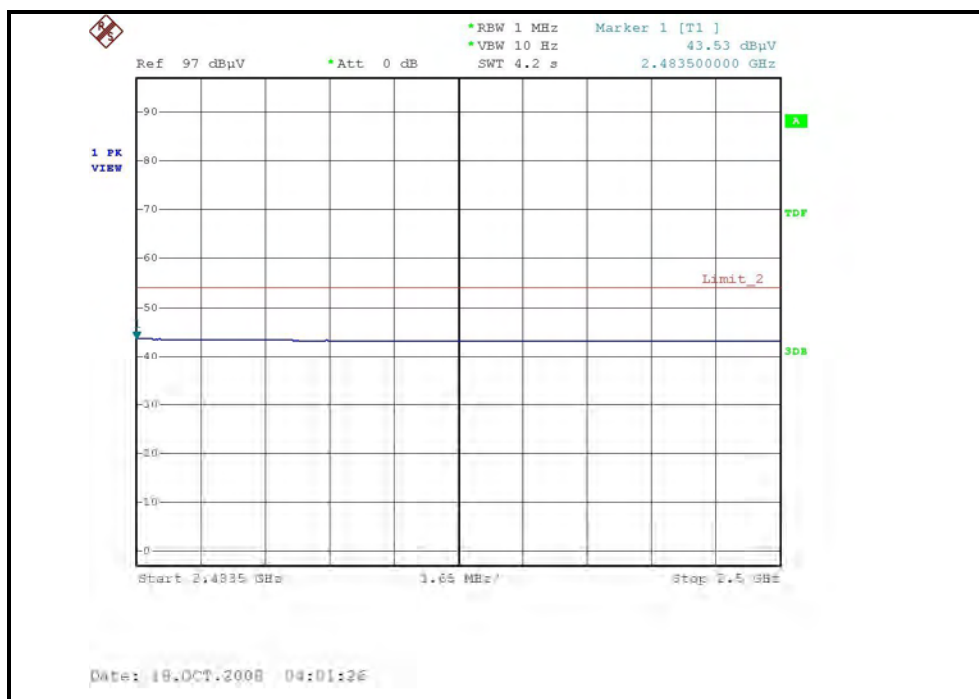
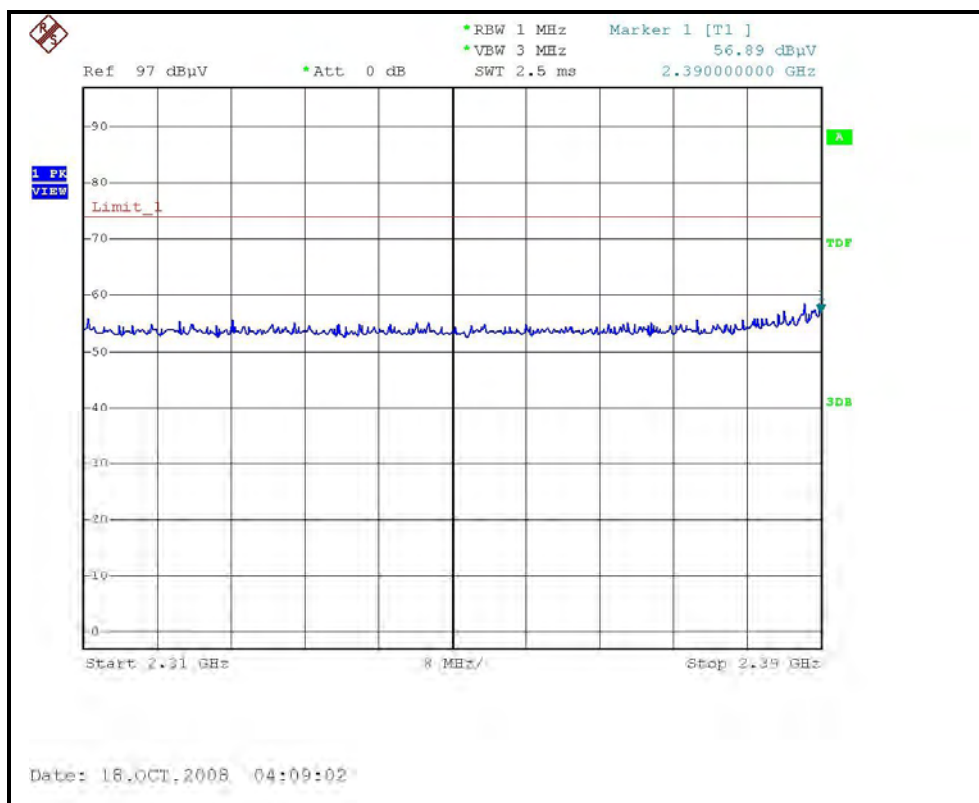



A D T

RESTRICTED BANDEDGE (DRAFT 802.11n (40MHz) MODE,CH7, VERTICAL)

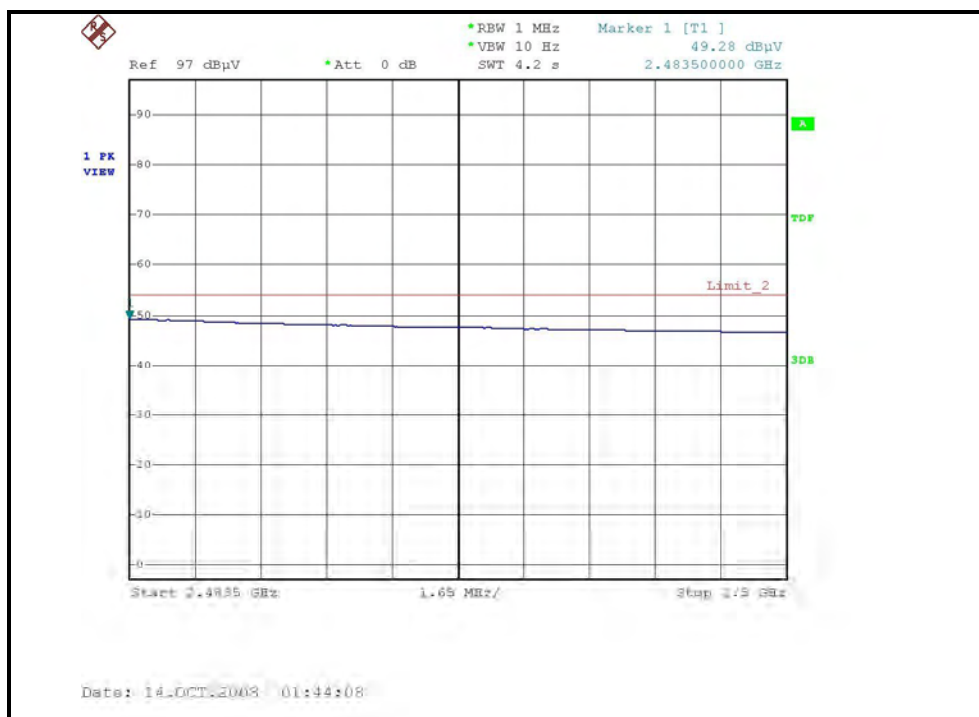
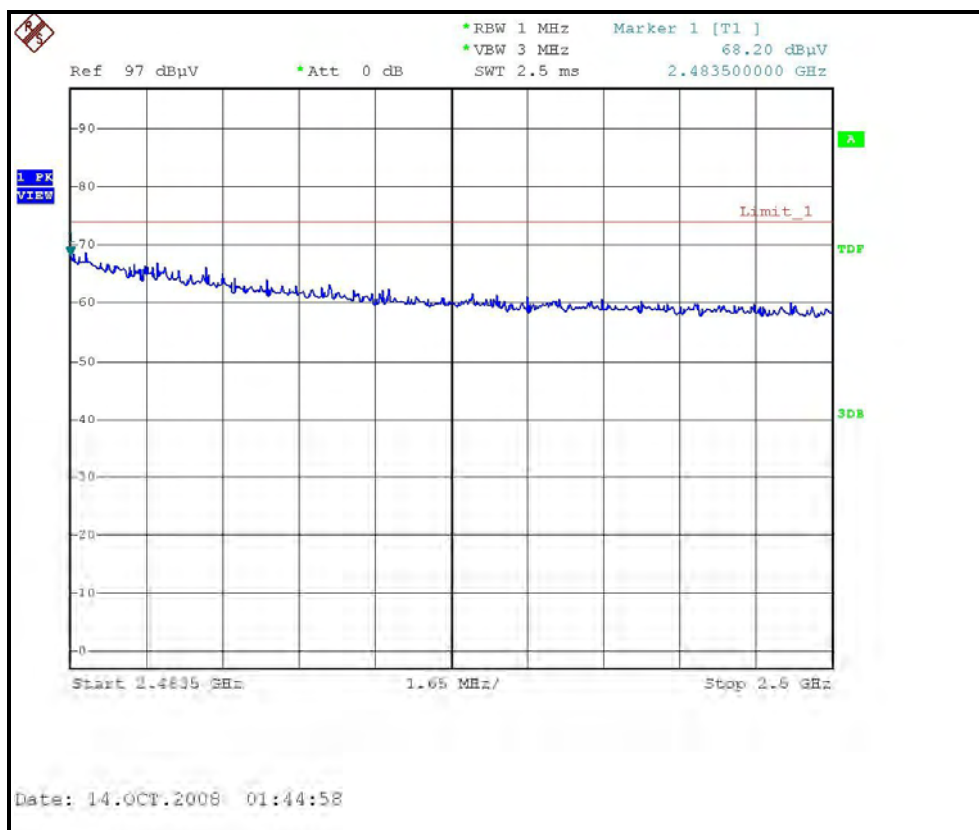



Below 1GHz Test Data

4.2.9 TEST RESULTS – MONOPOLES WITH REFLECTORS ANTENNA

BELOW 1GHz WORST-CASE DATA : 802.11b DSSS MODULATION

EUT TEST CONDITION		MEASUREMENT DETAIL	
CHANNEL	Channel 1	FREQUENCY RANGE	Below 1000MHz
INPUT POWER (SYSTEM)	120Vac, 60 Hz	DETECTOR FUNCTION	Quasi-Peak
ENVIRONMENTAL CONDITIONS	25deg. C, 65%RH 965hPa	TESTED BY	Eric Lin

ANTENNA POLARITY & TEST DISTANCE: HORIZONTAL AT 3 M								
NO.	FREQ. (MHz)	EMISSION LEVEL (dBuV/m)	LIMIT (dBuV/m)	MARGIN (dB)	ANTENNA HEIGHT (m)	TABLE ANGLE (Degree)	RAW VALUE (dBuV)	CORRECTION FACTOR (dB/m)
1	133.33	33.13 QP	43.50	-10.37	1.00 H	357	18.53	14.60
2	166.48	40.33 QP	43.50	-3.17	1.36 H	0	24.92	15.41
3	266.32	41.77 QP	46.00	-4.23	1.44 H	0	25.81	15.96
4	298.90	41.54 QP	46.00	-4.46	1.44 H	281	24.55	16.99
5	333.00	40.26 QP	46.00	-5.74	2.10 H	221	21.89	18.37
6	399.70	35.69 QP	46.00	-10.31	1.91 H	195	14.56	21.13
7	433.00	26.98 QP	46.00	-19.02	1.58 H	15	5.34	21.64
8	500.00	28.69 QP	46.00	-17.31	1.33 H	283	6.03	22.66
9	651.50	34.07 QP	46.00	-11.93	1.84 H	61	8.13	25.94
ANTENNA POLARITY & TEST DISTANCE: VERTICAL AT 3 M								
NO.	FREQ. (MHz)	EMISSION LEVEL (dBuV/m)	LIMIT (dBuV/m)	MARGIN (dB)	ANTENNA HEIGHT (m)	TABLE ANGLE (Degree)	RAW VALUE (dBuV)	CORRECTION FACTOR (dB/m)
1	133.49	33.81 QP	43.50	-9.69	1.90 V	222	19.20	14.61
2	166.57	31.12 QP	43.50	-12.38	1.60 V	66	15.72	15.40
3	199.91	25.78 QP	43.50	-17.72	1.80 V	91	12.79	12.99
4	213.80	26.32 QP	43.50	-17.18	1.86 V	343	12.67	13.65
5	233.50	36.94 QP	46.00	-9.06	2.01 V	49	22.33	14.61
6	266.98	37.40 QP	46.00	-8.60	1.79 V	34	21.42	15.98
7	333.05	35.61 QP	46.00	-10.39	1.10 V	271	17.24	18.37
8	396.65	33.37 QP	46.00	-12.63	1.41 V	201	12.37	21.00
9	401.00	29.11 QP	46.00	-16.89	1.83 V	184	7.95	21.16

- REMARKS:**
1. Emission level (dBuV/m) = Raw Value (dBuV) + Correction Factor (dB/m).
 2. Correction Factor (dB/m) = Antenna Factor (dB/m) + Cable Factor (dB).
 3. The other emission levels were very low against the limit.
 4. Margin value = Emission level – Limit value.



Above 1GHz Test Data

4.2.10 TEST RESULTS – MONOPOLES WITH REFLECTORS ANTENNA

802.11b DSSS MODULATION

EUT TEST CONDITION		MEASUREMENT DETAIL	
CHANNEL	Channel 1	FREQUENCY RANGE	1 ~ 25GHz
INPUT POWER (SYSTEM)	120Vac, 60 Hz	DETECTOR FUNCTION	Peak (PK) Average (AV)
ENVIRONMENTAL CONDITIONS	26deg. C, 55%RH 965hPa	TESTED BY	Frank Liu

ANTENNA POLARITY & TEST DISTANCE: HORIZONTAL AT 3 M								
NO.	FREQ. (MHz)	EMISSION LEVEL (dBuV/m)	LIMIT (dBuV/m)	MARGIN (dB)	ANTENNA HEIGHT (m)	TABLE ANGLE (Degree)	RAW VALUE (dBuV)	CORRECTION FACTOR (dB/m)
1	2390.00	53.38 PK	74.00	-20.62	1.97 H	112	23.32	30.06
2	2390.00	43.28 AV	54.00	-10.72	1.97 H	112	13.22	30.06
3	*2412.00	99.30 PK			1.97 H	112	69.15	30.15
4	*2412.00	93.90 AV			1.97 H	112	63.75	30.15
5	4824.00	48.00 PK	74.00	-26.00	1.63 H	42	12.54	35.46
6	4824.00	39.40 AV	54.00	-14.60	1.63 H	42	3.94	35.46
7	#7236.00	50.60 PK	79.30	-28.70	1.41 H	39	8.75	41.85
8	#7236.00	37.20 AV	73.90	-36.70	1.41 H	39	-4.65	41.85
ANTENNA POLARITY & TEST DISTANCE: VERTICAL AT 3 M								
NO.	FREQ. (MHz)	EMISSION LEVEL (dBuV/m)	LIMIT (dBuV/m)	MARGIN (dB)	ANTENNA HEIGHT (m)	TABLE ANGLE (Degree)	RAW VALUE (dBuV)	CORRECTION FACTOR (dB/m)
1	2390.00	53.53 PK	74.00	-20.47	1.00 V	24	23.47	30.06
2	2390.00	43.09 AV	54.00	-10.91	1.00 V	24	13.03	30.06
3	*2412.00	101.70 PK			1.00 V	21	71.55	30.15
4	*2412.00	96.30 AV			1.00 V	21	66.15	30.15
5	4824.00	48.70 PK	74.00	-25.30	1.43 V	298	13.24	35.46
6	4824.00	41.70 AV	54.00	-12.30	1.43 V	298	6.24	35.46
7	#7236.00	50.80 PK	81.70	-30.90	1.23 V	242	8.95	41.85
8	#7236.00	37.40 AV	76.30	-38.90	1.23 V	242	-4.45	41.85

- REMARKS:**
1. Emission level (dBuV/m) = Raw Value (dBuV) + Correction Factor (dB/m).
 2. Correction Factor (dB/m) = Antenna Factor (dB/m) + Cable Factor (dB).
 3. The other emission levels were very low against the limit.
 4. Margin value = Emission level – Limit value.
 5. “ * “: Fundamental frequency.
 6. “#”:The radiated frequency is out the restricted band.



A D T

EUT TEST CONDITION		MEASUREMENT DETAIL	
CHANNEL	Channel 6	FREQUENCY RANGE	1 ~ 25GHz
INPUT POWER (SYSTEM)	120Vac, 60 Hz	DETECTOR FUNCTION	Peak (PK) Average (AV)
ENVIRONMENTAL CONDITIONS	26deg. C, 55%RH 965hPa	TESTED BY	Frank Liu

ANTENNA POLARITY & TEST DISTANCE: HORIZONTAL AT 3 M								
NO.	FREQ. (MHz)	EMISSION LEVEL (dBuV/m)	LIMIT (dBuV/m)	MARGIN (dB)	ANTENNA HEIGHT (m)	TABLE ANGLE (Degree)	RAW VALUE (dBuV)	CORRECTION FACTOR (dB/m)
1	*2437.00	103.10 PK			1.72 H	120	72.86	30.24
2	*2437.00	97.62 AV			1.72 H	120	67.38	30.24
3	4874.00	48.40 PK	74.00	-25.60	1.70 H	60	12.85	35.55
4	4874.00	39.98 AV	54.00	-14.02	1.70 H	60	4.43	35.55
5	7311.00	51.30 PK	74.00	-22.70	1.50 H	141	9.26	42.04
6	7311.00	38.40 AV	54.00	-15.60	1.50 H	141	-3.64	42.04
ANTENNA POLARITY & TEST DISTANCE: VERTICAL AT 3 M								
NO.	FREQ. (MHz)	EMISSION LEVEL (dBuV/m)	LIMIT (dBuV/m)	MARGIN (dB)	ANTENNA HEIGHT (m)	TABLE ANGLE (Degree)	RAW VALUE (dBuV)	CORRECTION FACTOR (dB/m)
1	*2437.00	104.30 PK			1.00 V	24	74.06	30.24
2	*2437.00	98.99 AV			1.00 V	24	68.75	30.24
3	4874.00	49.99 PK	74.00	-24.01	1.40 V	265	14.44	35.55
4	4874.00	45.90 AV	54.00	-8.10	1.40 V	265	10.35	35.55
5	7311.00	50.54 PK	74.00	-23.46	1.37 V	300	8.50	42.04
6	7311.00	38.60 AV	54.00	-15.40	1.37 V	300	-3.44	42.04

- REMARKS:**
1. Emission level (dBuV/m) = Raw Value (dBuV) + Correction Factor (dB/m).
 2. Correction Factor (dB/m) = Antenna Factor (dB/m) + Cable Factor (dB).
 3. The other emission levels were very low against the limit.
 4. Margin value = Emission level – Limit value.
 5. “ * “: Fundamental frequency.



A D T

EUT TEST CONDITION		MEASUREMENT DETAIL	
CHANNEL	Channel 11	FREQUENCY RANGE	1 ~ 25GHz
INPUT POWER (SYSTEM)	120Vac, 60 Hz	DETECTOR FUNCTION	Peak (PK) Average (AV)
ENVIRONMENTAL CONDITIONS	26deg. C, 55%RH 965hPa	TESTED BY	Frank Liu

ANTENNA POLARITY & TEST DISTANCE: HORIZONTAL AT 3 M

NO.	FREQ. (MHz)	EMISSION LEVEL (dBuV/m)	LIMIT (dBuV/m)	MARGIN (dB)	ANTENNA HEIGHT (m)	TABLE ANGLE (Degree)	RAW VALUE (dBuV)	CORRECTION FACTOR (dB/m)
1	*2462.00	102.30 PK			1.68 H	212	71.96	30.34
2	*2462.00	96.88 AV			1.68 H	212	66.54	30.34
3	2483.50	55.20 PK	74.00	-18.80	1.92 H	210	24.77	30.43
4	2483.50	44.44 AV	54.00	-9.56	1.92 H	210	14.01	30.43
5	4924.00	49.62 PK	74.00	-24.38	1.62 H	74	13.99	35.63
6	4924.00	39.42 AV	54.00	-14.58	1.62 H	74	3.79	35.63
7	7386.00	50.10 PK	74.00	-23.90	1.43 H	153	7.87	42.23
8	7386.00	37.90 AV	54.00	-16.10	1.43 H	153	-4.33	42.23

ANTENNA POLARITY & TEST DISTANCE: VERTICAL AT 3 M

NO.	FREQ. (MHz)	EMISSION LEVEL (dBuV/m)	LIMIT (dBuV/m)	MARGIN (dB)	ANTENNA HEIGHT (m)	TABLE ANGLE (Degree)	RAW VALUE (dBuV)	CORRECTION FACTOR (dB/m)
1	*2462.00	103.50 PK			1.00 V	342	73.16	30.34
2	*2462.00	98.50 AV			1.00 V	342	68.16	30.34
3	2483.50	56.32 PK	74.00	-17.68	1.00 V	22	25.89	30.43
4	2483.50	46.07 AV	54.00	-7.93	1.00 V	22	15.64	30.43
5	4924.00	50.10 PK	74.00	-23.90	1.39 V	300	14.47	35.63
6	4924.00	44.80 AV	54.00	-9.20	1.39 V	300	9.17	35.63
7	7386.00	50.03 PK	74.00	-23.97	1.29 V	261	7.80	42.23
8	7386.00	37.48 AV	54.00	-16.52	1.29 V	261	-4.75	42.23

- REMARKS:**
1. Emission level (dBuV/m) = Raw Value (dBuV) + Correction Factor (dB/m).
 2. Correction Factor (dB/m) = Antenna Factor (dB/m) + Cable Factor (dB).
 3. The other emission levels were very low against the limit.
 4. Margin value = Emission level – Limit value.
 5. “ * “: Fundamental frequency.



A D T

RESTRICTED BANDEDGE (802.11b MODE,CH1, HORIZONTAL)

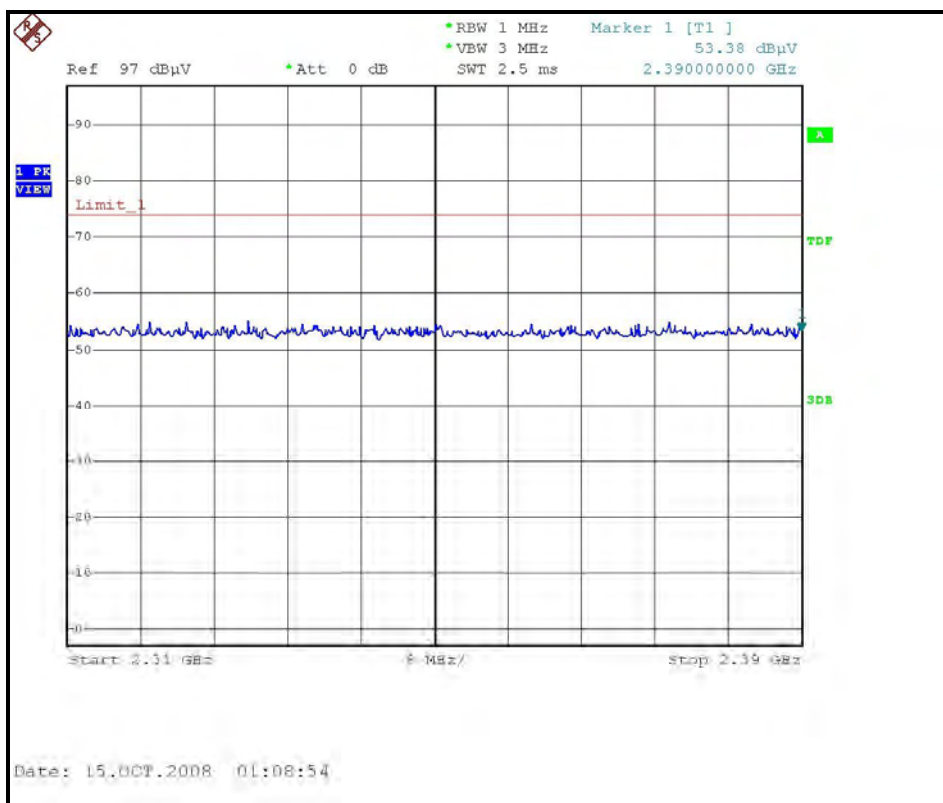



A D T

RESTRICTED BANDEDGE (802.11b MODE, CH1, VERTICAL)

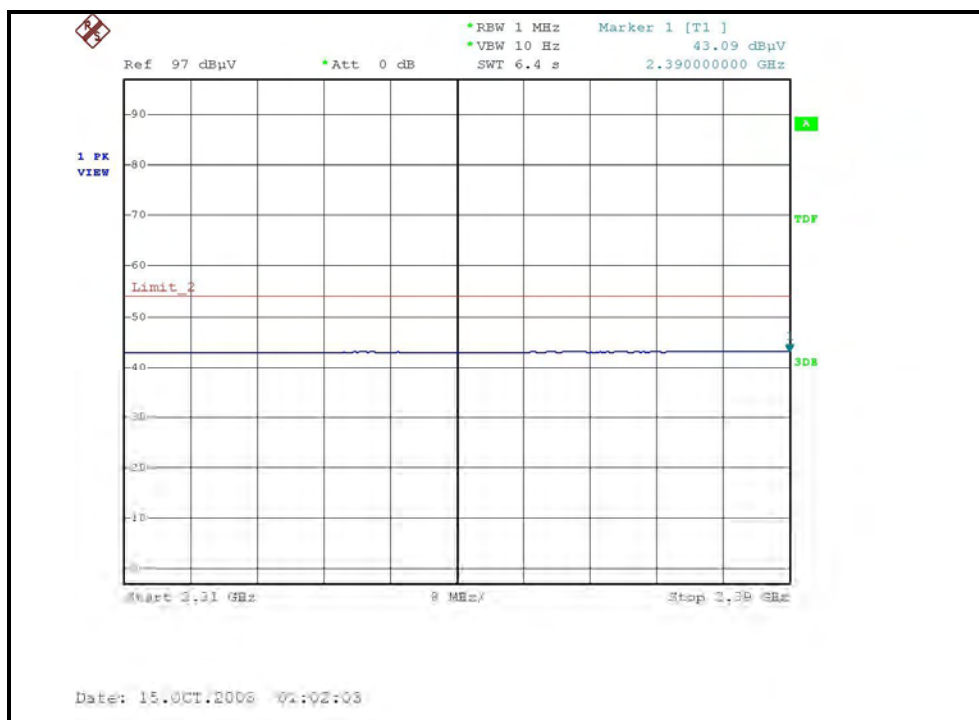
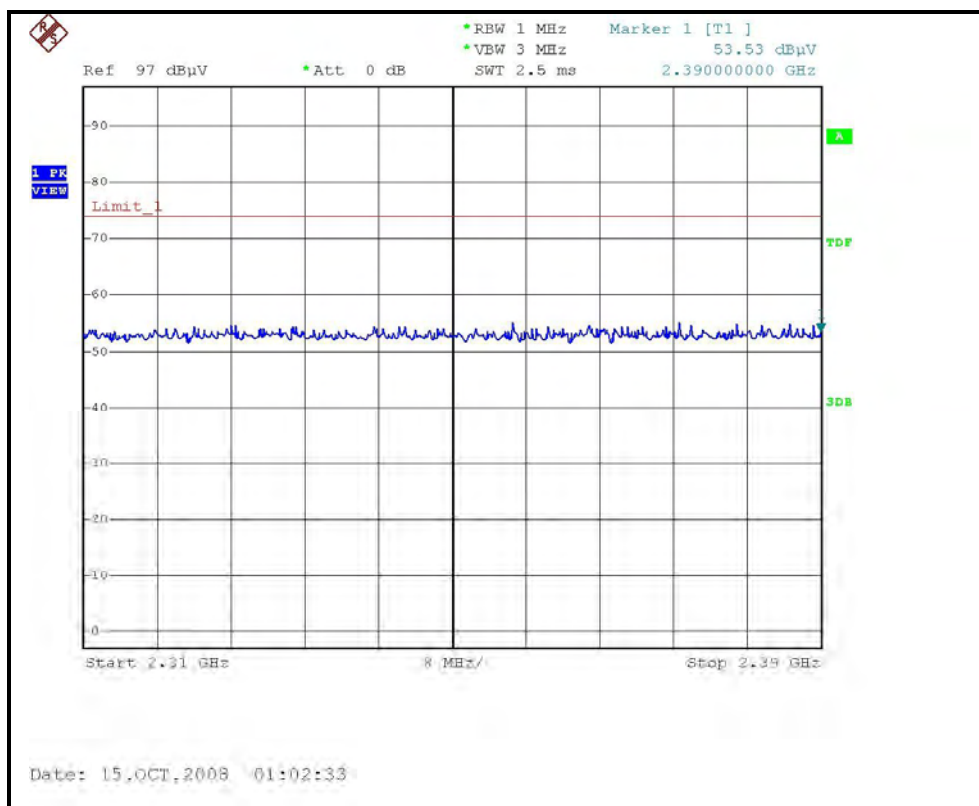



A D T

RESTRICTED BANDEDGE (802.11b MODE,CH11, HORIZONTAL)

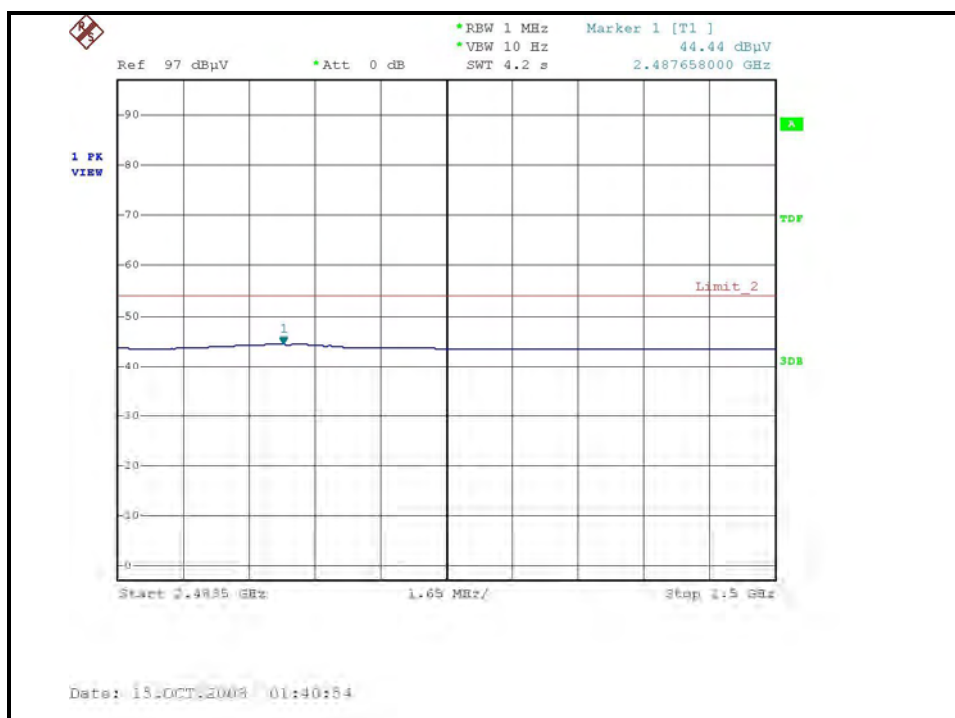
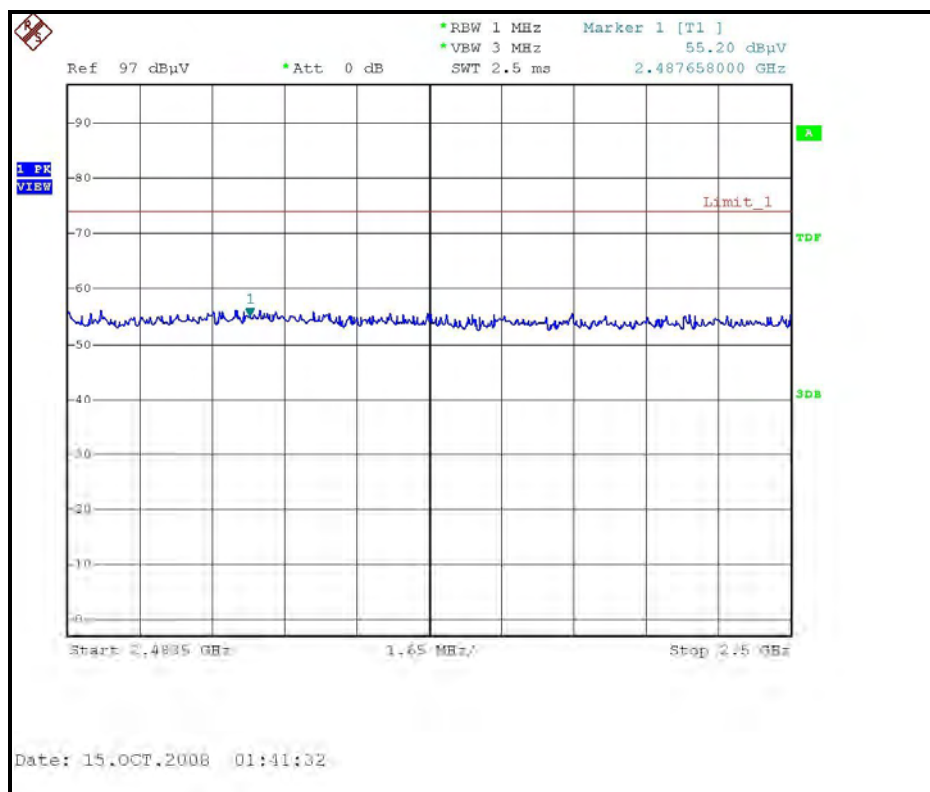



A D T

RESTRICTED BANDEDGE (802.11b MODE, CH11, VERTICAL)

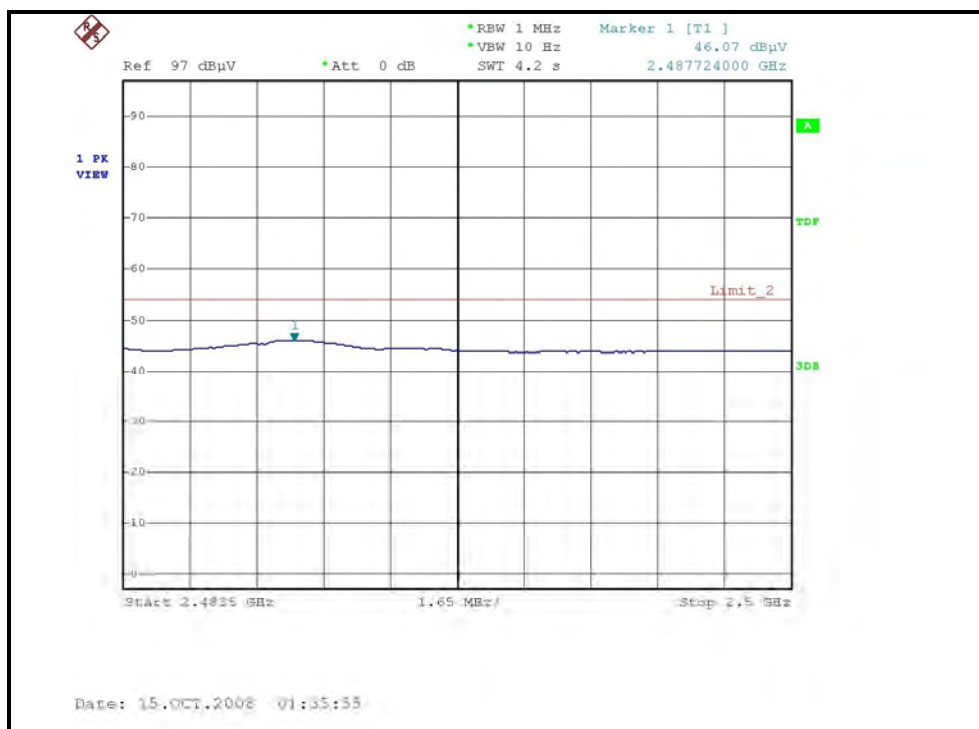
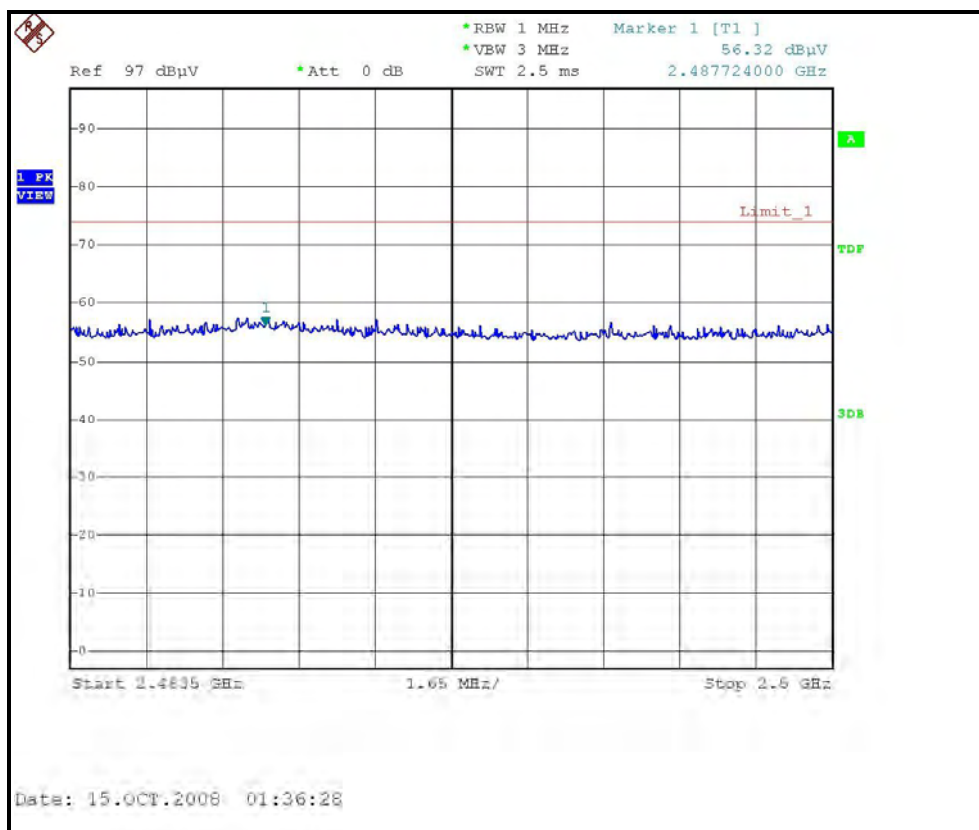



802.11g OFDM MODULATION

EUT TEST CONDITION		MEASUREMENT DETAIL	
CHANNEL	Channel 1	FREQUENCY RANGE	1 ~ 25GHz
INPUT POWER (SYSTEM)	120Vac, 60 Hz	DETECTOR FUNCTION	Peak (PK) Average (AV)
ENVIRONMENTAL CONDITIONS	26deg. C, 55%RH 965hPa	TESTED BY	Frank Liu

ANTENNA POLARITY & TEST DISTANCE: HORIZONTAL AT 3 M

NO.	FREQ. (MHz)	EMISSION LEVEL (dBuV/m)	LIMIT (dBuV/m)	MARGIN (dB)	ANTENNA HEIGHT (m)	TABLE ANGLE (Degree)	RAW VALUE (dBuV)	CORRECTION FACTOR (dB/m)
1	2390.00	54.60 PK	74.00	-19.40	1.82 H	300	24.54	30.06
2	2390.00	43.20 AV	54.00	-10.80	1.82 H	300	13.14	30.06
3	*2412.00	96.52 PK			1.99 H	290	66.37	30.15
4	*2412.00	86.23 AV			1.99 H	290	56.08	30.15
5	4824.00	47.62 PK	74.00	-26.38	1.88 H	282	12.16	35.46
6	4824.00	36.13 AV	54.00	-17.87	1.88 H	282	0.67	35.46
7	#7236.00	53.11 PK	76.52	-23.41	1.90 H	11	11.26	41.85
8	#7236.00	38.41 AV	66.23	-27.82	1.90 H	11	-3.44	41.85

ANTENNA POLARITY & TEST DISTANCE: VERTICAL AT 3 M

NO.	FREQ. (MHz)	EMISSION LEVEL (dBuV/m)	LIMIT (dBuV/m)	MARGIN (dB)	ANTENNA HEIGHT (m)	TABLE ANGLE (Degree)	RAW VALUE (dBuV)	CORRECTION FACTOR (dB/m)
1	2390.00	55.66 PK	74.00	-18.34	1.00 V	20	25.60	30.06
2	2390.00	43.57 AV	54.00	-10.43	1.00 V	20	13.51	30.06
3	*2412.00	101.50 PK			1.00 V	21	71.35	30.15
4	*2412.00	90.10 AV			1.00 V	21	59.95	30.15
5	4824.00	44.17 PK	74.00	-29.83	1.01 V	78	8.71	35.46
6	4824.00	33.69 AV	54.00	-20.31	1.01 V	78	-1.77	35.46
7	#7236.00	51.08 PK	81.50	-30.42	1.00 V	350	9.23	41.85
8	#7236.00	37.58 AV	70.10	-32.52	1.00 V	350	-4.27	41.85

- REMARKS:**
1. Emission level (dBuV/m) = Raw Value (dBuV) + Correction Factor (dB/m).
 2. Correction Factor (dB/m) = Antenna Factor (dB/m) + Cable Factor (dB).
 3. The other emission levels were very low against the limit.
 4. Margin value = Emission level – Limit value.
 5. “ * “: Fundamental frequency.
 6. “#”:The radiated frequency is out the restricted band.



A D T

EUT TEST CONDITION		MEASUREMENT DETAIL	
CHANNEL	Channel 6	FREQUENCY RANGE	1 ~ 25GHz
INPUT POWER (SYSTEM)	120Vac, 60 Hz	DETECTOR FUNCTION	Peak (PK) Average (AV)
ENVIRONMENTAL CONDITIONS	26deg. C, 55%RH 965hPa	TESTED BY	Frank Liu

ANTENNA POLARITY & TEST DISTANCE: HORIZONTAL AT 3 M								
NO.	FREQ. (MHz)	EMISSION LEVEL (dBuV/m)	LIMIT (dBuV/m)	MARGIN (dB)	ANTENNA HEIGHT (m)	TABLE ANGLE (Degree)	RAW VALUE (dBuV)	CORRECTION FACTOR (dB/m)
1	*2437.00	96.92 PK			2.00 H	316	66.68	30.24
2	*2437.00	85.61 AV			2.00 H	316	55.37	30.24
3	4874.00	46.79 PK	74.00	-27.21	1.93 H	78	11.24	35.55
4	4874.00	34.01 AV	54.00	-19.99	1.93 H	78	-1.54	35.55
5	7311.00	51.83 PK	74.00	-22.17	1.99 H	265	9.79	42.04
6	7311.00	37.62 AV	54.00	-16.38	1.99 H	265	-4.42	42.04
ANTENNA POLARITY & TEST DISTANCE: VERTICAL AT 3 M								
NO.	FREQ. (MHz)	EMISSION LEVEL (dBuV/m)	LIMIT (dBuV/m)	MARGIN (dB)	ANTENNA HEIGHT (m)	TABLE ANGLE (Degree)	RAW VALUE (dBuV)	CORRECTION FACTOR (dB/m)
1	*2437.00	102.80 PK			1.00 V	17	72.56	30.24
2	*2437.00	91.20 AV			1.00 V	17	60.96	30.24
3	4874.00	45.23 PK	74.00	-28.77	1.00 V	68	9.68	35.55
4	4874.00	34.01 AV	54.00	-19.99	1.00 V	68	-1.54	35.55
5	7311.00	52.58 PK	74.00	-21.42	1.01 V	172	10.54	42.04
6	7311.00	38.11 AV	54.00	-15.89	1.01 V	172	-3.93	42.04

- REMARKS:**
1. Emission level (dBuV/m) = Raw Value (dBuV) + Correction Factor (dB/m).
 2. Correction Factor (dB/m) = Antenna Factor (dB/m) + Cable Factor (dB).
 3. The other emission levels were very low against the limit.
 4. Margin value = Emission level – Limit value.
 5. “ * “: Fundamental frequency.



A D T

EUT TEST CONDITION		MEASUREMENT DETAIL	
CHANNEL	Channel 11	FREQUENCY RANGE	1 ~ 25GHz
INPUT POWER (SYSTEM)	120Vac, 60 Hz	DETECTOR FUNCTION	Peak (PK) Average (AV)
ENVIRONMENTAL CONDITIONS	26deg. C, 55%RH 965hPa	TESTED BY	Frank Liu

ANTENNA POLARITY & TEST DISTANCE: HORIZONTAL AT 3 M

NO.	FREQ. (MHz)	EMISSION LEVEL (dBuV/m)	LIMIT (dBuV/m)	MARGIN (dB)	ANTENNA HEIGHT (m)	TABLE ANGLE (Degree)	RAW VALUE (dBuV)	CORRECTION FACTOR (dB/m)
1	*2462.00	97.11 PK			2.00 H	272	66.77	30.34
2	*2462.00	86.58 AV			2.00 H	272	56.24	30.34
3	2483.50	66.01 PK	74.00	-7.99	1.92 H	280	35.58	30.43
4	2483.50	43.81 AV	54.00	-10.19	1.92 H	280	13.38	30.43
5	4924.00	45.68 PK	74.00	-28.32	1.93 H	48	10.05	35.63
6	4924.00	33.84 AV	54.00	-20.16	1.93 H	48	-1.79	35.63
7	7386.00	52.20 PK	74.00	-21.80	1.80 H	77	9.97	42.23
8	7386.00	38.01 AV	54.00	-15.99	1.80 H	77	-4.22	42.23

ANTENNA POLARITY & TEST DISTANCE: VERTICAL AT 3 M

NO.	FREQ. (MHz)	EMISSION LEVEL (dBuV/m)	LIMIT (dBuV/m)	MARGIN (dB)	ANTENNA HEIGHT (m)	TABLE ANGLE (Degree)	RAW VALUE (dBuV)	CORRECTION FACTOR (dB/m)
1	*2462.00	102.60 PK			1.00 V	342	72.26	30.34
2	*2462.00	91.50 AV			1.00 V	342	61.16	30.34
3	2483.50	63.98 PK	74.00	-10.02	1.00 V	353	33.55	30.43
4	2483.50	47.22 AV	54.00	-6.78	1.00 V	353	16.79	30.43
5	4924.00	43.58 PK	74.00	-30.42	1.00 V	78	7.95	35.63
6	4924.00	33.72 AV	54.00	-20.28	1.00 V	78	-1.91	35.63
7	7386.00	52.13 PK	74.00	-21.87	1.01 V	5	9.90	42.23
8	7386.00	39.62 AV	54.00	-14.38	1.01 V	5	-2.61	42.23

- REMARKS:**
1. Emission level (dBuV/m) = Raw Value (dBuV) + Correction Factor (dB/m).
 2. Correction Factor (dB/m) = Antenna Factor (dB/m) + Cable Factor (dB).
 3. The other emission levels were very low against the limit.
 4. Margin value = Emission level – Limit value.
 5. “ * “: Fundamental frequency.



A D T

RESTRICTED BANDEDGE (802.11g MODE, CH1, HORIZONTAL)

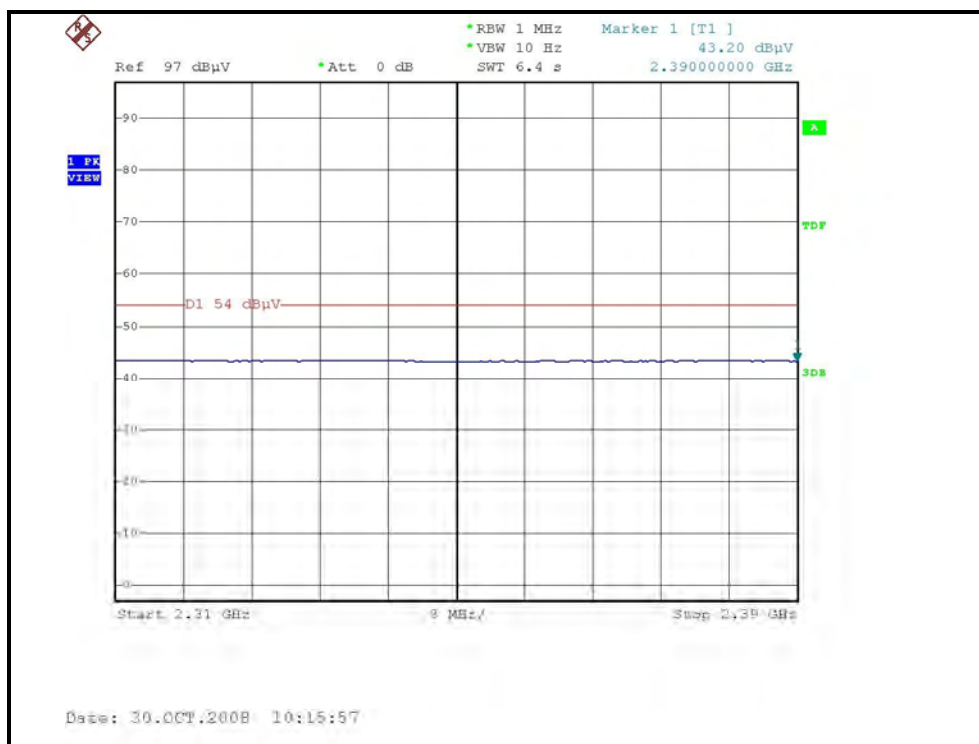
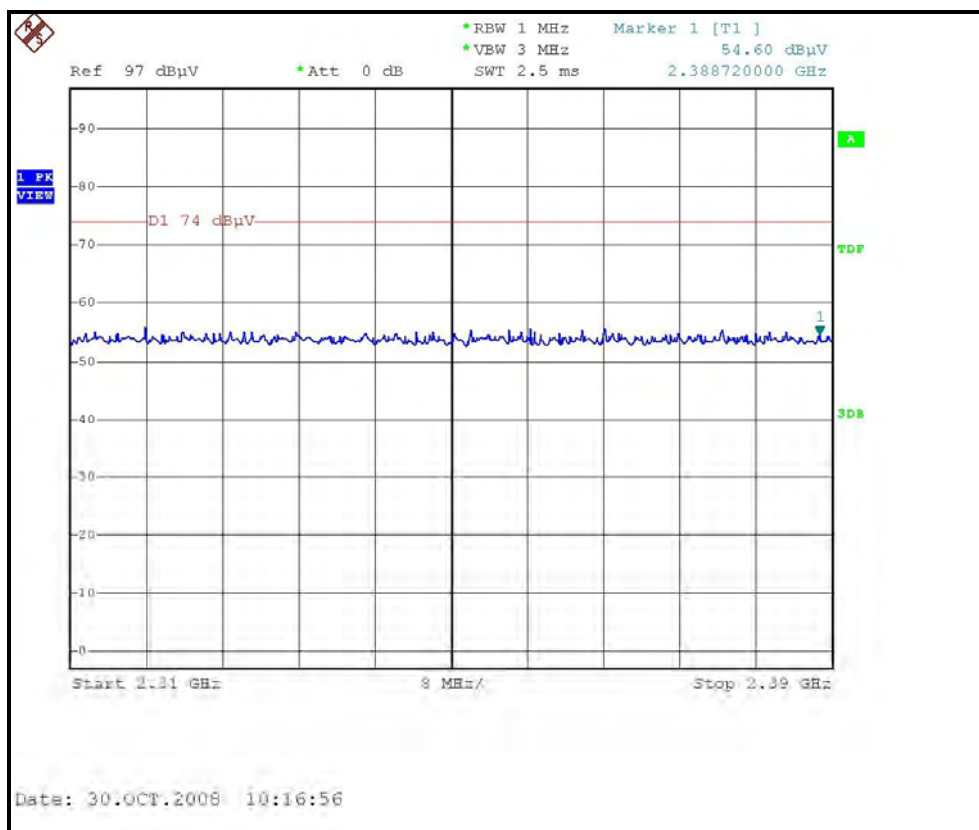



A D T

RESTRICTED BANDEDGE (802.11g MODE, CH1, VERTICAL)

