



FCC TEST REPORT

REPORT NO.: RF990623E06A

MODEL NO.: NWD2205

FCC ID: I88NWD2205

RECEIVED: Mar. 29, 2010

TESTED: Mar. 29, 2010 & July 06 to 16, 2010

ISSUED: Aug. 13, 2010

APPLICANT: ZyXEL Communications Corporation

ADDRESS: No. 6, Innovation Road II, Science-Park, Hsin-Chu, 300,
Taiwan

ISSUED BY: Bureau Veritas Consumer Products Services (H.K.)
Ltd., Taoyuan Branch Hsin Chu Laboratory

LAB ADDRESS: No. 81-1, Lu Liao Keng, 9th Ling, Wu Lung Tsuen,
Chiung Lin Hsiang, Hsin Chu Hsien 307, Taiwan

This test report consists of 77 pages in total. It may be duplicated completely for legal use with the approval of the applicant. It should not be reproduced except in full, without the written approval of our laboratory. The client should not use it to claim product certification, approval, or endorsement by TAF any government agencies. The test results in the report only apply to the tested sample.





Table of Contents

1.	CERTIFICATION	5
2.	SUMMARY OF TEST RESULTS	6
2.1	MEASUREMENT UNCERTAINTY	7
3.	GENERAL INFORMATION.....	8
3.1	GENERAL DESCRIPTION OF EUT	8
3.2	DESCRIPTION OF TEST MODES.....	10
3.2.1	TEST MODE APPLICABILITY AND TESTED CHANNEL DETAIL	11
3.3	GENERAL DESCRIPTION OF APPLIED STANDARDS.....	14
3.4	DESCRIPTION OF SUPPORT UNITS	15
3.5	CONFIGURATION OF SYSTEM UNDER TEST.....	15
4.	TEST TYPES AND RESULTS	16
4.1	CONDUCTED EMISSION MEASUREMENT.....	16
4.1.1	LIMITS OF CONDUCTED EMISSION MEASUREMENT	16
4.1.2	TEST INSTRUMENTS	16
4.1.3	TEST PROCEDURES.....	17
4.1.4	DEVIATION FROM TEST STANDARD.....	17
4.1.5	TEST SETUP	18
4.1.6	EUT OPERATING CONDITIONS	18
4.1.7	TEST RESULTS.....	19
4.2	RADIATED EMISSION MEASUREMENT.....	21
4.2.1	LIMITS OF RADIATED EMISSION MEASUREMENT	21
4.2.2	TEST INSTRUMENTS	22
4.2.3	TEST PROCEDURES.....	23
4.2.4	DEVIATION FROM TEST STANDARD.....	23
4.2.5	TEST SETUP	24
4.2.6	EUT OPERATING CONDITIONS	24



4.2.7	TEST RESULTS.....	25
4.3	6dB BANDWIDTH MEASUREMENT.....	54
4.3.1	LIMITS OF 6dB BANDWIDTH MEASUREMENT	54
4.3.2	TEST INSTRUMENTS	54
4.3.3	TEST PROCEDURE	54
4.3.4	DEVIATION FROM TEST STANDARD.....	54
4.3.5	TEST SETUP	54
4.3.6	EUT OPERATING CONDITIONS	54
4.3.7	TEST RESULTS.....	55
4.4	MAXIMUM PEAK OUTPUT POWER.....	59
4.4.1	LIMITS OF MAXIMUM PEAK OUTPUT POWER MEASUREMENT	59
4.4.2	INSTRUMENTS	59
4.4.3	TEST PROCEDURES.....	59
4.4.4	DEVIATION FROM TEST STANDARD.....	59
4.4.5	TEST SETUP	59
4.4.6	EUT OPERATING CONDITIONS	59
4.4.7	TEST RESULTS.....	60
4.5	POWER SPECTRAL DENSITY MEASUREMENT	62
4.5.1	LIMITS OF POWER SPECTRAL DENSITY MEASUREMENT	62
4.5.2	TEST INSTRUMENTS	62
4.5.3	TEST PROCEDURE	62
4.5.4	DEVIATION FROM TEST STANDARD.....	62
4.5.5	TEST SETUP	62
4.5.6	EUT OPERATING CONDITION	62
4.5.7	TEST RESULTS.....	63
4.6	CONDUCTED OUT-BAND EMISSION MEASUREMENT	67
4.6.1	LIMITS OF CONDUCTED OUT-BAND EMISSION MEASUREMENT	67



A D T

4.6.2	TEST INSTRUMENTS	67
4.6.3	TEST PROCEDURE	67
4.6.4	DEVIATION FROM TEST STANDARD.....	67
4.6.5	EUT OPERATING CONDITION	67
4.6.6	TEST RESULTS.....	67
5.	INFORMATION ON THE TESTING LABORATORIES.....	76
6.	APPENDIX A - MODIFICATIONS RECORDERS FOR ENGINEERING CHANGES TO THE EUT BY THE LAB.....	77



1. CERTIFICATION

PRODUCT: Wireless N USB Adapter
BRAND NAME: ZyXEL
MODEL NO.: NWD2205
TEST SAMPLE: ENGINEERING SAMPLE
TESTED: Mar. 29, 2010 & July 06 to 16, 2010
APPLICANT: ZyXEL Communications Corporation
STANDARDS: FCC Part 15, Subpart C (Section 15.247)
ANSI C63.4-2003

The above equipment (Model: NWD2205) has been tested by **Bureau Veritas Consumer Products Services (H.K.) Ltd., Taoyuan Branch**, and found compliance with the requirement of the above standards. The test record, data evaluation & Equipment Under Test (EUT) configurations represented herein are true and accurate accounts of the measurements of the sample's EMC characteristics under the conditions specified in this report.

PREPARED BY : *Sunny Wen* , **DATE:** *Aug 13, 2010*
(Sunny Wen, Specialist)

TECHNICAL ACCEPTANCE : *Hank Chung* , **DATE:** *Aug 13, 2010*
(Hank Chung, Deputy Manager)

APPROVED BY : *May Chen* , **DATE:** *Aug 13, 2010*
(May Chen, Deputy Manager)

2. SUMMARY OF TEST RESULTS

The EUT has been tested according to the following specifications:

APPLIED STANDARD: FCC Part 15, Subpart C			
Standard Section	Test Type and Limit	Result	Remark
15.207	AC Power Conducted Emission	PASS	Meet the requirement of limit. Minimum passing margin is -14.47dB at 0.170MHz
15.247(a)(2)	Spectrum Bandwidth of a Direct Sequence Spread Spectrum System Limit: min. 500kHz	PASS	Meet the requirement of limit.
15.247(b)	Maximum Peak Output Power Limit: max. 30dBm	PASS	Meet the requirement of limit.
15.247(d)	Radiated Emissions Limit: Table 15.209	PASS	Meet the requirement of limit. Minimum passing margin is -0.6dB at 2483.5MHz
15.247(e)	Power Spectral Density Limit: max. 8dBm	PASS	Meet the requirement of limit.
15.247(d)	Conducted Out-Band Emission Measurement Limit: 20dB less than the peak value of fundamental frequency	PASS	Meet the requirement of limit.
15.203	Antenna Requirement	PASS	No antenna connector is used.

2.1 MEASUREMENT UNCERTAINTY

Where relevant, the following measurement uncertainty levels have been estimated for tests performed on the EUT as specified in CISPR 16-4-2:

This uncertainty represents an expanded uncertainty expressed at approximately the 95% confidence level using a coverage factor of $k=2$.

Measurement	Value
Conducted emissions	2.45 dB
Radiated emissions (30MHz-1GHz)	2.94 dB
Radiated emissions (1GHz -18GHz)	2.49 dB
Radiated emissions (18GHz -40GHz)	2.70 dB



A D T

3. GENERAL INFORMATION

3.1 GENERAL DESCRIPTION OF EUT

PRODUCT	Wireless N USB Adapter
MODEL NO.	NWD2205
FCC ID	I88NWD2205
POWER SUPPLY	DC 5V from host equipment
MODULATION TYPE	CCK, DQPSK, DBPSK for DSSS 64QAM, 16QAM, QPSK, BPSK for OFDM
MODULATION TECHNOLOGY	DSSS, OFDM
TRANSFER RATE	802.11b: 11 / 5.5 / 2 / 1Mbps 802.11g: 54 / 48 / 36 / 24 / 18 / 12 / 9 / 6Mbps HT20 MCS 0~7 (800ns GI): 65 / 58.5 / 52 / 39 / 26 / 19.5 / 13 / 6.5Mbps. HT20 MCS 8~15 (800ns GI): 130 / 117 / 104 / 78 / 52 / 39 / 26 / 13Mbps. HT40 MCS 0~7 (800ns GI): 135 / 121.5 / 108 / 81 / 54 / 40.5 / 27 / 13.5Mbps. HT40 MCS 8~15 (800ns GI): 270 / 243 / 216 / 162 / 108 / 81 / 54 / 27Mbps. HT20 MCS 0~7 (400ns GI): 72.2 / 65 / 57.8 / 43.3 / 28.9 / 21.7 / 14.4 / 7.2Mbps. HT20 MCS 8~15 (400ns GI): 144.444 / 130 / 115.556 / 86.667 / 57.778 / 43.333 / 28.889 / 14.444Mbps. HT40 MCS 0~7 (400ns GI): 150 / 135 / 120 / 90 / 60 / 45 / 30 / 15Mbps. HT40 MCS 8~15 (400ns GI): 300 / 270 / 240 / 180 / 120 / 90 / 60 / 30Mbps.
FREQUENCY RANGE	2412MHz ~ 2462MHz
NUMBER OF CHANNEL	11 for 802.11b, 802.11g, 802.11n (20MHz) 7 for 802.11n (40MHz)
MAXIMUM OUTPUT POWER	802.11b: 64.6mW 802.11g: 281.8mW 802.11n (20MHz): 670.3mW 802.11n (40MHz): 592.7mW
ANTENNA TYPE	Please see note 1
DATA CABLE	NA
I/O PORTS	NA
ASSOCIATED DEVICES	NA

NOTE:

1. There are two antennas provided to this EUT, please refer to the following table:

Chain	Antenna Type	Antenna Connector	Antenna Gain (dBi)
Chain (0)	PIFA	NA	2.8
Chain(1)	PIFA	NA	2.9

2. The EUT incorporates a MIMO function with 802.11n. Physically, the EUT provides two completed transmits and two completed receivers.
3. The EUT is 2 * 2 spatial MIMO (2Tx & 2Rx) without beam forming function. The antenna configurations are two transmit antennas and two receiver antennas, as there are 2 PIFA antennas. Spatial multiplexing modes for simultaneous transmission using 2 antennas, and for simultaneous receiver using 2 antennas. The 11bg legacy mode is limited to single transmitter only.
4. The EUT complies with 802.11n standards and backwards compatible with 802.11b, 802.11g products.
5. When the EUT operating in 802.11n, the software operation, which is defined by manufacturer, MCS (Modulation and Coding Schemes) from 0 to 15.
6. The above EUT information was declared by manufacturer and for more detailed features description, please refer to the manufacturer's specifications or user's manual.



A D T

3.2 DESCRIPTION OF TEST MODES

Eleven channels are provided for 802.11b, 802.11g, 802.11n (20MHz):

CHANNEL	FREQUENCY	CHANNEL	FREQUENCY
1	2412MHz	7	2442MHz
2	2417MHz	8	2447MHz
3	2422MHz	9	2452MHz
4	2427MHz	10	2457MHz
5	2432MHz	11	2462MHz
6	2437MHz		

Seven channels are provided for 802.11n (40MHz):

CHANNEL	FREQUENCY	CHANNEL	FREQUENCY
1	2422MHz	5	2442MHz
2	2427MHz	6	2447MHz
3	2432MHz	7	2452MHz
4	2437MHz		

3.2.1 TEST MODE APPLICABILITY AND TESTED CHANNEL DETAIL

EUT CONFIGURE MODE	APPLICABLE TO				DESCRIPTION
	PLC	RE < 1G	RE ≥ 1G	APCM	
-	√	√	√	√	-

Where **PLC**: Power Line Conducted Emission

RE < 1G: Radiated Emission below 1GHz

RE ≥ 1G: Radiated Emission above 1GHz

APCM: Antenna Port Conducted Measurement

ANTENNA COMBINATION MODE:

COMBINATION MODE	OPERATION MODE	TX CHAIN(0)	TX CHAIN(1)
A	802.11 b	√	
B	802.11 g	√	
C	802.11n (20MHz) for MCS 0~7	√	
D	802.11n (20MHz) for MCS 0~7	√	√
E	802.11n (20MHz) for MCS 0~7		√
F	802.11n (20MHz) for MCS 8~15	√	
G	802.11n (20MHz) for MCS 8~15	√	√
H	802.11n (20MHz) for MCS 8~15		√
I	802.11n (40MHz) for MCS 0~7	√	
J	802.11n (40MHz) for MCS 0~7	√	√
K	802.11n (40MHz) for MCS 0~7		√
L	802.11n (40MHz) for MCS 8~15	√	
M	802.11n (40MHz) for MCS 8~15	√	√
N	802.11n (40MHz) for MCS 8~15		√

Note:

1. The above information was declared by manufacturer and for more detailed features description, please refer to the manufacturer's specifications or user's manual.
2. Mode A, B, G & M the worst modes, were selected as representative mode for the report.



A D T

POWER LINE CONDUCTED EMISSION TEST:

- Pre-Scan has been conducted to determine the worst-case mode from all possible combinations between available modulations, data rates and antenna ports (if EUT with antenna diversity architecture).
- Following channel(s) was (were) selected for the final test as listed below.

MODE	AVAILABLE CHANNEL	TESTED CHANNEL	MODULATION TECHNOLOGY	MODULATION TYPE	DATA RATE (Mbps)	TX COMBINATION
802.11g	1 to 11	6	OFDM	BPSK	6	B

RADIATED EMISSION TEST (BELOW 1 GHz):

- Pre-Scan has been conducted to determine the worst-case mode from all possible combinations between available modulations, data rates and antenna ports (if EUT with antenna diversity architecture).
- Following channel(s) was (were) selected for the final test as listed below.

MODE	AVAILABLE CHANNEL	TESTED CHANNEL	MODULATION TECHNOLOGY	MODULATION TYPE	DATA RATE (Mbps)	TX COMBINATION
802.11n (20MHz)	1 to 11	6	OFDM	BPSK	13	G

RADIATED EMISSION TEST (ABOVE 1 GHz):

- Pre-Scan has been conducted to determine the worst-case mode from all possible combinations between available modulations, data rates and antenna ports (if EUT with antenna diversity architecture).
- Following channel(s) was (were) selected for the final test as listed below.

MODE	AVAILABLE CHANNEL	TESTED CHANNEL	MODULATION TECHNOLOGY	MODULATION TYPE	DATA RATE (Mbps)	TX COMBINATION
802.11b	1 to 11	1, 6, 11	DSSS	DBPSK	1	A
802.11g	1 to 11	1, 6, 11	OFDM	BPSK	6	B
802.11n (20MHz)	1 to 11	1, 6, 11	OFDM	BPSK	13	G
802.11n (40MHz)	1 to 7	1, 4, 7	OFDM	BPSK	27	M

CONDUCTED OUT-BAND EMISSION MEASUREMENT:

- Pre-Scan has been conducted to determine the worst-case mode from all possible combinations between available modulations, data rates and antenna ports (if EUT with antenna diversity architecture).
- Following channel(s) was (were) selected for the final test as listed below.

MODE	AVAILABLE CHANNEL	TESTED CHANNEL	MODULATION TECHNOLOGY	MODULATION TYPE	DATA RATE (Mbps)	TX COMBINATION
802.11b	1 to 11	1, 11	DSSS	DBPSK	1	A
802.11g	1 to 11	1, 11	OFDM	BPSK	6	B
802.11n (20MHz)	1 to 11	1, 11	OFDM	BPSK	13	G
802.11n (40MHz)	1 to 7	1, 7	OFDM	BPSK	27	M

- ※ After verification, conducted out band emission as show worst chain in report by investigations.

ANTENNA PORT CONDUCTED MEASUREMENT:

- This item includes all test value of each mode, but only includes spectrum plot of worst value of each mode.
- The EUT have MIMO power save mode, one transmitter may be active (chain 0) while other is inactive (chain 1). Output power is no different compared to operation when both transmitter chains are active. Transmitter power is not increased or decreased for chain 0 when in single chain mode, compared to dual chain active mode.
- Following channel(s) was (were) selected for the final test as listed below.

MODE	AVAILABLE CHANNEL	TESTED CHANNEL	MODULATION TECHNOLOGY	MODULATION TYPE	DATA RATE (Mbps)	TX COMBINATION
802.11b	1 to 11	1, 6, 11	DSSS	DBPSK	1	A
802.11g	1 to 11	1, 6, 11	OFDM	BPSK	6	B
802.11n (20MHz)	1 to 11	1, 6, 11	OFDM	BPSK	13	G
802.11n (40MHz)	1 to 7	1, 4, 7	OFDM	BPSK	27	M

- ※ After verification, bandwidth as show worst chain in report by investigations.

※ **TEST CONDITION:**

APPLICABLE TO	ENVIRONMENTAL CONDITIONS	INPUT POWER (SYSTEM)	TESTED BY
RE ³ 1G	30deg. C, 80%RH, 1012 hPa	120Vac, 60Hz	Wen Yu / Phoenix Huang
RE<1G	32deg. C, 63%RH, 1012 hPa	120Vac, 60Hz	Wen Yu
PLC	28deg. C, 63%RH, 1012 hPa	120Vac, 60Hz	Wen Yu
APCM	25deg. C, 70%RH, 1012 hPa	120Vac, 60Hz	Eric Lee



A D T

3.3 GENERAL DESCRIPTION OF APPLIED STANDARDS

The EUT is a RF product. According to the specifications of the manufacturer, it must comply with the requirements of the following standards:

FCC Part 15, Subpart C. (15.247)

ANSI C63.4-2003

All test items have been performed and recorded as per the above standards.

NOTE: The EUT has been verified to comply with the requirements of FCC Part 15, Subpart B, Class B (DoC). The test report has been issued separately.



3.4 DESCRIPTION OF SUPPORT UNITS

The EUT has been tested as an independent unit together with other necessary accessories or support units. The following support units or accessories were used to form a representative test configuration during the tests.

NO.	PRODUCT	BRAND	MODEL NO.	SERIAL NO.	FCC ID
1	NOTEBOOK COMPUTER	DELL	PP17L	CN-ONF743-48643-7AV-0124	FCC DoC
2	MODEM	ACEEX	1414	0206026776	IFAXDM1414

NO.	SIGNAL CABLE DESCRIPTION OF THE ABOVE SUPPORT UNITS
1	NA
2	1.2 m braid shielded wire, terminated with DB25 and DB9 connector via metallic frame, w/o core.

NOTE: 1. All power cords of the above support units are non shielded (1.8m).

3.5 CONFIGURATION OF SYSTEM UNDER TEST

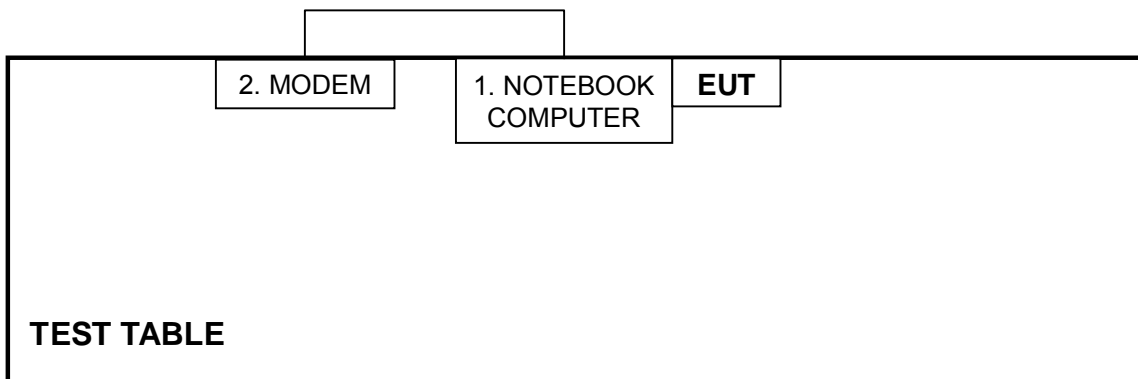

4. TEST TYPES AND RESULTS

4.1 CONDUCTED EMISSION MEASUREMENT

4.1.1 LIMITS OF CONDUCTED EMISSION MEASUREMENT

FREQUENCY OF EMISSION (MHz)	CONDUCTED LIMIT (dB μ V)	
0.15-0.5	Quasi-peak	Average
0.5-5	66 to 56	56 to 46
5-30	56	46
	60	50

- NOTE:**
1. The lower limit shall apply at the transition frequencies.
 2. The limit decreases in line with the logarithm of the frequency in the range of 0.15 to 0.50 MHz.
 3. All emanations from a class A/B digital device or system, including any network of conductors and apparatus connected thereto, shall not exceed the level of field strengths specified above.

4.1.2 TEST INSTRUMENTS

Tested Date: Mar. 29

DESCRIPTION & MANUFACTURER	MODEL NO.	SERIAL NO.	CALIBRATED DATE	CALIBRATED UNTIL
ROHDE & SCHWARZ Test Receiver	ESCS 30	100287	Mar. 01, 2010	Feb. 28, 2011
Line-Impedance Stabilization Network (for EUT)	NSLK 8127	8127-523	Sep. 23, 2009	Sep. 22, 2010
Line-Impedance Stabilization Network (for Peripheral)	ENV-216	100072	June 12, 2009	June 11, 2010
RF Cable (JYEBAO)	5DFB	COACAB-001	Dec. 14, 2009	Dec. 13, 2010
50 ohms Terminator	50	3	Oct. 28, 2009	Oct. 27, 2010
Software	BV ADT_Cond_V7.3.7	NA	NA	NA

Note:

1. The calibration interval of the above test instruments is 12 months and the calibrations are traceable to NML/ROC and NIST/USA.
2. The test was performed in Shielded Room No. A.
3. The VCCI Con A Registration No. is C-817.

4.1.3 TEST PROCEDURES

- a. The EUT was placed 0.4 meters from the conducting wall of the shielded room with EUT being connected to the power mains through a line impedance stabilization network (LISN). Other support units were connected to the power mains through another LISN. The two LISNs provide 50 ohm/ 50uH of coupling impedance for the measuring instrument.
- b. Both lines of the power mains connected to the EUT were checked for maximum conducted interference.
- c. The frequency range from 150kHz to 30MHz was searched. Emission levels under (Limit - 20dB) were not recorded.

4.1.4 DEVIATION FROM TEST STANDARD

No deviation

4.1.5 TEST SETUP

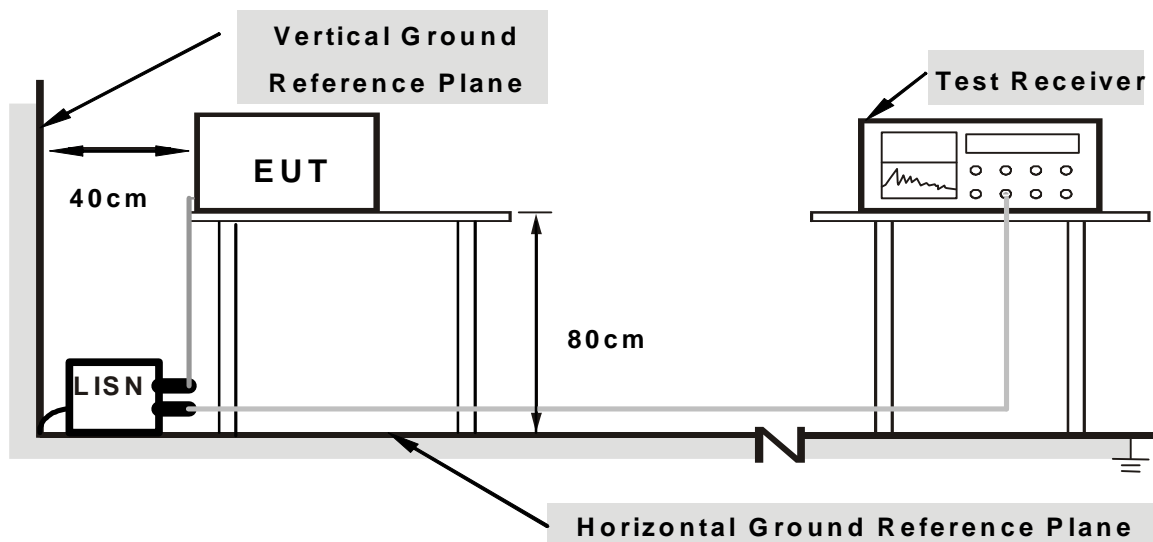

Note: 1. Support units were connected to second LISN.

2. Both of LISNs (AMN) are 80 cm from EUT and at least 80 from other units and other metal planes

For the actual test configuration, please refer to the related item – Photographs of the Test Configuration.

4.1.6 EUT OPERATING CONDITIONS

1. Connect the EUT with the support unit 1 (Notebook Computer) which is placed in control room.
2. The support unit 1 (Notebook Computer) runs test program “REALTEK 11n Single Chip 9xC USB WLAN NIC Mass production Kit” to enable EUT under transmission/receiving condition continuously at specific channel frequency.

4.1.7 TEST RESULTS

802.11n (20MHz) OFDM MODULATION:

PHASE	Line (L)	6dB BANDWIDTH	9 kHz
-------	----------	---------------	-------

No	Freq.	Corr.	Reading Value		Emission Level		Limit		Margin	
	[MHz]	Factor	[dB (uV)]		[dB (uV)]		[dB (uV)]		(dB)	
		(dB)	Q.P.	AV.	Q.P.	AV.	Q.P.	AV.	Q.P.	AV.
1	0.150	0.04	48.54	-	48.58	-	66.00	56.00	-17.42	-
2	0.178	0.04	48.50	-	48.54	-	64.59	54.59	-16.05	-
3	0.228	0.04	44.39	-	44.43	-	62.54	52.54	-18.10	-
4	0.294	0.05	37.21	-	37.26	-	60.40	50.40	-23.14	-
5	0.340	0.05	35.58	-	35.63	-	59.21	49.21	-23.58	-
6	3.551	0.18	28.05	-	28.23	-	56.00	46.00	-27.77	-

- REMARKS:**
1. Q.P. and AV. are abbreviations of quasi-peak and average individually.
 2. "-": The Quasi-peak reading value also meets average limit and measurement with the average detector is unnecessary.
 3. The emission levels of other frequencies were very low against the limit.
 4. Margin value = Emission level - Limit value
 5. Correction factor = Insertion loss + Cable loss
 6. Emission Level = Correction Factor + Reading Value.

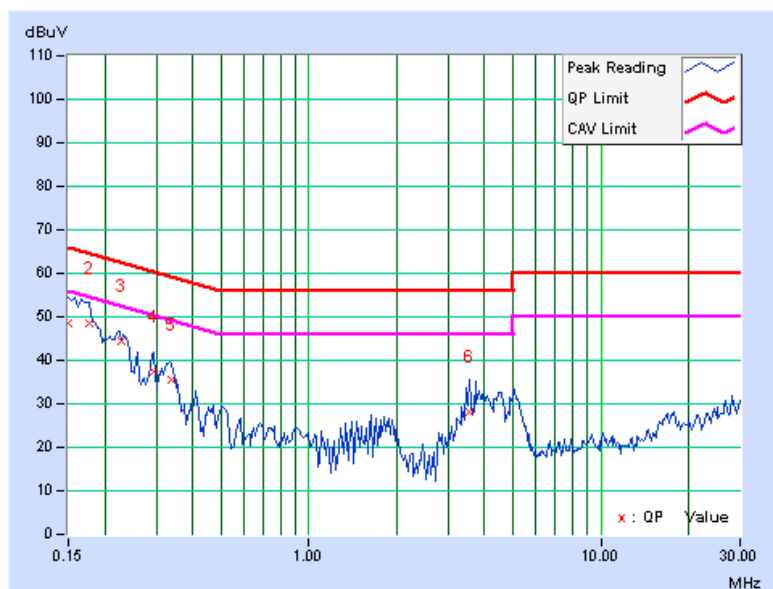



A D T

PHASE	Neutral (N)	6dB BANDWIDTH	9 kHz
--------------	-------------	----------------------	-------

No	Freq. [MHz]	Corr. Factor (dB)	Reading Value		Emission Level		Limit		Margin	
			[dB (uV)]		[dB (uV)]		[dB (uV)]		(dB)	
			Q.P.	AV.	Q.P.	AV.	Q.P.	AV.	Q.P.	AV.
1	0.150	0.05	49.12	-	49.17	-	66.00	56.00	-16.83	-
2	0.170	0.05	50.46	-	50.51	-	64.98	54.98	-14.47	-
3	0.232	0.05	45.23	-	45.28	-	62.38	52.38	-17.09	-
4	0.338	0.06	34.12	-	34.18	-	59.26	49.26	-25.08	-
5	3.605	0.20	25.82	-	26.02	-	56.00	46.00	-29.98	-
6	5.137	0.25	27.87	-	28.12	-	60.00	50.00	-31.88	-

- REMARKS:**
1. Q.P. and AV. are abbreviations of quasi-peak and average individually.
 2. "-": The Quasi-peak reading value also meets average limit and measurement with the average detector is unnecessary.
 3. The emission levels of other frequencies were very low against the limit.
 4. Margin value = Emission level - Limit value
 5. Correction factor = Insertion loss + Cable loss
 6. Emission Level = Correction Factor + Reading Value.

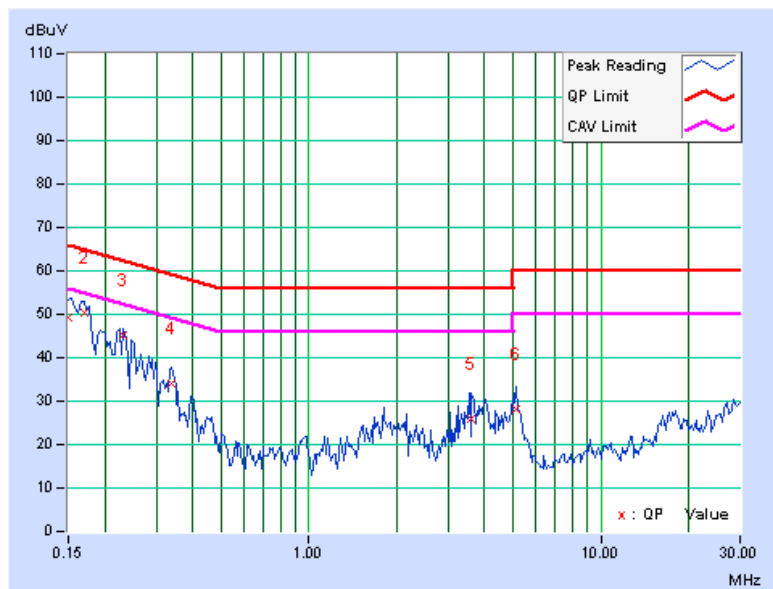

4.2 RADIATED EMISSION MEASUREMENT

4.2.1 LIMITS OF RADIATED EMISSION MEASUREMENT

Emissions radiated outside of the specified bands, shall be according to the general radiated limits in 15.209 as following:

Frequencies (MHz)	Field strength (microvolts/meter)	Measurement distance (meters)
0.009-0.490	2400/F(kHz)	300
0.490-1.705	24000/F(kHz)	30
1.705-30.0	30	30
30-88	100	3
88-216	150	3
216-960	200	3
Above 960	500	3

NOTE:

1. The lower limit shall apply at the transition frequencies.
2. Emission level (dBuV/m) = 20 log Emission level (uV/m).
3. As shown in 15.35(b), for frequencies above 1000MHz, the field strength limits are based on average detector, however, the peak field strength of any emission shall not exceed the maximum permitted average limits, specified above by more than 20dB under any condition of modulation.



A D T

4.2.2 TEST INSTRUMENTS

Tested Date: July 06 to 16

DESCRIPTION & MANUFACTURER	MODEL NO.	SERIAL NO.	CALIBRATED DATE	CALIBRATED UNTIL
ROHDE & SCHWARZ Spectrum Analyzer	FSP40	100036	Dec. 18, 2009	Dec. 17, 2010
Agilent PSA Spectrum Analyzer	E4446A	MY46180622	May 12 , 2010	May 11, 2011
HP Pre_Amplifier	8449B	300801923	Nov. 02, 2009	Nov. 01, 2010
ROHDE & SCHWARZ Test Receiver	ESCS30	847124/029	Aug. 28, 2009	Aug. 27, 2010
SCHWARZBECK TRILOG Broadband Antenna	VULB 9168	138	Apr. 28, 2010	Apr. 27, 2011
Schwarzbeck Horn_Antenna	BBHA9120	D124	Dec. 18, 2009	Dec. 17, 2010
Schwarzbeck Horn_Antenna	BBHA 9170	BBHA9170153	Jan. 22, 2010	Jan. 21, 2011
RF Switches	EMH-011	1001	NA	NA
RF CABLE (Chaintek)	Sucoflex 106	28077	Aug. 14, 2009	Aug. 13, 2010
RF Cable	8DFB	STCCAB-30M-1GHz	NA	NA
Software	ADT_Radiated_V7.6.15.9.2	NA	NA	NA
CT Antenna Tower & Turn Table	NA	NA	NA	NA

- Note: 1. The calibration interval of the above test instruments is 12 months and the calibrations are traceable to NML/ROC and NIST/USA.
2. The horn antenna, preamplifier (model: 8449B) and Spectrum Analyzer (model: FSP40) are used only for the measurement of emission frequency above 1GHz if tested.
3. The test was performed in Open Site No. C.
4. The FCC Site Registration No. is 656396.
5. The VCCI Site Registration No. is R-1626.
6. The CANADA Site Registration No. is IC 7450G-3.

4.2.3 TEST PROCEDURES

- a. The EUT was placed on the top of a rotating table 0.8 meters above the ground at 3 meters chamber room. The table was rotated 360 degrees to determine the position of the highest radiation.
- b. The EUT was set 3 meters away from the interference-receiving antenna, which was mounted on the top of a variable-height antenna tower.
- c. The antenna is a broadband antenna, and its height is varied from one meter to four meters above the ground to determine the maximum value of the field strength. Both horizontal and vertical polarizations of the antenna are set to make the measurement.
- d. For each suspected emission, the EUT was arranged to its worst case and then the antenna was tuned to heights from 1 meter to 4 meters and the rotatable table was turned from 0 degrees to 360 degrees to find the maximum reading.
- e. The test-receiver system was set to quasi-peak detect function and specified bandwidth with maximum hold mode when the test frequency is below 1 GHz.
- f. The test-receiver system was set to peak and average detect function and specified bandwidth with maximum hold mode when the test frequency is above 1 GHz. If the peak reading value also meets average limit, measurement with the average detector is unnecessary.

NOTE:

1. The resolution bandwidth and video bandwidth of test receiver/spectrum analyzer is 120kHz for Peak detection (PK) and Quasi-peak detection (QP) at frequency below 1GHz.
2. The resolution bandwidth of test receiver/spectrum analyzer is 1 MHz and video bandwidth is 3MHz for Peak detection at frequency above 1GHz.
3. The resolution bandwidth of test receiver/spectrum analyzer is 1MHz and the video bandwidth is 10Hz for Average detection (AV) at frequency above 1GHz.

4.2.4 DEVIATION FROM TEST STANDARD

No deviation

4.2.5 TEST SETUP

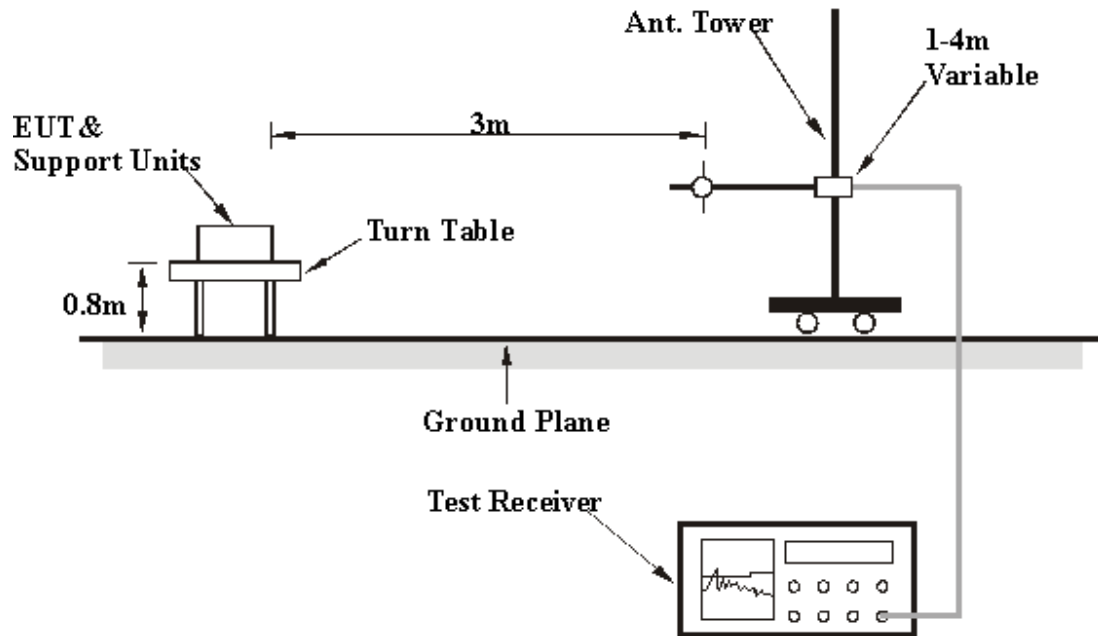

For the actual test configuration, please refer to the related item – Photographs of the Test Configuration.

4.2.6 EUT OPERATING CONDITIONS

Same as 4.1.6.



A D T

4.2.7 TEST RESULTS

BELOW 1GHz WORST-CASE DATA : 802.11n (20MHz) OFDM MODULATION

EUT TEST CONDITION		MEASUREMENT DETAIL	
CHANNEL	Channel 6	FREQUENCY RANGE	Below 1000MHz
INPUT POWER (SYSTEM)	120Vac, 60Hz	DETECTOR FUNCTION	Quasi-Peak
ENVIRONMENTAL CONDITIONS	32deg. C, 63%RH 1012 hPa	TESTED BY	Wen Yu

ANTENNA POLARITY & TEST DISTANCE: HORIZONTAL AT 3 M								
NO.	FREQ. (MHz)	EMISSION LEVEL (dBuV/m)	LIMIT (dBuV/m)	MARGIN (dB)	ANTENNA HEIGHT (m)	TABLE ANGLE (Degree)	RAW VALUE (dBuV)	CORRECTION FACTOR (dB/m)
1	192.00	32.5 QP	43.5	-11.0	1.23 H	251	21.23	11.27
2	288.00	32.9 QP	46.0	-13.1	1.24 H	165	17.74	15.16
3	384.00	38.1 QP	46.0	-7.9	1.36 H	121	20.33	17.77
4	480.00	26.3 QP	46.0	-19.7	1.24 H	15	6.07	20.23
5	528.00	34.0 QP	46.0	-12.0	1.25 H	126	12.53	21.47
6	624.00	38.2 QP	46.0	-7.8	1.55 H	121	14.62	23.58

ANTENNA POLARITY & TEST DISTANCE: VERTICAL AT 3 M								
NO.	FREQ. (MHz)	EMISSION LEVEL (dBuV/m)	LIMIT (dBuV/m)	MARGIN (dB)	ANTENNA HEIGHT (m)	TABLE ANGLE (Degree)	RAW VALUE (dBuV)	CORRECTION FACTOR (dB/m)
1	192.00	32.5 QP	43.5	-11.0	1.00 V	251	21.23	11.27
2	240.00	35.2 QP	46.0	-10.8	1.02 V	32	22.15	13.05
3	384.00	34.3 QP	46.0	-11.7	1.24 V	154	16.53	17.77
4	480.00	32.6 QP	46.0	-13.4	1.21 V	154	12.37	20.23
5	720.00	37.3 QP	46.0	-8.7	1.34 V	12	12.54	24.76
6	864.00	32.6 QP	46.0	-13.4	1.20 V	14	5.93	26.67

- REMARKS:**
1. Emission level (dBuV/m) = Raw Value (dBuV) + Correction Factor (dB/m).
 2. Correction Factor (dB/m) = Antenna Factor (dB/m) + Cable Factor (dB).
 3. The other emission levels were very low against the limit.
 4. Margin value = Emission level – Limit value.



A D T

ABOVE 1GHz WORST-CASE DATA

802.11b DSSS MODULATION

EUT TEST CONDITION		MEASUREMENT DETAIL	
CHANNEL	Channel 1	FREQUENCY RANGE	1 ~ 25GHz
INPUT POWER (SYSTEM)	120Vac, 60Hz	DETECTOR FUNCTION	Peak (PK) Average (AV)
ENVIRONMENTAL CONDITIONS	27deg. C, 56%RH 1012 hPa	TESTED BY	Phoenix Huang

ANTENNA POLARITY & TEST DISTANCE: HORIZONTAL AT 3 M

NO.	FREQ. (MHz)	EMISSION LEVEL (dBuV/m)	LIMIT (dBuV/m)	MARGIN (dB)	ANTENNA HEIGHT (m)	TABLE ANGLE (Degree)	RAW VALUE (dBuV)	CORRECTION FACTOR (dB/m)
1	2386.27	54.6 PK	74.0	-19.4	1.46 H	7	24.55	30.05
2	2386.27	43.6 AV	54.0	-10.4	1.46 H	7	13.55	30.05
3	*2412.00	101.8 PK			1.48 H	338	71.65	30.15
4	*2412.00	99.2 AV			1.48 H	338	69.05	30.15
5	4824.00	50.7 PK	74.0	-23.3	1.16 H	176	15.27	35.43
6	4824.00	47.4 AV	54.0	-6.6	1.16 H	176	11.97	35.43

ANTENNA POLARITY & TEST DISTANCE: VERTICAL AT 3 M

NO.	FREQ. (MHz)	EMISSION LEVEL (dBuV/m)	LIMIT (dBuV/m)	MARGIN (dB)	ANTENNA HEIGHT (m)	TABLE ANGLE (Degree)	RAW VALUE (dBuV)	CORRECTION FACTOR (dB/m)
1	2386.13	55.1 PK	74.0	-18.9	1.08 V	269	25.05	30.05
2	2386.13	44.1 AV	54.0	-9.9	1.08 V	269	14.05	30.05
3	*2412.00	102.5 PK			1.09 V	155	72.35	30.15
4	*2412.00	100.1 AV			1.09 V	155	69.95	30.15
5	4824.00	54.1 PK	74.0	-19.9	1.27 V	89	18.67	35.43
6	4824.00	52.1 AV	54.0	-1.9	1.27 V	89	16.67	35.43

- REMARKS:**
1. Emission level (dBuV/m) = Raw Value (dBuV) + Correction Factor (dB/m).
 2. Correction Factor (dB/m) = Antenna Factor (dB/m) + Cable Factor (dB).
 3. The other emission levels were very low against the limit.
 4. Margin value = Emission level – Limit value.
 5. “ * “: Fundamental frequency.



A D T

EUT TEST CONDITION		MEASUREMENT DETAIL	
CHANNEL	Channel 6	FREQUENCY RANGE	1 ~ 25GHz
INPUT POWER (SYSTEM)	120Vac, 60Hz	DETECTOR FUNCTION	Peak (PK) Average (AV)
ENVIRONMENTAL CONDITIONS	30deg. C, 80%RH 1012 hPa	TESTED BY	Wen Yu

ANTENNA POLARITY & TEST DISTANCE: HORIZONTAL AT 3 M								
NO.	FREQ. (MHz)	EMISSION LEVEL (dBuV/m)	LIMIT (dBuV/m)	MARGIN (dB)	ANTENNA HEIGHT (m)	TABLE ANGLE (Degree)	RAW VALUE (dBuV)	CORRECTION FACTOR (dB/m)
1	*2437.00	99.4 PK			1.33 H	345	69.16	30.24
2	*2437.00	97.0 AV			1.33 H	345	66.76	30.24
3	4874.00	45.8 PK	74.0	-28.2	1.40 H	6	10.28	35.52
4	4874.00	39.7 AV	54.0	-14.3	1.40 H	6	4.18	35.52
5	7311.00	58.1 PK	74.0	-15.9	1.47 H	220	16.14	41.96
6	7311.00	53.1 AV	54.0	-0.9	1.47 H	220	11.14	41.96
ANTENNA POLARITY & TEST DISTANCE: VERTICAL AT 3 M								
NO.	FREQ. (MHz)	EMISSION LEVEL (dBuV/m)	LIMIT (dBuV/m)	MARGIN (dB)	ANTENNA HEIGHT (m)	TABLE ANGLE (Degree)	RAW VALUE (dBuV)	CORRECTION FACTOR (dB/m)
1	*2437.00	100.2 PK			1.06 V	156	69.96	30.24
2	*2437.00	97.7 AV			1.06 V	156	67.46	30.24
3	4874.00	49.6 PK	74.0	-24.4	1.44 V	79	14.08	35.52
4	4874.00	45.7 AV	54.0	-8.3	1.44 V	79	10.18	35.52
5	7311.00	57.7 PK	74.0	-16.3	1.35 V	164	15.74	41.96
6	7311.00	53.2 AV	54.0	-0.8	1.35 V	164	11.24	41.96

- REMARKS:**
1. Emission level (dBuV/m) = Raw Value (dBuV) + Correction Factor (dB/m).
 2. Correction Factor (dB/m) = Antenna Factor (dB/m) + Cable Factor (dB).
 3. The other emission levels were very low against the limit.
 4. Margin value = Emission level – Limit value.
 5. “ * “: Fundamental frequency.



A D T

EUT TEST CONDITION		MEASUREMENT DETAIL	
CHANNEL	Channel 11	FREQUENCY RANGE	1 ~ 25GHz
INPUT POWER (SYSTEM)	120Vac, 60Hz	DETECTOR FUNCTION	Peak (PK) Average (AV)
ENVIRONMENTAL CONDITIONS	30deg. C, 80%RH 1012 hPa	TESTED BY	Wen Yu

ANTENNA POLARITY & TEST DISTANCE: HORIZONTAL AT 3 M

NO.	FREQ. (MHz)	EMISSION LEVEL (dBuV/m)	LIMIT (dBuV/m)	MARGIN (dB)	ANTENNA HEIGHT (m)	TABLE ANGLE (Degree)	RAW VALUE (dBuV)	CORRECTION FACTOR (dB/m)
1	*2462.00	99.2 PK			1.33 H	14	68.86	30.34
2	*2462.00	96.5 AV			1.33 H	14	66.16	30.34
3	2483.50	54.2 PK	74.0	-19.8	1.33 H	14	23.77	30.43
4	2483.50	41.8 AV	54.0	-12.2	1.33 H	14	11.37	30.43
5	4924.00	45.8 PK	74.0	-28.2	1.35 H	5	10.18	35.62
6	4924.00	40.3 AV	54.0	-13.7	1.35 H	5	4.68	35.62
7	7386.00	58.0 PK	74.0	-16.0	1.70 H	220	15.90	42.10
8	7386.00	52.4 AV	54.0	-1.6	1.70 H	220	10.30	42.10

ANTENNA POLARITY & TEST DISTANCE: VERTICAL AT 3 M

NO.	FREQ. (MHz)	EMISSION LEVEL (dBuV/m)	LIMIT (dBuV/m)	MARGIN (dB)	ANTENNA HEIGHT (m)	TABLE ANGLE (Degree)	RAW VALUE (dBuV)	CORRECTION FACTOR (dB/m)
1	*2462.00	99.3 PK			1.35 V	8	68.96	30.34
2	*2462.00	96.5 AV			1.35 V	8	66.16	30.34
3	2483.50	54.8 PK	74.0	-19.2	1.35 V	10	24.37	30.43
4	2483.50	41.7 AV	54.0	-12.3	1.35 V	10	11.27	30.43
5	4924.00	49.9 PK	74.0	-24.1	1.07 V	316	14.28	35.62
6	4924.00	45.8 AV	54.0	-8.2	1.07 V	316	10.18	35.62
7	7386.00	57.7 PK	74.0	-16.3	1.23 V	161	15.60	42.10
8	7386.00	52.9 AV	54.0	-1.1	1.23 V	161	10.80	42.10

- REMARKS:**
1. Emission level (dBuV/m) = Raw Value (dBuV) + Correction Factor (dB/m).
 2. Correction Factor (dB/m) = Antenna Factor (dB/m) + Cable Factor (dB).
 3. The other emission levels were very low against the limit.
 4. Margin value = Emission level – Limit value.
 5. “ * “: Fundamental frequency.

RESTRICTED BANDEDGE (802.11b MODE, CH1, HORIZONTAL)

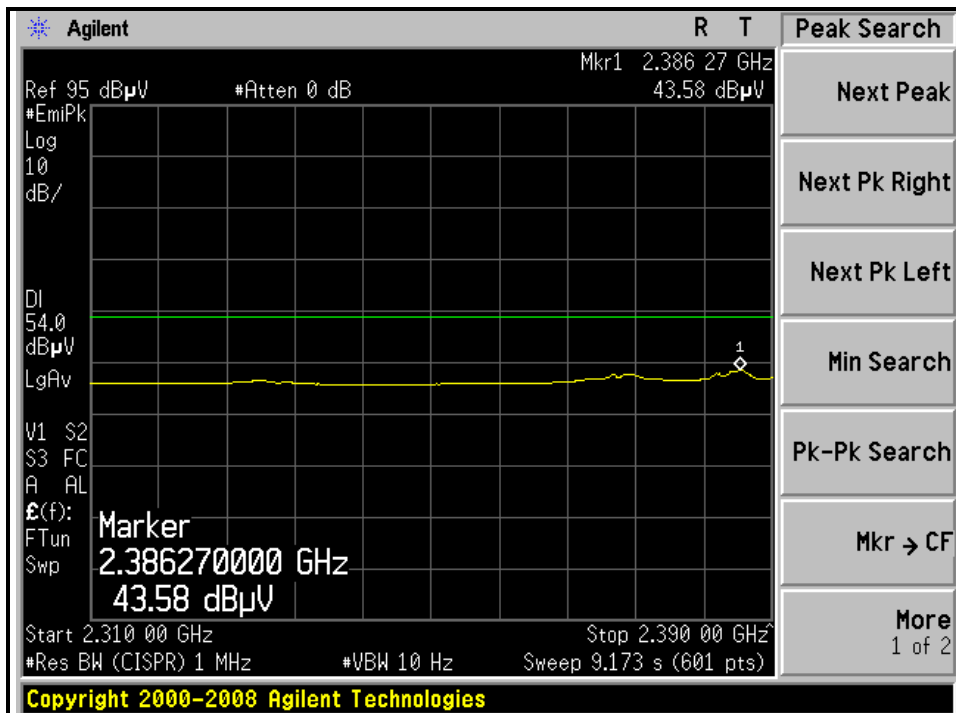
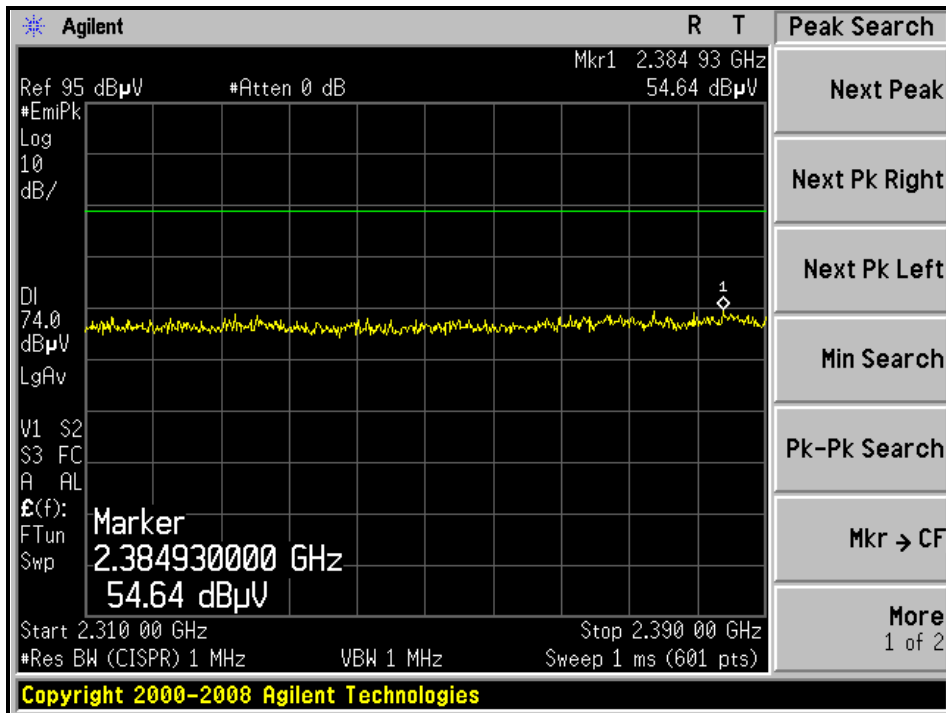



A D T

RESTRICTED BANDEDGE (802.11b MODE, CH1, VERTICAL)

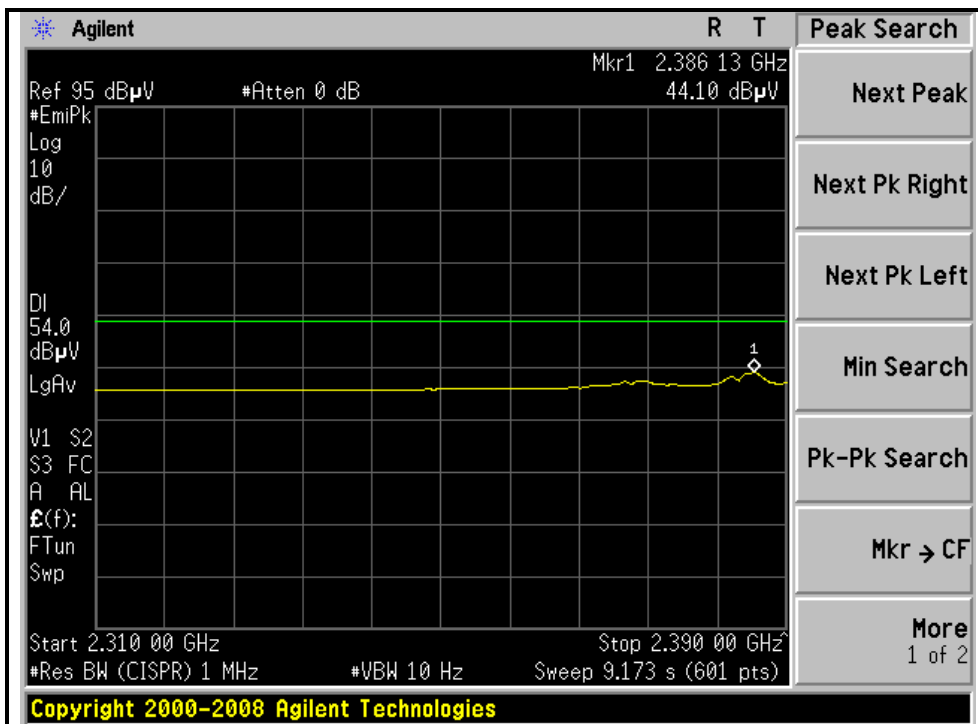
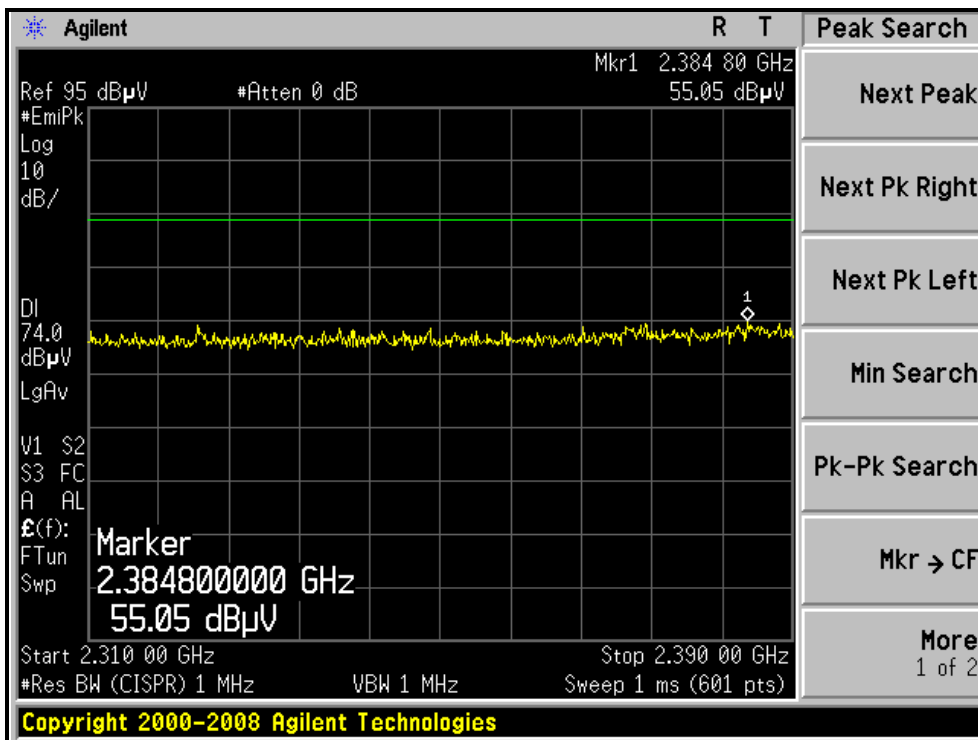



A D T

RESTRICTED BANDEDGE (802.11b MODE, CH11, HORIZONTAL)

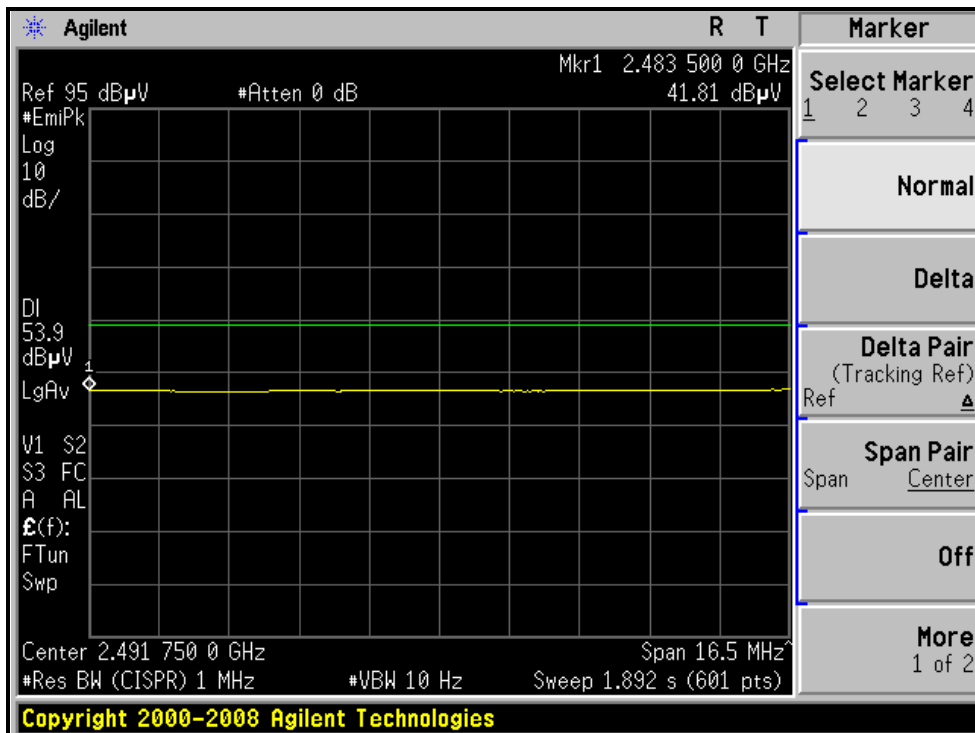
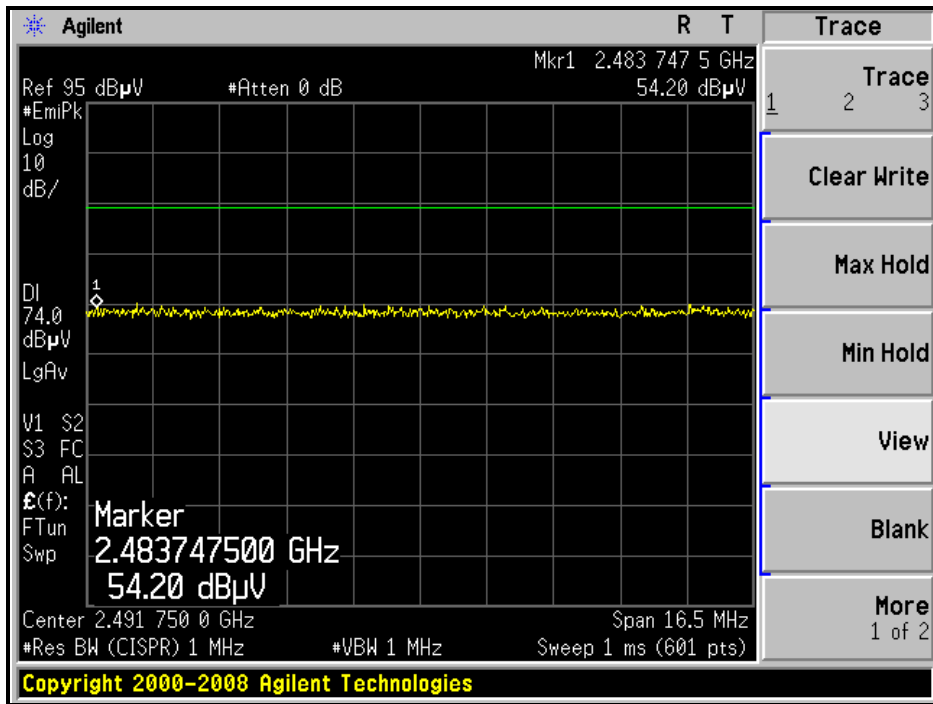



A D T

RESTRICTED BANDEDGE (802.11b MODE, CH11, VERTICAL)

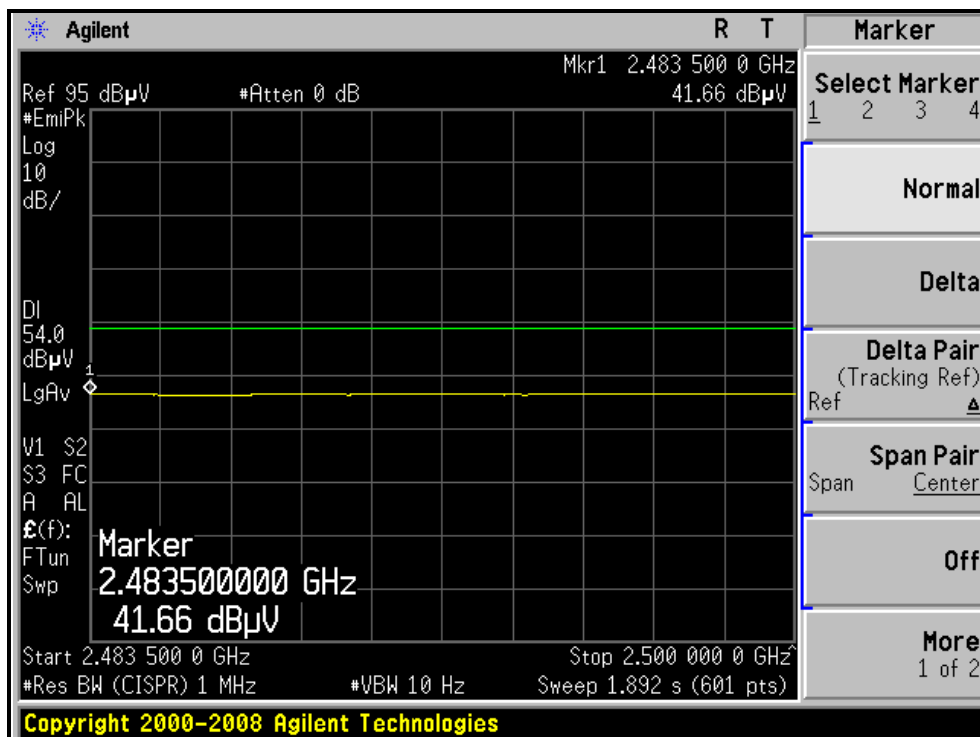
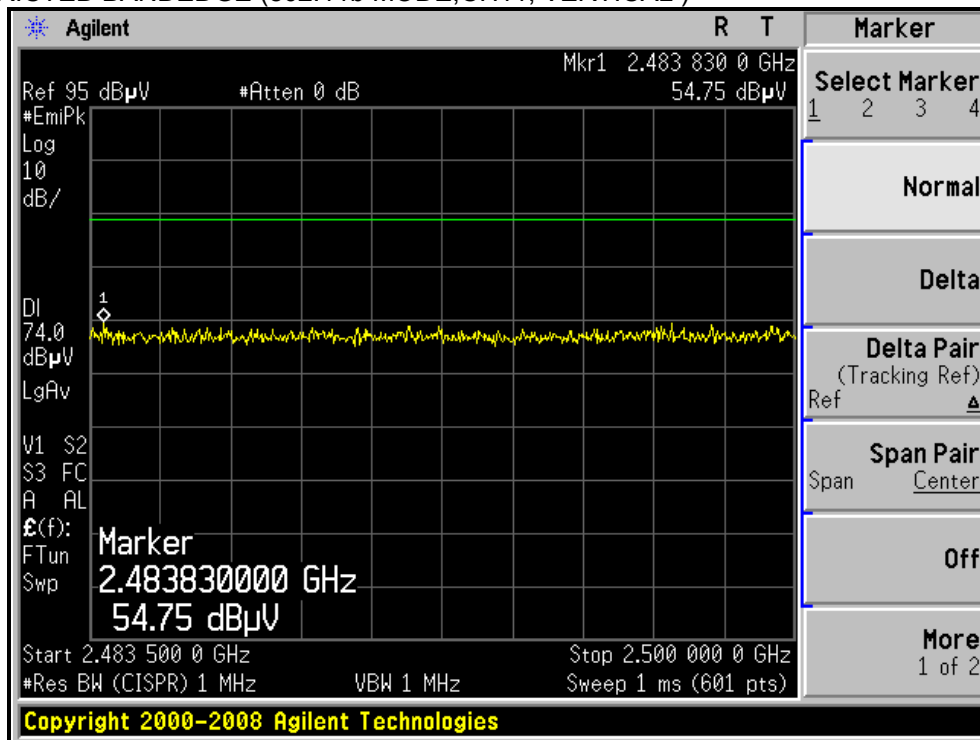



A D T

802.11g OFDM MODULATION

EUT TEST CONDITION		MEASUREMENT DETAIL	
CHANNEL	Channel 1	FREQUENCY RANGE	1 ~ 25GHz
INPUT POWER (SYSTEM)	120Vac, 60Hz	DETECTOR FUNCTION	Peak (PK) Average (AV)
ENVIRONMENTAL CONDITIONS	30deg. C, 80%RH 1012 hPa	TESTED BY	Wen Yu

ANTENNA POLARITY & TEST DISTANCE: HORIZONTAL AT 3 M

NO.	FREQ. (MHz)	EMISSION LEVEL (dBuV/m)	LIMIT (dBuV/m)	MARGIN (dB)	ANTENNA HEIGHT (m)	TABLE ANGLE (Degree)	RAW VALUE (dBuV)	CORRECTION FACTOR (dB/m)
1	2390.00	66.5 PK	74.0	-7.5	1.45 H	4	36.44	30.06
2	2390.00	50.0 AV	54.0	-4.0	1.45 H	4	19.94	30.06
3	*2412.00	104.2 PK			1.36 H	351	74.05	30.15
4	*2412.00	95.0 AV			1.36 H	351	64.85	30.15
5	4824.00	48.7 PK	74.0	-25.3	1.46 H	6	13.27	35.43
6	4824.00	35.4 AV	54.0	-18.6	1.46 H	6	-0.03	35.43

ANTENNA POLARITY & TEST DISTANCE: VERTICAL AT 3 M

NO.	FREQ. (MHz)	EMISSION LEVEL (dBuV/m)	LIMIT (dBuV/m)	MARGIN (dB)	ANTENNA HEIGHT (m)	TABLE ANGLE (Degree)	RAW VALUE (dBuV)	CORRECTION FACTOR (dB/m)
1	2390.00	71.2 PK	74.0	-2.8	1.21 V	99	41.14	30.06
2	2390.00	53.2 AV	54.0	-0.8	1.21 V	99	23.14	30.06
3	*2412.00	105.6 PK			1.21 V	97	75.45	30.15
4	*2412.00	96.4 AV			1.21 V	97	66.25	30.15
5	4824.00	51.5 PK	74.0	-22.5	1.23 V	89	16.07	35.43
6	4824.00	39.7 AV	54.0	-14.3	1.23 V	89	4.27	35.43

- REMARKS:**
1. Emission level (dBuV/m) = Raw Value (dBuV) + Correction Factor (dB/m).
 2. Correction Factor (dB/m) = Antenna Factor (dB/m) + Cable Factor (dB).
 3. The other emission levels were very low against the limit.
 4. Margin value = Emission level – Limit value.
 5. “ * “: Fundamental frequency.



A D T

EUT TEST CONDITION		MEASUREMENT DETAIL	
CHANNEL	Channel 6	FREQUENCY RANGE	1 ~ 25GHz
INPUT POWER (SYSTEM)	120Vac, 60Hz	DETECTOR FUNCTION	Peak (PK) Average (AV)
ENVIRONMENTAL CONDITIONS	30deg. C, 80%RH 1012 hPa	TESTED BY	Wen Yu

ANTENNA POLARITY & TEST DISTANCE: HORIZONTAL AT 3 M								
NO.	FREQ. (MHz)	EMISSION LEVEL (dBuV/m)	LIMIT (dBuV/m)	MARGIN (dB)	ANTENNA HEIGHT (m)	TABLE ANGLE (Degree)	RAW VALUE (dBuV)	CORRECTION FACTOR (dB/m)
1	*2437.00	102.5 PK			1.31 H	348	72.26	30.24
2	*2437.00	93.6 AV			1.31 H	348	63.36	30.24
3	4874.00	43.6 PK	74.0	-30.4	1.41 H	8	8.08	35.52
4	4874.00	31.4 AV	54.0	-22.6	1.41 H	8	-4.12	35.52
5	7311.00	63.0 PK	74.0	-11.0	1.70 H	221	21.04	41.96
6	7311.00	49.1 AV	54.0	-4.9	1.70 H	221	7.14	41.96
ANTENNA POLARITY & TEST DISTANCE: VERTICAL AT 3 M								
NO.	FREQ. (MHz)	EMISSION LEVEL (dBuV/m)	LIMIT (dBuV/m)	MARGIN (dB)	ANTENNA HEIGHT (m)	TABLE ANGLE (Degree)	RAW VALUE (dBuV)	CORRECTION FACTOR (dB/m)
1	*2437.00	103.6 PK			1.08 V	155	73.36	30.24
2	*2437.00	94.8 AV			1.08 V	155	64.56	30.24
3	4874.00	45.2 PK	74.0	-28.8	1.39 V	98	9.68	35.52
4	4874.00	32.8 AV	54.0	-21.2	1.39 V	98	-2.72	35.52
5	7311.00	66.8 PK	74.0	-7.2	1.35 V	164	24.84	41.96
6	7311.00	53.2 AV	54.0	-0.8	1.35 V	164	11.24	41.96

- REMARKS:**
1. Emission level (dBuV/m) = Raw Value (dBuV) + Correction Factor (dB/m).
 2. Correction Factor (dB/m) = Antenna Factor (dB/m) + Cable Factor (dB).
 3. The other emission levels were very low against the limit.
 4. Margin value = Emission level – Limit value.
 5. “ * “: Fundamental frequency.



A D T

EUT TEST CONDITION		MEASUREMENT DETAIL	
CHANNEL	Channel 11	FREQUENCY RANGE	1 ~ 25GHz
INPUT POWER (SYSTEM)	120Vac, 60Hz	DETECTOR FUNCTION	Peak (PK) Average (AV)
ENVIRONMENTAL CONDITIONS	30deg. C, 80%RH 1012 hPa	TESTED BY	Wen Yu

ANTENNA POLARITY & TEST DISTANCE: HORIZONTAL AT 3 M

NO.	FREQ. (MHz)	EMISSION LEVEL (dBuV/m)	LIMIT (dBuV/m)	MARGIN (dB)	ANTENNA HEIGHT (m)	TABLE ANGLE (Degree)	RAW VALUE (dBuV)	CORRECTION FACTOR (dB/m)
1	*2462.00	102.3 PK			1.33 H	345	71.96	30.34
2	*2462.00	93.2 AV			1.33 H	345	62.86	30.34
3	2483.50	66.7 PK	74.0	-7.3	1.33 H	15	36.27	30.43
4	2483.50	50.9 AV	54.0	-3.1	1.33 H	15	20.47	30.43
5	4924.00	42.9 PK	74.0	-31.1	1.36 H	6	7.28	35.62
6	4924.00	34.1 AV	54.0	-19.9	1.36 H	6	-1.52	35.62
7	7386.00	65.5 PK	74.0	-8.5	1.42 H	220	23.40	42.10
8	7386.00	51.7 AV	54.0	-2.3	1.42 H	220	9.60	42.10

ANTENNA POLARITY & TEST DISTANCE: VERTICAL AT 3 M

NO.	FREQ. (MHz)	EMISSION LEVEL (dBuV/m)	LIMIT (dBuV/m)	MARGIN (dB)	ANTENNA HEIGHT (m)	TABLE ANGLE (Degree)	RAW VALUE (dBuV)	CORRECTION FACTOR (dB/m)
1	*2462.00	103.2 PK			1.20 V	90	72.86	30.34
2	*2462.00	94.3 AV			1.20 V	90	63.96	30.34
3	2483.50	68.4 PK	74.0	-5.6	1.15 V	89	37.97	30.43
4	2483.50	53.4 AV	54.0	-0.6	1.15 V	89	22.97	30.43
5	4924.00	54.2 PK	74.0	-19.8	1.40 V	107	18.58	35.62
6	4924.00	41.3 AV	54.0	-12.7	1.40 V	107	5.68	35.62
7	7386.00	65.9 PK	74.0	-8.1	1.30 V	157	23.80	42.10
8	7386.00	53.2 AV	54.0	-0.8	1.30 V	157	11.10	42.10

- REMARKS:**
1. Emission level (dBuV/m) = Raw Value (dBuV) + Correction Factor (dB/m).
 2. Correction Factor (dB/m) = Antenna Factor (dB/m) + Cable Factor (dB).
 3. The other emission levels were very low against the limit.
 4. Margin value = Emission level – Limit value.
 5. “ * “: Fundamental frequency.



A D T

RESTRICTED BANDEDGE (802.11g MODE, CH1, HORIZONTAL)

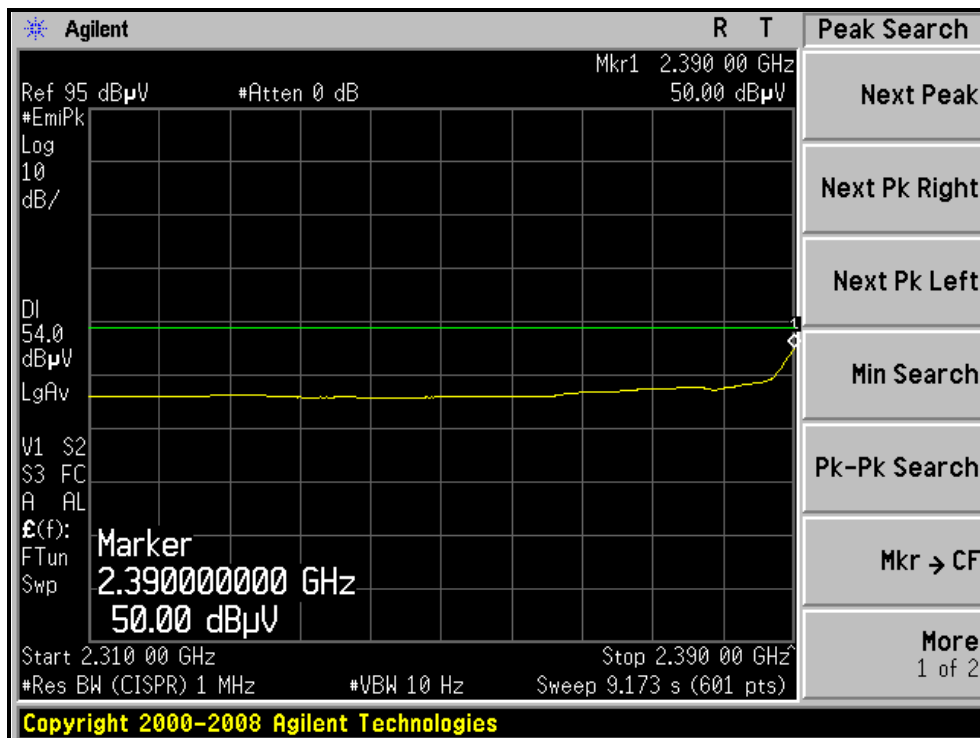
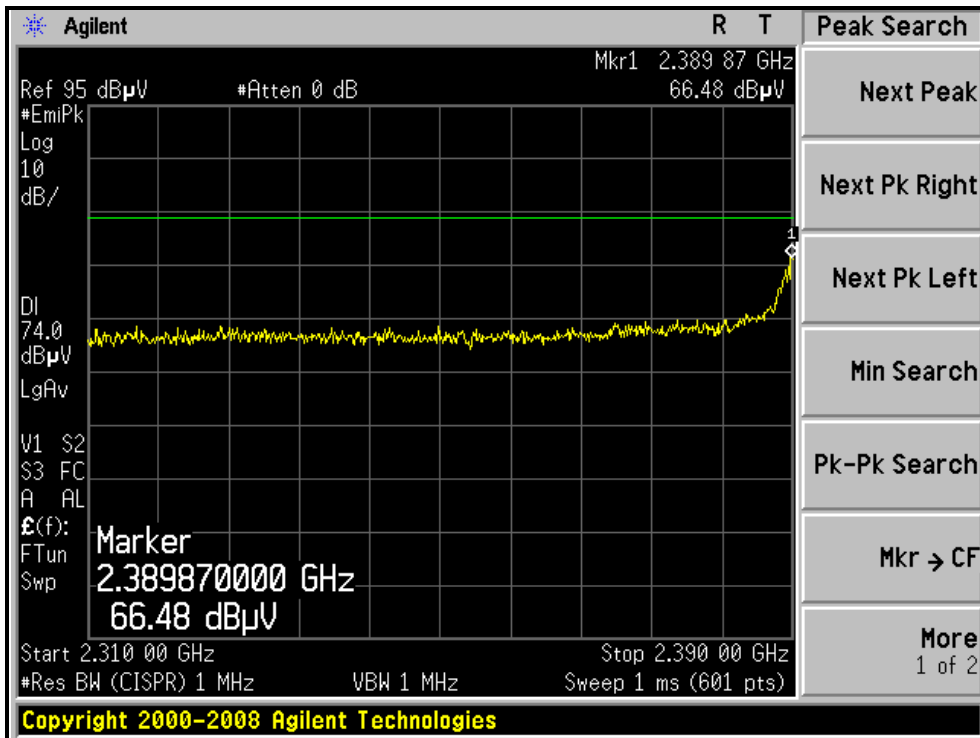



A D T

RESTRICTED BANDEDGE (802.11g MODE, CH1, VERTICAL)

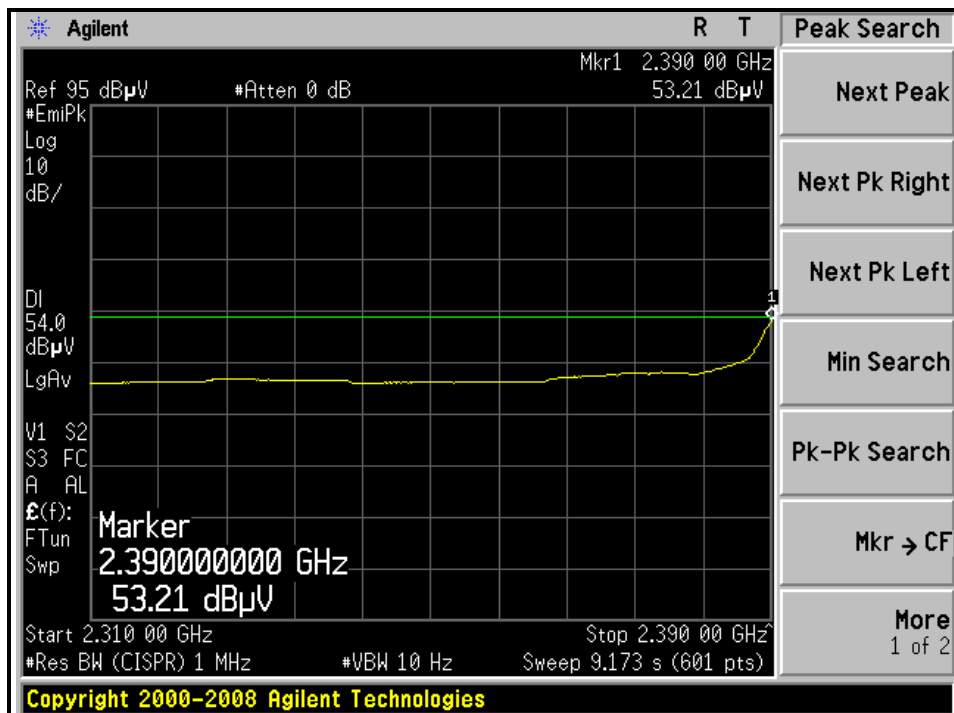
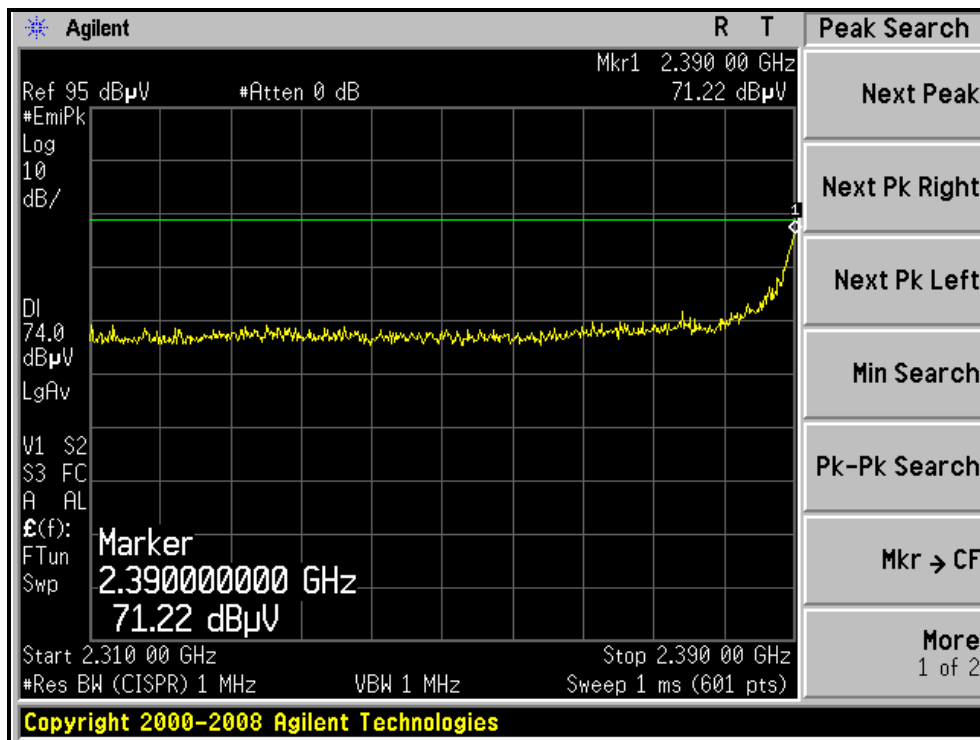



A D T

RESTRICTED BANDEDGE (802.11g MODE, CH11, HORIZONTAL)

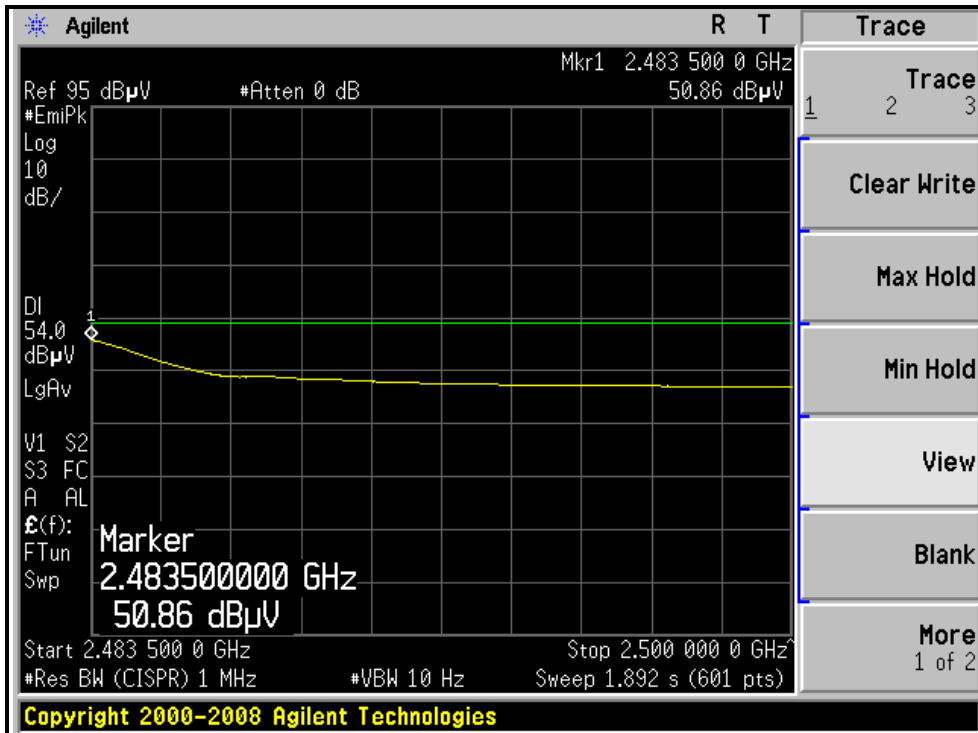
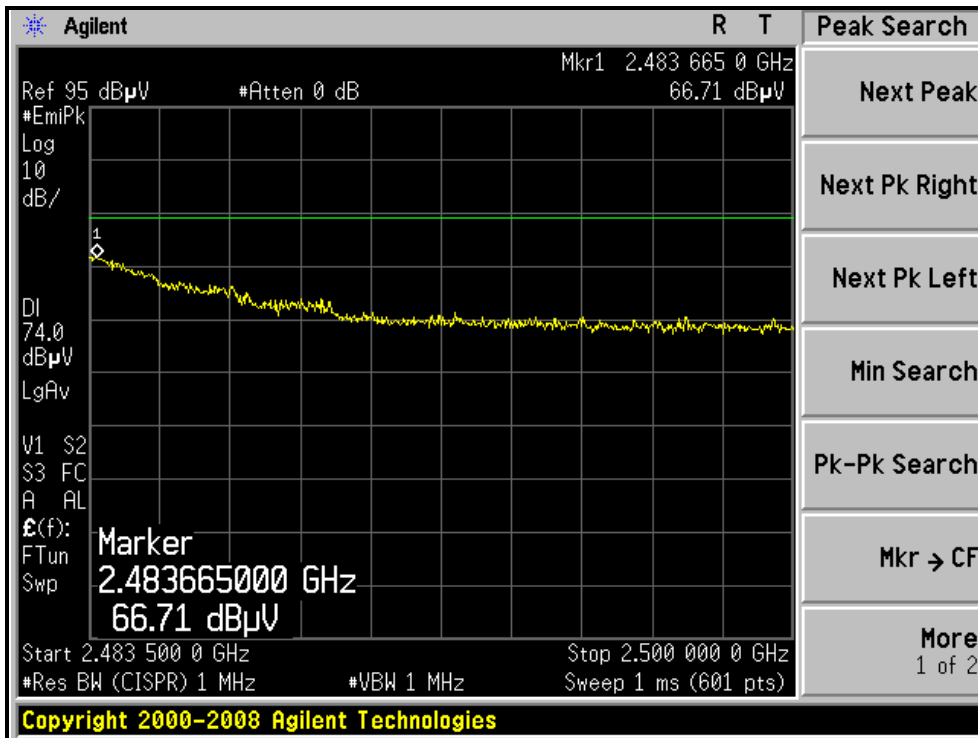



A D T

RESTRICTED BANDEDGE (802.11g MODE, CH11, VERTICAL)

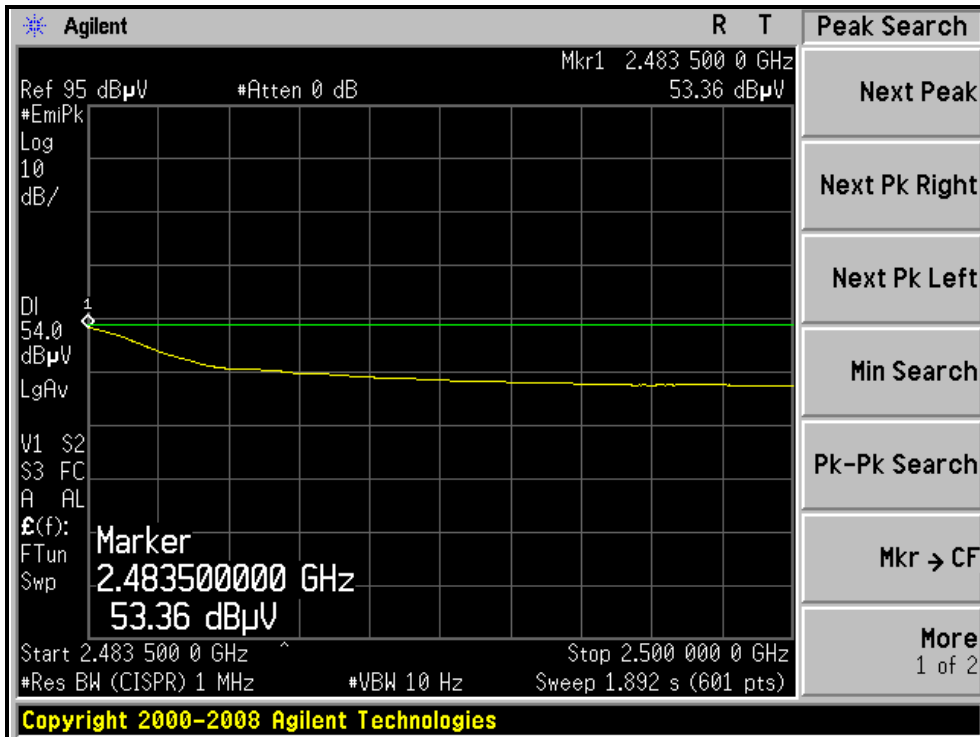
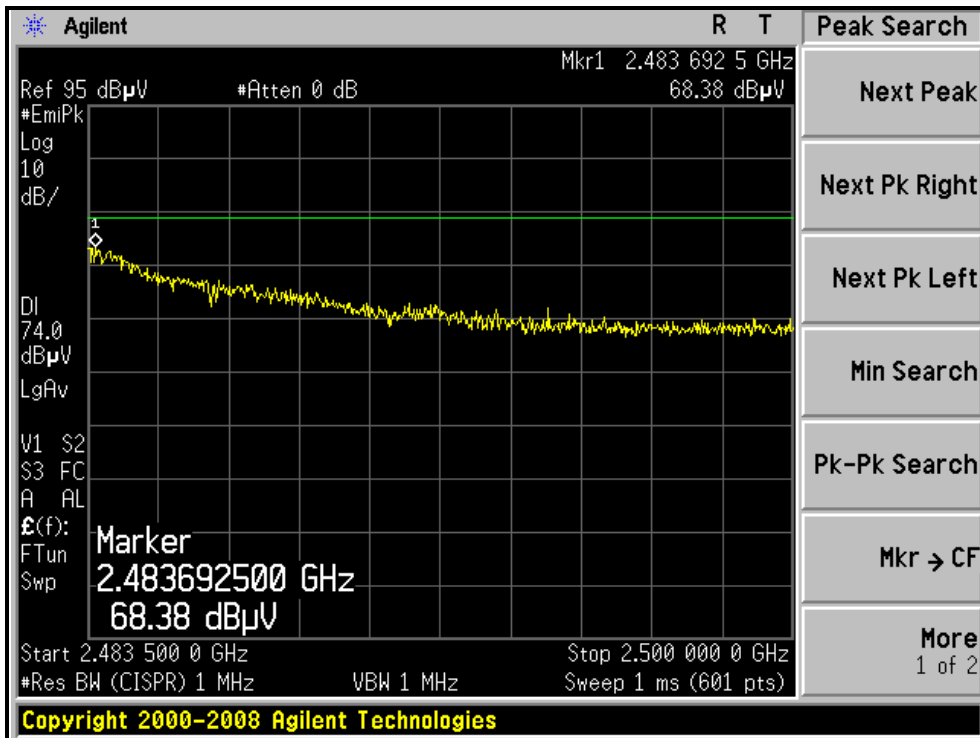



A D T

802.11n (20MHz) OFDM MODULATION

EUT TEST CONDITION		MEASUREMENT DETAIL	
CHANNEL	Channel 1	FREQUENCY RANGE	1 ~ 25GHz
INPUT POWER (SYSTEM)	120Vac, 60Hz	DETECTOR FUNCTION	Peak (PK) Average (AV)
ENVIRONMENTAL CONDITIONS	30deg. C, 80%RH 1012 hPa	TESTED BY	Wen Yu

ANTENNA POLARITY & TEST DISTANCE: HORIZONTAL AT 3 M								
NO.	FREQ. (MHz)	EMISSION LEVEL (dBuV/m)	LIMIT (dBuV/m)	MARGIN (dB)	ANTENNA HEIGHT (m)	TABLE ANGLE (Degree)	RAW VALUE (dBuV)	CORRECTION FACTOR (dB/m)
1	2390.00	64.4 PK	74.0	-9.6	1.31 H	201	34.34	30.06
2	2390.00	49.9 AV	54.0	-4.1	1.31 H	201	19.84	30.06
3	*2412.00	104.7 PK			1.31 H	202	74.55	30.15
4	*2412.00	94.1 AV			1.31 H	202	63.95	30.15
5	4824.00	49.5 PK	74.0	-24.5	1.60 H	6	14.07	35.43
6	4824.00	36.9 AV	54.0	-17.1	1.60 H	6	1.47	35.43
ANTENNA POLARITY & TEST DISTANCE: VERTICAL AT 3 M								
NO.	FREQ. (MHz)	EMISSION LEVEL (dBuV/m)	LIMIT (dBuV/m)	MARGIN (dB)	ANTENNA HEIGHT (m)	TABLE ANGLE (Degree)	RAW VALUE (dBuV)	CORRECTION FACTOR (dB/m)
1	2390.00	67.0 PK	74.0	-7.0	1.10 V	154	36.94	30.06
2	2390.00	52.6 AV	54.0	-1.4	1.10 V	154	22.54	30.06
3	*2412.00	107.2 PK			1.13 V	157	77.05	30.15
4	*2412.00	96.9 AV			1.13 V	157	66.75	30.15
5	4824.00	52.8 PK	74.0	-21.2	1.22 V	90	17.37	35.43
6	4824.00	40.7 AV	54.0	-13.3	1.22 V	90	5.27	35.43

- REMARKS:**
1. Emission level (dBuV/m) = Raw Value (dBuV) + Correction Factor (dB/m).
 2. Correction Factor (dB/m) = Antenna Factor (dB/m) + Cable Factor (dB).
 3. The other emission levels were very low against the limit.
 4. Margin value = Emission level – Limit value.
 5. “ * “: Fundamental frequency.



A D T

EUT TEST CONDITION		MEASUREMENT DETAIL	
CHANNEL	Channel 6	FREQUENCY RANGE	1 ~ 25GHz
INPUT POWER (SYSTEM)	120Vac, 60Hz	DETECTOR FUNCTION	Peak (PK) Average (AV)
ENVIRONMENTAL CONDITIONS	30deg. C, 80%RH 1012 hPa	TESTED BY	Wen Yu

ANTENNA POLARITY & TEST DISTANCE: HORIZONTAL AT 3 M								
NO.	FREQ. (MHz)	EMISSION LEVEL (dBuV/m)	LIMIT (dBuV/m)	MARGIN (dB)	ANTENNA HEIGHT (m)	TABLE ANGLE (Degree)	RAW VALUE (dBuV)	CORRECTION FACTOR (dB/m)
1	*2437.00	106.2 PK			1.33 H	280	75.96	30.24
2	*2437.00	94.6 AV			1.33 H	280	64.36	30.24
3	4874.00	51.8 PK	74.0	-22.2	1.40 H	6	16.28	35.52
4	4874.00	39.2 AV	54.0	-14.8	1.40 H	6	3.68	35.52
5	7311.00	64.2 PK	74.0	-9.8	1.70 H	220	22.24	41.96
6	7311.00	50.9 AV	54.0	-3.1	1.70 H	220	8.94	41.96
ANTENNA POLARITY & TEST DISTANCE: VERTICAL AT 3 M								
NO.	FREQ. (MHz)	EMISSION LEVEL (dBuV/m)	LIMIT (dBuV/m)	MARGIN (dB)	ANTENNA HEIGHT (m)	TABLE ANGLE (Degree)	RAW VALUE (dBuV)	CORRECTION FACTOR (dB/m)
1	*2437.00	107.0 PK			1.42 V	169	76.76	30.24
2	*2437.00	95.9 AV			1.42 V	169	65.66	30.24
3	4874.00	54.0 PK	74.0	-20.0	1.39 V	99	18.48	35.52
4	4874.00	41.7 AV	54.0	-12.3	1.39 V	99	6.18	35.52
5	7311.00	61.6 PK	74.0	-12.4	1.35 V	161	19.64	41.96
6	7311.00	48.5 AV	54.0	-5.5	1.35 V	161	6.54	41.96

- REMARKS:**
1. Emission level (dBuV/m) = Raw Value (dBuV) + Correction Factor (dB/m).
 2. Correction Factor (dB/m) = Antenna Factor (dB/m) + Cable Factor (dB).
 3. The other emission levels were very low against the limit.
 4. Margin value = Emission level – Limit value.
 5. “ * “: Fundamental frequency.



A D T

EUT TEST CONDITION		MEASUREMENT DETAIL	
CHANNEL	Channel 11	FREQUENCY RANGE	1 ~ 25GHz
INPUT POWER (SYSTEM)	120Vac, 60Hz	DETECTOR FUNCTION	Peak (PK) Average (AV)
ENVIRONMENTAL CONDITIONS	30deg. C, 80%RH 1012 hPa	TESTED BY	Wen Yu

ANTENNA POLARITY & TEST DISTANCE: HORIZONTAL AT 3 M

NO.	FREQ. (MHz)	EMISSION LEVEL (dBuV/m)	LIMIT (dBuV/m)	MARGIN (dB)	ANTENNA HEIGHT (m)	TABLE ANGLE (Degree)	RAW VALUE (dBuV)	CORRECTION FACTOR (dB/m)
1	*2462.00	104.0 PK			1.32 H	198	73.66	30.34
2	*2462.00	93.5 AV			1.32 H	198	63.16	30.34
3	2483.50	66.5 PK	74.0	-7.5	1.32 H	198	36.07	30.43
4	2483.50	52.1 AV	54.0	-1.9	1.32 H	198	21.67	30.43
5	4924.00	49.8 PK	74.0	-24.2	1.36 H	6	14.18	35.62
6	4924.00	37.0 AV	54.0	-17.0	1.36 H	6	1.38	35.62
7	7386.00	61.9 PK	74.0	-12.1	1.41 H	220	19.80	42.10
8	7386.00	48.5 AV	54.0	-5.5	1.41 H	220	6.40	42.10

ANTENNA POLARITY & TEST DISTANCE: VERTICAL AT 3 M

NO.	FREQ. (MHz)	EMISSION LEVEL (dBuV/m)	LIMIT (dBuV/m)	MARGIN (dB)	ANTENNA HEIGHT (m)	TABLE ANGLE (Degree)	RAW VALUE (dBuV)	CORRECTION FACTOR (dB/m)
1	*2462.00	106.1 PK			1.07 V	160	75.76	30.34
2	*2462.00	94.5 AV			1.07 V	160	64.16	30.34
3	2483.50	68.4 PK	74.0	-5.6	1.09 V	154	37.97	30.43
4	2483.50	52.8 AV	54.0	-1.2	1.09 V	154	22.37	30.43
5	4924.00	54.2 PK	74.0	-19.8	1.24 V	115	18.58	35.62
6	4924.00	41.2 AV	54.0	-12.8	1.24 V	115	5.58	35.62
7	7386.00	61.1 PK	74.0	-12.9	1.40 V	162	19.00	42.10
8	7386.00	48.1 AV	54.0	-5.9	1.40 V	162	6.00	42.10

- REMARKS:**
1. Emission level (dBuV/m) = Raw Value (dBuV) + Correction Factor (dB/m).
 2. Correction Factor (dB/m) = Antenna Factor (dB/m) + Cable Factor (dB).
 3. The other emission levels were very low against the limit.
 4. Margin value = Emission level – Limit value.
 5. “ * “: Fundamental frequency.



A D T

RESTRICTED BANDEDGE (802.11n (20MHz) MODE,CH1, HORIZONTAL)

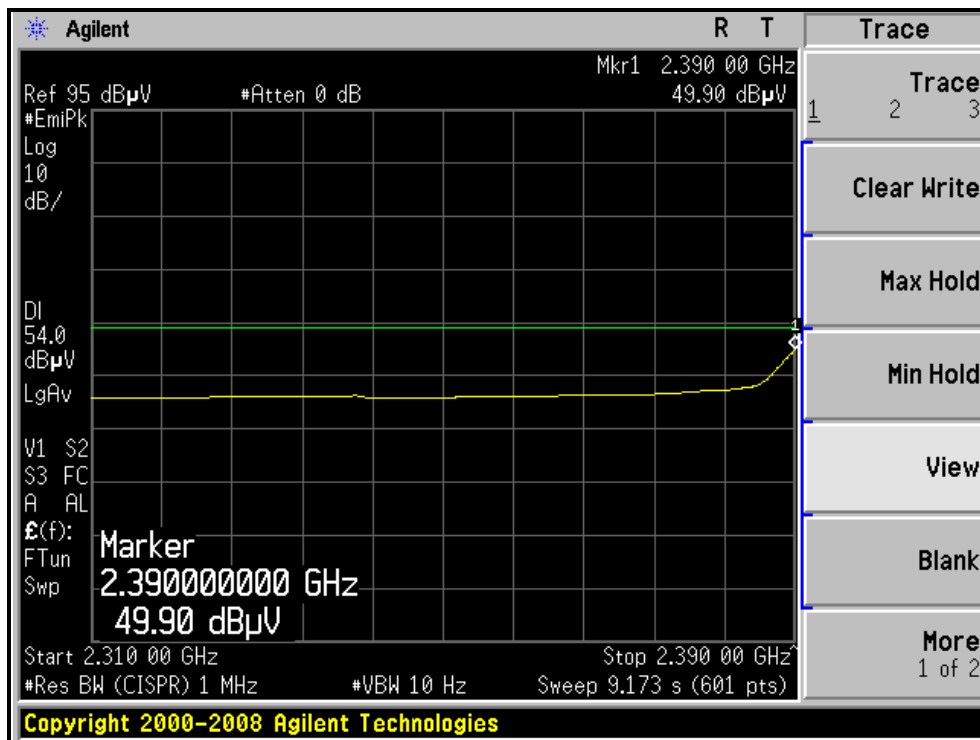
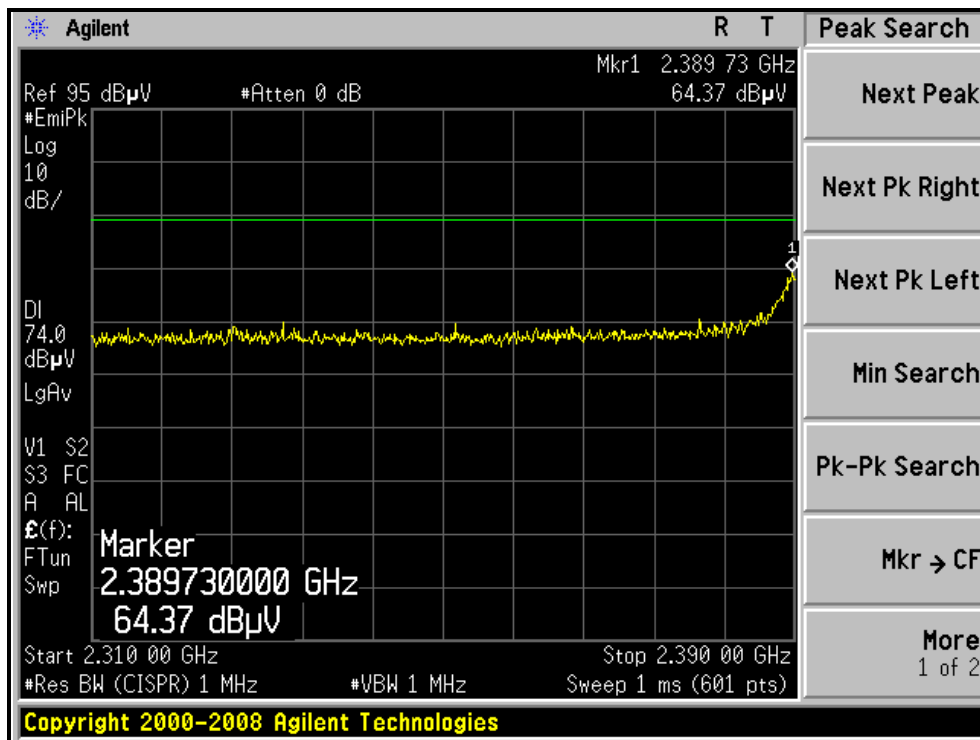



A D T

RESTRICTED BANDEDGE (802.11n (20MHz) MODE,CH1, VERTICAL)

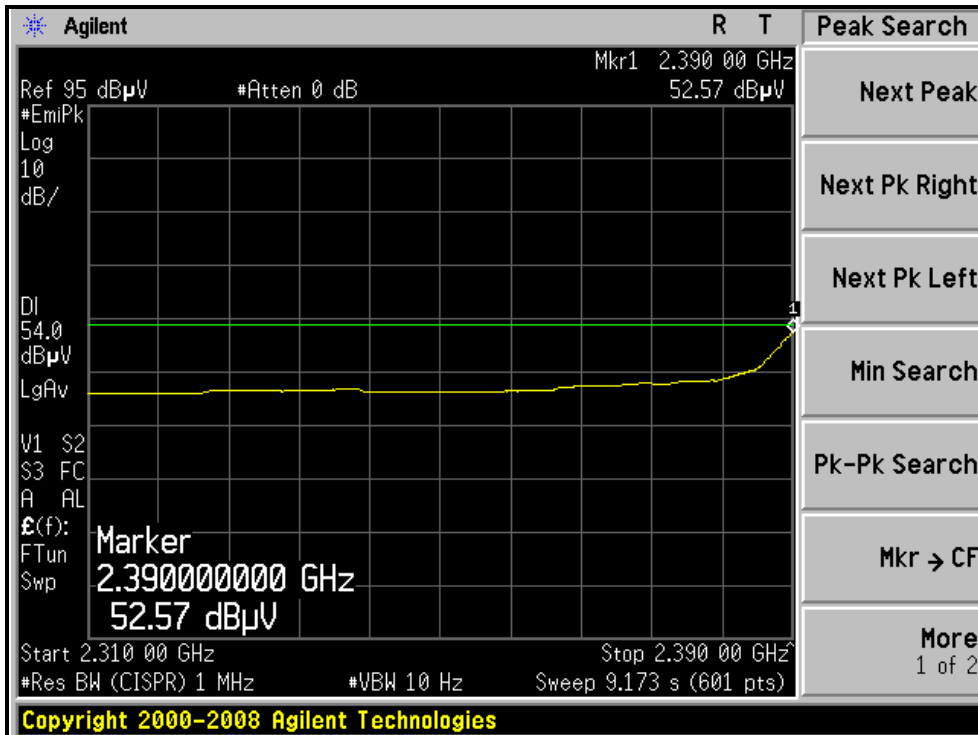
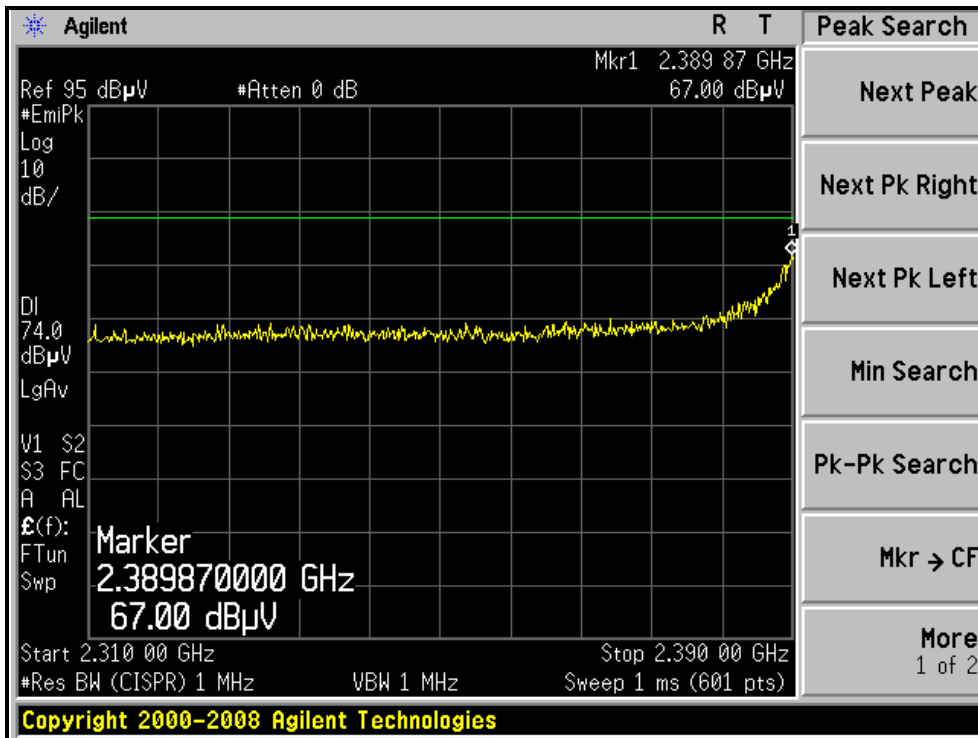

RESTRICTED BANDEDGE (802.11n (20MHz) MODE,CH11, HORIZONTAL)

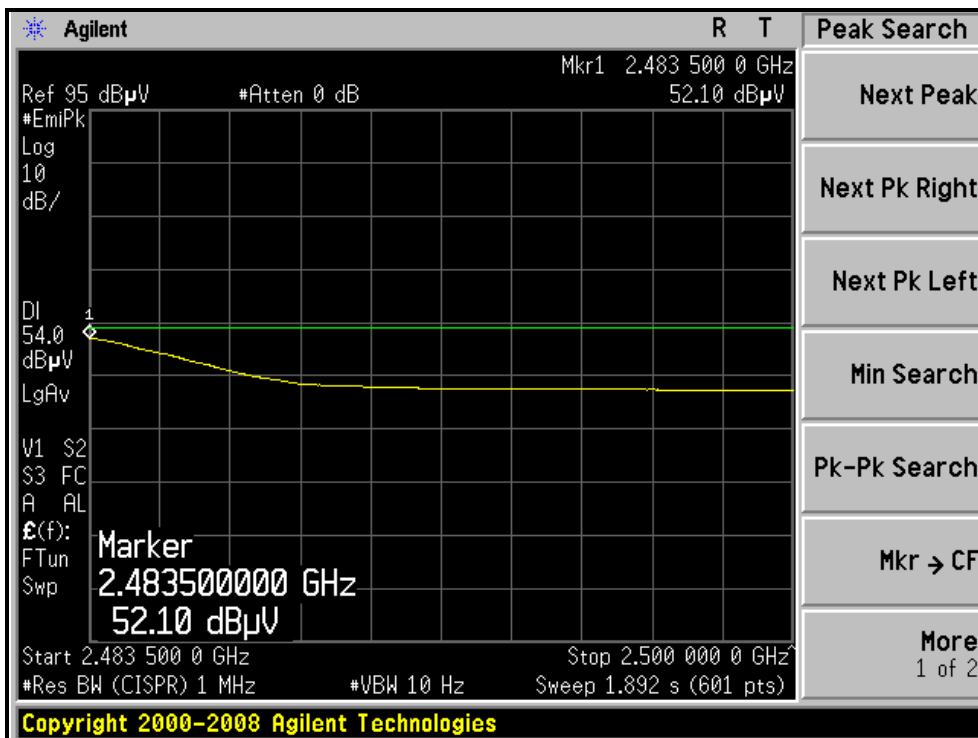
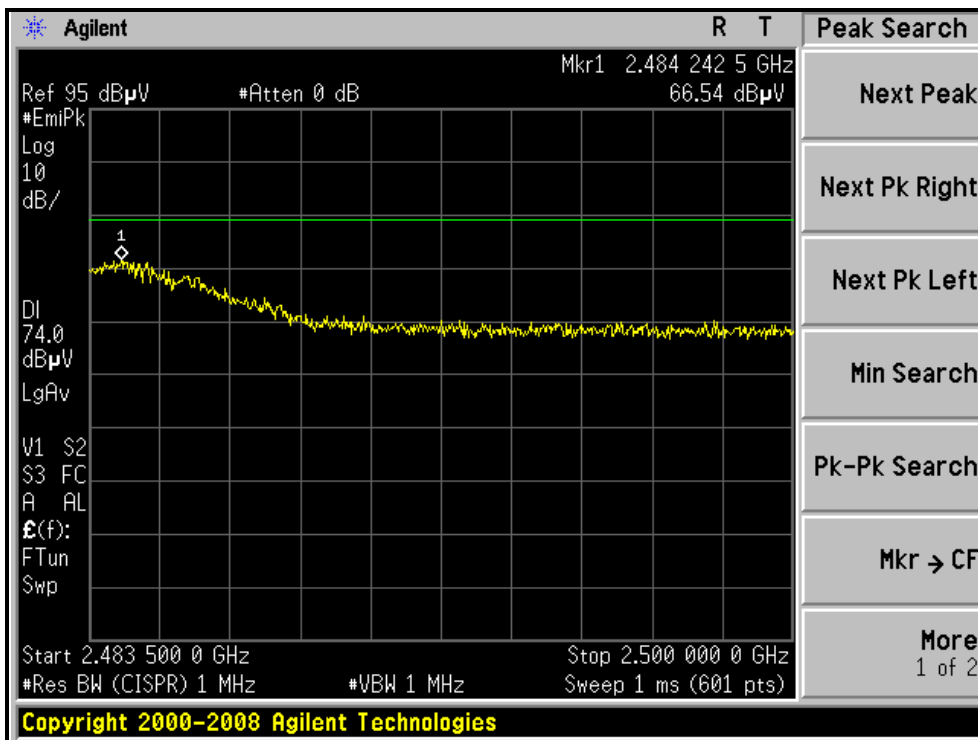

RESTRICTED BANDEDGE (802.11n (20MHz) MODE,CH11, VERTICAL)

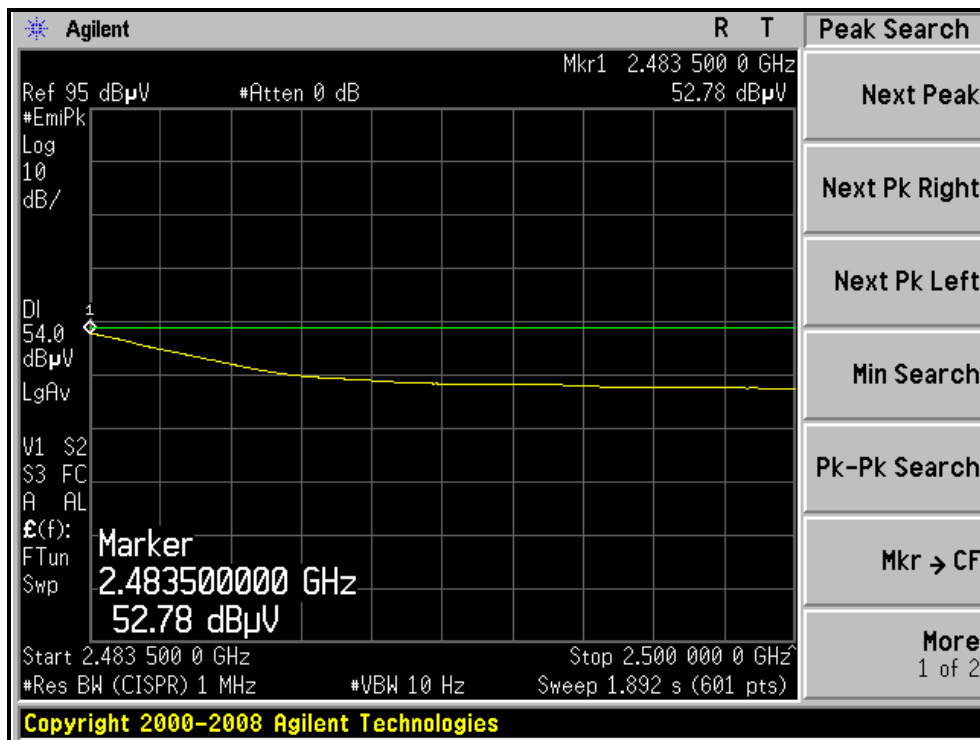
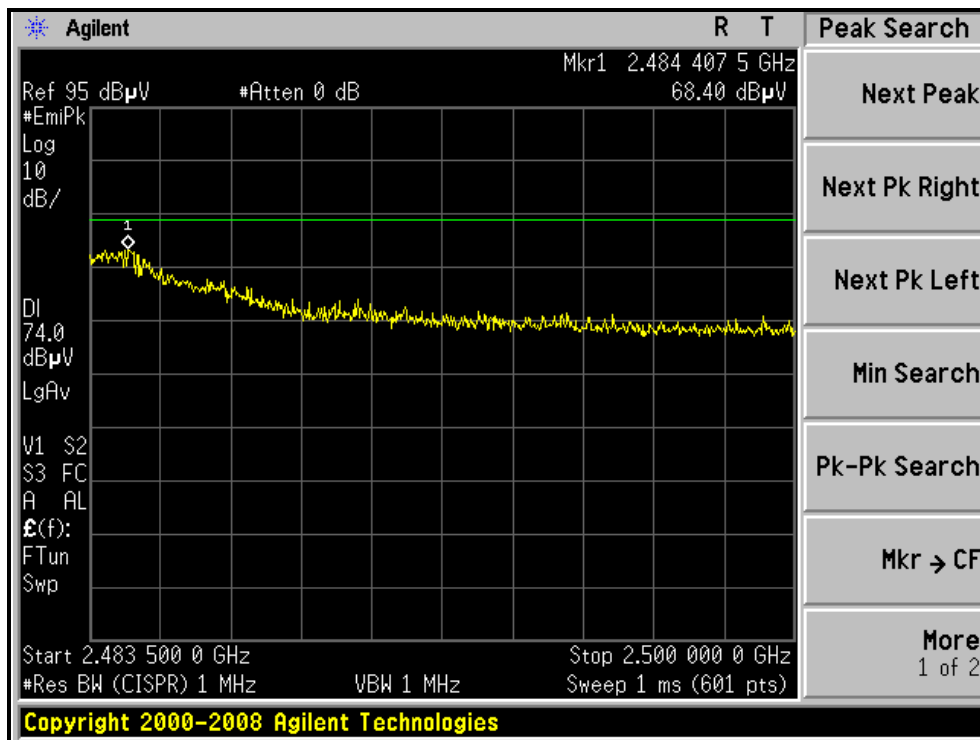



A D T

802.11n (40MHz) OFDM MODULATION

EUT TEST CONDITION		MEASUREMENT DETAIL	
CHANNEL	Channel 1	FREQUENCY RANGE	1 ~ 25GHz
INPUT POWER (SYSTEM)	120Vac, 60Hz	DETECTOR FUNCTION	Peak (PK) Average (AV)
ENVIRONMENTAL CONDITIONS	30deg. C, 80%RH 1012 hPa	TESTED BY	Wen Yu

ANTENNA POLARITY & TEST DISTANCE: HORIZONTAL AT 3 M								
NO.	FREQ. (MHz)	EMISSION LEVEL (dBuV/m)	LIMIT (dBuV/m)	MARGIN (dB)	ANTENNA HEIGHT (m)	TABLE ANGLE (Degree)	RAW VALUE (dBuV)	CORRECTION FACTOR (dB/m)
1	2390.00	64.4 PK	74.0	-9.6	1.32 H	201	34.34	30.06
2	2390.00	51.2 AV	54.0	-2.8	1.32 H	201	21.14	30.06
3	*2422.00	101.1 PK			1.32 H	201	70.91	30.19
4	*2422.00	91.3 AV			1.32 H	201	61.11	30.19
5	4844.00	45.9 PK	74.0	-28.1	1.41 H	8	10.43	35.47
6	4844.00	33.8 AV	54.0	-20.2	1.41 H	8	-1.67	35.47
7	7266.00	55.9 PK	74.0	-18.1	1.75 H	220	14.03	41.87
8	7266.00	42.1 AV	54.0	-11.9	1.75 H	220	0.23	41.87
ANTENNA POLARITY & TEST DISTANCE: VERTICAL AT 3 M								
NO.	FREQ. (MHz)	EMISSION LEVEL (dBuV/m)	LIMIT (dBuV/m)	MARGIN (dB)	ANTENNA HEIGHT (m)	TABLE ANGLE (Degree)	RAW VALUE (dBuV)	CORRECTION FACTOR (dB/m)
1	2390.00	64.5 PK	74.0	-9.5	1.11 V	156	34.44	30.06
2	2390.00	52.9 AV	54.0	-1.1	1.11 V	156	22.84	30.06
3	*2422.00	102.5 PK			1.12 V	156	72.31	30.19
4	*2422.00	92.4 AV			1.12 V	156	62.21	30.19
5	4844.00	49.7 PK	74.0	-24.3	1.22 V	90	14.23	35.47
6	4844.00	35.8 AV	54.0	-18.2	1.22 V	90	0.33	35.47
7	7266.00	54.0 PK	74.0	-20.0	1.29 V	162	12.13	41.87
8	7266.00	42.3 AV	54.0	-11.7	1.29 V	162	0.43	41.87

- REMARKS:**
1. Emission level (dBuV/m) = Raw Value (dBuV) + Correction Factor (dB/m).
 2. Correction Factor (dB/m) = Antenna Factor (dB/m) + Cable Factor (dB).
 3. The other emission levels were very low against the limit.
 4. Margin value = Emission level – Limit value.
 5. “ * “: Fundamental frequency.



A D T

EUT TEST CONDITION		MEASUREMENT DETAIL	
CHANNEL	Channel 4	FREQUENCY RANGE	1 ~ 25GHz
INPUT POWER (SYSTEM)	120Vac, 60Hz	DETECTOR FUNCTION	Peak (PK) Average (AV)
ENVIRONMENTAL CONDITIONS	30deg. C, 80%RH 1012 hPa	TESTED BY	Wen Yu

ANTENNA POLARITY & TEST DISTANCE: HORIZONTAL AT 3 M

NO.	FREQ. (MHz)	EMISSION LEVEL (dBuV/m)	LIMIT (dBuV/m)	MARGIN (dB)	ANTENNA HEIGHT (m)	TABLE ANGLE (Degree)	RAW VALUE (dBuV)	CORRECTION FACTOR (dB/m)
1	*2437.00	102.9 PK			1.33 H	200	72.66	30.24
2	*2437.00	92.7 AV			1.33 H	200	62.46	30.24
3	2483.50	62.2 PK	74.0	-11.8	1.33 H	200	31.77	30.43
4	2483.50	49.7 AV	54.0	-4.3	1.33 H	200	19.27	30.43
5	4874.00	46.4 PK	74.0	-27.6	1.41 H	7	10.88	35.52
6	4874.00	35.3 AV	54.0	-18.7	1.41 H	7	-0.22	35.52
7	7311.00	59.7 PK	74.0	-14.3	1.70 H	221	17.74	41.96
8	7311.00	45.7 AV	54.0	-8.3	1.70 H	221	3.74	41.96

ANTENNA POLARITY & TEST DISTANCE: VERTICAL AT 3 M

NO.	FREQ. (MHz)	EMISSION LEVEL (dBuV/m)	LIMIT (dBuV/m)	MARGIN (dB)	ANTENNA HEIGHT (m)	TABLE ANGLE (Degree)	RAW VALUE (dBuV)	CORRECTION FACTOR (dB/m)
1	*2437.00	103.7 PK			1.12 V	159	73.46	30.24
2	*2437.00	93.1 AV			1.12 V	159	62.86	30.24
3	2483.50	63.4 PK	74.0	-10.6	1.11 V	161	32.97	30.43
4	2483.50	50.3 AV	54.0	-3.7	1.11 V	161	19.87	30.43
5	4874.00	49.2 PK	74.0	-24.8	1.25 V	111	13.68	35.52
6	4874.00	38.2 AV	54.0	-15.8	1.25 V	111	2.68	35.52
7	7311.00	57.9 PK	74.0	-16.1	1.35 V	164	15.94	41.96
8	7311.00	45.6 AV	54.0	-8.4	1.35 V	164	3.64	41.96

- REMARKS:**
1. Emission level (dBuV/m) = Raw Value (dBuV) + Correction Factor (dB/m).
 2. Correction Factor (dB/m) = Antenna Factor (dB/m) + Cable Factor (dB).
 3. The other emission levels were very low against the limit.
 4. Margin value = Emission level – Limit value.
 5. “ * “: Fundamental frequency.



A D T

EUT TEST CONDITION		MEASUREMENT DETAIL	
CHANNEL	Channel 7	FREQUENCY RANGE	1 ~ 25GHz
INPUT POWER (SYSTEM)	120Vac, 60Hz	DETECTOR FUNCTION	Peak (PK) Average (AV)
ENVIRONMENTAL CONDITIONS	30deg. C, 80%RH 1012 hPa	TESTED BY	Wen Yu

ANTENNA POLARITY & TEST DISTANCE: HORIZONTAL AT 3 M

NO.	FREQ. (MHz)	EMISSION LEVEL (dBuV/m)	LIMIT (dBuV/m)	MARGIN (dB)	ANTENNA HEIGHT (m)	TABLE ANGLE (Degree)	RAW VALUE (dBuV)	CORRECTION FACTOR (dB/m)
1	*2452.00	99.8 PK			1.33 H	199	69.50	30.30
2	*2452.00	89.7 AV			1.33 H	199	59.40	30.30
3	2483.50	65.3 PK	74.0	-8.7	1.33 H	199	34.87	30.43
4	2483.50	51.4 AV	54.0	-2.6	1.33 H	199	20.97	30.43
5	4904.00	44.3 PK	74.0	-29.7	1.38 H	7	8.72	35.58
6	4904.00	32.1 AV	54.0	-21.9	1.38 H	7	-3.48	35.58
7	7356.00	54.5 PK	74.0	-19.5	1.70 H	220	12.46	42.04
8	7356.00	42.9 AV	54.0	-11.1	1.70 H	220	0.86	42.04

ANTENNA POLARITY & TEST DISTANCE: VERTICAL AT 3 M

NO.	FREQ. (MHz)	EMISSION LEVEL (dBuV/m)	LIMIT (dBuV/m)	MARGIN (dB)	ANTENNA HEIGHT (m)	TABLE ANGLE (Degree)	RAW VALUE (dBuV)	CORRECTION FACTOR (dB/m)
1	*2452.00	101.6 PK			1.10 V	160	71.30	30.30
2	*2452.00	90.9 AV			1.10 V	160	60.60	30.30
3	2483.91	66.7 PK	74.0	-7.3	1.15 V	89	36.27	30.43
4	2483.91	53.0 AV	54.0	-1.0	1.15 V	89	22.57	30.43
5	4904.00	46.6 PK	74.0	-27.4	1.24 V	115	11.02	35.58
6	4904.00	35.0 AV	54.0	-19.0	1.24 V	115	-0.58	35.58
7	7356.00	55.9 PK	74.0	-18.1	1.31 V	158	13.86	42.04
8	7356.00	42.4 AV	54.0	-11.6	1.31 V	158	0.36	42.04

- REMARKS:**
1. Emission level (dBuV/m) = Raw Value (dBuV) + Correction Factor (dB/m).
 2. Correction Factor (dB/m) = Antenna Factor (dB/m) + Cable Factor (dB).
 3. The other emission levels were very low against the limit.
 4. Margin value = Emission level – Limit value.
 5. “ * “: Fundamental frequency.



A D T

RESTRICTED BANDEDGE (802.11n (40MHz) MODE,CH1, HORIZONTAL)

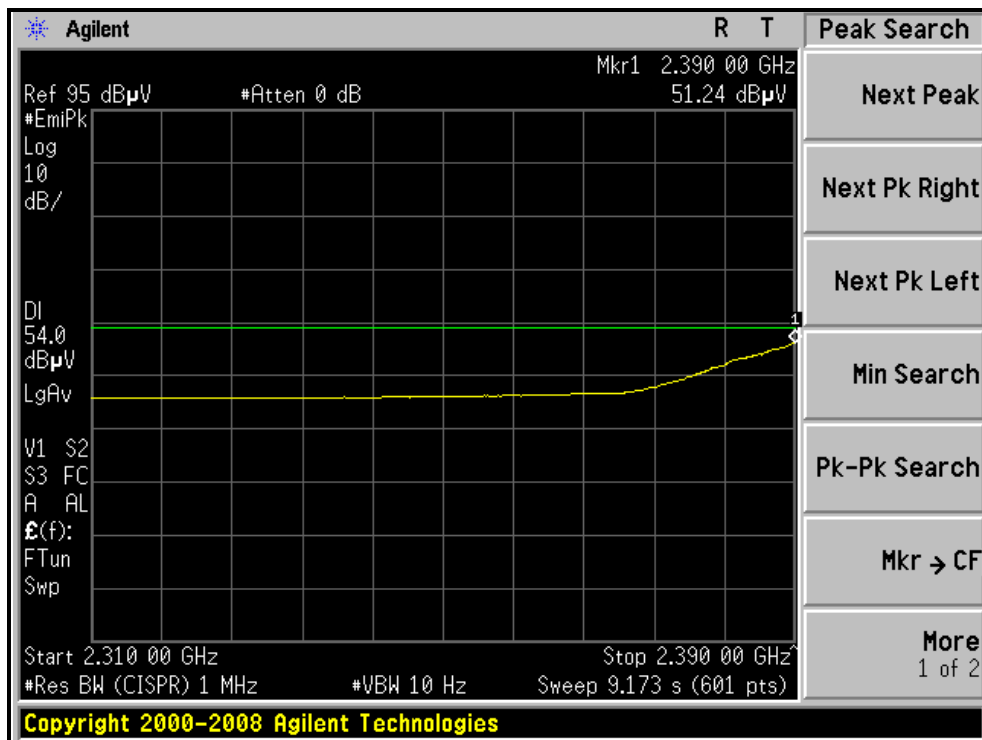
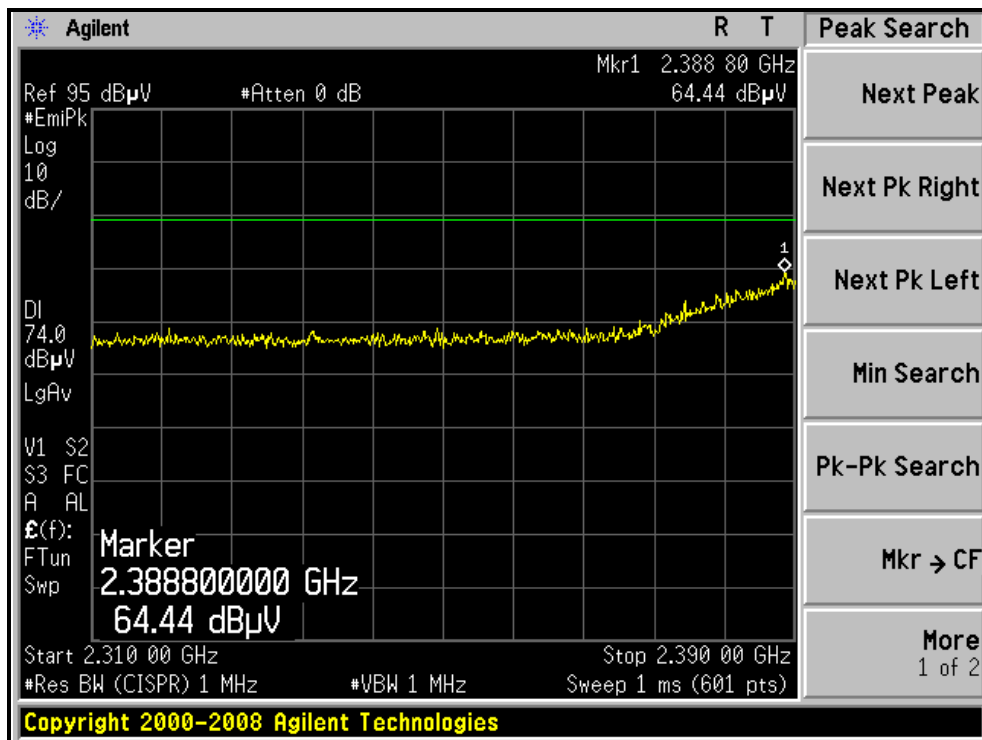



A D T

RESTRICTED BANDEDGE (802.11n (40MHz) MODE,CH1, VERTICAL)

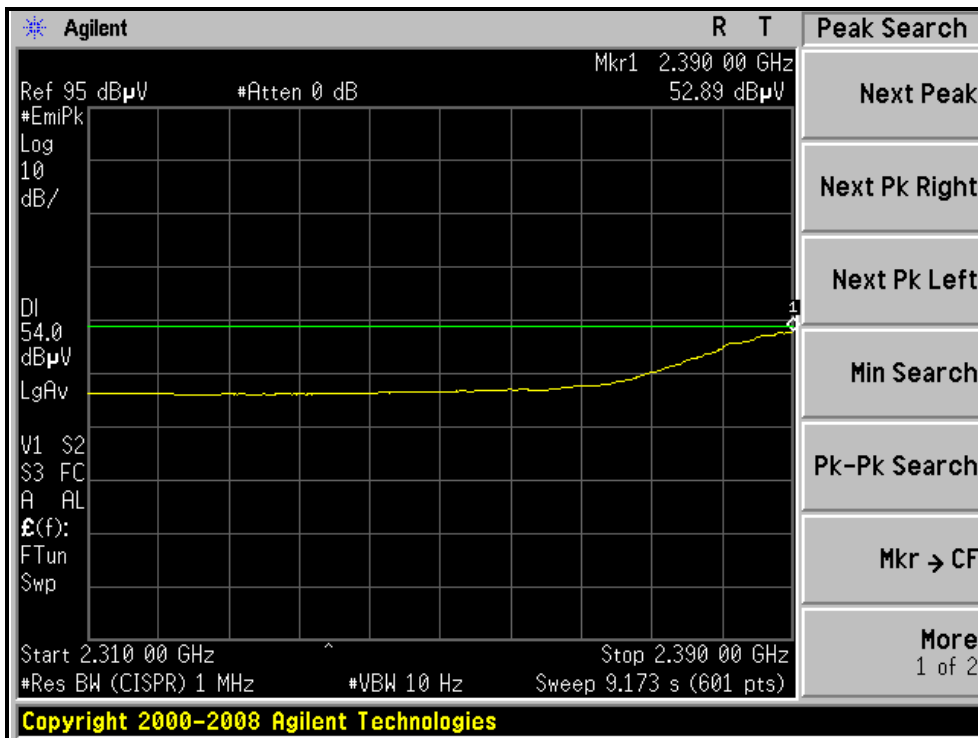
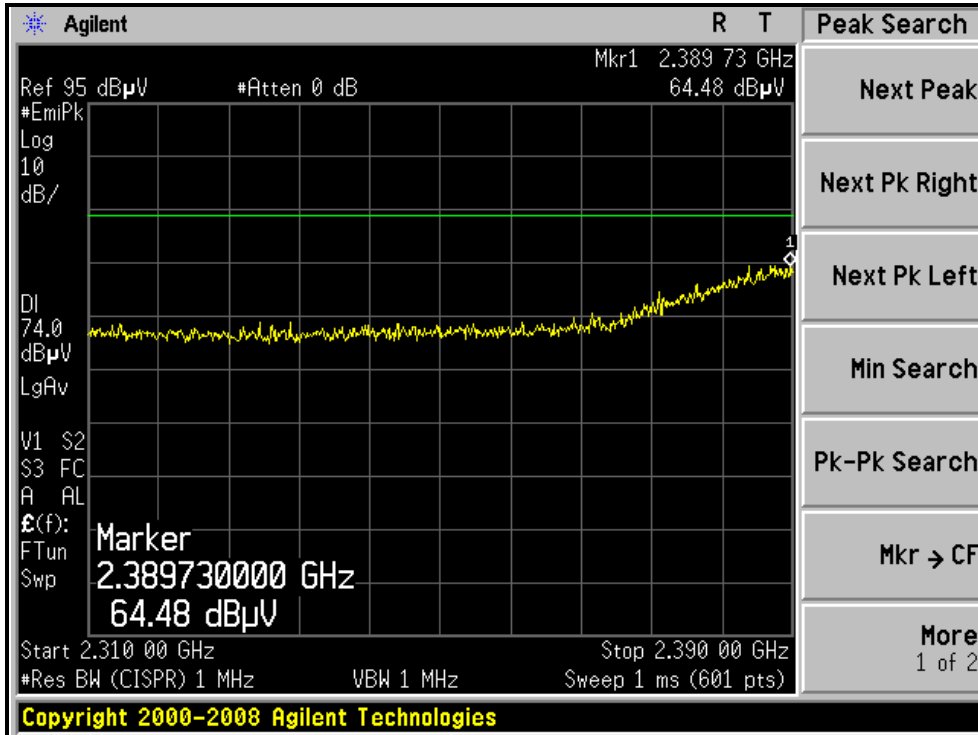



A D T

RESTRICTED BANDEDGE (802.11n (40MHz) MODE,CH7, HORIZONTAL)

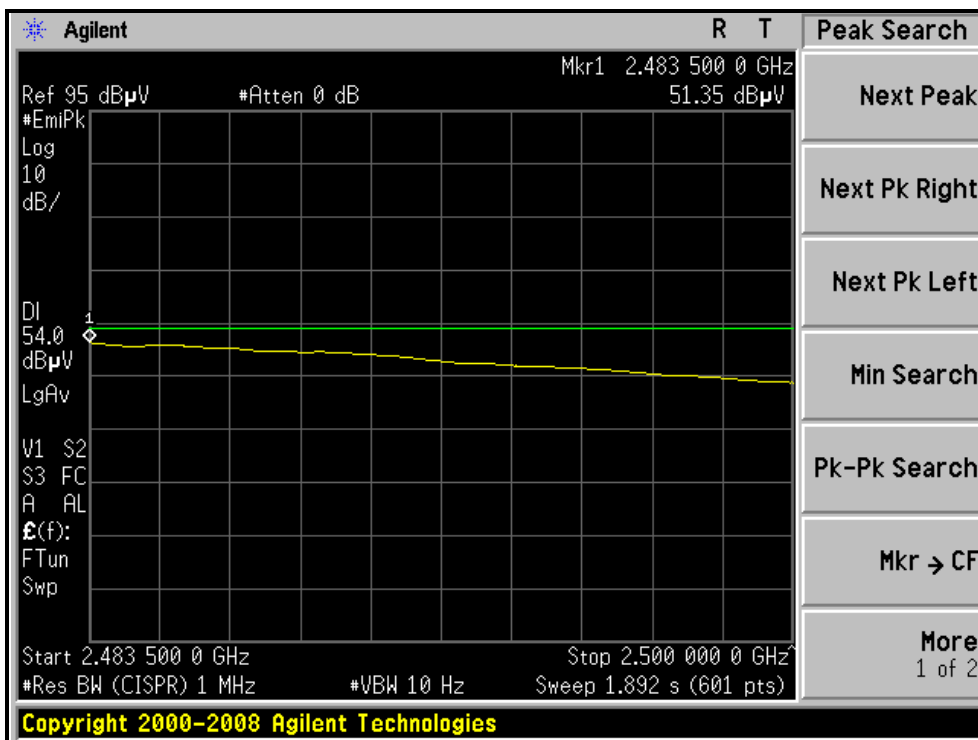
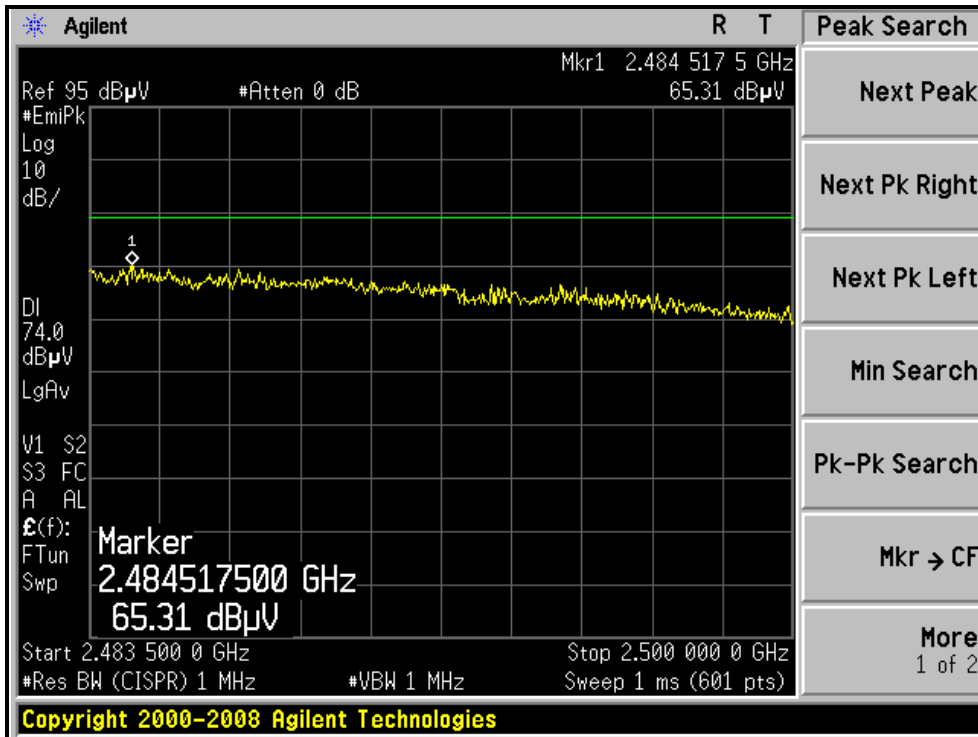



A D T

RESTRICTED BANDEDGE (802.11n (40MHz) MODE,CH7, VERTICAL)

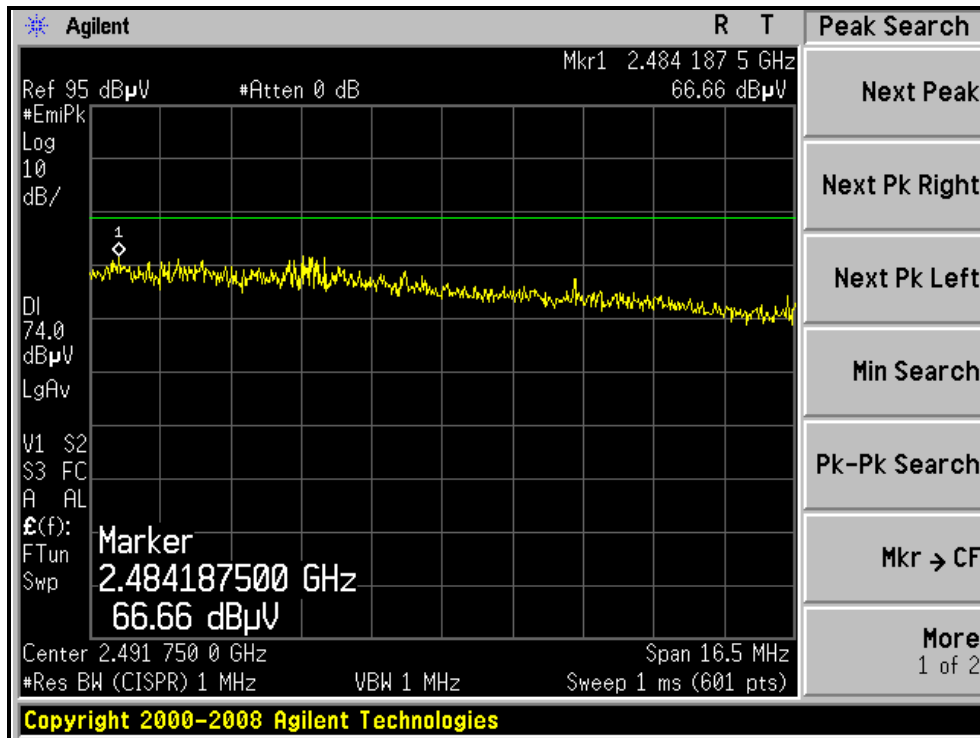

4.3 6dB BANDWIDTH MEASUREMENT

4.3.1 LIMITS OF 6dB BANDWIDTH MEASUREMENT

The minimum of 6dB Bandwidth Measurement is 0.5 MHz.

4.3.2 TEST INSTRUMENTS

DESCRIPTION & MANUFACTURER	MODEL NO.	SERIAL NO.	CALIBRATED DATE	CALIBRATED UNTIL
R&S SPECTRUM ANALYZER	E4446A	MY48250253	Aug. 03, 2009	Aug. 02, 2010

NOTE:

1. The calibration interval of the above test instruments is 12 months and the calibrations are traceable to NML/ROC and NIST/USA.

4.3.3 TEST PROCEDURE

The transmitter output was connected to the spectrum analyzer through an attenuator. The bandwidth of the fundamental frequency was measured by spectrum analyzer with 100kHz RBW and 100kHz VBW. The 6dB bandwidth is defined as the total spectrum the power of which is higher than peak power minus 6dB.

4.3.4 DEVIATION FROM TEST STANDARD

No deviation

4.3.5 TEST SETUP

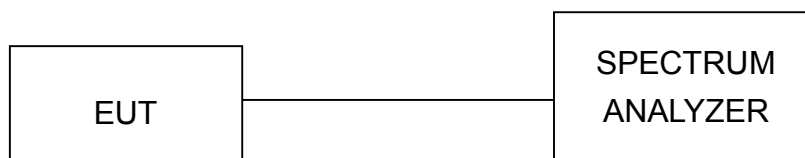

4.3.6 EUT OPERATING CONDITIONS

The software provided by client to enable the EUT under transmission condition continuously at lowest, middle and highest channel frequencies individually.



A D T

4.3.7 TEST RESULTS

802.11b DSSS MODULATION:

CHANNEL	CHANNEL FREQUENCY (MHz)	6dB BANDWIDTH (MHz)	MINIMUM LIMIT (MHz)	PASS / FAIL
1	2412	10.15	0.5	PASS
6	2437	10.10	0.5	PASS
11	2462	10.12	0.5	PASS

CH1

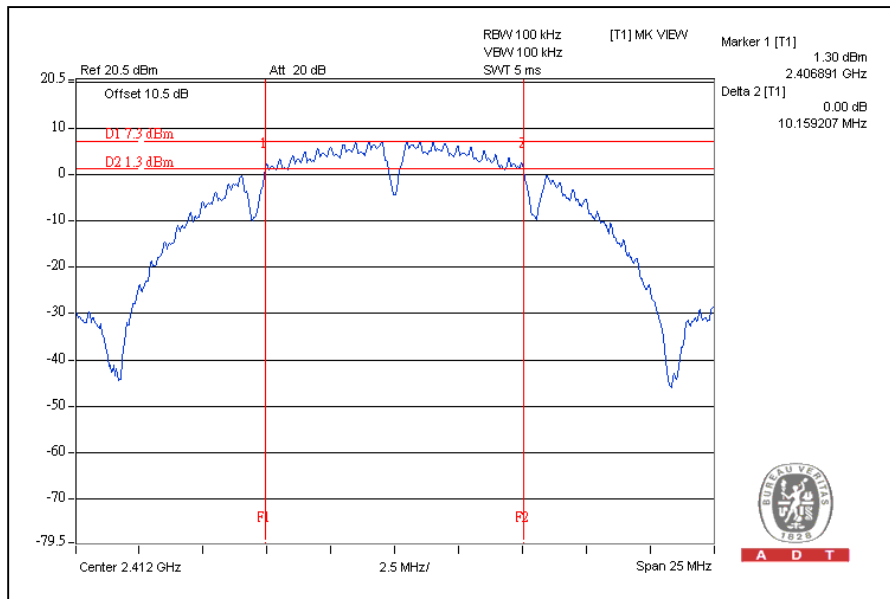

802.11g OFDM MODULATION:

CHANNEL	CHANNEL FREQUENCY (MHz)	6dB BANDWIDTH (MHz)	MINIMUM LIMIT (MHz)	PASS / FAIL
1	2412	16.60	0.5	PASS
6	2437	16.60	0.5	PASS
11	2462	16.58	0.5	PASS

CH1

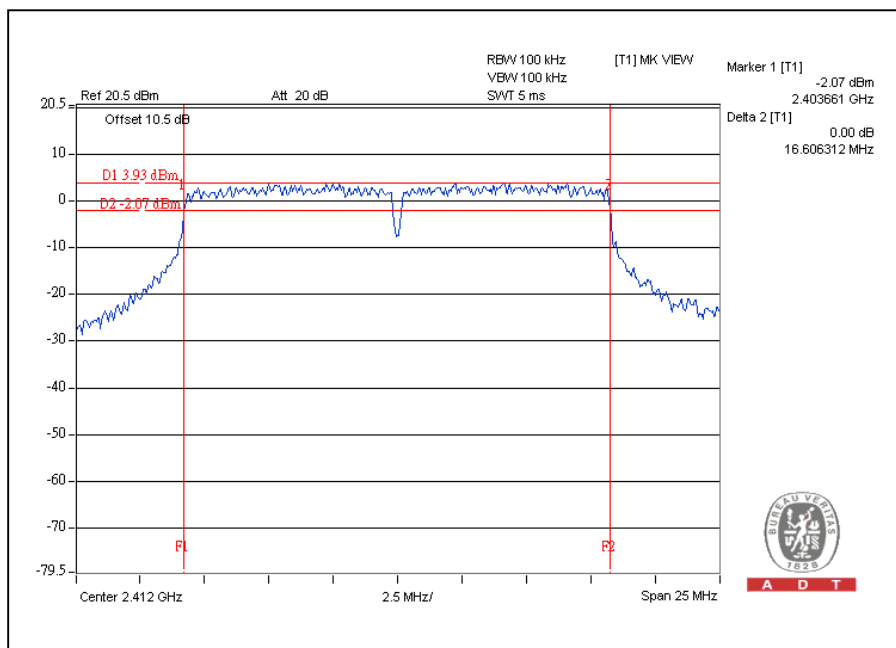

802.11n (20MHz) OFDM MODULATION:

CHANNEL	CHANNEL FREQUENCY (MHz)	6dB BANDWIDTH (MHz)	MINIMUM LIMIT (MHz)	PASS / FAIL
1	2412	17.86	0.5	PASS
6	2437	17.85	0.5	PASS
11	2462	17.83	0.5	PASS

CH1

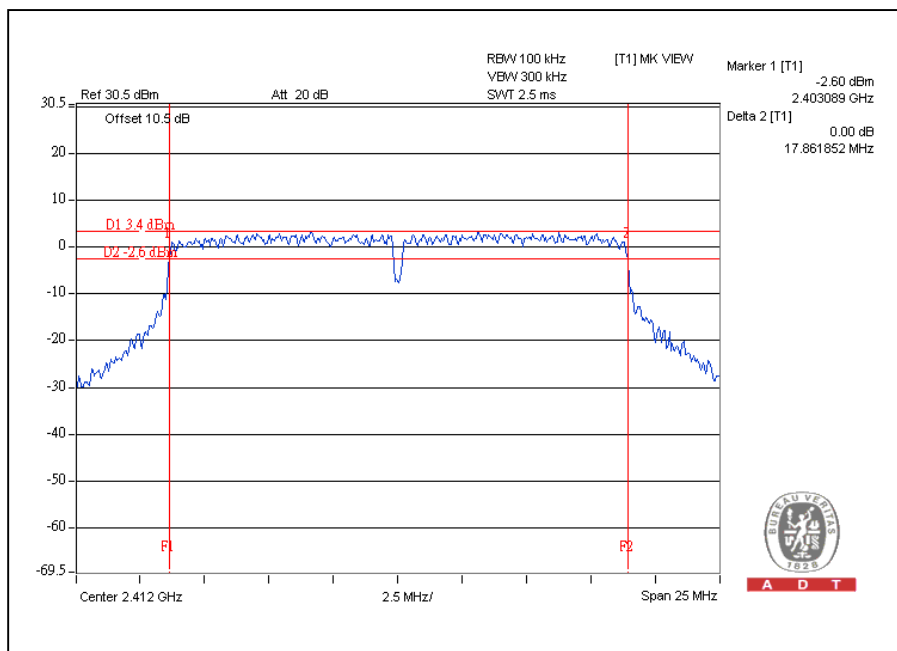

802.11n (40MHz) OFDM MODULATION:

CHANNEL	CHANNEL FREQUENCY (MHz)	6dB BANDWIDTH (MHz)	MINIMUM LIMIT (MHz)	PASS / FAIL
1	2422	36.51	0.5	PASS
4	2437	36.53	0.5	PASS
7	2452	36.50	0.5	PASS

CH4

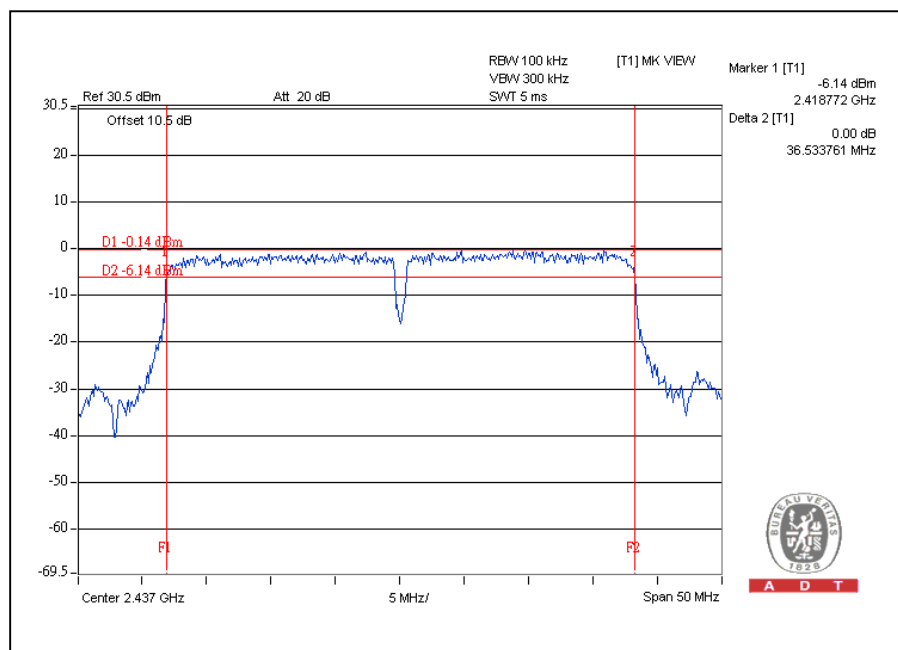

4.4 MAXIMUM PEAK OUTPUT POWER

4.4.1 LIMITS OF MAXIMUM PEAK OUTPUT POWER MEASUREMENT

The Maximum Peak Output Power Measurement is 30dBm.

4.4.2 INSTRUMENTS

Tested Date: July 13

DESCRIPTION & MANUFACTURER	MODEL NO.	SERIAL NO.	CALIBRATED DATE	CALIBRATED UNTIL
Anritsu Power Meter	ML2495A	0824006	May 04, 2010	May 03, 2011
Pulse Power Sensor	MA2411B	0738172	May 04, 2010	May 03, 2011

NOTE:

The calibration interval of the above test instruments is 12 months and the calibrations are traceable to NML/ROC and NIST/USA.

4.4.3 TEST PROCEDURES

1. The transmitter output was connected to the power meter through an attenuator; the bandwidth of the fundamental frequency was measured with the power meter.
2. Record the power level.

4.4.4 DEVIATION FROM TEST STANDARD

No deviation

4.4.5 TEST SETUP

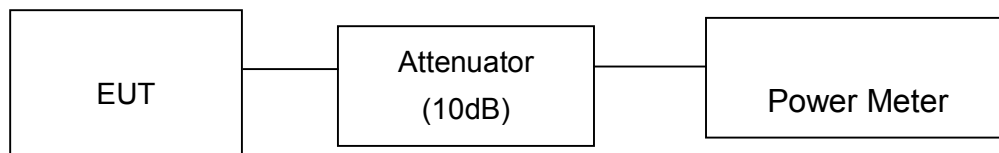

4.4.6 EUT OPERATING CONDITIONS

Same as Item 4.3.6



A D T

4.4.7 TEST RESULTS

802.11b DSSS MODULATION:

CHANNEL	CHANNEL FREQUENCY (MHz)	PEAK POWER OUTPUT (dBm)	PEAK POWER OUTPUT (mW)	PEAK POWER LIMIT (dBm)	PASS / FAIL
1	2412	17.6	57.5	30	PASS
6	2437	18.1	64.6	30	PASS
11	2462	18.0	63.1	30	PASS

802.11g OFDM MODULATION:

CHANNEL	CHANNEL FREQUENCY (MHz)	PEAK POWER OUTPUT (dBm)	PEAK POWER OUTPUT (mW)	PEAK POWER LIMIT (dBm)	PASS / FAIL
1	2412	24.2	263.0	30	PASS
6	2437	24.5	281.8	30	PASS
11	2462	24.4	275.4	30	PASS

802.11n (20MHz) OFDM MODULATION:

CHANNEL	CHANNEL FREQUENCY (MHz)	PEAK POWER OUTPUT (dBm)		TOTAL PEAK POWER (mW)	TOTAL PEAK POWER (dBm)	PEAK POWER LIMIT (dBm)	PASS / FAIL
		CHAIN(0)	CHAIN(1)				
1	2412	25.2	25.1	654.7	28.2	30	PASS
6	2437	25.4	25.1	670.3	28.3	30	PASS
11	2462	24.9	24.0	560.2	27.5	30	PASS



A D T

802.11n (40MHz) OFDM MODULATION:

CHANNEL	CHANNEL FREQUENCY (MHz)	PEAK POWER OUTPUT (dBm)		TOTAL PEAK POWER (mW)	TOTAL PEAK POWER (dBm)	PEAK POWER LIMIT (dBm)	PASS / FAIL
		CHAIN(0)	CHAIN(1)				
1	2422	23.8	23.9	485.4	26.9	30	PASS
4	2437	25.1	24.3	592.7	27.7	30	PASS
7	2452	23.6	22.9	424.1	26.3	30	PASS

4.5 POWER SPECTRAL DENSITY MEASUREMENT

4.5.1 LIMITS OF POWER SPECTRAL DENSITY MEASUREMENT

The Maximum of Power Spectral Density Measurement is 8dBm.

4.5.2 TEST INSTRUMENTS

DESCRIPTION & MANUFACTURER	MODEL NO.	SERIAL NO.	CALIBRATED DATE	CALIBRATED UNTIL
R&S SPECTRUM ANALYZER	E4446A	MY48250253	Aug. 03, 2009	Aug. 02, 2010

NOTE:

1. The calibration interval of the above test instruments is 12 months and the calibrations are traceable to NML/ROC and NIST/USA.

4.5.3 TEST PROCEDURE

The transmitter output was connected to the spectrum analyzer through an attenuator, the bandwidth of the fundamental frequency was measured with the spectrum analyzer using 3kHz RBW and 30kHz VBW, set sweep time = span/3kHz.

The power spectral density was measured and recorded.

The sweep time is allowed to be longer than span/3kHz for a full response of the mixer in the spectrum analyzer.

4.5.4 DEVIATION FROM TEST STANDARD

No deviation

4.5.5 TEST SETUP

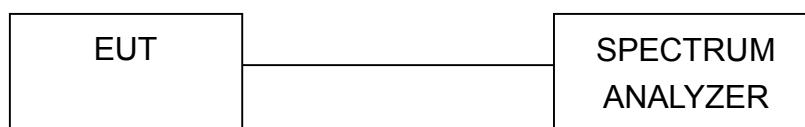

4.5.6 EUT OPERATING CONDITION

Same as Item 4.3.6



A D T

4.5.7 TEST RESULTS

802.11b DSSS MODULATION:

CHANNEL	CHANNEL FREQUENCY (MHz)	RF POWER LEVEL IN 3kHz BW (dBm)	MAXIMUM LIMIT (dBm)	PASS / FAIL
1	2412	-12.2	8	PASS
6	2437	-13.6	8	PASS
11	2462	-14.7	8	PASS

CH1

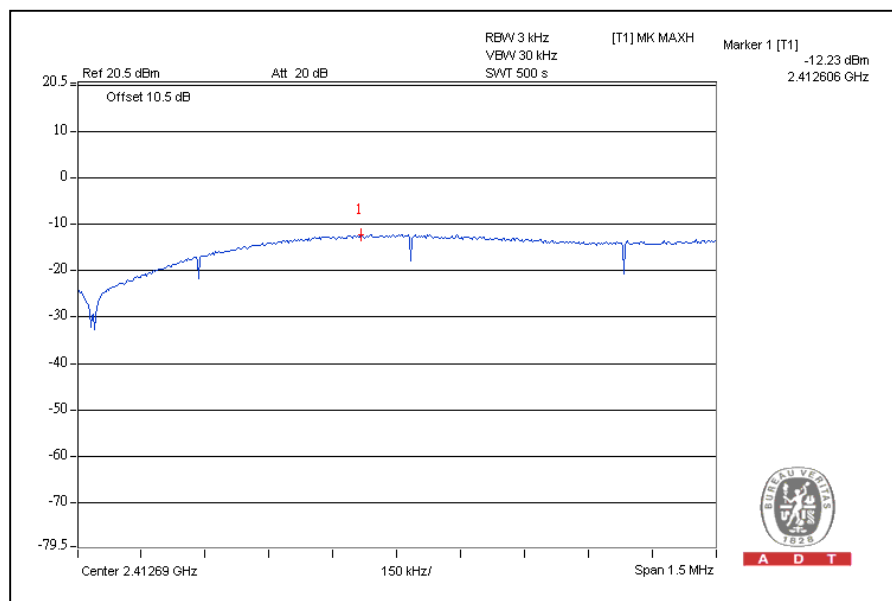



A D T

802.11g OFDM MODULATION:

CHANNEL	CHANNEL FREQUENCY (MHz)	RF POWER LEVEL IN 3kHz BW (dBm)	MAXIMUM LIMIT (dBm)	PASS / FAIL
1	2412	-10.2	8	PASS
6	2437	-10.1	8	PASS
11	2462	-10.7	8	PASS

CH6

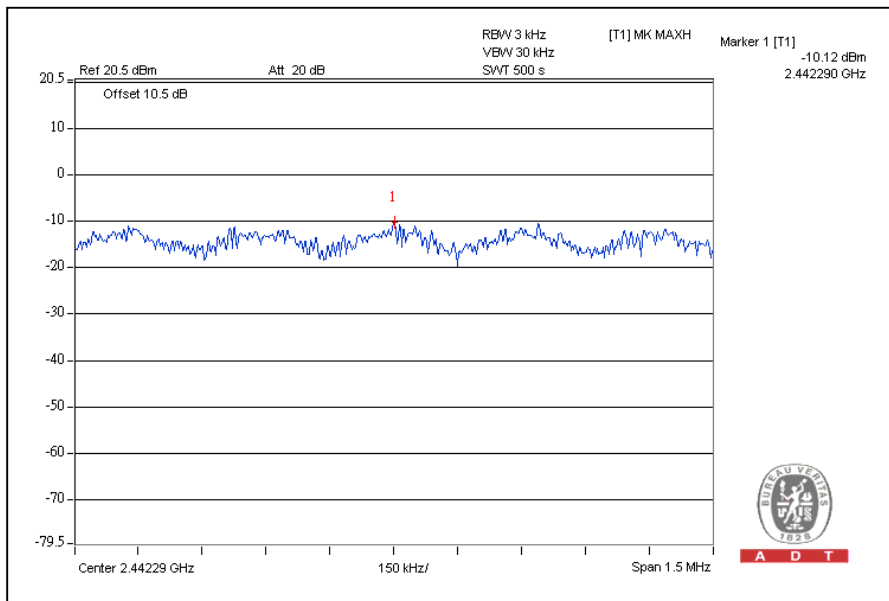

A D T



A D T

802.11n (20MHz) OFDM MODULATION:

CHANNEL	CHANNEL FREQUENCY (MHz)	RF POWER LEVEL IN 3kHz BW (dBm)		TOTAL POWER DENSITY (dBm)	MAXIMUM LIMIT (dBm)	PASS / FAIL
		CHAIN(0)	CHAIN(1)			
1	2412	-10.8	-11.1	-7.9	8	PASS
6	2437	-9.7	-9.4	-6.5	8	PASS
11	2462	-11.0	-11.2	-8.1	8	PASS

For Chain(1): CH6

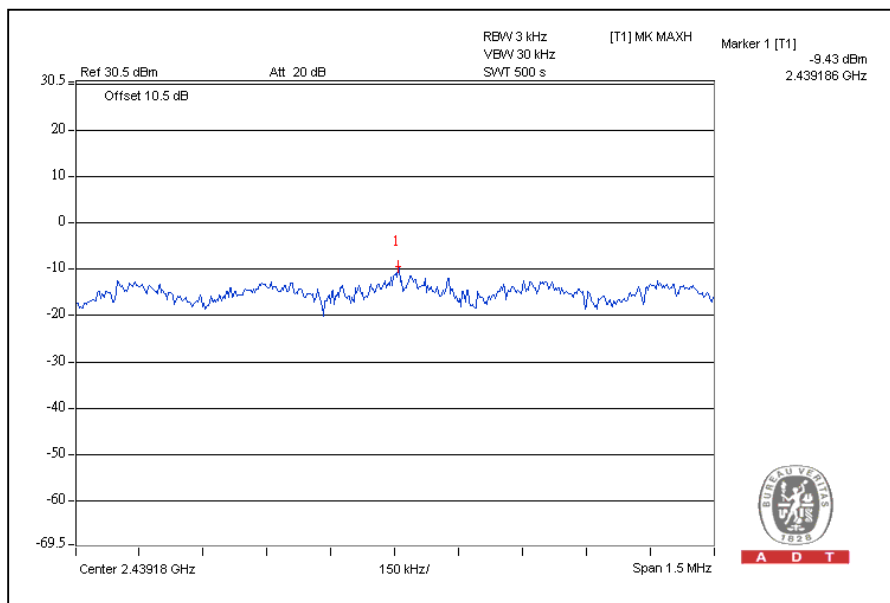

4.6 CONDUCTED OUT-BAND EMISSION MEASUREMENT

4.6.1 LIMITS OF CONDUCTED OUT-BAND EMISSION MEASUREMENT

Below -20dB of the highest emission level of operating band (in 100kHz Resolution Bandwidth).

4.6.2 TEST INSTRUMENTS

DESCRIPTION & MANUFACTURER	MODEL NO.	SERIAL NO.	CALIBRATED DATE	CALIBRATED UNTIL
R&S SPECTRUM ANALYZER	E4446A	MY482502 53	Aug. 03, 2009	Aug. 02, 2010

NOTE:

1. The calibration interval of the above test instruments is 12 months and the calibrations are traceable to NML/ROC and NIST/USA.

4.6.3 TEST PROCEDURE

The transmitter output was connected to the spectrum analyzer via a low loss cable. Set RBW of spectrum analyzer to 100kHz and VBW of spectrum analyzer to 300kHz with suitable frequency span including 100 MHz bandwidth from band edge. The band edges was measured and recorded.

The spectrum plots (RBW = 100kHz, VBW = 300kHz) are attached on the following pages.

4.6.4 DEVIATION FROM TEST STANDARD

No deviation

4.6.5 EUT OPERATING CONDITION

Same as Item 4.3.6

4.6.6 TEST RESULTS

The spectrum plots are attached on the following images. D1 line indicates the highest level, and D2 line indicates the 20dB offset below D1. It shows compliance with the requirement in part 15.247(d).

802.11b DSSS MODULATION:

CH1

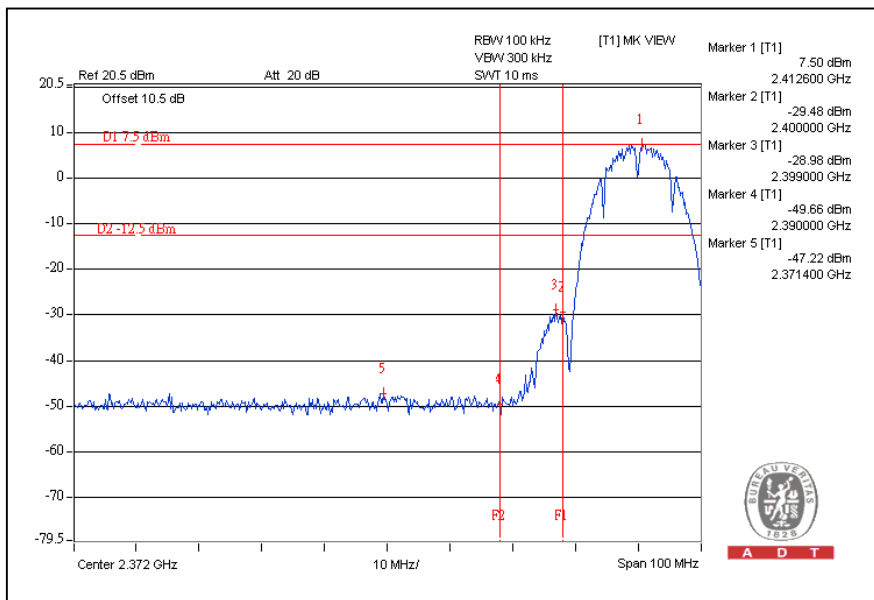

CH11

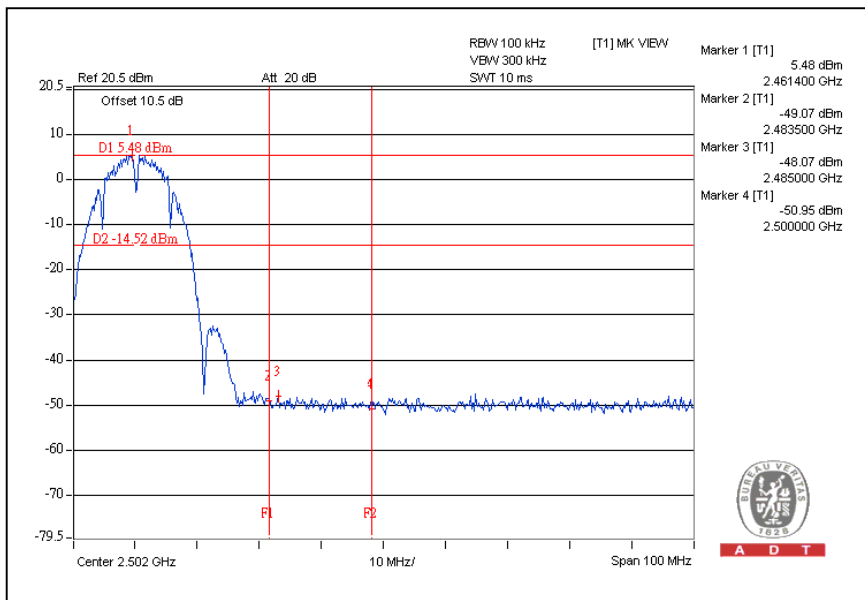



A D T

CH1

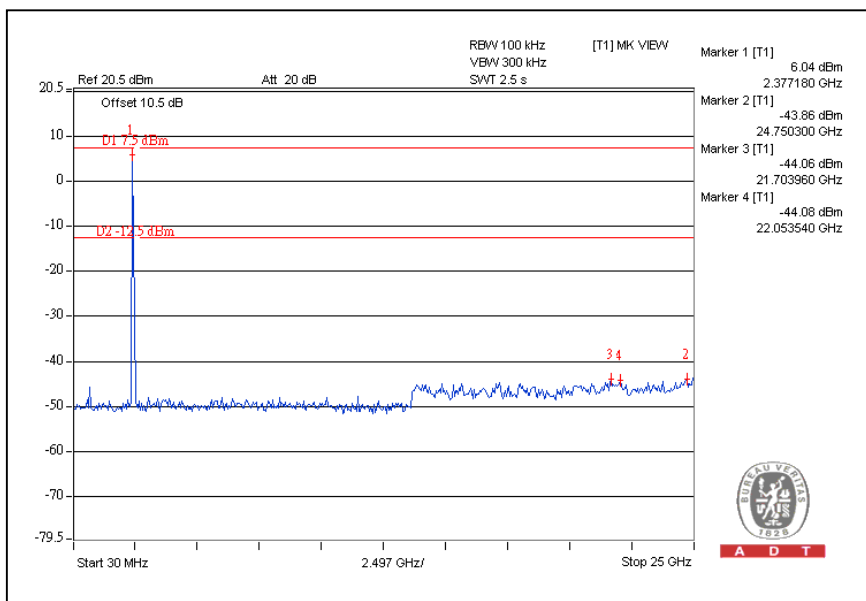

CH11

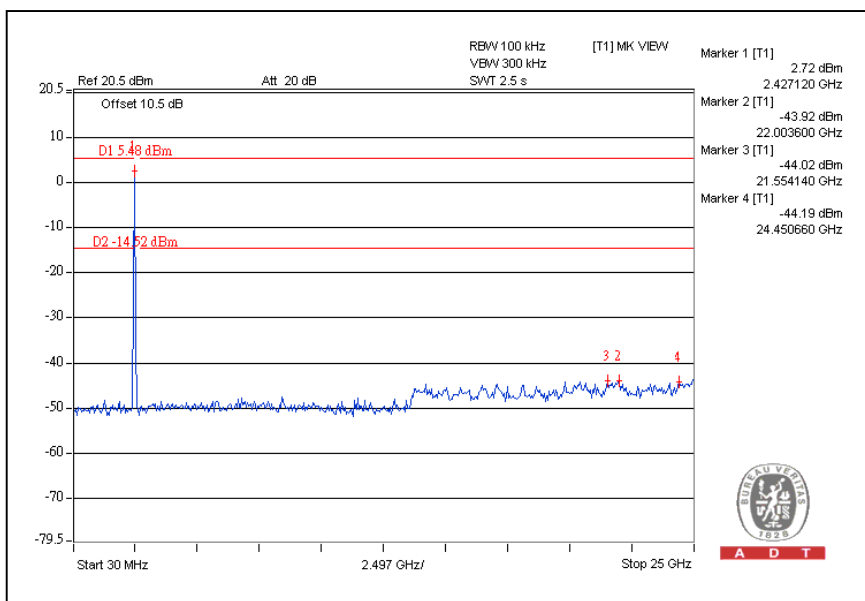

802.11g OFDM MODULATION:

CH1

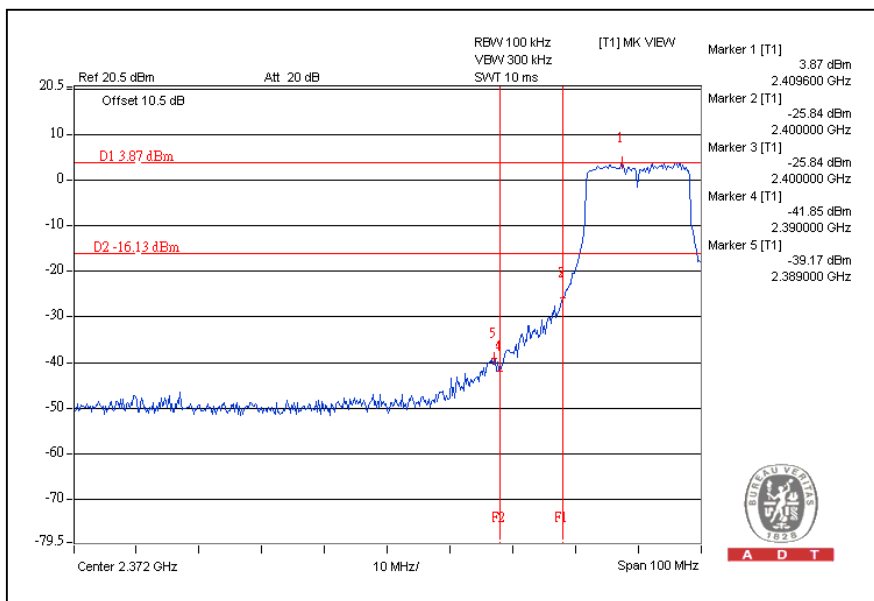

CH11

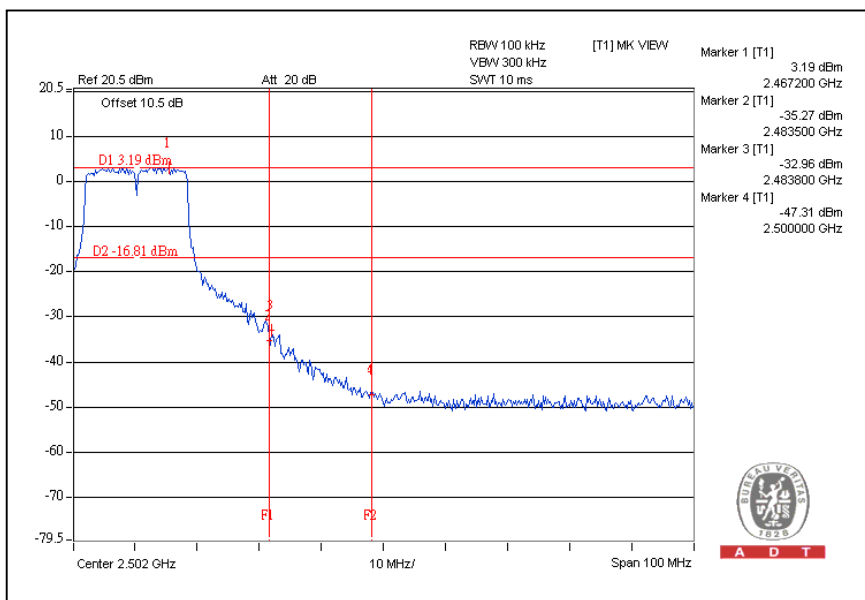



A D T

CH1

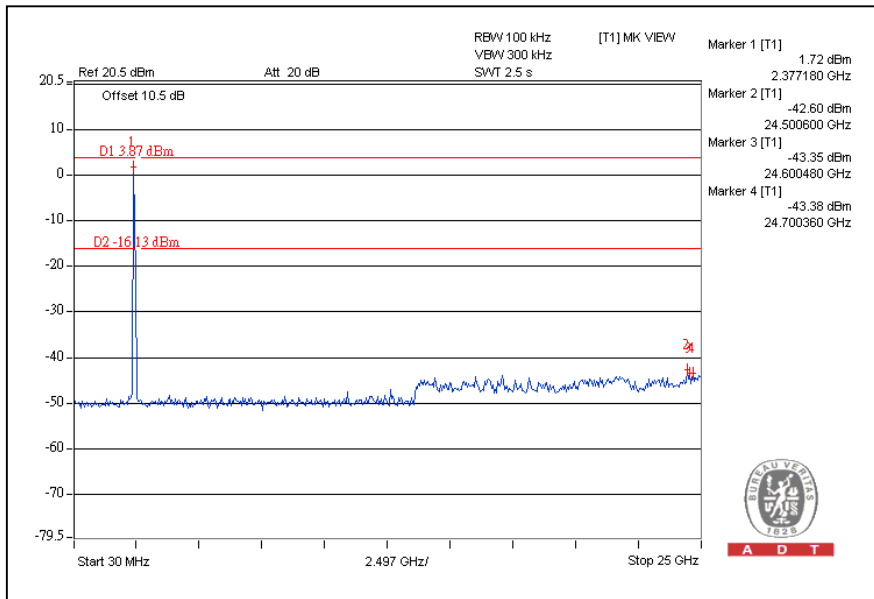

CH11

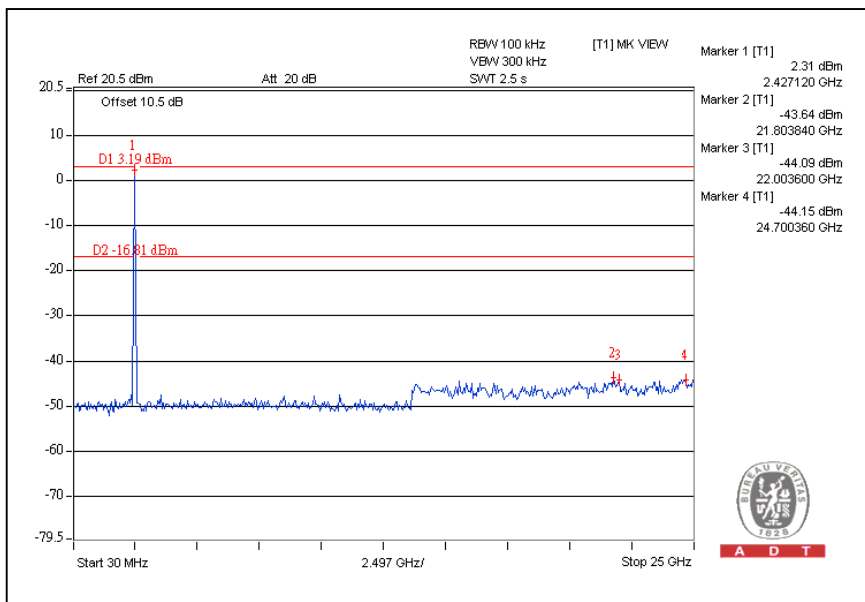

802.11n (20MHz) OFDM MODULATION:

CH1

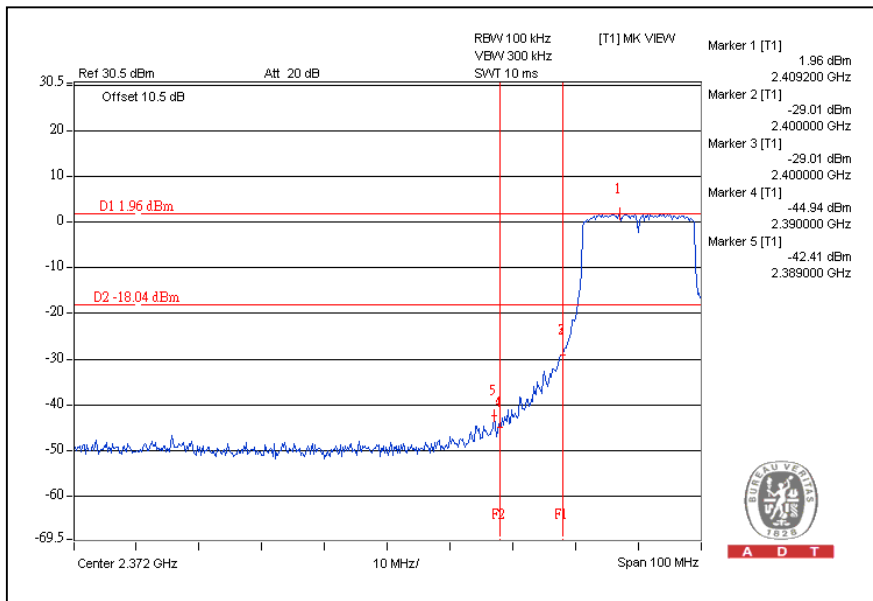

CH11

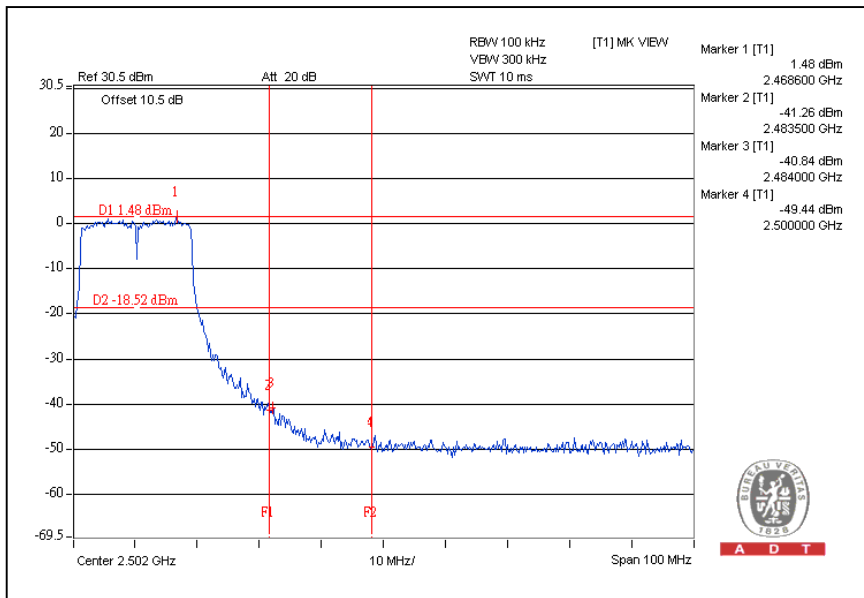



A D T

CH1

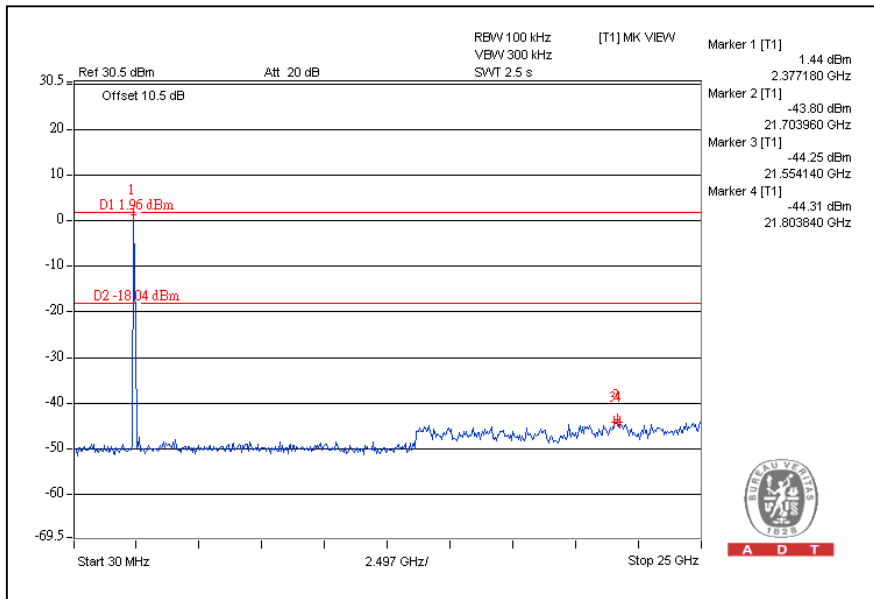

CH11

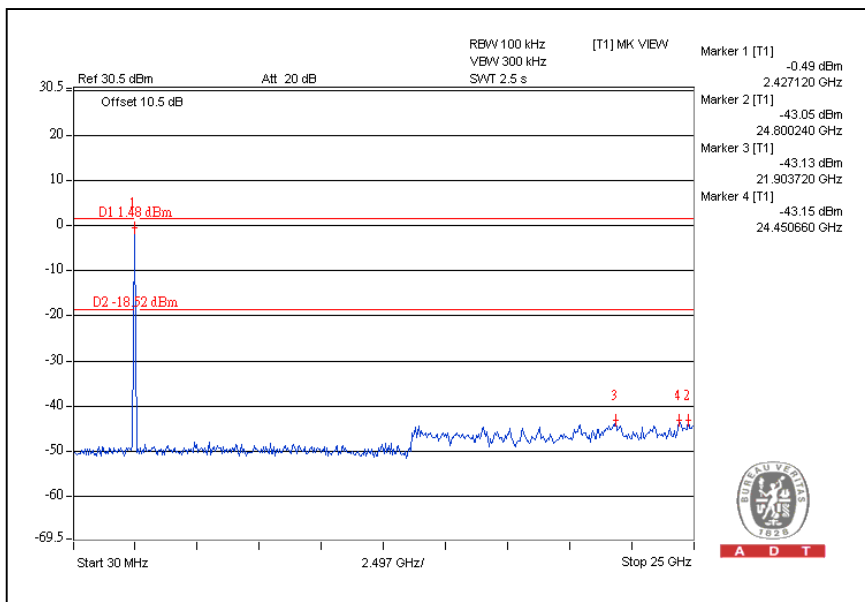

802.11n (40MHz) OFDM MODULATION:

CH1

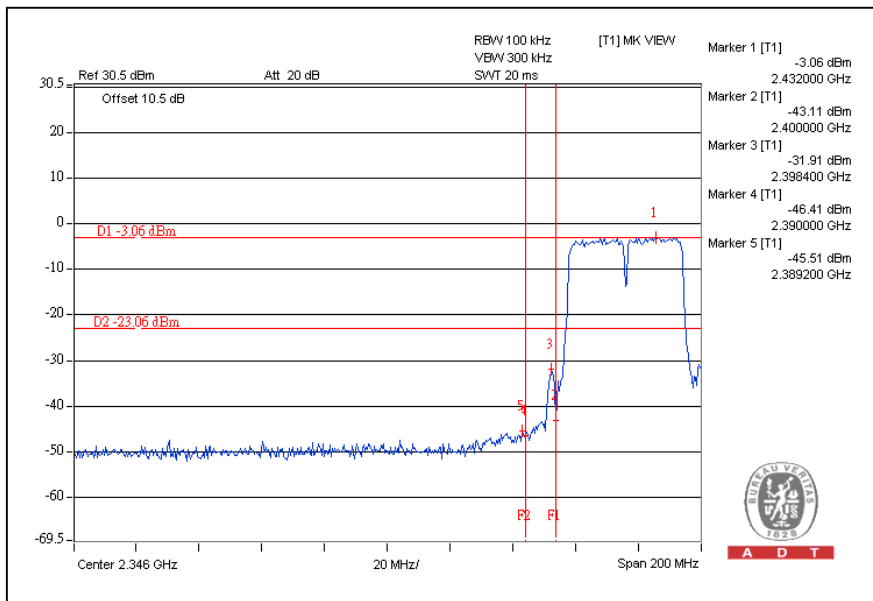

CH7

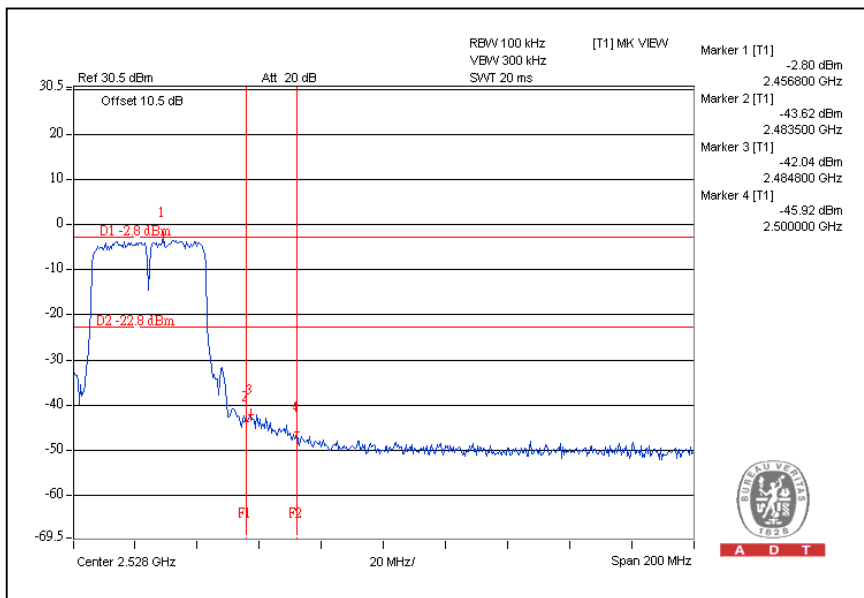



A D T

CH1

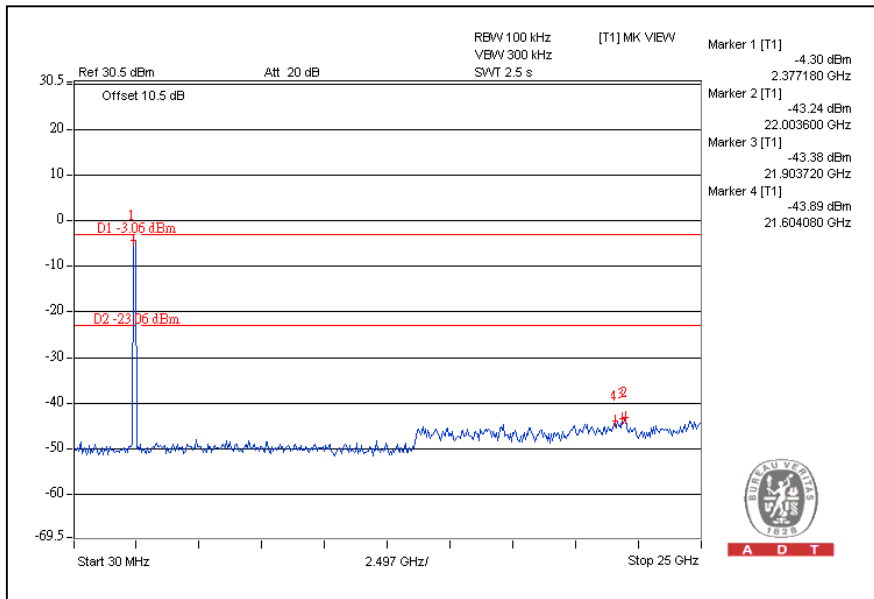

CH7

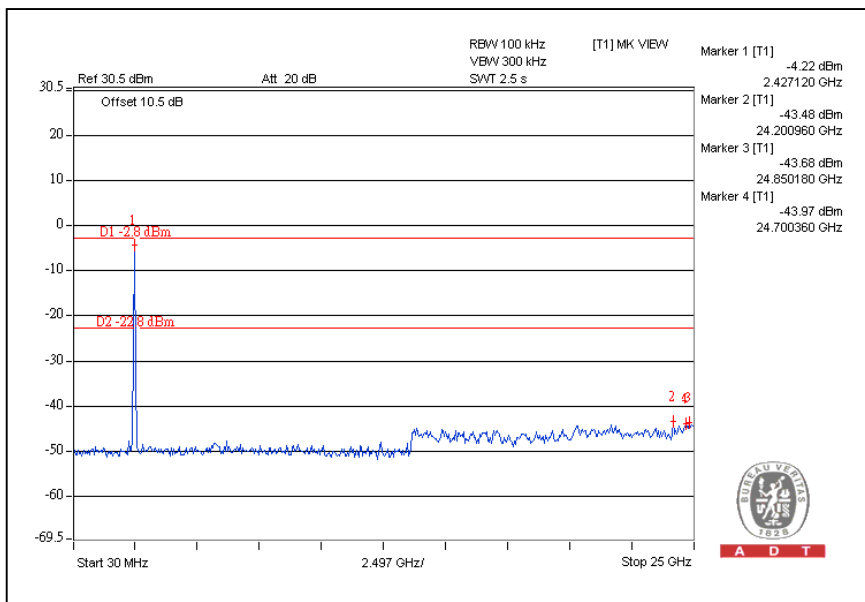



5. INFORMATION ON THE TESTING LABORATORIES

We, Bureau Veritas Consumer Products Services (H.K.) Ltd., Taoyuan Branch, were founded in 1988 to provide our best service in EMC, Radio, Telecom and Safety consultation. Our laboratories are accredited and approved according to ISO/IEC 17025:

Copies of accreditation certificates of our laboratories obtained from approval agencies can be downloaded from our web site: www.adt.com.tw/index.5/phtml.

If you have any comments, please feel free to contact us at the following:

Linko EMC/RF Lab:

Tel: 886-2-26052180

Fax: 886-2-26052943

Hsin Chu EMC/RF Lab:

Tel: 886-3-5935343

Fax: 886-3-5935342

Hwa Ya EMC/RF/Safety/Telecom Lab:

Tel: 886-3-3183232

Fax: 886-3-3185050

Email: service@adt.com.tw

Web Site: www.adt.com.tw

The address and road map of all our labs can be found in our web site also.



A D T

6.APPENDIX A - MODIFICATIONS RECORDERS FOR ENGINEERING CHANGES TO THE EUT BY THE LAB

No any modifications are made to the EUT by the lab during the test.

--- END ---