



FCC TEST REPORT (15.407)

REPORT NO.: RF131021C14-1
MODEL NO.: NWA1123-AC
FCC ID: I88NWA1123AC
RECEIVED: Oct. 18, 2013
TESTED: Oct. 25 ~ Nov. 02, 2013
ISSUED: Nov. 11, 2013

APPLICANT: ZyXEL Communications Corporation

ADDRESS: No. 2, Gongye E. 9th Road, Hsinchu Science Park, Hsinchu, Taiwan, R.O.C

ISSUED BY: Bureau Veritas Consumer Products Services (H.K.) Ltd., Taoyuan Branch

LAB ADDRESS: No. 47, 14th Ling, Chia Pau Vil., Lin Kou Dist., New Taipei City, Taiwan, R.O.C.

TEST LOCATION: No. 19, Hwa Ya 2nd Rd, Wen Hwa Tsuen, Kwei Shan Hsiang, Taoyuan Hsien 333, Taiwan, R.O.C.

This report should not be used by the client to claim product certification, approval, or endorsement by TAF or any government agencies.



This report is for your exclusive use. Any copying or replication of this report to or for any other person or entity, or use of our name or trademark, is permitted only with our prior written permission. This report sets forth our findings solely with respect to the test samples identified herein. The results set forth in this report are not indicative or representative of the quality or characteristics of the lot from which a test sample was taken or any similar or identical product unless specifically and expressly noted. Our report includes all of the tests requested by you and the results thereof based upon the information that you provided to us. You have 60 days from date of issuance of this report to notify us of any material error or omission caused by our negligence, provided, however, that such notice shall be in writing and shall specifically address the issue you wish to raise. A failure to raise such issue within the prescribed time shall constitute your unqualified acceptance of the completeness of this report, the tests conducted and the correctness of the report contents. Unless specific mention, the uncertainty of measurement has been explicitly taken into account to declare the compliance or non-compliance to the specification.



TABLE OF CONTENTS

RELEASE CONTROL RECORD	4
1. CERTIFICATION	5
2. SUMMARY OF TEST RESULTS	6
2.1 MEASUREMENT UNCERTAINTY	6
3. GENERAL INFORMATION	7
3.1 GENERAL DESCRIPTION OF EUT	7
3.2 DESCRIPTION OF TEST MODES	8
3.2.1 TEST MODE APPLICABILITY AND TESTED CHANNEL DETAIL	9
3.3 DUTY CYCLE OF TEST SIGNAL	11
3.4 DESCRIPTION OF SUPPORT UNITS	15
3.4.1 CONFIGURATION OF SYSTEM UNDER TEST	15
3.5 GENERAL DESCRIPTION OF APPLIED STANDARDS	16
4. TEST TYPES AND RESULTS	17
4.1 RADIATED EMISSION AND BANDEDGE MEASUREMENT	17
4.1.1 LIMITS OF RADIATED EMISSION AND BANDEDGE MEASUREMENT	17
4.1.2 LIMITS OF UNWANTED EMISSION OUT OF THE RESTRICTED BANDS	17
4.1.3 TEST INSTRUMENTS	18
4.1.4 TEST PROCEDURES	19
4.1.5 DEVIATION FROM TEST STANDARD	19
4.1.6 TEST SETUP	20
4.1.7 EUT OPERATING CONDITION	21
4.1.8 TEST RESULTS	22
4.2 CONDUCTED EMISSION MEASUREMENT	33
4.2.1 LIMITS OF CONDUCTED EMISSION MEASUREMENT	33
4.2.2 TEST INSTRUMENTS	33
4.2.3 TEST PROCEDURES	34
4.2.4 DEVIATION FROM TEST STANDARD	34
4.2.5 TEST SETUP	34
4.2.6 EUT OPERATING CONDITIONS	34
4.2.7 TEST RESULTS	35
4.3 PEAK TRANSMIT POWER MEASUREMENT	39
4.3.1 LIMITS OF PEAK TRANSMIT POWER MEASUREMENT	39
4.3.2 TEST SETUP	39
4.3.3 TEST INSTRUMENTS	40
4.3.4 TEST PROCEDURE	40
4.3.5 DEVIATION FROM TEST STANDARD	41
4.3.6 EUT OPERATING CONDITIONS	41
4.3.7 TEST RESULTS	42
4.4 PEAK POWER SPECTRAL DENSITY MEASUREMENT	46
4.4.1 LIMITS OF PEAK POWER SPECTRAL DENSITY MEASUREMENT	46
4.4.2 TEST SETUP	46
4.4.3 TEST INSTRUMENTS	46
4.4.4 TEST PROCEDURES	46
4.4.5 DEVIATION FROM TEST STANDARD	46
4.4.6 EUT OPERATING CONDITIONS	46
4.4.7 TEST RESULTS	47
4.5 PEAK POWER EXCURSION MEASUREMENT	50
4.5.1 LIMITS OF PEAK POWER EXCURSION MEASUREMENT	50
4.5.2 TEST SETUP	50



4.5.3	TEST INSTRUMENTS	50
4.5.4	TEST PROCEDURE	50
4.5.5	DEVIATION FROM TEST STANDARD	51
4.5.6	EUT OPERATING CONDITIONS.....	51
4.5.7	TEST RESULTS.....	52
4.6	FREQUENCY STABILITY	54
4.6.1	LIMITS OF FREQUENCY STABILITY MEASUREMENT	54
4.6.2	TEST SETUP	54
4.6.3	TEST INSTRUMENTS	54
4.6.4	TEST PROCEDURE	55
4.6.5	DEVIATION FROM TEST STANDARD	55
4.6.6	EUT OPERATING CONDITION	55
4.6.7	TEST RESULTS.....	56
5.	PHOTOGRAPHS OF THE TEST CONFIGURATION	57
6.	INFORMATION ON THE TESTING LABORATORIES.....	58
7.	APPENDIX A – MODIFICATIONS RECORDERS FOR ENGINEERING CHANGES TO THE EUT BY THE LAB	59



A D T

RELEASE CONTROL RECORD

ISSUE NO.	REASON FOR CHANGE	DATE ISSUED
RF131021C14-1	Original release	Nov. 11, 2013



1. CERTIFICATION

PRODUCT: 802.11 a/b/g/n/ac Dual-Radio Ceiling Mount PoE Access Point

MODEL: NWA1123-AC

BRAND: ZyXEL

APPLICANT: ZyXEL Communications Corporation

TESTED: Oct. 25 ~ Nov. 02, 2013

TEST SAMPLE: ENGINEERING SAMPLE

STANDARDS: FCC Part 15, Subpart E (Section 15.407)

ANSI C63.10-2009

The above equipment (model: NWA1123-AC) has been tested by **Bureau Veritas Consumer Products Services (H.K.) Ltd., Taoyuan Branch**, and found compliance with the requirement of the above standards. The test record, data evaluation & Equipment Under Test (EUT) configurations represented herein are true and accurate accounts of the measurements of the sample's EMC characteristics under the conditions specified in this report.

PREPARED BY :  , **DATE :** Nov. 11, 2013

Pettie Chen / Senior Specialist

APPROVED BY :  , **DATE :** Nov. 11, 2013

Ken Liu / Senior Manager

2. SUMMARY OF TEST RESULTS

The EUT has been tested according to the following specifications:

APPLIED STANDARD: FCC PART 15, SUBPART E (SECTION 15.407)			
STANDARD SECTION	TEST TYPE	RESULT	REMARK
15.407(b)(6)	AC Power Conducted Emission	PASS	Meet the requirement of limit. Minimum passing margin is -4.20dB at 0.34286MHz.
15.407(b/1/2/3)(b)(6)	Radiated Emissions	PASS	Meet the requirement of limit. Minimum passing margin is -1.2dB at 600.38, 625.60MHz.
15.407(a/1/2)	Max Average Transmit Power	PASS	Meet the requirement of limit.
15.407(a)(6)	Peak Power Excursion	PASS	Meet the requirement of limit.
15.407(a/1/2)	Peak Power Spectral Density	PASS	Meet the requirement of limit.
15.407(g)	Frequency Stability	PASS	Meet the requirement of limit.
15.203	Antenna Requirement	PASS	Antenna connector is I-PEX not a standard connector.

2.1 MEASUREMENT UNCERTAINTY

Where relevant, the following measurement uncertainty levels have been estimated for tests performed on the EUT as specified in CISPR 16-4-2:

MEASUREMENT	FREQUENCY	UNCERTAINTY
Conducted emissions	9kHz~30MHz	2.44 dB
Radiated emissions	30MHz ~ 200MHz	3.19 dB
	200MHz ~1000MHz	3.21 dB
	1GHz ~ 18GHz	2.26 dB
	18GHz ~ 40GHz	1.94 dB

This uncertainty represents an expanded uncertainty expressed at approximately the 95% confidence level using a coverage factor of $k = 2$.

3. GENERAL INFORMATION

3.1 GENERAL DESCRIPTION OF EUT

EUT	802.11 a/b/g/n/ac Dual-Radio Ceiling Mount PoE Access Point
MODEL NO.	NWA1123-AC
POWER SUPPLY	12Vdc from adapter 55Vdc from POE
MODULATION TYPE	256QAM, 64QAM, 16QAM, QPSK, BPSK
MODULATION TECHNOLOGY	OFDM
TRANSFER RATE	802.11a: 54.0/ 48.0/ 36.0/ 24.0/ 18.0/ 12.0/ 9.0/ 6.0Mbps 802.11n: up to 300.0Mbps 802.11ac: up to 867Mbps
OPERATING FREQUENCY	5150 ~ 5250MHz
NUMBER OF CHANNEL	4 for 802.11a, 802.11n (20MHz) 2 for 802.11n (40MHz) 1 for 802.11ac (80MHz)
OUTPUT POWER	33.432mW
ANTENNA TYPE	Printed antenna with 4.9dBi gain
ANTENNA CONNECTOR	I-PEX
DATA CABLE	NA
I/O PORTS	Refer to user's manual
ACCESSORY DEVICES	Adapter

NOTE:

- The EUT incorporates a MIMO function. Physically, the EUT provides two completed transmitters and two receivers.

MODULATION MODE	TX FUNCTION
802.11a	2TX
802.11n (20MHz)	2TX
802.11n (40MHz)	2TX
802.11ac (80MHz)	2TX

- The EUT consumes power from the following adapter or PoE.

ADAPTER	
BRAND:	DVE
MODEL:	DSA-12CA-12 120100
INPUT:	100-240Vac, 50/60Hz, 0.3A
OUTPUT:	+12Vdc, 1A
POWER LINE:	DC 1.5m non-shielded cable without core attached on adapter



POE (Support Unit only)	
BRAND	PowerDsine™
MODEL	9001G-40/SP
INPUT POWER	100-240Vac, 50-60Hz, 1.5A
OUTPUT POWER	55Vdc, 0.73A

3. The above EUT information is declared by manufacturer and for more detailed features description, please refer to the manufacturer's specifications or user's manual.

3.2 DESCRIPTION OF TEST MODES

4 channels are provided for 802.11a, 802.11n (20MHz):

CHANNEL	FREQUENCY	CHANNEL	FREQUENCY
36	5180MHz	44	5220MHz
40	5200MHz	48	5240MHz

2 channels are provided for 802.11n (40MHz):

CHANNEL	FREQUENCY	CHANNEL	FREQUENCY
38	5190MHz	46	5230MHz

1 channel is provided for 802.11ac (80MHz):

CHANNEL	FREQUENCY
42	5210MHz

3.2.1 TEST MODE APPLICABILITY AND TESTED CHANNEL DETAIL

EUT CONFIGURE MODE	APPLICABLE TO				DESCRIPTION
	RE≥1G	RE<1G	PLC	APCM	
A	√	√	√	√	Power from adapter
B	-	√	√	-	Power from PoE

Where **RE≥1G**: Radiated Emission above 1GHz **RE<1G**: Radiated Emission below 1GHz
PLC: Power Line Conducted Emission **APCM**: Antenna Port Conducted Measurement

NOTE:

1. The EUT had been pre-tested on the positioned of each X & Z axis. The worst case was found when positioned on **Z-plane**.
2. "-" means no effect.

RADIATED EMISSION TEST (ABOVE 1GHz):

- Pre-Scan has been conducted to determine the worst-case mode from all possible combinations between available modulations, data rates and antenna ports (if EUT with antenna diversity architecture).
- Following channel(s) was (were) selected for the final test as listed below.

EUT CONFIGURE MODE	MODE	AVAILABLE CHANNEL	TESTED CHANNEL	MODULATION TECHNOLOGY	MODULATION TYPE	DATA RATE (Mbps)
A	802.11a	36 to 48	36, 40, 48	OFDM	BPSK	6.0
A	802.11n (20MHz)	36 to 48	36, 40, 48	OFDM	BPSK	7.2
A	802.11n (40MHz)	38 to 46	38, 46	OFDM	BPSK	15.0
A	802.11ac (80MHz)	42	42	OFDM	BPSK	65.0

RADIATED EMISSION TEST (BELOW 1GHz):

- Pre-Scan has been conducted to determine the worst-case mode from all possible combinations between available modulations, data rates and antenna ports (if EUT with antenna diversity architecture).
- Following channel(s) was (were) selected for the final test as listed below.

EUT CONFIGURE MODE	MODE	AVAILABLE CHANNEL	TESTED CHANNEL	MODULATION TECHNOLOGY	MODULATION TYPE	DATA RATE (Mbps)
A, B	802.11n (20MHz)	36 to 48	36	OFDM	BPSK	7.2

POWER LINE CONDUCTED EMISSION TEST:

- Pre-Scan has been conducted to determine the worst-case mode from all possible combinations between available modulations, data rates and antenna ports (if EUT with antenna diversity architecture).
- Following channel(s) was (were) selected for the final test as listed below.

EUT CONFIGURE MODE	MODE	AVAILABLE CHANNEL	TESTED CHANNEL	MODULATION TECHNOLOGY	MODULATION TYPE	DATA RATE (Mbps)
A, B	802.11n (20MHz)	36 to 48	36	OFDM	BPSK	7.2

ANTENNA PORT CONDUCTED MEASUREMENT:

- This item includes all test value of each mode, but only includes spectrum plot of worst value of each mode.
- Pre-Scan has been conducted to determine the worst-case mode from all possible combinations between available modulations, data rates and antenna ports (if EUT with antenna diversity architecture).
- Following channel(s) was (were) selected for the final test as listed below.

EUT CONFIGURE MODE	MODE	AVAILABLE CHANNEL	TESTED CHANNEL	MODULATION TECHNOLOGY	MODULATION TYPE	DATA RATE (Mbps)
A	802.11a	36 to 48	36, 40, 48	OFDM	BPSK	6.0
A	802.11n (20MHz)	36 to 48	36, 40, 48	OFDM	BPSK	7.2
A	802.11n (40MHz)	38 to 46	38, 46	OFDM	BPSK	15.0
A	802.11ac (80MHz)	42	42	OFDM	BPSK	65.0

TEST CONDITION:

APPLICABLE TO	ENVIRONMENTAL CONDITIONS	INPUT POWER	TESTED BY
RE≥1G	25deg. C, 69%RH	120Vac, 60Hz	Alan Wu
RE<1G	25deg. C, 69%RH	120Vac, 60Hz	Alan Wu
PLC	24deg. C, 64%RH	120Vac, 60Hz	Match Tsui
APCM	24deg. C, 64%RH	120Vac, 60Hz	Match Tsui

3.3 DUTY CYCLE OF TEST SIGNAL

MODULATION TYPE: BPSK

If duty cycle is < 98%, duty factor shall be considered.

802.11a: Duty cycle = $2.028/2.086 = 0.972$, Duty factor = $10 * \log(1/0.972) = 0.12$

802.11n (20MHz): Duty cycle = $1.887/1.947 = 0.969$, Duty factor = $10 * \log(1/0.969) = 0.14$

802.11n (40MHz): Duty cycle = $0.927/0.987 = 0.939$, Duty factor = $10 * \log(1/0.939) = 0.27$

802.11ac (80MHz): Duty cycle = $0.454/0.511 = 0.888$, Duty factor = $10 * \log(1/0.888) = 0.51$

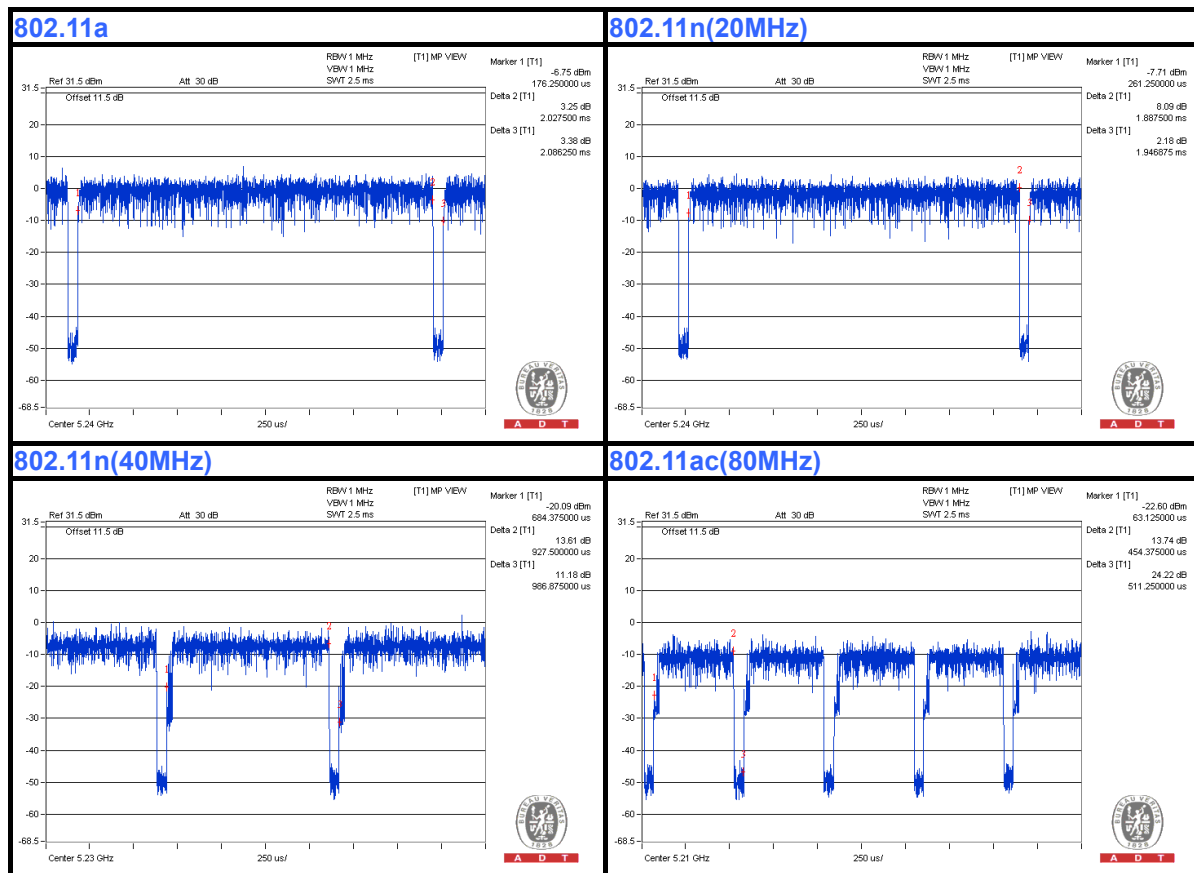



A D T

MODULATION TYPE: QPSK

802.11a: Duty cycle = $1.022/1.081 = 0.945$, Duty factor = $10 * \log(1/0.945) = 0.24$

802.11n (20MHz): Duty cycle = $0.961/1.019 = 0.943$, Duty factor = $10 * \log(1/0.943) = 0.25$

802.11n (40MHz): Duty cycle = $0.483/0.542 = 0.891$, Duty factor = $10 * \log(1/0.891) = 0.50$

802.11ac (80MHz): Duty cycle = $0.247/0.304 = 0.813$, Duty factor = $10 * \log(1/0.813) = 0.90$

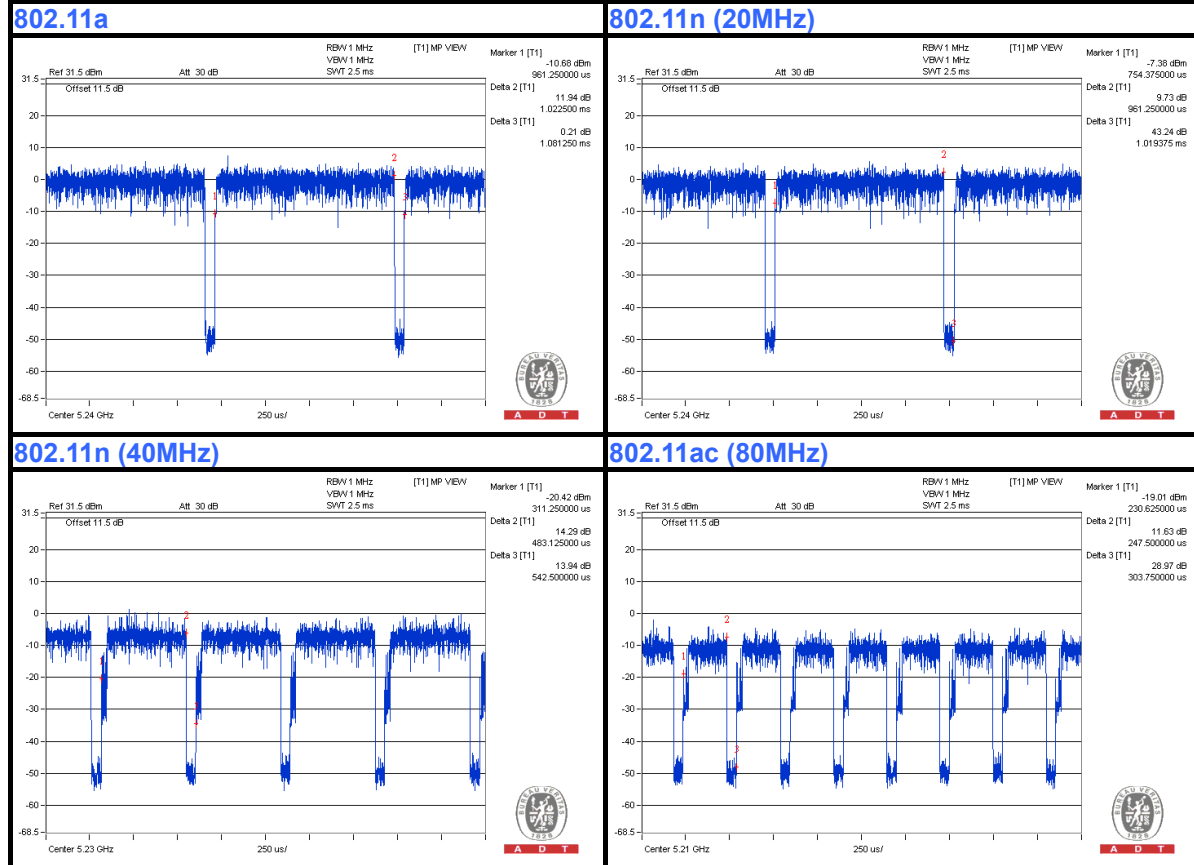



A D T

MODULATION TYPE: 16QAM

802.11a: Duty cycle = $0.524/0.579 = 0.905$, Duty factor = $10 * \log(1/0.905) = 0.43$

802.11n (20MHz): Duty cycle = $0.499/0.556 = 0.897$, Duty factor = $10 * \log(1/0.897) = 0.47$

802.11n (40MHz): Duty cycle = $0.482/0.540 = 0.893$, Duty factor = $10 * \log(1/0.893) = 0.49$

802.11ac (80MHz): Duty cycle = $0.144/0.199 = 0.724$, Duty factor = $10 * \log(1/0.724) = 1.40$

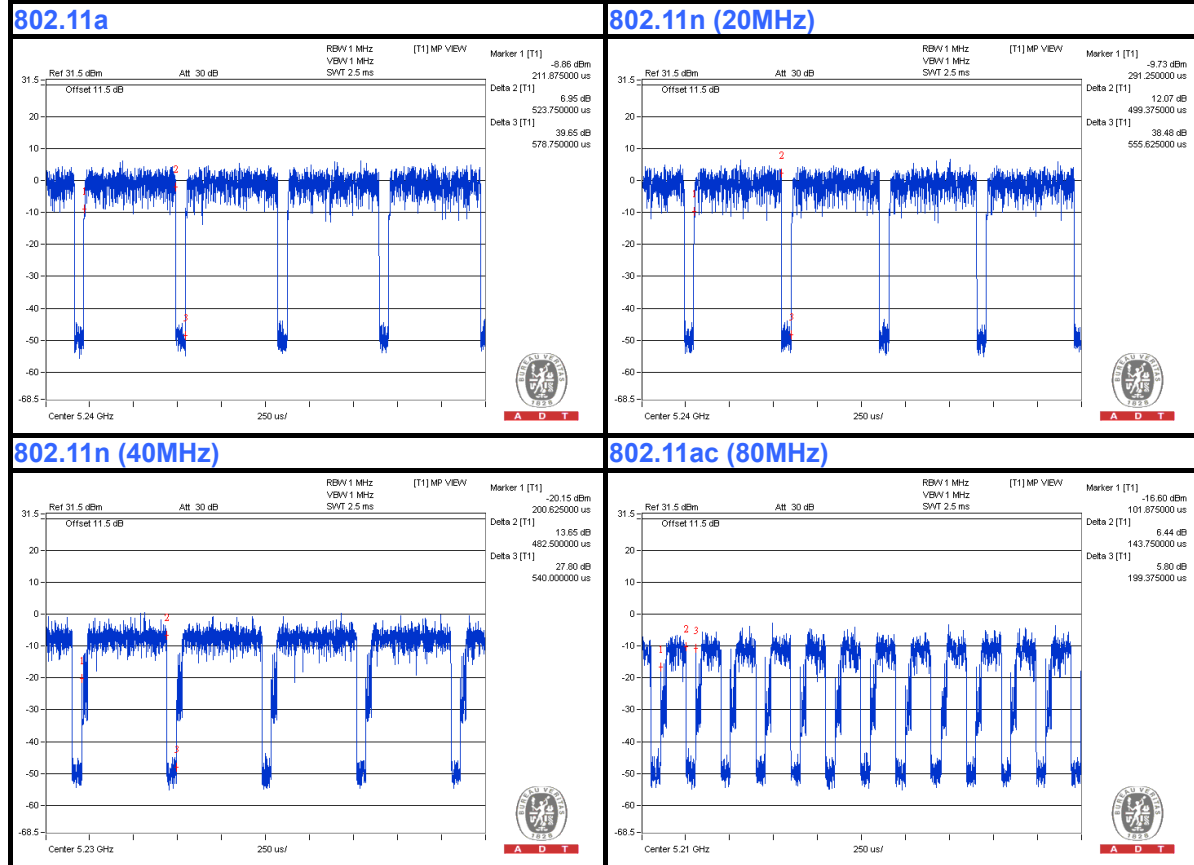



A D T

MODULATION TYPE: 64QAM

802.11a: Duty cycle = 0.271/0.326 = 0.831, Duty factor = $10 * \log(1/0.831) = 0.80$

802.11n (20MHz): Duty cycle = 0.267/0.324 = 0.824, Duty factor = $10 * \log(1/0.824) = 0.84$

802.11n (40MHz): Duty cycle = 0.148/0.204 = 0.725, Duty factor = $10 * \log(1/0.725) = 1.39$

802.11ac (80MHz): Duty cycle = 0.028/0.084 = 0.333, Duty factor = $10 * \log(1/0.333) = 4.77$

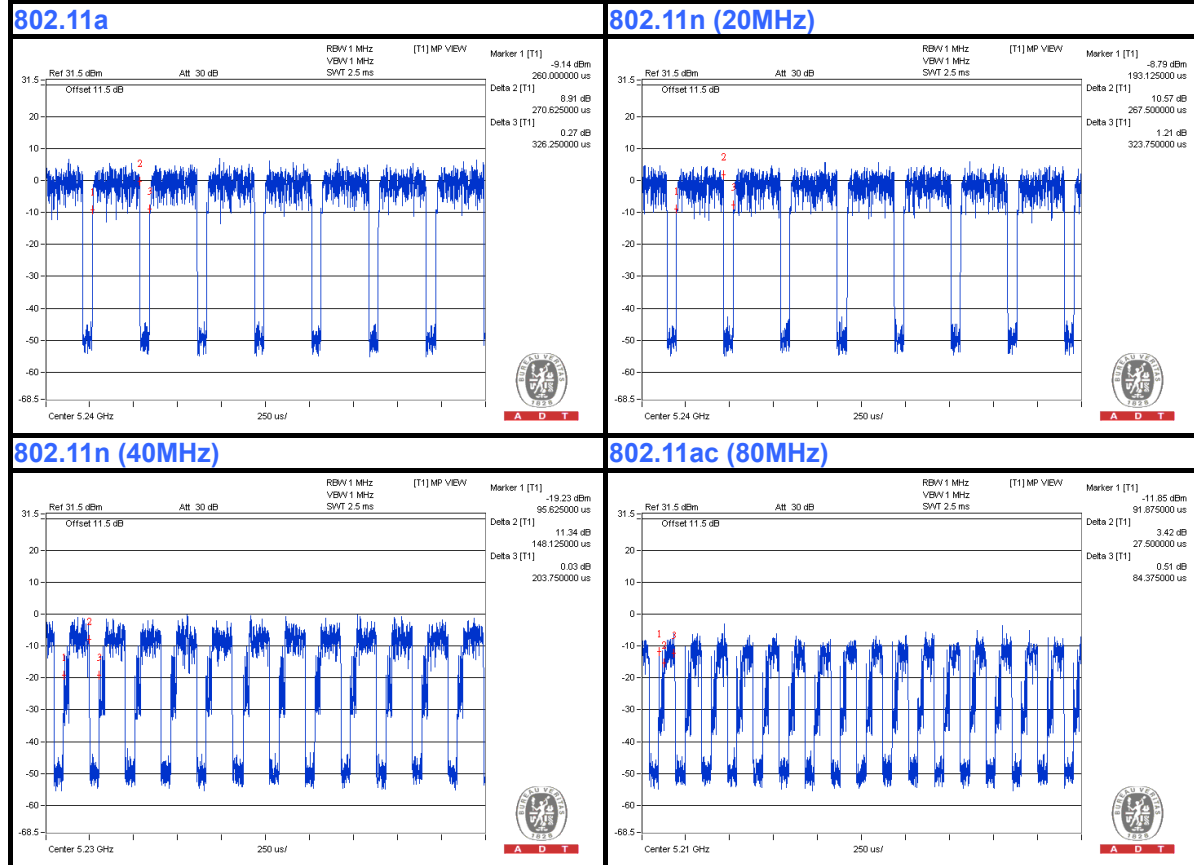

MODULATION TYPE: 256QAM

802.11ac (80MHz): Duty cycle = 0.076/0.13 = 0.576, Duty factor = $10 * \log(1/0.576) = 2.40$

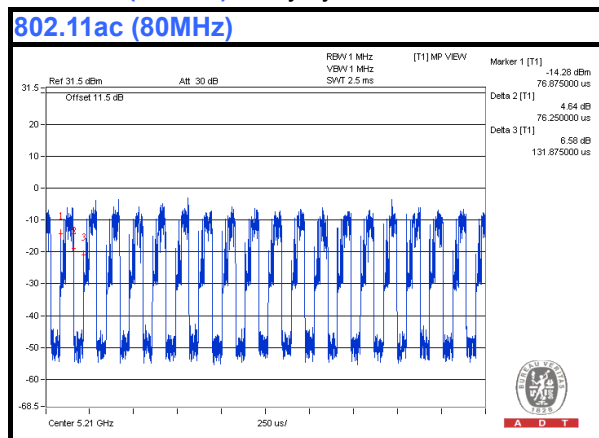

3.4 DESCRIPTION OF SUPPORT UNITS

The EUT has been tested as an independent unit together with other necessary accessories or support units. The following support units or accessories were used to form a representative test configuration during the tests.

NO.	PRODUCT	BRAND	MODEL NO.	SERIAL NO.	FCC ID
1	Notebook	DELL	E5410	1HC2XM1	FCC DoC Approved

NO.	SIGNAL CABLE DESCRIPTION OF THE ABOVE SUPPORT UNITS
1	10m RJ45 Cable.

NOTE:

1. All power cords of the above support units are non shielded (1.8m).
2. Item 1 acted as communication partner to transfer data.

3.4.1 CONFIGURATION OF SYSTEM UNDER TEST

Test Mode A

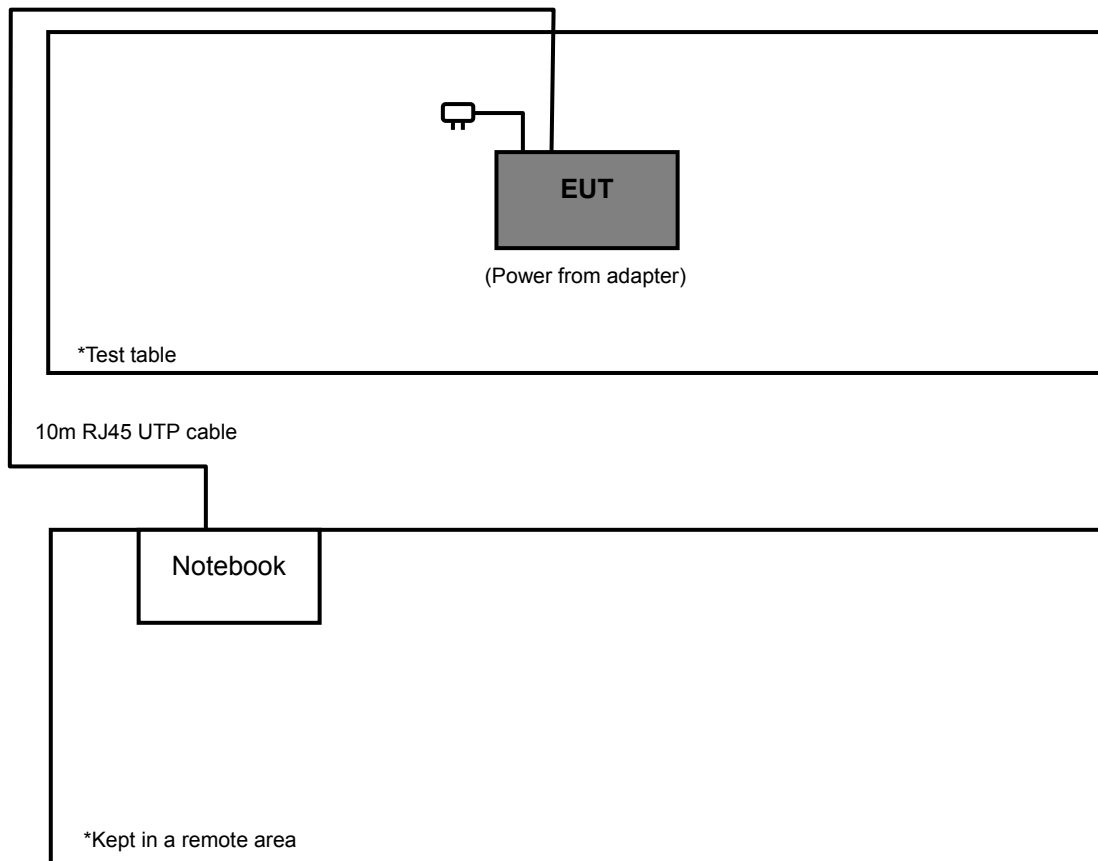

Test Mode B

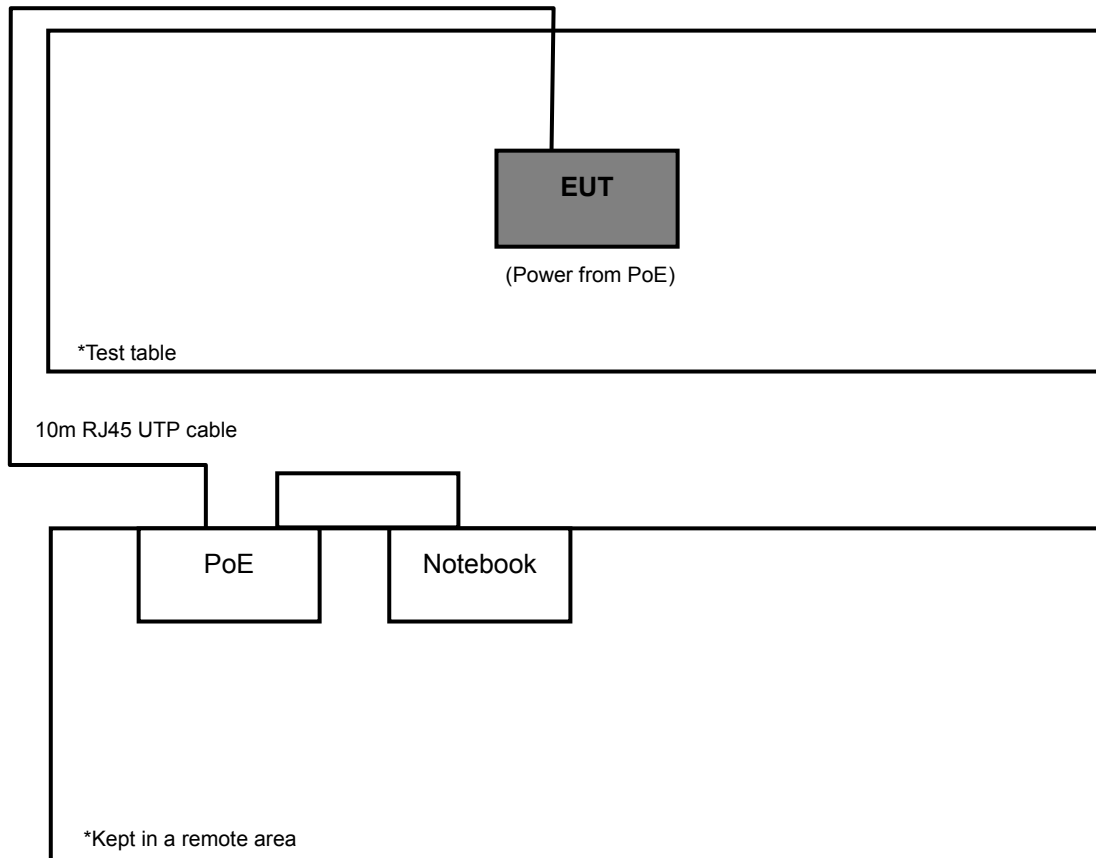

3.5 GENERAL DESCRIPTION OF APPLIED STANDARDS

The EUT is a RF Product. According to the specifications of the manufacturer, it must comply with the requirements of the following standards:

FCC Part 15, Subpart E (15.407)

789033 D01 General UNII Test Procedures v01 r03

662911 D01 Multiple Transmitter Output v02

ANSI C63.10-2009

All test items have been performed and recorded as per the above standards.

NOTE: The EUT is also considered as a kind of computer peripheral, because the connection to computer is necessary for typical use. It has been verified to comply with the requirements of FCC Part 15, Subpart B, Class B (DoC). The test report has been issued separately.

4. TEST TYPES AND RESULTS

4.1 RADIATED EMISSION AND BANDEDGE MEASUREMENT

4.1.1 LIMITS OF RADIATED EMISSION AND BANDEDGE MEASUREMENT

Radiated emissions which fall in the restricted bands must comply with the radiated emission limits specified as below table:

FREQUENCIES (MHz)	FIELD STRENGTH (microvolts/meter)	MEASUREMENT DISTANCE (meters)
0.009 ~ 0.490	2400/F(kHz)	300
0.490 ~ 1.705	24000/F(kHz)	30
1.705 ~ 30.0	30	30
30 ~ 88	100	3
88 ~ 216	150	3
216 ~ 960	200	3
Above 960	500	3

NOTE:

1. The lower limit shall apply at the transition frequencies.
2. Emission level (dBuV/m) = 20 log Emission level (uV/m).
3. For frequencies above 1000MHz, the field strength limits are based on average detector, however, the peak field strength of any emission shall not exceed the maximum permitted average limits, specified above by more than 20dB under any condition of modulation.

4.1.2 LIMITS OF UNWANTED EMISSION OUT OF THE RESTRICTED BANDS

APPLICABLE TO	LIMIT	
√	FIELD STRENGTH AT 3m (dBμV/m)	
	PK	AV
	74	54
	EIRP LIMIT (dBm)	EQUIVALENT FIELD STRENGTH AT 3m (dBμV/m)
	PK	PK
	-27	68.3

NOTE: The following formula is used to convert the equipment isotropic radiated power (eirp) to field strength:

$$E = \frac{1000000\sqrt{30P}}{3} \mu\text{V/m, where P is the eirp (Watts).}$$



4.1.3 TEST INSTRUMENTS

DESCRIPTION & MANUFACTURER	MODEL NO.	SERIAL NO.	DATE OF CALIBRATION	DUE DATE OF CALIBRATION
Test Receiver ROHDE & SCHWARZ	ESCI	100424	Sep. 09, 2013	Sep. 08, 2014
Spectrum Analyzer ROHDE & SCHWARZ	FSP40	100039	Jan. 31, 2013	Jan. 30, 2014
BILOG Antenna SCHWARZBECK	VULB9168	9168-155	Mar. 25, 2013	Mar. 24, 2014
HORN Antenna SCHWARZBECK	BBHA 9120D	9120D-404	Dec. 22, 2012	Dec. 21, 2013
HORN Antenna SCHWARZBECK	BBHA 9170	148	Jul. 15, 2013	Jul. 14, 2014
Preamplifier Agilent	8449B	3008A01910	Oct. 18, 2013	Oct. 17, 2014
Preamplifier Agilent	8447D	2944A10738	Oct. 18, 2013	Oct. 17, 2014
RF signal cable HUBER+SUHNNER	SUCOFLEX 104	309220/4	Aug. 26, 2013	Aug. 25, 2014
RF signal cable HUBER+SUHNNER	SUCOFLEX 104	250724/4	Aug. 26, 2013	Aug. 25, 2014
RF signal cable HUBER+SUHNNER	SUCOFLEX 104	295012/4	Aug. 26, 2013	Aug. 25, 2014
Software BV ADT	ADT_Radiated_ V7.6.15.9.4	NA	NA	NA
Antenna Tower inn-co GmbH	MA 4000	010303	NA	NA
Antenna Tower Controller inn-co GmbH	CO2000	019303	NA	NA
Turn Table BV ADT	TT100.	TT93021704	NA	NA
Turn Table Controller BV ADT	SC100.	SC93021704	NA	NA
26GHz ~ 40GHz Amplifier	EM26400	815221	Oct. 18, 2013	Oct. 17, 2014
High Speed Peak Power Meter	ML2495A	0842014	Apr. 25, 2013	Apr. 24, 2014
Power Sensor	MA2411B	0738404	Apr. 24, 2013	Apr. 23, 2014
WIT Standard temperature and humidity chamber	TH-4S-C	W981030	Jun. 10, 2013	Jun. 09, 2014

- NOTE:**
1. The calibration interval of the above test instruments is 12 months and the calibrations are traceable to NML/ROC and NIST/USA.
 2. The test was performed in HwaYa Chamber 3.
 3. The horn antenna and HP preamplifier (model: 8449B) are used only for the measurement of emission frequency above 1GHz if tested.
 4. The FCC Site Registration No. is 988962.
 5. The IC Site Registration No. is IC 7450F-3.

4.1.4 TEST PROCEDURES

- a. The EUT was placed on the top of a rotating table 0.8 meters above the ground at a 3 meter semi-anechoic chamber. The table was rotated 360 degrees to determine the position of the highest radiation.
- b. The EUT was set 3 meters away from the interference-receiving antenna, which was mounted on the top of a variable-height antenna tower.
- c. The antenna is a broadband antenna, and its height is varied from one meter to four meters above the ground to determine the maximum value of the field strength. Both horizontal and vertical polarizations of the antenna are set to make the measurement.
- d. For each suspected emission, the EUT was arranged to its worst case and then the antenna was tuned to heights from 1 meter to 4 meters and the rotatable table was turned from 0 degrees to 360 degrees to find the maximum reading.
- e. The test-receiver system was set to Peak Detect Function and Specified Bandwidth with Maximum Hold Mode.
- f. If the emission level of the EUT in peak mode was 10dB lower than the limit specified, then testing could be stopped and the peak values of the EUT would be reported. Otherwise the emissions that did not have 10dB margin would be re-tested one by one using peak, quasi-peak or average method as specified and then reported in a data sheet.

NOTE:

1. The resolution bandwidth and video bandwidth of test receiver/spectrum analyzer is 120kHz for Quasi-peak detection at frequency below 1GHz.
2. The resolution bandwidth of test receiver/spectrum analyzer is 1MHz and video bandwidth is 3MHz for Peak detection at frequency above 1GHz.
3. The resolution bandwidth of test receiver/spectrum analyzer is 1MHz and the video bandwidth is $\geq 1/T$ (Duty cycle < 98%) or 10Hz (Duty cycle > 98%) for Average detection (AV) at frequency above 1GHz.
4. All modes of operation were investigated and the worst-case emissions are reported.

4.1.5 DEVIATION FROM TEST STANDARD

No deviation.

4.1.6 TEST SETUP

Frequency range 30MHz~1GHz

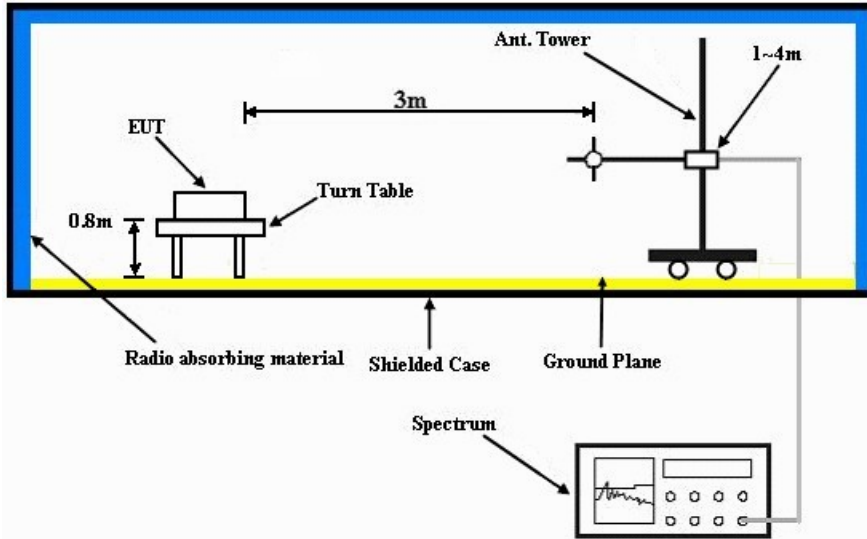

Frequency range above 1GHz

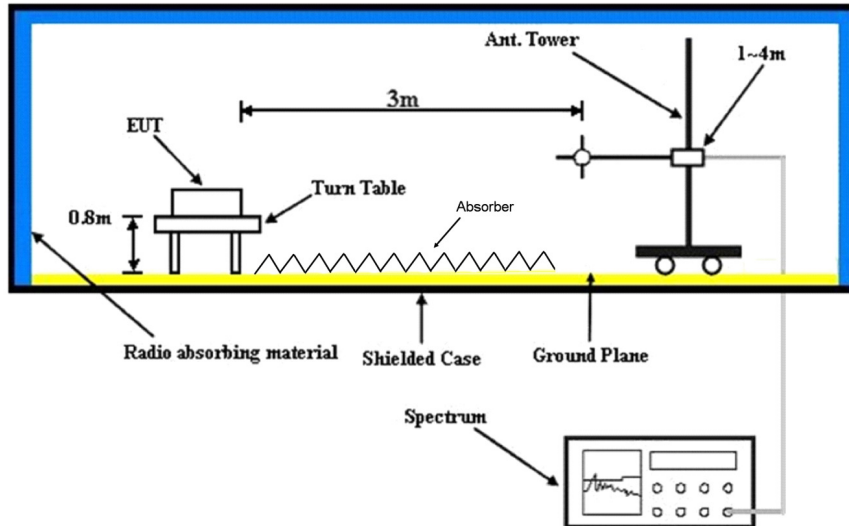

For the actual test configuration, please refer to the attached file (Test Setup Photo).

4.1.7 EUT OPERATING CONDITION

- a. Placed the EUT on the testing table.
- b. Prepared notebook to act as communication partner and placed it outside of testing area.
- c. The communication partner connected with EUT via a RJ45 cable and ran a test program (provided by manufacturer) to enable EUT under transmission condition continuously at specific channel frequency.
- d. The communication partner sent data to EUT by command "PING".

4.1.8 TEST RESULTS

ABOVE 1GHz DATA :

802.11a

EUT TEST CONDITION		MEASUREMENT DETAIL	
CHANNEL	Channel 36	FREQUENCY RANGE	1 ~ 40GHz
INPUT POWER (SYSTEM)	120Vac, 60 Hz	DETECTOR FUNCTION	Peak (PK) Average (AV)
ENVIRONMENTAL CONDITIONS	27deg. C, 65%RH	TESTED BY	Alan Wu

ANTENNA POLARITY & TEST DISTANCE: HORIZONTAL AT 3 M								
NO.	FREQ. (MHz)	EMISSION LEVEL (dBuV/m)	LIMIT (dBuV/m)	MARGIN (dB)	ANTENNA HEIGHT (m)	TABLE ANGLE (Degree)	RAW VALUE (dBuV)	CORRECTION FACTOR (dB/m)
1	5150.00	56.3 PK	74.0	-17.7	1.42 H	285	50.90	5.40
2	5150.00	43.6 AV	54.0	-10.4	1.42 H	285	38.20	5.40
3	*5180.00	107.3 PK			1.46 H	284	68.00	39.30
4	*5180.00	96.1 AV			1.46 H	284	56.80	39.30
5	#10360.00	58.3 PK	74.0	-15.7	1.00 H	307	42.30	16.00
6	#10360.00	45.3 AV	54.0	-8.7	1.00 H	307	29.30	16.00
ANTENNA POLARITY & TEST DISTANCE: VERTICAL AT 3 M								
NO.	FREQ. (MHz)	EMISSION LEVEL (dBuV/m)	LIMIT (dBuV/m)	MARGIN (dB)	ANTENNA HEIGHT (m)	TABLE ANGLE (Degree)	RAW VALUE (dBuV)	CORRECTION FACTOR (dB/m)
1	5150.00	56.7 PK	74.0	-17.3	1.56 V	353	51.30	5.40
2	5150.00	44.2 AV	54.0	-9.8	1.56 V	353	38.80	5.40
3	*5180.00	107.6 PK			1.53 V	355	68.30	39.30
4	*5180.00	97.8 AV			1.53 V	355	58.50	39.30
5	#10360.00	58.5 PK	74.0	-15.5	1.00 V	6	42.50	16.00
6	#10360.00	45.8 AV	54.0	-8.2	1.00 V	6	29.80	16.00

REMARKS:

1. Emission Level(dBuV/m) = Raw Value(dBuV) + Correction Factor(dB/m)
2. Correction Factor(dB/m) = Antenna Factor(dB/m) + Cable Factor(dB)
– Pre-Amplifier Factor(dB)
3. The other emission levels were very low against the limit.
4. Margin value = Emission Level – Limit value
5. “ * “: Fundamental frequency.
6. “#”:The radiated frequency is out the restricted band.



A D T

EUT TEST CONDITION		MEASUREMENT DETAIL	
CHANNEL	Channel 40	FREQUENCY RANGE	1 ~ 40GHz
INPUT POWER (SYSTEM)	120Vac, 60 Hz	DETECTOR FUNCTION	Peak (PK) Average (AV)
ENVIRONMENTAL CONDITIONS	27deg. C, 65%RH	TESTED BY	Alan Wu

ANTENNA POLARITY & TEST DISTANCE: HORIZONTAL AT 3 M								
NO.	FREQ. (MHz)	EMISSION LEVEL (dBuV/m)	LIMIT (dBuV/m)	MARGIN (dB)	ANTENNA HEIGHT (m)	TABLE ANGLE (Degree)	RAW VALUE (dBuV)	CORRECTION FACTOR (dB/m)
1	*5200.00	106.8 PK			1.46 H	257	67.50	39.30
2	*5200.00	95.9 AV			1.46 H	257	56.60	39.30
3	#10400.00	59.0 PK	74.0	-15.0	1.01 H	301	42.80	16.20
4	#10400.00	45.4 AV	54.0	-8.6	1.01 H	301	29.20	16.20
ANTENNA POLARITY & TEST DISTANCE: VERTICAL AT 3 M								
NO.	FREQ. (MHz)	EMISSION LEVEL (dBuV/m)	LIMIT (dBuV/m)	MARGIN (dB)	ANTENNA HEIGHT (m)	TABLE ANGLE (Degree)	RAW VALUE (dBuV)	CORRECTION FACTOR (dB/m)
1	*5200.00	107.7 PK			1.08 V	357	68.40	39.30
2	*5200.00	97.7 AV			1.08 V	357	58.40	39.30
3	#10400.00	59.1 PK	74.0	-14.9	1.00 V	5	42.90	16.20
4	#10400.00	45.9 AV	54.0	-8.1	1.00 V	5	29.70	16.20

REMARKS:

1. Emission Level(dBuV/m) = Raw Value(dBuV) + Correction Factor(dB/m)
2. Correction Factor(dB/m) = Antenna Factor(dB/m) + Cable Factor(dB)
– Pre-Amplifier Factor(dB)
3. The other emission levels were very low against the limit.
4. Margin value = Emission Level – Limit value
5. “ * “: Fundamental frequency.
6. “#”:The radiated frequency is out the restricted band.



A D T

EUT TEST CONDITION		MEASUREMENT DETAIL	
CHANNEL	Channel 48	FREQUENCY RANGE	1 ~ 40GHz
INPUT POWER (SYSTEM)	120Vac, 60 Hz	DETECTOR FUNCTION	Peak (PK) Average (AV)
ENVIRONMENTAL CONDITIONS	27deg. C, 65%RH	TESTED BY	Alan Wu

ANTENNA POLARITY & TEST DISTANCE: HORIZONTAL AT 3 M								
NO.	FREQ. (MHz)	EMISSION LEVEL (dBuV/m)	LIMIT (dBuV/m)	MARGIN (dB)	ANTENNA HEIGHT (m)	TABLE ANGLE (Degree)	RAW VALUE (dBuV)	CORRECTION FACTOR (dB/m)
1	*5240.00	106.6 PK			1.44 H	284	67.30	39.30
2	*5240.00	95.6 AV			1.44 H	284	56.30	39.30
3	5350.00	56.0 PK	74.0	-18.0	1.46 H	282	50.50	5.50
4	5350.00	43.2 AV	54.0	-10.8	1.46 H	282	37.70	5.50
5	#10480.00	57.5 PK	74.0	-16.5	1.00 H	304	40.70	16.80
6	#10480.00	44.3 AV	54.0	-9.7	1.00 H	304	27.50	16.80
ANTENNA POLARITY & TEST DISTANCE: VERTICAL AT 3 M								
NO.	FREQ. (MHz)	EMISSION LEVEL (dBuV/m)	LIMIT (dBuV/m)	MARGIN (dB)	ANTENNA HEIGHT (m)	TABLE ANGLE (Degree)	RAW VALUE (dBuV)	CORRECTION FACTOR (dB/m)
1	*5240.00	107.6 PK			1.19 V	2	68.30	39.30
2	*5240.00	97.7 AV			1.19 V	2	58.40	39.30
3	5350.00	56.4 PK	74.0	-17.6	1.19 V	6	50.90	5.50
4	5350.00	43.9 AV	54.0	-10.1	1.19 V	6	38.40	5.50
5	#10480.00	58.0 PK	74.0	-16.0	1.00 V	15	41.20	16.80
6	#10480.00	44.9 AV	54.0	-9.1	1.00 V	15	28.10	16.80

REMARKS:

1. Emission Level(dBuV/m) = Raw Value(dBuV) + Correction Factor(dB/m)
2. Correction Factor(dB/m) = Antenna Factor(dB/m) + Cable Factor(dB) – Pre-Amplifier Factor(dB)
3. The other emission levels were very low against the limit.
4. Margin value = Emission Level – Limit value
5. " * ": Fundamental frequency.
6. "#":The radiated frequency is out the restricted band.



A D T

802.11n (20MHz)

EUT TEST CONDITION		MEASUREMENT DETAIL	
CHANNEL	Channel 36	FREQUENCY RANGE	1 ~ 40GHz
INPUT POWER (SYSTEM)	120Vac, 60 Hz	DETECTOR FUNCTION	Peak (PK) Average (AV)
ENVIRONMENTAL CONDITIONS	27deg. C, 65%RH	TESTED BY	Alan Wu

ANTENNA POLARITY & TEST DISTANCE: HORIZONTAL AT 3 M								
NO.	FREQ. (MHz)	EMISSION LEVEL (dBuV/m)	LIMIT (dBuV/m)	MARGIN (dB)	ANTENNA HEIGHT (m)	TABLE ANGLE (Degree)	RAW VALUE (dBuV)	CORRECTION FACTOR (dB/m)
1	5150.00	57.2 PK	74.0	-16.8	1.42 H	288	51.80	5.40
2	5150.00	43.7 AV	54.0	-10.3	1.42 H	288	38.30	5.40
3	*5180.00	106.9 PK			1.46 H	282	67.60	39.30
4	*5180.00	95.8 AV			1.46 H	282	56.50	39.30
5	#10360.00	57.5 PK	74.0	-16.5	1.00 H	306	41.50	16.00
6	#10360.00	44.4 AV	54.0	-9.6	1.00 H	306	28.40	16.00

ANTENNA POLARITY & TEST DISTANCE: VERTICAL AT 3 M								
NO.	FREQ. (MHz)	EMISSION LEVEL (dBuV/m)	LIMIT (dBuV/m)	MARGIN (dB)	ANTENNA HEIGHT (m)	TABLE ANGLE (Degree)	RAW VALUE (dBuV)	CORRECTION FACTOR (dB/m)
1	5150.00	57.6 PK	74.0	-16.4	1.57 V	353	52.20	5.40
2	5150.00	44.3 AV	54.0	-9.7	1.57 V	353	38.90	5.40
3	*5180.00	107.9 PK			1.53 V	354	68.60	39.30
4	*5180.00	97.6 AV			1.53 V	354	58.30	39.30
5	#10360.00	58.7 PK	74.0	-15.3	1.00 V	10	42.70	16.00
6	#10360.00	45.9 AV	54.0	-8.1	1.00 V	10	29.90	16.00

REMARKS:

1. Emission Level(dBuV/m) = Raw Value(dBuV) + Correction Factor(dB/m)
2. Correction Factor(dB/m) = Antenna Factor(dB/m) + Cable Factor(dB)
– Pre-Amplifier Factor(dB)
3. The other emission levels were very low against the limit.
4. Margin value = Emission Level – Limit value
5. “ * “: Fundamental frequency.
6. “#” :The radiated frequency is out the restricted band.



EUT TEST CONDITION		MEASUREMENT DETAIL	
CHANNEL	Channel 40	FREQUENCY RANGE	1 ~ 40GHz
INPUT POWER (SYSTEM)	120Vac, 60 Hz	DETECTOR FUNCTION	Peak (PK) Average (AV)
ENVIRONMENTAL CONDITIONS	27deg. C, 65%RH	TESTED BY	Alan Wu

ANTENNA POLARITY & TEST DISTANCE: HORIZONTAL AT 3 M								
NO.	FREQ. (MHz)	EMISSION LEVEL (dBuV/m)	LIMIT (dBuV/m)	MARGIN (dB)	ANTENNA HEIGHT (m)	TABLE ANGLE (Degree)	RAW VALUE (dBuV)	CORRECTION FACTOR (dB/m)
1	*5200.00	106.2 PK			1.46 H	254	66.90	39.30
2	*5200.00	95.6 AV			1.46 H	254	56.30	39.30
3	#10400.00	58.0 PK	74.0	-16.0	1.00 H	307	41.80	16.20
4	#10400.00	45.2 AV	54.0	-8.8	1.00 H	307	29.00	16.20
ANTENNA POLARITY & TEST DISTANCE: VERTICAL AT 3 M								
NO.	FREQ. (MHz)	EMISSION LEVEL (dBuV/m)	LIMIT (dBuV/m)	MARGIN (dB)	ANTENNA HEIGHT (m)	TABLE ANGLE (Degree)	RAW VALUE (dBuV)	CORRECTION FACTOR (dB/m)
1	*5200.00	107.3 PK			1.11 V	357	68.00	39.30
2	*5200.00	97.3 AV			1.11 V	357	58.00	39.30
3	#10400.00	58.2 PK	74.0	-15.8	1.00 V	12	42.00	16.20
4	#10400.00	45.7 AV	54.0	-8.3	1.00 V	12	29.50	16.20

REMARKS:

1. Emission Level(dBuV/m) = Raw Value(dBuV) + Correction Factor(dB/m)
2. Correction Factor(dB/m) = Antenna Factor(dB/m) + Cable Factor(dB) – Pre-Amplifier Factor(dB)
3. The other emission levels were very low against the limit.
4. Margin value = Emission Level – Limit value
5. “ * “: Fundamental frequency.
6. “#”:The radiated frequency is out the restricted band.



A D T

EUT TEST CONDITION		MEASUREMENT DETAIL	
CHANNEL	Channel 48	FREQUENCY RANGE	1 ~ 40GHz
INPUT POWER (SYSTEM)	120Vac, 60 Hz	DETECTOR FUNCTION	Peak (PK) Average (AV)
ENVIRONMENTAL CONDITIONS	27deg. C, 65%RH	TESTED BY	Alan Wu

ANTENNA POLARITY & TEST DISTANCE: HORIZONTAL AT 3 M								
NO.	FREQ. (MHz)	EMISSION LEVEL (dBuV/m)	LIMIT (dBuV/m)	MARGIN (dB)	ANTENNA HEIGHT (m)	TABLE ANGLE (Degree)	RAW VALUE (dBuV)	CORRECTION FACTOR (dB/m)
1	*5240.00	105.5 PK			1.45 H	283	66.20	39.30
2	*5240.00	94.8 AV			1.45 H	283	55.50	39.30
3	5350.00	56.5 PK	74.0	-17.5	1.42 H	286	51.00	5.50
4	5350.00	43.5 AV	54.0	-10.5	1.42 H	286	38.00	5.50
5	#10480.00	57.2 PK	74.0	-16.8	1.00 H	308	40.40	16.80
6	#10480.00	45.1 AV	54.0	-8.9	1.00 H	308	28.30	16.80
ANTENNA POLARITY & TEST DISTANCE: VERTICAL AT 3 M								
NO.	FREQ. (MHz)	EMISSION LEVEL (dBuV/m)	LIMIT (dBuV/m)	MARGIN (dB)	ANTENNA HEIGHT (m)	TABLE ANGLE (Degree)	RAW VALUE (dBuV)	CORRECTION FACTOR (dB/m)
1	*5240.00	108.0 PK			1.19 V	0	68.70	39.30
2	*5240.00	97.6 AV			1.19 V	0	58.30	39.30
3	5350.00	56.9 PK	74.0	-17.1	1.12 V	8	51.40	5.50
4	5350.00	44.0 AV	54.0	-10.0	1.12 V	8	38.50	5.50
5	#10480.00	57.5 PK	74.0	-16.5	1.00 V	16	40.70	16.80
6	#10480.00	45.6 AV	54.0	-8.4	1.00 V	16	28.80	16.80

REMARKS:

1. Emission Level(dBuV/m) = Raw Value(dBuV) + Correction Factor(dB/m)
2. Correction Factor(dB/m) = Antenna Factor(dB/m) + Cable Factor(dB) – Pre-Amplifier Factor(dB)
3. The other emission levels were very low against the limit.
4. Margin value = Emission Level – Limit value
5. " * ": Fundamental frequency.
6. "#":The radiated frequency is out the restricted band.



802.11n (40MHz)

EUT TEST CONDITION		MEASUREMENT DETAIL	
CHANNEL	Channel 38	FREQUENCY RANGE	1 ~ 40GHz
INPUT POWER (SYSTEM)	120Vac, 60 Hz	DETECTOR FUNCTION	Peak (PK) Average (AV)
ENVIRONMENTAL CONDITIONS	27deg. C, 65%RH	TESTED BY	Alan Wu

ANTENNA POLARITY & TEST DISTANCE: HORIZONTAL AT 3 M								
NO.	FREQ. (MHz)	EMISSION LEVEL (dBuV/m)	LIMIT (dBuV/m)	MARGIN (dB)	ANTENNA HEIGHT (m)	TABLE ANGLE (Degree)	RAW VALUE (dBuV)	CORRECTION FACTOR (dB/m)
1	5150.00	58.1 PK	74.0	-15.9	1.49 H	250	52.70	5.40
2	5150.00	44.1 AV	54.0	-9.9	1.49 H	250	38.70	5.40
3	*5190.00	103.1 PK			1.47 H	255	63.80	39.30
4	*5190.00	92.7 AV			1.47 H	255	53.40	39.30
5	#10380.00	57.0 PK	74.0	-17.0	1.00 H	309	40.90	16.10
6	#10380.00	44.2 AV	54.0	-9.8	1.00 H	309	28.10	16.10

ANTENNA POLARITY & TEST DISTANCE: VERTICAL AT 3 M								
NO.	FREQ. (MHz)	EMISSION LEVEL (dBuV/m)	LIMIT (dBuV/m)	MARGIN (dB)	ANTENNA HEIGHT (m)	TABLE ANGLE (Degree)	RAW VALUE (dBuV)	CORRECTION FACTOR (dB/m)
1	5150.00	58.3 PK	74.0	-15.7	1.53 V	354	52.90	5.40
2	5150.00	45.6 AV	54.0	-8.4	1.53 V	354	40.20	5.40
3	*5190.00	104.8 PK			1.56 V	356	65.50	39.30
4	*5190.00	94.7 AV			1.56 V	356	55.40	39.30
5	#10380.00	58.0 PK	74.0	-16.0	1.00 V	7	41.90	16.10
6	#10380.00	44.8 AV	54.0	-9.2	1.00 V	7	28.70	16.10

REMARKS:

1. Emission Level(dBuV/m) = Raw Value(dBuV) + Correction Factor(dB/m)
2. Correction Factor(dB/m) = Antenna Factor(dB/m) + Cable Factor(dB) – Pre-Amplifier Factor(dB)
3. The other emission levels were very low against the limit.
4. Margin value = Emission Level – Limit value
5. “ * “: Fundamental frequency.
6. “#”:The radiated frequency is out the restricted band.



A D T

EUT TEST CONDITION		MEASUREMENT DETAIL	
CHANNEL	Channel 46	FREQUENCY RANGE	1 ~ 40GHz
INPUT POWER (SYSTEM)	120Vac, 60 Hz	DETECTOR FUNCTION	Peak (PK) Average (AV)
ENVIRONMENTAL CONDITIONS	27deg. C, 65%RH	TESTED BY	Alan Wu

ANTENNA POLARITY & TEST DISTANCE: HORIZONTAL AT 3 M								
NO.	FREQ. (MHz)	EMISSION LEVEL (dBuV/m)	LIMIT (dBuV/m)	MARGIN (dB)	ANTENNA HEIGHT (m)	TABLE ANGLE (Degree)	RAW VALUE (dBuV)	CORRECTION FACTOR (dB/m)
1	*5230.00	102.3 PK			1.44 H	284	63.00	39.30
2	*5230.00	91.7 AV			1.44 H	284	52.40	39.30
3	5350.00	56.4 PK	74.0	-17.6	1.40 H	289	50.90	5.50
4	5350.00	42.8 AV	54.0	-11.2	1.40 H	289	37.30	5.50
5	#10460.00	56.1 PK	74.0	-17.9	1.00 H	299	39.50	16.60
6	#10460.00	44.1 AV	54.0	-9.9	1.00 H	299	27.50	16.60
ANTENNA POLARITY & TEST DISTANCE: VERTICAL AT 3 M								
NO.	FREQ. (MHz)	EMISSION LEVEL (dBuV/m)	LIMIT (dBuV/m)	MARGIN (dB)	ANTENNA HEIGHT (m)	TABLE ANGLE (Degree)	RAW VALUE (dBuV)	CORRECTION FACTOR (dB/m)
1	*5230.00	104.3 PK			1.08 V	359	65.00	39.30
2	*5230.00	93.7 AV			1.08 V	359	54.40	39.30
3	5350.00	57.8 PK	74.0	-16.2	1.04 V	356	52.30	5.50
4	5350.00	43.5 AV	54.0	-10.5	1.04 V	356	38.00	5.50
5	#10460.00	57.4 PK	74.0	-16.6	1.00 V	12	40.80	16.60
6	#10460.00	44.7 AV	54.0	-9.3	1.00 V	12	28.10	16.60

REMARKS:

1. Emission Level(dBuV/m) = Raw Value(dBuV) + Correction Factor(dB/m)
2. Correction Factor(dB/m) = Antenna Factor(dB/m) + Cable Factor(dB) – Pre-Amplifier Factor(dB)
3. The other emission levels were very low against the limit.
4. Margin value = Emission Level – Limit value
5. " * ": Fundamental frequency.
6. "#":The radiated frequency is out the restricted band.



802.11ac (80MHz)

EUT TEST CONDITION		MEASUREMENT DETAIL	
CHANNEL	Channel 42	FREQUENCY RANGE	1 ~ 40GHz
INPUT POWER (SYSTEM)	120Vac, 60 Hz	DETECTOR FUNCTION	Peak (PK) Average (AV)
ENVIRONMENTAL CONDITIONS	27deg. C, 65%RH	TESTED BY	Alan Wu

ANTENNA POLARITY & TEST DISTANCE: HORIZONTAL AT 3 M								
NO.	FREQ. (MHz)	EMISSION LEVEL (dBuV/m)	LIMIT (dBuV/m)	MARGIN (dB)	ANTENNA HEIGHT (m)	TABLE ANGLE (Degree)	RAW VALUE (dBuV)	CORRECTION FACTOR (dB/m)
1	5150.00	59.5 PK	74.0	-14.5	1.42 H	273	54.10	5.40
2	5150.00	47.2 AV	54.0	-6.8	1.42 H	273	41.80	5.40
3	*5210.00	98.6 PK			1.47 H	276	59.30	39.30
4	*5210.00	88.5 AV			1.47 H	276	49.20	39.30
5	#10420.00	56.2 PK	74.0	-17.8	1.00 H	305	39.80	16.40
6	#10420.00	43.5 AV	54.0	-10.5	1.00 H	305	27.10	16.40

ANTENNA POLARITY & TEST DISTANCE: VERTICAL AT 3 M								
NO.	FREQ. (MHz)	EMISSION LEVEL (dBuV/m)	LIMIT (dBuV/m)	MARGIN (dB)	ANTENNA HEIGHT (m)	TABLE ANGLE (Degree)	RAW VALUE (dBuV)	CORRECTION FACTOR (dB/m)
1	5150.00	60.0 PK	74.0	-14.0	1.00 V	346	54.60	5.40
2	5150.00	48.4 AV	54.0	-5.6	1.00 V	346	43.00	5.40
3	*5210.00	99.7 PK			1.00 V	350	60.40	39.30
4	*5210.00	90.1 AV			1.00 V	350	50.80	39.30
5	#10420.00	57.5 PK	74.0	-16.5	1.00 V	12	41.10	16.40
6	#10420.00	44.6 AV	54.0	-9.4	1.00 V	12	28.20	16.40

REMARKS:

1. Emission Level(dBuV/m) = Raw Value(dBuV) + Correction Factor(dB/m)
2. Correction Factor(dB/m) = Antenna Factor(dB/m) + Cable Factor(dB) – Pre-Amplifier Factor(dB)
3. The other emission levels were very low against the limit.
4. Margin value = Emission Level – Limit value
5. “ * “: Fundamental frequency.
6. “#”:The radiated frequency is out the restricted band.



A D T

BELOW 1GHz WORST-CASE DATA : 802.11n (20MHz)

EUT TEST CONDITION		MEASUREMENT DETAIL	
CHANNEL	Channel 36	FREQUENCY RANGE	Below 1000MHz
INPUT POWER (SYSTEM)	120Vac, 60 Hz	DETECTOR FUNCTION	Quasi-Peak
ENVIRONMENTAL CONDITIONS	24deg. C, 67%RH	TESTED BY	Alan Wu
TEST MODE	A		

ANTENNA POLARITY & TEST DISTANCE: HORIZONTAL AT 3 M								
NO.	FREQ. (MHz)	EMISSION LEVEL (dBuV/m)	LIMIT (dBuV/m)	MARGIN (dB)	ANTENNA HEIGHT (m)	TABLE ANGLE (Degree)	RAW VALUE (dBuV)	CORRECTION FACTOR (dB/m)
1	249.17	42.5 QP	46.0	-3.5	1.24 H	288	57.00	-14.50
2	375.29	43.8 QP	46.0	-2.2	1.00 H	122	55.10	-11.30
3	499.48	43.2 QP	46.0	-2.8	1.49 H	131	52.20	-9.00
4	600.38	44.8 QP	46.0	-1.2	1.25 H	153	51.80	-7.00
5	625.60	43.5 QP	46.0	-2.5	1.24 H	145	49.80	-6.30
6	751.73	41.4 QP	46.0	-4.6	1.00 H	150	45.10	-3.70
ANTENNA POLARITY & TEST DISTANCE: VERTICAL AT 3 M								
NO.	FREQ. (MHz)	EMISSION LEVEL (dBuV/m)	LIMIT (dBuV/m)	MARGIN (dB)	ANTENNA HEIGHT (m)	TABLE ANGLE (Degree)	RAW VALUE (dBuV)	CORRECTION FACTOR (dB/m)
1	35.72	36.7 QP	40.0	-3.3	1.00 V	135	51.40	-14.70
2	60.95	36.1 QP	40.0	-3.9	1.24 V	139	50.70	-14.60
3	375.29	41.8 QP	46.0	-4.2	1.00 V	213	53.10	-11.30
4	499.48	42.3 QP	46.0	-3.7	1.99 V	181	51.30	-9.00
5	625.60	42.2 QP	46.0	-3.8	1.49 V	290	48.50	-6.30
6	875.91	41.6 QP	46.0	-4.4	1.24 V	132	43.80	-2.20

REMARKS:

1. Emission Level(dBuV/m) = Raw Value(dBuV) + Correction Factor(dB/m)
2. Correction Factor(dB/m) = Antenna Factor(dB/m) + Cable Factor(dB) – Pre-Amplifier Factor (dB)
3. The other emission levels were very low against the limit.
4. Margin value = Emission Level – Limit value



A D T

EUT TEST CONDITION		MEASUREMENT DETAIL	
CHANNEL	Channel 36	FREQUENCY RANGE	Below 1000MHz
INPUT POWER (SYSTEM)	120Vac, 60 Hz	DETECTOR FUNCTION	Quasi-Peak
ENVIRONMENTAL CONDITIONS	24deg. C, 67%RH	TESTED BY	Alan Wu
TEST MODE	B		

ANTENNA POLARITY & TEST DISTANCE: HORIZONTAL AT 3 M								
NO.	FREQ. (MHz)	EMISSION LEVEL (dBuV/m)	LIMIT (dBuV/m)	MARGIN (dB)	ANTENNA HEIGHT (m)	TABLE ANGLE (Degree)	RAW VALUE (dBuV)	CORRECTION FACTOR (dB/m)
1	249.17	42.3 QP	46.0	-3.7	1.00 H	283	56.80	-14.50
2	375.29	41.1 QP	46.0	-4.9	1.24 H	13	52.40	-11.30
3	499.48	43.2 QP	46.0	-2.8	1.49 H	157	52.20	-9.00
4	600.38	41.2 QP	46.0	-4.8	1.00 H	158	48.20	-7.00
5	625.60	43.3 QP	46.0	-2.7	1.24 H	164	49.60	-6.30
6	751.73	44.3 QP	46.0	-1.7	1.00 H	160	48.00	-3.70

ANTENNA POLARITY & TEST DISTANCE: VERTICAL AT 3 M								
NO.	FREQ. (MHz)	EMISSION LEVEL (dBuV/m)	LIMIT (dBuV/m)	MARGIN (dB)	ANTENNA HEIGHT (m)	TABLE ANGLE (Degree)	RAW VALUE (dBuV)	CORRECTION FACTOR (dB/m)
1	35.72	38.3 QP	40.0	-1.7	1.00 V	179	53.00	-14.70
2	124.98	36.5 QP	43.5	-7.0	1.75 V	94	52.20	-15.70
3	499.48	44.3 QP	46.0	-1.7	1.00 V	180	53.30	-9.00
4	625.60	44.8 QP	46.0	-1.2	1.49 V	191	51.10	-6.30
5	749.79	39.9 QP	46.0	-6.1	1.24 V	176	43.80	-3.90
6	875.91	42.5 QP	46.0	-3.5	1.24 V	148	44.70	-2.20

REMARKS:

1. Emission Level(dBuV/m) = Raw Value(dBuV) + Correction Factor(dB/m)
2. Correction Factor(dB/m) = Antenna Factor(dB/m) + Cable Factor(dB)
 - Pre-Amplifier Factor (dB)
3. The other emission levels were very low against the limit.
4. Margin value = Emission Level – Limit value

4.2 CONDUCTED EMISSION MEASUREMENT

4.2.1 LIMITS OF CONDUCTED EMISSION MEASUREMENT

FREQUENCY OF EMISSION (MHz)	CONDUCTED LIMIT (dB μ V)	
	Quasi-peak	Average
0.15 ~ 0.5	66 to 56	56 to 46
0.5 ~ 5	56	46
5 ~ 30	60	50

- NOTE:**
1. The lower limit shall apply at the transition frequencies.
 2. The limit decreases in line with the logarithm of the frequency in the range of 0.15 to 0.50MHz.
 3. All emanations from a class A/B digital device or system, including any network of conductors and apparatus connected thereto, shall not exceed the level of field strengths specified above.

4.2.2 TEST INSTRUMENTS

DESCRIPTION & MANUFACTURER	MODEL NO.	SERIAL NO.	DATE OF CALIBRATION	DUE DATE OF CALIBRATION
Test Receiver ROHDE & SCHWARZ	ESCS30	100289	Nov. 16, 2012	Nov. 15, 2013
RF signal cable Woken	5D-FB	Cable-HYC01-01	Dec. 28, 2012	Dec. 27, 2013
LISN ROHDE & SCHWARZ (EUT)	ESH3-Z5	835239/001	Feb. 04, 2013	Feb. 03, 2014
LISN ROHDE & SCHWARZ (Peripheral)	ESH3-Z5	100312	Jul. 08, 2013	Jul. 07, 2014
Software ADT	BV ADT_Cond_ V7.3.7.3	NA	NA	NA

- NOTE:**
1. The calibration interval of the above test instruments is 12 months and the calibrations are traceable to NML/ROC and NIST/USA.
 2. The test was performed in HwaYa Shielded Room 2.
 3. The VCCI Site Registration No. is C-2047.

4.2.3 TEST PROCEDURES

- The EUT was placed 0.4 meters from the conducting wall of the shielded room with EUT being connected to the power mains through a line impedance stabilization network (LISN). Other support units were connected to the power mains through another LISN. The two LISNs provide 50 ohm/ 50uH of coupling impedance for the measuring instrument.
- Both lines of the power mains connected to the EUT were checked for maximum conducted interference.
- The frequency range from 150kHz to 30MHz was searched. Emission levels under (Limit - 20dB) was not recorded.

NOTE: All modes of operation were investigated and the worst-case emissions are reported.

4.2.4 DEVIATION FROM TEST STANDARD

No deviation.

4.2.5 TEST SETUP

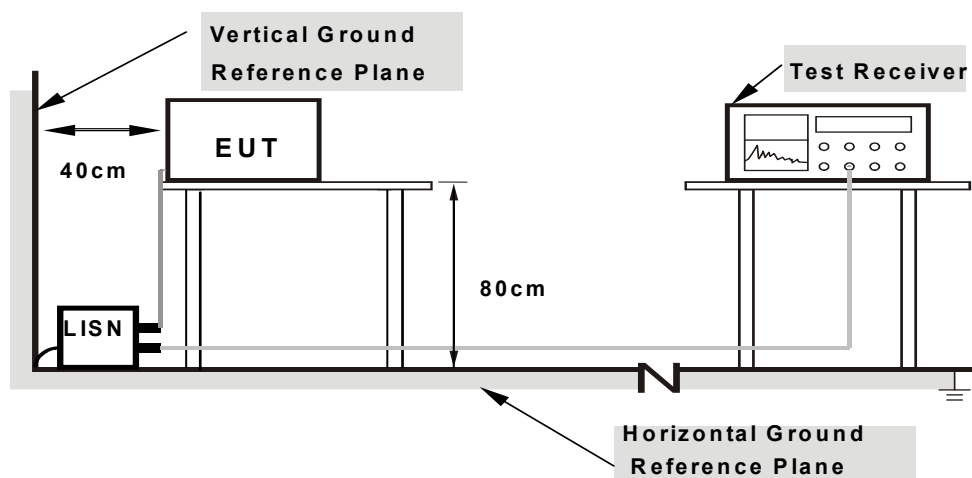

- Note:**
- Support units were connected to second LISN.
 - Both of LISNs (AMN) are 80 cm from EUT and at least 80 from other units and other metal planes

For the actual test configuration, please refer to the attached file (Test Setup Photo).

4.2.6 EUT OPERATING CONDITIONS

Same as 4.1.6.



4.2.7 TEST RESULTS

CONDUCTED WORST-CASE DATA : 802.11n (20MHz)

PHASE	Line 1	6dB BANDWIDTH	9kHz
TEST MODE	A		

No	Freq. [MHz]	Corr. Factor (dB)	Reading Value		Emission Level		Limit		Margin	
			[dB (uV)]		[dB (uV)]		[dB (uV)]		(dB)	
			Q.P.	AV.	Q.P.	AV.	Q.P.	AV.	Q.P.	AV.
1	0.22812	0.17	41.16	39.02	41.33	39.19	62.52	52.52	-21.19	-13.33
2	0.34286	0.21	45.46	44.72	45.67	44.93	59.13	49.13	-13.46	-4.20
3	0.53605	0.23	34.40	33.04	34.63	33.27	56.00	46.00	-21.37	-12.73
4	0.72440	0.24	32.37	31.13	32.61	31.37	56.00	46.00	-23.39	-14.63
5	3.59074	0.38	28.86	20.44	29.24	20.82	56.00	46.00	-26.76	-25.18
6	22.55859	1.36	20.25	14.37	21.61	15.73	60.00	50.00	-38.39	-34.27

- REMARKS:**
1. Q.P. and AV. are abbreviations of quasi-peak and average individually.
 2. The emission levels of other frequencies were very low against the limit.
 3. Margin value = Emission level - Limit value
 4. Correction factor = Insertion loss + Cable loss
 5. Emission Level = Correction Factor + Reading Value.

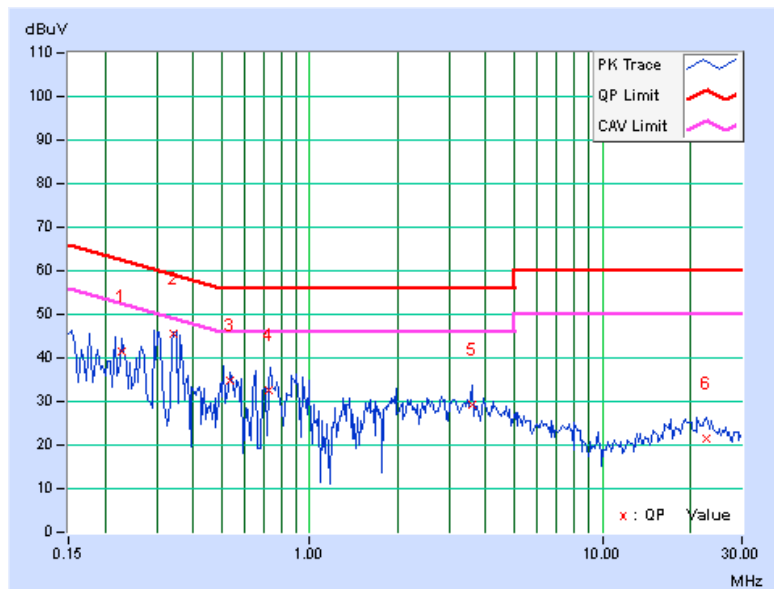

PHASE	Line 2	6dB BANDWIDTH	9kHz
TEST MODE	A		

No	Freq. [MHz]	Corr. Factor (dB)	Reading Value		Emission Level		Limit		Margin	
			[dB (uV)]		[dB (uV)]		[dB (uV)]		(dB)	
			Q.P.	AV.	Q.P.	AV.	Q.P.	AV.	Q.P.	AV.
1	0.22912	0.18	34.23	30.78	34.41	30.96	62.48	52.48	-28.07	-21.52
2	0.30625	0.21	42.96	42.06	43.17	42.27	60.07	50.07	-16.90	-7.80
3	0.49667	0.24	29.82	28.72	30.06	28.96	56.06	46.06	-25.99	-17.09
4	0.87628	0.25	34.42	29.74	34.67	29.99	56.00	46.00	-21.33	-16.01
5	2.09414	0.28	27.69	21.28	27.97	21.56	56.00	46.00	-28.03	-24.44
6	15.10938	0.76	13.47	7.78	14.23	8.54	60.00	50.00	-45.77	-41.46

- REMARKS:**
1. Q.P. and AV. are abbreviations of quasi-peak and average individually.
 2. The emission levels of other frequencies were very low against the limit.
 3. Margin value = Emission level - Limit value
 4. Correction factor = Insertion loss + Cable loss
 5. Emission Level = Correction Factor + Reading Value.

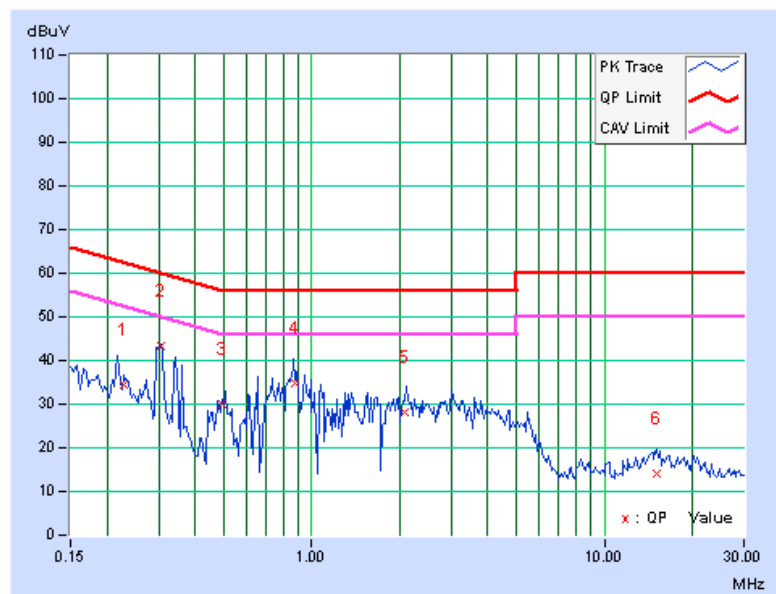



PHASE	Line 1	6dB BANDWIDTH	9kHz
TEST MODE	B		

No	Freq. [MHz]	Corr. Factor (dB)	Reading Value		Emission Level		Limit		Margin	
			[dB (uV)]		[dB (uV)]		[dB (uV)]		(dB)	
			Q.P.	AV.	Q.P.	AV.	Q.P.	AV.	Q.P.	AV.
1	0.15000	0.16	38.98	26.05	39.14	26.21	66.00	56.00	-26.86	-29.79
2	0.27228	0.19	36.10	26.56	36.29	26.75	61.05	51.05	-24.76	-24.30
3	0.98203	0.25	27.59	21.00	27.84	21.25	56.00	46.00	-28.16	-24.75
4	3.00391	0.35	30.69	21.76	31.04	22.11	56.00	46.00	-24.96	-23.89
5	10.53906	0.75	28.74	22.99	29.49	23.74	60.00	50.00	-30.51	-26.26
6	19.83594	1.22	34.20	33.35	35.42	34.57	60.00	50.00	-24.58	-15.43

- REMARKS:**
1. Q.P. and AV. are abbreviations of quasi-peak and average individually.
 2. The emission levels of other frequencies were very low against the limit.
 3. Margin value = Emission level - Limit value
 4. Correction factor = Insertion loss + Cable loss
 5. Emission Level = Correction Factor + Reading Value.

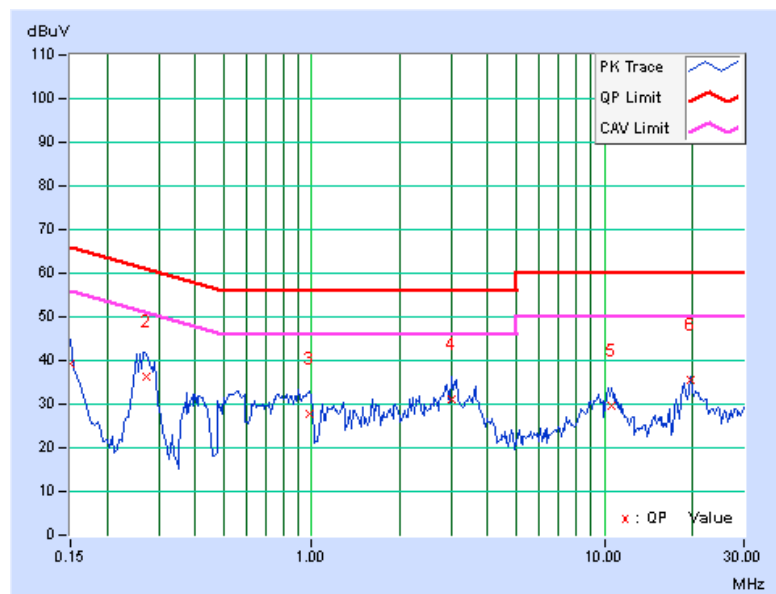

PHASE	Line 2	6dB BANDWIDTH	9kHz
TEST MODE	B		

No	Freq. [MHz]	Corr. Factor (dB)	Reading Value		Emission Level		Limit		Margin	
			[dB (uV)]		[dB (uV)]		[dB (uV)]		(dB)	
			Q.P.	AV.	Q.P.	AV.	Q.P.	AV.	Q.P.	AV.
1	0.15000	0.16	36.51	25.56	36.67	25.72	66.00	56.00	-29.33	-30.28
2	0.26583	0.19	32.17	23.75	32.36	23.94	61.25	51.25	-28.88	-27.30
3	0.40000	0.24	27.11	19.57	27.35	19.81	57.85	47.85	-30.50	-28.04
4	3.08984	0.33	30.74	22.42	31.07	22.75	56.00	46.00	-24.93	-23.25
5	10.04297	0.60	29.14	23.84	29.74	24.44	60.00	50.00	-30.26	-25.56
6	19.83203	0.92	33.28	30.62	34.20	31.54	60.00	50.00	-25.80	-18.46

- REMARKS:**
1. Q.P. and AV. are abbreviations of quasi-peak and average individually.
 2. The emission levels of other frequencies were very low against the limit.
 3. Margin value = Emission level - Limit value
 4. Correction factor = Insertion loss + Cable loss
 5. Emission Level = Correction Factor + Reading Value.

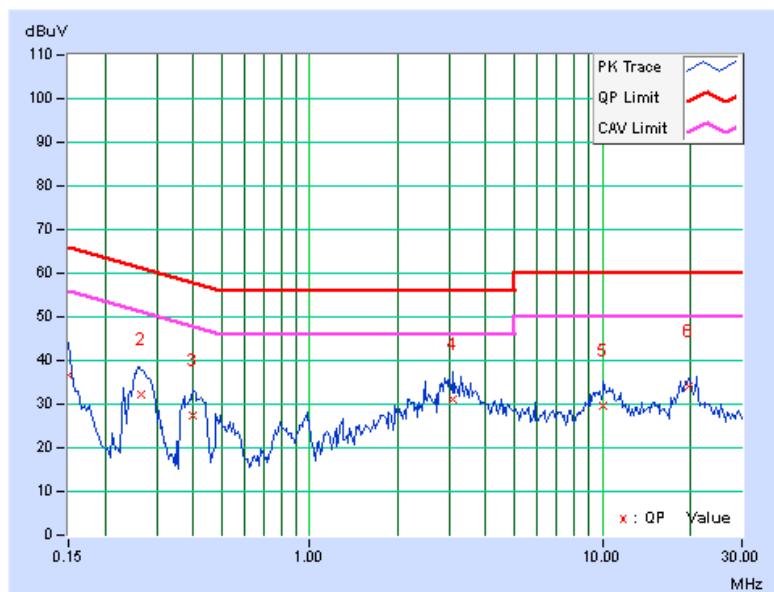

4.3 PEAK TRANSMIT POWER MEASUREMENT

4.3.1 LIMITS OF PEAK TRANSMIT POWER MEASUREMENT

FREQUENCY BAND	LIMIT
5.15 ~ 5.25GHz	The lesser of 50mW (17dBm) or 4dBm + 10logB

NOTE: Where B is the 26dB emission bandwidth in MHz.

Per KDB 662911 D01 Multiple Transmitter Output v02 Method of conducted output power measurement on IEEE 802.11 devices,

Array Gain = 0 dB (i.e., no array gain) for NANT ≤ 4;

Array Gain = 0 dB (i.e., no array gain) for channel widths ≥ 40 MHz for any NANT;

Array Gain = 5 log(NANT/NSS) dB or 3 dB, whichever is less for 20-MHz channel widths with NANT ≥ 5.

For power measurements on all other devices: Array Gain = 10 log(NANT/NSS) dB.

4.3.2 TEST SETUP

FOR POWER OUTPUT MEASUREMENT

For 802.11a, 802.11n (20MHz), 802.11n (40MHz)

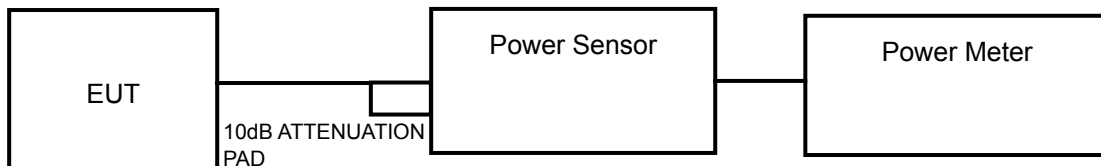

For 802.11ac (80MHz)

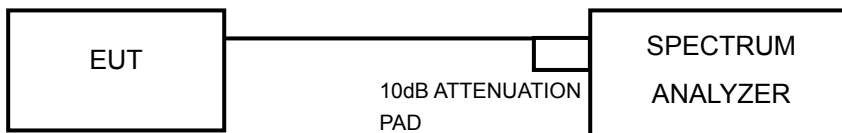

FOR 26dB BANDWIDTH

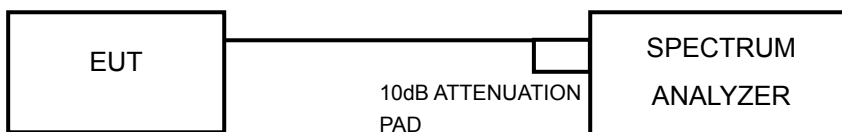

4.3.3 TEST INSTRUMENTS

Refer to section 4.1.3 to get information of above instrument.

4.3.4 TEST PROCEDURE

FOR AVERAGE POWER MEASUREMENT

For 802.11a, 802.11n (20MHz), 802.11n (40MHz)

Method PM is used to perform output power measurement, trigger and gating function of wide band power meter is enabled to measure max output power of TX on burst. Duty factor is not added to measured value.

For 802.11ac (80MHz)

This procedure may be used when the maximum available RBW of the measurement instrument is less than the DTS bandwidth.

- 1) Set the RBW = 1 MHz.
- 2) Set the VBW \geq 3 RBW.
- 3) Set the span \geq 1.5 x DTS bandwidth.
- 4) Detector = peak.
- 5) Sweep time = auto couple.
- 6) Trace mode = max hold.
- 7) Allow trace to fully stabilize.
- 8) Use the instrument's band/channel power measurement function with the band limits set equal to the DTS bandwidth edges (for some instruments, this may require a manual override to select peak detector). If the instrument does not have a band power function, sum the spectrum levels (in linear power units) at intervals equal to the RBW extending across the DTS bandwidth.

FOR 26dB BANDWIDTH

- 1) Set RBW = approximately 1% of the emission bandwidth.
- 2) Set the VBW > RBW.
- 3) Detector = Peak.
- 4) Trace mode = max hold.
- 5) Measure the maximum width of the emission that is 26 dB down from the peak of the emission. Compare this with the RBW setting of the analyzer. Readjust RBW and repeat measurement as needed until the RBW/EBW ratio is approximately 1%.

4.3.5 DEVIATION FROM TEST STANDARD

No deviation.

4.3.6 EUT OPERATING CONDITIONS

The software provided by client to enable the EUT under transmission condition continuously at specific channel frequencies individually.



4.3.7 TEST RESULTS

POWER OUTPUT:

802.11a

CHAN.	FREQ. (MHz)	AVERAGE POWER (dBm)		TOTAL POWER (mW)	TOTAL POWER (dBm)	POWER LIMIT (dBm)	PASS / FAIL
		CHAIN 0	CHAIN 1				
36	5180	11.74	12.57	33.000	15.19	16.97	PASS
40	5200	11.84	12.13	31.607	15.00	16.96	PASS
48	5240	12.34	11.65	31.762	15.02	16.99	PASS

NOTE:

CHAIN 0

- 1. $4\text{dBm} + 10\log(19.89) = 16.99\text{dBm} < 17\text{dBm}$.
- 2. $4\text{dBm} + 10\log(19.82) = 16.97\text{dBm} < 17\text{dBm}$.
- 3. $4\text{dBm} + 10\log(20.09) = 17.03\text{dBm} > 17\text{dBm}$.

CHAIN 1

- 1. $4\text{dBm} + 10\log(19.80) = 16.97\text{dBm} < 17\text{dBm}$.
- 2. $4\text{dBm} + 10\log(19.78) = 16.96\text{dBm} < 17\text{dBm}$.
- 3. $4\text{dBm} + 10\log(19.89) = 16.99\text{dBm} < 17\text{dBm}$.

802.11n (20MHz)

CHAN.	FREQ. (MHz)	AVERAGE POWER (dBm)		TOTAL POWER (mW)	TOTAL POWER (dBm)	POWER LIMIT (dBm)	PASS / FAIL
		CHAIN 0	CHAIN 1				
36	5180	11.55	12.82	33.432	15.24	17	PASS
40	5200	11.88	12.35	32.596	15.13	17	PASS
48	5240	12.55	11.66	32.644	15.14	17	PASS

NOTE:

CHAIN 0

- 1. $4\text{dBm} + 10\log(21.46) = 17.32\text{dBm} > 17\text{dBm}$.
- 2. $4\text{dBm} + 10\log(20.89) = 17.20\text{dBm} > 17\text{dBm}$.
- 3. $4\text{dBm} + 10\log(21.29) = 17.28\text{dBm} > 17\text{dBm}$.

CHAIN 1

- 1. $4\text{dBm} + 10\log(21.27) = 17.28\text{dBm} > 17\text{dBm}$.
- 2. $4\text{dBm} + 10\log(20.40) = 17.10\text{dBm} > 17\text{dBm}$.
- 3. $4\text{dBm} + 10\log(21.48) = 17.32\text{dBm} > 17\text{dBm}$.



802.11n (40MHz)

CHAN.	FREQ. (MHz)	AVERAGE POWER (dBm)		TOTAL POWER (mW)	TOTAL POWER (dBm)	POWER LIMIT (dBm)	PASS / FAIL
		CHAIN 0	CHAIN 1				
38	5190	11.60	12.39	31.792	15.02	17	PASS
46	5230	12.21	11.84	31.910	15.04	17	PASS

NOTE:

CHAIN 0

- 1. $4\text{dBm} + 10\log(46.07) = 20.63\text{dBm} > 17\text{dBm}$.
- 2. $4\text{dBm} + 10\log(47.39) = 20.76\text{dBm} > 17\text{dBm}$.

CHAIN 1

- 1. $4\text{dBm} + 10\log(47.23) = 20.74\text{dBm} > 17\text{dBm}$.
- 2. $4\text{dBm} + 10\log(45.66) = 20.60\text{dBm} > 17\text{dBm}$.

802.11ac (80MHz)

CHAN.	FREQ. (MHz)	AVERAGE POWER (dBm)		TOTAL POWER (mW)	TOTAL POWER (dBm)	POWER LIMIT (dBm)	PASS / FAIL
		CHAIN 0	CHAIN 1				
42	5210	11.82	11.93	30.801	14.89	17	PASS

NOTE:

CHAIN 0

- 1. $4\text{dBm} + 10\log(89.93) = 23.54\text{dBm} > 17\text{dBm}$.

CHAIN 1

- 1. $4\text{dBm} + 10\log(88.28) = 23.46\text{dBm} > 17\text{dBm}$.



26dB BANDWIDTH:

802.11a

CHANNEL	FREQUENCY (MHz)	26dBc BANDWIDTH (MHz)		PASS / FAIL
		CHAIN 0	CHAIN 1	
36	5180	19.89	19.80	PASS
40	5200	19.82	19.78	PASS
48	5240	20.09	19.89	PASS

802.11n (20MHz)

CHANNEL	FREQUENCY (MHz)	26dBc BANDWIDTH (MHz)		PASS / FAIL
		CHAIN 0	CHAIN 1	
36	5180	21.46	21.27	PASS
40	5200	20.89	20.40	PASS
48	5240	21.29	21.48	PASS

802.11n (40MHz)

CHANNEL	FREQUENCY (MHz)	26dBc BANDWIDTH (MHz)		PASS / FAIL
		CHAIN 0	CHAIN 1	
38	5190	46.07	47.23	PASS
46	5230	47.39	45.66	PASS

802.11ac (80MHz)

CHANNEL	FREQUENCY (MHz)	26dBc BANDWIDTH (MHz)		PASS / FAIL
		CHAIN 0	CHAIN 1	
42	5210	89.93	88.28	PASS



A D T

SPECTRUM PLOT OF WORST VALUE

802.11a

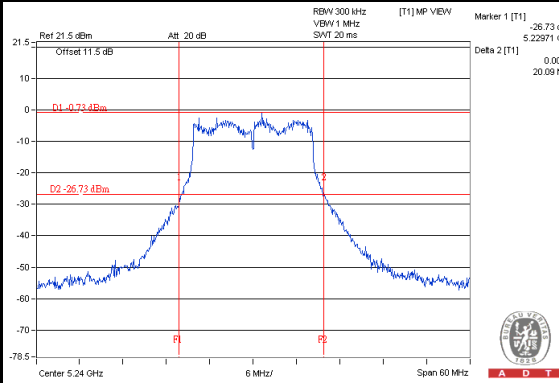

802.11n (20MHz)

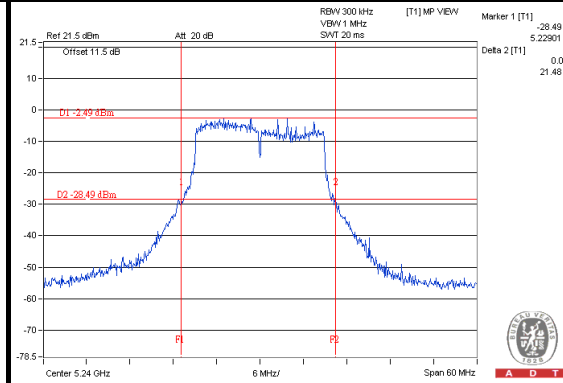

802.11n (40MHz)

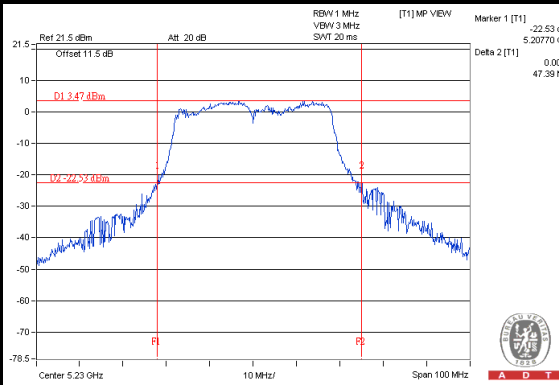

802.11ac (80MHz)

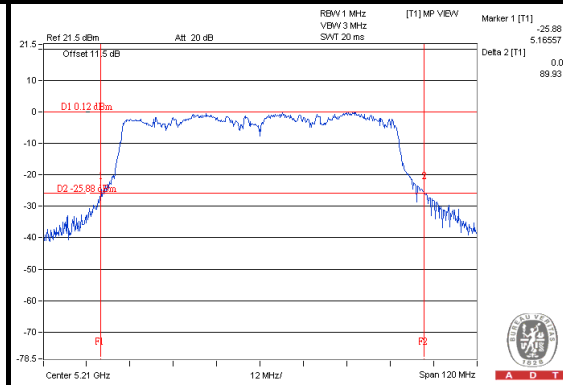

4.4 PEAK POWER SPECTRAL DENSITY MEASUREMENT

4.4.1 LIMITS OF PEAK POWER SPECTRAL DENSITY MEASUREMENT

FREQUENCY BAND	LIMIT
5.15 ~ 5.25GHz	4dBm

4.4.2 TEST SETUP

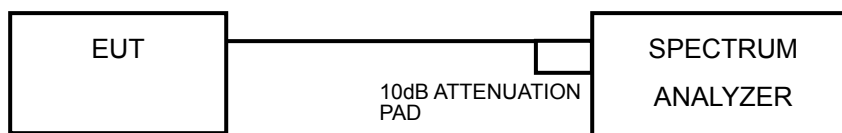

4.4.3 TEST INSTRUMENTS

Refer to section 4.1.3 to get information of above instrument.

4.4.4 TEST PROCEDURES

Using method SA-2

- 1) Set span to encompass the entire emission bandwidth (EBW) of the signal.
- 2) Set RBW = 30 KHz, Set VBW \geq 1 MHz, Detector = RMS
- 3) Set Channel power measure = 1MHz
- 4) Sweep time = auto, trigger set to "free run".
- 5) Trace average at least 100 traces in power averaging mode.
- 6) Record the max value and add $10 \log (1/\text{duty cycle})$

4.4.5 DEVIATION FROM TEST STANDARD

No deviation.

4.4.6 EUT OPERATING CONDITIONS

Same as 4.3.6.

4.4.7 TEST RESULTS

802.11a

CHAN.	FREQ. (MHz)	PSD (dBm)		TOTAL PSD W/O DUTY FACTOR (dBm)	DUTY FACTOR	TOTAL PSD WITH DUTY FACTOR (dBm)	MAX. LIMIT (dBm)	PASS / FAIL
		CHAIN 0	CHAIN 1					
36	5180	-1.63	-0.81	1.81	0.12	1.93	2.09	PASS
40	5200	-1.83	-1.18	1.52	0.12	1.64	2.09	PASS
48	5240	-0.91	-1.48	1.82	0.12	1.94	2.09	PASS

NOTE:

1. Method 1 of power density measurement of KDB 662911 is using for calculating total power density. Total power density is summing entire spectra across corresponding frequency bins on the various outputs by computer.
2. Directional gain = $4.9\text{dBi} + 10\log(2) = 7.91\text{dBi} > 6\text{dBi}$, so the power density limit shall be reduced to $4-(7.91-6) = 2.09\text{dBm}$.
3. Refer to section 3.3 for duty cycle spectrum plot.

802.11n (20MHz)

CHAN.	FREQ. (MHz)	PSD (dBm)		TOTAL PSD W/O DUTY FACTOR (dBm)	DUTY FACTOR	TOTAL PSD WITH DUTY FACTOR (dBm)	MAX. LIMIT (dBm)	PASS / FAIL
		CHAIN 0	CHAIN 1					
36	5180	-1.81	-1.46	1.38	0.14	1.52	2.09	PASS
40	5200	-1.45	-1.52	1.53	0.14	1.67	2.09	PASS
48	5240	-1.05	-1.40	1.79	0.14	1.93	2.09	PASS

NOTE:

1. Method 1 of power density measurement of KDB 662911 is using for calculating total power density. Total power density is summing entire spectra across corresponding frequency bins on the various outputs by computer.
2. Directional gain = $4.9\text{dBi} + 10\log(2) = 7.91\text{dBi} > 6\text{dBi}$, so the power density limit shall be reduced to $4-(7.91-6) = 2.09\text{dBm}$.
3. Refer to section 3.3 for duty cycle spectrum plot.



802.11n (40MHz)

CHAN.	FREQ. (MHz)	PSD (dBm)		TOTAL PSD W/O DUTY FACTOR (dBm)	DUTY FACTOR	TOTAL PSD WITH DUTY FACTOR (dBm)	MAX. LIMIT (dBm)	PASS / FAIL
		CHAIN 0	CHAIN 1					
38	5190	-5.08	-4.67	-1.86	0.27	-1.36	2.09	PASS
46	5230	-4.65	-5.99	-2.26	0.27	-1.76	2.09	PASS

NOTE:

1. Method 1 of power density measurement of KDB 662911 is using for calculating total power density. Total power density is summing entire spectra across corresponding frequency bins on the various outputs by computer.
2. Directional gain = $4.9\text{dBi} + 10\log(2) = 7.91\text{dBi} > 6\text{dBi}$, so the power density limit shall be reduced to $4-(7.91-6) = 2.09\text{dBm}$.
3. Refer to section 3.3 for duty cycle spectrum plot.

802.11ac (80MHz)

CHAN.	FREQ. (MHz)	PSD (dBm)		TOTAL PSD W/O DUTY FACTOR (dBm)	DUTY FACTOR	TOTAL PSD WITH DUTY FACTOR (dBm)	MAX. LIMIT (dBm)	PASS / FAIL
		CHAIN 0	CHAIN 1					
42	5210	-8.64	-8.81	-5.71	0.51	-5.20	2.09	PASS

NOTE:

1. Method 1 of power density measurement of KDB 662911 is using for calculating total power density. Total power density is summing entire spectra across corresponding frequency bins on the various outputs by computer.
2. Directional gain = $4.9\text{dBi} + 10\log(2) = 7.91\text{dBi} > 6\text{dBi}$, so the power density limit shall be reduced to $4-(7.91-6) = 2.09\text{dBm}$.
3. Refer to section 3.3 for duty cycle spectrum plot.



A D T

SPECTRUM PLOT OF WORST VALUE

802.11a

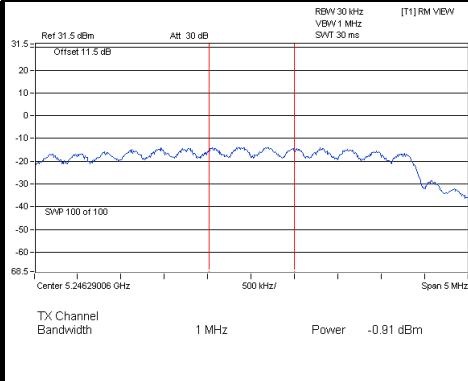

802.11n (20MHz)

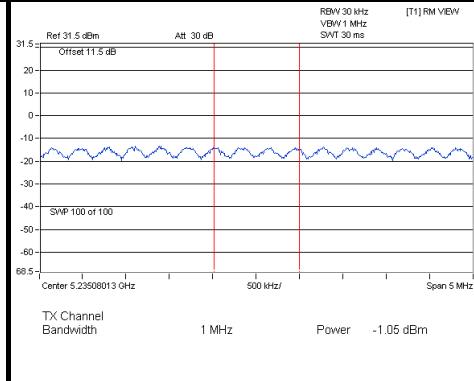

802.11n (40MHz)

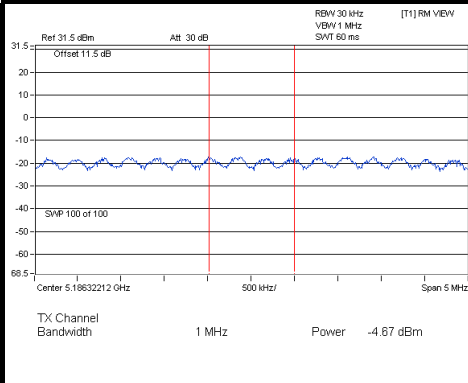

802.11ac (80MHz)

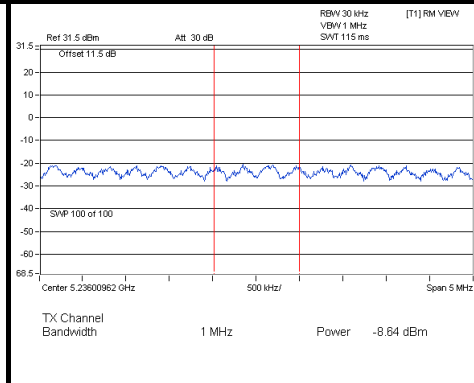

4.5 PEAK POWER EXCURSION MEASUREMENT

4.5.1 LIMITS OF PEAK POWER EXCURSION MEASUREMENT

Shall not exceed 13 dB

4.5.2 TEST SETUP

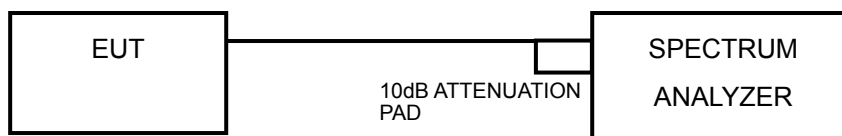

4.5.3 TEST INSTRUMENTS

Refer to section 4.1.3 to get information of above instrument.

4.5.4 TEST PROCEDURE

- 1) Set RBW = 1 MHz, VBW \geq 3 MHz, Detector = peak.
- 2) Trace mode = max-hold. Allow the sweeps to continue until the trace stabilizes.
- 3) Use the peak search function to find the peak of the spectrum.
- 4) Measure the PPSD.
- 5) Compute the ratio of the maximum of the peak-max-hold spectrum to the PPSD. Find the worst channel and modulation mode as above test procedure, and follow KDB 789033 D01 General UNII Test Procedures v01r03 and repeat step 1 to 5 for final testing of each modulation mode on a single channel (all modulation types) in a single operating band to compliance with the peak excursion requirement.

4.5.5 DEVIATION FROM TEST STANDARD

No deviation.

4.5.6 EUT OPERATING CONDITIONS

Same as 4.2.6



4.5.7 TEST RESULTS

MODULATION MODE	MODULATION TYPE	FREQ. (MHz)	PEAK VALUE (dBm)	PPSD WITHOUT DUTY FACTOR (dBm)	PPSD WITH DUTY FACTOR (dBm)	PEAK EXCURSION (dB)	LIMIT (dB)	PASS /FAIL
802.11a	BPSK	5240	7.20	-0.91	-0.79	7.99	13	PASS
	QPSK		8.30	-0.88	-0.64	8.94	13	PASS
	16QAM		7.82	-1.47	-1.04	8.86	13	PASS
	64QAM		8.69	-2.50	-1.7	10.39	13	PASS
802.11n (20MHz)	BPSK	5240	7.54	-1.05	-0.91	8.45	13	PASS
	QPSK		8.29	-1.13	-0.88	9.17	13	PASS
	16QAM		9.02	-1.70	-1.23	10.25	13	PASS
	64QAM		8.05	-2.67	-1.83	9.88	13	PASS
802.11n (40MHz)	BPSK	5230	4.50	-4.65	-4.38	8.88	13	PASS
	QPSK		5.18	-5.13	-4.63	9.81	13	PASS
	16QAM		4.65	-5.22	-4.73	9.38	13	PASS
	64QAM		6.82	-6.96	-5.57	12.39	13	PASS
802.11ac (80MHz)	BPSK	5210	0.98	-8.64	-8.13	9.11	13	PASS
	QPSK		2.18	-9.38	-8.48	10.66	13	PASS
	16QAM		1.61	-10.22	-8.82	10.43	13	PASS
	64QAM		2.30	-11.97	-7.20	9.50	13	PASS
	256QAM		1.19	-11.67	-9.27	10.46	13	PASS



A D T

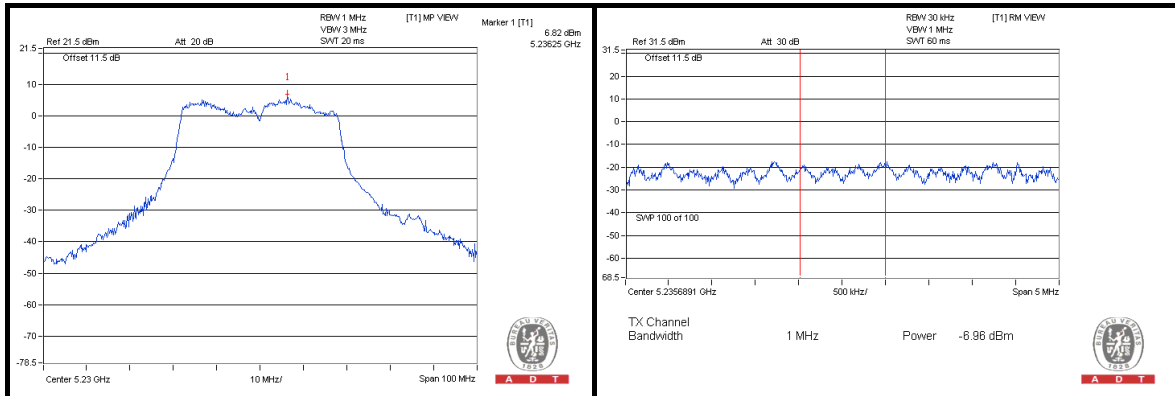

4.6 FREQUENCY STABILITY

4.6.1 LIMITS OF FREQUENCY STABILITY MEASUREMENT

The frequency of the carrier signal shall be maintained within band of operation

4.6.2 TEST SETUP

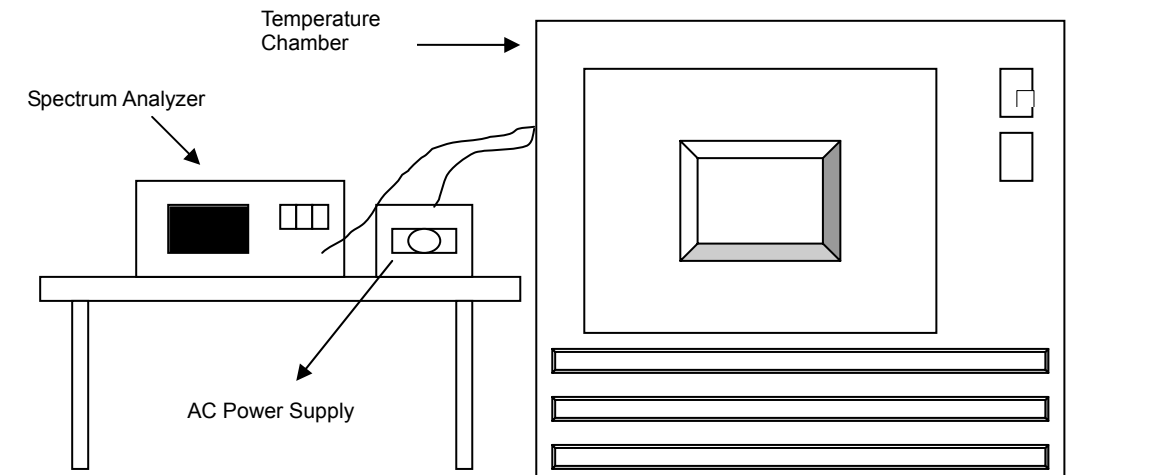

4.6.3 TEST INSTRUMENTS

Refer to section 4.1.3 to get information of above instrument.

4.6.4 TEST PROCEDURE

- a. The EUT was placed inside the environmental test chamber and powered by nominal AC voltage.
- b. Turn the EUT on and couple its output to a spectrum analyzer.
- c. Turn the EUT off and set the chamber to the highest temperature specified.
- d. Allow sufficient time (approximately 30 min) for the temperature of the chamber to stabilize, turn the EUT on and measure the operating frequency after 2, 5, and 10 minutes.
- e. Repeat step 2 and 3 with the temperature chamber set to the lowest temperature.
- f. The test chamber was allowed to stabilize at +20 degree C for a minimum of 30 minutes. The supply voltage was then adjusted on the EUT from 85% to 115% and the frequency record.

4.6.5 DEVIATION FROM TEST STANDARD

No deviation.

4.6.6 EUT OPERATING CONDITION

Set the EUT transmit at un-modulation mode to test frequency stability.



4.6.7 TEST RESULTS

FREQUENCY STABILITY VERSUS TEMP.									
OPERATING FREQUENCY: 5240MHz									
TEMP. (°C)	POWER SUPPLY (Vac)	0 MINUTE		2 MINUTE		5 MINUTE		10 MINUTE	
		Measured Frequency (MHz)	Frequency Drift (%)	Measured Frequency (MHz)	Frequency Drift (%)	Measured Frequency (MHz)	Frequency Drift (%)	Measured Frequency (MHz)	Frequency Drift (%)
50	120	5239.9993	-0.00001	5239.9999	0.00000	5239.9919	-0.00015	5240.0011	0.00002
40	120	5240.0008	0.00002	5240.0074	0.00014	5240.0003	0.00001	5240.0044	0.00008
30	120	5240.0136	0.00026	5240.0137	0.00026	5240.0112	0.00021	5240.0161	0.00031
20	120	5239.9825	-0.00033	5239.9806	-0.00037	5239.9751	-0.00048	5239.9736	-0.00050
10	120	5240.0165	0.00031	5240.0156	0.00030	5240.0166	0.00032	5240.0206	0.00039
0	120	5240.0098	0.00019	5240.0026	0.00005	5240.0051	0.00010	5240.0015	0.00003
-10	120	5240.0261	0.00050	5240.0306	0.00058	5240.0238	0.00045	5240.0298	0.00057
-20	120	5240.0200	0.00038	5240.0245	0.00047	5240.0195	0.00037	5240.0181	0.00035
-30	120	5239.9863	-0.00026	5239.9869	-0.00025	5239.9942	-0.00011	5239.9896	-0.00020

FREQUENCY STABILITY VERSUS VOLTAGE									
OPERATING FREQUENCY: 5240MHz									
TEMP. (°C)	POWER SUPPLY (Vac)	0 MINUTE		2 MINUTE		5 MINUTE		10 MINUTE	
		Measured Frequency (MHz)	Frequency Drift (%)	Measured Frequency (MHz)	Frequency Drift (%)	Measured Frequency (MHz)	Frequency Drift (%)	Measured Frequency (MHz)	Frequency Drift (%)
20	138	5239.9835	-0.00031	5239.9812	-0.00036	5239.976	-0.00046	5239.9729	-0.00052
	120	5239.9825	-0.00033	5239.9806	-0.00037	5239.9751	-0.00048	5239.9736	-0.00050
	102	5239.9832	-0.00032	5239.9800	-0.00038	5239.9742	-0.00049	5239.9727	-0.00052

5. PHOTOGRAPHS OF THE TEST CONFIGURATION

Please refer to the attached file (Test Setup Photo).



6. INFORMATION ON THE TESTING LABORATORIES

We, Bureau Veritas Consumer Products Services (H.K.) Ltd., Taoyuan Branch, were founded in 1988 to provide our best service in EMC, Radio, Telecom and Safety consultation. Our laboratories are accredited and approved according to ISO/IEC 17025.

If you have any comments, please feel free to contact us at the following:

Linko EMC/RF Lab:

Tel: 886-2-26052180

Fax: 886-2-26051924

Hsin Chu EMC/RF Lab:

Tel: 886-3-5935343

Fax: 886-3-5935342

Hwa Ya EMC/RF/Safety Telecom Lab:

Tel: 886-3-3183232

Fax: 886-3-3270892

Email: service.adt@tw.bureauveritas.com

Web Site: www.bureauveritas-adt.com

The address and road map of all our labs can be found in our web site also.



A D T

7. APPENDIX A – MODIFICATIONS RECORDERS FOR ENGINEERING CHANGES TO THE EUT BY THE LAB

No modifications were made to the EUT by the lab during the test.

---END---