



A D T

FCC TEST REPORT (15.247)

REPORT NO.: RF130511C01A

MODEL NO.: NBG6716, EMG2926-Q10A

FCC ID: I88NBG6716

RECEIVED: Jan. 24, 2014

TESTED: Feb. 07 ~ Feb. 08, 2014

ISSUED: Feb. 25, 2014

APPLICANT: ZyXEL Communications Corporation

ADDRESS: No. 6, Innovation Road II, Hsinchu Science Park
No. 2, Gongye E. 9th Road, Hsinchu Science
Park, Hsinchu Taiwan

ISSUED BY: Bureau Veritas Consumer Products Services
(H.K.) Ltd., Taoyuan Branch

LAB ADDRESS: No. 47, 14th Ling, Chia Pau Vil., Lin Kou Dist.,
New Taipei City, Taiwan, R.O.C.

TEST LOCATION: No. 19, Hwa Ya 2nd Rd, Wen Hwa Tsuen, Kwei
Shan Hsiang, Taoyuan Hsien 333, Taiwan, R.O.C.

This report should not be used by the client to claim product certification, approval, or endorsement by TAF or any government agencies.



This report is for your exclusive use. Any copying or replication of this report to or for any other person or entity, or use of our name or trademark, is permitted only with our prior written permission. This report sets forth our findings solely with respect to the test samples identified herein. The results set forth in this report are not indicative or representative of the quality or characteristics of the lot from which a test sample was taken or any similar or identical product unless specifically and expressly noted. Our report includes all of the tests requested by you and the results thereof based upon the information that you provided to us. You have 60 days from date of issuance of this report to notify us of any material error or omission caused by our negligence, provided, however, that such notice shall be in writing and shall specifically address the issue you wish to raise. A failure to raise such issue within the prescribed time shall constitute your unqualified acceptance of the completeness of this report, the tests conducted and the correctness of the report contents. Unless specific mention, the uncertainty of measurement has been explicitly taken into account to declare the compliance or non-compliance to the specification.



A D T

TABLE OF CONTENTS

RELEASE CONTROL RECORD.....	4
1. CERTIFICATION.....	5
2. SUMMARY OF TEST RESULTS	6
2.1 MEASUREMENT UNCERTAINTY.....	6
3. GENERAL INFORMATION.....	7
3.1 GENERAL DESCRIPTION OF EUT	7
3.2 DESCRIPTION OF TEST MODES	9
3.2.1 TEST MODE APPLICABILITY AND TESTED CHANNEL DETAIL	10
3.3 DESCRIPTION OF SUPPORT UNITS	12
3.3.1 CONFIGURATION OF SYSTEM UNDER TEST	13
3.4 GENERAL DESCRIPTION OF APPLIED STANDARDS	14
4. TEST TYPES AND RESULTS (FOR 2.4GHz BAND)	15
4.1 RADIATED EMISSION AND BANDEDGE MEASUREMENT	15
4.1.1 LIMITS OF RADIATED EMISSION AND BANDEDGE MEASUREMENT	15
4.1.2 TEST INSTRUMENTS.....	16
4.1.3 TEST PROCEDURES	17
4.1.4 DEVIATION FROM TEST STANDARD.....	17
4.1.5 TEST SETUP.....	18
4.1.6 EUT OPERATING CONDITIONS	18
4.1.7 TEST RESULTS	19
4.2 CONDUCTED EMISSION MEASUREMENT	21
4.2.1 LIMITS OF CONDUCTED EMISSION MEASUREMENT	21
4.2.2 TEST INSTRUMENTS.....	21
4.2.3 TEST PROCEDURES	22
4.2.4 DEVIATION FROM TEST STANDARD.....	22
4.2.5 TEST SETUP.....	22
4.2.6 EUT OPERATING CONDITIONS	22
4.2.7 TEST RESULTS	23
5. TEST TYPES AND RESULTS (FOR 5.0GHz BAND)	25
5.1 RADIATED EMISSION MEASUREMENT	25
5.1.1 LIMITS OF RADIATED EMISSION MEASUREMENT	25
5.1.2 TEST INSTRUMENTS.....	26
5.1.3 TEST PROCEDURES	26
5.1.4 DEVIATION FROM TEST STANDARD.....	26
5.1.5 TEST SETUP.....	26
5.1.6 EUT OPERATING CONDITIONS	26



A D T

5.1.7	TEST RESULTS	27
5.2	CONDUCTED EMISSION MEASUREMENT	29
5.2.1	LIMITS OF CONDUCTED EMISSION MEASUREMENT	29
5.2.2	TEST INSTRUMENTS.....	29
5.2.3	TEST PROCEDURES	29
5.2.4	DEVIATION FROM TEST STANDARD.....	29
5.2.5	TEST SETUP	29
5.2.6	EUT OPERATING CONDITIONS	29
5.2.7	TEST RESULTS	30
6.	PHOTOGRAPHS OF THE TEST CONFIGURATION.....	32
7.	INFORMATION ON THE TESTING LABORATORIES	33
8.	APPENDIX A – MODIFICATIONS RECORDERS FOR ENGINEERING CHANGES TO THE EUT BY THE LAB.....	34



A D T

RELEASE CONTROL RECORD

ISSUE NO.	REASON FOR CHANGE	DATE ISSUED
RF130511C01A	Original release	Feb. 25, 2014



A D T

1. CERTIFICATION

PRODUCT: Simultaneous Dual-Band Wireless AC1750 HD Media Router
MODEL NO.: NBG6716, EMG2926-Q10A
BRAND: ZyXEL
APPLICANT: ZyXEL Communications Corporation
TESTED: Feb. 07 ~ Feb. 08, 2014
TEST SAMPLE: ENGINEERING SAMPLE
STANDARDS: **FCC Part 15, Subpart C (Section 15.247)**
ANSI C63.10-2009

This report is issued as a supplementary report of **RF130511C01** for changing second source. This report shall be used combining with its original report.

PREPARED BY: Ivy Lin, **DATE:** Feb. 25, 2014
Ivy Lin / Specialist

APPROVED BY: Ken Liu, **DATE:** Feb. 25, 2014
Ken Liu / Senior Manager

NOTE: The conducted and radiated emission tests were performed for the modification. Refer to original report for the other test data.



2. SUMMARY OF TEST RESULTS

The EUT has been tested according to the following specifications:

APPLIED STANDARD: FCC PART 15, SUBPART C (SECTION 15.247)			
STANDARD SECTION	TEST TYPE	RESULT	REMARK
15.207	AC Power Conducted Emission	PASS	Meet the requirement of limit. Minimum passing margin is -14.12dB at 0.27109MHz.
15.247(d) 15.209	Radiated Emissions	PASS	Meet the requirement of limit. Minimum passing margin is -0.9dB at 4874.00MHz
15.247(d)	Band Edge Measurement	NA	Refer to Note
15.247(a)(2)	6dB bandwidth	NA	Refer to Note
15.247(b)	Conducted power	NA	Refer to Note
15.247(e)	Power Spectral Density	NA	Refer to Note
15.203	Antenna Requirement	PASS	Antenna connector is I-PEX not a standard connector.

NOTE: The conducted and radiated emission tests were performed for the modification. Refer to original report for the other test data.

2.1 MEASUREMENT UNCERTAINTY

Where relevant, the following measurement uncertainty levels have been estimated for tests performed on the EUT as specified in CISPR 16-4-2:

MEASUREMENT	FREQUENCY	UNCERTAINTY
Conducted emissions	9kHz~30MHz	2.44 dB
Radiated emissions	30MHz ~ 200MHz	3.34 dB
	200MHz ~1000MHz	3.35 dB

This uncertainty represents an expanded uncertainty expressed at approximately the 95% confidence level using a coverage factor of k = 2.



3. GENERAL INFORMATION

3.1 GENERAL DESCRIPTION OF EUT

EUT	Simultaneous Dual-Band Wireless AC1750 HD Media Router
MODEL NO.	NBG6716, EMG2926-Q10A
POWER SUPPLY	12Vdc (Adapter)
MODULATION TYPE	CCK, DQPSK, DBPSK for DSSS 64QAM, 16QAM, QPSK, BPSK for OFDM 256QAM for OFDM in 11ac mode only.
MODULATION TECHNOLOGY	DSSS, OFDM
TRANSFER RATE	802.11b: 11.0/ 5.5/ 2.0/ 1.0Mbps 802.11g: 54.0/ 48.0/ 36.0/ 24.0/ 18.0/ 12.0/ 9.0/ 6.0Mbps 802.11a: 54.0/ 48.0/ 36.0/ 24.0/ 18.0/ 12.0/ 9.0/ 6.0Mbps 802.11n: up to 450.0Mbps 802.11ac: up to 1.3Gbps
OPERATING FREQUENCY	2.4GHz: 2412 ~ 2462MHz 5.0GHz: 5745 ~ 5825MHz
NUMBER OF CHANNEL	2.4GHz: 11 for 802.11b, 802.11g, 802.11n (20MHz) 7 for 802.11n (40MHz) 5.0GHz: 5 for 802.11a, 802.11n (20MHz) 2 for 802.11n (40MHz) 1 for 802.11ac (80MHz)
OUTPUT POWER	830.032mW for 2412 ~ 2462MHz 501.310mW for 5745 ~ 5825MHz
ANTENNA TYPE	PCB antenna with 2dBi gain
ANTENNA CONNECTOR	I-PEX
DATA CABLE	N/A
I/O PORTS	Refer to user's manual
ACCESSORY DEVICES	Adapter



NOTE:

1. This is a supplementary report of RF130511C01. This report shall be combined together with its original report.
2. This report is prepared for FCC class II permissive change. Difference compared with the original report is changing the following sources. Therefore, radiated emission and conducted emission had been re-tested and presented in the test report.

Item	Description
USB Connector	Changed source to CONN USB-A_2.0 1PORT USB-AFRA122-088 DIP LFP
X'tal of PHY	Changed source to X'TAL 25MHz 25ppm 20pF NXS25.000AD20F DIP LFP
2.4GHz I-PEX connector	Changed source to RFJACK COAXIAL F 180 W08-5801-002-00-810 SMD LFP
IC ROM-FLASH	Changed from 128Mb to 32Mb
IC ROM-FLAS	Changed from 2 GB to 1GB
WAN Port	Changed to without metal case
LAN Port	Changed to without metal case
DDR	DDR updated version

3. The following models are electrically identical, different model names are for marketing purpose.

BRAND	MODEL
ZyXEL	NBG6716
	EMG2926-Q10A

* The model of the NBG6716 was chosen for final test.

4. The EUT incorporates a MIMO function. The EUT provides 3 completed transmitters and 3 receivers.

MODULATION MODE	TX FUNCTION
802.11b	3TX
802.11g	3TX
802.11a	3TX
802.11n (20MHz)	3TX
802.11n (40MHz)	3TX
802.11ac (80MHz)	3TX

5. The EUT consumes power from the following adapter.

BRAND:	DVE
MODEL:	DSA-24PFD-15 FUS 120200
INPUT:	100-240Vac, 50/60Hz, 0.8A
OUTPUT:	+12Vdc, 2A
POWER LINE:	DC 1.5m power cable w/o core attached on adapter

6. The above EUT information is declared by manufacturer and for more detailed features description, please refer to the manufacturer's specifications or user's manual.



3.2 DESCRIPTION OF TEST MODES

FOR 2.4GHz:

11 channels are provided for 802.11b, 802.11g and 802.11n (20MHz):

CHANNEL	FREQUENCY	CHANNEL	FREQUENCY
1	2412MHz	7	2442MHz
2	2417MHz	8	2447MHz
3	2422MHz	9	2452MHz
4	2427MHz	10	2457MHz
5	2432MHz	11	2462MHz
6	2437MHz		

7 channels are provided for 802.11n (40MHz):

CHANNEL	FREQUENCY	CHANNEL	FREQUENCY
3	2422MHz	7	2442MHz
4	2427MHz	8	2447MHz
5	2432MHz	9	2452MHz
6	2437MHz		

FOR 5.0GHz (5745 ~ 5825MHz):

5 channels are provided for 802.11a, 802.11n (20MHz):

CHANNEL	FREQUENCY	CHANNEL	FREQUENCY
149	5745MHz	161	5805MHz
153	5765MHz	165	5825MHz
157	5785MHz		

2 channels are provided for 802.11n (40MHz):

CHANNEL	FREQUENCY	CHANNEL	FREQUENCY
151	5755MHz	159	5795MHz

1 channel is provided for 802.11ac (80MHz):

CHANNEL	FREQUENCY
155	5775MHz



3.2.1 TEST MODE APPLICABILITY AND TESTED CHANNEL DETAIL

FOR 2.4GHz:

EUT CONFIGURE MODE	APPLICABLE TO			DESCRIPTION
	RE≥1G	RE<1G	PLC	
-	√	√	√	-

Where **RE≥1G**: Radiated Emission above 1GHz **RE<1G**: Radiated Emission below 1GHz
PLC: Power Line Conducted Emission

RADIATED EMISSION TEST (ABOVE 1GHz):

- Pre-Scan has been conducted to determine the worst-case mode from all possible combinations between available modulations, data rates and antenna ports (if EUT with antenna diversity architecture).
- Following channel(s) was (were) selected for the final test as listed below.

EUT CONFIGURE MODE	MODE	AVAILABLE CHANNEL	TESTED CHANNEL	MODULATION TECHNOLOGY	MODULATION TYPE	DATA RATE (Mbps)
-	802.11b	1 to 11	6	DSSS	DBPSK	1.0

RADIATED EMISSION TEST (BELOW 1GHz):

- Pre-Scan has been conducted to determine the worst-case mode from all possible combinations between available modulations, data rates and antenna ports (if EUT with antenna diversity architecture).
- Following channel(s) was (were) selected for the final test as listed below.

EUT CONFIGURE MODE	MODE	AVAILABLE CHANNEL	TESTED CHANNEL	MODULATION TECHNOLOGY	MODULATION TYPE	DATA RATE (Mbps)
-	802.11g	1 to 11	11	OFDM	BPSK	6.0

POWER LINE CONDUCTED EMISSION TEST:

- Pre-Scan has been conducted to determine the worst-case mode from all possible combinations between available modulations, data rates and antenna ports (if EUT with antenna diversity architecture).
- Following channel(s) was (were) selected for the final test as listed below.

EUT CONFIGURE MODE	MODE	AVAILABLE CHANNEL	TESTED CHANNEL	MODULATION TECHNOLOGY	MODULATION TYPE	DATA RATE (Mbps)
-	802.11g	1 to 11	11	OFDM	BPSK	6.0

TEST CONDITION:

APPLICABLE TO	ENVIRONMENTAL CONDITIONS	INPUT POWER	TESTED BY
RE≥1G	25deg. C, 65%RH	120Vac, 60Hz	Chris Lin
RE<1G	25deg. C, 65%RH	120Vac, 60Hz	Chris Lin
PLC	25deg. C, 65%RH	120Vac, 60Hz	Chris Lin



A D T

FOR 5.0GHz (5745 ~ 5825MHz):

EUT CONFIGURE MODE	APPLICABLE TO			DESCRIPTION
	RE≥1G	RE<1G	PLC	
-	√	√	√	-

Where **RE≥1G**: Radiated Emission above 1GHz **RE<1G**: Radiated Emission below 1GHz
PLC: Power Line Conducted Emission

RADIATED EMISSION TEST (ABOVE 1GHz):

- Pre-Scan has been conducted to determine the worst-case mode from all possible combinations between available modulations, data rates and antenna ports (if EUT with antenna diversity architecture).
- Following channel(s) was (were) selected for the final test as listed below.

EUT CONFIGURE MODE	MODE	AVAILABLE CHANNEL	TESTED CHANNEL	MODULATION TECHNOLOGY	MODULATION TYPE	DATA RATE (Mbps)
-	802.11n (20MHz)	149 to 165	165	OFDM	BPSK	7.2

RADIATED EMISSION TEST (BELOW 1GHz):

- Pre-Scan has been conducted to determine the worst-case mode from all possible combinations between available modulations, data rates and antenna ports (if EUT with antenna diversity architecture).
- Following channel(s) was (were) selected for the final test as listed below.

EUT CONFIGURE MODE	MODE	AVAILABLE CHANNEL	TESTED CHANNEL	MODULATION TECHNOLOGY	MODULATION TYPE	DATA RATE (Mbps)
-	802.11a	149 to 165	149	OFDM	BPSK	6.0

POWER LINE CONDUCTED EMISSION TEST:

- Pre-Scan has been conducted to determine the worst-case mode from all possible combinations between available modulations, data rates and antenna ports (if EUT with antenna diversity architecture).
- Following channel(s) was (were) selected for the final test as listed below.

EUT CONFIGURE MODE	MODE	AVAILABLE CHANNEL	TESTED CHANNEL	MODULATION TECHNOLOGY	MODULATION TYPE	DATA RATE (Mbps)
-	802.11a	149 to 165	149	OFDM	BPSK	6.0

TEST CONDITION:

APPLICABLE TO	ENVIRONMENTAL CONDITIONS	INPUT POWER	TESTED BY
RE>1G	25deg. C, 65%RH	120Vac, 60Hz	Chris Lin
RE<1G	25deg. C, 65%RH	120Vac, 60Hz	Chris Lin
PLC	25deg. C, 65%RH	120Vac, 60Hz	Chris Lin



A D T

3.3 DESCRIPTION OF SUPPORT UNITS

The EUT has been tested as an independent unit together with other necessary accessories or support units. The following support units or accessories were used to form a representative test configuration during the tests.

NO.	PRODUCT	BRAND	MODEL NO.	SERIAL NO.	FCC ID
1	USB FLASH DRIVE	Transcend	V85	538455 4490	NA
2	USB FLASH DRIVE	Transcend	V85	538455 4488	NA
3	NOTEBOOK	DELL	E5410	1HC2XM1	FCC DoC Approved

NO.	SIGNAL CABLE DESCRIPTION OF THE ABOVE SUPPORT UNITS
1	NA
2	NA
3	10m RJ45 UTP cable.

NOTE:

1. All power cords of the above support units are non-shielded (1.8m).
2. Item 3 acted as a communication partner to transfer data.

3.3.1 CONFIGURATION OF SYSTEM UNDER TEST

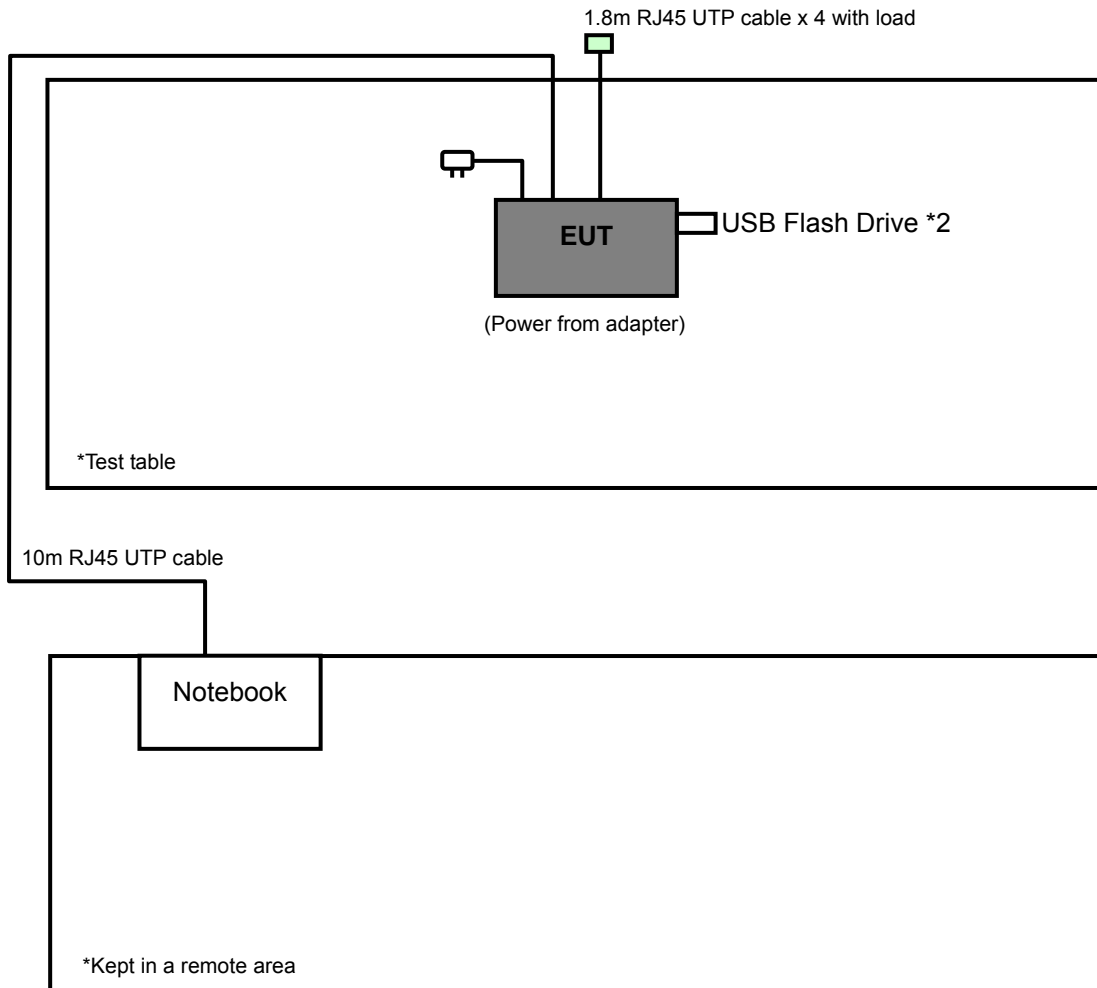



A D T

3.4 GENERAL DESCRIPTION OF APPLIED STANDARDS

The EUT is a RF Product. According to the specifications of the manufacturer, it must comply with the requirements of the following standards:

FCC Part 15, Subpart C (15.247)

558074 D01 DTS Meas Guidance v03r01

662911 D01 Multiple Transmitter Output v01 r02

ANSI C63.10-2009

All test items have been performed and recorded as per the above standards.

NOTE: The EUT is also considered as a kind of computer peripheral, because the connection to computer is necessary for typical use. It has been verified to comply with the requirements of FCC Part 15, Subpart B, Class B (DoC). The test report has been issued separately.



A D T

4. TEST TYPES AND RESULTS (FOR 2.4GHz BAND)

4.1 RADIATED EMISSION AND BANDEDGE MEASUREMENT

4.1.1 LIMITS OF RADIATED EMISSION AND BANDEDGE MEASUREMENT

Radiated emissions which fall in the restricted bands must comply with the radiated emission limits specified as below table. Other emissions shall be at least 20dB below the highest level of the desired power:

FREQUENCIES (MHz)	FIELD STRENGTH (microvolts/meter)	MEASUREMENT DISTANCE (meters)
0.009 ~ 0.490	2400/F(kHz)	300
0.490 ~ 1.705	24000/F(kHz)	30
1.705 ~ 30.0	30	30
30 ~ 88	100	3
88 ~ 216	150	3
216 ~ 960	200	3
Above 960	500	3

NOTE:

1. The lower limit shall apply at the transition frequencies.
2. Emission level (dBuV/m) = 20 log Emission level (uV/m).
3. For frequencies above 1000MHz, the field strength limits are based on average detector, however, the peak field strength of any emission shall not exceed the maximum permitted average limits, specified above by more than 20dB under any condition of modulation.



A D T

4.1.2 TEST INSTRUMENTS

DESCRIPTION & MANUFACTURER	MODEL NO.	SERIAL NO.	DATE OF CALIBRATION	DUE DATE OF CALIBRATION
Test Receiver ROHDE & SCHWARZ	ESIB7	100187	Jan. 02, 2014	Jan. 01, 2015
Spectrum Analyzer ROHDE & SCHWARZ	FSP40	100041	Aug. 23, 2013	Aug. 22, 2014
BILOG Antenna SCHWARZBECK	VULB9168	9168-160	Mar. 20, 2013	Mar. 19, 2014
HORN Antenna SCHWARZBECK	9120D	209	Sep. 12, 2013	Sep. 11, 2014
HORN Antenna SCHWARZBECK	BBHA 9170	148	Jul. 15, 2013	Jul. 14, 2014
Preamplifier Agilent	8447D	2944A10633	Oct. 07, 2013	Oct. 06, 2014
Preamplifier Agilent	8449B	3008A01964	Aug. 26, 2013	Aug. 25, 2014
RF signal cable HUBER+SUHNNER	SUCOFLEX 104	214378/4	Aug. 26, 2013	Aug. 25, 2014
RF signal cable HUBER+SUHNNER	SUCOFLEX 106	12738/6+309224/4	Aug. 26, 2013	Aug. 25, 2014
Software BV ADT	ADT_Radiated_ V7.6.15.9.4	NA	NA	NA
Antenna Tower inn-co GmbH	MA 4000	013303	NA	NA
Antenna Tower Controller inn-co GmbH	CO2000	017303	NA	NA
Turn Table BV ADT	TT100	TT93021703	NA	NA
Turn Table Controller BV ADT	SC100	SC93021703	NA	NA

- NOTE:**
1. The calibration interval of the above test instruments is 12 months and the calibrations are traceable to NML/ROC and NIST/USA.
 2. The test was performed in HwaYa Chamber 3.
 3. The horn antenna and HP preamplifier (model: 8449B) are used only for the measurement of emission frequency above 1GHz if tested.
 4. The FCC Site Registration No. is 988962.
 5. The IC Site Registration No. is IC 7450F-3.



A D T

4.1.3 TEST PROCEDURES

- a. The EUT was placed on the top of a rotating table 0.8 meters above the ground at a 3 meters semi-anechoic chamber. The table was rotated 360 degrees to determine the position of the highest radiation.
- b. The EUT was set 3 meters away from the interference-receiving antenna, which was mounted on the top of a variable-height antenna tower.
- c. The antenna is a broadband antenna, and its height is varied from one meter to four meters above the ground to determine the maximum value of the field strength. Both horizontal and vertical polarizations of the antenna are set to make the measurement.
- d. For each suspected emission, the EUT was arranged to its worst case and then the antenna was tuned to heights from 1 meter to 4 meters and the rotatable table was turned from 0 degrees to 360 degrees to find the maximum reading.
- e. The test-receiver system was set to Peak Detect Function and Specified Bandwidth with Maximum Hold Mode.
- f. If the emission level of the EUT in peak mode was lower than the limit specified, then testing could be stopped and the peak values of the EUT would be reported. Otherwise the emissions would be re-tested one by one using peak, quasi-peak or average method as specified and then reported in a data sheet.

NOTE:

1. The resolution bandwidth and video bandwidth of test receiver/spectrum analyzer is 120kHz for Quasi-peak detection at frequency below 1GHz.
2. The resolution bandwidth of test receiver/spectrum analyzer is 1MHz and video bandwidth is 3MHz for Peak detection at frequency above 1GHz.
3. The resolution bandwidth of test receiver/spectrum analyzer is 1MHz and the video bandwidth is 1kHz(Duty cycle < 98%) or 10Hz(Duty cycle > 98%) for Average detection (AV) at frequency above 1GHz.
4. All modes of operation were investigated and the worst-case emissions are reported.

4.1.4 DEVIATION FROM TEST STANDARD

No deviation.

4.1.5 TEST SETUP

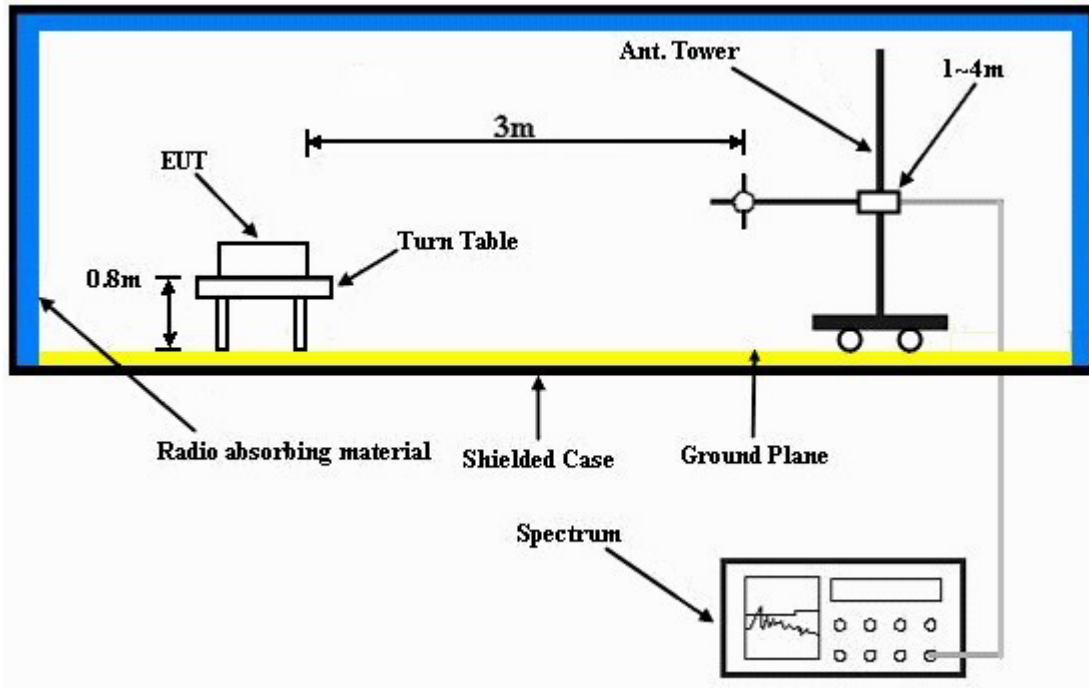

For the actual test configuration, please refer to the attached file (Test Setup Photo).

4.1.6 EUT OPERATING CONDITIONS

- a. Placed the EUT on the testing table.
- b. Prepared notebook to act as communication partner and placed it outside of testing area.
- c. The communication partner connected with EUT via a RJ45 cable and ran a test program (provided by manufacturer) to enable EUT under transmission condition continuously at specific channel frequency.
- d. The communication partner sent data to EUT by command "PING".
- e. The necessary accessories enabled the system in full functions.



A D T

4.1.7 TEST RESULTS

ABOVE 1GHz DATA : 802.11b

EUT TEST CONDITION		MEASUREMENT DETAIL	
CHANNEL	Channel 6	FREQUENCY RANGE	1 ~ 25GHz
INPUT POWER	120Vac, 60 Hz	DETECTOR FUNCTION	Peak (PK) Average (AV)
ENVIRONMENTAL CONDITIONS	25deg. C, 65%RH	TESTED BY	Chris Lin

ANTENNA POLARITY & TEST DISTANCE: HORIZONTAL AT 3 M								
NO.	FREQ. (MHz)	EMISSION LEVEL (dBuV/m)	LIMIT (dBuV/m)	MARGIN (dB)	ANTENNA HEIGHT (m)	TABLE ANGLE (Degree)	RAW VALUE (dBuV)	CORRECTION FACTOR (dB/m)
1	2288.00	46.7 PK	74.0	-27.3	1.58 H	351	48.90	-2.20
2	2288.00	35.1 AV	54.0	-18.9	1.58 H	351	37.30	-2.20
3	*2437.00	110.5 PK			1.45 H	347	78.50	32.00
4	*2437.00	106.3 AV			1.45 H	347	74.30	32.00
5	4874.00	54.5 PK	74.0	-19.5	1.08 H	331	50.00	4.50
6	4874.00	49.9 AV	54.0	-4.1	1.08 H	331	45.40	4.50
ANTENNA POLARITY & TEST DISTANCE: VERTICAL AT 3 M								
NO.	FREQ. (MHz)	EMISSION LEVEL (dBuV/m)	LIMIT (dBuV/m)	MARGIN (dB)	ANTENNA HEIGHT (m)	TABLE ANGLE (Degree)	RAW VALUE (dBuV)	CORRECTION FACTOR (dB/m)
1	2288.00	46.9 PK	74.0	-27.1	1.00 V	211	49.10	-2.20
2	2288.00	40.4 AV	54.0	-13.6	1.00 V	211	42.60	-2.20
3	*2437.00	114.4 PK			1.04 V	259	82.40	32.00
4	*2437.00	110.3 AV			1.04 V	259	78.30	32.00
5	4874.00	58.8 PK	74.0	-15.2	1.16 V	43	54.30	4.50
6	4874.00	53.1 AV	54.0	-0.9	1.16 V	43	48.60	4.50

REMARKS:

1. Emission Level(dBuV/m) = Raw Value(dBuV) + Correction Factor(dB/m)
2. Correction Factor(dB/m) = Antenna Factor(dB/m) + Cable Factor(dB) – Pre-Amplifier Factor(dB)
3. The other emission levels were very low against the limit.
4. Margin value = Emission Level – Limit value
5. “ * “: Fundamental frequency.



A D T

BELOW 1GHz WORST-CASE DATA : 802.11g

EUT TEST CONDITION		MEASUREMENT DETAIL	
CHANNEL	Channel 11	FREQUENCY RANGE	Below 1000MHz
INPUT POWER (SYSTEM)	120Vac, 60 Hz	DETECTOR FUNCTION	Quasi-Peak
ENVIRONMENTAL CONDITIONS	25deg. C, 65%RH	TESTED BY	Chris Lin

ANTENNA POLARITY & TEST DISTANCE: HORIZONTAL AT 3 M

NO.	FREQ. (MHz)	EMISSION LEVEL (dBuV/m)	LIMIT (dBuV/m)	MARGIN (dB)	ANTENNA HEIGHT (m)	TABLE ANGLE (Degree)	RAW VALUE (dBuV)	CORRECTION FACTOR (dB/m)
1	57.12	25.9 QP	40.0	-14.1	1.25 H	58	40.80	-14.90
2	249.60	27.8 QP	46.0	-18.2	1.00 H	234	42.00	-14.20
3	360.43	33.2 QP	46.0	-12.8	1.50 H	15	44.50	-11.30
4	440.14	27.9 QP	46.0	-18.1	1.25 H	332	37.30	-9.40
5	624.85	31.9 QP	46.0	-14.1	1.00 H	131	37.40	-5.50
6	751.23	32.8 QP	46.0	-13.2	1.50 H	18	35.80	-3.00

ANTENNA POLARITY & TEST DISTANCE: VERTICAL AT 3 M

NO.	FREQ. (MHz)	EMISSION LEVEL (dBuV/m)	LIMIT (dBuV/m)	MARGIN (dB)	ANTENNA HEIGHT (m)	TABLE ANGLE (Degree)	RAW VALUE (dBuV)	CORRECTION FACTOR (dB/m)
1	62.95	30.8 QP	40.0	-9.2	1.25 V	286	45.50	-14.70
2	103.78	26.1 QP	43.5	-17.4	1.00 V	341	44.20	-18.10
3	300.16	25.1 QP	46.0	-20.9	1.50 V	291	37.40	-12.30
4	624.85	35.2 QP	46.0	-10.8	1.25 V	185	40.70	-5.50
5	875.67	35.2 QP	46.0	-10.8	1.50 V	162	36.20	-1.00
6	959.27	39.3 QP	46.0	-6.7	1.00 V	198	38.50	0.80

REMARKS:

1. Emission Level(dBuV/m) = Raw Value(dBuV) + Correction Factor(dB/m)
2. Correction Factor(dB/m) = Antenna Factor(dB/m) + Cable Factor(dB) – Pre-Amplifier Factor (dB)
3. The other emission levels were very low against the limit.
4. Margin value = Emission Level – Limit value



A D T

4.2 CONDUCTED EMISSION MEASUREMENT

4.2.1 LIMITS OF CONDUCTED EMISSION MEASUREMENT

FREQUENCY OF EMISSION (MHz)	CONDUCTED LIMIT (dB μ V)	
	Quasi-peak	Average
0.15 ~ 0.5	66 to 56	56 to 46
0.5 ~ 5	56	46
5 ~ 30	60	50

- NOTE:** 1. The lower limit shall apply at the transition frequencies.
2. The limit decreases in line with the logarithm of the frequency in the range of 0.15 to 0.50MHz.
3. All emanations from a class A/B digital device or system, including any network of conductors and apparatus connected thereto, shall not exceed the level of field strengths specified above.

4.2.2 TEST INSTRUMENTS

Description & Manufacturer	Model No.	Serial No.	Cal. Date	Cal. Due
Test Receiver ROHDE & SCHWARZ	ESCS30	100288	Nov. 17, 2013	Nov. 16, 2014
RF signal cable Woken	5D-FB	Cable-HYCO2-01	Dec. 27, 2013	Dec. 26, 2014
LISN ROHDE & SCHWARZ (EUT)	ESH2-Z5	100100	Dec. 23, 2013	Dec. 22, 2014
LISN ROHDE & SCHWARZ (Peripheral)	ESH3-Z5	100312	Jul. 08, 2013	Jul. 07, 2014
Software ADT	BV ADT_Cond_ V7.3.7.3	NA	NA	NA

- Notes: 1. The calibration interval of the above test instruments is 12 months and the calibrations are traceable to NML/ROC and NIST/USA.
2. The test was performed in HwaYa Shielded Room 2.
3. The VCCI Site Registration No. is C-2047.

4.2.3 TEST PROCEDURES

- a. The EUT was placed 0.4 meters from the conducting wall of the shielded room with EUT being connected to the power mains through a line impedance stabilization network (LISN). Other support units were connected to the power mains through another LISN. The two LISNs provide 50 ohm/ 50uH of coupling impedance for the measuring instrument.
- b. Both lines of the power mains connected to the EUT were checked for maximum conducted interference.
- c. The frequency range from 150kHz to 30MHz was searched. Emission levels under (Limit - 20dB) was not recorded.

NOTE: All modes of operation were investigated and the worst-case emissions are reported.

4.2.4 DEVIATION FROM TEST STANDARD

No deviation.

4.2.5 TEST SETUP

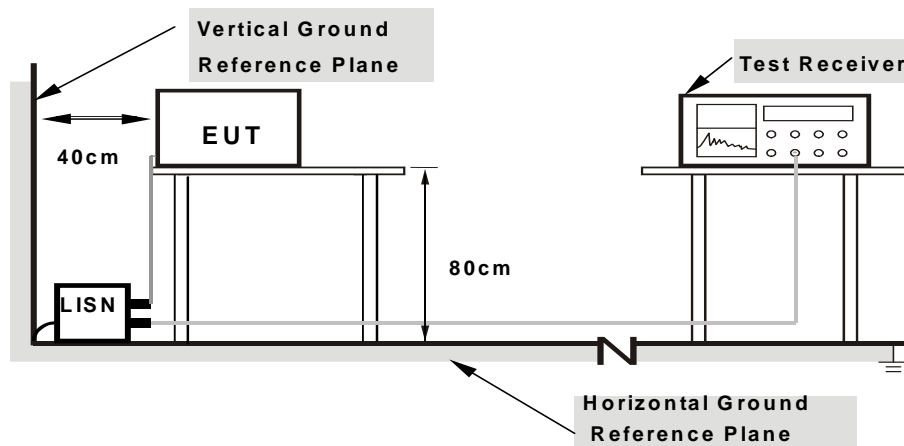

- Note:**
1. Support units were connected to second LISN.
 2. Both of LISNs (AMN) are 80 cm from EUT and at least 80 from other units and other metal planes

For the actual test configuration, please refer to the attached file (Test Setup Photo).

4.2.6 EUT OPERATING CONDITIONS

Same as 4.1.6.

4.2.7 TEST RESULTS

CONDUCTED WORST-CASE DATA : 802.11g

PHASE	Line 1	6dB BANDWIDTH	9kHz
-------	--------	---------------	------

No	Freq. [MHz]	Corr. Factor (dB)	Reading Value		Emission Level		Limit		Margin	
			[dB (uV)]		[dB (uV)]		[dB (uV)]		(dB)	
			Q.P.	AV.	Q.P.	AV.	Q.P.	AV.	Q.P.	AV.
1	0.15000	0.26	41.99	24.55	42.25	24.81	66.00	56.00	-23.75	-31.19
2	0.27109	0.29	38.99	36.32	39.28	36.61	61.08	51.08	-21.81	-14.48
3	0.77891	0.33	25.22	17.05	25.55	17.38	56.00	46.00	-30.45	-28.62
4	3.00781	0.40	30.44	24.22	30.84	24.62	56.00	46.00	-25.16	-21.38
5	7.77734	0.47	33.50	28.68	33.97	29.15	60.00	50.00	-26.03	-20.85
6	11.41016	0.51	22.05	17.39	22.56	17.90	60.00	50.00	-37.44	-32.10

- REMARKS:**
1. Q.P. and AV. are abbreviations of quasi-peak and average individually.
 2. The emission levels of other frequencies were very low against the limit.
 3. Margin value = Emission level - Limit value
 4. Correction factor = Insertion loss + Cable loss
 5. Emission Level = Correction Factor + Reading Value.

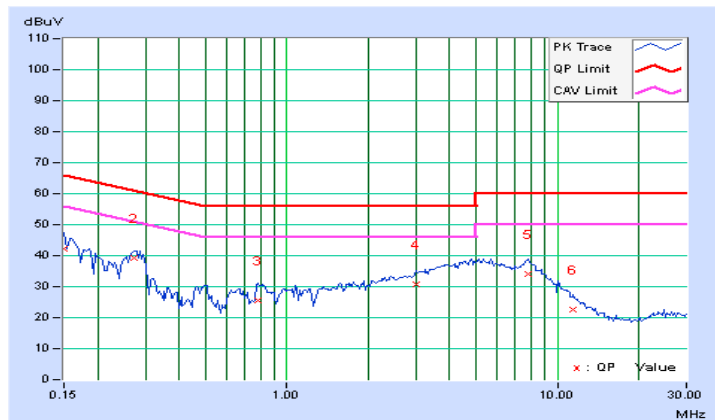



A D T

PHASE	Line 2	6dB BANDWIDTH	9kHz
-------	--------	---------------	------

No	Freq. [MHz]	Corr. Factor (dB)	Reading Value		Emission Level		Limit		Margin	
			[dB (uV)]		[dB (uV)]		[dB (uV)]		(dB)	
			Q.P.	AV.	Q.P.	AV.	Q.P.	AV.	Q.P.	AV.
1	0.15781	0.27	42.61	31.72	42.88	31.99	65.58	55.58	-22.70	-23.59
2	0.27109	0.29	39.46	36.68	39.75	36.97	61.08	51.08	-21.34	-14.12
3	0.78672	0.33	25.37	18.72	25.70	19.05	56.00	46.00	-30.30	-26.95
4	3.54688	0.42	31.36	25.75	31.78	26.17	56.00	46.00	-24.22	-19.83
5	5.28125	0.46	33.54	28.54	34.00	29.00	60.00	50.00	-26.00	-21.00
6	7.69141	0.49	33.47	28.63	33.96	29.12	60.00	50.00	-26.04	-20.88

- REMARKS:**
1. Q.P. and AV. are abbreviations of quasi-peak and average individually.
 2. The emission levels of other frequencies were very low against the limit.
 3. Margin value = Emission level - Limit value
 4. Correction factor = Insertion loss + Cable loss
 5. Emission Level = Correction Factor + Reading Value.

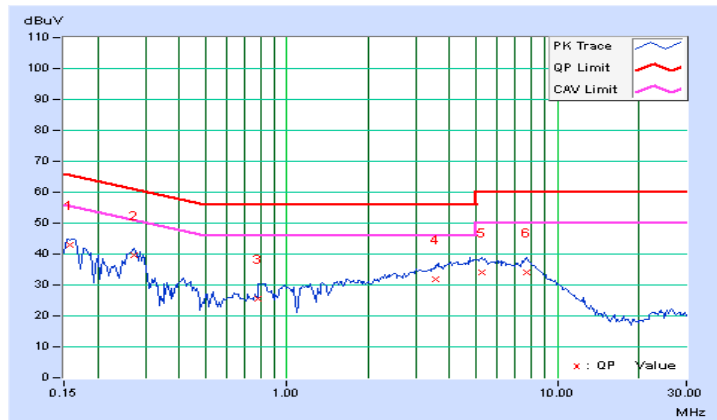



5. TEST TYPES AND RESULTS (FOR 5.0GHz BAND)

5.1 RADIATED EMISSION MEASUREMENT

5.1.1 LIMITS OF RADIATED EMISSION MEASUREMENT

Radiated emissions which fall in the restricted bands must comply with the radiated emission limits specified as below table. Other emissions shall be at least 20dB below the highest level of the desired power:

FREQUENCIES (MHz)	FIELD STRENGTH (microvolts/meter)	MEASUREMENT DISTANCE (meters)
0.009 ~ 0.490	2400/F(kHz)	300
0.490 ~ 1.705	24000/F(kHz)	30
1.705 ~ 30.0	30	30
30 ~ 88	100	3
88 ~ 216	150	3
216 ~ 960	200	3
Above 960	500	3

NOTE:

1. The lower limit shall apply at the transition frequencies.
2. Emission level (dBuV/m) = 20 log Emission level (uV/m).
3. For frequencies above 1000MHz, the field strength limits are based on average detector, however, the peak field strength of any emission shall not exceed the maximum permitted average limits, specified above by more than 20dB under any condition of modulation.



A D T

5.1.2 TEST INSTRUMENTS

Same as item 4.1.2.

5.1.3 TEST PROCEDURES

Same as item 4.1.3.

5.1.4 DEVIATION FROM TEST STANDARD

No deviation.

5.1.5 TEST SETUP

Same as item 4.1.5.

5.1.6 EUT OPERATING CONDITIONS

Same as item 4.1.6.



A D T

5.1.7 TEST RESULTS

ABOVE 1GHz DATA : 802.11n (20MHz)

EUT TEST CONDITION		MEASUREMENT DETAIL	
CHANNEL	Channel 165	FREQUENCY RANGE	1 ~ 40GHz
INPUT POWER (SYSTEM)	120Vac, 60Hz	DETECTOR FUNCTION	Peak (PK) Average (AV)
ENVIRONMENTAL CONDITIONS	25deg. C, 65%RH	TESTED BY	Chris Lin

ANTENNA POLARITY & TEST DISTANCE: HORIZONTAL AT 3 M								
NO.	FREQ. (MHz)	EMISSION LEVEL (dBuV/m)	LIMIT (dBuV/m)	MARGIN (dB)	ANTENNA HEIGHT (m)	TABLE ANGLE (Degree)	RAW VALUE (dBuV)	CORRECTION FACTOR (dB/m)
1	*5825.00	115.8 PK			1.00 H	194	77.10	38.70
2	*5825.00	105.1 AV			1.00 H	194	66.40	38.70
3	#5850.00	70.6 PK	95.8	-25.2	1.09 H	180	64.40	6.20
4	#5850.00	59.9 AV	85.1	-25.2	1.09 H	180	53.70	6.20
5	11650.00	64.1 PK	74.0	-9.9	1.00 H	207	43.80	20.30
6	11650.00	51.1 AV	54.0	-2.9	1.00 H	207	30.80	20.30
ANTENNA POLARITY & TEST DISTANCE: VERTICAL AT 3 M								
NO.	FREQ. (MHz)	EMISSION LEVEL (dBuV/m)	LIMIT (dBuV/m)	MARGIN (dB)	ANTENNA HEIGHT (m)	TABLE ANGLE (Degree)	RAW VALUE (dBuV)	CORRECTION FACTOR (dB/m)
1	*5825.00	116.4 PK			1.11 V	355	77.70	38.70
2	*5825.00	106.1 AV			1.11 V	355	67.40	38.70
3	#5850.00	71.2 PK	96.4	-25.2	1.09 V	180	65.00	6.20
4	#5850.00	60.9 AV	86.1	-25.2	1.09 V	180	54.70	6.20
5	11650.00	66.4 PK	74.0	-7.6	1.00 V	199	46.10	20.30
6	11650.00	52.5 AV	54.0	-1.5	1.00 V	199	32.20	20.30

REMARKS:

1. Emission Level(dBuV/m) = Raw Value(dBuV) + Correction Factor(dB/m)
2. Correction Factor(dB/m) = Antenna Factor(dB/m) + Cable Factor(dB)
– Pre-Amplifier Factor(dB)
3. The other emission levels were very low against the limit.
4. Margin value = Emission Level – Limit value
5. “ * “: Fundamental frequency.
6. The limit value is defined as per 15.247.
7. “#”:The radiated frequency is out the restricted band.



A D T

BELOW 1GHz WORST-CASE DATA : 802.11a

EUT TEST CONDITION		MEASUREMENT DETAIL	
CHANNEL	Channel 149	FREQUENCY RANGE	Below 1000MHz
INPUT POWER (SYSTEM)	120Vac, 60 Hz	DETECTOR FUNCTION	Quasi-Peak
ENVIRONMENTAL CONDITIONS	25deg. C, 65%RH	TESTED BY	Chris Lin

ANTENNA POLARITY & TEST DISTANCE: HORIZONTAL AT 3 M								
NO.	FREQ. (MHz)	EMISSION LEVEL (dBuV/m)	LIMIT (dBuV/m)	MARGIN (dB)	ANTENNA HEIGHT (m)	TABLE ANGLE (Degree)	RAW VALUE (dBuV)	CORRECTION FACTOR (dB/m)
1	57.12	26.0 QP	40.0	-14.0	1.25 H	334	40.90	-14.90
2	249.60	28.3 QP	46.0	-17.7	1.00 H	259	42.50	-14.20
3	300.16	34.5 QP	46.0	-11.5	1.50 H	2	46.80	-12.30
4	360.43	32.3 QP	46.0	-13.7	1.25 H	2	43.60	-11.30
5	624.85	32.1 QP	46.0	-13.9	1.00 H	134	37.60	-5.50
6	751.23	33.3 QP	46.0	-12.7	1.50 H	36	36.30	-3.00

ANTENNA POLARITY & TEST DISTANCE: VERTICAL AT 3 M								
NO.	FREQ. (MHz)	EMISSION LEVEL (dBuV/m)	LIMIT (dBuV/m)	MARGIN (dB)	ANTENNA HEIGHT (m)	TABLE ANGLE (Degree)	RAW VALUE (dBuV)	CORRECTION FACTOR (dB/m)
1	300.16	25.6 QP	46.0	-20.4	1.25 V	299	37.90	-12.30
2	500.42	30.0 QP	46.0	-16.0	1.00 V	357	38.30	-8.30
3	624.85	36.3 QP	46.0	-9.7	1.50 V	179	41.80	-5.50
4	751.23	29.5 QP	46.0	-16.5	1.25 V	308	32.50	-3.00
5	891.22	35.2 QP	46.0	-10.8	1.00 V	104	35.90	-0.70
6	961.21	39.8 QP	54.0	-14.2	1.50 V	152	39.10	0.70

REMARKS:

1. Emission Level(dBuV/m) = Raw Value(dBuV) + Correction Factor(dB/m)
2. Correction Factor(dB/m) = Antenna Factor(dB/m) + Cable Factor(dB) – Pre-Amplifier Factor (dB)
3. The other emission levels were very low against the limit.
4. Margin value = Emission Level – Limit value



5.2 CONDUCTED EMISSION MEASUREMENT

5.2.1 LIMITS OF CONDUCTED EMISSION MEASUREMENT

FREQUENCY OF EMISSION (MHz)	CONDUCTED LIMIT (dB μ V)	
	Quasi-peak	Average
0.15 ~ 0.5	66 to 56	56 to 46
0.5 ~ 5	56	46
5 ~ 30	60	50

- NOTE:**
1. The lower limit shall apply at the transition frequencies.
 2. The limit decreases in line with the logarithm of the frequency in the range of 0.15 to 0.50MHz.
 3. All emanations from a class A/B digital device or system, including any network of conductors and apparatus connected thereto, shall not exceed the level of field strengths specified above.

5.2.2 TEST INSTRUMENTS

Same as item 4.2.2.

5.2.3 TEST PROCEDURES

Same as item 4.2.3.

5.2.4 DEVIATION FROM TEST STANDARD

No deviation.

5.2.5 TEST SETUP

Same as item 4.2.5.

5.2.6 EUT OPERATING CONDITIONS

Same as item 4.1.6.

5.2.7 TEST RESULTS

CONDUCTED WORST-CASE DATA : 802.11a

PHASE	Line 1	6dB BANDWIDTH	9kHz
--------------	--------	----------------------	------

No	Freq. [MHz]	Corr. Factor (dB)	Reading Value		Emission Level		Limit		Margin	
			[dB (uV)]		[dB (uV)]		[dB (uV)]		(dB)	
			Q.P.	AV.	Q.P.	AV.	Q.P.	AV.	Q.P.	AV.
1	0.15781	0.27	42.57	30.56	42.84	30.83	65.58	55.58	-22.74	-24.75
2	0.27109	0.29	39.06	36.45	39.35	36.74	61.08	51.08	-21.74	-14.35
3	0.81016	0.33	28.50	22.52	28.83	22.85	56.00	46.00	-27.17	-23.15
4	3.82031	0.42	32.65	27.67	33.07	28.09	56.00	46.00	-22.93	-17.91
5	7.69141	0.47	33.37	28.41	33.84	28.88	60.00	50.00	-26.16	-21.12
6	11.50000	0.51	21.77	17.01	22.28	17.52	60.00	50.00	-37.72	-32.48

REMARKS:

1. Q.P. and AV. are abbreviations of quasi-peak and average individually.
2. The emission levels of other frequencies were very low against the limit.
3. Margin value = Emission level - Limit value
4. Correction factor = Insertion loss + Cable loss
5. Emission Level = Correction Factor + Reading Value.

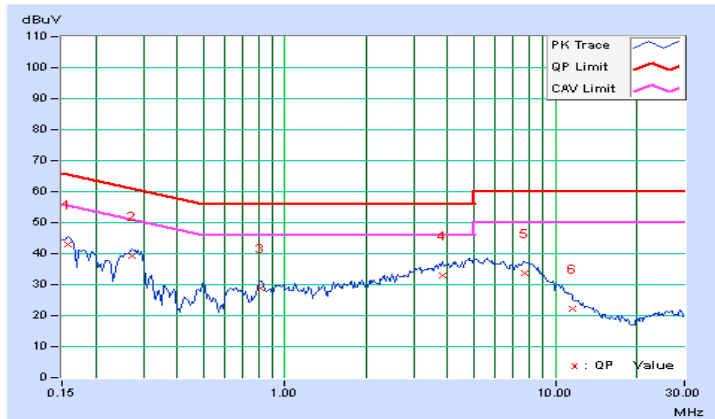



A D T

PHASE	Line 2	6dB BANDWIDTH	9kHz
-------	--------	---------------	------

No	Freq. [MHz]	Corr. Factor (dB)	Reading Value		Emission Level		Limit		Margin	
			[dB (uV)]		[dB (uV)]		[dB (uV)]		(dB)	
			Q.P.	AV.	Q.P.	AV.	Q.P.	AV.	Q.P.	AV.
1	0.15391	0.27	42.12	27.71	42.39	27.98	65.79	55.79	-23.40	-27.81
2	0.27500	0.29	39.04	36.01	39.33	36.30	60.97	50.97	-21.64	-14.67
3	0.82188	0.33	28.36	22.50	28.69	22.83	56.00	46.00	-27.31	-23.17
4	2.31641	0.38	29.57	23.24	29.95	23.62	56.00	46.00	-26.05	-22.38
5	4.41797	0.45	32.94	27.78	33.39	28.23	56.00	46.00	-22.61	-17.77
6	7.66406	0.49	33.47	28.69	33.96	29.18	60.00	50.00	-26.04	-20.82

REMARKS:

1. Q.P. and AV. are abbreviations of quasi-peak and average individually.
2. The emission levels of other frequencies were very low against the limit.
3. Margin value = Emission level - Limit value
4. Correction factor = Insertion loss + Cable loss
5. Emission Level = Correction Factor + Reading Value.

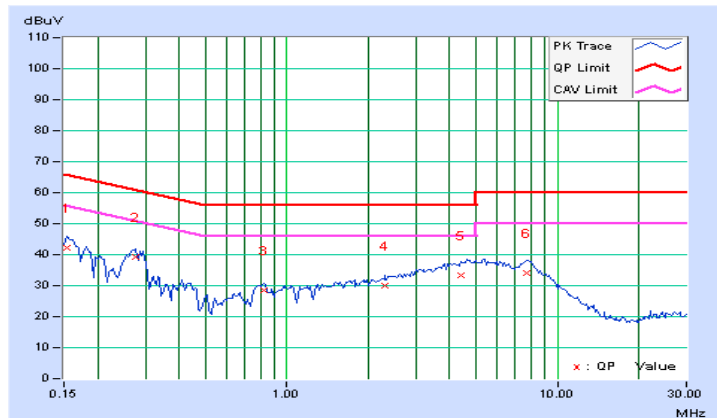



A D T

6. PHOTOGRAPHS OF THE TEST CONFIGURATION

Please refer to the attached file (Test Setup Photo).



A D T

7. INFORMATION ON THE TESTING LABORATORIES

We, Bureau Veritas Consumer Products Services (H.K.) Ltd., Taoyuan Branch, were founded in 1988 to provide our best service in EMC, Radio, Telecom and Safety consultation. Our laboratories are accredited and approved according to ISO/IEC 17025.

If you have any comments, please feel free to contact us at the following:

Linko EMC/RF Lab

Tel: 886-2-26052180

Fax: 886-2-26051924

Hsin Chu EMC/RF Lab

Tel: 886-3-5935343

Fax: 886-3-5935342

Hwa Ya EMC/RF/Safety/Telecom Lab

Tel: 886-3-3183232

Fax: 886-3-3270892

Email: service.adt@tw.bureauveritas.com

Web Site: www.bureauveritas-adt.com

The address and road map of all our labs can be found in our web site also.



A D T

8. APPENDIX A – MODIFICATIONS RECORDERS FOR ENGINEERING CHANGES TO THE EUT BY THE LAB

No modifications were made to the EUT by the lab during the test.

---END---