

Specific Absorption Rate (SAR) Test Report
for
ZyXEL Communications Corporation
on the
802.11g Wireless USB Stick
Model Number: ZyAIR G-220

Test Report: EME-041086
Date of Report: Nov. 23, 2004
Date of test: Nov. 16, 2004

Total No of Pages Contained in this Report: 71

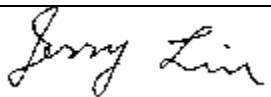

Accredited for testing to FCC Part 15

Tested by: Kevin Chen	
Reviewed by: Jerry Liu	

Review Date: Dec. 17, 2004

All services undertaken are subject to the following general policy: Reports are submitted for exclusive use of the client to whom they are addressed. Their significance is subject to the adequacy and representative character of the samples and to the comprehensiveness of the tests, examinations or surveys made. This report shall not be reproduced except in full, without written consent of Intertek Testing Services, Taiwan Ltd.

Table of Contents

- STATEMENT OF COMPLIANCE 3
- 1.0 Job Description 4
 - 1.1 Client Information..... 4
 - 1.2 Equipment under test (EUT)..... 4
 - 1.3 Test plan reference 5
 - 1.4 System test configuration 5
 - 1.4.1 Support equipment & System block diagram 5
 - 1.4.2 Test Position 6
 - 1.4.3 Test Condition 6
 - 1.5 Modifications required for compliance 7
 - 1.6 Additions, deviations and exclusions from standards 7
- 2.0 SAR Evaluation 8
 - 2.1 SAR Limits 8
 - 2.2 Configuration Photographs..... 9
 - 2.3 SAR measurement system 13
 - 2.4 SAR measurement system validation..... 14
 - 2.4.1 System Validation result 15
 - 2.4.2 System Performance Check result..... 17
 - 2.5 Test Result..... 19
- 3.0 Test Equipment 20
 - 3.1 Equipment List 20
 - 3.2 Tissue Simulating Liquid..... 21
 - 3.2.1 Body Tissue Simulating Liquid for evaluation test..... 21
 - 3.2.2 Head Tissue Simulating Liquid for System performance Check test..... 21
 - 3.2.3 Body Liquid results 22
 - 3.2.4 Head Liquid results 23
 - 3.3 E-Field Probe and 2450 Balanced Dipole Antenna Calibration 24
- 4.0 Measurement Uncertainty 25
- 5.0 Measurement Traceability 27
- 6.0 WARNING LABEL INFORMATION - USA..... 27
- 7.0 REFERENCES 28
- 8.0 DOCUMENT HISTORY 29
- APPENDIX A - SAR Evaluation Data 30
- APPENDIX B - Photographs 43
- APPENDIX C - E-Field Probe and 2450MHz Balanced Dipole Antenna Calibration Data 45

STATEMENT OF COMPLIANCE

The ZyXEL sample device, model # ZyAIR G-220 was evaluated in accordance with the requirements for compliance testing defined in FCC OET Bulletin 65, Supplement C (Edition 01-01). Testing was performed at the Intertek Testing Services facility in Hsinchu, Taiwan.

For the evaluation, the dosimetric assessment system INDEXSAR SARA2 was used. The phantom employed was the box phantom of 2mm thick in one wall. The total uncertainty for the evaluation of the spatial peak SAR values averaged over a cube of 1g tissue mass had been assessed for this system to be $\pm 20.6\%$.

The device was tested at their maximum output power declared by the ZyXEL.

In summary, the maximum spatial peak SAR value for the sample device averaged over 1g was found to be:

Phantom	Position (worst case)	SAR_{1g}, mW/g
2mm thick box phantom wall	802.11b middle channel EUT bottom to the phantom, 0 mm separation.	0.787 mW/g.

In conclusion, the tested Sample device was found to be in compliance with the requirements defined in OET Bulletin 65, Supplement C (Edition 01-01) for body configurations.

1.0 Job Description

1.1 Client Information

The ZyAIR G-220 has been tested at the request of:

Company: ZyXEL Communications Corporation
No. 6, Innovation Rd II, Science-Based Industrial Park,
Hsin-Chu, Taiwan

1.2 Equipment under test (EUT)

Product Descriptions:

Equipment		802.11g Wireless USB Stick	
Trade Name	ZyXEL	Model No:	ZyAIR G-220
FCC ID	I88G-220	S/N No.	Not Labeled
Category	Portable	RF Exposure	Uncontrolled Environment
Frequency Band	2412 – 2462 MHz	System	DSSS, OFDM

EUT Antenna Description			
Type	Chip Antenna	Configuration	Fixed
Dimensions	5 x 2 mm	Gain	0 dBi
Location	Embedded		

Use of Product : Wireless Data Communication

Manufacturer: ZyXEL

Production is planned: Yes, No

EUT receive date: Nov. 5, 2004

EUT received condition: Good operating condition prototype

Test start date: Nov. 16, 2004

Test end date: Nov. 16, 2004

1.3 Test plan reference

FCC Rule: Part 2.1093, FCC's OET Bulletin 65, Supplement C (Edition 01-01) and IEEE 1528

1.4 System test configuration

1.4.1 Support equipment & System block diagram

Support Equipment				
Item #	Equipment	Brand	Model No.	S/N
1	Notebook PC	DELL	PP05L	CN-0G5152-48643-498-6810



1.4.2 Test Position

See the photographs as section 2.2

1.4.3 Test Condition

During tests the worst-case data (max RF coupling) was determined with following conditions:

Usage	Operates with a portable computer	Distance between antenna axis at the joint and the liquid surface:	Laptop is touching the Phantom in bottom position, separating 0mm in front position, separating 0mm and 15mm in rear position.	
Simulating human Head/ Body/Hand	Body	EUT Battery	Device is powered from host computer through battery.	
Conducted output Power	Channel	Frequency MHz	Before SAR Test (dBm)	After SAR Test (dBm)
	Low Channel - 1	2412	19.57	-
	Mid Channel - 6	2437	19.66	19.65
	High Channel- 11	2462	19.70	-
802.11g Conducted output Power	Channel	Frequency MHz	Before SAR Test (dBm)	After SAR Test (dBm)
	Low Channel - 1	2412	19.37	-
	Mid Channel - 6	2437	19.42	19.41
	High Channel- 11	2462	19.60	-

The spatial peak SAR values were assessed for lowest, middle and highest operating channels, defined by the manufacturer.

The conducted output power was measured before and after the test using a wideband peak power meter/sensor.

Plug the EUT into notebook via USB interface, then turn on the Notebook power and run the test program “ZD1211EVL.exe” under windows OS, which provide by manufacturer.

It worked in the status of continuously transmitting.

We verified that G-220 and G220 are series model to ZyAIR G-220, for these models are identical in hardware aspect, and the different is in model number only.

After verifying the maximum output power, we found the maximum output power was occurred at 11Mbps data rate in 802.11b and at 54 Mbps data rate in 802.11g. The final test was executed under this condition and recorded in this report individually.

1.5 Modifications required for compliance

Intertek Testing Services implemented no modifications.

1.6 Additions, deviations and exclusions from standards

The phantom employed was the box phantom of 2mm thick in vertical wall.

2.0 SAR Evaluation

2.1 SAR Limits

The following FCC limits for SAR apply to devices operate in General Population/Uncontrolled Exposure environment:

EXPOSURE (General Population/Uncontrolled Exposure environment)	SAR (W/kg)
Average over the whole body	0.08
Spatial Peak (1g)	1.60
Spatial Peak for hands, wrists, feet and ankles (10g)	4.00

2.2 Configuration Photographs

SAR Measurement Test Setup

Test System



SAR Measurement Test Setup

Bottom side of Laptop facing phantom touching



Bottom side of Laptop facing phantom touching-Zoon In



SAR Measurement Test Setup

EUT rear to phantom, 0 mm separation

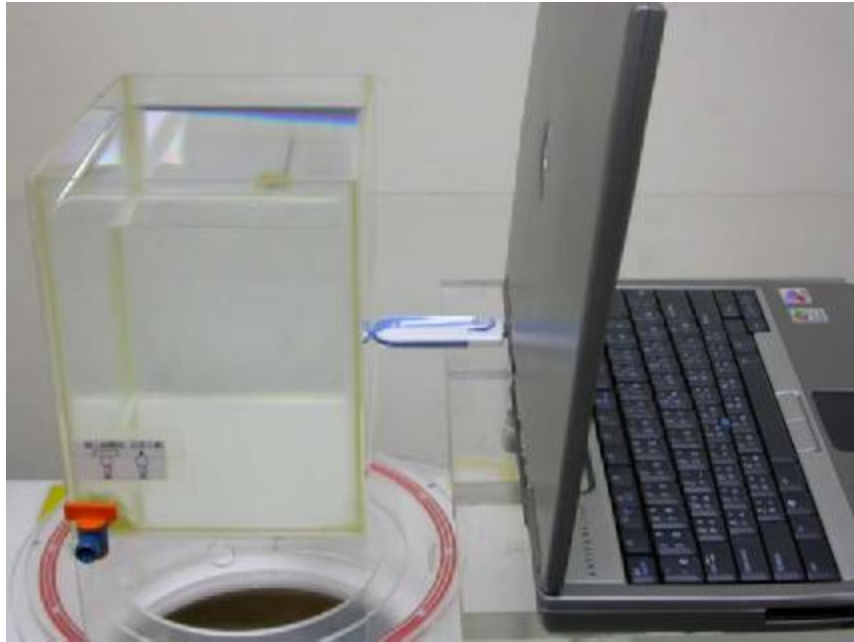

EUT perpendicular to phantom, 0 mm separation-Zoon In

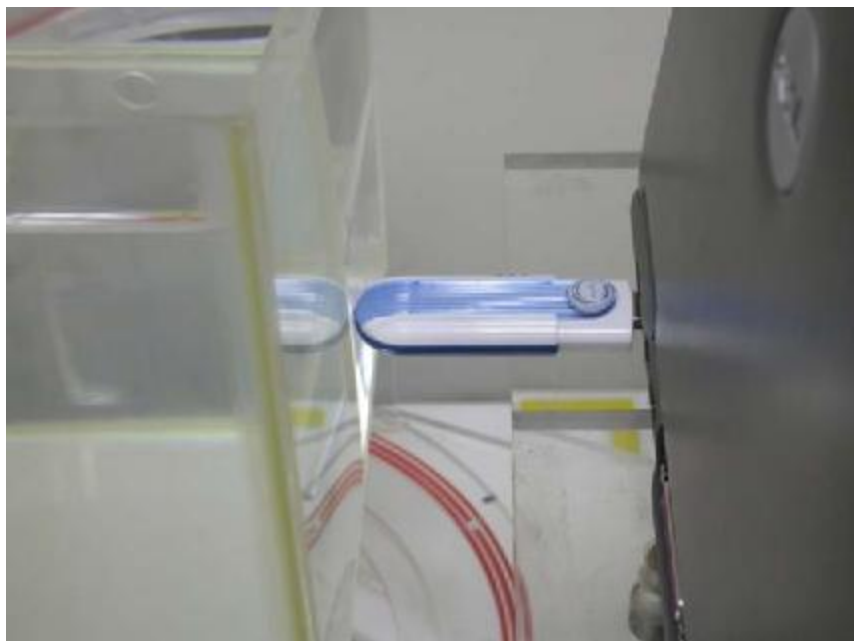

SAR Measurement Test Setup

EUT rear to phantom, 15 mm separation



EUT perpendicular to phantom, 15 mm separation-Zoon In

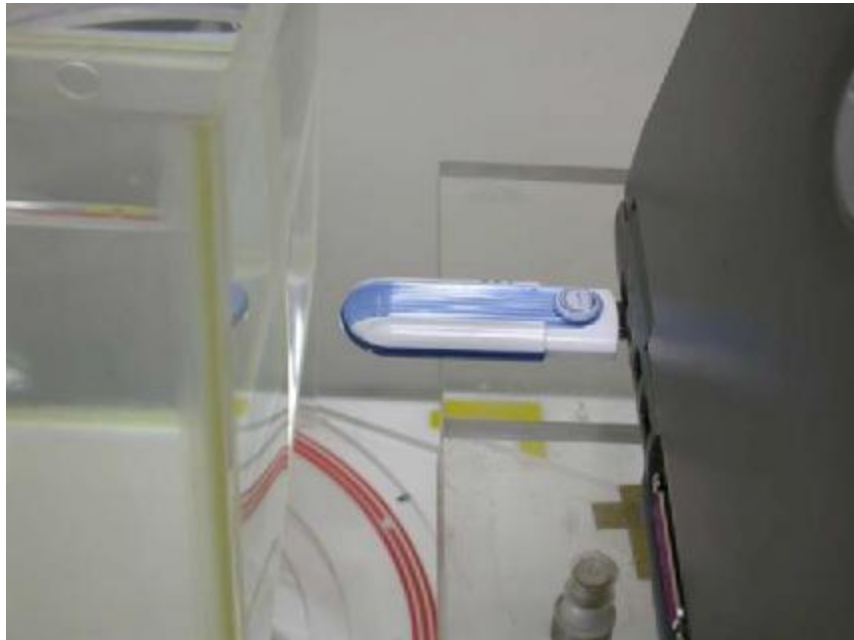

2.3 SAR measurement system

Robot system specification

The SAR measurement system being used is the IndexSAR SARA2 system, which consists of a Mitsubishi RV-E2 6-axis robot arm and controller, IndexSAR probe and amplifier and SAM phantom Head Shape. The robot is used to articulate the probe to programmed positions inside the phantom head to obtain the SAR readings from the DUT.

The system is controlled remotely from a PC, which contains the software to control the robot and data acquisition equipment. The software also displays the data obtained from test scans.

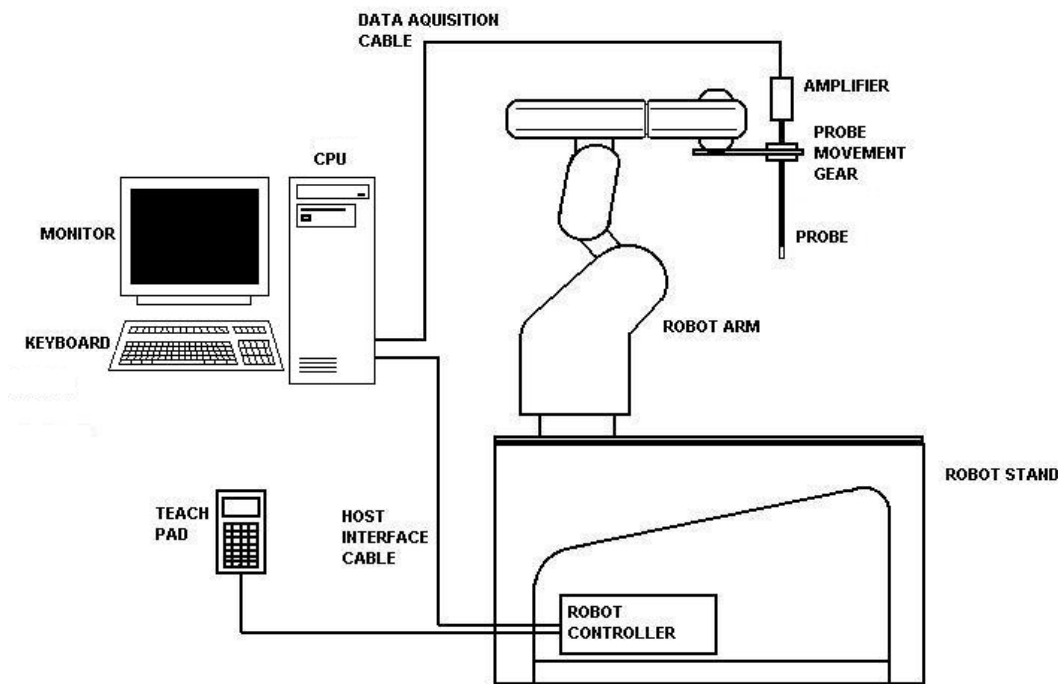

Figure 1: Schematic diagram of the SAR measurement system

The position and digitised shape of the phantom heads are made available to the software for accurate positioning of the probe and reduction of set-up time.

The SAM phantom heads are individually digitised using a Mitutoyo CMM machine to a precision of 0.02mm. The data is then converted into a shape format for the software, providing an accurate description of the phantom shell. In operation, the system first does an area (2D) scan at a fixed depth within the liquid from the inside wall of the phantom. When the maximum SAR point has been found, the system will then carry out a 3D scan centred at that point to determine volume averaged SAR level.

The first 2 measurements points in a direction perpendicular to the surface of the phantom during the zoom scan and closest to the phantom surface, were only 3.5mm and the probe is kept at greater than half a diameter from the surface.

2.4 SAR measurement system validation

Prior to the assessment, the system was verified to the $\pm 10\%$ of the specifications by using the system validation equipments. The validation was performed at 2450 MHz on the bottom side of box phantom.

Procedures

The SAR evaluation was performed with the following procedures:

- a. The SAR distribution was measured at the exposed side of the bottom of the box phantom and was measured at a distance of 8 mm from the inner surface of the shell. The feed power was 1/5 W.
- b. The dimension for this cube is 32 mm x 32 mm x 34 mm was assessed by measuring 5 x 5 x 7 points. On the basis of this data set, the spatial peak SAR value was evaluated with the following procedure:
 - i) The data at the surface were extrapolated, since the center of the dipoles is 2.7 mm away from the tip of the probe and the distance between the surface and the lowest measurement point is 5 mm. The extrapolation was based on a least square algorithm. A polynomial of the fourth order was calculated through the points in Z-axes. This polynomial was then used to evaluate the points between the surface and the probe tip.
 - ii) The maximum interpolated value was searched with a straightforward algorithm. Around this maximum, the SAR values averaged over the spatial volumes (1g or 10g) were computed using the 3-D spline interpolation algorithm. The 3-D spline is composed of three one-dimensional splines with the "Not a knot" condition (in x, y and z directions). The volume was integrated with the trapezoidal algorithm. 1000 points (10 x 10 x 10) were interpolated to calculate the average.
 - iii) All neighboring volumes were evaluated until no neighboring volume with a higher average value was found.

The test scan procedure for system validation also apply to the general scan procedure except for the set-up position. For general scan, the EUT was placed at the side of phantom. For validation scan, the dipole antenna was placed at the bottom of phantom

2.4.1 System Validation result

System Validation (2450 MHz Head)				
Frequency MHz	Operating Mode	Target SAR_{1g} (mW/g)	Measured SAR_{1g} (mW/g)	Deviation (±10%)
2450	CW	52.4	52.36	-0.07%

Please see the plot below:

Date: 2004/10/1	Position: Bottom
Filename: 2450val10-15.txt	Phantom: Box1.csv
Device Tested: SARA2 system	Head Rotation: 0
Antenna: 2450dipole	Test Frequency: 2450MHz
Shape File: none.csv	Power Level: 23dBm /CW

Probe:	0149			
Cal File:	SN0149_2450_CW_HEAD			
Cal Factors:		X	Y	Z
	Air	365	444	414
	DCP	20	20	20
	Lin	.561	.561	.561
Amp Gain:	2			
Averaging:	1			
Batteries Replaced:	-			

Liquid:	15.5cm
Type:	2450MHz Head
Conductivity:	1.804
Relative Permittivity:	38.122
Liquid Temp (deg C):	23.3
Ambient Temp (deg C):	23
Ambient RH (%):	50
Density (kg/m3):	1000
Software Version:	2.3VPM
Crest Factor = 1	

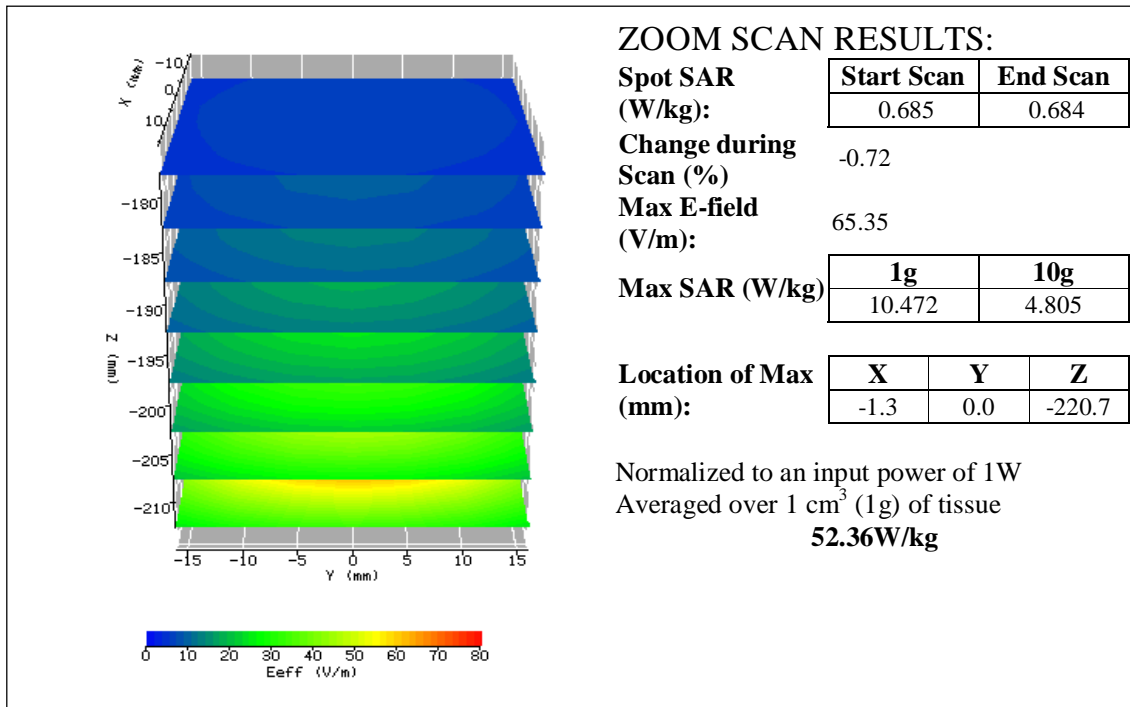

2.4.2 System Performance Check result

System performance check (2450 MHz Head)				
Frequency MHz	Operating Mode	Target SAR_{1g} (mW/g)	Measured SAR_{1g} (mW/g)	Deviation (±10%)
2450	CW	52.4	48.825	-6.82%

Please see the plot below:

Date:	2004/11/15	Position:	Bottom of phantom box
Filename:	2450 performance check.txt	Phantom:	HeadBox1-val..csv
Device Tested:	2450 performance check	Head Rotation:	0
Antenna:	2450 MHz dipole	Test Frequency:	2450 MHz
Shape File:	none.csv	Power Level:	23 dBm

Probe:	0149			
Cal File:	SN0149_2450_CW_HEAD			
Cal Factors:		X	Y	Z
	Air	365	444	414
	DCP	20	20	20
	Lin	.504	.504	.504
Amp Gain:	2			
Averaging:	1			
Batteries Replaced:				

Liquid:	15.5cm
Type:	2450 head
Conductivity:	1.841
Relative Permittivity:	39.2
Liquid Temp (deg C):	22.8
Ambient Temp (deg C):	23
Ambient RH (%):	55
Density (kg/m3):	1000
Software Version:	2.3VPM
Crest Factor =	1

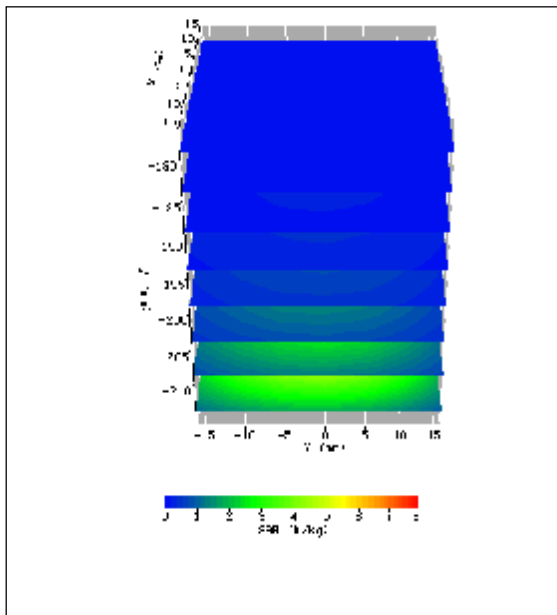

ZOOM SCAN RESULTS:

Spot SAR (W/kg):	Start Scan	End Scan
	0.637	0.638

Change during Scan (%) 0.19

Max E-field (V/m): 62.93

Max SAR (W/kg)	1g	10g
	9.765	4.578

Location of Max (mm):	X	Y	Z
	0.0	0.0	-221.8

Normalized to an input power of 1W
 Averaged over 1 cm³ (1g) of tissue
48.825W/kg

2.5 Test Result

The results on the following page(s) were obtained when the device was tested in the condition described in this report. Detailed measurement data and plots, which reveal information about the location of the maximum SAR with respect to the device, are reported in Appendix A.

Measurement Results

Trade Name:	ZyXEL	Model No.:	ZyAIR G-220
Serial No.:	Not Labeled	Test Engineer:	Kevin Chen
TEST CONDITIONS			
Ambient Temperature	21.8 °C	Relative Humidity	50.2 %
Test Signal Source	Test Mode	Signal Modulation	DSSS, OFDM
Output Power Before SAR Test	See page 6	Output Power After SAR Test	See page 6
Test Duration	24 min. each scan	Number of Battery Change	1

EUT Position						
Channel (MHz)	Operating Mode	Crest Factor	Description	Distance (mm)	Measured SAR_{1g} (mW/g)	Plot Number
2437	DSSS	1	Bottom to phantom	0	0.787	1
2437	DSSS	1	Perpendicular to phantom	0	0.112	2
2437	DSSS	1	Perpendicular to phantom	15	0.020	3
2437	OFDM	1	Bottom to phantom	0	0.326	4
2437	OFDM	1	Perpendicular to phantom	0	0.042	5
2437	OFDM	1	Perpendicular to phantom	15	0.009	6

Note: 1. The distance from bottom of EUT to flat phantom is 2 mm.
 2. Configuration at middle channel with more than -3dB of applicable limit.

3.0 Test Equipment

3.1 Equipment List

The Specific Absorption Rate (SAR) tests were performed with the INDEXSAR SARA2 SYSTEM.

The following major equipment/components were used for the SAR evaluations:

SAR Measurement System			
EQUIPMENT	SPECIFICATIONS	S/N #	LAST CAL. DATE
Balanced Validation dipole	2450MHz	0048	03/26/2003
Controller	Mitsubishi CR-E116	F1008007	N/A
Robot	Mitsubishi RV-E2	EA009002	N/A
	Repeatability: ± 0.04mm; Number of Axes: 6		
E-Field Probe	IXP-050	0149	05/2004
	Frequency Range: Probe outer diameter: 5.2 mm; Length: 350 mm; Distance between the probe tip and the dipole center: 2.7 mm		
Data Acquisition	SARA2	N/A	N/A
	Processor: Pentium 4; Clock speed: 1.5GHz; OS: Windows XP; I/O: two RS232; Software: SARA2 ver. 2.3VPM (Virtual Probe Minaturisation)		
Phantom	2mm wall thickness box phantom	N/A	N/A
	Shell Material: clear Perspex; Thickness: 2 ± 0.1 mm; Capacity: 152.5 x 225.5 x 200 (W x L x D) mm ³ ; Dielectric constant: less than 2.85 above 500MHz;		
Device holder	Material: clear Perspex; Dielectric constant: less than 2.85 above 500MHz	N/A	N/A
Simulated Tissue	Mixture	N/A	11/15/2004
	Please see section 3.2 for details		
RF Power Meter	Boonton 4231A with 51011-EMC power sensor	79401-32482	03/22/2004
	Frequency Range: 0.03 to 8 GHz, <24dBm		
Vector Network Analyzer	HP 8753B HP 85046A	2807J04037 2729A01958	08/19/2004
	Frequency Range: 300k to 3GHz		
Signal Generator	R&S SMR27	100036	08/19/2004
	10M to 27GHz, <120dBuV		
Wideband Peak Power Meter/ Sensor	Anritsu ML2497A with MA2491A power sensor	6K00002322/ 031543	N/A
	Frequency Range: 100 MHz to 18 GHz		

3.2 Tissue Simulating Liquid

The head and body tissue parameters should be used to test operating frequency band of transmitters. When a transmission band overlaps with one of the target frequencies, the tissue dielectric parameters of the tissue medium at the middle of a device transmission band should be within $\pm 5\%$ of the parameters specified at that target frequency.

3.2.1 Body Tissue Simulating Liquid for evaluation test

Body Ingredients Frequency (2.45 GHz)	
DGBE (Dilethylene Glycol Butyl Ether)	26.7%
Salt	0.04%
Water	73.2%

The dielectric parameters were verified prior to assessment using the HP 85046A dielectric probe kit and the HP 8753B network Analyzer. The dielectric parameters were:

Frequency (MHz)	Temp. (°C)	e _r / Relative Permittivity			s / Conductivity (mho/m)			r *(kg/m ³)
		measured	target	Δ(±5%)	measured	target	Δ(±5%)	
2450	22.2	50.72	52.7	-3.76%	1.96	1.95	0.51%	1000

**Worst-case assumption*

3.2.2 Head Tissue Simulating Liquid for System performance Check test

Head Ingredients Frequency (2.45 GHz)	
DGBE (Dilethylene Glycol Butyl Ether)	53.3%
Water	46.7%

The dielectric parameters were verified prior to assessment using the HP 85046A dielectric probe kit and the HP 8753B network Analyzer. The dielectric parameters were:

Frequency (MHz)	Temp. (°C)	e _r / Relative Permittivity			s / Conductivity (mho/m)			r *(kg/m ³)
		measured	target	Δ(±5%)	measured	target	Δ(±5%)	
2450	23.5	39.20	39.20	0%	1.84	1.80	2.22%	1000

**Worst-case assumption*

3.2.3 Body Liquid results

Date: 15 Nov. 2004	Temperature: 22.2 °C	Type: 2450 MHz/ body (FCC)	Tested by: Kevin
2410, 50.0373664851, -2.021392968		2450, 50.7189284235, -1.9621693508	
2411, 50.0666930083, -2.0211671148		2451, 50.7482055161, -1.9614024746	
2412, 50.0943336901, -2.0181170366		2452, 50.7835742776, -1.9685104344	
2413, 50.0493386512, -2.0177952385		2453, 50.8017342911, -1.9705680131	
2414, 50.1084415733, -2.0103907917		2454, 50.8011787742, -1.9775475618	
2415, 50.0586895758, -2.0068274968		2455, 50.8506223235, -1.9735157355	
2416, 50.0930300086, -2.0066746885		2456, 50.8803648888, -1.9778793401	
2417, 50.0616378648, -2.0053633944		2457, 50.8929318535, -1.9760350489	
2418, 50.072115498, -1.9994133124		2458, 50.9169269209, -1.9876387617	
2419, 50.0857607851, -1.9985406835		2459, 50.9588233286, -1.9862534629	
2420, 50.0457588876, -1.9905172228		2460, 50.9694887379, -1.9958332179	
2421, 50.0785493258, -1.9912228878		2461, 51.0194866297, -1.9864598285	
2422, 50.1067444706, -1.9891143993		2462, 51.0044623548, -1.9945136144	
2423, 50.0659958799, -1.9846780719		2463, 51.021337162, -2.000394829	
2424, 50.0893761641, -1.9807401093		2464, 51.0744261593, -2.0023556191	
2425, 50.1230068825, -1.9837877731		2465, 51.0760644108, -2.0066183579	
2426, 50.1309240335, -1.9767874451		2466, 51.0867543581, -2.0120802916	
2427, 50.1547608238, -1.9738208629		2467, 51.0966860756, -2.0112372686	
2428, 50.1708058897, -1.9755058703		2468, 51.1066807859, -2.0138500392	
2429, 50.1844780711, -1.9729456296		2469, 51.1487333304, -2.0279551711	
2430, 50.1654332759, -1.9643904256		2470, 51.1530833036, -2.0241840055	
2431, 50.2183638952, -1.9669831559		2471, 51.1906000044, -2.0303967626	
2432, 50.2892746282, -1.963562682		2472, 51.1962598251, -2.0391025878	
2433, 50.2750151442, -1.9697478291		2473, 51.2069749286, -2.0416059983	
2434, 50.3044809514, -1.9621004882		2474, 51.1647721045, -2.0436584109	
2435, 50.2864903691, -1.9593389709		2475, 51.2068724488, -2.0470181629	
2436, 50.3408331059, -1.9565833985		2476, 51.2574955449, -2.0613062871	
2437, 50.372138785, -1.9546379558		2477, 51.295869078, -2.0575789114	
2438, 50.3654678177, -1.9571203689		2478, 51.2271798179, -2.0671614867	
2439, 50.4352994989, -1.9572966118		2479, 51.2704527739, -2.0678424117	
2440, 50.429723053, -1.9595589897		2480, 51.2704527739, -2.0726355441	
2441, 50.4780874884, -1.9581991359		2481, 51.2753737889, -2.0719691528	
2442, 50.4542349524, -1.9581708352		2482, 51.3262329811, -2.0832054716	
2443, 50.5415201006, -1.9616888211		2483, 51.292198485, -2.088140038	
2444, 50.5528792394, -1.9571966218		2484, 51.3344036806, -2.0910759036	
2445, 50.6093360918, -1.9593256336		2485, 51.2946946027, -2.1013612229	
2446, 50.61677656, -1.9652543314		2486, 51.3383801078, -2.1100563918	
2447, 50.6385683445, -1.9564178575		2487, 51.308173428, -2.1112155079	
2448, 50.6676328347, -1.9624300871		2488, 51.2710821372, -2.1137791818	
2449, 50.6971020569, -1.9621416854		2489, 51.2975179404, -2.1210965818	
		2490, 51.2503213372, -2.1196075328	

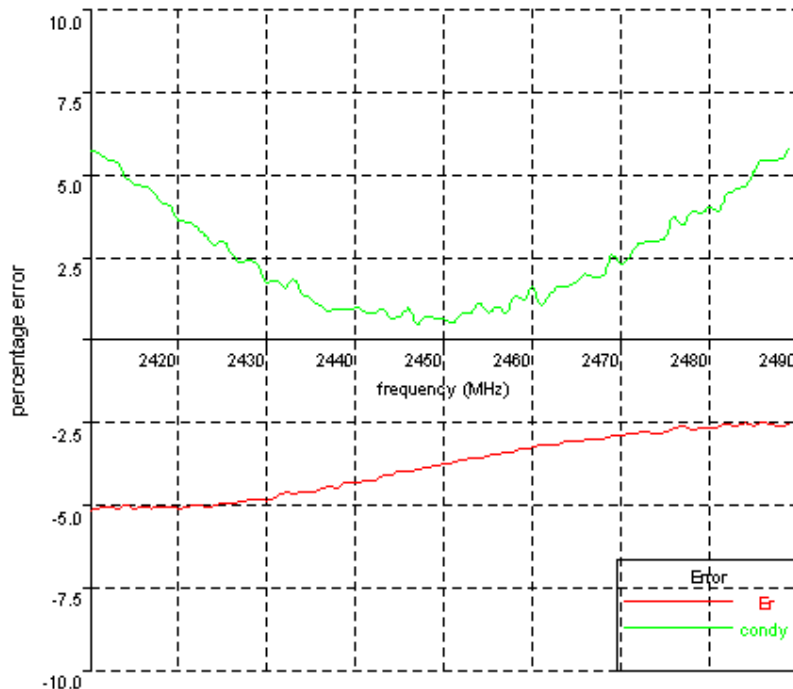

3.2.4 Head Liquid results

Date: 15 Nov. 2004	Temperature: 23.5 °C	Type: 2450 MHz/ head (FCC)	Tested by: Kevin
2410, 38.6770591052, -1.8917982474		2450, 39.2004752944, -1.8412954749	
2411, 38.6741923477, -1.8846487264		2451, 39.2623468833, -1.8447700018	
2412, 38.6717958705, -1.8870299643		2452, 39.2387680031, -1.8383462575	
2413, 38.672782566, -1.8822480998		2453, 39.3180651218, -1.8455107807	
2414, 38.6613941622, -1.8835138306		2454, 39.2901539758, -1.8456521631	
2415, 38.6370712167, -1.8801480033		2455, 39.2994285251, -1.852229473	
2416, 38.6644219617, -1.8774873645		2456, 39.363637246, -1.8575069717	
2417, 38.6611333814, -1.869213961		2457, 39.3713369264, -1.8565535788	
2418, 38.6487622489, -1.8667745582		2458, 39.398202211, -1.8544885927	
2419, 38.6317013234, -1.8693104012		2459, 39.4118116328, -1.8572208785	
2420, 38.7060570879, -1.8676470456		2460, 39.4267674011, -1.8667503789	
2421, 38.675989631, -1.8612438588		2461, 39.4596407497, -1.8725034863	
2422, 38.6294554239, -1.8605887714		2462, 39.4712572296, -1.8630713793	
2423, 38.7270889903, -1.8580709928		2463, 39.5124721172, -1.8692258283	
2424, 38.7004437365, -1.8562607459		2464, 39.4974773027, -1.876327163	
2425, 38.7274158579, -1.8549279684		2465, 39.5116014508, -1.8767419735	
2426, 38.7383931746, -1.8495440078		2466, 39.498958178, -1.8851195686	
2427, 38.753658448, -1.8453908016		2467, 39.5541559722, -1.8863704354	
2428, 38.7383868159, -1.8446766984		2468, 39.6094309025, -1.8839637961	
2429, 38.7592083101, -1.8497092639		2469, 39.5900214899, -1.8906525934	
2430, 38.7980771732, -1.8481769576		2470, 39.5977654519, -1.8925544929	
2431, 38.8050541493, -1.8429252221		2471, 39.5875475716, -1.9000908521	
2432, 38.8341052572, -1.8415796953		2472, 39.6151379566, -1.9035369784	
2433, 38.8202168688, -1.8374023209		2473, 39.6171594539, -1.9090921976	
2434, 38.855039531, -1.8416082209		2474, 39.6294000717, -1.9078473389	
2435, 38.8790465251, -1.8385681924		2475, 39.6245850996, -1.9145981149	
2436, 38.9245328765, -1.84110738		2476, 39.6306706301, -1.9160116754	
2437, 38.9162372124, -1.8366575693		2477, 39.6555561462, -1.9246375659	
2438, 38.9433597303, -1.8335556834		2478, 39.6628318198, -1.9182364805	
2439, 38.989774031, -1.8352736104		2479, 39.6329350778, -1.9335837741	
2440, 38.9713500962, -1.8352416821		2480, 39.6285530097, -1.9352694273	
2441, 38.9819702838, -1.8356837698		2481, 39.6197712203, -1.939498088	
2442, 39.057000223, -1.8315837553		2482, 39.6478176076, -1.942133569	
2443, 39.0302702656, -1.8322870369		2483, 39.6425669016, -1.9490031261	
2444, 39.0413334266, -1.833623461		2484, 39.6543817394, -1.9554133437	
2445, 39.085233492, -1.8345297215		2485, 39.651924524, -1.957230583	
2446, 39.1116184013, -1.8351440087		2486, 39.631916468, -1.9589254378	
2447, 39.1467024576, -1.8390971595		2487, 39.628545598, -1.9640201305	
2448, 39.1677434174, -1.8362290779		2488, 39.6393448797, -1.9685485295	
2449, 39.1802736142, -1.8378794382		2489, 39.6315903886, -1.976288071	
		2490, 39.6826339172, -1.9804590922	

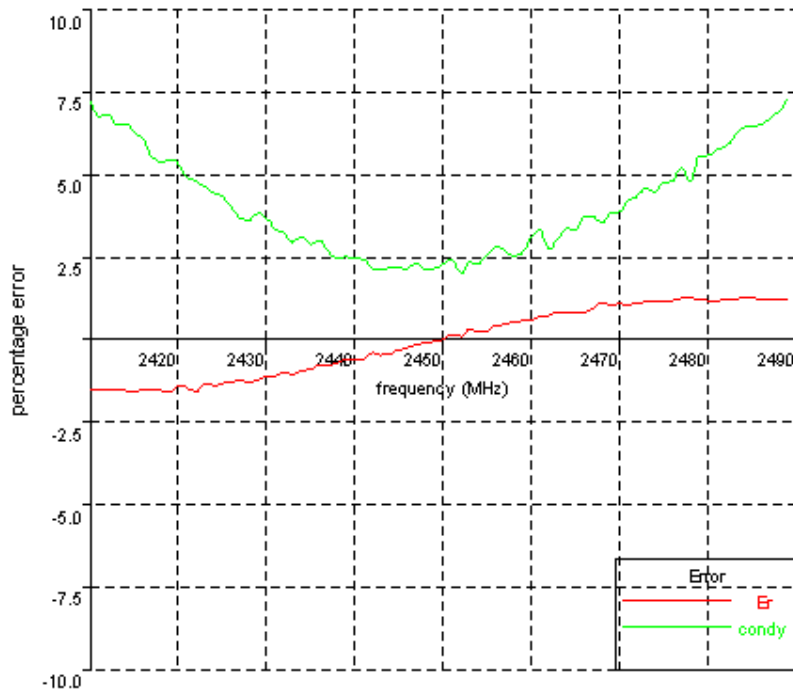

3.3 E-Field Probe and 2450 Balanced Dipole Antenna Calibration

Probe calibration factors and dipole antenna calibration are included in Appendix C.

4.0 Measurement Uncertainty

The uncertainty budget has been determined for the INDEXSAR SARA2 measurement system according to IEEE P1528 documents [3] and is given in the following table. The extended uncertainty (95% confidence level) was assessed to be 20.6 % for SAR measurement, and the extended uncertainty (95% confidence level) was assessed to be 20.2 % for system performance check.

Table 1 Exposure Assessment Uncertainty
Example of measurement uncertainty assessment SAR measurement

(blue entries are site-specific)

a	b	c		d	e	f		g	h	i	
Uncertainty Component	Sec.	Tol. (+/-)		Prob. Dist.	Divisor (descrip)	Divisor (value)	c1 (1g)	c1 (10g)	Standard Uncertainty (%) 1g	Standard Uncertainty (%) 10g	
		(dB)		(%)							
Measurement System											
Probe Calibration	E2.1			2.5	N	1 or k	1	1	1	2.50	2.50
Axial Isotropy	E2.2	0.25	5.93	5.93	R	$\sqrt{3}$	1.73	0	0	0.00	0.00
Hemispherical Isotropy	E2.2	0.45	10.92	10.92	R	$\sqrt{3}$	1.73	1	1	6.30	6.30
Boundary effect	E2.3		4	4.00	R	$\sqrt{3}$	1.73	1	1	2.31	2.31
Linearity	E2.4	0.04	0.93	0.93	R	$\sqrt{3}$	1.73	1	1	0.53	0.53
System Detection Limits	E2.5		1	1.00	R	$\sqrt{3}$	1.73	1	1	0.58	0.58
Readout Electronics	E2.6		1	1.00	N	1 or k	1.00	1	1	1.00	1.00
Response time	E2.7		0	0.00	R	$\sqrt{3}$	1.73	1	1	0.00	0.00
Integration time	E2.8		1.4	1.40	R	$\sqrt{3}$	1.73	1	1	0.81	0.81
RF Ambient Conditions	E6.1		3	3.00	R	$\sqrt{3}$	1.73	1	1	1.73	1.73
Probe Positioner Mechanical Tolerance	E6.2		0.6	0.60	R	$\sqrt{3}$	1.73	1	1	0.35	0.35
Probe Position wrt. Phantom Shell	E6.3		3	3.00	R	$\sqrt{3}$	1.73	1	1	1.73	1.73
SAR Evaluation Algorithms	E5		8	8.00	R	$\sqrt{3}$	1.73	1	1	4.62	4.62
Test Sample Related											
Test Sample Positioning	E4.2		2	2.00	N	1	1.00	1	1	2.00	2.00
Device Holder Uncertainty	E4.1		2	2.00	N	1	1.00	1	1	2.00	2.00
Output Power Variation	6.6.2		5	5.00	R	$\sqrt{3}$	1.73	1	1	2.89	2.89
Phantom and Tissue Parameters											
Phantom Uncertainty (shape and thickness)	E3.1		4	4.00	R	$\sqrt{3}$	1.73	1	1	2.31	2.31
Liquid conductivity (Deviation from target)	E3.2		5	5.00	R	$\sqrt{3}$	1.73	0.64	0.43	1.85	1.24
Liquid conductivity (measurement uncert.)	E3.3		1.1	1.10	N	1	1.00	0.64	0.43	0.70	0.47
Liquid permittivity (Deviation from target)	E3.2		5	5.00	R	$\sqrt{3}$	1.73	0.6	0.49	1.73	1.41
Liquid permittivity (measurement uncert.)	E3.3		1.1	1.10	N	1	1.00	0.6	0.49	0.66	0.54
Combined standard uncertainty					RSS					10.5	10.3
Expanded uncertainty	(95% Confidence Level)				k=2					20.6	20.3

Table 2 System Check (Verification)

Example of measurement uncertainty assessment for system performance check

(blue entries are site-specific)

a	b	c		d	e	f	g	h	i	
Uncertainty Component	Sec.	Tol. (+/-)		Prob. Dist.	Divisor (descrip)	Divisor (value)	c1 (1g)	c1 (10g)	Standard Uncertainty (%) 1g	Standard Uncertainty (%) 10g
		(dB)	(%)							
Measurement System										
Probe Calibration	E2.1		2.5	N	1 or k	1	1	1	2.50	2.50
Axial Isotropy	E2.2	0.25	5.93	R	√3	1.73	0	0	0.00	0.00
Hemispherical Isotropy	E2.2	0.45	10.92	R	√3	1.73	1	1	6.30	6.30
Boundary effect	E2.3		4	R	√3	1.73	1	1	2.31	2.31
Linearity	E2.4	0.04	0.93	R	√3	1.73	1	1	0.53	0.53
System Detection Limits	E2.5		1	R	√3	1.73	1	1	0.58	0.58
Readout Electronics	E2.6		1	N	1 or k	1.00	1	1	1.00	1.00
Response time	E2.7		0	R	√3	1.73	1	1	0.00	0.00
Integration time	E2.8		1.4	R	√3	1.73	1	1	0.81	0.81
RF Ambient Conditions	E6.1		3	R	√3	1.73	1	1	1.73	1.73
Probe Positioner Mechanical Tolerance	E6.2		0.6	R	√3	1.73	1	1	0.35	0.35
Probe Position wrt. Phantom Shell	E6.3		3	R	√3	1.73	1	1	1.73	1.73
SAR Evaluation Algorithms	E5		8	R	√3	1.73	1	1	4.62	4.62
Dipole										
Dipole axis to liquid distance	8, E4.2		2	N	1	1.00	1	1	2.00	2.00
Input power and SAR drift measurement	8, 6.6.2		5	R	√3	1.73	1	1	2.89	2.89
Phantom and Tissue Parameters										
Phantom Uncertainty (thickness)	E3.1		4	R	√3	1.73	1	1	2.31	2.31
Liquid conductivity (Deviation from target)	E3.2		5	R	√3	1.73	0.64	0.43	1.85	1.24
Liquid conductivity (measurement uncert.)	E3.3		1.1	N	1	1.00	0.64	0.43	0.70	0.47
Liquid permittivity (Deviation from target)	E3.2		5	R	√3	1.73	0.6	0.49	1.73	1.41
Liquid permittivity (measurement uncert.)	E3.3		1.1	N	1	1.00	0.6	0.49	0.66	0.54
Combined standard uncertainty				RSS					10.3	10.1
Expanded uncertainty	(95% Confidence Level)			k=2					20.2	19.9

5.0 Measurement Traceability

All measurements described in this report are traceable to Chinese National Laboratory Accreditation (CNLA) standards or appropriate national standards.

6.0 WARNING LABEL INFORMATION - USA

See user manual.

7.0 REFERENCES

- [1] ANSI, *ANSI/IEEE C95.1-1999: IEEE Standard for Safety Levels with Respect to Human Exposure to Radio Frequency Electromagnetic Fields, 3kHz to 300 GHz*, The Institute of electrical and Electronics Engineers, Inc., New York, NY 10017, 1999
- [2] Federal Communications Commission, "Evaluating Compliance with FCC Guidelines for Human Exposure to Radiofrequency Electromagnetic Fields", Supplement C to OET Bulletin 65, Washington, D.C. 20554, 1997
- [3] IEEE Standards Coordinating Committee 34, "IEEE Recommended Practice for Determining the Peak Spatial-Average Specific Absorption Rate (SAR) in the Human Head from Wireless Communications Devices: Measurement Techniques", IEEE Std 1528TM-2003

8.0 DOCUMENT HISTORY

Revision/ Job Number	Writer Initials	Date	Change
N/A	C.I.	Nov. 23, 2004	Original document

APPENDIX A - SAR Evaluation Data

Power drift is the measurement of power drift of the device over one complete SAR scan.

To assess the drift of the power of the device under test, a SAR measurement was made in the middle of the zoom scan volume at the start of the scan and a measurement at this point was then also made after the measurement scan. The difference between the two measurements should be less than 5%.

Plot #1(1/2)

Date: 2004/11/16	Position: Bottom
Filename: ZyXEL G-220 (11b) bot0mm.txt	Phantom: HeadBox2-test.csv
Device Tested: ZyAIR G-220	Head Rotation: 0
Antenna: chip	Test Frequency: 2437 MHz
Shape File: ZyAIR G-220-bot.csv	Power Level: 19.66 dBm

Probe:	0149																
Cal File:	SN0149_2450_CW_BODY																
Cal Factors:	<table border="1" style="width: 100%; border-collapse: collapse;"> <tr> <td></td> <td style="text-align: center;">X</td> <td style="text-align: center;">Y</td> <td style="text-align: center;">Z</td> </tr> <tr> <td style="text-align: center;">Air</td> <td style="text-align: center;">365</td> <td style="text-align: center;">444</td> <td style="text-align: center;">414</td> </tr> <tr> <td style="text-align: center;">DCP</td> <td style="text-align: center;">20</td> <td style="text-align: center;">20</td> <td style="text-align: center;">20</td> </tr> <tr> <td style="text-align: center;">Lin</td> <td style="text-align: center;">.561</td> <td style="text-align: center;">.561</td> <td style="text-align: center;">.561</td> </tr> </table>		X	Y	Z	Air	365	444	414	DCP	20	20	20	Lin	.561	.561	.561
		X	Y	Z													
	Air	365	444	414													
	DCP	20	20	20													
Lin	.561	.561	.561														
Amp Gain:	2																
Averaging:	1																
Batteries Replaced:	-																

Liquid:	15.5cm
Type:	2450 body
Conductivity:	1.962
Relative Permittivity:	50.719
Liquid Temp (deg C):	21.9
Ambient Temp (deg C):	21.8
Ambient RH (%):	50.2
Density (kg/m3):	1000
Software Version:	2.3VPM
Crest Factor =	1

ZOOM SCAN RESULTS:

Spot SAR (W/kg):	Start Scan	End Scan
	0.143	0.141
Change during Scan (%)	-1.37	
Max E-field (V/m):	24.30	
Max SAR (W/kg)	1g	10g
	0.787	0.372
Location of Max (mm):	X	Y
	78.0	-8.0
	Z	-147.1

Plot #1(2/2)

AREA SCAN:

Scan Extent:

	Min	Max	Steps
Y	-50.0	40.0	9.0
Z	-185.0	-115.0	7.0

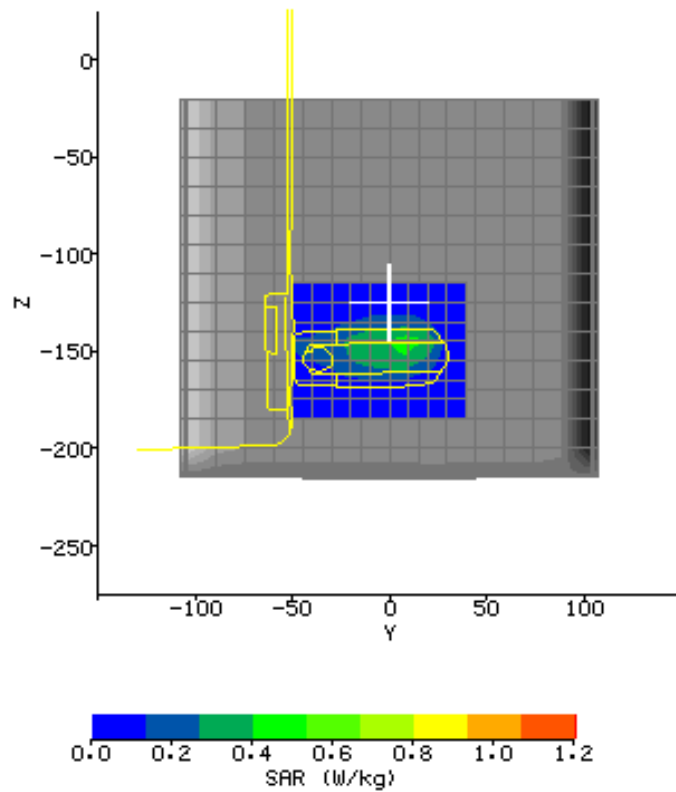

Plot #2 (1/2)

Date: 2004/11/16	Position: Perpendicular 0mm
Filename: ZyAIR G-220 (11b) per0mm.txt	Phantom: HeadBox2-test.csv
Device Tested: ZyAIR G-220	Head Rotation: 0
Antenna: chip	Test Frequency: 2437 MHz
Shape File: ZyAIR G-220-per.csv	Power Level: 19.66 dBm

Probe:	0149																
Cal File:	SN0149_2450_CW_BODY																
Cal Factors:	<table border="1" style="width: 100%; border-collapse: collapse;"> <thead> <tr> <th></th> <th>X</th> <th>Y</th> <th>Z</th> </tr> </thead> <tbody> <tr> <td>Air</td> <td>365</td> <td>444</td> <td>414</td> </tr> <tr> <td>DCP</td> <td>20</td> <td>20</td> <td>20</td> </tr> <tr> <td>Lin</td> <td>.561</td> <td>.561</td> <td>.561</td> </tr> </tbody> </table>		X	Y	Z	Air	365	444	414	DCP	20	20	20	Lin	.561	.561	.561
		X	Y	Z													
	Air	365	444	414													
	DCP	20	20	20													
Lin	.561	.561	.561														
Amp Gain:	2																
Averaging:	1																
Batteries Replaced:	-																

Liquid:	15.5cm
Type:	2450 body
Conductivity:	1.962
Relative Permittivity:	50.719
Liquid Temp (deg C):	21.9
Ambient Temp (deg C):	21.8
Ambient RH (%):	50.2
Density (kg/m3):	1000
Software Version:	2.3VPM
Crest Factor =	1

ZOOM SCAN RESULTS:

Spot SAR (W/kg):	Start Scan	End Scan
	0.027	0.027
Change during Scan (%):	0	
Max E-field (V/m):	8.64	
Max SAR (W/kg)	1g	10g
	0.112	0.057
Location of Max (mm):	X	Y
	78.0	-20.0
	Z	-154.9

Plot #2 (2/2)

AREA SCAN:

Scan Extent:

	Min	Max	Steps
Y	-45.0	35.0	8.0
Z	-185.0	-105.0	8.0

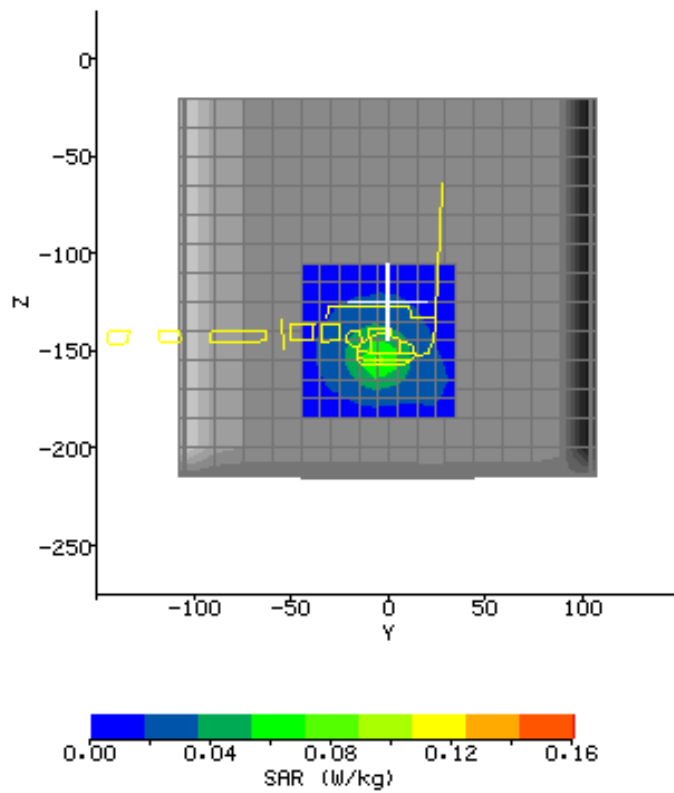

Plot #3 (1/2)

Date: 2004/11/16	Position: Perpendicular 15mm
Filename: ZyAIR G-220 (11b) per15mm.txt	Phantom: HeadBox2-test.csv
Device Tested: ZyAIR G-220	Head Rotation: 0
Antenna: chip	Test Frequency: 2437 MHz
Shape File: ZyAIR G-220-per.csv	Power Level: 19.66 dBm

Probe:	0149																
Cal File:	SN0149_2450_CW_BODY																
Cal Factors:	<table border="1" style="width: 100%; border-collapse: collapse;"> <thead> <tr> <th></th> <th>X</th> <th>Y</th> <th>Z</th> </tr> </thead> <tbody> <tr> <td>Air</td> <td>365</td> <td>444</td> <td>414</td> </tr> <tr> <td>DCP</td> <td>20</td> <td>20</td> <td>20</td> </tr> <tr> <td>Lin</td> <td>.561</td> <td>.561</td> <td>.561</td> </tr> </tbody> </table>		X	Y	Z	Air	365	444	414	DCP	20	20	20	Lin	.561	.561	.561
		X	Y	Z													
	Air	365	444	414													
	DCP	20	20	20													
Lin	.561	.561	.561														
Amp Gain:	2																
Averaging:	1																
Batteries Replaced:	-																

Liquid:	15.5cm
Type:	2450 body
Conductivity:	1.962
Relative Permittivity:	50.719
Liquid Temp (deg C):	21.9
Ambient Temp (deg C):	21.8
Ambient RH (%):	50.2
Density (kg/m3):	1000
Software Version:	2.3VPM
Crest Factor =	1

ZOOM SCAN RESULTS:

Spot SAR (W/kg):	Start Scan	End Scan
	0.007	0.007
Change during Scan (%)	0	
Max E-field (V/m):	3.57	
Max SAR (W/kg)	1g	10g
	0.020	0.013
Location of Max (mm):	X	Y
	78.1	-32.0
	Z	-141.7

Plot #3 (2/2)

AREA SCAN:

Scan Extent:

	Min	Max	Steps
Y	-45.0	35.0	8.0
Z	-185.0	-115.0	7.0

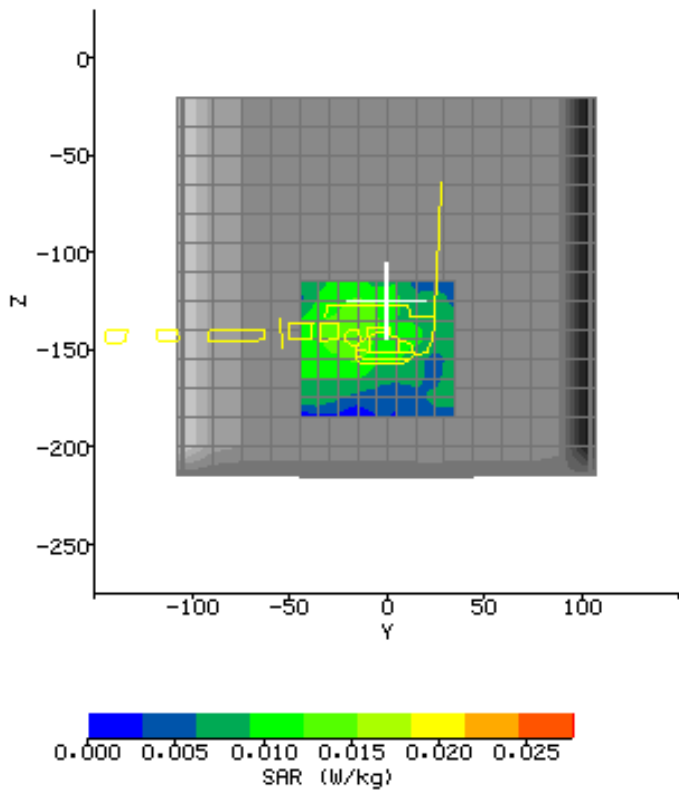

Plot #4 (1/2)

Date: 2004/11/16	Position: Bottom
Filename: ZyAIR G-220 (11g) bot0mm.txt	Phantom: HeadBox2-test.csv
Device Tested: ZyAIR G-220	Head Rotation: 0
Antenna: chip	Test Frequency: 2437 MHz
Shape File: ZyAIR G-220-bot.csv	Power Level: 19.42 dBm

Probe:	0149																
Cal File:	SN0149_2450_CW_BODY																
Cal Factors:	<table border="1" style="width: 100%; border-collapse: collapse;"> <thead> <tr> <th></th> <th>X</th> <th>Y</th> <th>Z</th> </tr> </thead> <tbody> <tr> <td>Air</td> <td>365</td> <td>444</td> <td>414</td> </tr> <tr> <td>DCP</td> <td>20</td> <td>20</td> <td>20</td> </tr> <tr> <td>Lin</td> <td>.561</td> <td>.561</td> <td>.561</td> </tr> </tbody> </table>		X	Y	Z	Air	365	444	414	DCP	20	20	20	Lin	.561	.561	.561
		X	Y	Z													
	Air	365	444	414													
	DCP	20	20	20													
Lin	.561	.561	.561														
Amp Gain:	2																
Averaging:	1																
Batteries Replaced:	-																

Liquid:	15.5cm
Type:	2450 body
Conductivity:	1.962
Relative Permittivity:	50.719
Liquid Temp (deg C):	21.9
Ambient Temp (deg C):	21.8
Ambient RH (%):	50.2
Density (kg/m3):	1000
Software Version:	2.3VPM
Crest Factor =	1

ZOOM SCAN RESULTS:

Spot SAR (W/kg):	Start Scan	End Scan
	0.059	0.061
Change during Scan (%):	3.04	
Max E-field (V/m):	15.47	
Max SAR (W/kg)	1g	10g
	0.326	0.154
Location of Max (mm):	X	Y
	78.1	-10.0
	Z	-152.1

Plot #4 (2/2)

AREA SCAN:

Scan Extent:

	Min	Max	Steps
Y	-50.0	40.0	9.0
Z	-185.0	-115.0	7.0

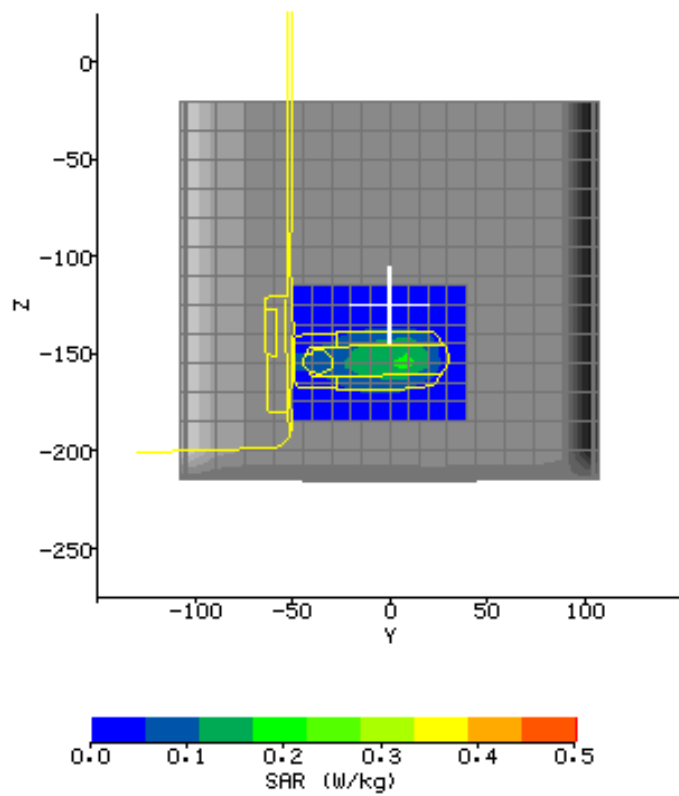

Plot #5 (1/2)

Date: 2004/11/16	Position: Perpendicular 0mm
Filename: ZyAIR G-220 (11g) per0mm.txt	Phantom: HeadBox2-test.csv
Device Tested: ZyAIR G-220	Head Rotation: 0
Antenna: chip	Test Frequency: 2437 MHz
Shape File: ZyAIR G-220-per.csv	Power Level: 19.42 dBm

Probe:	0149																
Cal File:	SN0149_2450_CW_BODY																
Cal Factors:	<table border="1" style="width: 100%; border-collapse: collapse;"> <thead> <tr> <th></th> <th>X</th> <th>Y</th> <th>Z</th> </tr> </thead> <tbody> <tr> <td>Air</td> <td>365</td> <td>444</td> <td>414</td> </tr> <tr> <td>DCP</td> <td>20</td> <td>20</td> <td>20</td> </tr> <tr> <td>Lin</td> <td>.561</td> <td>.561</td> <td>.561</td> </tr> </tbody> </table>		X	Y	Z	Air	365	444	414	DCP	20	20	20	Lin	.561	.561	.561
		X	Y	Z													
	Air	365	444	414													
	DCP	20	20	20													
Lin	.561	.561	.561														
Amp Gain:	2																
Averaging:	1																
Batteries Replaced:	-																

Liquid:	15.5cm
Type:	2450 body
Conductivity:	1.962
Relative Permittivity:	50.719
Liquid Temp (deg C):	21.9
Ambient Temp (deg C):	21.8
Ambient RH (%):	50.2
Density (kg/m3):	1000
Software Version:	2.3VPM
Crest Factor =	1

ZOOM SCAN RESULTS:

Spot SAR (W/kg):	Start Scan	End Scan
	0.01	0.01
Change during Scan (%):	0	
Max E-field (V/m):	5.33	
Max SAR (W/kg)	1g	10g
	0.042	0.022
Location of Max (mm):	X	Y
	78.0	-20.0
	Z	-155.9

Plot #5 (2/2)

AREA SCAN:

Scan Extent:

	Min	Max	Steps
Y	-45.0	35.0	8.0
Z	-185.0	-115.0	7.0

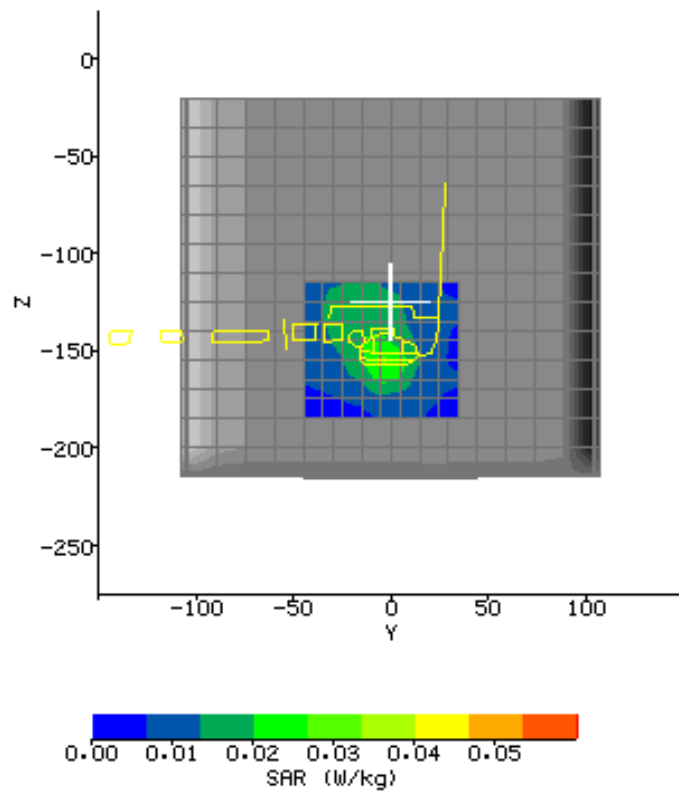

Plot #6 (1/2)

Date: 2004/11/16	Position: Perpendicular 15mm
Filename: ZyAIR G-220 (11g) per15mm.txt	Phantom: HeadBox2-test.csv
Device Tested: ZyAIR G-220	Head Rotation: 0
Antenna: chip	Test Frequency: 2437 MHz
Shape File: ZyAIR G-220-per.csv	Power Level: 19.42 dBm

Probe:	0149																
Cal File:	SN0149_2450_CW_BODY																
Cal Factors:	<table border="1" style="width: 100%; border-collapse: collapse;"> <thead> <tr> <th></th> <th>X</th> <th>Y</th> <th>Z</th> </tr> </thead> <tbody> <tr> <td>Air</td> <td>365</td> <td>444</td> <td>414</td> </tr> <tr> <td>DCP</td> <td>20</td> <td>20</td> <td>20</td> </tr> <tr> <td>Lin</td> <td>.561</td> <td>.561</td> <td>.561</td> </tr> </tbody> </table>		X	Y	Z	Air	365	444	414	DCP	20	20	20	Lin	.561	.561	.561
		X	Y	Z													
	Air	365	444	414													
	DCP	20	20	20													
Lin	.561	.561	.561														
Amp Gain:	2																
Averaging:	1																
Batteries Replaced:	-																

Liquid:	15.5cm
Type:	2450 body
Conductivity:	1.962
Relative Permittivity:	50.719
Liquid Temp (deg C):	21.9
Ambient Temp (deg C):	21.8
Ambient RH (%):	50.2
Density (kg/m3):	1000
Software Version:	2.3VPM
Crest Factor =	1

ZOOM SCAN RESULTS:

Spot SAR (W/kg):	Start Scan	End Scan
	0.002	0.003
Change during Scan (%):	2.16	
Max E-field (V/m):	2.43	
Max SAR (W/kg)	1g	10g
	0.009	0.006
Location of Max (mm):	X	Y
	78.0	-20.0
	Z	-147.0

AREA SCAN:

Scan Extent:

	Min	Max	Steps
Y	-45.0	35.0	8.0
Z	-185.0	-115.0	7.0

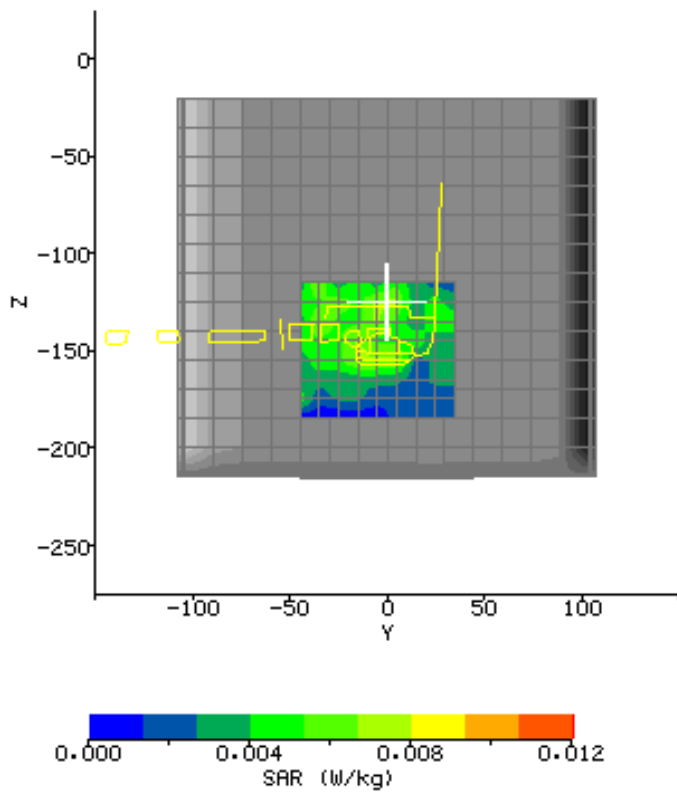

APPENDIX B - Photographs





APPENDIX C - E-Field Probe and 2450MHz Balanced Dipole Antenna Calibration Data



**IMMERSIBLE SAR PROBE
CALIBRATION REPORT
Part Number: IXP – 050**

S/N 0149

May 2004



Indexsar Limited
Oakfield House
Cudworth Lane
Newdigate
Surrey RH5 5BG
Tel: +44 (0) 1306 632 870
Fax: +44 (0) 1306 631 834
e-mail: enquiries@indexsar.com

INTRODUCTION

This Report presents measured calibration data for a particular Indexas SAR probe (S/N 0149) and describes the procedures used for characterisation and calibration.

Indexas probes are characterised using procedures that, where applicable, follow the recommendations of CENELEC [1] and IEEE [2] standards. The procedures incorporate techniques for probe linearisation, isotropy assessment and determination of liquid factors (conversion factors). Calibrations are determined by comparing probe readings with analytical computations in canonical test geometries (waveguides) using normalised power inputs.

Each step of the calibration procedure and the equipment used is described in the sections below.

CALIBRATION PROCEDURE

1. Equipment Used

For the first part of the characterisation procedure, the probe is placed in an isotropy measurement jig as pictured in Figure 1. In this position the probe can be rotated about its axis by a non-metallic belt driven by a stepper motor.

The probe is attached via its amplifier and an optical cable to a PC. A schematic representation of the test geometry is illustrated in Figure 2.

A balanced dipole (900 MHz) is inserted horizontally into the bracket attached to a second belt (Figure 1). The dipole can also be rotated about its axis. A cable connects the dipole to a signal generator, via a directional coupler and power meter. The signal generator feeds an RF amplifier at constant power, the output of which is monitored using the power meter. The probe is positioned so that its sensors line up with the rotation center of the source dipole. By recording output voltage measurements of each channel as both the probe and the dipole are rotated, data are obtained from which the spherical isotropy of the probe can be optimised and its magnitude determined.

The calibration process requires E-field measurements to be taken in air, in 900 MHz simulated brain liquid and at other frequencies/liquids as appropriate.

2. Linearising probe output

The probe channel output signals are linearised in the manner set out in Refs [1] and [2]. The following equation is utilized for each channel:

$$U_{lin} = U_{o/p} + U_{o/p}^2 / DCP \quad (1)$$

where U_{lin} is the linearised signal, $U_{o/p}$ is the raw output signal in voltage units and DCP is the diode compression potential in similar voltage units.

DCP is determined from fitting equation (1) to measurements of U_{lin} versus source feed power over the full dynamic range of the probe. The DCP is a characteristic of the schottky diodes used as the sensors. For the IXP-050 probes with CW signals the DCP values are typically 0.10V (or 20 in the voltage units used by Indexsar software, which are $V*200$).

3. Selecting channel sensitivity factors to optimise isotropic response

The basic measurements obtained using the calibration jig (Fig 1) represent the output from each diode sensor as a function of the presentation angle of the source (probe and dipole rotation angles). The directionality of the orthogonally-arranged sensors can be checked by analysing the data using dedicated Indexsar software, which displays the data in 3D format as in Figure 3. The left-hand side of this diagram shows the individual channel outputs after linearisation (see above). The program uses these data to balance the channel outputs and then applies an optimisation process, which makes fine adjustments to the channel factors for optimum isotropic response.

The next stage of the process is to calibrate the Indexsar probe to a W&G EMR300 E-field meter in air. The principal reasons for this are to obtain conversion factors applicable should the probe be used in air and to provide an overall measure of the probe sensitivity.

A multiplier is applied to factors to bring the magnitudes of the average E-field measurements as close as possible to those of the W&G probe.

The following equation is used (where linearised output voltages are in units of $V*200$):

$$E_{air}^2 (V/m) = U_{linx} * Air Factor_x + U_{liny} * Air Factor_y + U_{linz} * Air Factor_z \quad (2)$$

It should be noted that the air factors are not separately used for normal SAR testing. The IXP-050 probes are optimised for use in tissue-simulating liquids and do not behave isotropically in air.

4. 900 MHz Liquid Calibration

Conversion factors for use when the probes are immersed in tissue-simulant liquids at 900 MHz are determined either using a waveguide or by comparison to a reference probe that has been calibrated by NPL. Waveguide procedures are described later. The summary sheet indicates the method used for the probe S/N 0149.

The conversion factor, referred to as the 'liquid factor' is also applied to the measurements of each channel. The following equation is used (where output voltages are in units of $V*200$):

$$E_{liq}^2 (V/m) = U_{linx} * Air Factor_x * Liq Factor_x + U_{liny} * Air Factor_y * Liq Factor_y + U_{linz} * Air Factor_z * Liq Factor_z \quad (3)$$

A 3D representation of the spherical isotropy for probe S/N 0149 using these factors is shown in Figure 3.

The rotational isotropy can also be determined from the calibration jig measurements and is reported as the 900MHz isotropy in the summary table. Note that waveguide measurements can also be used to determine rotational isotropy (Fig. 5).

The design of the cells used for determining probe conversion factors are waveguide cells is shown in Figure 4. The cells consist of a coax to waveguide transition and an open-ended section of waveguide containing a dielectric separator. Each waveguide cell stands in the upright position and is filled with liquid within 10 mm of the open end. The separator provides a liquid seal and is designed for a good electrical transition from air filled guide to liquid filled guide. The choice of cell depends on the portion of the frequency band to be examined and the choice of liquid used. The depth of liquid ensures there is negligible radiation from the waveguide open top and that the probe calibration is not influenced by reflections from nearby objects. The return loss at the coaxial connector of the filled waveguide cell is measured initially using a network analyser and this information is used subsequently in the calibration procedure. The probe is positioned in the centre of the waveguide and is adjusted vertically or rotated using stepper motor arrangements. The signal generator is connected to the waveguide cell and the power is monitored with a coupler and a power meter. A fuller description of the waveguide method is given below.

The liquid dielectric parameters used for the probe calibrations are listed in the Tables below. The final calibration factors for the probe are listed in the summary chart.

WAVEGUIDE MEASUREMENT PROCEDURE

The calibration method is based on setting up a calculable specific absorption rate (SAR) in a vertically-mounted WG8 (R22) waveguide section [1]. The waveguide has an air-filled, launcher section and a liquid-filled section separated by a matching window that is designed to minimise reflections at the liquid interface. A TE_{01} mode is launched into the waveguide by means of a N-type-to-waveguide adapter. The power delivered to the liquid section is calculated from the forward power and reflection coefficient measured at the input to the waveguide. At the centre of the cross-section of the waveguide, the local spot SAR in the liquid as a function of distance from the window is given by functions set out in IEEE1528 as below:

Because of the low cutoff frequency, the field inside the liquid nearly propagates as a TEM wave. The depth of the medium (greater than three penetration depths) ensures that reflections at the upper surface of the liquid are negligible. The power absorbed in the liquid is determined by measuring the waveguide forward and reflected power. Equation (4) shows the relationship between the SAR at the cross-sectional center of the lossy waveguide and the longitudinal distance (z) from the dielectric separator

$$SAR(z) = \frac{4(P_f - P_b)}{rabd} e^{-2z/d} \quad (4)$$

where the density ρ is conventionally assumed to be 1000 kg/m^3 , ab is the cross-sectional area of the waveguide, P_f and P_b are the forward and reflected power inside the lossless section of the waveguide, respectively. The penetration depth d , which is the reciprocal of the waveguide-mode attenuation coefficient, is determined from a scan along the z -axis and compared with the theoretical value determined from Equation (5) using the measured dielectric properties of the lossy liquid.

$$d = \left[\text{Re} \left\{ \sqrt{(p/a)^2 + j\omega\mu_0 (s + j\omega\epsilon_0\epsilon_r)} \right\} \right]^{-1}. \quad (5)$$

Table A.1 of [1] can be used for designing calibration waveguides with a return loss greater than 30 dB at the most important frequencies used for personal wireless communications. Values for the penetration depth for these specific fixtures and tissue-simulating mixtures are also listed in Table A.1.

According to [1], this calibration technique provides excellent accuracy, with standard uncertainty of less than 3.6% depending on the frequency and medium. The calibration itself is reduced to power measurements traceable to a standard calibration procedure. The practical limitation to the frequency band of 800 to 2500 MHz because of the waveguide size is not severe in the context of compliance testing.

CALIBRATION FACTORS MEASURED FOR PROBE S/N 0149

The probe was calibrated at 900, 1800, 1900 and 2450MHz MHz in liquid samples representing both brain liquid and body fluid at these frequencies. The calibration was for CW signals only, and the axis of the probe was parallel to the direction of propagation of the incident field i.e. end-on to the incident radiation. The axial isotropy of the probe was measured by rotating the probe about its axis in 10 degree steps through 360 degrees in this orientation.

The reference point for the calibration is in the centre of the probe's cross-section at a distance of 2.7 m from the probe tip in the direction of the probe amplifier. A value of 2.7 mm should be used for the tip to sensor offset distance in the software.

It is important that the diode compression point and air factors used in the software are the same as those quoted in the results tables, as these are used to convert the diode output voltages to a SAR value.

DIELECTRIC PROPERTIES OF LIQUIDS

The dielectric properties of the brain and body tissue-simulant liquids employed for calibration are listed in the tables below. The measurements were performed prior to each waveguide test using an Indexsar DiLine measurement kit, which uses the TEM method as recommended in [2].

AMBIENT CONDITIONS

Measurements were made in the open laboratory at $22 \pm 2.0^\circ\text{C}$. The temperature of the liquids in the waveguide used was measured using a mercury thermometer.

RESPONSE TO MODULATED SIGNALS

To measure the response of the probe and amplifier to modulated signals, the probe is held vertically in a liquid-filled waveguide.

An RF amplifier is allowed to warm up and stabilise before use. A spectrum analyser is used to demonstrate that the peak power of the RF amplifier for the CW signals and the pulsed signals are within 0.1dB of each other when the signal generator is switched from CW to modulated output. Subsequently, the power levels recorded are read from a power meter when a CW signal is being transmitted.

The test sequence involves manually stepping the power up in regular (e.g. 2 dB) steps from the lowest power that gives a measurable reading on the SAR probe up to the maximum that the amplifiers can deliver.

At each power level, the individual channel outputs from the SAR probe are recorded at CW and then recorded again with the modulation setting. The results are entered into a spreadsheet. Using the spreadsheets, the modulated power is calculated by applying a factor to the measured CW power (e.g. for GSM, this factor is 9.03dB). This process is repeated 3 times with the response maximised for each channel sensor in turn.

The probe channel output signals are linearised in the manner set out in Section 1 above using equation (1) with the DCPs determined from the linearisation procedure. Calibration factors for the probe are used to determine the E-field values corresponding to the probe readings using equation (3). SAR is determined from the equation

$$\text{SAR (W/kg)} = E_{\text{liq}}^2 \text{ (V/m)} * \sigma \text{ (S/m)} / 1000 \quad (6)$$

Where σ is the conductivity of the simulant liquid employed.

Using the spreadsheet data, the DCP value for linearising each of the individual channels (X, Y and Z) is assessed separately. The corresponding DCP values are listed in the summary page of the calibration factors for each probe.

Figure 7 shows the linearised probe response to GSM signals, Figure 8 the response to GPRS signals (GSM with 2 timeslots) and Figure 9 the response to CDMA IS-95A and W-CDMA signals.

Additional tests have shown that the modulation response is similar at 1800MHz and is not affected by the orientation between the source and the probe.

VPM (Virtual Probe Miniaturisation)

SAR probes with 3 diode-sensors in an orthogonal arrangement are designed to display an isotropic response when exposed to a uniform field. However, the probes are ordinarily used for measurements in non-uniform fields and isotropy is not assured when the field gradients are significant compared to the dimensions of the tip containing the three orthogonally-arranged dipole sensors.

It becomes increasingly important to assess the effects of field gradients on SAR probe readings when higher frequencies are being used. For Indexsar IXP-050 probes, which are of 5mm tip diameter, field gradient effects are minor at GSM frequencies, but are major above 5GHz. Smaller probes are less affected by field gradients and so probes, which are significantly less than 5mm

diameter, would be better for applications above 5GHz.

The IndexSAR report IXS0223 describes theoretical and experimental studies to evaluate the issues associated with the use of probes at arbitrary angles to surfaces and field directions. Based upon these studies, the procedures and uncertainty analyses referred to in P1528 are addressed for the full range of probe presentation angles.

In addition, generalized procedures for correcting for the finite size of immersible SAR probes are developed. Use of these procedures enables application of schemes for virtual probe miniaturization (VPM) – allowing probes of a specific size to be used where physically-smaller probes would otherwise be required.

Given the typical dimensions of 3-channel SAR probes presently available, use of the VPM technique extends the satisfactory measurement range to higher frequencies.

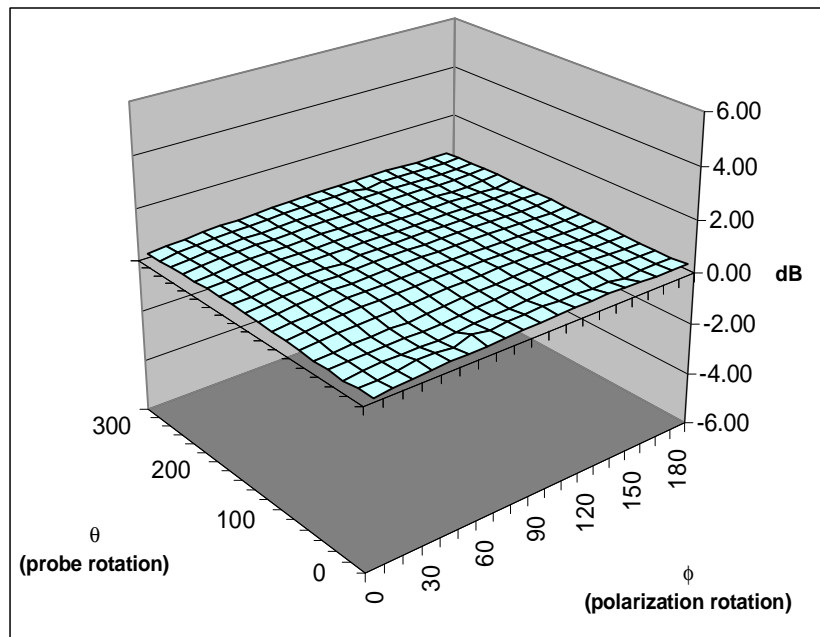

Surface Isotropy diagram of IXP-050 Probe S/N 0149 at 900MHz after VPM

Probe tip radius 1.25
 X Ch. Angle to red dot 7

Frequency	Head		Body	
	Bdy. Corr. – f(0)	Bdy. Corr. – d(mm)	Bdy. Corr. – f(0)	Bdy. Corr. – d(mm)
900	0.2	1.0	0.31	2.0
1800	0.2	2.0	0.27	1.6
1900	0.19	1.7	0.3	1.4
2450	0.24	2.0	0.72	2.0

SUMMARY OF CALIBRATION FACTORS FOR PROBE IXP-050 S/N 0149

Spherical isotropy measured at 900 MHz 0.28 (+/-) dB

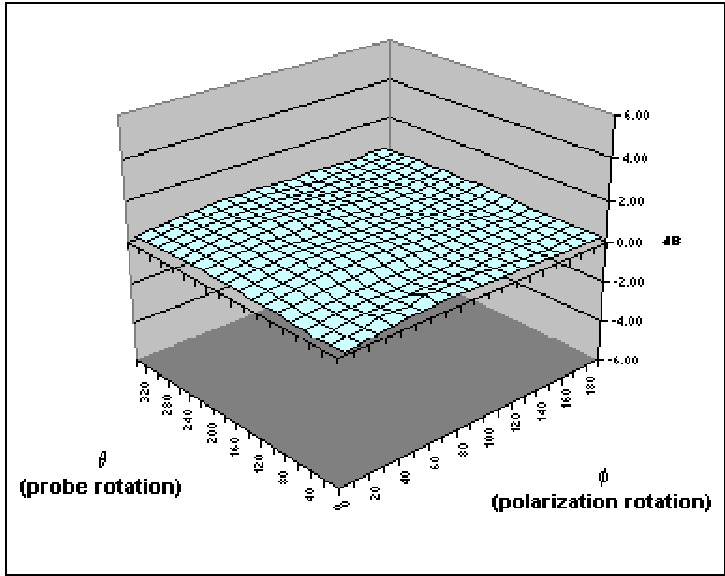

	X	Y	Z	
Air factors	365	444	414	(V*200)
DCPs	20	20	20	(V*200)
GSM	13.4	9.6	7.9	(V*200)
CDMA	20	20	20	(V*200)

f (MHz)	Axial isotropy (+/- dB)		SAR conversion factors (liq/air)		Notes
	BRAIN	BODY	BRAIN	BODY	
450	0.08	0.07	0.344	0.360	1,2,3
835	0.08	0.07	0.344	0.360	1,2,3
900	0.08	0.07	0.344	0.360	1,2,3
1800	0.10	0.11	0.438	0.477	1,2,3
1900	0.11	0.12	0.441	0.504	1,2,3
2450	0.11	0.11	0.504	0.561	1,2,3

Notes	
1)	Calibrations done at 22C +/- 2C
2)	Waveguide calibration
3)	Checked using box-phantom validation test

(the graph shows a simple, spreadsheet representation of surface shown in 3D in Figure 3 below)

PROBE SPECIFICATIONS

Indexsar probe 0149, along with its calibration, is compared with CENELEC and IEEE standards recommendations (Refs [1] and [2]) in the Tables below. A listing of relevant specifications is contained in the tables below:

Dimensions	S/N 0149	CENELEC [1]	IEEE [2]
Overall length (mm)	350		
Tip length (mm)	10		
Body diameter (mm)	12		
Tip diameter (mm)	5.2	8	8
Distance from probe tip to dipole centers (mm)	2.7		

Dynamic range	S/N 0149	CENELEC [1]	IEEE [2]
Minimum (W/kg)	0.01	<0.02	0.01
Maximum (W/kg) N.B. only measured to 35 W/kg	>35	>100	100

Linearity of response	S/N 0149	CENELEC [1]	IEEE [2]
Over range 0.01 – 100 W/kg (+/- dB)	0.125	0.50	0.25

Isotropy (measured at 900MHz)	S/N 0149	CENELEC [1]	IEEE [2]
Axial rotation with probe normal to source (+/- dB) at 900, 1800, 1900 and 2450 MHz	0.12 Max (See table above)	0.5	0.25
Spherical isotropy covering all orientations to source (+/- dB)	0.28	1.0	0.50

Construction	Each probe contains three orthogonal dipole sensors arranged on a triangular prism core, protected against static charges by built-in shielding, and covered at the tip by PEEK cylindrical enclosure material. No adhesives are used in the immersed section. Outer case materials are PEEK and heat-shrink sleeving.
Chemical resistance	Tested to be resistant to glycol and alcohol containing simulant liquids but probes should be removed, cleaned and dried when not in use.

REFERENCES

[1] CENELEC, EN 50361, July 2001. Basic Standard for the measurement of specific absorption rate related to human exposure to electromagnetic fields from mobile phones.

[2] IEEE 1528, Recommended practice for determining the spatial-peak specific absorption rate (SAR) in the human body due to wireless communications devices: Experimental techniques.

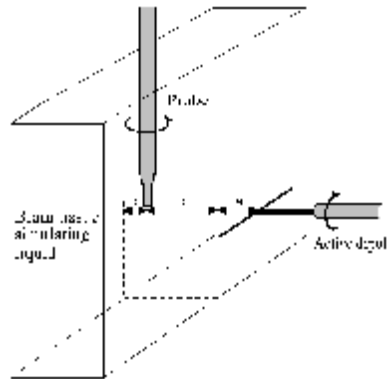
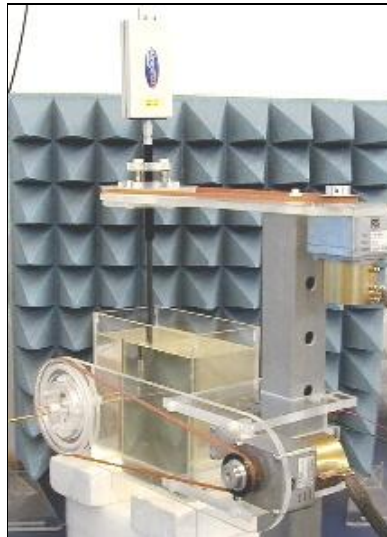

Figure 1. Spherical isotropy jig showing probe, dipole and box filled with simulated brain liquid (see Ref [2], Section A.5.2.1)

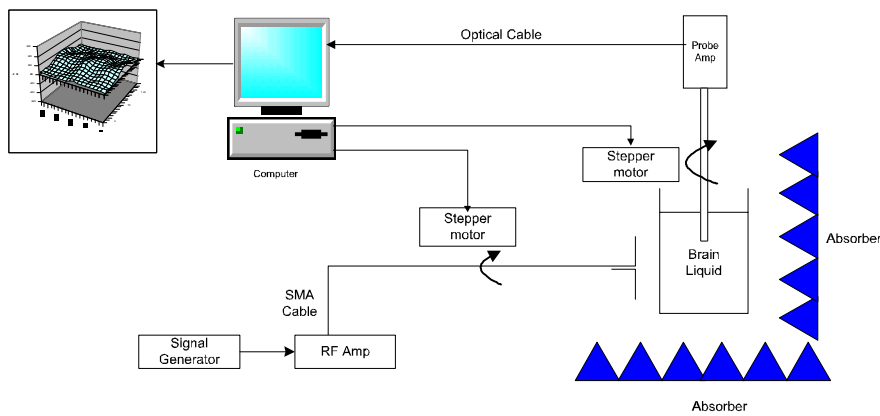

Figure 2. Schematic diagram of the test geometry used for isotropy determination

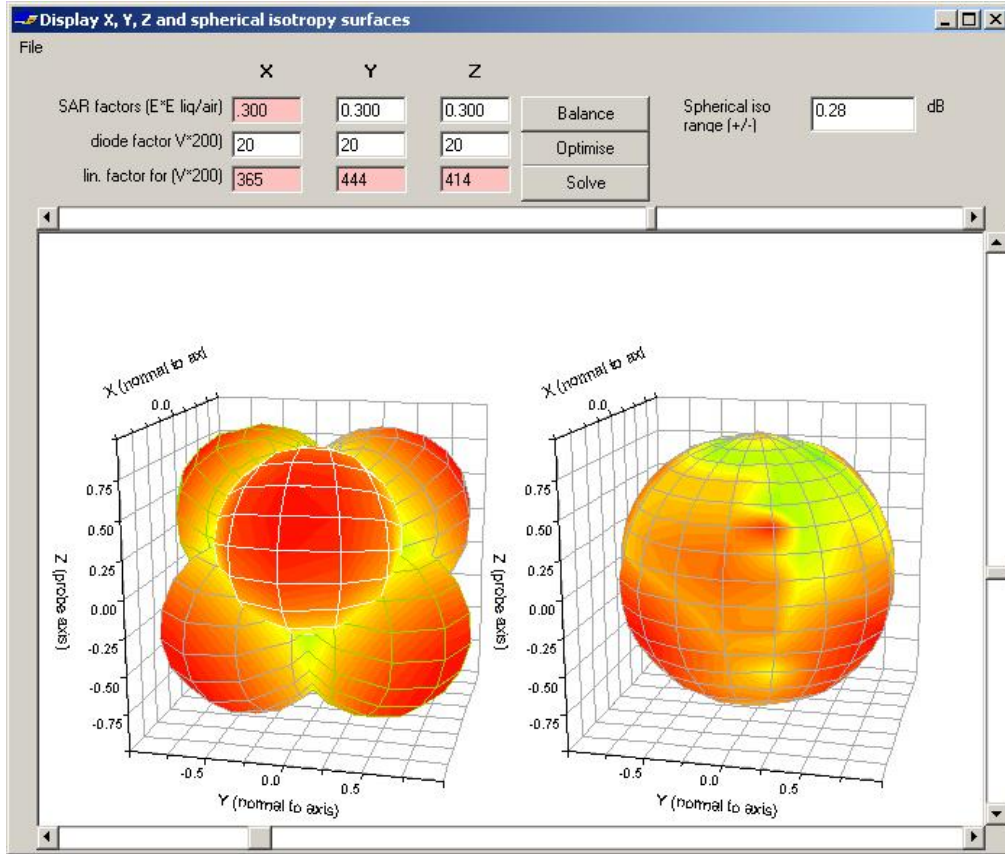

Figure 3. Graphical representation of the probe response to fields applied from each direction. The diagram on the left shows the individual response characteristics of each of the three channels and the diagram on the right shows the resulting probe sensitivity in each direction. The colour range in the figure images the lowest values as blue and the maximum values as red. For the probe S/N 0149, this range is (+/-) 0.28 dB. The probe is more sensitive to fields parallel to the axis and less sensitive to

fields normal to the probe axis.

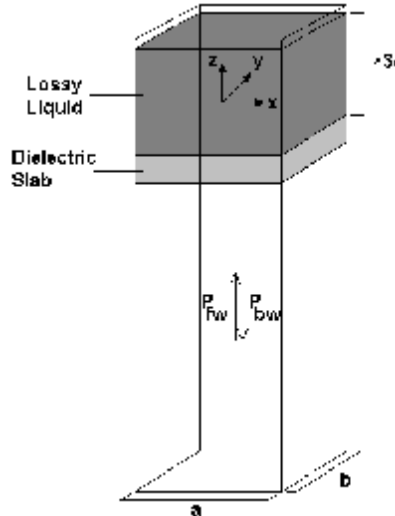

Figure 4. Geometry used for waveguide calibration (after Ref [2]. Section A.3.2.2)

IXP-050 S/N 0149

11-May-04

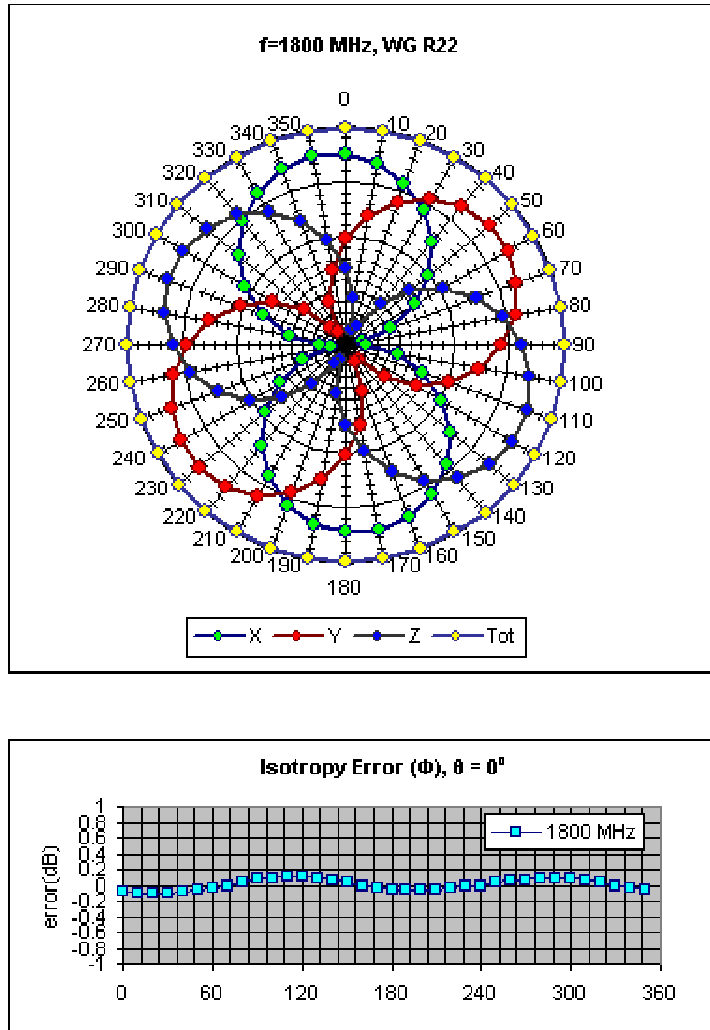

Figure 5. Example of the rotational isotropy of probe S/N 0149 obtained by rotating the probe in a liquid-filled waveguide at 1800 MHz. Similar distributions are obtained at the other test Frequencies (900 and 2450 MHz) both in brain liquids and body fluids (see summary table).

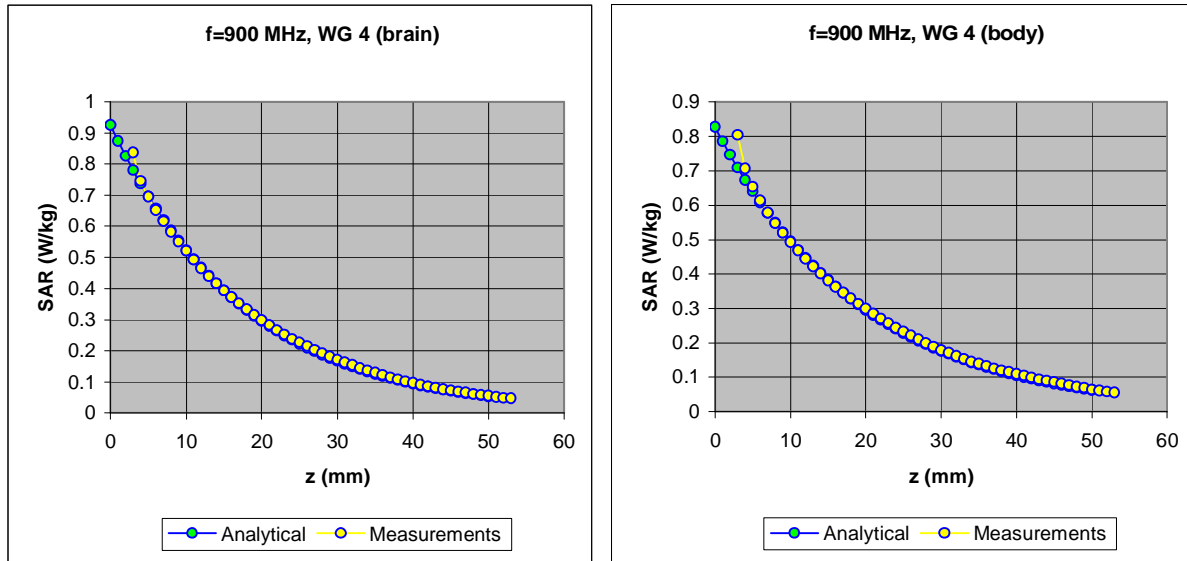
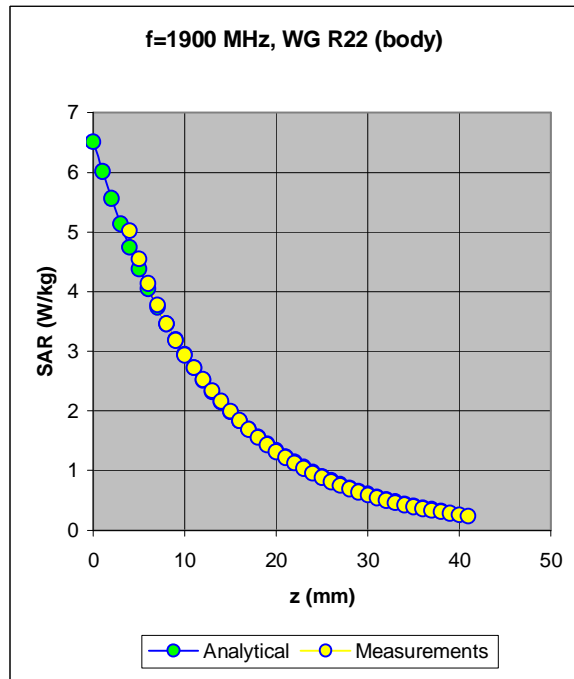
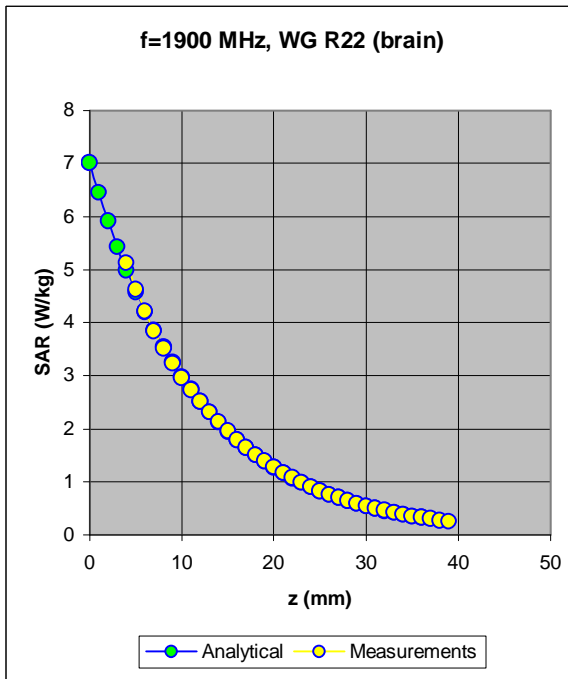
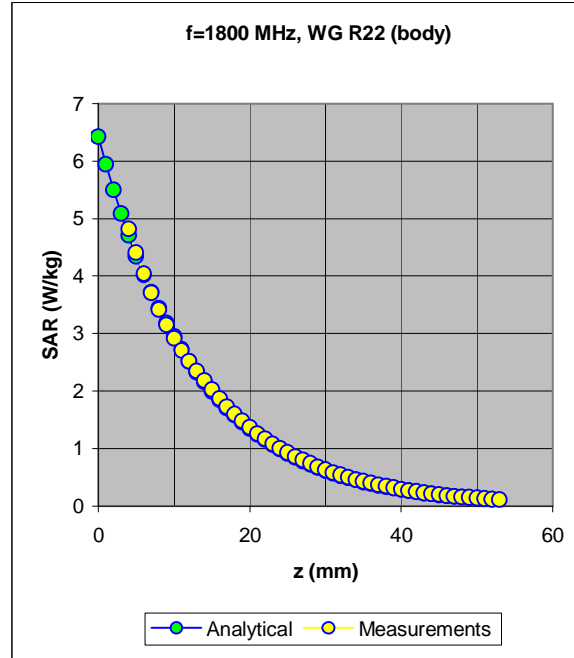
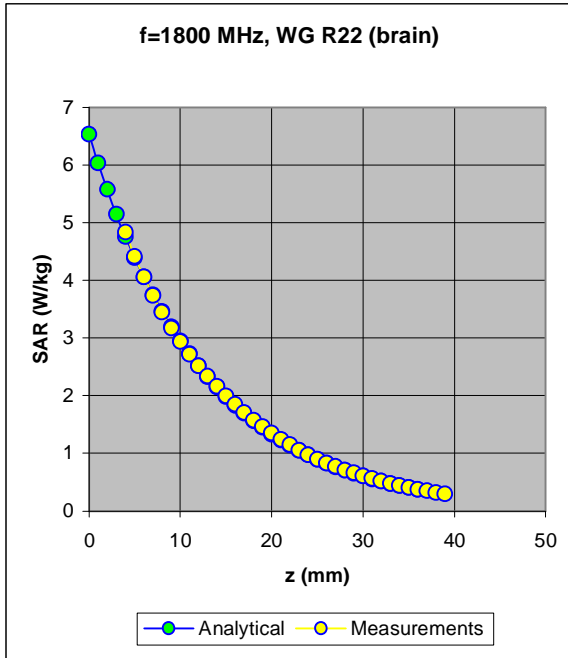

Figure 6. The measured SAR decay function along the centreline of the WG4 waveguide with conversion factors adjusted to fit to the theoretical function for the particular dimension, frequency, power and liquid properties employed.



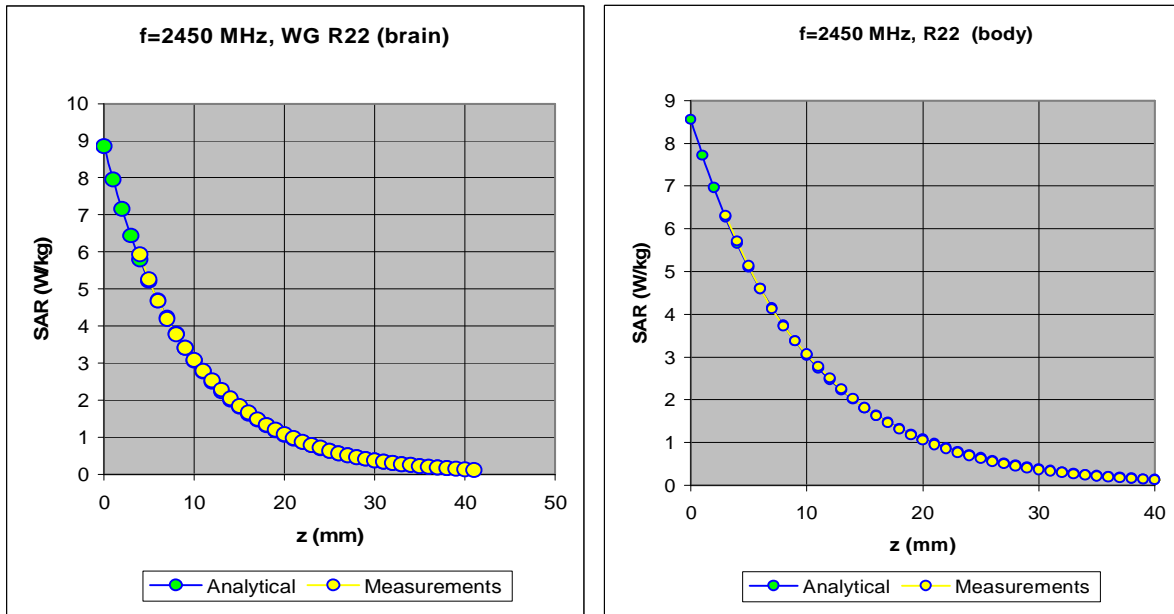

Figure 7. The measured SAR decay function along the centreline of the R22 waveguide with conversion factors adjusted to fit to the theoretical function for the particular dimension, frequency, power and liquid properties employed.

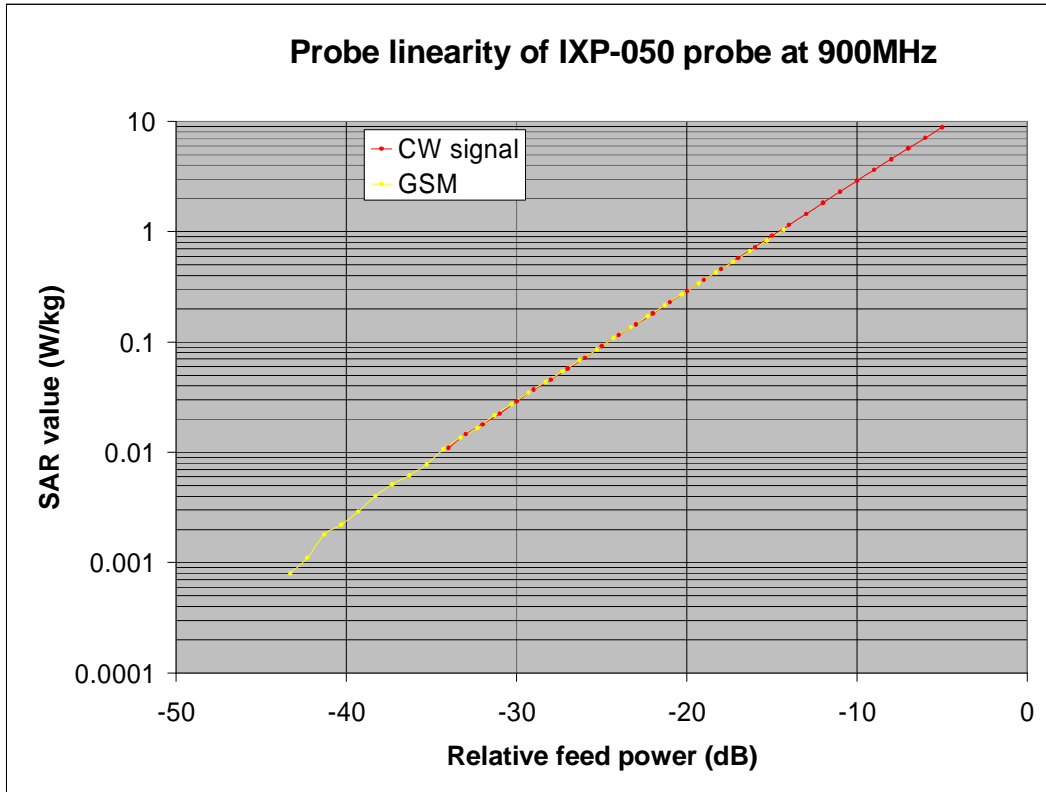

Figure 8. The GSM response of an IXP-050 probe at 900MHz

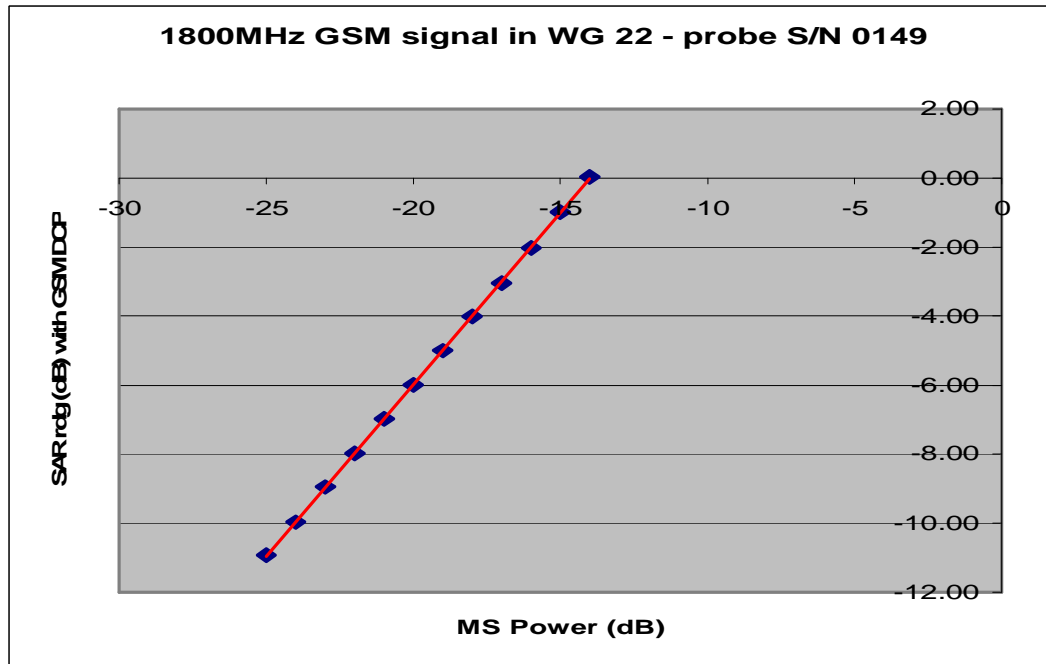

Figure 8a. The actual GSM response of IXP-050 probe S/N 0149 at 1800MHz

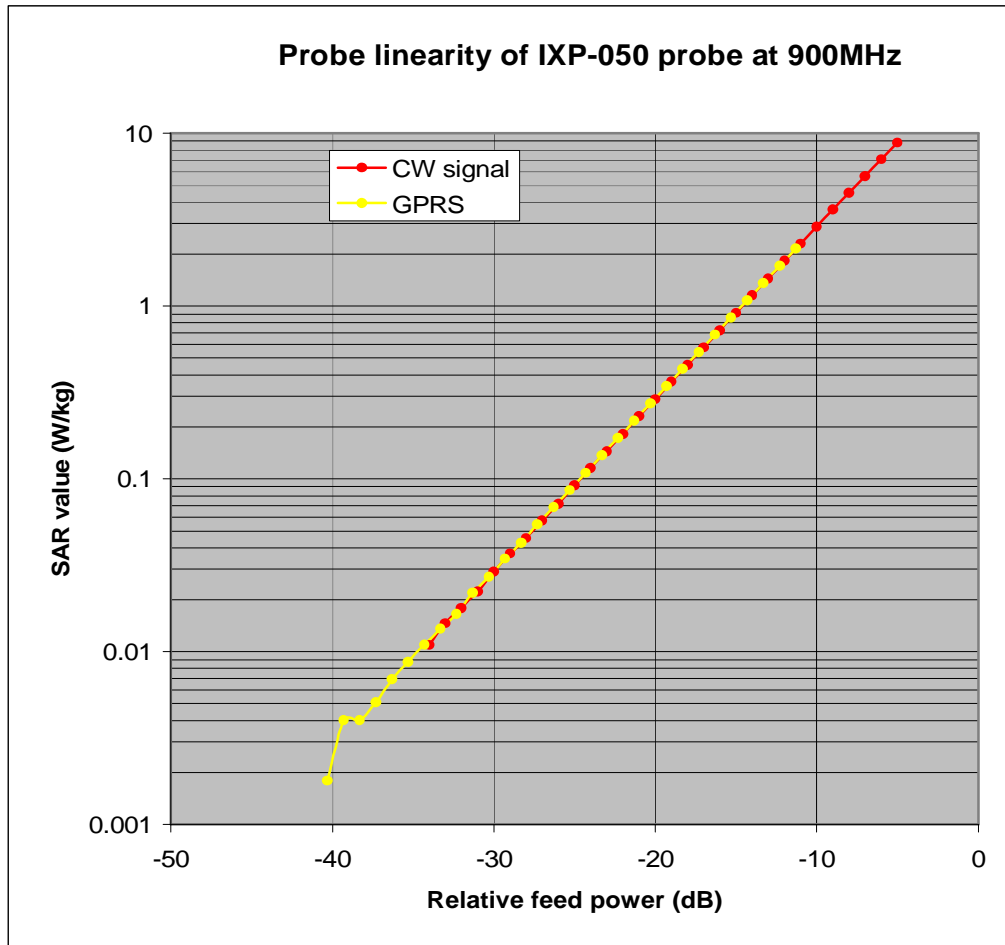

Figure 9. The GPRS response of an IXP-050 probe at 900MHz.

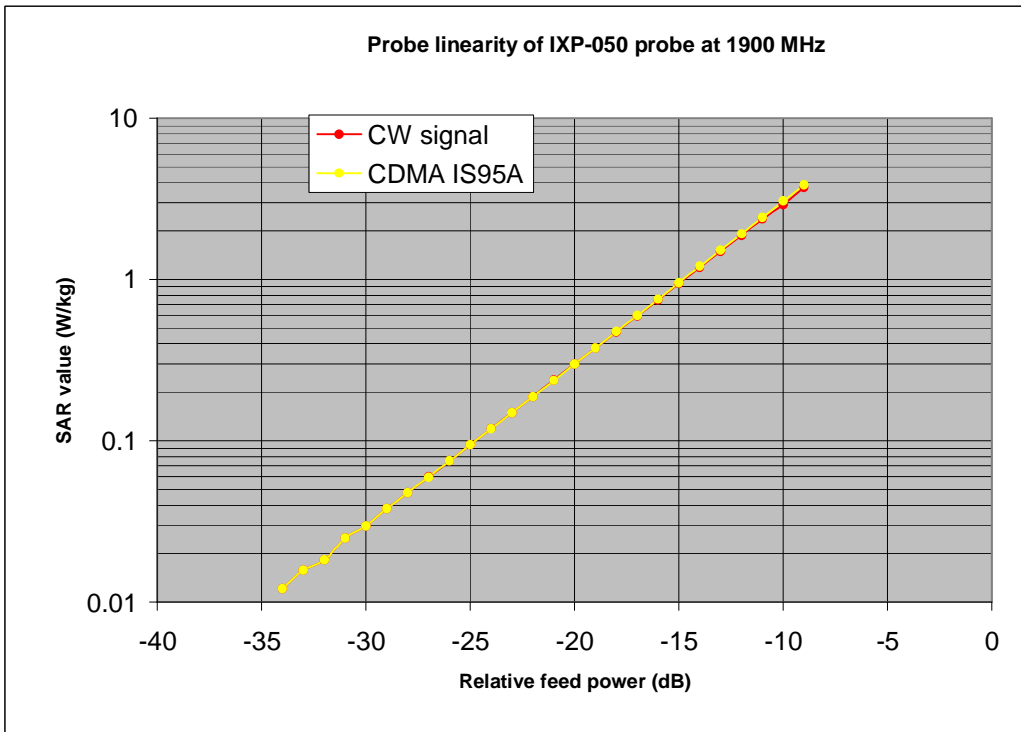
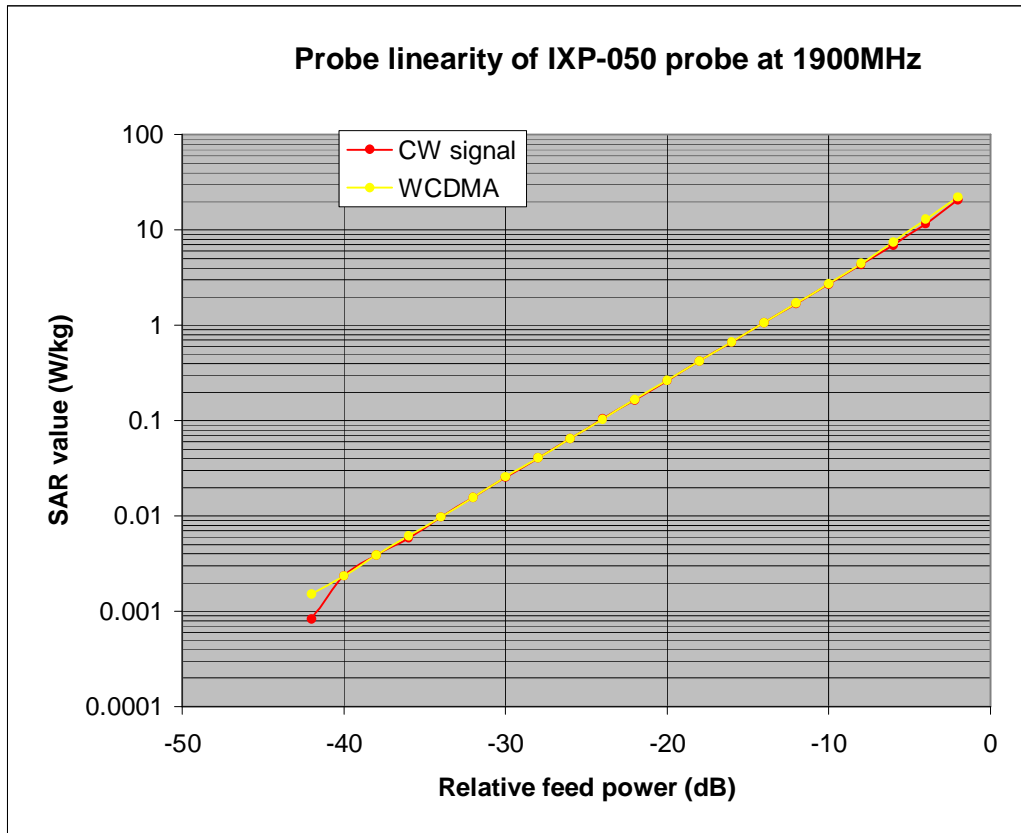

Figure 10. The CDMA response of an IXP-050 probe at 1900MHz.

Table indicating the dielectric parameters of the liquids used for calibrations at each frequency

Liquid used	Relative permittivity (measured)	Conductivity (S/m) (measured)
<i>900 MHz BRAIN</i>	<i>40.92</i>	<i>0.99</i>
<i>900 MHz BODY</i>	<i>57.27</i>	<i>1.045</i>
<i>1800 MHz BRAIN</i>	<i>40.63</i>	<i>1.37</i>
<i>1800 MHz BODY</i>	<i>52.89</i>	<i>1.53</i>
<i>1900 MHz BRAIN</i>	<i>40.33</i>	<i>1.47</i>
<i>1900 MHz BODY</i>	<i>52.84</i>	<i>1.55</i>
<i>2450 MHz BRAIN</i>	<i>40.73</i>	<i>1.82</i>
<i>2450 MHz BODY</i>	<i>54.56</i>	<i>2.04</i>



Report No. SN0048_2450
26th March 2003

INDEXSAR
2450MHz validation Dipole
Type IXD-245 S/N 0048

Performance measurements

- *MI Manning*

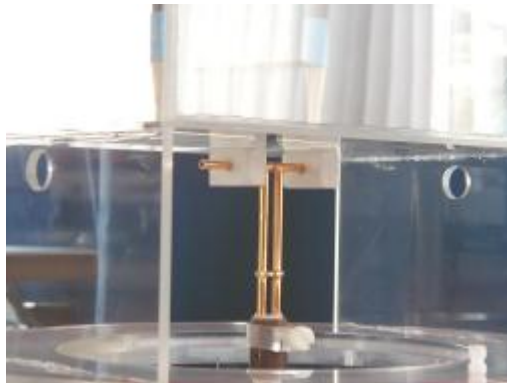

**Indexsar, Oakfield House, Cudworth Lane,
Newdigate, Surrey RH5 5DR. UK.**
Tel: +44 (0) 1306 631233 Fax: +44 (0) 1306 631834
e-mail: enquiries@indexsar.com

**Calibration / Conformance statement****Balanced Validation dipole**

Type:	IXD-245 2450MHz
-------	------------------------

Manufacturer:	IndexSAR, UK
---------------	---------------------

Serial Number:	0048
----------------	-------------

Place of Calibration:	IndexSAR, UK
-----------------------	---------------------

IndexSAR Limited hereby declares that the IXD series dipole named above has been checked for conformity to the specifications given in the draft IEEE 1528 and CENELEC En 50361 standards on the date shown below.

Date of Calibration/Check:	26th March 2003
----------------------------	-----------------------------------

The dipole named above should be periodically re-checked using the procedures set out in the dipole calibration document. It is important that the cautions regarding handling of the dipoles (given in the calibration document) are adhered to.

Next Calibration Date:	March 2005
------------------------	-------------------

The calibration measurements were carried out using the methods described in the calibration document. Where applicable, the standards used in the calibration process are traceable to the UK's National Physical Laboratory.

Calibrated By:	
----------------	---

Approved By:	
--------------	---

1. Tests on Validation Dipole

Tests have been performed on a balanced dipole made for 2450MHz application according to the construction guidelines, dimensions and tolerances given in the draft IEEE1528 standard [1]. Measurements have been made of the impedance and return loss when positioned against the liquid-filled phantom and a validation test has been performed according to the procedures set out in IEEE 1528 [1].

2. Measurement Conditions

Measurements were performed using a box-shaped phantom made of PMMA with dimensions designed to meet the accuracy criteria for reasonably-sized phantoms that do not have liquid capacities substantially in excess of the volume of liquid required to fill the Indexsar upright SAM phantoms used for SAR testing of handsets against the ear.

An HP 8753B vector network analyser was used for the return loss measurements. The dipole was placed in a special holder made of low-permittivity, low-loss materials. This holder enables the dipole to be positioned accurately in the centre of the base of the Indexsar box-phantom used for flat-surface testing and validation checks.

The validation dipoles are supplied with special spacers made from a low-permittivity, low-loss foam material. These spacers are fitted to the dipole arms to ensure that, when the dipole is offered up to the phantom surface, the spacing between the dipole and the liquid surface is accurately aligned according to the guidance in the relevant standards documentation. The spacers are rectangular with a central hole equal to the dipole arm diameter and dimensioned so that the longer side can be used to ensure a spacing of 15mm from the liquid in the phantom (for tests at 900MHz and below) and the shorter side can be used for tests at 1800MHz and above to ensure a spacing of 10mm from the liquid in the phantom. The spacers are made on a CNC milling machine with an accuracy of 1/40th mm but they may suffer wear and tear and need to be replaced periodically. The material used is Rohacell, which has a relative permittivity of approx. 1.05 and a negligible loss tangent.

The apparatus supplied by Indexsar for dipole validation tests thus includes:

Balanced dipoles for each frequency required are dimensioned according to the guidelines given in IEEE 1528 [1]. The dipoles are made from semi-rigid 50 Ohm co-ax, which is joined by soldering and is gold-plated subsequently. The constructed dipoles are easily deformed, if mis-handled, and periodic checks need to be made of their symmetry.

Rohacell foam spacers designed for presenting the dipoles to 2mm thick PMMA box phantoms. These components also suffer wear and tear and should be replaced when the central hole is a loose-fit on the dipole arms or if the edges are too worn to ensure accurate alignment. The standard spacers are dimensioned for use with 2mm wall thickness (additional spacers are available for 4mm wall thickness).

3. SAR Validation Measurement

A SAR validation check was performed with the box-phantom located on the SARA2 phantom support base on the SARA2 robot system. Tests were then conducted at a feed power level of approx. 0.25W. The actual power level was recorded and used to normalise the results obtained to the standard input power conditions of 1W (forward power). The ambient temperature was 24°C.

The phantom was filled with a 2450MHz brain liquid using a recipe from [1], which was measured using an Indexasar DiLine kit at 2450MHz. Measurements were taken at 23°C and 30°C and interpolation was used to find the properties at 24°C which were as below:

Relative Permittivity **39.221**
 Conductivity **1.8714 S/m**

The SARA2 software version 0.420N was used with an Indexasar probe previously calibrated using waveguide techniques.

The 3D measurement made using the dipole at the bottom of the phantom box is shown below:

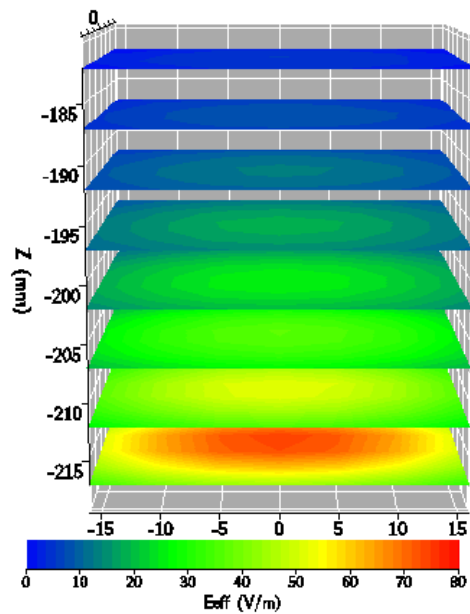

The volume-averaged SAR results, normalised to an input power of 1W (forward power) are:

Averaged over 1 cm³ (1g) of tissue **51.376 W/kg**
 Averaged over 10cm³ (10g) of tissue **23.888 W/kg**

These results can be compared with Table 8.1 in [1]. The agreement is within 10%.

4. Dipole impedance and return loss

The dipoles are designed to have low return loss ONLY when presented against a lossy-phantom at the specified distance. A Vector Network Analyser (VNA) was used to perform a return loss measurement on the specific dipole when in the measurement-location against the box phantom. The distance was as specified in the standard i.e. 10mm from the liquid (for 2450MHz). The Indexsar foam spacers (described above) were used to ensure this condition during measurement.

The impedance was measured at the SMA-connector with the network analyser.
The following parameters were measured:

Dipole impedance at 2450 MHz $\text{Re}\{Z\} = 44.814 \Omega$
 $\text{Im}\{Z\} = -5.3359 \Omega$

Return loss at 2450MHz **-22.122 dB**

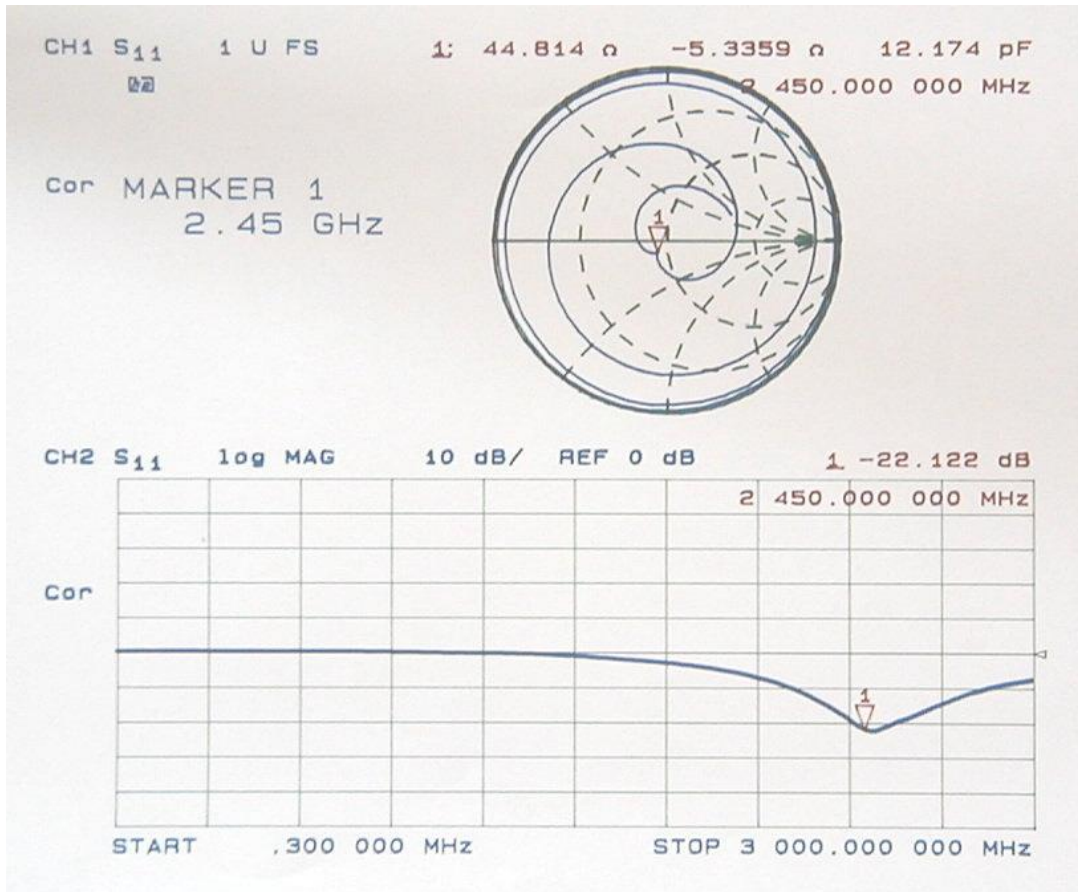

5. Dipole handling

The dipoles are made from standard, copper-sheathed coaxial cable. In assembly, the sections are joined using ordinary soft-soldering. This is necessary to avoid excessive heat input in manufacture, which would destroy the polythene dielectric used for the cable. The consequence of the construction material and the assembly technique is that the dipoles are fragile and can be deformed by rough handling. Conversely, they can be straightened quite easily as described in this report.

If a dipole is suspected of being deformed, a normal workshop lathe can be used as an alignment jig to restore the symmetry. To do this, the dipole is first placed in the headstock of the lathe (centred on the plastic or brass spacers) and the headstock is rotated by hand (do NOT use the motor). A marker (lathe tool or similar) is brought up close to the end of one dipole arm and then the headstock is rotated by 0.5 rev. to check the opposing arm. If they are not balanced, judicious deformation of the arms can be used to restore the symmetry.

If a dipole has a failed solder joint, the dipole can be fixed down in such a way that the arms are co-linear and the joint re-soldered with a reasonably-powerful electrical soldering iron. Do not use gas soldering irons. After such a repair, electrical tests must be performed as described below.

Please note that, because of their construction, the dipoles are short-circuited for DC signals.

6. Tuning the dipole

The dipole dimensions are based on calculations that assumed specific liquid dielectric properties. If the liquid dielectric properties are somewhat different, the dipole tuning will also vary. A pragmatic way of accounting for variations in liquid properties is to 'tune' the dipole (by applying minor variations to its effective length). For this purpose, Indexsar can supply short brass tube lengths to extend the length of the dipole and thus 'tune' the dipole. It cannot be made shorter without removing a bit from the arm. An alternative way to tune the dipole is to use copper shielding tape to extend the effective length of the dipole. Do both arms equally.

It should be possible to tune a dipole as described, whilst in place in the measurement position as long as the user has access to a VNA for determining the return loss.

7. Reference

[1] Draft recommended practice for determining the peak spatial-average specific absorption rate (SAR) in the human body due to wireless communications devices: Measurement Techniques. Draft CD1.1 – December 29, 2002.