



FCC TEST REPORT

According to

FCC CFR Title 47 Part 15 Subpart C

Applicant	: ZyXEL Communications Corp.
Address	: No. 6, Innovation Road II, Science Park, Hsinchu 300, Taiwan
Manufacturer	: ZyXEL Communications Corp.
Address	: 60#-E Minshan Road, Wuxi New District Jiangsu PRC
Equipment	: Wireless N FTTH Router
Model No.	: FR1000Z
FCC ID	: I88FR1000Z

- The test result refers exclusively to the test presented test model / sample.
- Without written approval of **CerpPASS Technology Corp.** the test report shall not be reproduced except in full.
- The test report must not be used by the clients to claim product certification approval by **NVLAP** or any agency of the Government.



Table of Contents

1. Report of Measurements and Examinations.....	6
2. Test Configuration of Equipment under Test.....	7
2.1. Feature of Equipment under Test	7
2.2. Carrier Frequency of Channels	8
2.3. Test Manner	9
2.4. Description of Test System	9
2.5. Connection Diagram of Test System	10
2.6. General Information of Test	11
2.7. Measurement Uncertainty	11
3. Test of Conducted Emission	12
3.1. Test Limit.....	12
3.2. Test Procedures.....	12
3.3. Typical Test Setup.....	13
3.4. Measurement Equipment	13
3.5. Test Result and Data	14
4. Test of Radiated Emission.....	18
4.1. Test Limit.....	18
4.2. Test Procedures.....	18
4.3. Typical Test Setup.....	19
4.4. Measurement Equipment	20
4.5. Test Result and Data	21
5. Occupied Bandwidth	93
5.1. Test Limit.....	93
5.2. Test Procedures.....	93
5.3. Test Setup Layout.....	93
5.4. Measurement Equipment	93
5.5. Test Result and Data	94
6. Maximum Peak Output Power	106
6.1. Test Limit.....	106
6.2. Test Procedure	106
6.3. Test Setup Layout.....	107
6.4. Measurement Equipment	107
6.5. Test Result and Data	108
7. Band Edges	120
7.1. Test Limit.....	120
7.2. Test Procedure	120
7.3. Test Setup Layout.....	121
7.4. Measurement Equipment	121
7.5. Test Result and Data	122
8. Power Spectral Density.....	144
8.1. Test Limit.....	144



8.2. Test Procedure	144
8.3. Test Setup Layout.....	144
8.4. Measurement Equipment	144
8.5. Test Result and Data	145



FCC TEST REPORT

according to

FCC CFR Title 47 Part 15 Subpart C

Applicant : ZyXEL Communications Corp.
Address : No. 6, Innovation Road II, Science Park, Hsinchu
300, Taiwan
Manufacturer : ZyXEL Communications Corp.
Address : 60#-E Minshan Road, Wuxi New District Jiangsu
PRC
Equipment : Wireless N FTTH Router
Model No. : FR1000Z
FCC ID : I88FR1000Z

I HEREBY CERTIFY THAT :

The measurements shown in this test report were made in accordance with the procedures given in **ANSI C63.4 – 2003** and the energy emitted by this equipment was **passed CISPR PUB. 22 and FCC Part 15** in both radiated and conducted emission class B limits. Testing was carried out on Jun 30, 2010 at **Cerpass Technology Corp.**

Documented By:

Approved By:

Cathy Chen/ Administration

Hill Chen/ Technical director



1. Report of Measurements and Examinations

FCC CFR Title 47 Part 15 Subpart C: 2007			
ANSI C63.4: 2003			
Clause	Test Parameter	Test Performed	Remark
15.207	Conducted Emission	YES	PASS
15.209	Radiated Emission	YES	PASS
15.247(a) 15.215(c)	Occupied Bandwidth	YES	PASS
15.247(b)	Maximum Peak Output Power	YES	PASS
15.247(d)	Band Edges	YES	PASS
15.247(d)	Power Spectral Density	YES	PASS



2. Test Configuration of Equipment under Test

2.1. Feature of Equipment under Test

Wireless N FTTH Router	Model No:	FR1000Z
POWER SUPPLY	Model No.:	MT12-Y120100-A1
	Input:	120V~ 60Hz 0.3A
	Output:	12V $\overline{\text{---}}$ 1.0A
DC Cable	Non-Shielded, 1.5m	
LAN Cable	Non-Shielded, 1.5m	

WLAN	Broadcom/BCM43222
Spreading	802.11b: DSSS 802.11g / n: OFDM
Frequency Range	802.11b/g/n(20MHz): 2412-2462MHz 802.11n(40MHz): 2422-2452MHz
Number of Channels	802.11b/g/n (20MHz):11 802.11n (40MHz): 7
Data Rate	802.11b: 11, 5.5, 2, 1 Mbps 802.11g: 54, 48, 36, 24, 18, 12, 9, 6 Mbps 802.11n: up to 300Mbps
Antenna Type	Dipole antenna
Antenna Gain	Ant0: AN2400-9209RS/5.7dBi; Ant1: AN2400-9209RS/5.7dBi;



2.2. Carrier Frequency of Channels

802.11b, 802.11g, 802.11n (20MHz)

Channel	Frequency(MHz)	Channel	Frequency(MHz)
01	2412	07	2442
02	2417	08	2447
03	2422	09	2452
04	2427	10	2457
05	2432	11	2462
06	2437	---	---

802.11n (40MHz)

Channel	Frequency(MHz)	Channel	Frequency(MHz)
---	---	07	2442
---	---	08	2447
03	2422	09	2452
04	2427	---	---
05	2432	---	---
06	2437	---	---



2.3. Test Manner

Test Manner	
a	During testing, the interface cables and equipment positions were varied according to 47 CFR, Part 2, Part 15
b	The complete test system included HUB, IPOD, Notebook, PC and EUT for RF test.
c	During the test, Connect the HUB, IPOD, Notebook, PC and EUT.
d	Adjust the EUT at the test mode and the channel. Then test.
The test modes:	
	Mode 1: Transmit by 802.11b (An0)
	Mode 2: Transmit by 802.11g (An0)
	Mode 3: Transmit by 802.11n (20MHz) (An0 and An1)
	Mode 4: Transmit by 802.11n (40MHz) (An0 and An1)

2.4. Description of Test System

No	Device	Manufacturer	Model No.	Description
1	HUB	D-Link	DI-504	N/A
2	IPOD	Apple	MA477TA/A	N/A
3	Notebook	ASUS	W6A	Power by adaptor
4	PC	DELL	DCTA	N/A



2.5. Connection Diagram of Test System

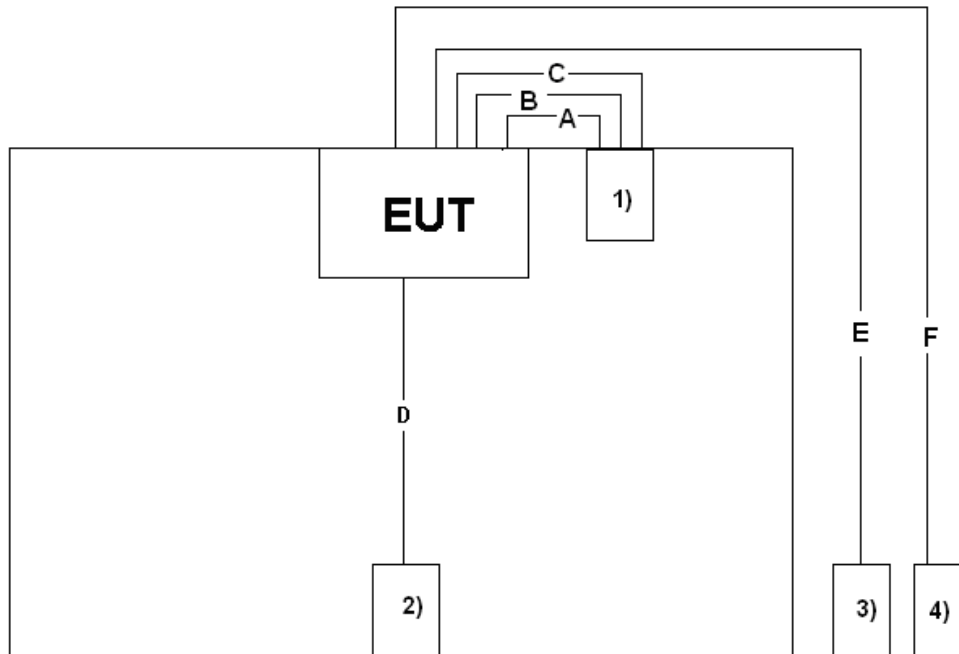

Use Cable

Item	Cable	Quantity	Description
A	LAN Cable	1	Non-Shielding, 3.0m
B	LAN Cable	1	Non-Shielding, 3.0m
C	LAN Cable	1	Non-Shielding, 3.0m
D	USB Cable	1	Shielding, 1.2m
E	LAN Cable	1	Non-Shielding, >3.0m
F	LAN Cable	1	Non-Shielding, >3.0m

**2.6. General Information of Test**

Test Site:	Cerpass Technology Corp.
Performand Location :	No.66,Tangzhuang Road, Suzhou Industrial Park, Jiangsu 215006, China
NVLAP LAB Code :	200814-0
FCC Registration Number :	916572
IC Registration Number :	7290A-1
VCCI Registration Number :	T-343 for Telecommunication Test C-2919 for Conducted emission test R-2670 for Radiated emission test

Laboratory accreditation

**2.7. Measurement Uncertainty**

Measurement Item	Measurement Frequency	Polarization	Uncertainty
Conducted Emission	9 kHz ~ 30 MHz	LINE/NEUTRAL	±2.71 dB
Radiated Emission	30 MHz ~ 25GHz	Vertical	±4.11 dB
		Horizontal	±4.10 dB
Occupied Bandwidth	---	---	±7500 Hz
Maximum Peak Output Power	---	---	±1.4 dB
Band Edges	---	---	±2.2 dB
Power Spectral Density	---	---	±2.2 dB



3. Test of Conducted Emission

3.1. Test Limit

Conducted Emissions were measured from 150 kHz to 30 MHz with a bandwidth of 9 KHz on the 120 VAC power and return leads of the EUT according to the methods defined in ANSI C63.4-2003 Section 3.1. The EUT was placed on a nonmetallic stand in a shielded room 0.8 meters above the ground plane as shown in section 2.2. The interface cables and equipment positioning were varied within limits of reasonable applications to determine the position produced maximum conducted emissions.

Frequency (MHz)	Quasi Peak (dB μ V)	Average (dB μ V)
0.15 – 0.5	66-56*	56-46*
0.5 – 5.0	56	46
5.0 – 30.0	60	50

*Decreases with the logarithm of the frequency.

3.2. Test Procedures

The EUT was setup according to ANSI C63.4, 2003 and tested according to DTS test procedure of Oct 2002 KDB558074 for compliance to FCC 47CFR 15.247 requirements.

The EUT was placed on a platform of nominal size, 1 m by 1.5 m, raised 80 cm above the conducting ground plane. The vertical conducting plane was located 40 cm to the rear of the EUT. All other surfaces of EUT were at least 80 cm from any other grounded conducting surface. The EUT and simulators are connected to the main power through a line impedance stabilization network (LISN). The LISN provides a 50 ohm /50uH coupling impedance for the measuring equipment. The peripheral devices are also connected to the main power through a LISN. (Please refer to the block diagram of the test setup and photographs)

Each current-carrying conductor of the EUT power cord, except the ground (safety) conductor, was individually connected through a LISN to the input power source.

The excess length of the power cord between the EUT and the LISN receptacle were folded back and forth at the center of the lead to form a bundle not exceeding 40 cm in length.

Conducted emissions were investigated over the frequency range from 0.15MHz to 30MHz using a receiver bandwidth of 9kHz.



3.3. Typical Test Setup

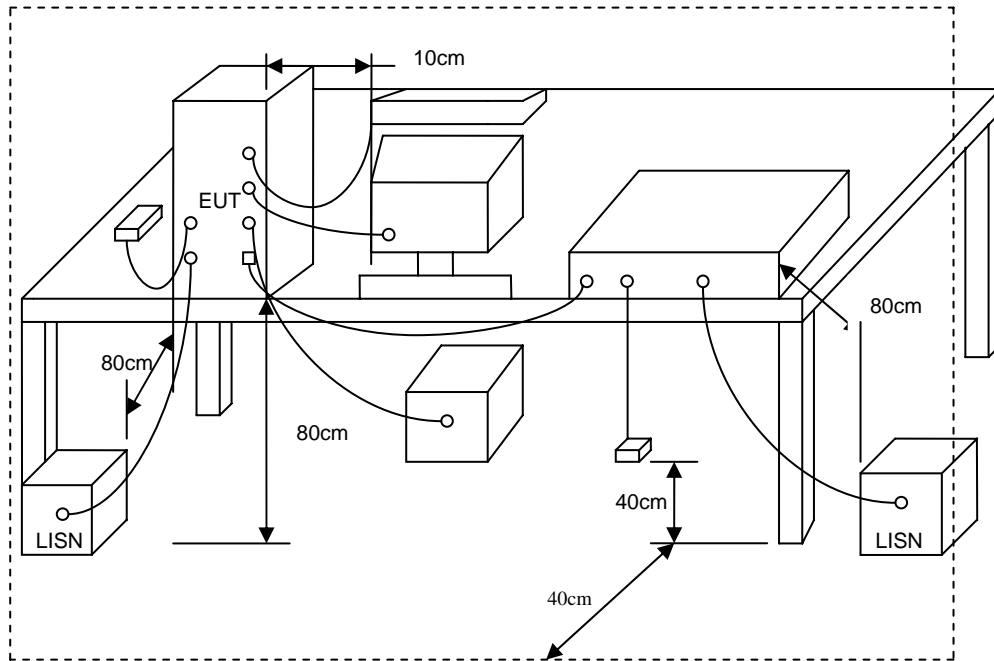

3.4. Measurement Equipment

Instrument	Manufacturer	Model No.	Serial No.	Calibration Date
EMC Emission Tester	EMCPARTNER	Harmonics-1000	159	2009.09.08
Test Receiver	R&S	ESCI	100565	2010.01.15
AMN	R&S	ESH2-Z5	100182	2010.06.23
Two-Line V-Network	R&S	ENV216	100325	2010.06.23
ISN	FCC	FCC-TLISN-T2-02	20379	2010.06.23
ISN	FCC	FCC-TLISN-T4-02	20380	2010.06.23
ISN	FCC	FCC-TLISN-T8-02	20381	2010.06.23
Attenuator	R&S	ESH3-Z2	100529	2010.01.11
Temperature/ Humidity Meter	Zhicheng	ZC1-11	CEP-TH-004	2009.10.19



3.5. Test Result and Data

Test Mode :	Mode 1: Transmit by 802.11b (An0) (2437MHz)		
AC Power :	AC 120V/60Hz	Phase :	L&N
Temperature :	21°C	Humidity:	51%
Pressur(mbar) :	1002	Date:	2010/06/29

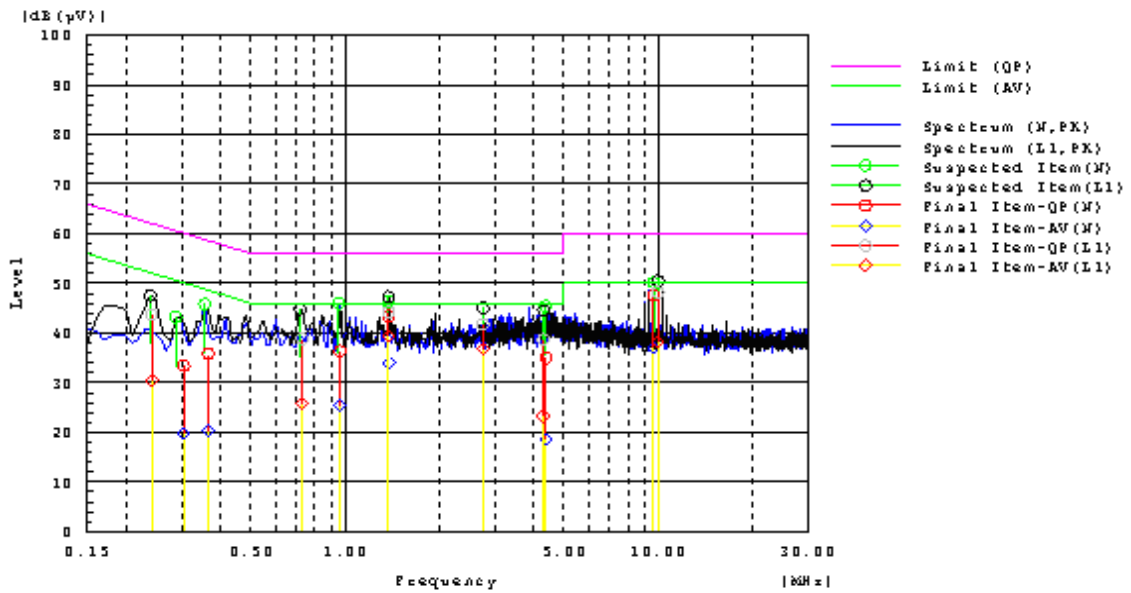

Frequency MHz	Line Phase	Reading dB(uV) QP	Reading dB(uV) AV	Factor dB	Level dB(uV) QP	Level dB(uV) AV	Limit dB(uV) QP	Limit dB(uV) AV	Margin dB QP	Margin dB AV	Pass/Fail
1.37705	L1	24.6	19.7	19.7	44.3	39.4	56.0	46.0	11.7	6.6	Pass
9.9758	L1	28.5	18.5	19.7	48.2	38.2	60.0	50.0	11.8	11.8	Pass
0.72802	L1	19.1	6.0	19.8	38.9	25.8	56.0	46.0	17.1	20.2	Pass
2.75445	L1	22.1	17.2	19.7	41.8	36.9	56.0	46.0	14.2	9.1	Pass
0.24099	L1	23.8	10.6	19.9	43.7	30.5	62.1	52.1	18.4	21.6	Pass
4.28608	L1	19.0	3.6	19.7	38.7	23.3	56.0	46.0	17.3	22.7	Pass
0.36466	N	16.3	0.8	19.5	35.8	20.3	58.6	48.6	22.8	28.3	Pass
0.30472	N	13.9	0.2	19.5	33.4	19.7	60.1	50.1	26.7	30.4	Pass
9.6507	N	27.9	17.4	19.8	47.7	37.2	60.0	50.0	12.3	12.8	Pass
1.37598	N	24.0	14.6	19.5	43.5	34.1	56.0	46.0	12.5	11.9	Pass
0.96257	N	17.0	6.0	19.4	36.4	25.4	56.0	46.0	19.6	20.6	Pass
4.37736	N	15.4	-1.0	19.6	35.0	18.6	56.0	46.0	21.0	27.4	Pass

Note: Measurement Level = Reading Level + Correct Factor



Test Mode :	Mode 2: Transmit by 802.11g (An0) (2437MHz)		
AC Power :	AC 120V/60Hz	Phase :	L&N
Temperature :	21°C	Humidity:	51%
Pressur(mbar) :	1002	Date:	2010/06/29

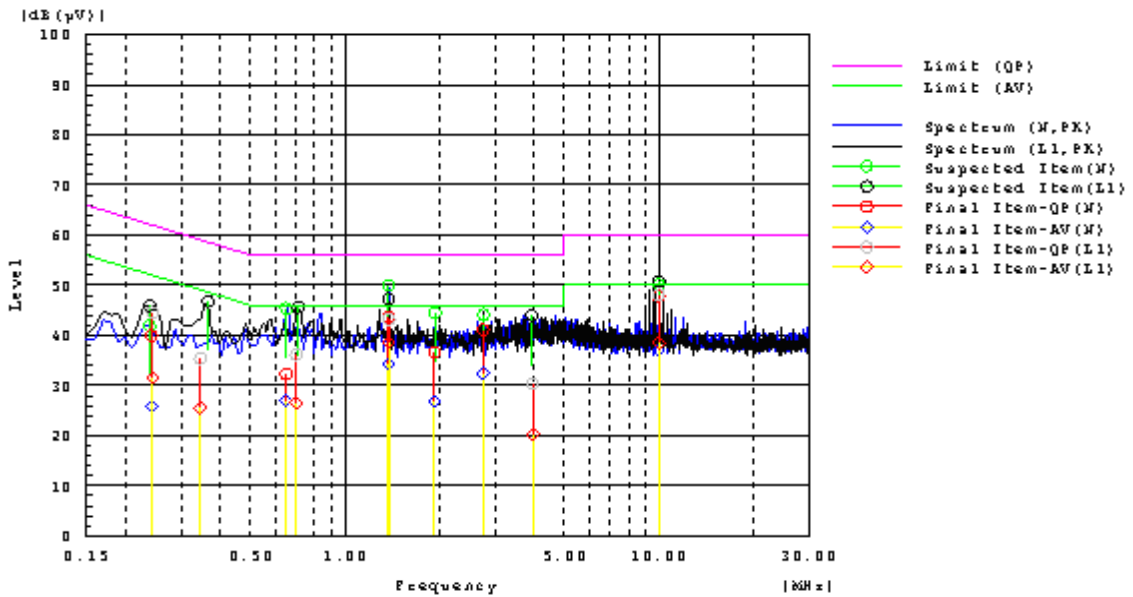

Frequency MHz	Line Phase	Reading dB(uV) QP	Reading dB(uV) AV	Factor dB	Level dB(uV) QP	Level dB(uV) AV	Limit dB(uV) QP	Limit dB(uV) AV	Margin dB QP	Margin dB AV	Pass/Fail
1.3787	L1	23.5	18.8	19.7	43.2	38.5	56.0	46.0	12.8	7.5	Pass
0.34584	L1	15.5	5.7	19.9	35.4	25.6	59.1	49.1	23.7	23.5	Pass
0.24322	L1	24.7	11.6	19.9	44.6	31.5	62.0	52.0	17.4	20.5	Pass
9.968	L1	28.4	18.8	19.7	48.1	38.5	60.0	50.0	11.9	11.5	Pass
3.95502	L1	10.7	0.6	19.7	30.4	20.3	56.0	46.0	25.6	25.7	Pass
0.69853	L1	16.4	6.8	19.8	36.2	26.6	56.0	46.0	19.8	19.4	Pass
0.64848	N	12.8	7.5	19.5	32.3	27.0	56.0	46.0	23.7	19.0	Pass
1.37627	N	24.1	14.7	19.5	43.6	34.2	56.0	46.0	12.4	11.8	Pass
9.9686	N	28.0	17.3	19.8	47.8	37.1	60.0	50.0	12.2	12.9	Pass
1.92607	N	17.1	7.3	19.5	36.6	26.8	56.0	46.0	19.4	19.2	Pass
0.24186	N	20.5	6.4	19.5	40.0	25.9	62.0	52.0	22.0	26.1	Pass
2.75435	N	21.6	12.8	19.6	41.2	32.4	56.0	46.0	14.8	13.6	Pass

Note: Measurement Level = Reading Level + Correct Factor



Test Mode :	Mode 3: Transmit by 802.11n(20MHz) (An0) (2437MHz)		
AC Power :	AC 120V/60Hz	Phase :	L&N
Temperature :	21°C	Humidity:	51%
Pressur(mbar) :	1002	Date:	2010/06/29

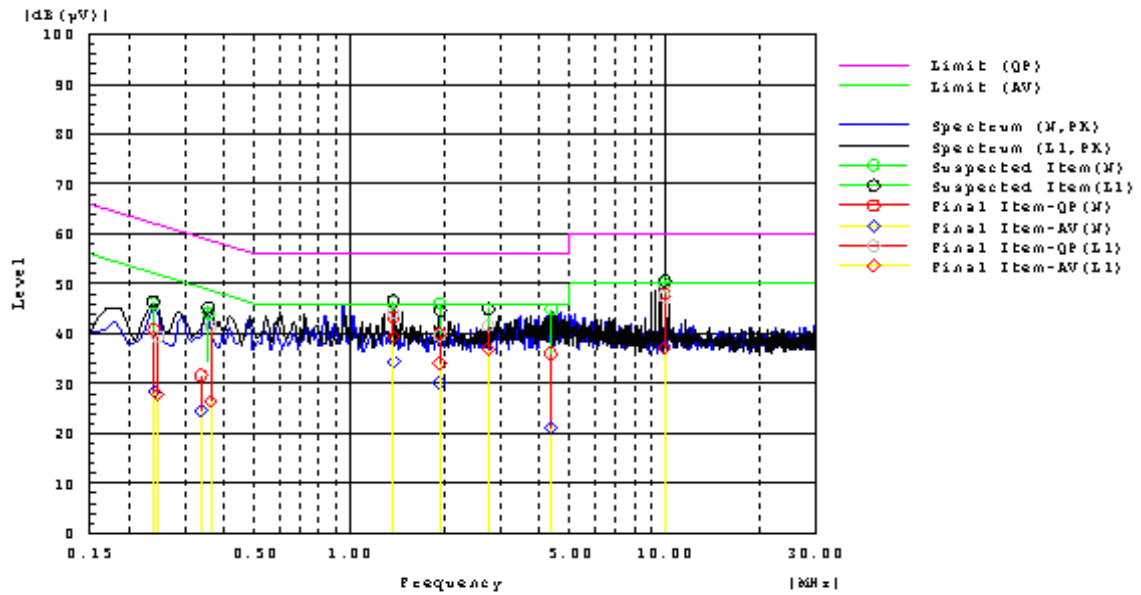

Frequency MHz	Line Phase	Reading dB(uV) QP	Reading dB(uV) AV	Factor dB	Level dB(uV) QP	Level dB(uV) AV	Limit dB(uV) QP	Limit dB(uV) AV	Margin dB QP	Margin dB AV	Pass/Fail
1.37666	L1	24.5	19.8	19.7	44.2	39.5	56.0	46.0	11.8	6.5	Pass
0.24661	L1	19.5	7.9	19.9	39.4	27.8	61.9	51.9	22.5	24.1	Pass
9.9634	L1	27.7	17.3	19.7	47.4	37.0	60.0	50.0	12.6	13.0	Pass
2.75338	L1	21.9	17.3	19.7	41.6	37.0	56.0	46.0	14.4	9.0	Pass
1.92859	L1	19.9	14.4	19.7	39.6	34.1	56.0	46.0	16.4	11.9	Pass
0.36282	L1	21.6	6.7	19.9	41.5	26.6	58.7	48.7	17.2	22.1	Pass
0.23953	N	21.4	8.9	19.5	40.9	28.4	62.1	52.1	21.2	23.7	Pass
0.3375	N	12.2	5.1	19.5	31.7	24.6	59.3	49.3	27.6	24.7	Pass
1.37686	N	23.8	15.0	19.5	43.3	34.5	56.0	46.0	12.7	11.5	Pass
9.9628	N	28.2	17.5	19.8	48.0	37.3	60.0	50.0	12.0	12.7	Pass
1.92714	N	20.5	10.7	19.5	40.0	30.2	56.0	46.0	16.0	15.8	Pass
4.34205	N	16.4	1.4	19.6	36.0	21.0	56.0	46.0	20.0	25.0	Pass

Note: Measurement Level = Reading Level + Correct Factor



Test Mode :	Mode 4: Transmit by 802.11 n(40MHz) (An0) (2437MHz)		
AC Power :	AC 120V/60Hz	Phase :	L&N
Temperature :	21°C	Humidity:	51%
Pressur(mbar) :	1002	Date:	2010/06/29

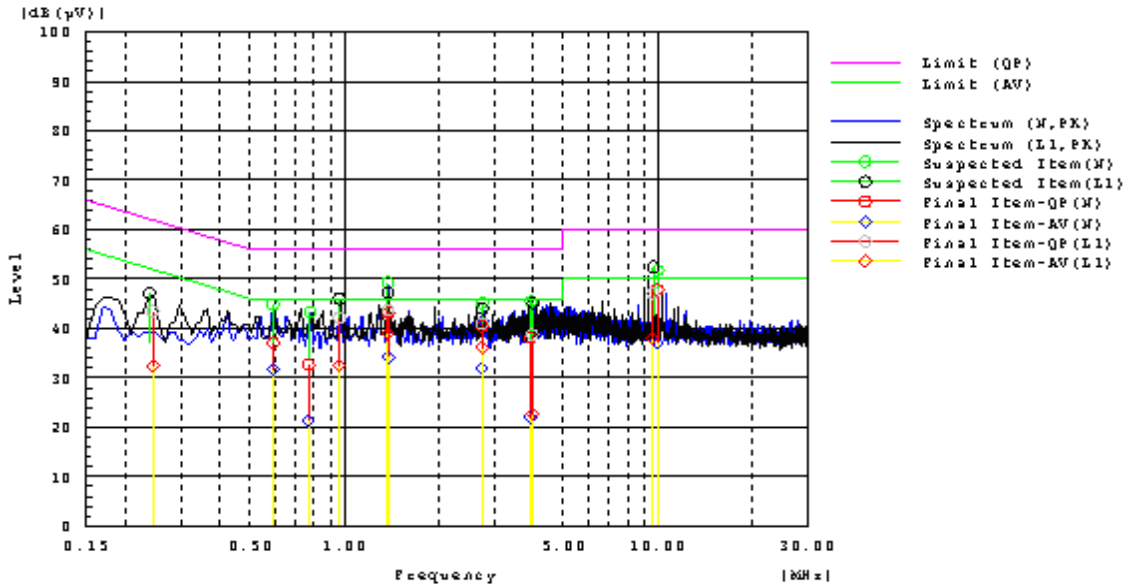

Frequency MHz	Line Phase	Reading dB(uV) QP	Reading dB(uV) AV	Factor dB	Level dB(uV) QP	Level dB(uV) AV	Limit dB(uV) QP	Limit dB(uV) AV	Margin dB QP	Margin dB AV	Pass/Fail
1.37724	N	23.7	14.7	19.5	43.2	34.2	56.0	46.0	12.8	11.8	Pass
0.59251	N	17.6	12.2	19.5	37.1	31.7	56.0	46.0	18.9	14.3	Pass
9.9644	N	28.0	17.3	19.8	47.8	37.1	60.0	50.0	12.2	12.9	Pass
3.91709	N	18.5	2.5	19.6	38.1	22.1	56.0	46.0	17.9	23.9	Pass
2.75096	N	20.9	12.3	19.6	40.5	31.9	56.0	46.0	15.5	14.1	Pass
0.76779	N	13.2	1.8	19.5	32.7	21.3	56.0	46.0	23.3	24.7	Pass
0.96305	L1	22.3	12.7	19.8	42.1	32.5	56.0	46.0	13.9	13.5	Pass
9.6424	L1	27.5	18.3	19.7	47.2	38.0	60.0	50.0	12.8	12.0	Pass
3.97277	L1	19.1	3.0	19.7	38.8	22.7	56.0	46.0	17.2	23.3	Pass
1.37569	L1	24.0	19.1	19.7	43.7	38.8	56.0	46.0	12.3	7.2	Pass
0.24438	L1	23.6	12.6	19.9	43.5	32.5	61.9	51.9	18.4	19.4	Pass
2.75164	L1	21.3	16.5	19.7	41.0	36.2	56.0	46.0	15.0	9.8	Pass

Note: Measurement Level = Reading Level + Correct Factor

Test engineer: Fred Guo



4. Test of Radiated Emission

4.1. Test Limit

Radiated emissions from 30 MHz to 25 GHz were measured according to the methods defines in ANSI C63.4-2003. The EUT was placed, 0.8 meter above the ground plane, as shown in section 5.6.3. The interface cables and equipment positions were varied within limits of reasonable applications to determine the positions producing maximum radiated emissions for unintentional device, according to § 15.109(a), except for Class A digital devices, the field strength of radiated emissions from unintentional radiators at a distance of 3 meters shall not exceed the following values:

Frequency (MHz)	Distance Meters	Radiated (μ V / M)	Radiated (dB μ V/ M)
30-88	3	100	40.0
88-216	3	150	43.5
216-960	3	200	46.0
Above 960	3	500	54.0

For unintentional device, according to CISPR PUB.22, for Class B digital devices, the general requirement of field strength of radiated emissions from intentional radiators at a distance of 10 meters shall not exceed the below table.

Frequency (MHz)	Distance Meters	Radiated (dB μ V/ M)
30-230	10	30
230-1000	10	37

4.2. Test Procedures

The EUT was setup according to ANSI C63.4, 2003 and tested according to DTS test procedure of Oct 2002 KDB558074 for compliance to FCC 47CFR 15.247 requirements.

The EUT is placed on a turn table which is 0.8 meter above ground plane. The antenna to EUT distance is 3 meters. The EUT is configured in accordance with ANSI C63.4. The EUT is set to transmit in a continuous mode.

For measurements below 1GHz the resolution bandwidth is set to 100kHz for peak detection measurements or 120kHz for quasi-peak detection measurements. Peak detection is used unless otherwise noted as quasi-peak.

For measurements above 1GHz the resolution bandwidth is set to 1MHz, then the video



bandwidth is set to 1MHz for peak measurements and 10Hz for average measurements.

The spectrum from 30MHz to 26GHz is investigated with the transmitter set to the lowest, middle and highest channels in the 2.4GHz band.

The frequency range of interest is monitored at a fixed antenna height and EUT azimuth. The EUT is rotated through 360 degrees to maximize emissions received. The antenna is scanned from 1 to 4 meters above the ground plane to further maximize the emission. Measurements are Made with the antenna polarized in both the vertical and the horizontal positions.

When performing radiated measurements >1 GHz, the EUT always remains within the 3dB beam-width of the measuring antenna.

4.3. Typical Test Setup

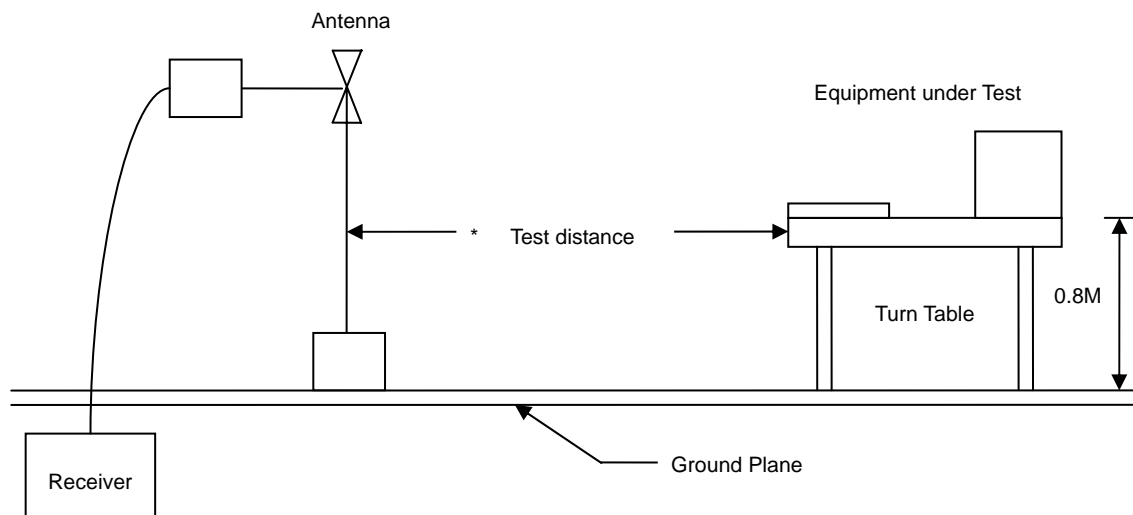



4.4. Measurement Equipment

Instrument	Model No.	Manufacturer	Serial No.	Calibration Date
EMI Test Receiver	R&S	ESCI	100564	2010.06.23
Preamplifier	Agilent	87405B	My39500554	2010.02.10
Preamplifier	Agilent	8449B	ED-HE-EMI-077	2010.02.10
Ultra Broadband Antenna	R&S	HL562	100362	2009.11.25
Broad-Band Horn Antenna	Schwarzbeck	BBHA9120D	9120D-619	2009.11.10
Spectrum Analyzer	R&S	FSP40	100324	2009.11.02
Temperature/ Humidity Meter	Zhicheng	ZC1-11	CEP-TH-001	2009.10.19



4.5. Test Result and Data

Under 1G:

Engineer : Fred	
Site : EMC Lab AC 102	Time : 2010/06/30 - 10:41
Limit : FCC_CLASS_B_03M_QP	Margin : 6
EUT : Wireless N FTTH Router	Probe : HL562(30-1000MHz) - HORIZONTAL
Power : AC 120V/60Hz	Note : Mode 1: Transmit by 802.11b (An0) (2412MHz)

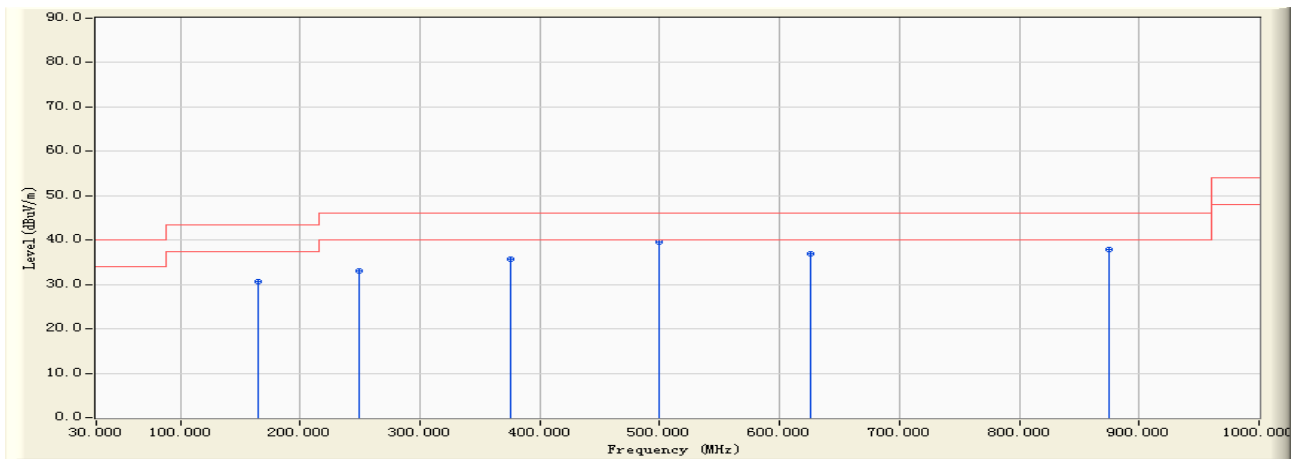

		Frequency (MHz)	Correct Factor (dB)	Reading Level (dBuV)	Measure Level (dBuV/m)	Margin (dB)	Limit (dBuV/m)	Detector Type
1		165.320	-17.718	48.310	30.592	-12.908	43.500	QUASPEAK
2		249.310	-15.276	48.310	33.033	-12.967	46.000	QUASPEAK
3		375.830	-11.286	47.090	35.805	-10.195	46.000	QUASPEAK
4	*	500.002	-8.875	48.360	39.485	-6.515	46.000	QUASPEAK
5		625.310	-6.880	43.890	37.010	-8.990	46.000	QUASPEAK
6		874.990	-1.980	39.760	37.780	-8.220	46.000	QUASPEAK

Note:

1. All Readings below 1GHz are Quasi-Peak, above are performed with peak and/or average measurements as necessary.
2. " * ", means this data is the worst emission level.
3. Measurement Level = Reading Level + Correct Factor



Engineer : Fred	
Site : EMC Lab AC 102	Time : 2010/06/30 - 10:44
Limit : FCC_CLASS_B_03M_QP	Margin : 6
EUT : Wireless N FTTH Router	Probe : HL562(30-1000MHz) - VERTICAL
Power : AC 120V/60Hz	Note : Mode 1: Transmit by 802.11b (An0) (2412MHz)

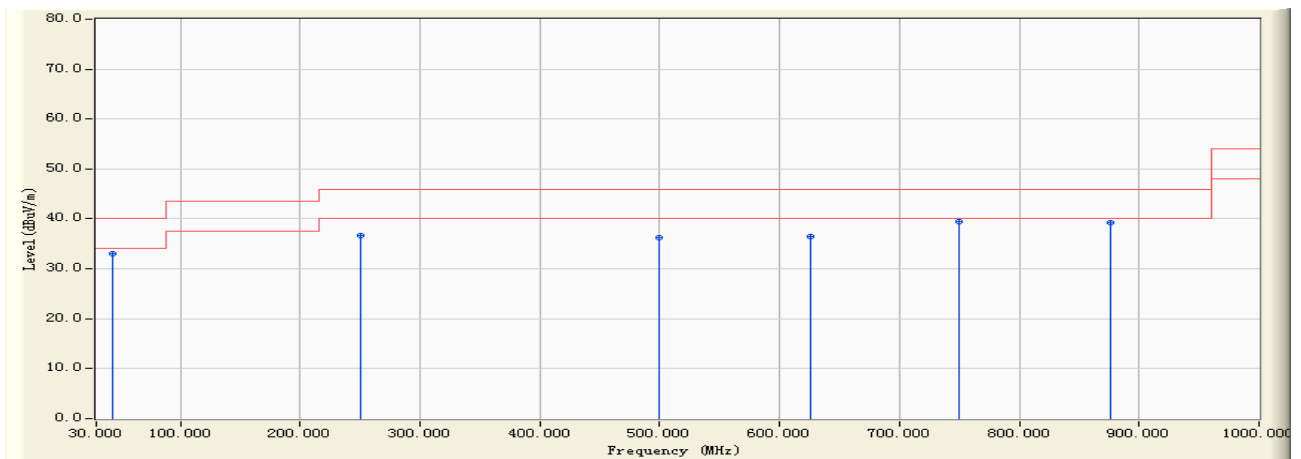

		Frequency (MHz)	Correct Factor (dB)	Reading Level (dBuV)	Measure Level (dBuV/m)	Margin (dB)	Limit (dBuV/m)	Detector Type
1		43.783	-15.257	48.310	33.054	-6.946	40.000	QUASPEAK
2		250.016	-15.237	51.920	36.683	-9.317	46.000	QUASPEAK
3		499.136	-8.896	45.200	36.304	-9.696	46.000	QUASPEAK
4		625.301	-6.879	43.260	36.381	-9.619	46.000	QUASPEAK
5	*	749.320	-4.395	43.910	39.515	-6.485	46.000	QUASPEAK
6		876.310	-2.061	41.290	39.229	-6.771	46.000	QUASPEAK

Note:

1. All Readings below 1GHz are Quasi-Peak, above are performed with peak and/or average measurements as necessary.
2. " * ", means this data is the worst emission level.
3. Measurement Level = Reading Level + Correct Factor



Engineer : Fred	
Site : EMC Lab AC 102	Time : 2010/06/30 - 10:47
Limit : FCC_CLASS_B_03M_QP	Margin : 6
EUT : Wireless N FTTH Router	Probe : HL562(30-1000MHz) - HORIZONTAL
Power : AC 120V/60Hz	Note : Mode 1: Transmit by 802.11b (An0) (2437MHz)

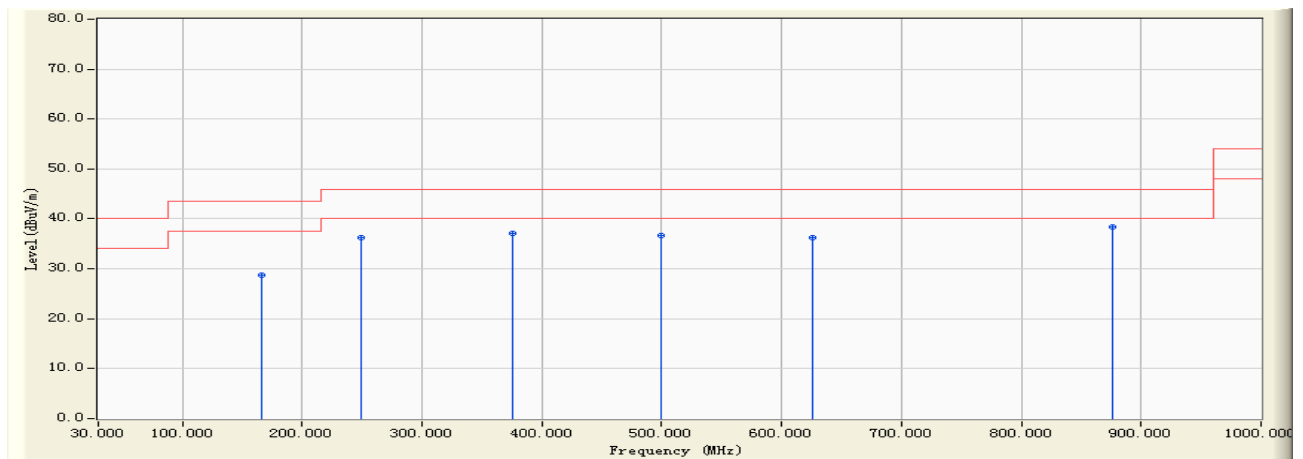

		Frequency (MHz)	Correct Factor (dB)	Reading Level (dBuV)	Measure Level (dBuV/m)	Margin (dB)	Limit (dBuV/m)	Detector Type
1		166.276	-17.663	46.510	28.847	-14.653	43.500	QUASPEAK
2		249.890	-15.245	51.560	36.315	-9.685	46.000	QUASPEAK
3	*	375.030	-11.290	48.350	37.060	-8.940	46.000	QUASPEAK
4		499.998	-8.875	45.600	36.725	-9.275	46.000	QUASPEAK
5		625.370	-6.882	43.060	36.179	-9.821	46.000	QUASPEAK
6		876.310	-2.061	40.360	38.299	-7.701	46.000	QUASPEAK

Note:

1. All Readings below 1GHz are Quasi-Peak, above are performed with peak and/or average measurements as necessary.
2. " * ", means this data is the worst emission level.
3. Measurement Level = Reading Level + Correct Factor



Engineer : Fred	
Site : EMC Lab AC 102	Time : 2010/06/30 - 10:49
Limit : FCC_CLASS_B_03M_QP	Margin : 6
EUT : Wireless N FTTH Router	Probe : HL562(30-1000MHz) - VERTICAL
Power : AC 120V/60Hz	Note : Mode 1: Transmit by 802.11b (An0) (2437MHz)

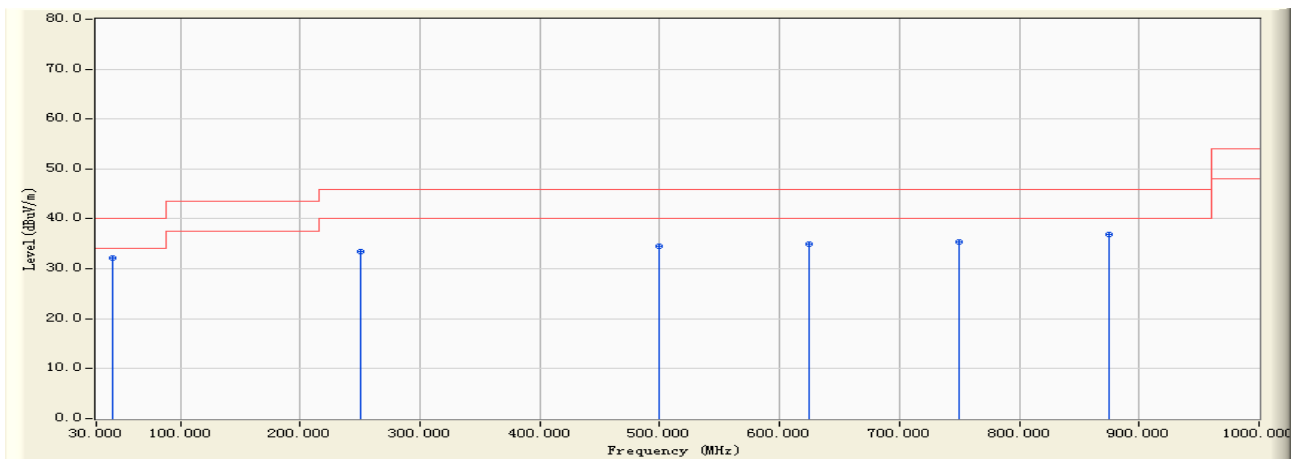

		Frequency (MHz)	Correct Factor (dB)	Reading Level (dBuV)	Measure Level (dBuV/m)	Margin (dB)	Limit (dBuV/m)	Detector Type
1	*	43.923	-15.336	47.600	32.263	-7.737	40.000	QUASPEAK
2		250.300	-15.218	48.600	33.383	-12.617	46.000	QUASPEAK
3		499.163	-8.896	43.417	34.522	-11.478	46.000	QUASPEAK
4		624.300	-6.851	41.800	34.949	-11.051	46.000	QUASPEAK
5		749.990	-4.397	39.820	35.423	-10.577	46.000	QUASPEAK
6		875.312	-2.002	38.790	36.788	-9.212	46.000	QUASPEAK

Note:

1. All Readings below 1GHz are Quasi-Peak, above are performed with peak and/or average measurements as necessary.
2. " * ", means this data is the worst emission level.
3. Measurement Level = Reading Level + Correct Factor



Engineer : Fred	
Site : EMC Lab AC 102	Time : 2010/06/30 - 10:52
Limit : FCC_CLASS_B_03M_QP	Margin : 6
EUT : Wireless N FTTH Router	Probe : HL562(30-1000MHz) - HORIZONTAL
Power : AC 120V/60Hz	Note : Mode 1: Transmit by 802.11b (An0) (2462MHz)

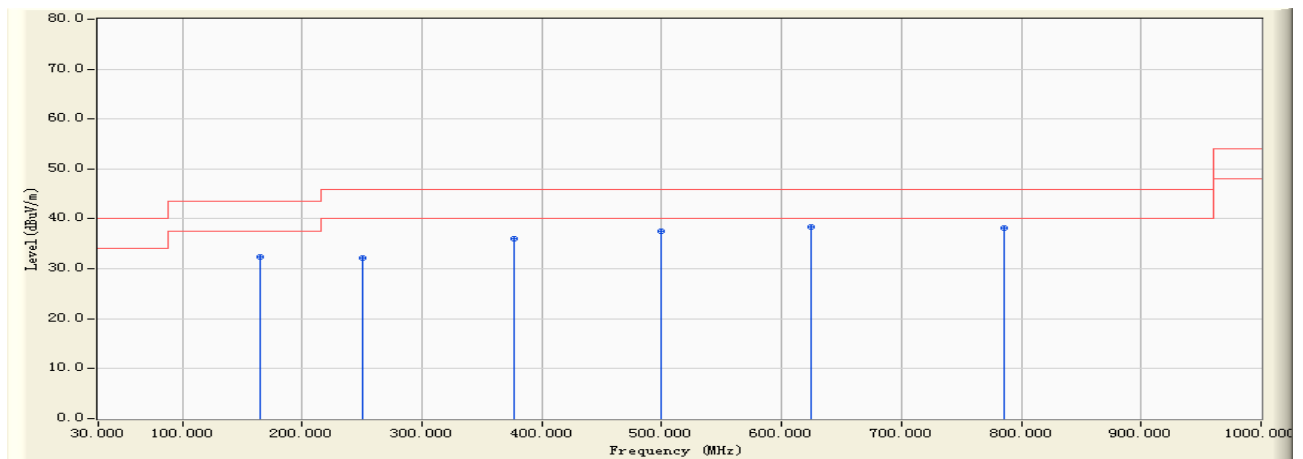

		Frequency (MHz)	Correct Factor (dB)	Reading Level (dBuV)	Measure Level (dBuV/m)	Margin (dB)	Limit (dBuV/m)	Detector Type
1		165.219	-17.724	50.030	32.306	-11.194	43.500	QUASPEAK
2		249.990	-15.238	47.360	32.122	-13.878	46.000	QUASPEAK
3		376.900	-11.279	47.300	36.022	-9.978	46.000	QUASPEAK
4		499.890	-8.878	46.312	37.435	-8.565	46.000	QUASPEAK
5	*	624.300	-6.851	45.200	38.349	-7.651	46.000	QUASPEAK
6		785.900	-3.167	41.300	38.133	-7.867	46.000	QUASPEAK

Note:

1. All Readings below 1GHz are Quasi-Peak, above are performed with peak and/or average measurements as necessary.
2. " * ", means this data is the worst emission level.
3. Measurement Level = Reading Level + Correct Factor



Engineer : Fred	
Site : EMC Lab AC 102	Time : 2010/06/30 - 10:54
Limit : FCC_CLASS_B_03M_QP	Margin : 6
EUT : Wireless N FTTH Router	Probe : HL562(30-1000MHz) - VERTICAL
Power : AC 120V/60Hz	Note : Mode 1: Transmit by 802.11b (An0) (2462MHz)

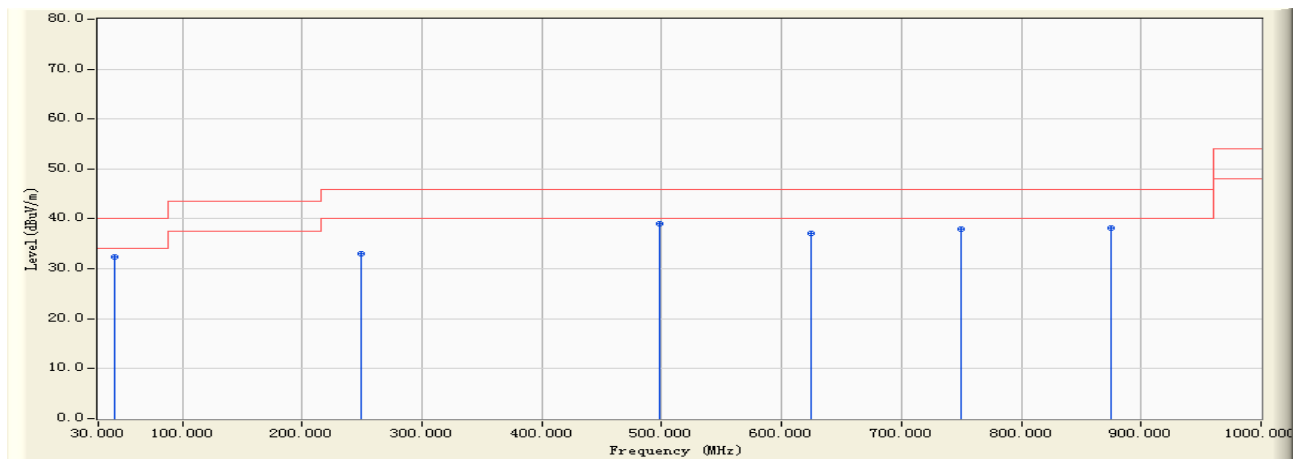

		Frequency (MHz)	Correct Factor (dB)	Reading Level (dBuV)	Measure Level (dBuV/m)	Margin (dB)	Limit (dBuV/m)	Detector Type
1		43.163	-14.902	47.310	32.408	-7.592	40.000	QUASIPeAK
2		249.182	-15.282	48.360	33.077	-12.923	46.000	QUASIPeAK
3	*	498.500	-8.915	47.900	38.984	-7.016	46.000	QUASIPeAK
4		624.990	-6.870	43.870	37.000	-9.000	46.000	QUASIPeAK
5		750.200	-4.395	42.300	37.905	-8.095	46.000	QUASIPeAK
6		875.400	-2.007	40.100	38.092	-7.908	46.000	QUASIPeAK

Note:

1. All Readings below 1GHz are Quasi-Peak, above are performed with peak and/or average measurements as necessary.
2. " * ", means this data is the worst emission level.
3. Measurement Level = Reading Level + Correct Factor



Engineer : Fred	
Site : EMC Lab AC 102	Time : 2010/06/30 - 11:00
Limit : FCC_CLASS_B_03M_QP	Margin : 6
EUT : Wireless N FTTH Router	Probe : HL562(30-1000MHz) - HORIZONTAL
Power : AC 120V/60Hz	Note : Mode 2: Transmit by 802.11g (An0) (2412MHz)

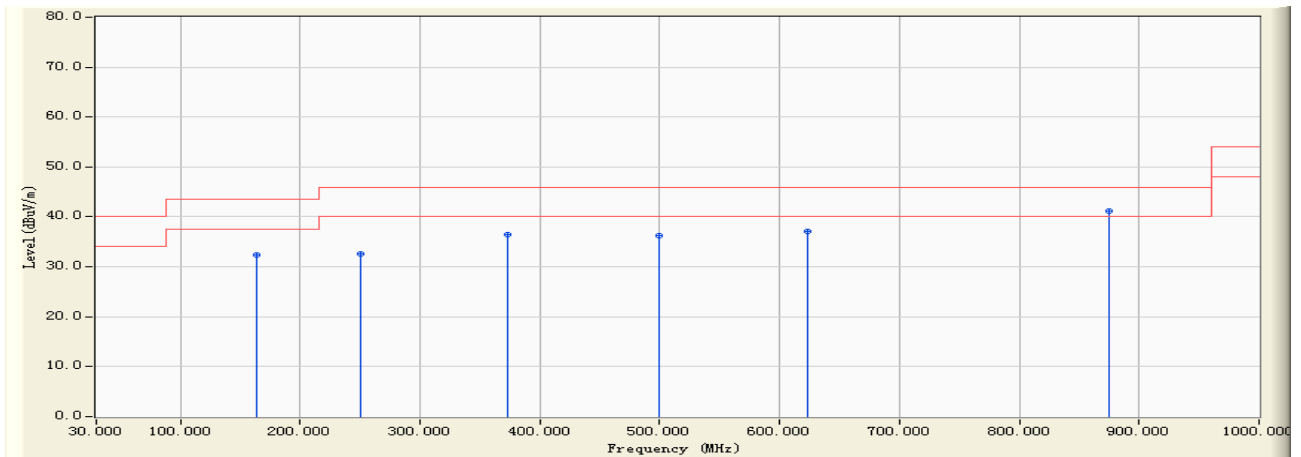

		Frequency (MHz)	Correct Factor (dB)	Reading Level (dBuV)	Measure Level (dBuV/m)	Margin (dB)	Limit (dBuV/m)	Detector Type
1		164.200	-17.782	50.100	32.317	-11.183	43.500	QUASPEAK
2		249.996	-15.238	47.910	32.672	-13.328	46.000	QUASPEAK
3		372.800	-11.288	47.800	36.512	-9.488	46.000	QUASPEAK
4		500.100	-8.873	45.200	36.328	-9.672	46.000	QUASPEAK
5		623.800	-6.841	43.900	37.059	-8.941	46.000	QUASPEAK
6	*	875.120	-1.989	43.200	41.211	-4.789	46.000	QUASPEAK

Note:

1. All Readings below 1GHz are Quasi-Peak, above are performed with peak and/or average measurements as necessary.
2. " * ", means this data is the worst emission level.
3. Measurement Level = Reading Level + Correct Factor



Engineer : Fred	
Site : EMC Lab AC 102	Time : 2010/06/30 - 11:02
Limit : FCC_CLASS_B_03M_QP	Margin : 6
EUT : Wireless N FTTH Router	Probe : HL562(30-1000MHz) - VERTICAL
Power : AC 120V/60Hz	Note : Mode 2: Transmit by 802.11g (An0) (2412MHz)

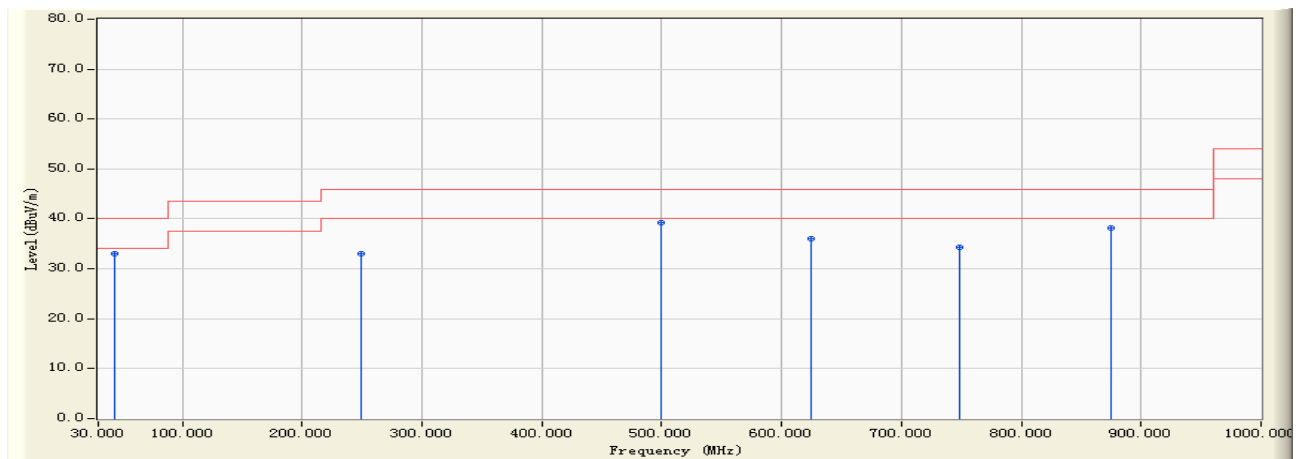

		Frequency (MHz)	Correct Factor (dB)	Reading Level (dBuV)	Measure Level (dBuV/m)	Margin (dB)	Limit (dBuV/m)	Detector Type
1		43.163	-14.902	47.900	32.998	-7.002	40.000	QUASPEAK
2		249.182	-15.282	48.370	33.087	-12.913	46.000	QUASPEAK
3	*	499.993	-8.875	48.200	39.325	-6.675	46.000	QUASPEAK
4		625.009	-6.870	42.870	36.000	-10.000	46.000	QUASPEAK
5		749.103	-4.393	38.620	34.227	-11.773	46.000	QUASPEAK
6		875.102	-1.987	40.160	38.173	-7.827	46.000	QUASPEAK

Note:

1. All Readings below 1GHz are Quasi-Peak, above are performed with peak and/or average measurements as necessary.
2. " * ", means this data is the worst emission level.
3. Measurement Level = Reading Level + Correct Factor



Engineer : Fred	
Site : EMC Lab AC 102	Time : 2010/06/30 - 11:04
Limit : FCC_CLASS_B_03M_QP	Margin : 6
EUT : Wireless N FTTH Router	Probe : HL562(30-1000MHz) - HORIZONTAL
Power : AC 120V/60Hz	Note : Mode 2: Transmit by 802.11g (An0) (2437MHz)

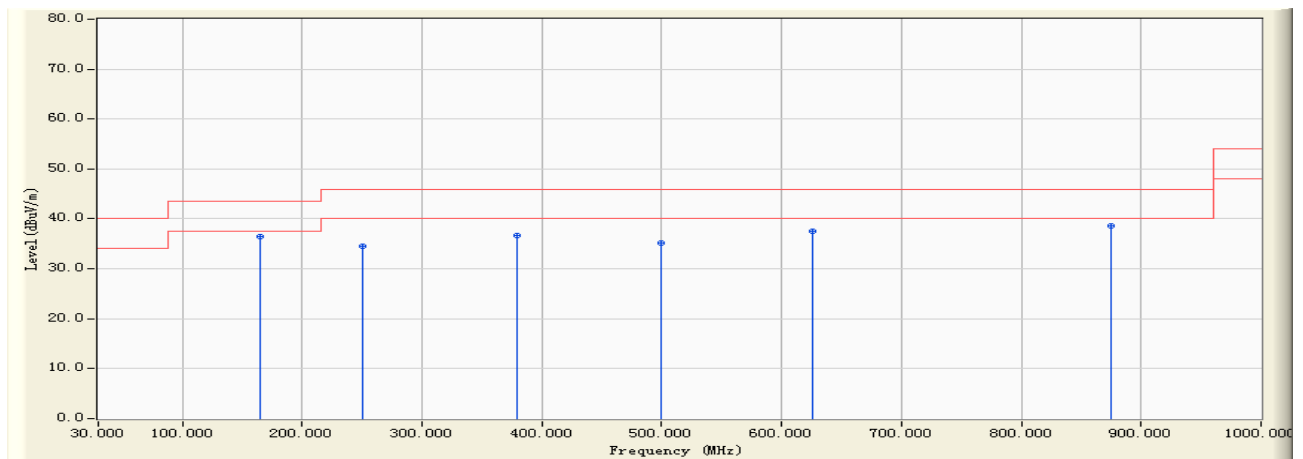

		Frequency (MHz)	Correct Factor (dB)	Reading Level (dBuV)	Measure Level (dBuV/m)	Margin (dB)	Limit (dBuV/m)	Detector Type
1	*	165.029	-17.735	54.090	36.355	-7.145	43.500	QUASPEAK
2		249.996	-15.238	49.670	34.432	-11.568	46.000	QUASPEAK
3		379.000	-11.262	47.960	36.698	-9.302	46.000	QUASPEAK
4		499.993	-8.875	44.000	35.125	-10.875	46.000	QUASPEAK
5		625.310	-6.880	44.450	37.570	-8.430	46.000	QUASPEAK
6		874.992	-1.980	40.630	38.650	-7.350	46.000	QUASPEAK

Note:

1. All Readings below 1GHz are Quasi-Peak, above are performed with peak and/or average measurements as necessary.
2. " * ", means this data is the worst emission level.
3. Measurement Level = Reading Level + Correct Factor



Engineer : Fred	
Site : EMC Lab AC 102	Time : 2010/06/30 - 11:06
Limit : FCC_CLASS_B_03M_QP	Margin : 6
EUT : Wireless N FTTH Router	Probe : HL562(30-1000MHz) - VERTICAL
Power : AC 120V/60Hz	Note : Mode 2: Transmit by 802.11g (An0) (2437MHz)

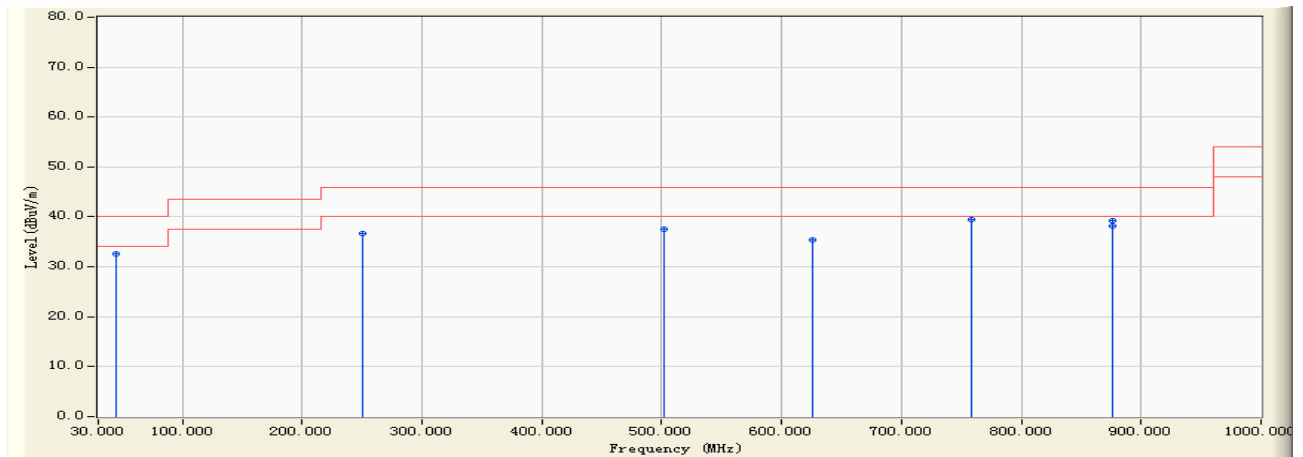

		Frequency (MHz)	Correct Factor (dB)	Reading Level (dBuV)	Measure Level (dBuV/m)	Margin (dB)	Limit (dBuV/m)	Detector Type
1		44.600	-15.729	48.300	32.571	-7.429	40.000	QUASPEAK
2		249.922	-15.244	51.970	36.727	-9.273	46.000	QUASPEAK
3		501.600	-8.838	46.300	37.462	-8.538	46.000	QUASPEAK
4		625.371	-6.882	42.173	35.291	-10.709	46.000	QUASPEAK
5	*	758.660	-4.109	43.600	39.491	-6.509	46.000	QUASPEAK
6		876.300	-2.061	40.300	38.240	-7.760	46.000	QUASPEAK

Note:

1. All Readings below 1GHz are Quasi-Peak, above are performed with peak and/or average measurements as necessary.
2. " * ", means this data is the worst emission level.
3. Measurement Level = Reading Level + Correct Factor



Engineer : Fred	
Site : EMC Lab AC 102	Time : 2010/06/30 - 11:10
Limit : FCC_CLASS_B_03M_QP	Margin : 6
EUT : Wireless N FTTH Router	Probe : HL562(30-1000MHz) - HORIZONTAL
Power : AC 120V/60Hz	Note : Mode 2: Transmit by 802.11g (An0) (2462MHz)

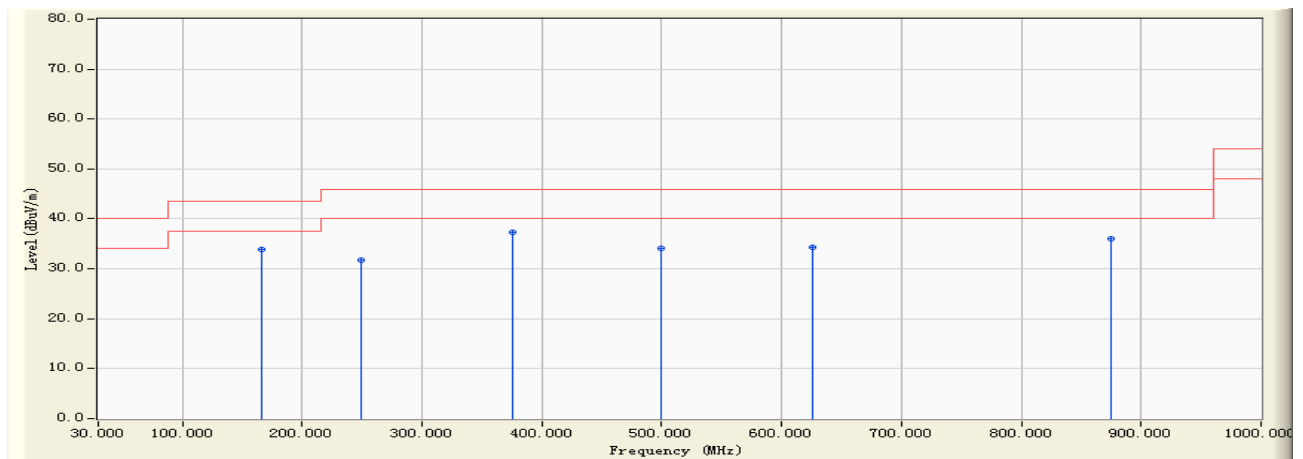

		Frequency (MHz)	Correct Factor (dB)	Reading Level (dBuV)	Measure Level (dBuV/m)	Margin (dB)	Limit (dBuV/m)	Detector Type
1		166.009	-17.679	51.480	33.802	-9.698	43.500	QUASPEAK
2		249.360	-15.274	46.972	31.698	-14.302	46.000	QUASPEAK
3	*	375.600	-11.287	48.600	37.313	-8.687	46.000	QUASPEAK
4		499.992	-8.875	42.900	34.025	-11.975	46.000	QUASPEAK
5		626.300	-6.903	41.300	34.397	-11.603	46.000	QUASPEAK
6		874.328	-1.923	38.030	36.107	-9.893	46.000	QUASPEAK

Note:

1. All Readings below 1GHz are Quasi-Peak, above are performed with peak and/or average measurements as necessary.
2. " * ", means this data is the worst emission level.
3. Measurement Level = Reading Level + Correct Factor



Engineer : Fred	
Site : EMC Lab AC 102	Time : 2010/06/30 - 11:12
Limit : FCC_CLASS_B_03M_QP	Margin : 6
EUT : Wireless N FTTH Router	Probe : HL562(30-1000MHz) - VERTICAL
Power : AC 120V/60Hz	Note : Mode 2: Transmit by 802.11g (An0) (2462MHz)

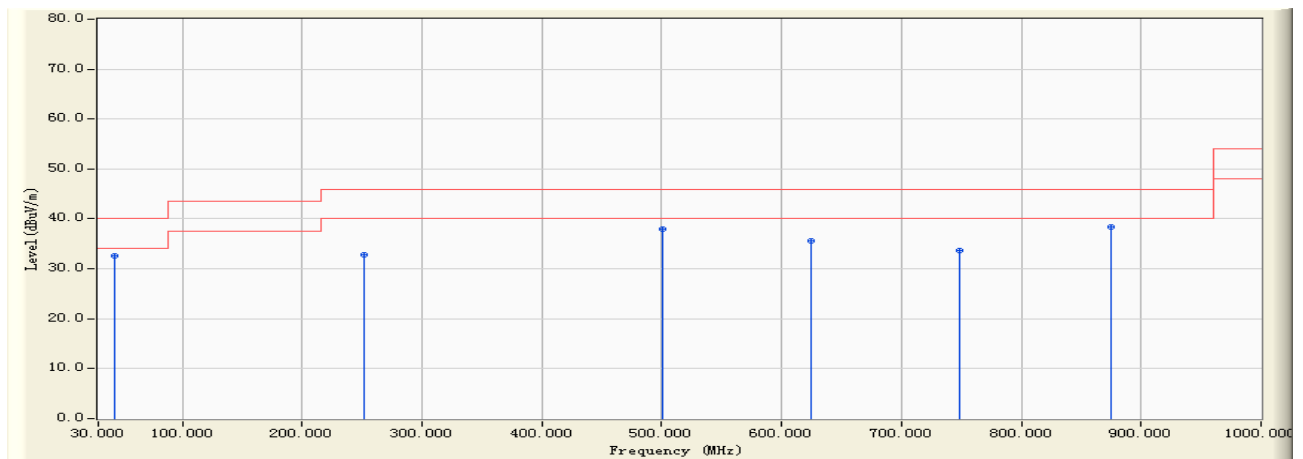

		Frequency (MHz)	Correct Factor (dB)	Reading Level (dBuV)	Measure Level (dBuV/m)	Margin (dB)	Limit (dBuV/m)	Detector Type
1	*	43.260	-14.957	47.600	32.643	-7.357	40.000	QUASPEAK
2		251.300	-15.148	47.990	32.842	-13.158	46.000	QUASPEAK
3		500.300	-8.868	46.900	38.032	-7.968	46.000	QUASPEAK
4		625.119	-6.873	42.370	35.496	-10.504	46.000	QUASPEAK
5		749.103	-4.393	38.160	33.767	-12.233	46.000	QUASPEAK
6		875.112	-1.987	40.310	38.322	-7.678	46.000	QUASPEAK

Note:

1. All Readings below 1GHz are Quasi-Peak, above are performed with peak and/or average measurements as necessary.
2. " * ", means this data is the worst emission level.
3. Measurement Level = Reading Level + Correct Factor



Engineer : Fred	
Site : EMC Lab AC 102	Time : 2010/06/30 - 11:20
Limit : FCC_CLASS_B_03M_QP	Margin : 6
EUT : Wireless N FTTH Router	Probe : HL562(30-1000MHz) - HORIZONTAL
Power : AC 120V/60Hz	Note : Mode 3: Transmit by 802.11n (20MHz) (An0 and An1) (2412MHz)

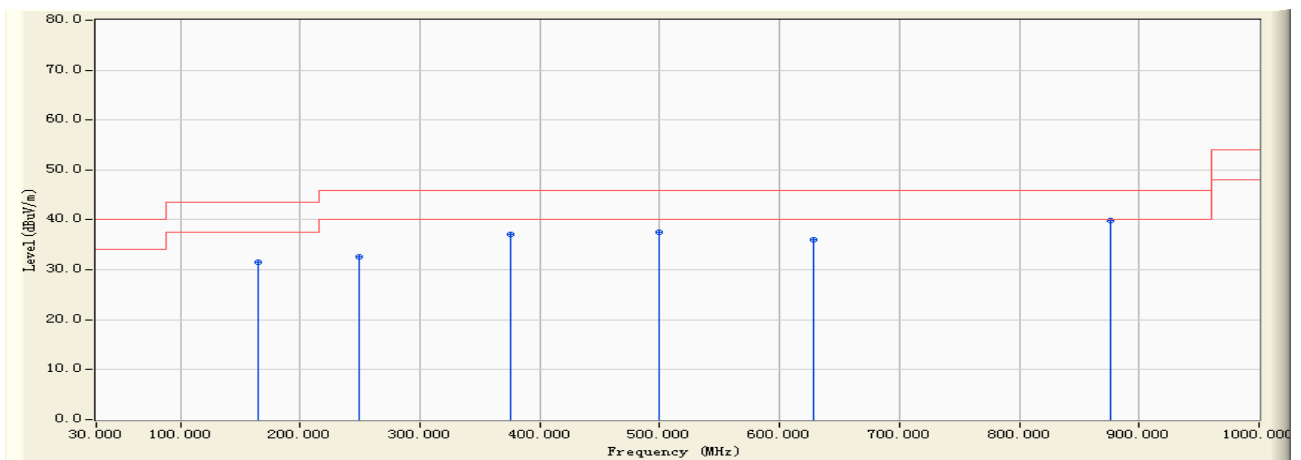

		Frequency (MHz)	Correct Factor (dB)	Reading Level (dBuV)	Measure Level (dBuV/m)	Margin (dB)	Limit (dBuV/m)	Detector Type
1		165.129	-17.729	49.360	31.631	-11.869	43.500	QUASPEAK
2		248.700	-15.302	47.800	32.497	-13.503	46.000	QUASPEAK
3		375.161	-11.290	48.360	37.071	-8.929	46.000	QUASPEAK
4		500.120	-8.871	46.300	37.428	-8.572	46.000	QUASPEAK
5		627.800	-6.926	43.000	36.074	-9.926	46.000	QUASPEAK
6	*	876.580	-2.074	41.900	39.826	-6.174	46.000	QUASPEAK

Note:

1. All Readings below 1GHz are Quasi-Peak, above are performed with peak and/or average measurements as necessary.
2. " * ", means this data is the worst emission level.
3. Measurement Level = Reading Level + Correct Factor



Engineer : Fred	
Site : EMC Lab AC 102	Time : 2010/06/30 - 11:23
Limit : FCC_CLASS_B_03M_QP	Margin : 6
EUT : Wireless N FTTH Router	Probe : HL562(30-1000MHz) - VERTICAL
Power : AC 120V/60Hz	Note : Mode 3: Transmit by 802.11n (20MHz) (An0 and An1) (2412MHz)

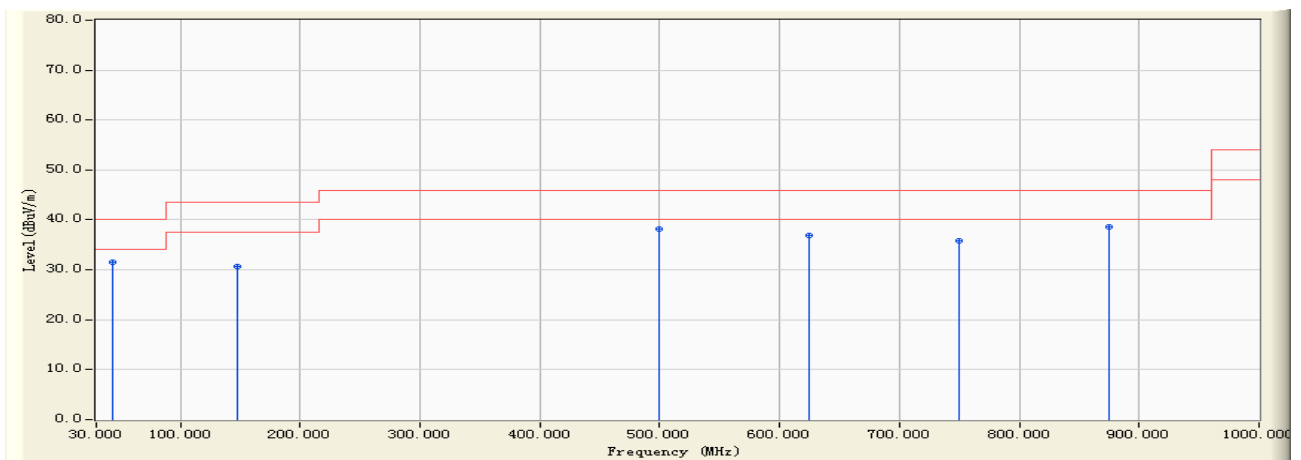

		Frequency (MHz)	Correct Factor (dB)	Reading Level (dBuV)	Measure Level (dBuV/m)	Margin (dB)	Limit (dBuV/m)	Detector Type
1		43.800	-15.267	46.700	31.434	-8.566	40.000	QUASPEAK
2		148.300	-17.880	48.500	30.619	-12.881	43.500	QUASPEAK
3		499.199	-8.894	47.090	38.196	-7.804	46.000	QUASPEAK
4		624.700	-6.861	43.800	36.940	-9.060	46.000	QUASPEAK
5		749.360	-4.396	40.260	35.864	-10.136	46.000	QUASPEAK
6	*	874.800	-1.965	40.500	38.535	-7.465	46.000	QUASPEAK

Note:

1. All Readings below 1GHz are Quasi-Peak, above are performed with peak and/or average measurements as necessary.
2. " * ", means this data is the worst emission level.
3. Measurement Level = Reading Level + Correct Factor



Engineer : Fred	
Site : EMC Lab AC 102	Time : 2010/06/30 - 11:25
Limit : FCC_CLASS_B_03M_QP	Margin : 6
EUT : Wireless N FTTH Router	Probe : HL562(30-1000MHz) - HORIZONTAL
Power : AC 120V/60Hz	Note : Mode 3: Transmit by 802.11n (20MHz) (An0 and An1) (2437MHz)

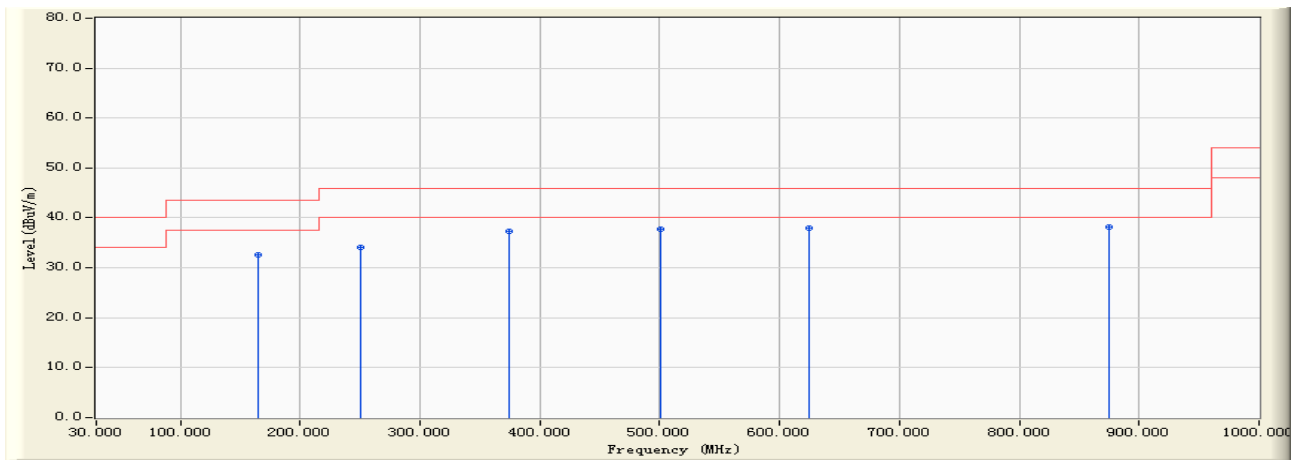

		Frequency (MHz)	Correct Factor (dB)	Reading Level (dBuV)	Measure Level (dBuV/m)	Margin (dB)	Limit (dBuV/m)	Detector Type
1		165.329	-17.718	50.230	32.512	-10.988	43.500	QUASPEAK
2		249.930	-15.242	49.310	34.068	-11.932	46.000	QUASPEAK
3		374.800	-11.291	48.600	37.308	-8.692	46.000	QUASPEAK
4		500.200	-8.870	46.700	37.830	-8.170	46.000	QUASPEAK
5		624.700	-6.861	44.900	38.040	-7.960	46.000	QUASPEAK
6	*	874.600	-1.947	40.017	38.070	-7.930	46.000	QUASPEAK

Note:

1. All Readings below 1GHz are Quasi-Peak, above are performed with peak and/or average measurements as necessary.
2. " * ", means this data is the worst emission level.
3. Measurement Level = Reading Level + Correct Factor



Engineer : Fred	
Site : EMC Lab AC 102	Time : 2010/06/30 - 11:27
Limit : FCC_CLASS_B_03M_QP	Margin : 6
EUT : Wireless N FTTH Router	Probe : HL562(30-1000MHz) - VERTICAL
Power : AC 120V/60Hz	Note : Mode 3: Transmit by 802.11n (20MHz) (An0 and An1) (2437MHz)

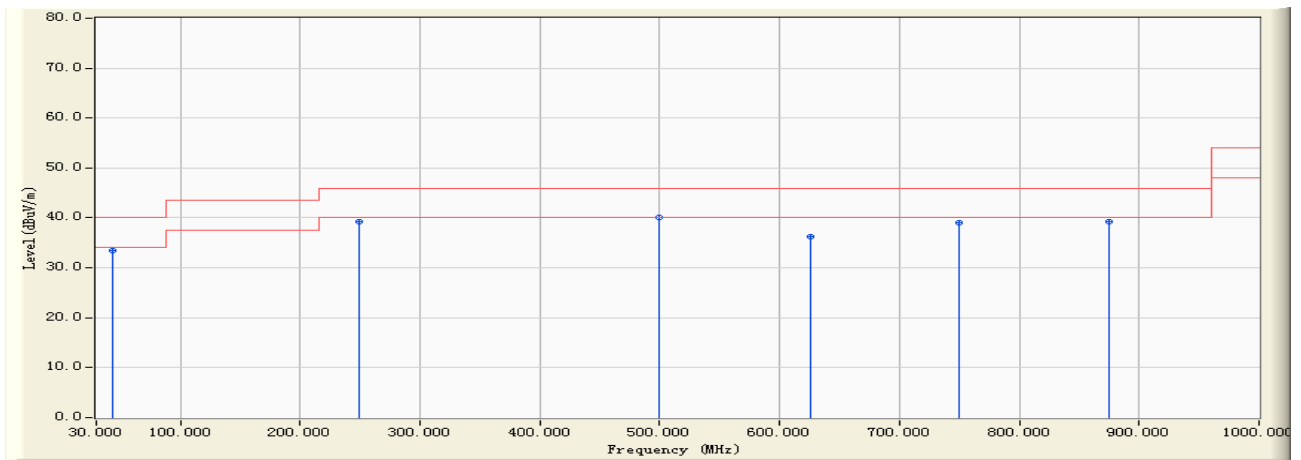

		Frequency (MHz)	Correct Factor (dB)	Reading Level (dBuV)	Measure Level (dBuV/m)	Margin (dB)	Limit (dBuV/m)	Detector Type
1		43.263	-14.959	48.360	33.401	-6.599	40.000	QUASPEAK
2		249.350	-15.275	54.460	39.185	-6.815	46.000	QUASPEAK
3	*	500.060	-8.873	49.010	40.137	-5.863	46.000	QUASPEAK
4		625.390	-6.882	43.180	36.298	-9.702	46.000	QUASPEAK
5		749.360	-4.396	43.462	39.066	-6.934	46.000	QUASPEAK
6		875.310	-2.002	41.260	39.258	-6.742	46.000	QUASPEAK

Note:

1. All Readings below 1GHz are Quasi-Peak, above are performed with peak and/or average measurements as necessary.
2. " * ", means this data is the worst emission level.
3. Measurement Level = Reading Level + Correct Factor



Engineer : Fred	
Site : EMC Lab AC 102	Time : 2010/06/30 - 11:32
Limit : FCC_CLASS_B_03M_QP	Margin : 6
EUT : Wireless N FTTH Router	Probe : HL562(30-1000MHz) - HORIZONTAL
Power : AC 120V/60Hz	Note : Mode 3: Transmit by 802.11n (20MHz) (An0 and An1) (2462MHz)

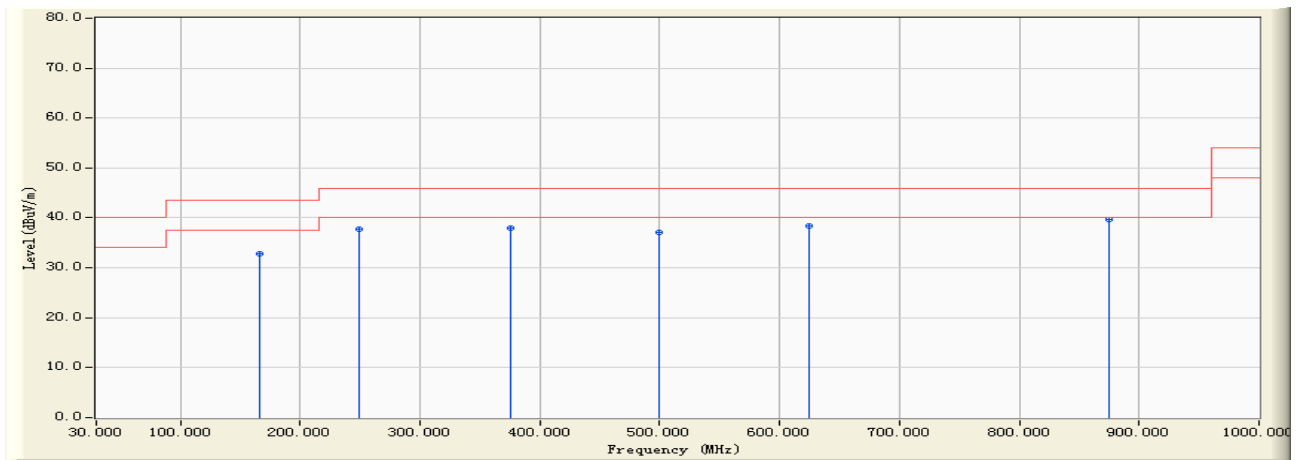

		Frequency (MHz)	Correct Factor (dB)	Reading Level (dBuV)	Measure Level (dBuV/m)	Margin (dB)	Limit (dBuV/m)	Detector Type
1		166.360	-17.658	50.370	32.712	-10.788	43.500	QUASPEAK
2		249.132	-15.285	52.990	37.705	-8.295	46.000	QUASPEAK
3		375.131	-11.290	49.238	37.948	-8.052	46.000	QUASPEAK
4		500.030	-8.874	45.980	37.106	-8.894	46.000	QUASPEAK
5		625.191	-6.876	45.220	38.344	-7.656	46.000	QUASPEAK
6	*	875.360	-2.005	41.790	39.785	-6.215	46.000	QUASPEAK

Note:

1. All Readings below 1GHz are Quasi-Peak, above are performed with peak and/or average measurements as necessary.
2. " * ", means this data is the worst emission level.
3. Measurement Level = Reading Level + Correct Factor



Engineer : Fred	
Site : EMC Lab AC 102	Time : 2010/06/30 - 11:40
Limit : FCC_CLASS_B_03M_QP	Margin : 6
EUT : Wireless N FTTH Router	Probe : HL562(30-1000MHz) - VERTICAL
Power : AC 120V/60Hz	Note : Mode 3: Transmit by 802.11n (20MHz) (An0 and An1) (2462MHz)

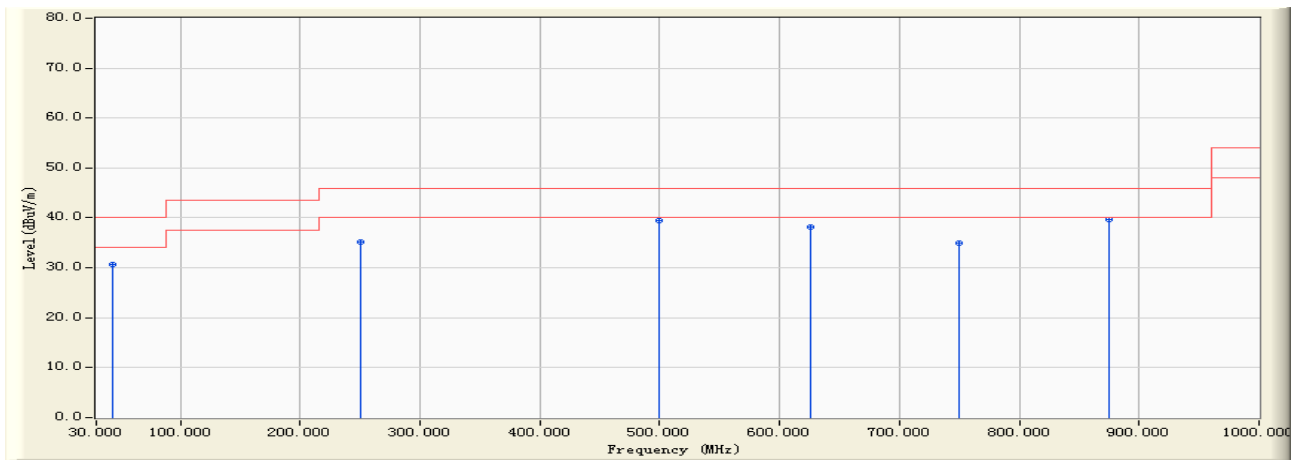

		Frequency (MHz)	Correct Factor (dB)	Reading Level (dBuV)	Measure Level (dBuV/m)	Margin (dB)	Limit (dBuV/m)	Detector Type
1		43.163	-14.902	45.500	30.598	-9.402	40.000	QUASPEAK
2		250.310	-15.217	50.370	35.153	-10.847	46.000	QUASPEAK
3		500.006	-8.875	48.390	39.515	-6.485	46.000	QUASPEAK
4		625.311	-6.880	44.990	38.110	-7.890	46.000	QUASPEAK
5		750.060	-4.397	39.260	34.863	-11.137	46.000	QUASPEAK
6	*	875.112	-1.987	41.610	39.622	-6.378	46.000	QUASPEAK

Note:

1. All Readings below 1GHz are Quasi-Peak, above are performed with peak and/or average measurements as necessary.
2. " * ", means this data is the worst emission level.
3. Measurement Level = Reading Level + Correct Factor



Engineer : Fred	
Site : EMC Lab AC 102	Time : 2010/06/30 - 11:42
Limit : FCC_CLASS_B_03M_QP	Margin : 6
EUT : Wireless N FTTH Router	Probe : HL562(30-1000MHz) - HORIZONTAL
Power : AC 120V/60Hz	Note : Mode 4: Transmit by 802.11n (40MHz) (An0 and An1) (2422MHz)

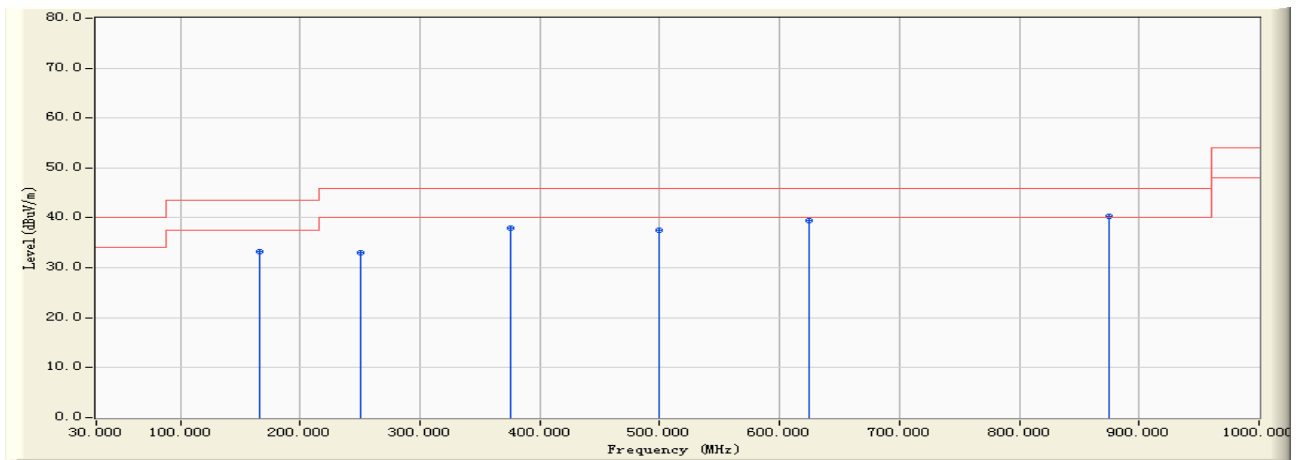

		Frequency (MHz)	Correct Factor (dB)	Reading Level (dBuV)	Measure Level (dBuV/m)	Margin (dB)	Limit (dBuV/m)	Detector Type
1		166.326	-17.661	50.850	33.190	-10.310	43.500	QUASPEAK
2		250.160	-15.227	48.310	33.083	-12.917	46.000	QUASPEAK
3		375.840	-11.285	49.320	38.035	-7.965	46.000	QUASPEAK
4		499.992	-8.875	46.500	37.625	-8.375	46.000	QUASPEAK
5		625.130	-6.874	46.250	39.376	-6.624	46.000	QUASPEAK
6	*	875.320	-2.002	42.390	40.388	-5.612	46.000	QUASPEAK

Note:

1. All Readings below 1GHz are Quasi-Peak, above are performed with peak and/or average measurements as necessary.
2. " * ", means this data is the worst emission level.
3. Measurement Level = Reading Level + Correct Factor



Engineer : Fred	
Site : EMC Lab AC 102	Time : 2010/06/30 - 11:44
Limit : FCC_CLASS_B_03M_QP	Margin : 6
EUT : Wireless N FTTH Router	Probe : HL562(30-1000MHz) - VERTICAL
Power : AC 120V/60Hz	Note : Mode 4: Transmit by 802.11n (40MHz) (An0 and An1) (2422MHz)

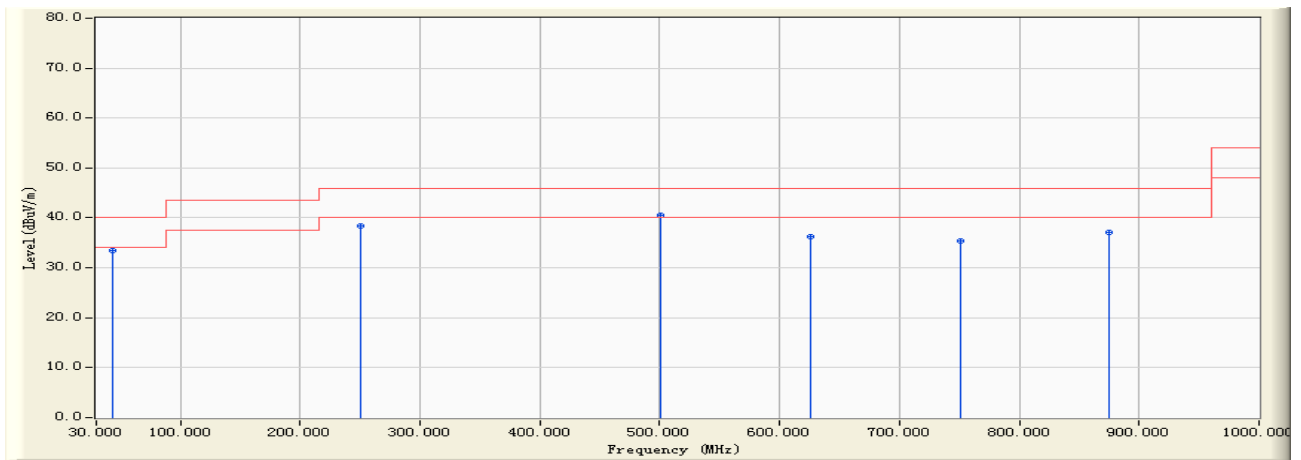

		Frequency (MHz)	Correct Factor (dB)	Reading Level (dBuV)	Measure Level (dBuV/m)	Margin (dB)	Limit (dBuV/m)	Detector Type
1		43.163	-14.902	48.360	33.458	-6.542	40.000	QUASPEAK
2		249.992	-15.238	53.560	38.322	-7.678	46.000	QUASPEAK
3	*	500.320	-8.867	49.310	40.443	-5.557	46.000	QUASPEAK
4		625.370	-6.882	43.180	36.299	-9.701	46.000	QUASPEAK
5		750.980	-4.390	39.870	35.480	-10.520	46.000	QUASPEAK
6		875.112	-1.987	39.030	37.042	-8.958	46.000	QUASPEAK

Note:

1. All Readings below 1GHz are Quasi-Peak, above are performed with peak and/or average measurements as necessary.
2. " * ", means this data is the worst emission level.
3. Measurement Level = Reading Level + Correct Factor



Engineer : Fred	
Site : EMC Lab AC 102	Time : 2010/06/30 - 11:46
Limit : FCC_CLASS_B_03M_QP	Margin : 6
EUT : Wireless N FTTH Router	Probe : HL562(30-1000MHz) - HORIZONTAL
Power : AC 120V/60Hz	Note : Mode 4: Transmit by 802.11n (40MHz) (An0 and An1) (2437MHz)

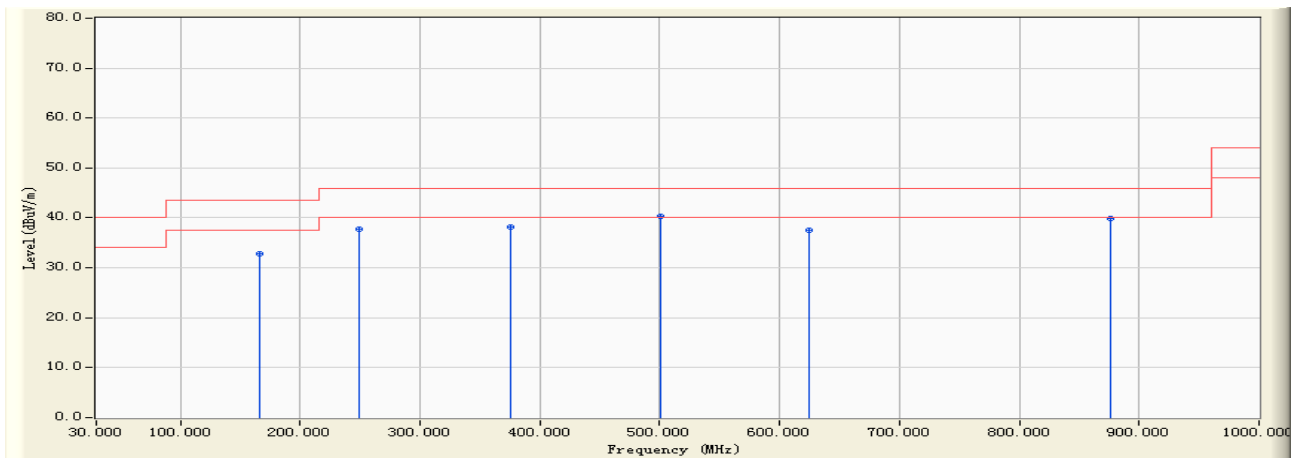

		Frequency (MHz)	Correct Factor (dB)	Reading Level (dBuV)	Measure Level (dBuV/m)	Margin (dB)	Limit (dBuV/m)	Detector Type
1		166.360	-17.658	50.390	32.732	-10.768	43.500	QUASPEAK
2		249.182	-15.282	52.970	37.687	-8.313	46.000	QUASPEAK
3		375.390	-11.288	49.360	38.072	-7.928	46.000	QUASPEAK
4	*	500.360	-8.866	49.140	40.274	-5.726	46.000	QUASPEAK
5		625.191	-6.876	44.470	37.594	-8.406	46.000	QUASPEAK
6		876.310	-2.061	41.960	39.899	-6.101	46.000	QUASPEAK

Note:

1. All Readings below 1GHz are Quasi-Peak, above are performed with peak and/or average measurements as necessary.
2. " * ", means this data is the worst emission level.
3. Measurement Level = Reading Level + Correct Factor



Engineer : Fred	
Site : EMC Lab AC 102	Time : 2010/06/30 - 11:49
Limit : FCC_CLASS_B_03M_QP	Margin : 6
EUT : Wireless N FTTH Router	Probe : HL562(30-1000MHz) - VERTICAL
Power : AC 120V/60Hz	Note : Mode 4: Transmit by 802.11n (40MHz) (An0 and An1) (2437MHz)

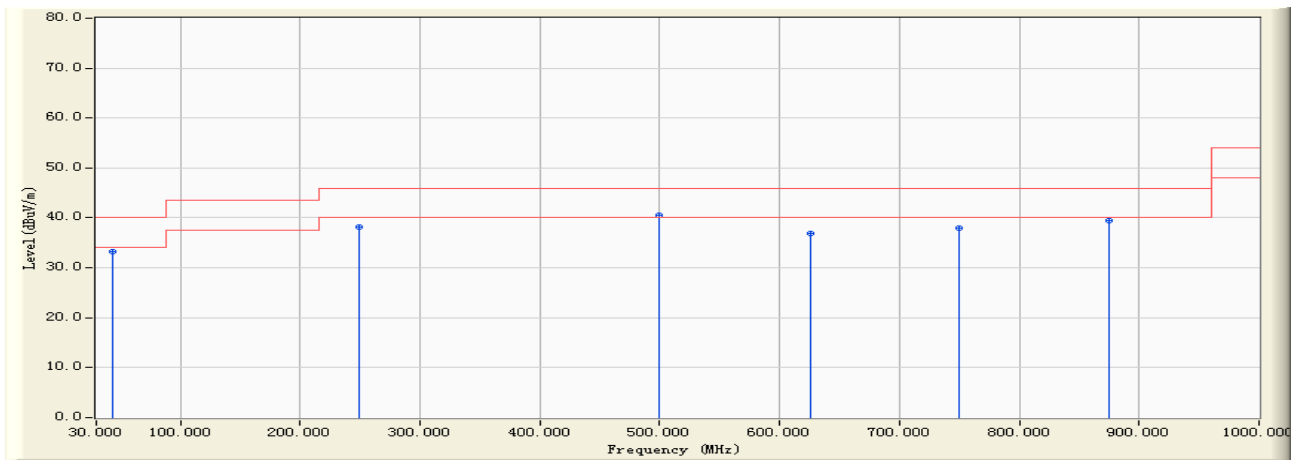

		Frequency (MHz)	Correct Factor (dB)	Reading Level (dBuV)	Measure Level (dBuV/m)	Margin (dB)	Limit (dBuV/m)	Detector Type
1		43.563	-15.130	48.390	33.261	-6.739	40.000	QUASPEAK
2		249.360	-15.274	53.460	38.186	-7.814	46.000	QUASPEAK
3	*	500.003	-8.875	49.310	40.435	-5.565	46.000	QUASPEAK
4		625.370	-6.882	43.860	36.979	-9.021	46.000	QUASPEAK
5		749.363	-4.396	42.320	37.924	-8.076	46.000	QUASPEAK
6		875.340	-2.004	41.390	39.386	-6.614	46.000	QUASPEAK

Note:

1. All Readings below 1GHz are Quasi-Peak, above are performed with peak and/or average measurements as necessary.
2. " * ", means this data is the worst emission level.
3. Measurement Level = Reading Level + Correct Factor



Engineer : Fred	
Site : EMC Lab AC 102	Time : 2010/06/30 - 11:51
Limit : FCC_CLASS_B_03M_QP	Margin : 6
EUT : Wireless N FTTH Router	Probe : HL562(30-1000MHz) - HORIZONTAL
Power : AC 120V/60Hz	Note : Mode 4: Transmit by 802.11n (40MHz) (An0 and An1) (2452MHz)

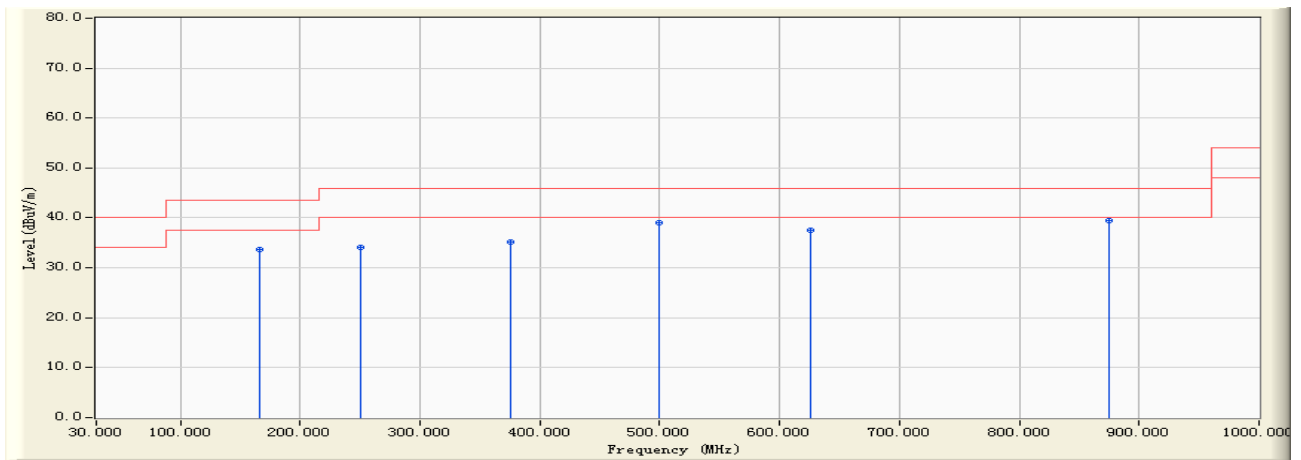

		Frequency (MHz)	Correct Factor (dB)	Reading Level (dBuV)	Measure Level (dBuV/m)	Margin (dB)	Limit (dBuV/m)	Detector Type
1		166.320	-17.661	51.320	33.660	-9.840	43.500	QUASPEAK
2		250.310	-15.217	49.320	34.103	-11.897	46.000	QUASPEAK
3		375.310	-11.289	46.538	35.249	-10.751	46.000	QUASPEAK
4		499.993	-8.875	48.000	39.125	-6.875	46.000	QUASPEAK
5		625.390	-6.882	44.360	37.478	-8.522	46.000	QUASPEAK
6	*	875.310	-2.002	41.560	39.558	-6.442	46.000	QUASPEAK

Note:

1. All Readings below 1GHz are Quasi-Peak, above are performed with peak and/or average measurements as necessary.
2. " * ", means this data is the worst emission level.
3. Measurement Level = Reading Level + Correct Factor



Engineer : Fred	
Site : EMC Lab AC 102	Time : 2010/06/30 - 11:52
Limit : FCC_CLASS_B_03M_QP	Margin : 6
EUT : Wireless N FTTH Router	Probe : HL562(30-1000MHz) - VERTICAL
Power : AC 120V/60Hz	Note : Mode 4: Transmit by 802.11n (40MHz) (An0 and An1) (2452MHz)

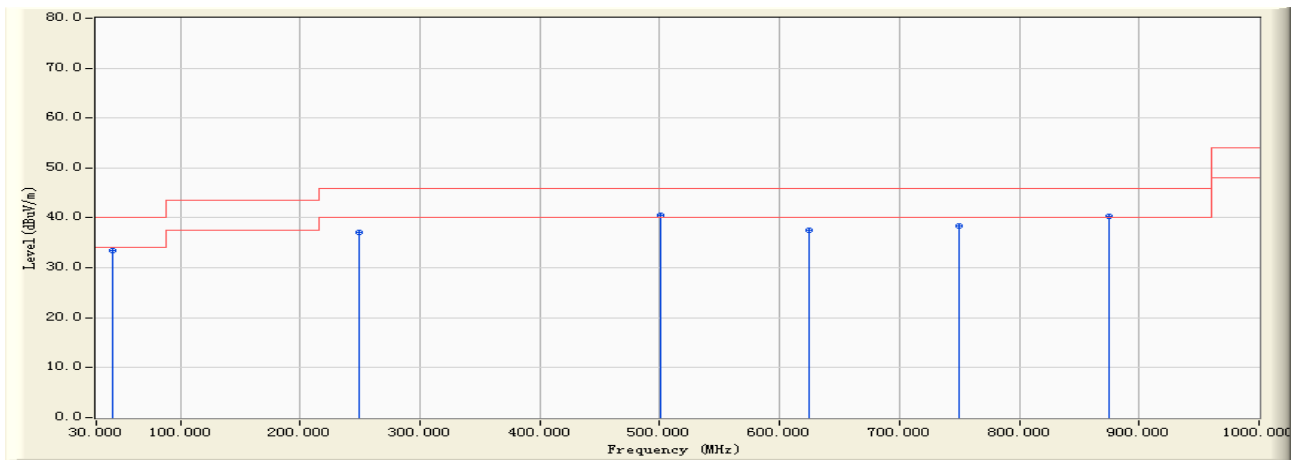

		Frequency (MHz)	Correct Factor (dB)	Reading Level (dBuV)	Measure Level (dBuV/m)	Margin (dB)	Limit (dBuV/m)	Detector Type
1		43.153	-14.896	48.390	33.494	-6.506	40.000	QUASPEAK
2		249.362	-15.274	52.470	37.196	-8.804	46.000	QUASPEAK
3	*	500.289	-8.868	49.360	40.492	-5.508	46.000	QUASPEAK
4		625.131	-6.874	44.470	37.596	-8.404	46.000	QUASPEAK
5		749.360	-4.396	42.870	38.474	-7.526	46.000	QUASPEAK
6		875.320	-2.002	42.310	40.308	-5.692	46.000	QUASPEAK

Note:

1. All Readings below 1GHz are Quasi-Peak, above are performed with peak and/or average measurements as necessary.
2. " * ", means this data is the worst emission level.
3. Measurement Level = Reading Level + Correct Factor



Above 1G:

Engineer : Fred	
Site : EMC Lab AC 102	Time : 2010/06/29 - 17:35
Limit : FCC_15_03M_PK	Margin : 6
EUT : Wireless N FTTH Router	Probe : BBHA9120D(1-18GHz) - HORIZONTAL
Power : AC 120V/60Hz	Note : Mode 1: Transmit by 802.11b (An0) (2412MHz)

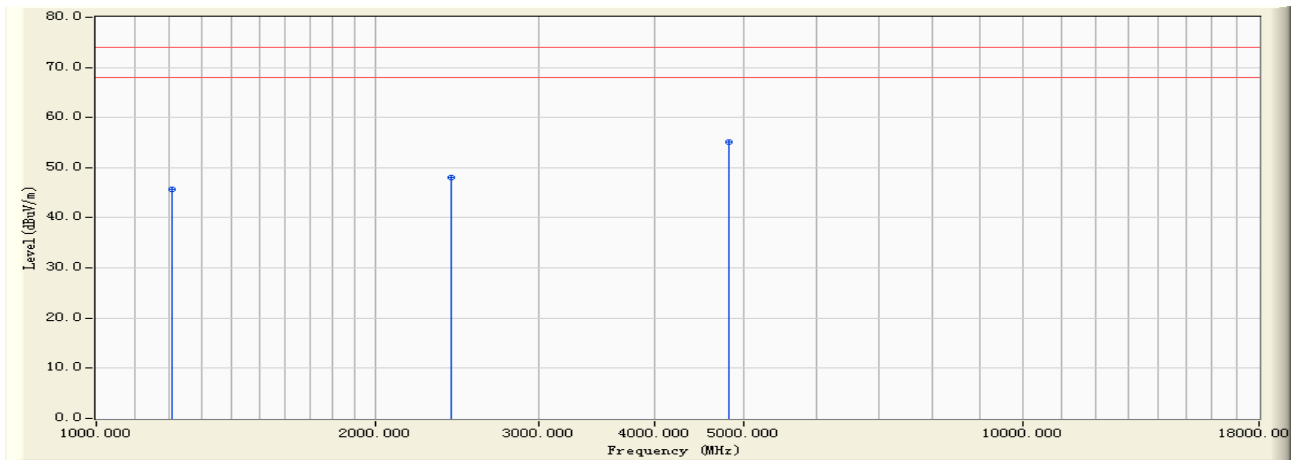

		Frequency (MHz)	Correct Factor (dB)	Reading Level (dBUV)	Measure Level (dBUV/m)	Margin (dB)	Limit (dBUV/m)	Detector Type
1		1206.500	-5.893	51.507	45.614	-28.386	74.000	PEAK
2		2412.300	0.429	47.531	47.961	-26.039	74.000	PEAK
3	*	4825.600	7.351	47.718	55.069	-18.931	74.000	PEAK

Note:

1. All Readings below 1GHz are Quasi-Peak, above are performed with peak and/or average measurements as necessary.
2. " * ", means this data is the worst emission level.
3. Measurement Level = Reading Level + Correct Factor



Engineer : Fred	
Site : EMC Lab AC 102	Time : 2010/06/29 - 17:35
Limit : FCC_15_03M_AV	Margin : 6
EUT : Wireless N FTTH Router	Probe : BBHA9120D(1-18GHz) - HORIZONTAL
Power : AC 120V/60Hz	Note : Mode 1: Transmit by 802.11b (An0) (2412MHz)

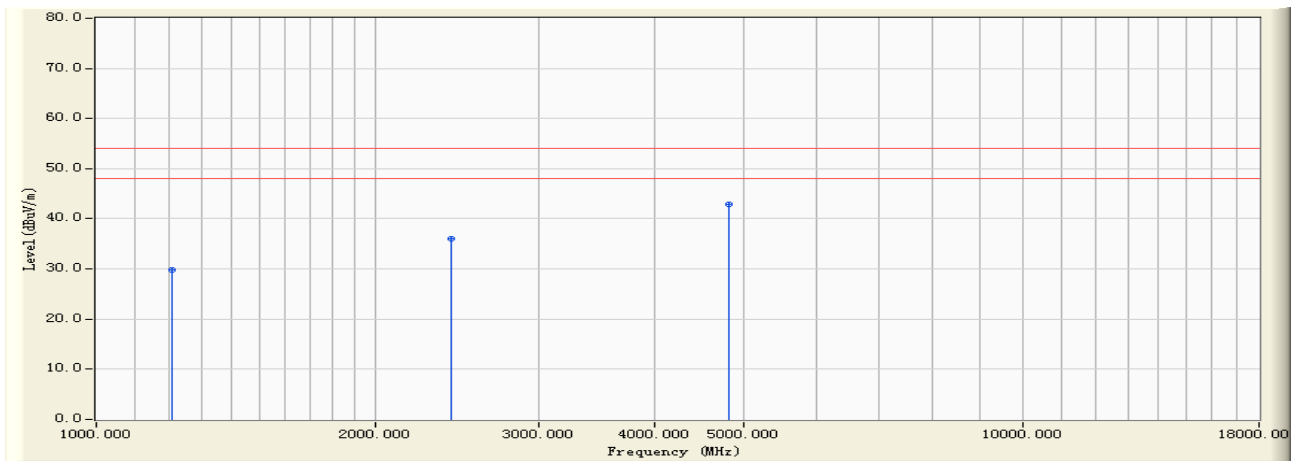

		Frequency (MHz)	Correct Factor (dB)	Reading Level (dBuV)	Measure Level (dBuV/m)	Margin (dB)	Limit (dBuV/m)	Detector Type
1		1206.500	-5.893	35.600	29.707	-24.293	54.000	AVERAGE
2		2412.300	0.429	35.600	36.030	-17.970	54.000	AVERAGE
3	*	4825.600	7.351	35.500	42.851	-11.149	54.000	AVERAGE

Note:

1. All Readings below 1GHz are Quasi-Peak, above are performed with peak and/or average measurements as necessary.
2. " * ", means this data is the worst emission level.
3. Measurement Level = Reading Level + Correct Factor



Engineer : Fred	
Site : EMC Lab AC 102	Time : 2010/06/29 - 17:36
Limit : FCC_15_03M_PK	Margin : 6
EUT : Wireless N FTTH Router	Probe : BBHA9120D(1-18GHz) - VERTICAL
Power : AC 120V/60Hz	Note : Mode 1: Transmit by 802.11b (An0) (2412MHz)

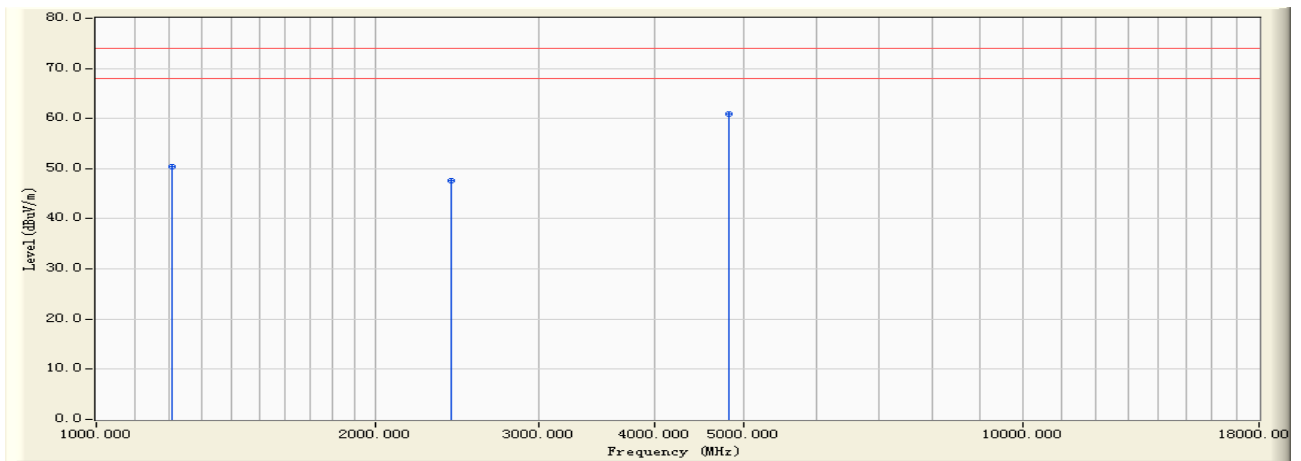

		Frequency (MHz)	Correct Factor (dB)	Reading Level (dBuV)	Measure Level (dBuV/m)	Margin (dB)	Limit (dBuV/m)	Detector Type
1		1205.390	-5.904	56.200	50.296	-23.704	74.000	PEAK
2		2413.560	0.434	47.242	47.676	-26.324	74.000	PEAK
3	*	4824.350	7.348	53.480	60.828	-13.172	74.000	PEAK

Note:

1. All Readings below 1GHz are Quasi-Peak, above are performed with peak and/or average measurements as necessary.
2. " * ", means this data is the worst emission level.
3. Measurement Level = Reading Level + Correct Factor



Engineer : Fred	
Site : EMC Lab AC 102	Time : 2010/06/29 - 17:36
Limit : FCC_15_03M_AV	Margin : 6
EUT : Wireless N FTTH Router	Probe : BBHA9120D(1-18GHz) - VERTICAL
Power : AC 120V/60Hz	Note : Mode 1: Transmit by 802.11b (An0) (2412MHz)

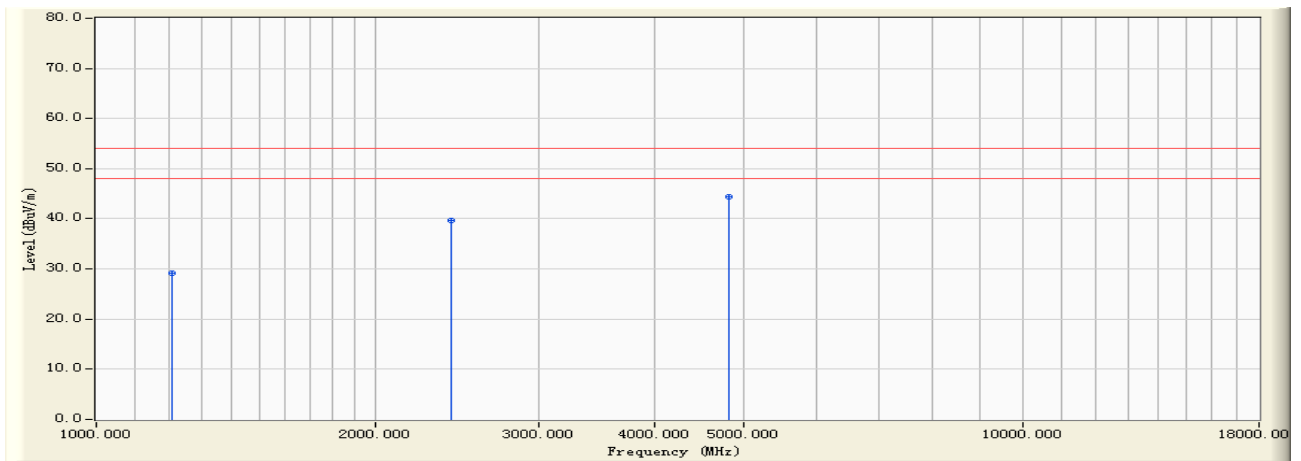

		Frequency (MHz)	Correct Factor (dB)	Reading Level (dBuV)	Measure Level (dBuV/m)	Margin (dB)	Limit (dBuV/m)	Detector Type
1		1205.390	-5.904	35.040	29.136	-24.864	54.000	AVERAGE
2		2413.560	0.434	39.210	39.644	-14.356	54.000	AVERAGE
3	*	4824.350	7.348	37.000	44.348	-9.652	54.000	AVERAGE

Note:

1. All Readings below 1GHz are Quasi-Peak, above are performed with peak and/or average measurements as necessary.
2. " * ", means this data is the worst emission level.
3. Measurement Level = Reading Level + Correct Factor



Engineer : Fred	
Site : EMC Lab AC 102	Time : 2010/06/29 - 17:38
Limit : FCC_15_03M_PK	Margin : 6
EUT : Wireless N FTTH Router	Probe : BBHA9120D(1-18GHz) - HORIZONTAL
Power : AC 120V/60Hz	Note : Mode 1: Transmit by 802.11b (An0) (2437MHz)

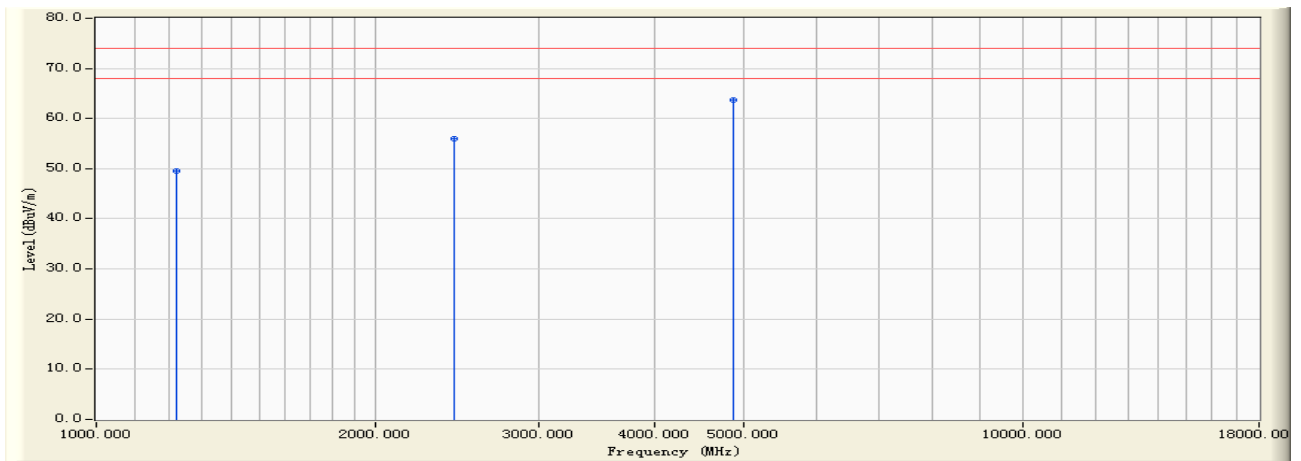

		Frequency (MHz)	Correct Factor (dB)	Reading Level (dBuV)	Measure Level (dBuV/m)	Margin (dB)	Limit (dBuV/m)	Detector Type
1		1219.360	-5.759	55.310	49.552	-24.448	74.000	PEAK
2		2437.160	0.510	55.390	55.900	-18.100	74.000	PEAK
3	*	4875.310	7.459	56.310	63.769	-10.231	74.000	PEAK

Note:

1. All Readings below 1GHz are Quasi-Peak, above are performed with peak and/or average measurements as necessary.
2. " * ", means this data is the worst emission level.
3. Measurement Level = Reading Level + Correct Factor



Engineer : Fred	
Site : EMC Lab AC 102	Time : 2010/06/29 - 17:38
Limit : FCC_15_03M_AV	Margin : 6
EUT : Wireless N FTTH Router	Probe : BBHA9120D(1-18GHz) - HORIZONTAL
Power : AC 120V/60Hz	Note : Mode 1: Transmit by 802.11b (An0) (2437MHz)

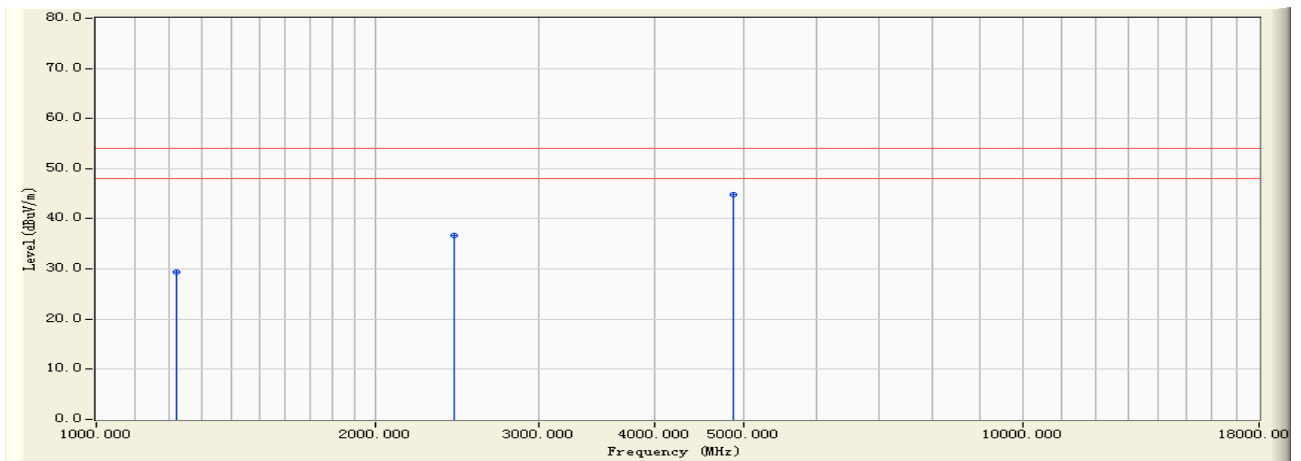

		Frequency (MHz)	Correct Factor (dB)	Reading Level (dBuV)	Measure Level (dBuV/m)	Margin (dB)	Limit (dBuV/m)	Detector Type
1		1219.360	-5.759	35.160	29.402	-24.598	54.000	AVERAGE
2		2437.160	0.510	36.150	36.660	-17.340	54.000	AVERAGE
3	*	4875.310	7.459	37.340	44.799	-9.201	54.000	AVERAGE

Note:

1. All Readings below 1GHz are Quasi-Peak, above are performed with peak and/or average measurements as necessary.
2. " * ", means this data is the worst emission level.
3. Measurement Level = Reading Level + Correct Factor



Engineer : Fred	
Site : EMC Lab AC 102	Time : 2010/06/29 - 17:40
Limit : FCC_15_03M_PK	Margin : 6
EUT : Wireless N FTTH Router	Probe : BBHA9120D(1-18GHz) - VERTICAL
Power : AC 120V/60Hz	Note : Mode 1: Transmit by 802.11b (An0) (2437MHz)

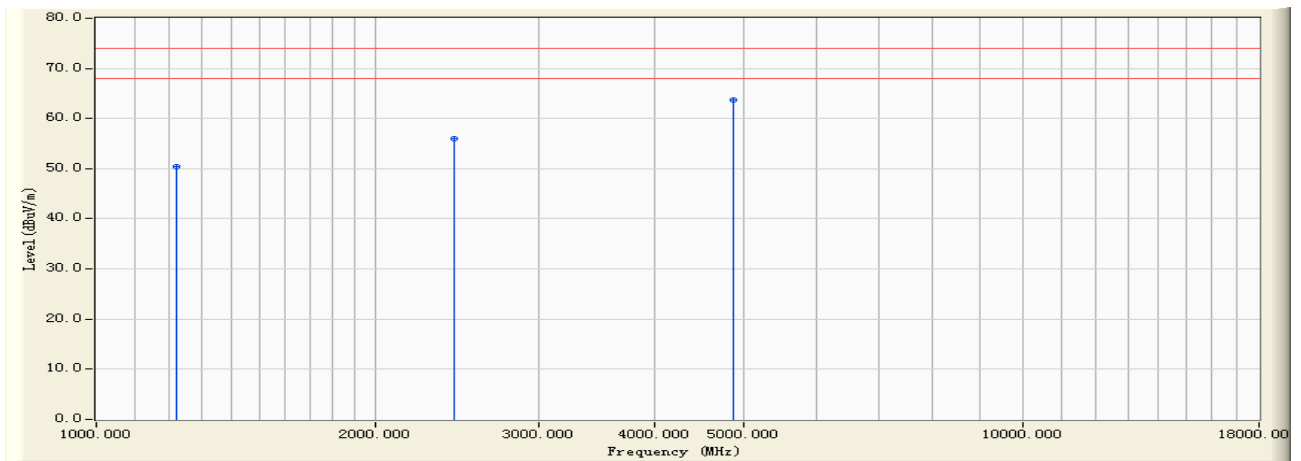

		Frequency (MHz)	Correct Factor (dB)	Reading Level (dBuV)	Measure Level (dBuV/m)	Margin (dB)	Limit (dBuV/m)	Detector Type
1		1218.360	-5.769	56.130	50.361	-23.639	74.000	PEAK
2		2437.150	0.510	55.400	55.910	-18.090	74.000	PEAK
3	*	4875.310	7.459	56.310	63.769	-10.231	74.000	PEAK

Note:

1. All Readings below 1GHz are Quasi-Peak, above are performed with peak and/or average measurements as necessary.
2. " * ", means this data is the worst emission level.
3. Measurement Level = Reading Level + Correct Factor



Engineer : Fred	
Site : EMC Lab AC 102	Time : 2010/06/29 - 17:40
Limit : FCC_15_03M_AV	Margin : 6
EUT : Wireless N FTTH Router	Probe : BBHA9120D(1-18GHz) - VERTICAL
Power : AC 120V/60Hz	Note : Mode 1: Transmit by 802.11b (An0) (2437MHz)

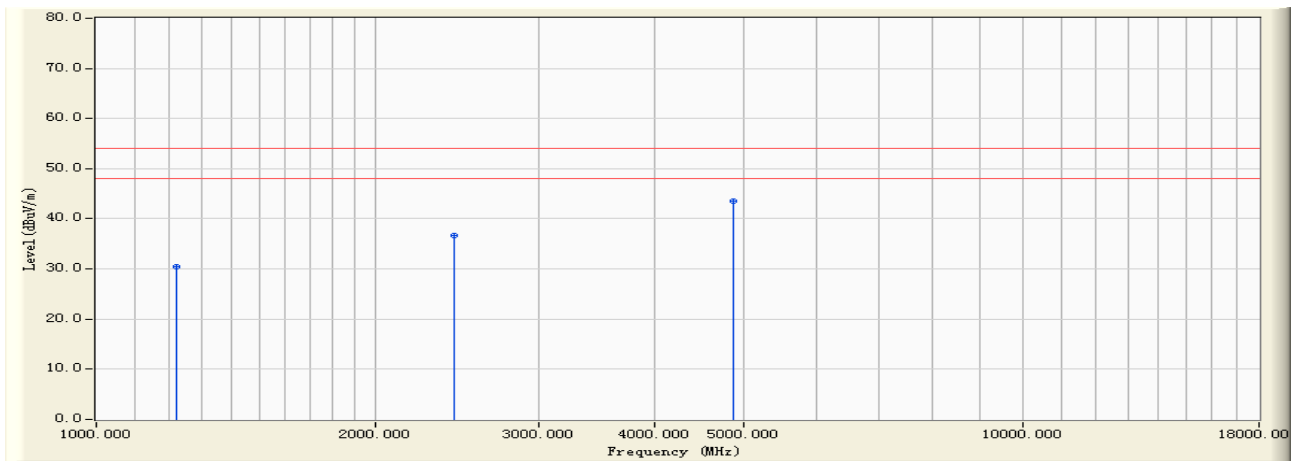

		Frequency (MHz)	Correct Factor (dB)	Reading Level (dBuV)	Measure Level (dBuV/m)	Margin (dB)	Limit (dBuV/m)	Detector Type
1		1218.360	-5.769	36.150	30.381	-23.619	54.000	AVERAGE
2		2437.150	0.510	36.190	36.700	-17.300	54.000	AVERAGE
3	*	4875.310	7.459	36.150	43.609	-10.391	54.000	AVERAGE

Note:

1. All Readings below 1GHz are Quasi-Peak, above are performed with peak and/or average measurements as necessary.
2. " * ", means this data is the worst emission level.
3. Measurement Level = Reading Level + Correct Factor



Engineer : Fred	
Site : EMC Lab AC 102	Time : 2010/06/29 - 17:41
Limit : FCC_15_03M_PK	Margin : 6
EUT : Wireless N FTTH Router	Probe : BBHA9120D(1-18GHz) - HORIZONTAL
Power : AC 120V/60Hz	Note : Mode 1: Transmit by 802.11b (An0) (2462MHz)

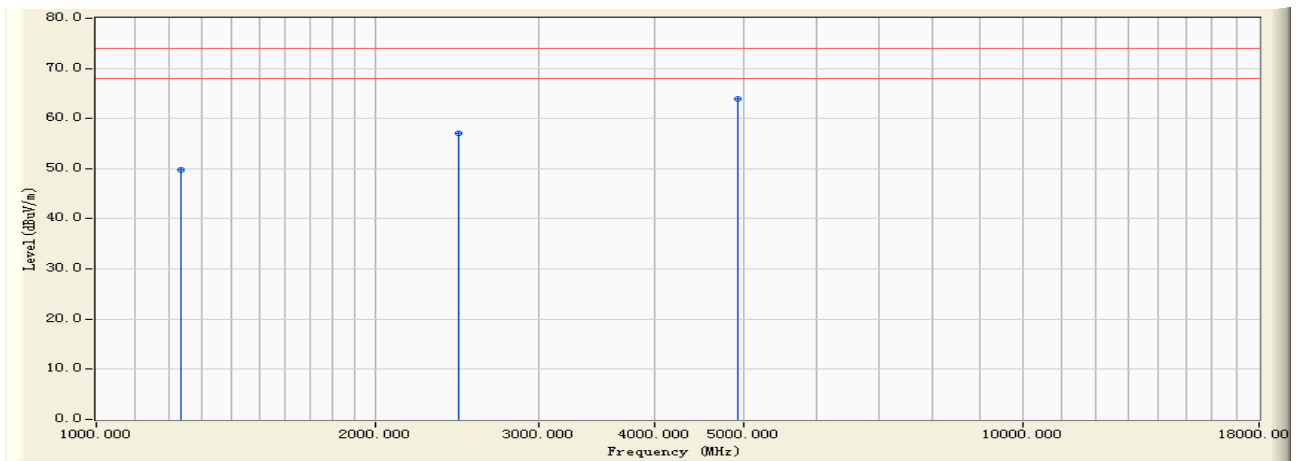

		Frequency (MHz)	Correct Factor (dB)	Reading Level (dBuV)	Measure Level (dBuV/m)	Margin (dB)	Limit (dBuV/m)	Detector Type
1		1232.650	-5.612	55.340	49.729	-24.271	74.000	PEAK
2		2462.190	0.601	56.370	56.970	-17.030	74.000	PEAK
3	*	4925.340	7.567	56.310	63.877	-10.123	74.000	PEAK

Note:

1. All Readings below 1GHz are Quasi-Peak, above are performed with peak and/or average measurements as necessary.
2. " * ", means this data is the worst emission level.
3. Measurement Level = Reading Level + Correct Factor



Engineer : Fred	
Site : EMC Lab AC 102	Time : 2010/06/29 - 17:41
Limit : FCC_15_03M_AV	Margin : 6
EUT : Wireless N FTTH Router	Probe : BBHA9120D(1-18GHz) - HORIZONTAL
Power : AC 120V/60Hz	Note : Mode 1: Transmit by 802.11b (An0) (2462MHz)

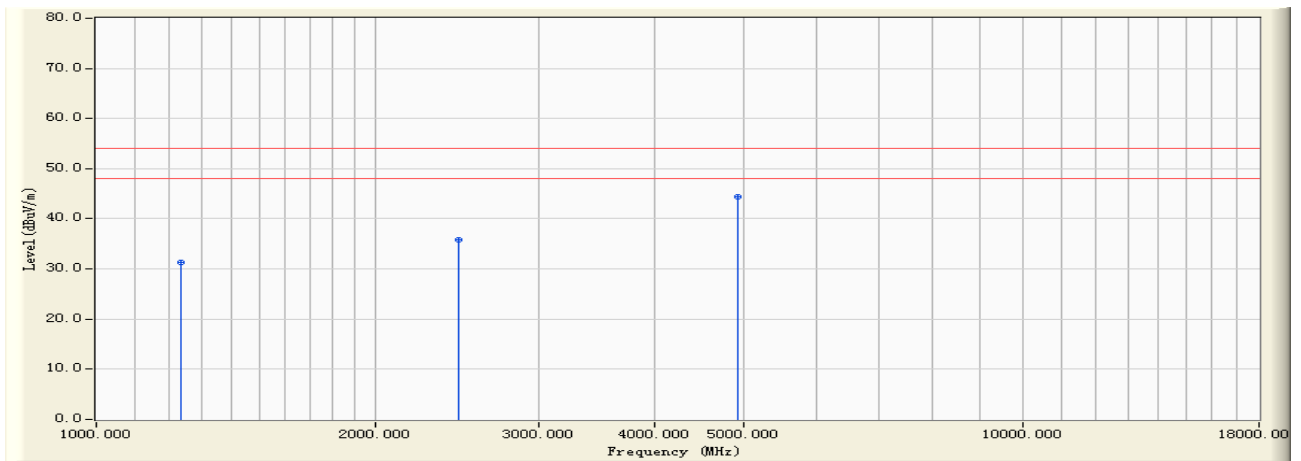

		Frequency (MHz)	Correct Factor (dB)	Reading Level (dBuV)	Measure Level (dBuV/m)	Margin (dB)	Limit (dBuV/m)	Detector Type
1		1232.650	-5.612	36.870	31.259	-22.741	54.000	AVERAGE
2		2462.190	0.601	35.190	35.790	-18.210	54.000	AVERAGE
3	*	4925.340	7.567	36.830	44.397	-9.603	54.000	AVERAGE

Note:

1. All Readings below 1GHz are Quasi-Peak, above are performed with peak and/or average measurements as necessary.
2. " * ", means this data is the worst emission level.
3. Measurement Level = Reading Level + Correct Factor



Engineer : Fred	
Site : EMC Lab AC 102	Time : 2010/06/29 - 17:43
Limit : FCC_15_03M_PK	Margin : 6
EUT : Wireless N FTTH Router	Probe : BBHA9120D(1-18GHz) - VERTICAL
Power : AC 120V/60Hz	Note : Mode 1: Transmit by 802.11b (An0) (2462MHz)

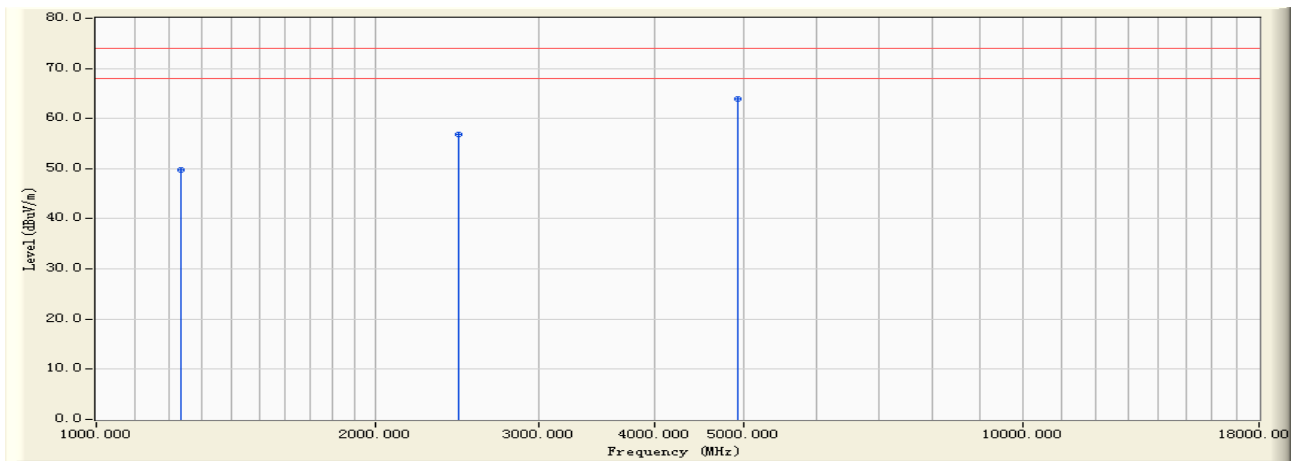

		Frequency (MHz)	Correct Factor (dB)	Reading Level (dBuV)	Measure Level (dBuV/m)	Margin (dB)	Limit (dBuV/m)	Detector Type
1		1232.640	-5.612	55.390	49.778	-24.222	74.000	PEAK
2		2462.160	0.601	56.310	56.910	-17.090	74.000	PEAK
3	*	4925.370	7.567	56.340	63.907	-10.093	74.000	PEAK

Note:

1. All Readings below 1GHz are Quasi-Peak, above are performed with peak and/or average measurements as necessary.
2. " * ", means this data is the worst emission level.
3. Measurement Level = Reading Level + Correct Factor



Engineer : Fred	
Site : EMC Lab AC 102	Time : 2010/06/29 - 17:43
Limit : FCC_15_03M_AV	Margin : 6
EUT : Wireless N FTTH Router	Probe : BBHA9120D(1-18GHz) - VERTICAL
Power : AC 120V/60Hz	Note : Mode 1: Transmit by 802.11b (An0) (2462MHz)

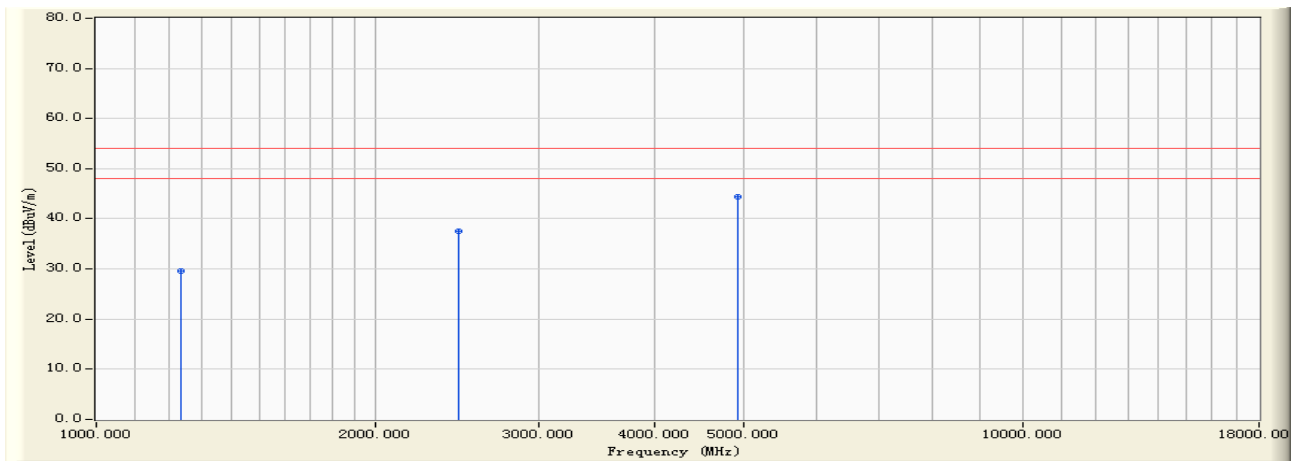

		Frequency (MHz)	Correct Factor (dB)	Reading Level (dBuV)	Measure Level (dBuV/m)	Margin (dB)	Limit (dBuV/m)	Detector Type
1		1232.640	-5.612	35.160	29.548	-24.452	54.000	AVERAGE
2		2462.160	0.601	36.870	37.470	-16.530	54.000	AVERAGE
3	*	4925.370	7.567	36.870	44.437	-9.563	54.000	AVERAGE

Note:

1. All Readings below 1GHz are Quasi-Peak, above are performed with peak and/or average measurements as necessary.
2. " * ", means this data is the worst emission level.
3. Measurement Level = Reading Level + Correct Factor



Engineer : Fred	
Site : EMC Lab AC 102	Time : 2010/06/29 - 17:52
Limit : FCC_15_03M_PK	Margin : 6
EUT : Wireless N FTTH Router	Probe : BBHA9120D(1-18GHz) - HORIZONTAL
Power : AC 120V/60Hz	Note : Mode 2: Transmit by 802.11g (An0) (2412MHz)

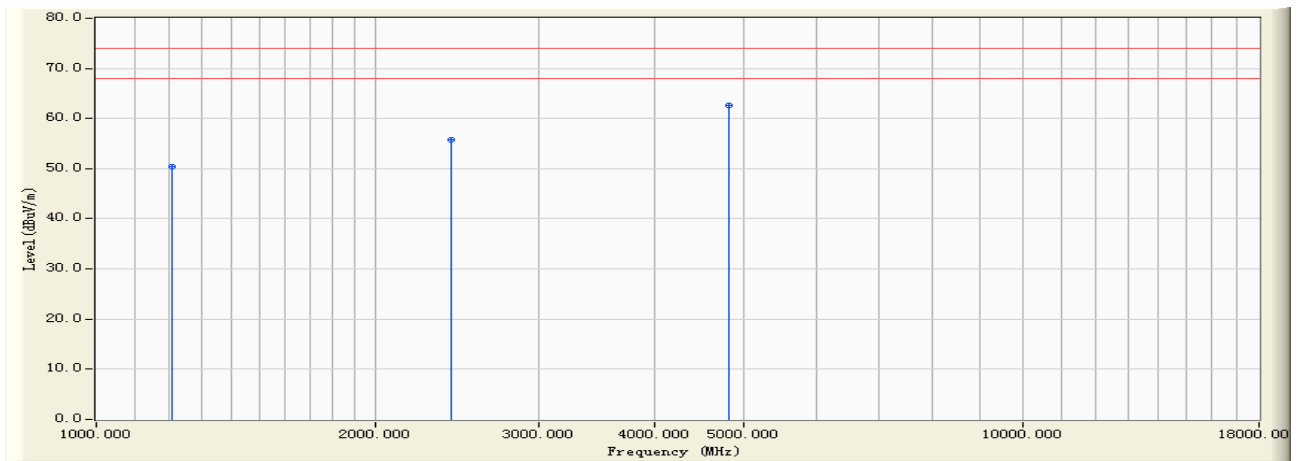

		Frequency (MHz)	Correct Factor (dB)	Reading Level (dBuV)	Measure Level (dBuV/m)	Margin (dB)	Limit (dBuV/m)	Detector Type
1		1207.350	-5.883	56.310	50.426	-23.574	74.000	PEAK
2		2412.040	0.428	55.380	55.809	-18.191	74.000	PEAK
3	*	4825.310	7.350	55.340	62.691	-11.309	74.000	PEAK

Note:

1. All Readings below 1GHz are Quasi-Peak, above are performed with peak and/or average measurements as necessary.
2. " * ", means this data is the worst emission level.
3. Measurement Level = Reading Level + Correct Factor



Engineer : Fred	
Site : EMC Lab AC 102	Time : 2010/06/29 - 17:52
Limit : FCC_15_03M_AV	Margin : 6
EUT : Wireless N FTTH Router	Probe : BBHA9120D(1-18GHz) - HORIZONTAL
Power : AC 120V/60Hz	Note : Mode 2: Transmit by 802.11g (An0) (2412MHz)

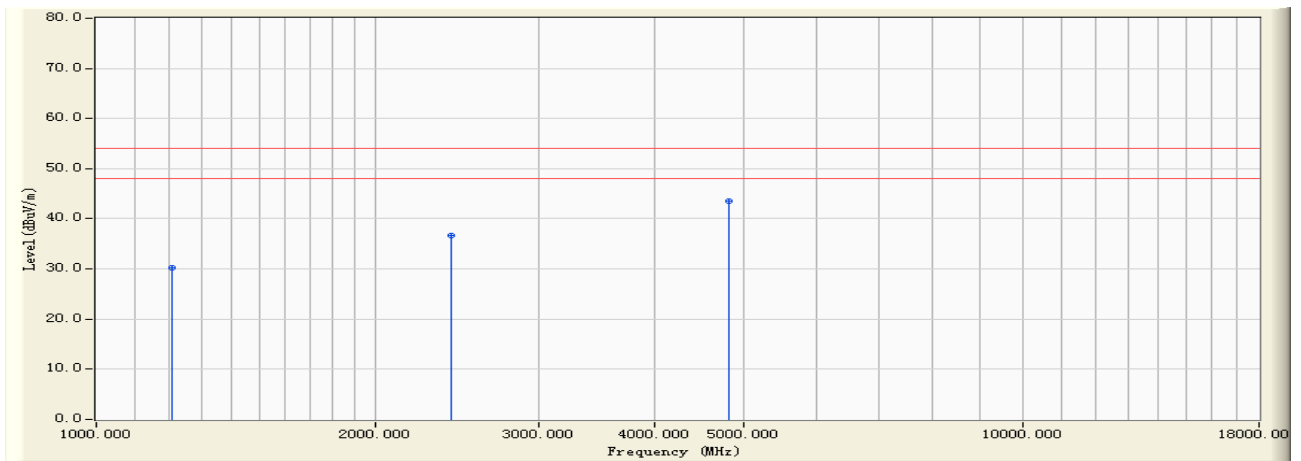

		Frequency (MHz)	Correct Factor (dB)	Reading Level (dBuV)	Measure Level (dBuV/m)	Margin (dB)	Limit (dBuV/m)	Detector Type
1		1207.350	-5.883	36.120	30.236	-23.764	54.000	AVERAGE
2		2412.040	0.428	36.150	36.579	-17.421	54.000	AVERAGE
3	*	4825.310	7.350	36.150	43.501	-10.499	54.000	AVERAGE

Note:

1. All Readings below 1GHz are Quasi-Peak, above are performed with peak and/or average measurements as necessary.
2. " * ", means this data is the worst emission level.
3. Measurement Level = Reading Level + Correct Factor



Engineer : Fred	
Site : EMC Lab AC 102	Time : 2010/06/29 - 18:19
Limit : FCC_15_03M_PK	Margin : 6
EUT : Wireless N FTTH Router	Probe : BBHA9120D(1-18GHz) - VERTICAL
Power : AC 120V/60Hz	Note : Mode 2: Transmit by 802.11g (An0) (2412MHz)

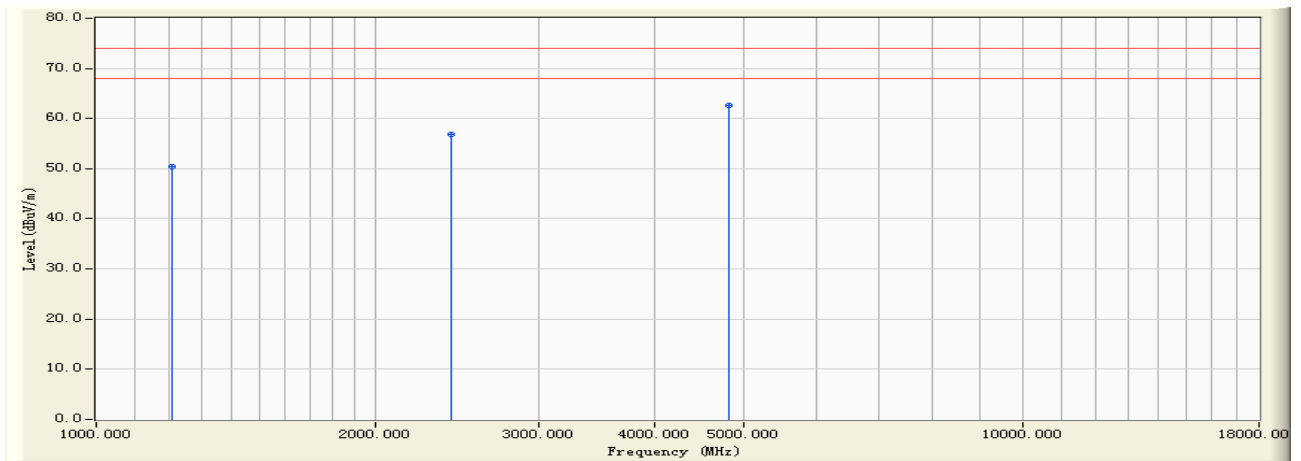

		Frequency (MHz)	Correct Factor (dB)	Reading Level (dBuV)	Measure Level (dBuV/m)	Margin (dB)	Limit (dBuV/m)	Detector Type
1		1207.350	-5.883	56.310	50.426	-23.574	74.000	PEAK
2		2412.050	0.428	56.320	56.749	-17.251	74.000	PEAK
3	*	4824.340	7.348	55.310	62.658	-11.342	74.000	PEAK

Note:

1. All Readings below 1GHz are Quasi-Peak, above are performed with peak and/or average measurements as necessary.
2. " * ", means this data is the worst emission level.
3. Measurement Level = Reading Level + Correct Factor



Engineer : Fred	
Site : EMC Lab AC 102	Time : 2010/06/29 - 18:19
Limit : FCC_15_03M_AV	Margin : 6
EUT : Wireless N FTTH Router	Probe : BBHA9120D(1-18GHz) - VERTICAL
Power : AC 120V/60Hz	Note : Mode 2: Transmit by 802.11g (An0) (2412MHz)

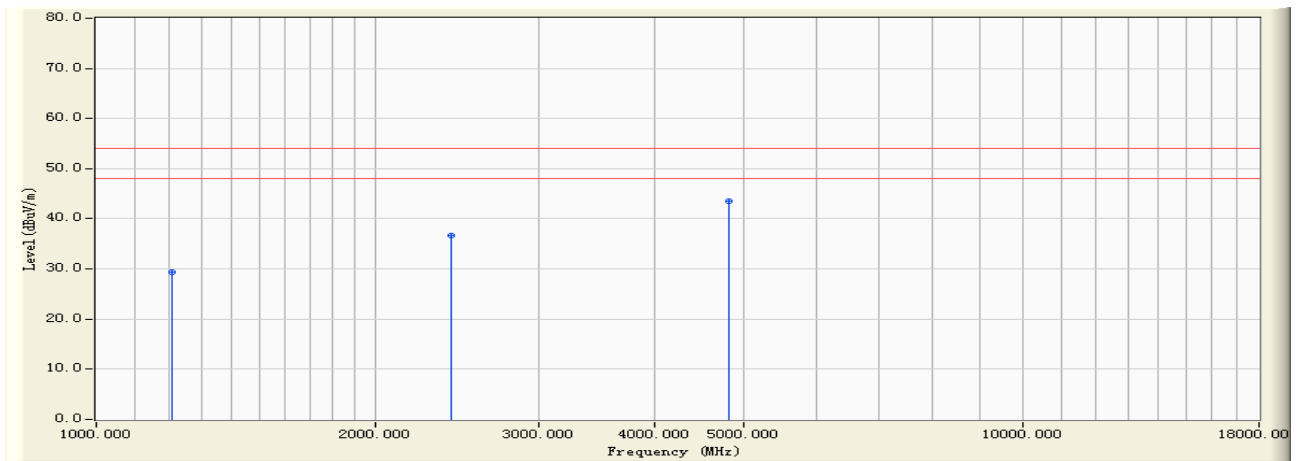

		Frequency (MHz)	Correct Factor (dB)	Reading Level (dBuV)	Measure Level (dBuV/m)	Margin (dB)	Limit (dBuV/m)	Detector Type
1		1207.350	-5.883	35.260	29.376	-24.624	54.000	AVERAGE
2		2412.050	0.428	36.150	36.579	-17.421	54.000	AVERAGE
3	*	4824.340	7.348	36.150	43.498	-10.502	54.000	AVERAGE

Note:

1. All Readings below 1GHz are Quasi-Peak, above are performed with peak and/or average measurements as necessary.
2. " * ", means this data is the worst emission level.
3. Measurement Level = Reading Level + Correct Factor



Engineer : Fred	
Site : EMC Lab AC 102	Time : 2010/06/29 - 18:21
Limit : FCC_15_03M_PK	Margin : 6
EUT : Wireless N FTTH Router	Probe : BBHA9120D(1-18GHz) - HORIZONTAL
Power : AC 120V/60Hz	Note : Mode 2: Transmit by 802.11g (An0) (2437MHz)

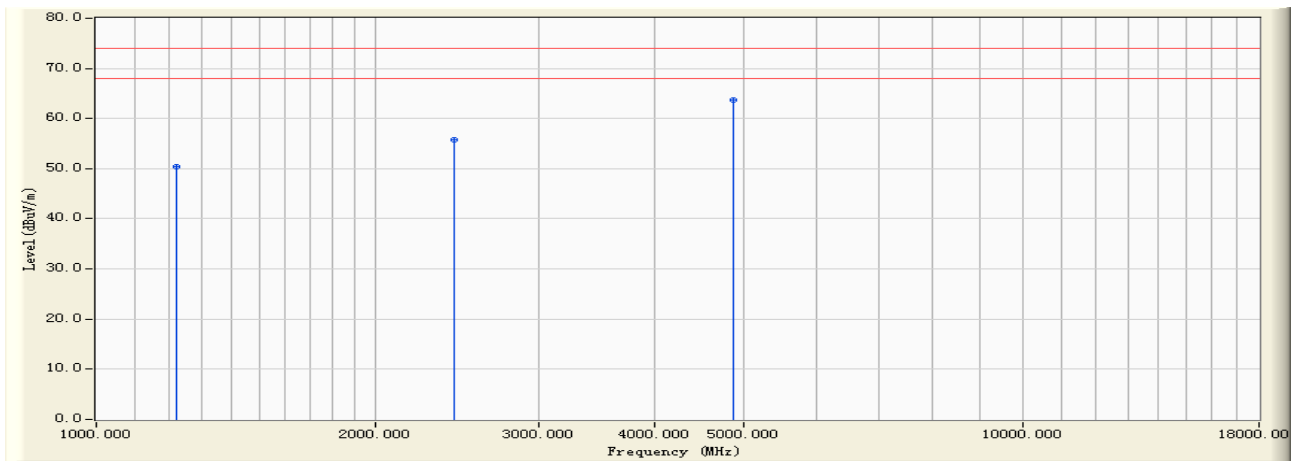

		Frequency (MHz)	Correct Factor (dB)	Reading Level (dBuV)	Measure Level (dBuV/m)	Margin (dB)	Limit (dBuV/m)	Detector Type
1		1219.350	-5.759	56.140	50.382	-23.618	74.000	PEAK
2		2437.050	0.509	55.310	55.819	-18.181	74.000	PEAK
3	*	4874.350	7.457	56.310	63.768	-10.232	74.000	PEAK

Note:

1. All Readings below 1GHz are Quasi-Peak, above are performed with peak and/or average measurements as necessary.
2. " * ", means this data is the worst emission level.
3. Measurement Level = Reading Level + Correct Factor



Engineer : Fred	
Site : EMC Lab AC 102	Time : 2010/06/29 - 18:21
Limit : FCC_15_03M_AV	Margin : 6
EUT : Wireless N FTTH Router	Probe : BBHA9120D(1-18GHz) - HORIZONTAL
Power : AC 120V/60Hz	Note : Mode 2: Transmit by 802.11g (An0) (2437MHz)

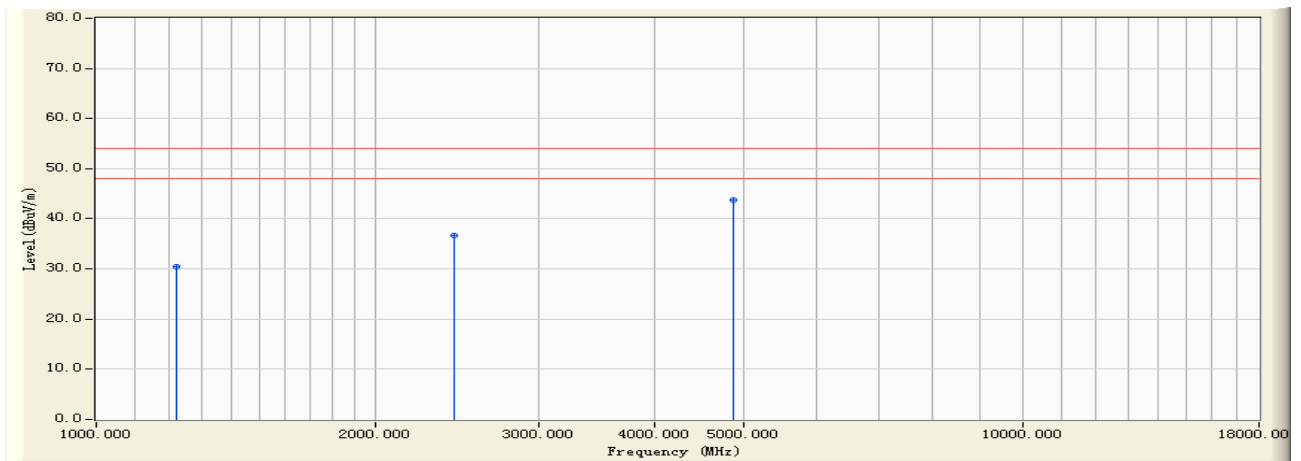

		Frequency (MHz)	Correct Factor (dB)	Reading Level (dBuV)	Measure Level (dBuV/m)	Margin (dB)	Limit (dBuV/m)	Detector Type
1		1219.350	-5.759	36.150	30.392	-23.608	54.000	AVERAGE
2		2437.050	0.509	36.150	36.659	-17.341	54.000	AVERAGE
3	*	4874.350	7.457	36.250	43.708	-10.292	54.000	AVERAGE

Note:

1. All Readings below 1GHz are Quasi-Peak, above are performed with peak and/or average measurements as necessary.
2. " * ", means this data is the worst emission level.
3. Measurement Level = Reading Level + Correct Factor



Engineer : Fred	
Site : EMC Lab AC 102	Time : 2010/06/29 - 18:24
Limit : FCC_15_03M_PK	Margin : 6
EUT : Wireless N FTTH Router	Probe : BBHA9120D(1-18GHz) - VERTICAL
Power : AC 120V/60Hz	Note : Mode 2: Transmit by 802.11g (An0) (2437MHz)

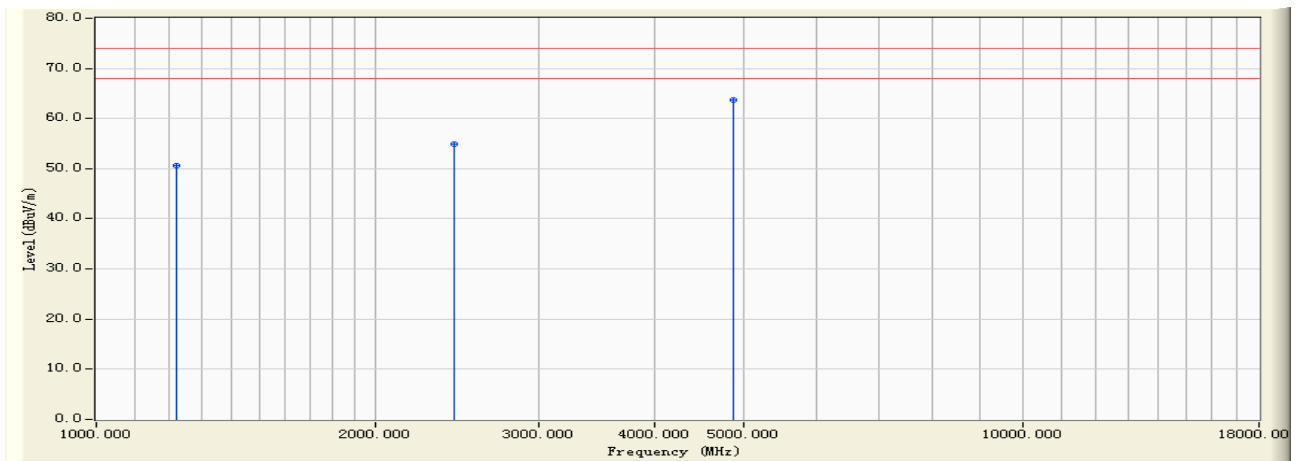

		Frequency (MHz)	Correct Factor (dB)	Reading Level (dBuV)	Measure Level (dBuV/m)	Margin (dB)	Limit (dBuV/m)	Detector Type
1		1219.350	-5.759	56.340	50.582	-23.418	74.000	PEAK
2		2437.050	0.509	54.390	54.899	-19.101	74.000	PEAK
3	*	4875.310	7.459	56.310	63.769	-10.231	74.000	PEAK

Note:

1. All Readings below 1GHz are Quasi-Peak, above are performed with peak and/or average measurements as necessary.
2. " * ", means this data is the worst emission level.
3. Measurement Level = Reading Level + Correct Factor



Engineer : Fred	
Site : EMC Lab AC 102	Time : 2010/06/29 - 18:24
Limit : FCC_15_03M_AV	Margin : 6
EUT : Wireless N FTTH Router	Probe : BBHA9120D(1-18GHz) - VERTICAL
Power : AC 120V/60Hz	Note : Mode 2: Transmit by 802.11g (An0) (2437MHz)

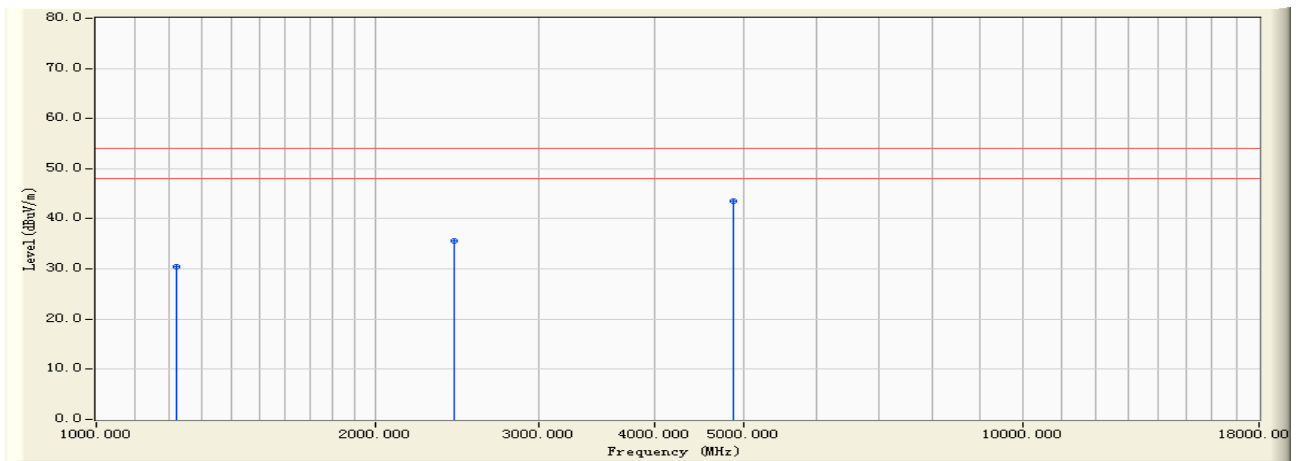

		Frequency (MHz)	Correct Factor (dB)	Reading Level (dBuV)	Measure Level (dBuV/m)	Margin (dB)	Limit (dBuV/m)	Detector Type
1		1219.350	-5.759	36.190	30.432	-23.568	54.000	AVERAGE
2		2437.050	0.509	35.160	35.669	-18.331	54.000	AVERAGE
3	*	4875.310	7.459	36.150	43.609	-10.391	54.000	AVERAGE

Note:

1. All Readings below 1GHz are Quasi-Peak, above are performed with peak and/or average measurements as necessary.
2. " * ", means this data is the worst emission level.
3. Measurement Level = Reading Level + Correct Factor



Engineer : Fred	
Site : EMC Lab AC 102	Time : 2010/06/29 - 18:25
Limit : FCC_15_03M_PK	Margin : 6
EUT : Wireless N FTTH Router	Probe : BBHA9120D(1-18GHz) - HORIZONTAL
Power : AC 120V/60Hz	Note : Mode 2: Transmit by 802.11g (An0) (2462MHz)

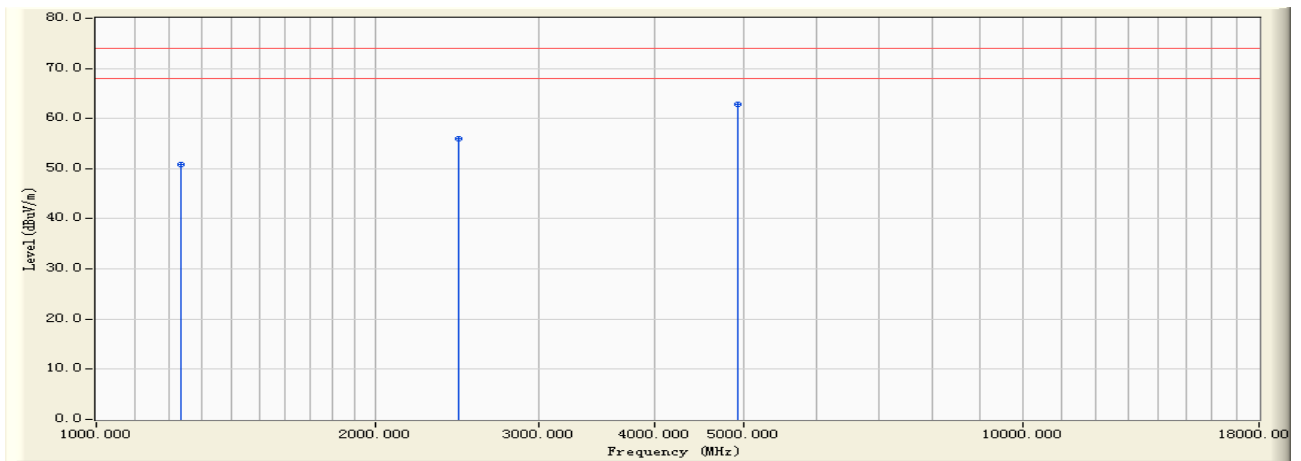

		Frequency (MHz)	Correct Factor (dB)	Reading Level (dBuV)	Measure Level (dBuV/m)	Margin (dB)	Limit (dBuV/m)	Detector Type
1		1232.060	-5.618	56.380	50.762	-23.238	74.000	PEAK
2		2462.060	0.600	55.340	55.940	-18.060	74.000	PEAK
3	*	4925.370	7.567	55.180	62.747	-11.253	74.000	PEAK

Note:

1. All Readings below 1GHz are Quasi-Peak, above are performed with peak and/or average measurements as necessary.
2. " * ", means this data is the worst emission level.
3. Measurement Level = Reading Level + Correct Factor



Engineer : Fred	
Site : EMC Lab AC 102	Time : 2010/06/29 - 18:25
Limit : FCC_15_03M_AV	Margin : 6
EUT : Wireless N FTTH Router	Probe : BBHA9120D(1-18GHz) - HORIZONTAL
Power : AC 120V/60Hz	Note : Mode 2: Transmit by 802.11g (An0) (2462MHz)

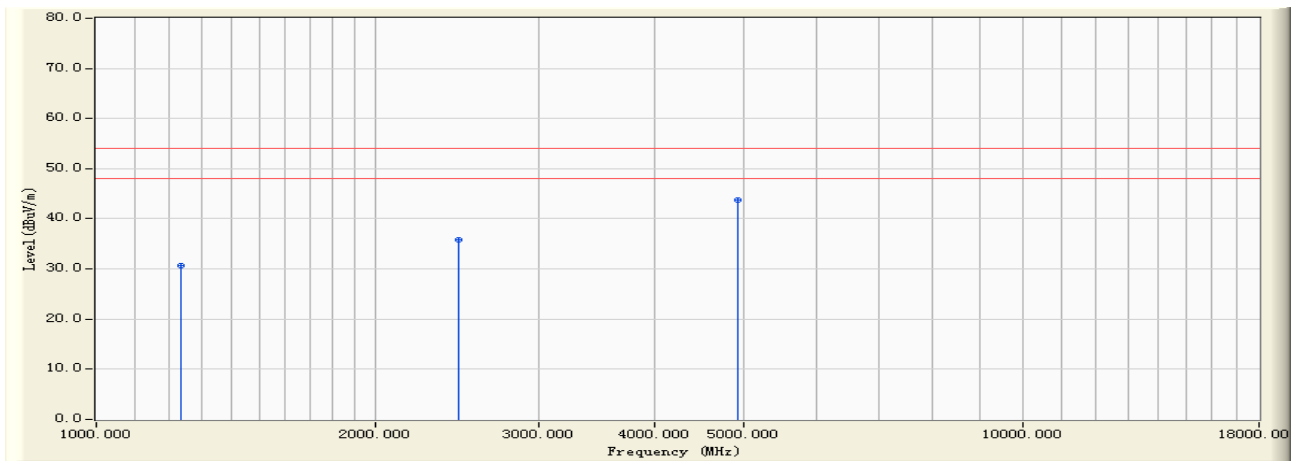

		Frequency (MHz)	Correct Factor (dB)	Reading Level (dBuV)	Measure Level (dBuV/m)	Margin (dB)	Limit (dBuV/m)	Detector Type
1		1232.060	-5.618	36.190	30.572	-23.428	54.000	AVERAGE
2		2462.090	0.600	35.160	35.760	-18.240	54.000	AVERAGE
3	*	4925.370	7.567	36.180	43.747	-10.253	54.000	AVERAGE

Note:

1. All Readings below 1GHz are Quasi-Peak, above are performed with peak and/or average measurements as necessary.
2. " * ", means this data is the worst emission level.
3. Measurement Level = Reading Level + Correct Factor



Engineer : Fred	
Site : EMC Lab AC 102	Time : 2010/06/29 - 18:26
Limit : FCC_15_03M_PK	Margin : 6
EUT : Wireless N FTTH Router	Probe : BBHA9120D(1-18GHz) - VERTICAL
Power : AC 120V/60Hz	Note : Mode 2: Transmit by 802.11g (An0) (2462MHz)

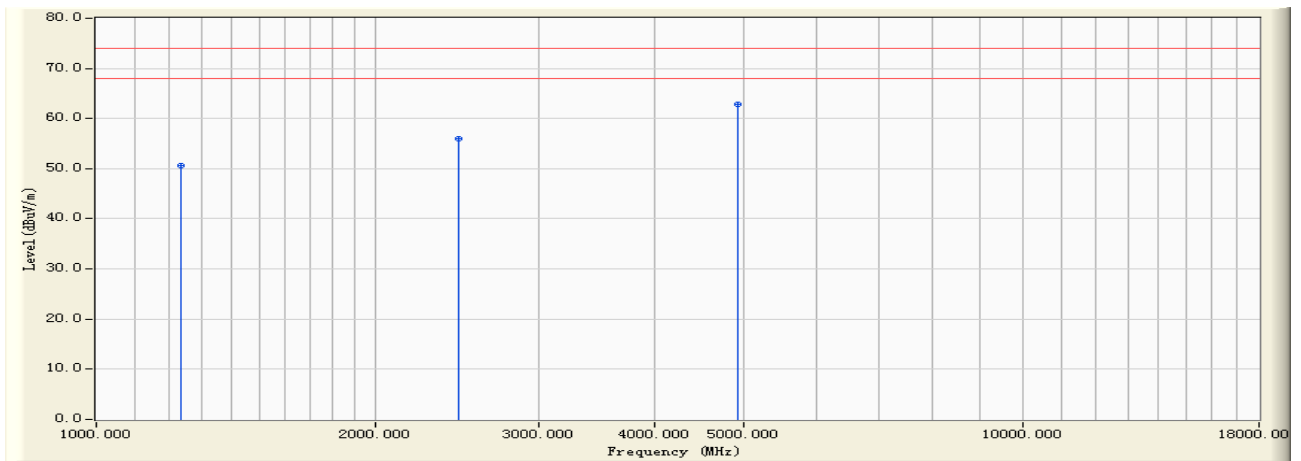

		Frequency (MHz)	Correct Factor (dB)	Reading Level (dBuV)	Measure Level (dBuV/m)	Margin (dB)	Limit (dBuV/m)	Detector Type
1		1232.190	-5.617	56.150	50.533	-23.467	74.000	PEAK
2		2462.090	0.600	55.310	55.910	-18.090	74.000	PEAK
3	*	4925.370	7.567	55.360	62.927	-11.073	74.000	PEAK

Note:

1. All Readings below 1GHz are Quasi-Peak, above are performed with peak and/or average measurements as necessary.
2. " * ", means this data is the worst emission level.
3. Measurement Level = Reading Level + Correct Factor



Engineer : Fred	
Site : EMC Lab AC 102	Time : 2010/06/29 - 18:26
Limit : FCC_15_03M_AV	Margin : 6
EUT : Wireless N FTTH Router	Probe : BBHA9120D(1-18GHz) - VERTICAL
Power : AC 120V/60Hz	Note : Mode 2: Transmit by 802.11g (An0) (2462MHz)

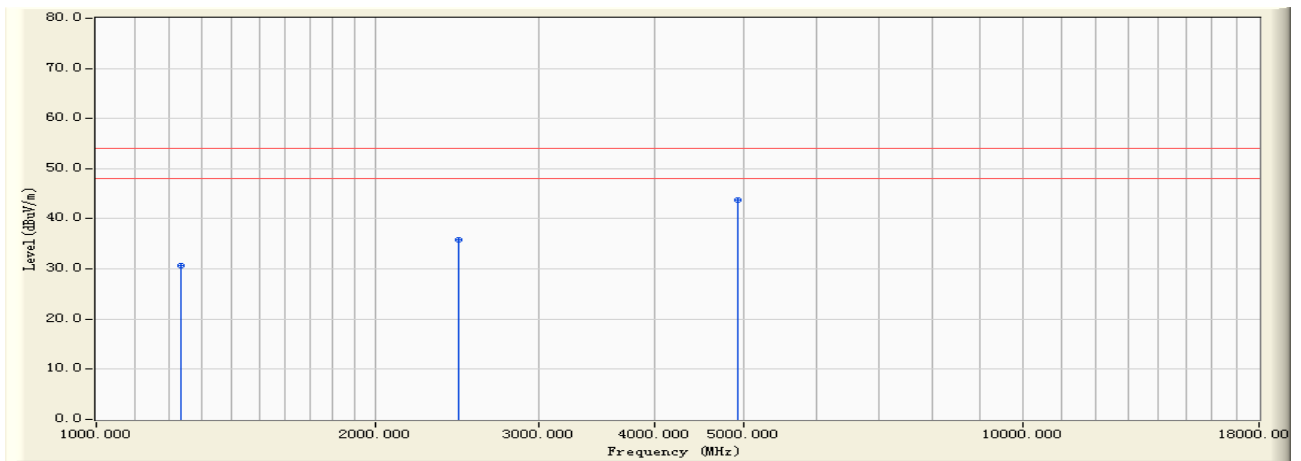

		Frequency (MHz)	Correct Factor (dB)	Reading Level (dBuV)	Measure Level (dBuV/m)	Margin (dB)	Limit (dBuV/m)	Detector Type
1		1232.190	-5.617	36.190	30.573	-23.427	54.000	AVERAGE
2		2462.090	0.600	35.180	35.780	-18.220	54.000	AVERAGE
3	*	4925.370	7.567	36.190	43.757	-10.243	54.000	AVERAGE

Note:

1. All Readings below 1GHz are Quasi-Peak, above are performed with peak and/or average measurements as necessary.
2. " * ", means this data is the worst emission level.
3. Measurement Level = Reading Level + Correct Factor



Engineer : Fred	
Site : EMC Lab AC 102	Time : 2010/06/30 - 16:31
Limit : FCC_15_03M_PK	Margin : 6
EUT : Wireless N FTTH Router	Probe : BBHA9120D(1-18GHz) - HORIZONTAL
Power : AC 120V/60Hz	Note : Mode 3: Transmit by 802.11n (20MHz) (An0 and An1) (2412MHz)

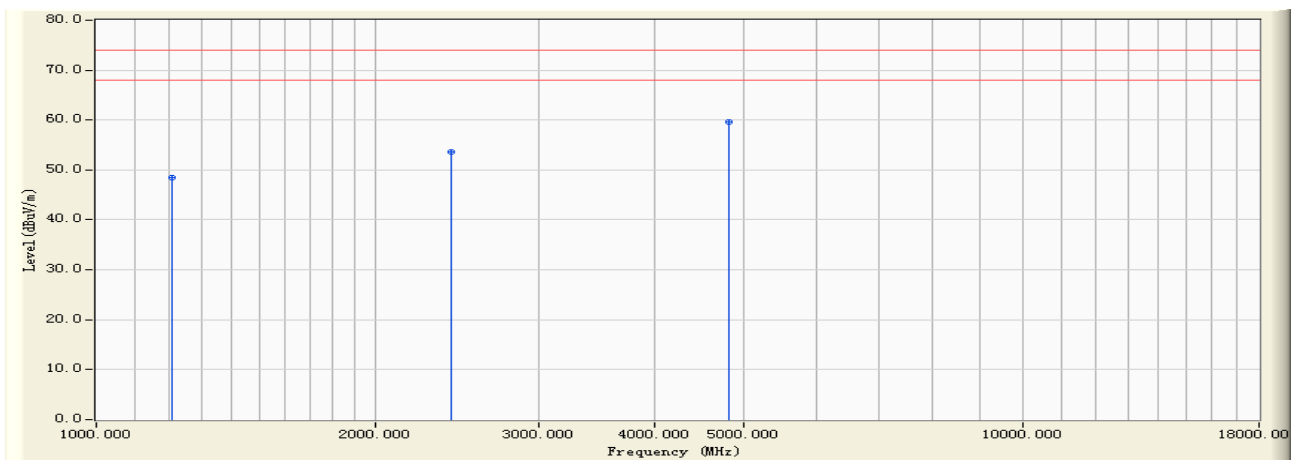

		Frequency (MHz)	Correct Factor (dB)	Reading Level (dBuV)	Measure Level (dBuV/m)	Margin (dB)	Limit (dBuV/m)	Detector Type
1		1207.350	-5.883	54.290	48.406	-25.594	74.000	PEAK
2		2412.030	0.428	53.180	53.609	-20.391	74.000	PEAK
3	*	4825.130	7.350	52.180	59.530	-14.470	74.000	PEAK

Note:

1. All Readings below 1GHz are Quasi-Peak, above are performed with peak and/or average measurements as necessary.
2. " * ", means this data is the worst emission level.
3. Measurement Level = Reading Level + Correct Factor



Engineer : Fred	
Site : EMC Lab AC 102	Time : 2010/06/30 - 16:31
Limit : FCC_15_03M_AV	Margin : 6
EUT : Wireless N FTTH Router	Probe : BBHA9120D(1-18GHz) - HORIZONTAL
Power : AC 120V/60Hz	Note : Mode 3: Transmit by 802.11n (20MHz) (An0 and An1) (2412MHz)

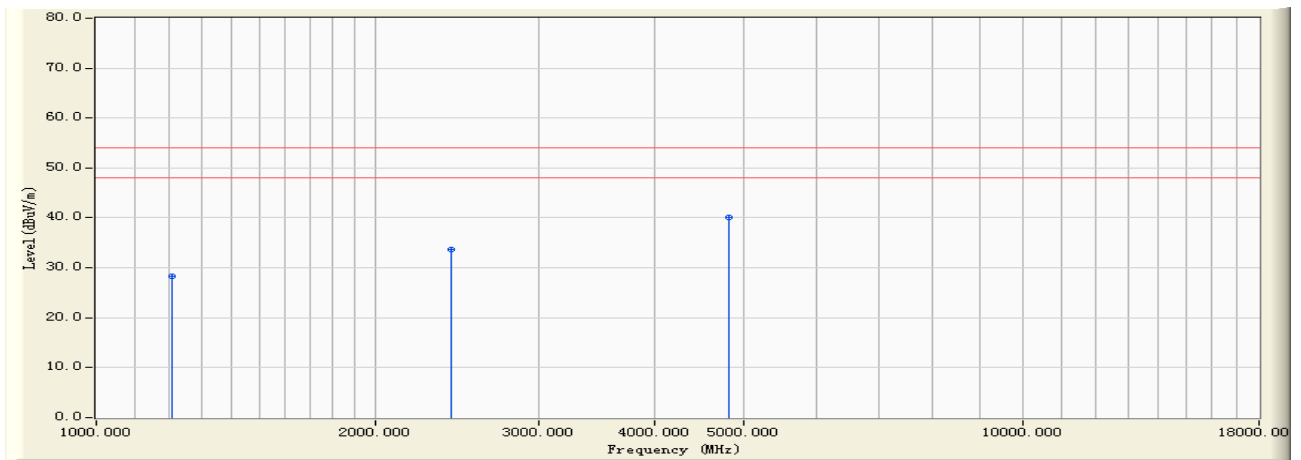

		Frequency (MHz)	Correct Factor (dB)	Reading Level (dBuV)	Measure Level (dBuV/m)	Margin (dB)	Limit (dBuV/m)	Detector Type
1		1207.350	-5.883	34.260	28.376	-25.624	54.000	AVERAGE
2		2412.030	0.428	33.290	33.719	-20.281	54.000	AVERAGE
3	*	4825.130	7.350	32.660	40.010	-13.990	54.000	AVERAGE

Note:

1. All Readings below 1GHz are Quasi-Peak, above are performed with peak and/or average measurements as necessary.
2. " * ", means this data is the worst emission level.
3. Measurement Level = Reading Level + Correct Factor



Engineer : Fred	
Site : EMC Lab AC 102	Time : 2010/06/30 - 16:33
Limit : FCC_15_03M_PK	Margin : 6
EUT : Wireless N FTTH Router	Probe : BBHA9120D(1-18GHz) - VERTICAL
Power : AC 120V/60Hz	Note : Mode 3: Transmit by 802.11n (20MHz) (An0 and An1) (2412MHz)

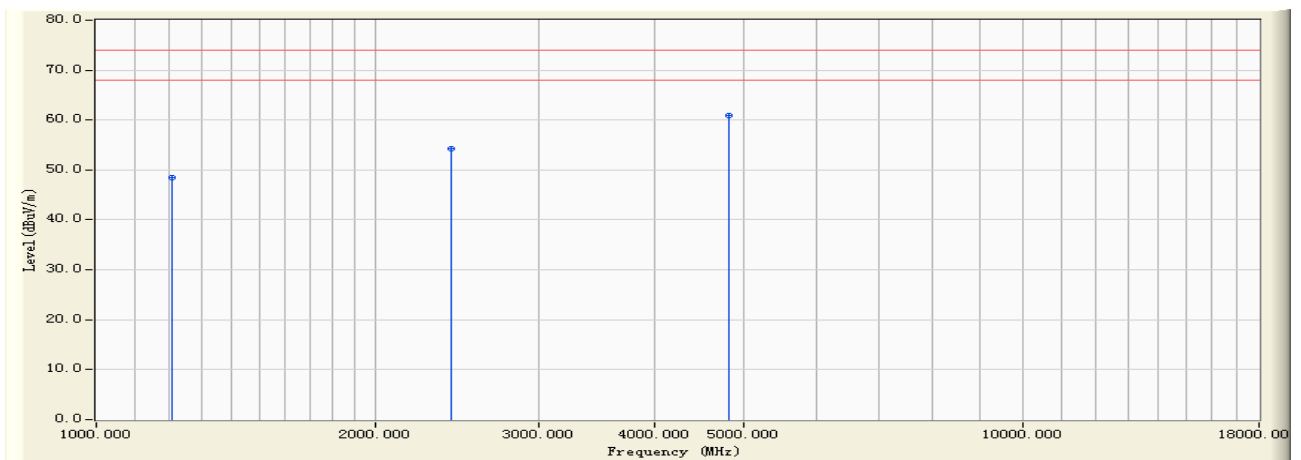

		Frequency (MHz)	Correct Factor (dB)	Reading Level (dBuV)	Measure Level (dBuV/m)	Margin (dB)	Limit (dBuV/m)	Detector Type
1		1207.390	-5.883	54.260	48.377	-25.623	74.000	PEAK
2		2412.080	0.428	53.870	54.299	-19.701	74.000	PEAK
3	*	4825.360	7.350	53.480	60.831	-13.169	74.000	PEAK

Note:

1. All Readings below 1GHz are Quasi-Peak, above are performed with peak and/or average measurements as necessary.
2. " * ", means this data is the worst emission level.
3. Measurement Level = Reading Level + Correct Factor



Engineer : Fred	
Site : EMC Lab AC 102	Time : 2010/06/30 - 16:33
Limit : FCC_15_03M_AV	Margin : 6
EUT : Wireless N FTTH Router	Probe : BBHA9120D(1-18GHz) - VERTICAL
Power : AC 120V/60Hz	Note : Mode 3: Transmit by 802.11n (20MHz) (An0 and An1) (2412MHz)

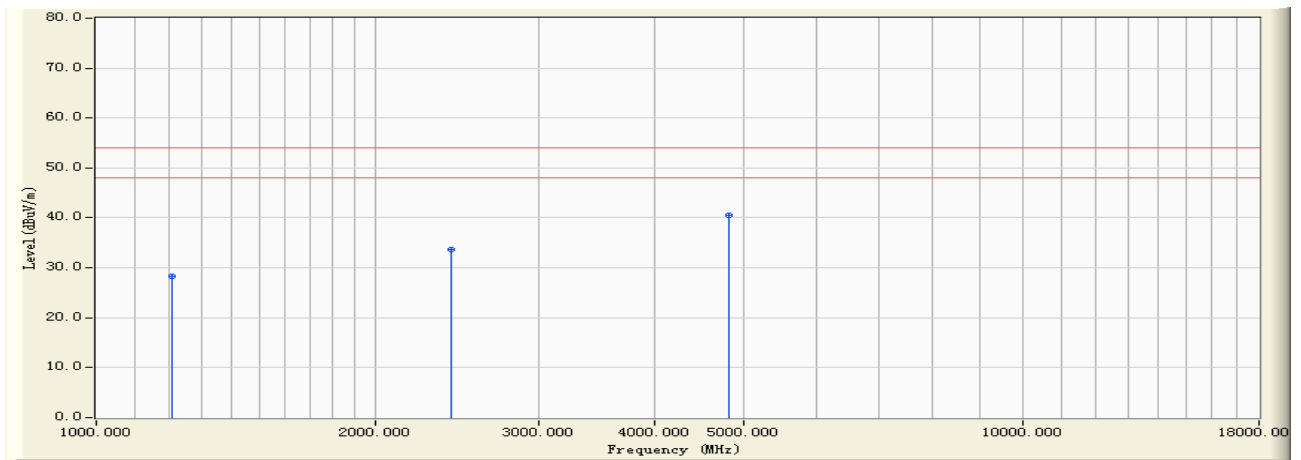

		Frequency (MHz)	Correct Factor (dB)	Reading Level (dBuV)	Measure Level (dBuV/m)	Margin (dB)	Limit (dBuV/m)	Detector Type
1		1207.390	-5.883	34.260	28.377	-25.623	54.000	AVERAGE
2		2412.080	0.428	33.260	33.689	-20.311	54.000	AVERAGE
3	*	4825.360	7.350	33.290	40.641	-13.359	54.000	AVERAGE

Note:

1. All Readings below 1GHz are Quasi-Peak, above are performed with peak and/or average measurements as necessary.
2. " * ", means this data is the worst emission level.
3. Measurement Level = Reading Level + Correct Factor



Engineer : Fred	
Site : EMC Lab AC 102	Time : 2010/06/30 - 16:34
Limit : FCC_15_03M_PK	Margin : 6
EUT : Wireless N FTTH Router	Probe : BBHA9120D(1-18GHz) - HORIZONTAL
Power : AC 120V/60Hz	Note : Mode 3: Transmit by 802.11n (20MHz) (An0 and An1) (2437MHz)

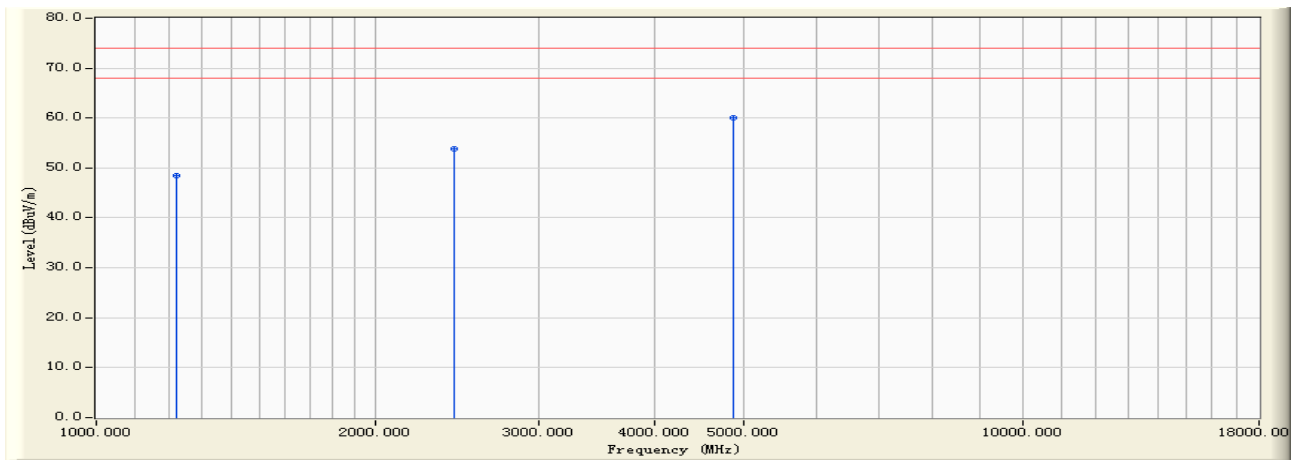

		Frequency (MHz)	Correct Factor (dB)	Reading Level (dBuV)	Measure Level (dBuV/m)	Margin (dB)	Limit (dBuV/m)	Detector Type
1		1219.350	-5.759	54.310	48.552	-25.448	74.000	PEAK
2		2437.060	0.509	53.290	53.799	-20.201	74.000	PEAK
3	*	4875.310	7.459	52.680	60.139	-13.861	74.000	PEAK

Note:

1. All Readings below 1GHz are Quasi-Peak, above are performed with peak and/or average measurements as necessary.
2. " * ", means this data is the worst emission level.
3. Measurement Level = Reading Level + Correct Factor



Engineer : Fred	
Site : EMC Lab AC 102	Time : 2010/06/30 - 16:34
Limit : FCC_15_03M_AV	Margin : 6
EUT : Wireless N FTTH Router	Probe : BBHA9120D(1-18GHz) - HORIZONTAL
Power : AC 120V/60Hz	Note : Mode 3: Transmit by 802.11n (20MHz) (An0 and An1) (2437MHz)

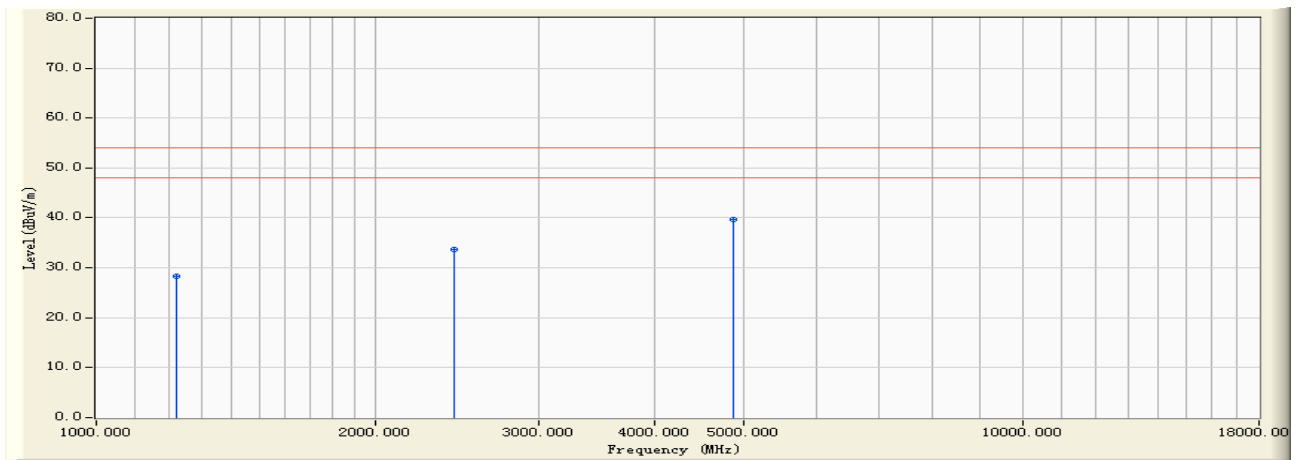

		Frequency (MHz)	Correct Factor (dB)	Reading Level (dBuV)	Measure Level (dBuV/m)	Margin (dB)	Limit (dBuV/m)	Detector Type
1		1219.350	-5.759	34.160	28.402	-25.598	54.000	AVERAGE
2		2437.060	0.509	33.190	33.699	-20.301	54.000	AVERAGE
3	*	4875.310	7.459	32.180	39.639	-14.361	54.000	AVERAGE

Note:

1. All Readings below 1GHz are Quasi-Peak, above are performed with peak and/or average measurements as necessary.
2. " * ", means this data is the worst emission level.
3. Measurement Level = Reading Level + Correct Factor



Engineer : Fred	
Site : EMC Lab AC 102	Time : 2010/06/30 - 16:36
Limit : FCC_15_03M_PK	Margin : 6
EUT : Wireless N FTTH Router	Probe : BBHA9120D(1-18GHz) - VERTICAL
Power : AC 120V/60Hz	Note : Mode 3: Transmit by 802.11n (20MHz) (An0 and An1) (2437MHz)

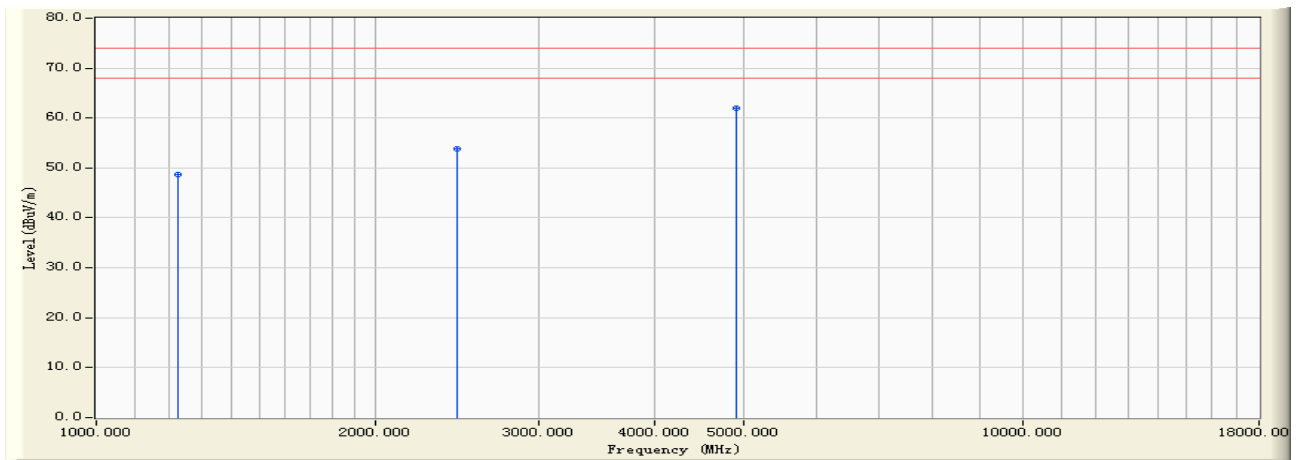

	Frequency (MHz)	Correct Factor (dB)	Reading Level (dBuV)	Measure Level (dBuV/m)	Margin (dB)	Limit (dBuV/m)	Detector Type	Ant Pos (cm)	Table Pos (deg)
1	1227.350	-5.671	54.320	48.649	-25.351	74.000	PEAK	102.300	49.500
2	2452.140	0.560	53.190	53.750	-20.250	74.000	PEAK	123.500	146.200
3	* 4905.160	7.526	54.360	61.886	-12.114	74.000	PEAK	105.200	189.400

Note:

1. All Readings below 1GHz are Quasi-Peak, above are performed with peak and/or average measurements as necessary.
2. " * ", means this data is the worst emission level.
3. Measurement Level = Reading Level + Correct Factor



Engineer : Fred	
Site : EMC Lab AC 102	Time : 2010/06/30 - 16:36
Limit : FCC_15_03M_AV	Margin : 6
EUT : Wireless N FTTH Router	Probe : BBHA9120D(1-18GHz) - VERTICAL
Power : AC 120V/60Hz	Note : Mode 3: Transmit by 802.11n (20MHz) (An0 and An1) (2437MHz)

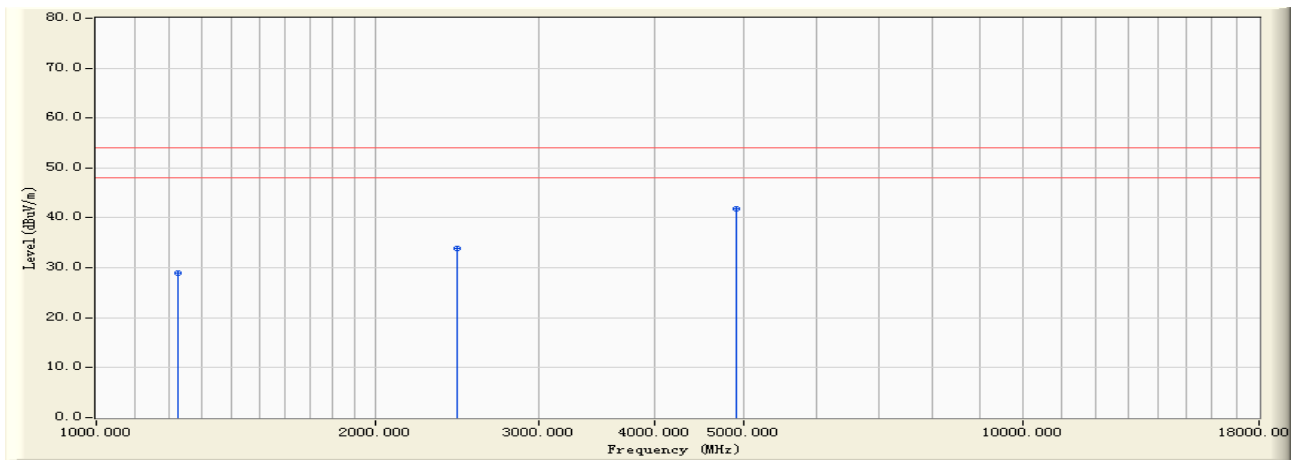

	Frequency (MHz)	Correct Factor (dB)	Reading Level (dBuV)	Measure Level (dBuV/m)	Margin (dB)	Limit (dBuV/m)	Detector Type	Ant Pos (cm)	Table Pos (deg)
1	1227.350	-5.671	34.620	28.949	-25.051	54.000	AVERAGE	102.300	49.500
2	2452.140	0.560	33.260	33.820	-20.180	54.000	AVERAGE	123.500	146.200
3	* 4905.160	7.526	34.260	41.786	-12.214	54.000	AVERAGE	105.200	189.400

Note:

1. All Readings below 1GHz are Quasi-Peak, above are performed with peak and/or average measurements as necessary.
2. " * ", means this data is the worst emission level.
3. Measurement Level = Reading Level + Correct Factor



Engineer : Fred	
Site : EMC Lab AC 102	Time : 2010/06/30 - 16:39
Limit : FCC_15_03M_PK	Margin : 6
EUT : Wireless N FTTH Router	Probe : BBHA9120D(1-18GHz) - HORIZONTAL
Power : AC 120V/60Hz	Note : Mode 3: Transmit by 802.11n (20MHz) (An0 and An1) (2462MHz)

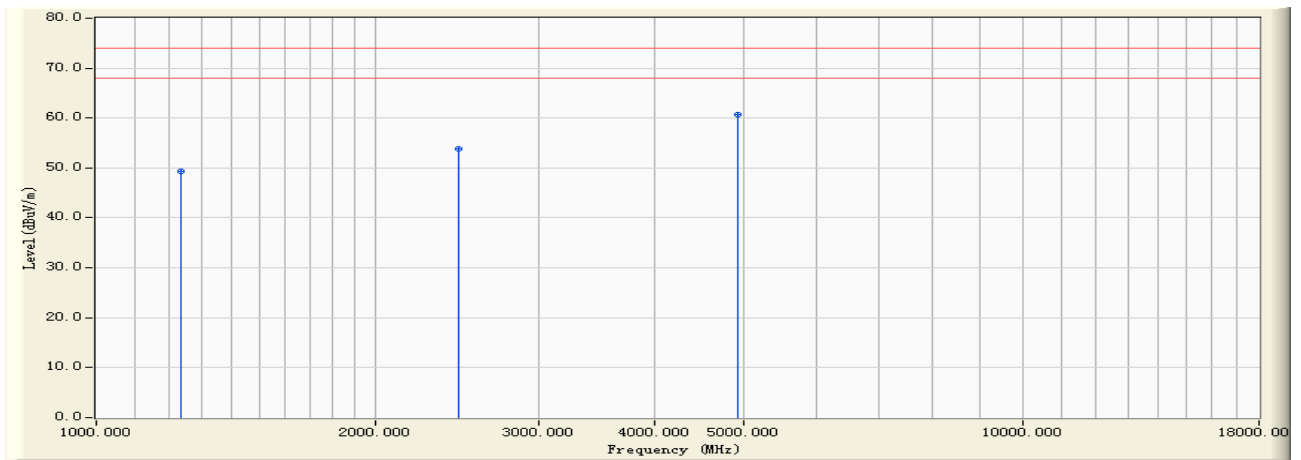

		Frequency (MHz)	Correct Factor (dB)	Reading Level (dBuV)	Measure Level (dBuV/m)	Margin (dB)	Limit (dBuV/m)	Detector Type
1		1232.460	-5.613	54.980	49.366	-24.634	74.000	PEAK
2		2462.060	0.600	53.190	53.790	-20.210	74.000	PEAK
3	*	4925.370	7.567	53.160	60.727	-13.273	74.000	PEAK

Note:

1. All Readings below 1GHz are Quasi-Peak, above are performed with peak and/or average measurements as necessary.
2. " * ", means this data is the worst emission level.
3. Measurement Level = Reading Level + Correct Factor



Engineer : Fred	
Site : EMC Lab AC 102	Time : 2010/06/30 - 16:39
Limit : FCC_15_03M_AV	Margin : 6
EUT : Wireless N FTTH Router	Probe : BBHA9120D(1-18GHz) - HORIZONTAL
Power : AC 120V/60Hz	Note : Mode 3: Transmit by 802.11n (20MHz) (An0 and An1) (2462MHz)

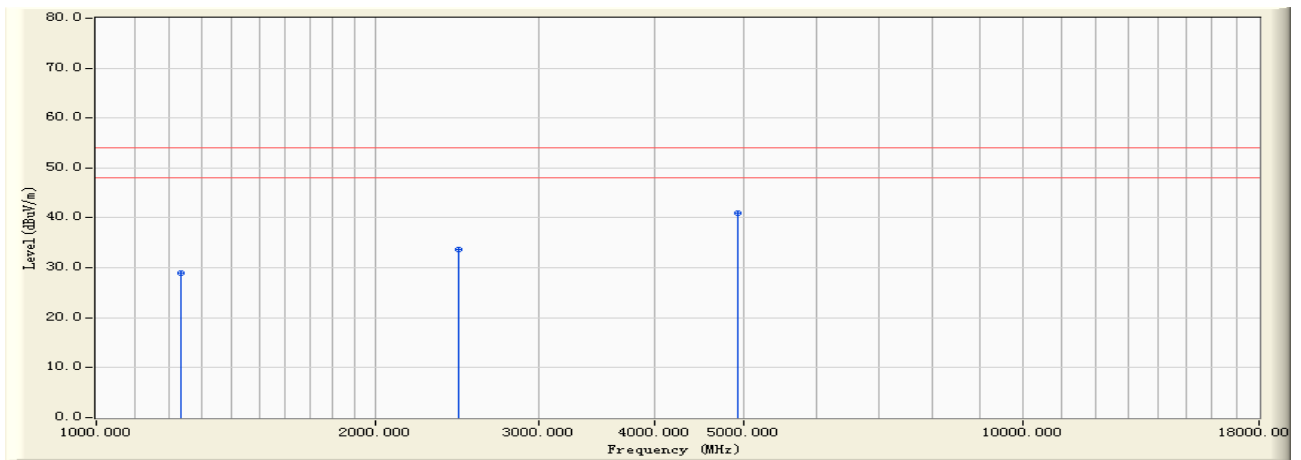

		Frequency (MHz)	Correct Factor (dB)	Reading Level (dBuV)	Measure Level (dBuV/m)	Margin (dB)	Limit (dBuV/m)	Detector Type
1		1232.460	-5.613	34.620	29.006	-24.994	54.000	AVERAGE
2		2462.060	0.600	33.160	33.760	-20.240	54.000	AVERAGE
3	*	4925.370	7.567	33.490	41.057	-12.943	54.000	AVERAGE

Note:

1. All Readings below 1GHz are Quasi-Peak, above are performed with peak and/or average measurements as necessary.
2. " * ", means this data is the worst emission level.
3. Measurement Level = Reading Level + Correct Factor



Engineer : Fred	
Site : EMC Lab AC 102	Time : 2010/06/30 - 16:40
Limit : FCC_15_03M_PK	Margin : 6
EUT : Wireless N FTTH Router	Probe : BBHA9120D(1-18GHz) - VERTICAL
Power : AC 120V/60Hz	Note : Mode 3: Transmit by 802.11n (20MHz) (An0 and An1) (2462MHz)

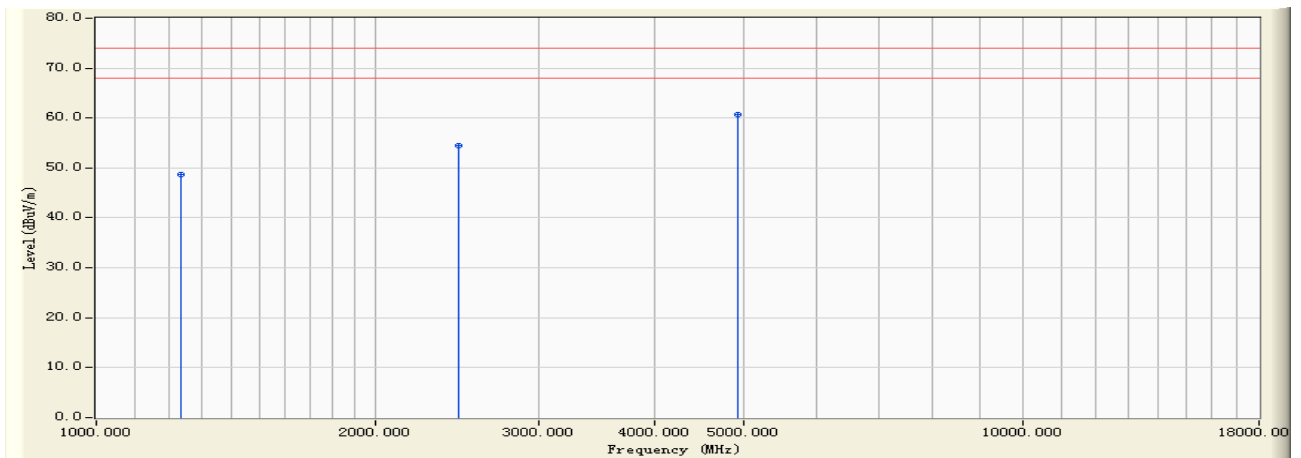

		Frequency (MHz)	Correct Factor (dB)	Reading Level (dBuV)	Measure Level (dBuV/m)	Margin (dB)	Limit (dBuV/m)	Detector Type
1		1232.640	-5.612	54.360	48.748	-25.252	74.000	PEAK
2		2462.010	0.600	53.890	54.490	-19.510	74.000	PEAK
3	*	4926.370	7.570	53.180	60.750	-13.250	74.000	PEAK

Note:

1. All Readings below 1GHz are Quasi-Peak, above are performed with peak and/or average measurements as necessary.
2. " * ", means this data is the worst emission level.
3. Measurement Level = Reading Level + Correct Factor



Engineer : Fred	
Site : EMC Lab AC 102	Time : 2010/06/30 - 16:40
Limit : FCC_15_03M_AV	Margin : 6
EUT : Wireless N FTTH Router	Probe : BBHA9120D(1-18GHz) - VERTICAL
Power : AC 120V/60Hz	Note : Mode 3: Transmit by 802.11n (20MHz) (An0 and An1) (2462MHz)

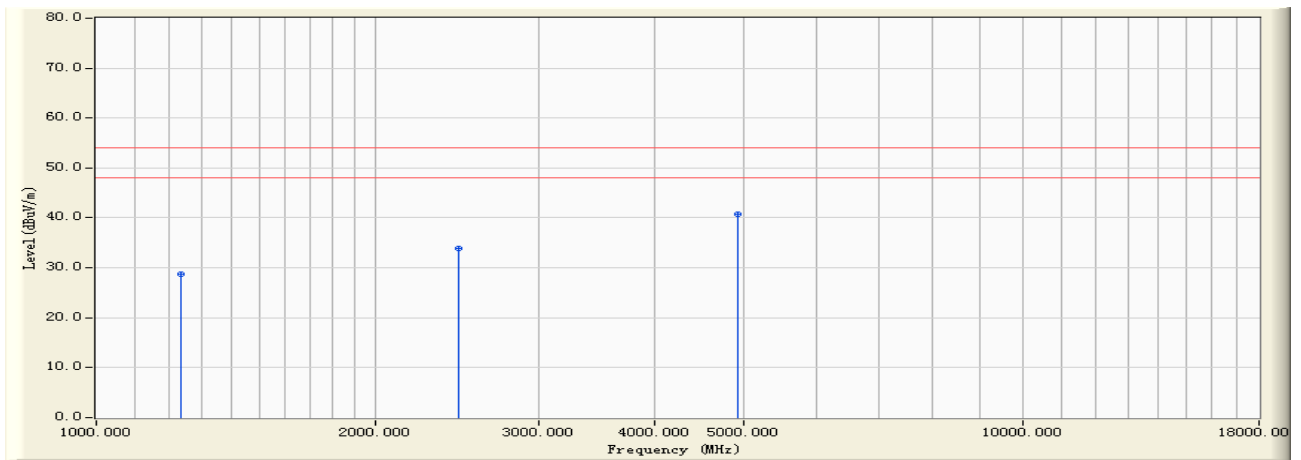

		Frequency (MHz)	Correct Factor (dB)	Reading Level (dBuV)	Measure Level (dBuV/m)	Margin (dB)	Limit (dBuV/m)	Detector Type
1		1232.640	-5.612	34.260	28.648	-25.352	54.000	AVERAGE
2		2462.010	0.600	33.260	33.860	-20.140	54.000	AVERAGE
3	*	4926.370	7.570	33.280	40.850	-13.150	54.000	AVERAGE

Note:

1. All Readings below 1GHz are Quasi-Peak, above are performed with peak and/or average measurements as necessary.
2. " * ", means this data is the worst emission level.
3. Measurement Level = Reading Level + Correct Factor



Engineer : Fred	
Site : EMC Lab AC 102	Time : 2010/06/30 - 16:42
Limit : FCC_15_03M_PK	Margin : 6
EUT : Wireless N FTTH Router	Probe : BBHA9120D(1-18GHz) - HORIZONTAL
Power : AC 120V/60Hz	Note : Mode 4: Transmit by 802.11n (40MHz) (An0 and An1) (2422MHz)

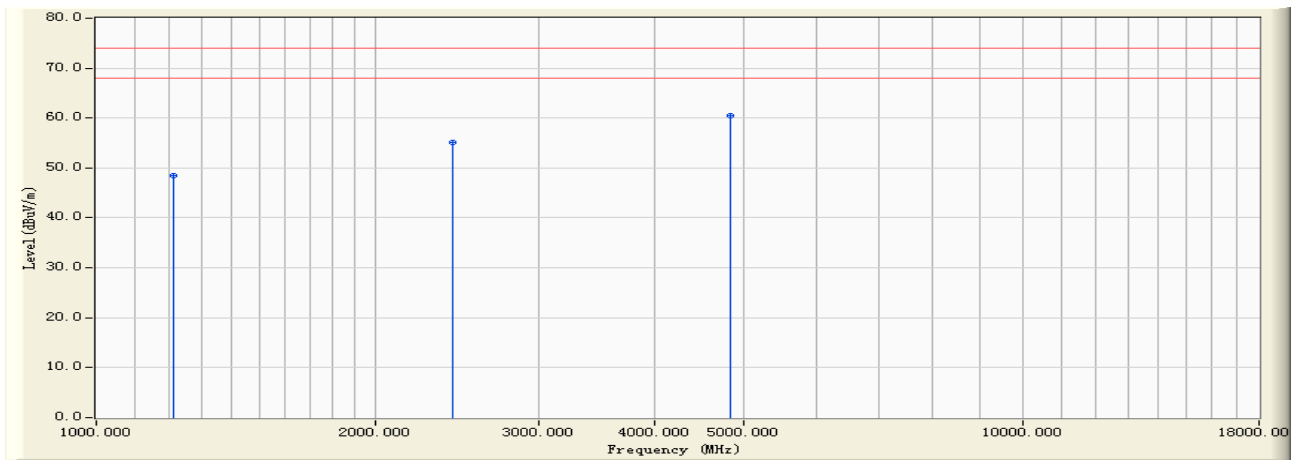

		Frequency (MHz)	Correct Factor (dB)	Reading Level (dBuV)	Measure Level (dBuV/m)	Margin (dB)	Limit (dBuV/m)	Detector Type
1		1212.320	-5.832	54.260	48.428	-25.572	74.000	PEAK
2		2422.035	0.463	54.690	55.153	-18.847	74.000	PEAK
3	*	4845.310	7.392	53.160	60.552	-13.448	74.000	PEAK

Note:

1. All Readings below 1GHz are Quasi-Peak, above are performed with peak and/or average measurements as necessary.
2. " * ", means this data is the worst emission level.
3. Measurement Level = Reading Level + Correct Factor



Engineer : Fred	
Site : EMC Lab AC 102	Time : 2010/06/30 - 16:42
Limit : FCC_15_03M_AV	Margin : 6
EUT : Wireless N FTTH Router	Probe : BBHA9120D(1-18GHz) - HORIZONTAL
Power : AC 120V/60Hz	Note : Mode 4: Transmit by 802.11n (40MHz) (An0 and An1) (2422MHz)

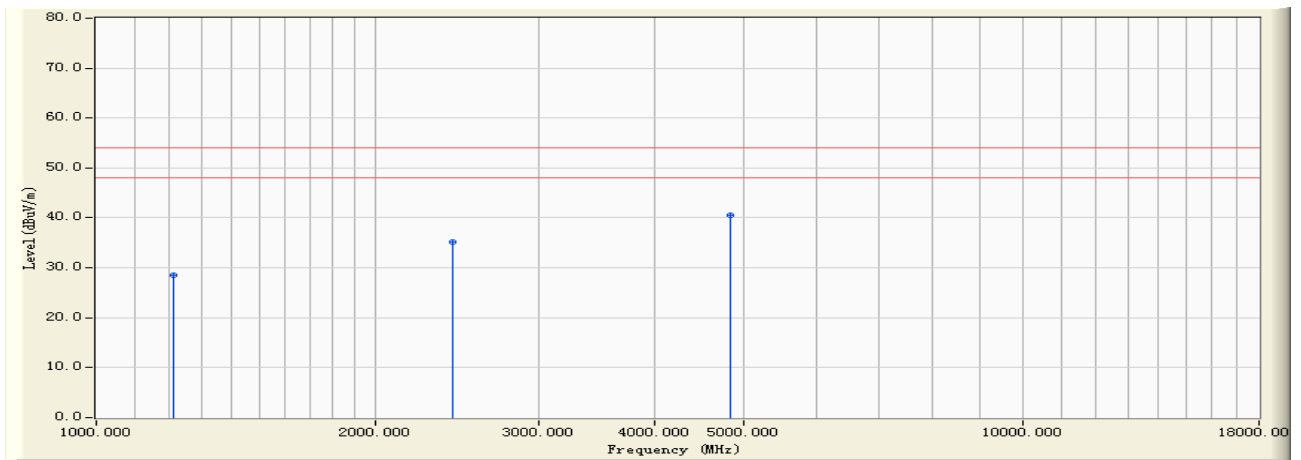

		Frequency (MHz)	Correct Factor (dB)	Reading Level (dBuV)	Measure Level (dBuV/m)	Margin (dB)	Limit (dBuV/m)	Detector Type
1		1212.320	-5.832	34.260	28.428	-25.572	54.000	AVERAGE
2		2422.035	0.463	34.620	35.083	-18.917	54.000	AVERAGE
3	*	4845.310	7.392	33.160	40.552	-13.448	54.000	AVERAGE

Note:

1. All Readings below 1GHz are Quasi-Peak, above are performed with peak and/or average measurements as necessary.
2. " * ", means this data is the worst emission level.
3. Measurement Level = Reading Level + Correct Factor



Engineer : Fred	
Site : EMC Lab AC 102	Time : 2010/06/30 - 16:44
Limit : FCC_15_03M_PK	Margin : 6
EUT : Wireless N FTTH Router	Probe : BBHA9120D(1-18GHz) - VERTICAL
Power : AC 120V/60Hz	Note : Mode 4: Transmit by 802.11n (40MHz) (An0 and An1) (2422MHz)

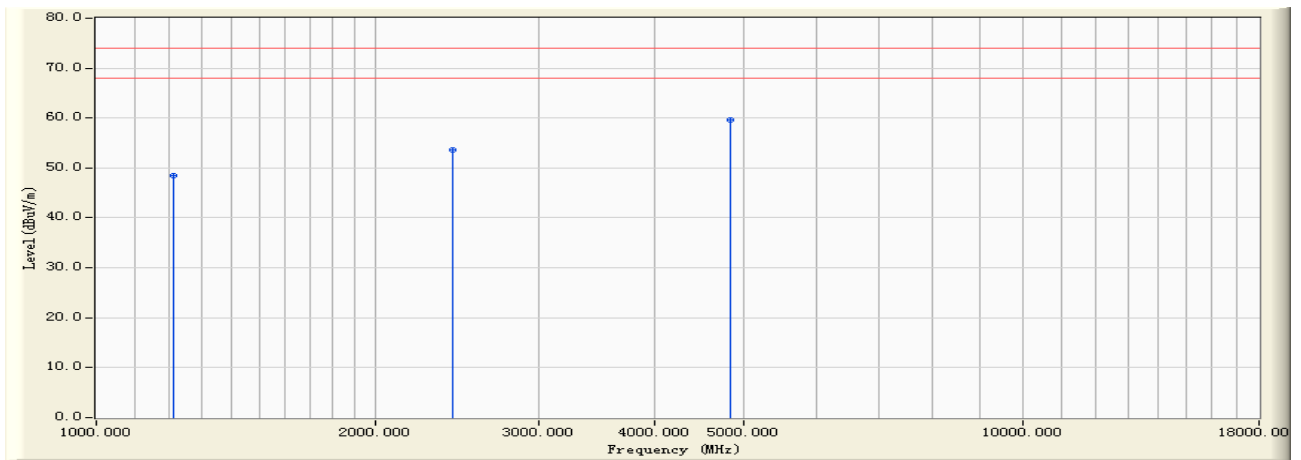

		Frequency (MHz)	Correct Factor (dB)	Reading Level (dBuV)	Measure Level (dBuV/m)	Margin (dB)	Limit (dBuV/m)	Detector Type
1		1212.350	-5.831	54.310	48.478	-25.522	74.000	PEAK
2		2422.060	0.462	53.160	53.623	-20.377	74.000	PEAK
3	*	4845.360	7.392	52.190	59.582	-14.418	74.000	PEAK

Note:

1. All Readings below 1GHz are Quasi-Peak, above are performed with peak and/or average measurements as necessary.
2. " * ", means this data is the worst emission level.
3. Measurement Level = Reading Level + Correct Factor



Engineer : Fred	
Site : EMC Lab AC 102	Time : 2010/06/30 - 16:44
Limit : FCC_15_03M_AV	Margin : 6
EUT : Wireless N FTTH Router	Probe : BBHA9120D(1-18GHz) - VERTICAL
Power : AC 120V/60Hz	Note : Mode 4: Transmit by 802.11n (40MHz) (An0 and An1) (2422MHz)

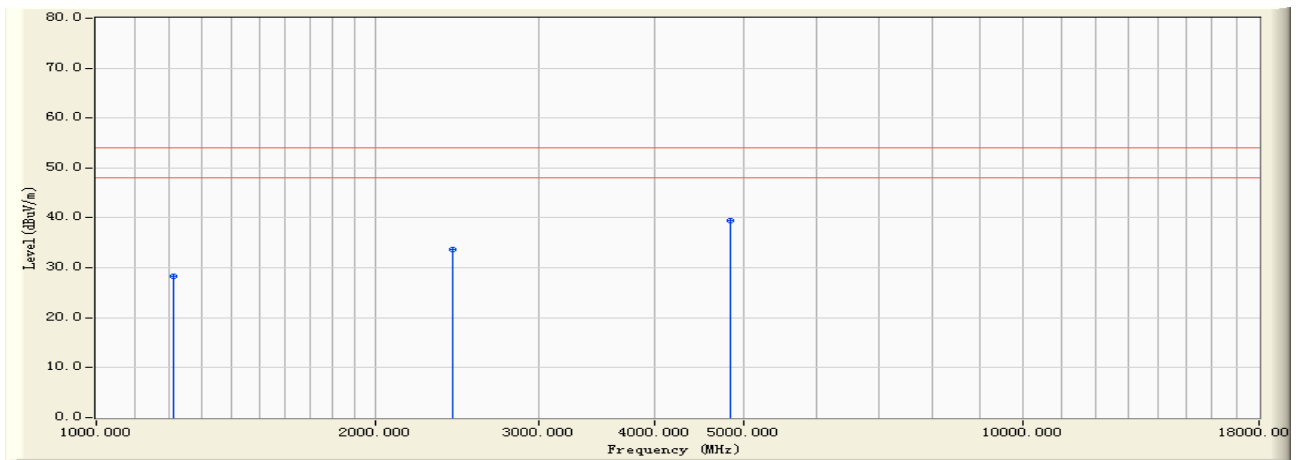

		Frequency (MHz)	Correct Factor (dB)	Reading Level (dBuV)	Measure Level (dBuV/m)	Margin (dB)	Limit (dBuV/m)	Detector Type
1		1212.350	-5.831	34.160	28.328	-25.672	54.000	AVERAGE
2		2422.060	0.462	33.160	33.623	-20.377	54.000	AVERAGE
3	*	4845.360	7.392	32.160	39.552	-14.448	54.000	AVERAGE

Note:

1. All Readings below 1GHz are Quasi-Peak, above are performed with peak and/or average measurements as necessary.
2. " * ", means this data is the worst emission level.
3. Measurement Level = Reading Level + Correct Factor



Engineer : Fred	
Site : EMC Lab AC 102	Time : 2010/06/30 - 16:47
Limit : FCC_15_03M_PK	Margin : 6
EUT : Wireless N FTTH Router	Probe : BBHA9120D(1-18GHz) - HORIZONTAL
Power : AC 120V/60Hz	Note : Mode 4: Transmit by 802.11n (40MHz) (An0 and An1) (2437MHz)

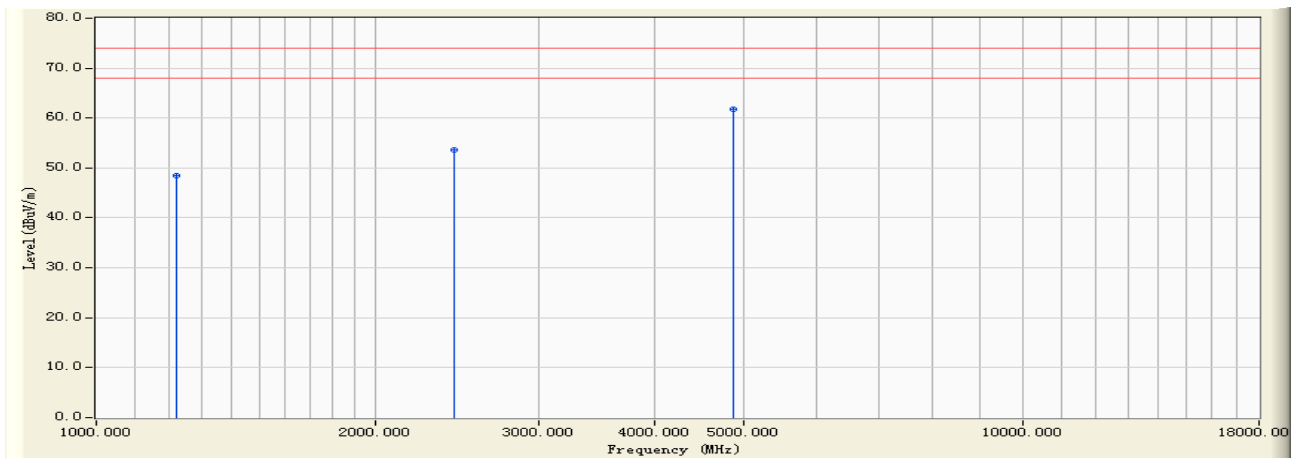

		Frequency (MHz)	Correct Factor (dB)	Reading Level (dBUV)	Measure Level (dBUV/m)	Margin (dB)	Limit (dBUV/m)	Detector Type
1		1219.360	-5.759	54.130	48.372	-25.628	74.000	PEAK
2		2437.060	0.509	53.160	53.669	-20.331	74.000	PEAK
3	*	4875.310	7.459	54.360	61.819	-12.181	74.000	PEAK

Note:

1. All Readings below 1GHz are Quasi-Peak, above are performed with peak and/or average measurements as necessary.
2. " * ", means this data is the worst emission level.
3. Measurement Level = Reading Level + Correct Factor



Engineer : Fred	
Site : EMC Lab AC 102	Time : 2010/06/30- 16:47
Limit : FCC_15_03M_AV	Margin : 6
EUT : Wireless N FTTH Router	Probe : BBHA9120D(1-18GHz) - HORIZONTAL
Power : AC 120V/60Hz	Note : Mode 4: Transmit by 802.11n (40MHz) (An0 and An1) (2437MHz)

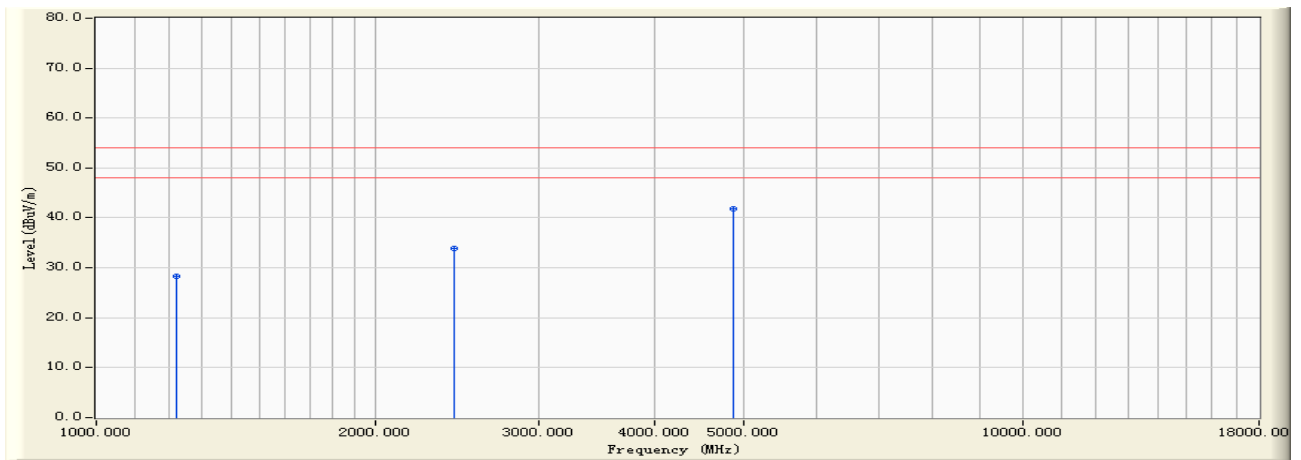

		Frequency (MHz)	Correct Factor (dB)	Reading Level (dBuV)	Measure Level (dBuV/m)	Margin (dB)	Limit (dBuV/m)	Detector Type
1		1219.360	-5.759	34.160	28.402	-25.598	54.000	AVERAGE
2		2437.060	0.509	33.290	33.799	-20.201	54.000	AVERAGE
3	*	4875.310	7.459	34.260	41.719	-12.281	54.000	AVERAGE

Note:

1. All Readings below 1GHz are Quasi-Peak, above are performed with peak and/or average measurements as necessary.
2. " * ", means this data is the worst emission level.
3. Measurement Level = Reading Level + Correct Factor



Engineer : Fred	
Site : EMC Lab AC 102	Time : 2010/06/30 - 16:48
Limit : FCC_15_03M_PK	Margin : 6
EUT : Wireless N FTTH Router	Probe : BBHA9120D(1-18GHz) - VERTICAL
Power : AC 120V/60Hz	Note : Mode 4: Transmit by 802.11n (40MHz) (An0 and An1) (2437MHz)

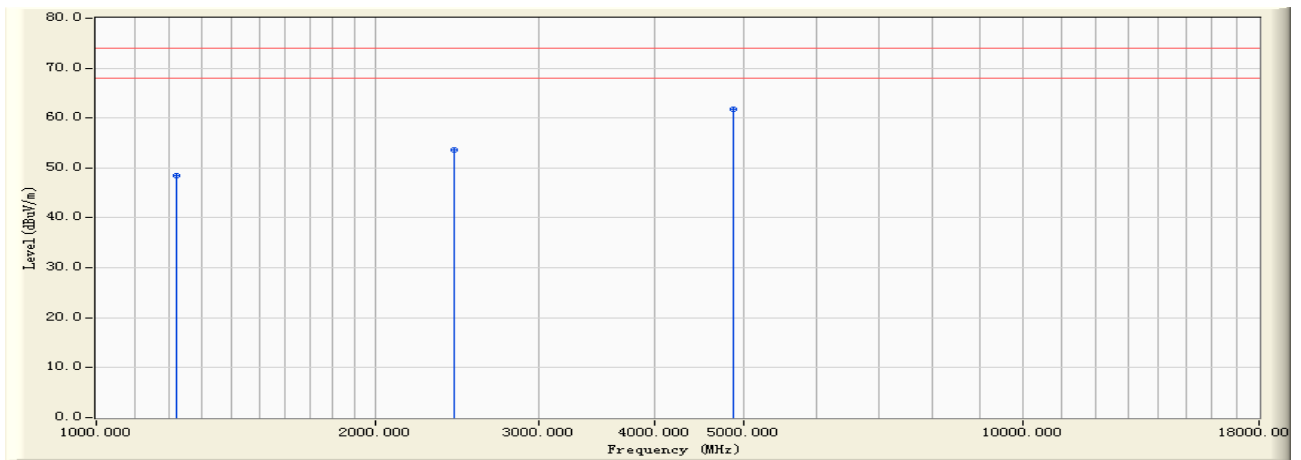

		Frequency (MHz)	Correct Factor (dB)	Reading Level (dBuV)	Measure Level (dBuV/m)	Margin (dB)	Limit (dBuV/m)	Detector Type
1		1219.350	-5.759	54.310	48.552	-25.448	74.000	PEAK
2		2437.160	0.510	53.190	53.700	-20.300	74.000	PEAK
3	*	4875.340	7.459	54.360	61.819	-12.181	74.000	PEAK

Note:

1. All Readings below 1GHz are Quasi-Peak, above are performed with peak and/or average measurements as necessary.
2. " * ", means this data is the worst emission level.
3. Measurement Level = Reading Level + Correct Factor



Engineer : Fred	
Site : EMC Lab AC 102	Time : 2010/06/30- 16:48
Limit : FCC_15_03M_AV	Margin : 6
EUT : Wireless N FTTH Router	Probe : BBHA9120D(1-18GHz) - VERTICAL
Power : AC 120V/60Hz	Note : Mode 4: Transmit by 802.11n (40MHz) (An0 and An1) (2437MHz)

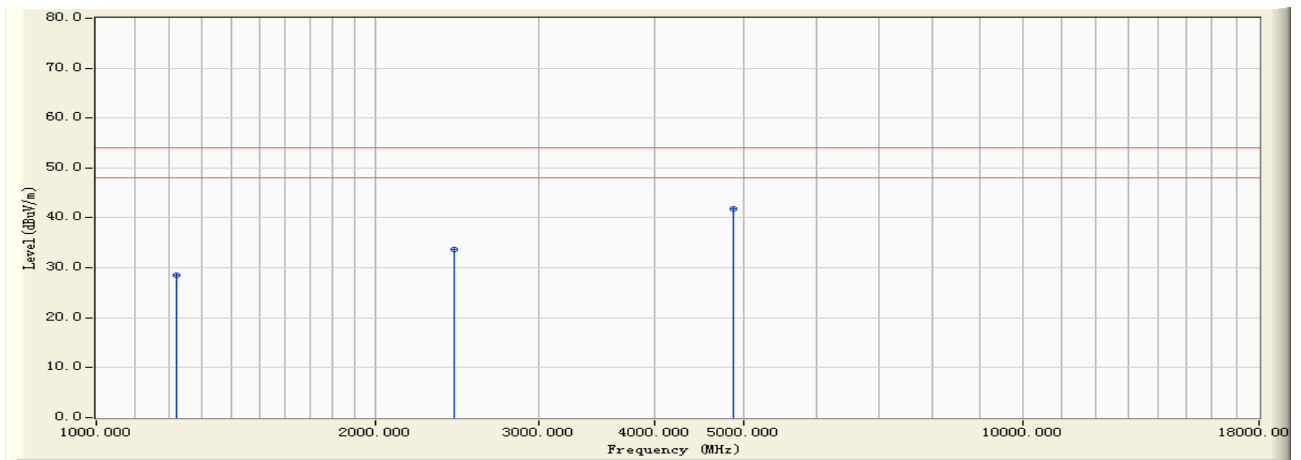

		Frequency (MHz)	Correct Factor (dB)	Reading Level (dBuV)	Measure Level (dBuV/m)	Margin (dB)	Limit (dBuV/m)	Detector Type
1		1219.350	-5.759	34.260	28.502	-25.498	54.000	AVERAGE
2		2437.160	0.510	33.160	33.670	-20.330	54.000	AVERAGE
3	*	4875.340	7.459	34.260	41.719	-12.281	54.000	AVERAGE

Note:

1. All Readings below 1GHz are Quasi-Peak, above are performed with peak and/or average measurements as necessary.
2. " * ", means this data is the worst emission level.
3. Measurement Level = Reading Level + Correct Factor



Engineer : Fred	
Site : EMC Lab AC 102	Time : 2010/06/30 - 16:50
Limit : FCC_15_03M_PK	Margin : 6
EUT : Wireless N FTTH Router	Probe : BBHA9120D(1-18GHz) - HORIZONTAL
Power : AC 120V/60Hz	Note : Mode 4: Transmit by 802.11n (40MHz) (An0 and An1) (2452MHz)

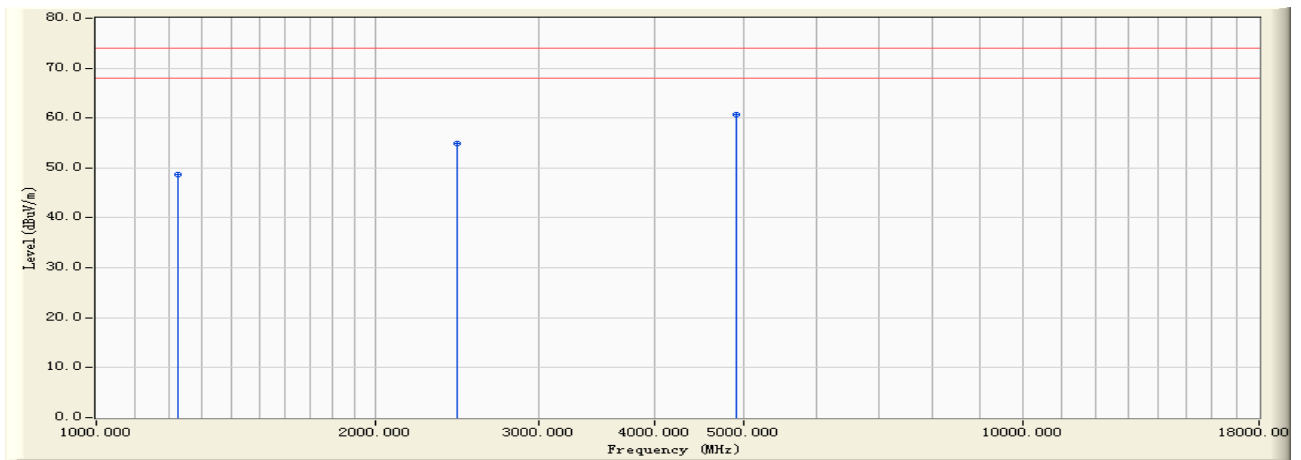

		Frequency (MHz)	Correct Factor (dB)	Reading Level (dBuV)	Measure Level (dBuV/m)	Margin (dB)	Limit (dBuV/m)	Detector Type
1		1227.350	-5.671	54.310	48.639	-25.361	74.000	PEAK
2		2452.360	0.560	54.340	54.901	-19.099	74.000	PEAK
3	*	4905.160	7.526	53.160	60.686	-13.314	74.000	PEAK

Note:

1. All Readings below 1GHz are Quasi-Peak, above are performed with peak and/or average measurements as necessary.
2. " * ", means this data is the worst emission level.
3. Measurement Level = Reading Level + Correct Factor



Engineer : Fred	
Site : EMC Lab AC 102	Time : 2010/06/30 - 16:50
Limit : FCC_15_03M_AV	Margin : 6
EUT : Wireless N FTTH Router	Probe : BBHA9120D(1-18GHz) - HORIZONTAL
Power : AC 120V/60Hz	Note : Mode 4: Transmit by 802.11n (40MHz) (An0 and An1) (2452MHz)

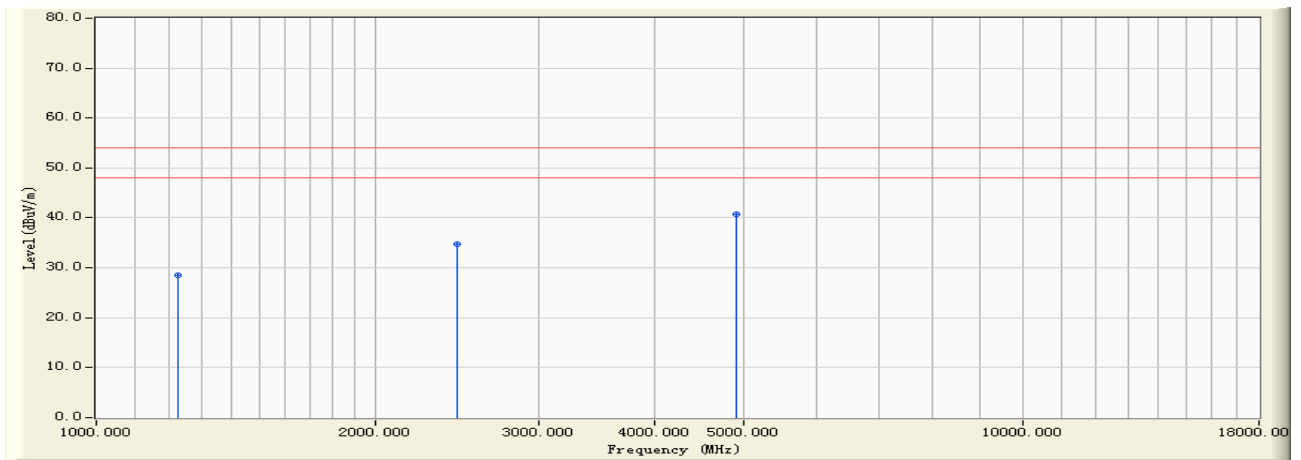

		Frequency (MHz)	Correct Factor (dB)	Reading Level (dBuV)	Measure Level (dBuV/m)	Margin (dB)	Limit (dBuV/m)	Detector Type
1		1227.350	-5.671	34.160	28.489	-25.511	54.000	AVERAGE
2		2452.360	0.560	34.160	34.721	-19.279	54.000	AVERAGE
3	*	4905.320	7.526	33.290	40.817	-13.183	54.000	AVERAGE

Note:

1. All Readings below 1GHz are Quasi-Peak, above are performed with peak and/or average measurements as necessary.
2. " * ", means this data is the worst emission level.
3. Measurement Level = Reading Level + Correct Factor



Engineer : Fred	
Site : EMC Lab AC 102	Time : 2010/06/30 - 16:52
Limit : FCC_15_03M_PK	Margin : 6
EUT : Wireless N FTTH Router	Probe : BBHA9120D(1-18GHz) - VERTICAL
Power : AC 120V/60Hz	Note : Mode 4: Transmit by 802.11n (40MHz) (An0 and An1) (2452MHz)

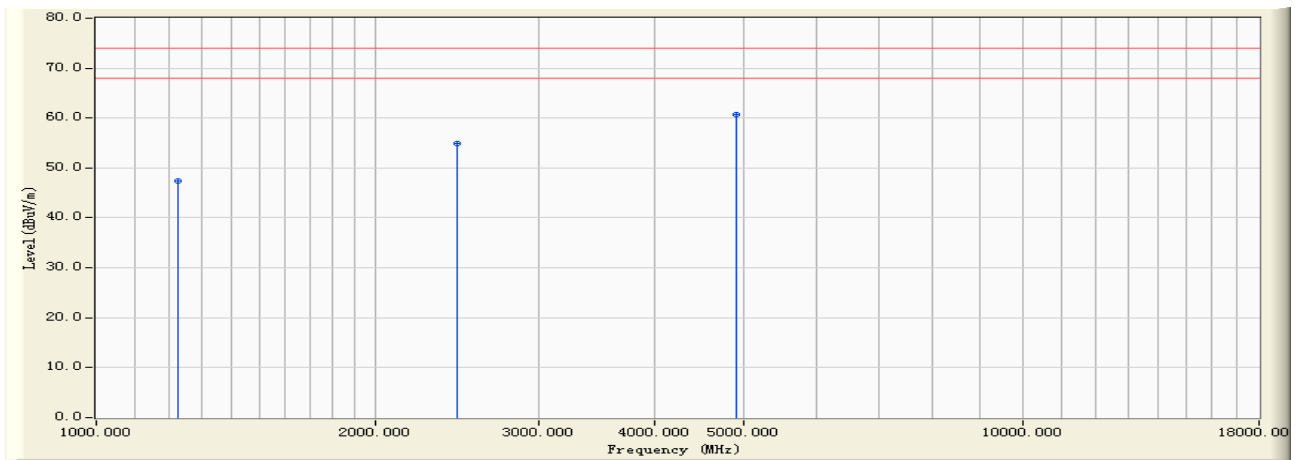

		Frequency (MHz)	Correct Factor (dB)	Reading Level (dBuV)	Measure Level (dBuV/m)	Margin (dB)	Limit (dBuV/m)	Detector Type
1		1227.340	-5.671	53.160	47.489	-26.511	74.000	PEAK
2		2452.040	0.560	54.360	54.920	-19.080	74.000	PEAK
3	*	4905.340	7.527	53.160	60.687	-13.313	74.000	PEAK

Note:

1. All Readings below 1GHz are Quasi-Peak, above are performed with peak and/or average measurements as necessary.
2. " * ", means this data is the worst emission level.
3. Measurement Level = Reading Level + Correct Factor



Engineer : Fred	
Site : EMC Lab AC 102	Time : 2010/06/30 - 16:52
Limit : FCC_15_03M_AV	Margin : 6
EUT : Wireless N FTTH Router	Probe : BBHA9120D(1-18GHz) - VERTICAL
Power : AC 120V/60Hz	Note : Mode 4: Transmit by 802.11n (40MHz) (An0 and An1) (2452MHz)

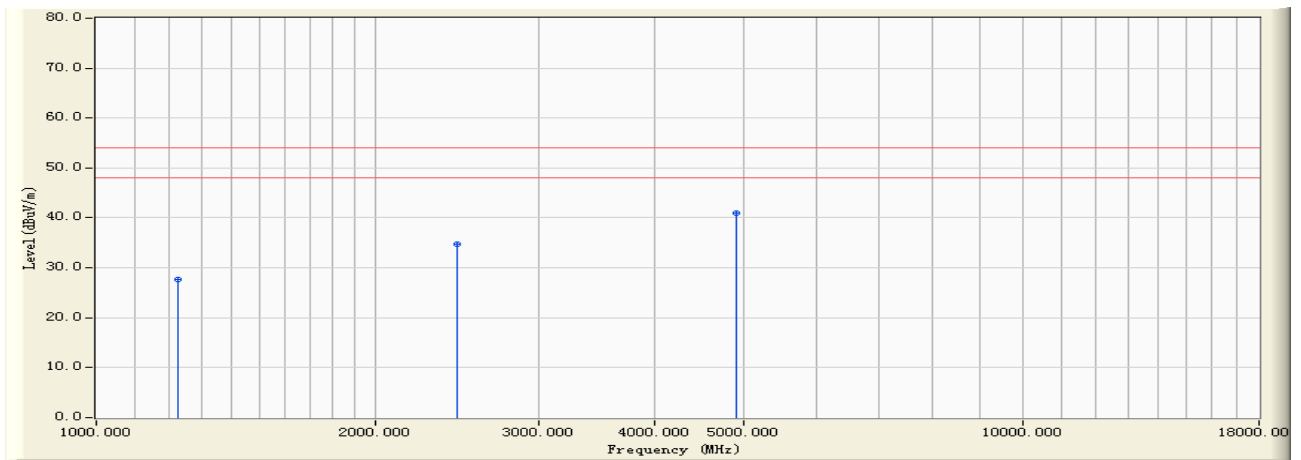

		Frequency (MHz)	Correct Factor (dB)	Reading Level (dBuV)	Measure Level (dBuV/m)	Margin (dB)	Limit (dBuV/m)	Detector Type
1		1227.340	-5.671	33.260	27.589	-26.411	54.000	AVERAGE
2		2452.040	0.560	34.160	34.720	-19.280	54.000	AVERAGE
3	*	4905.340	7.527	33.490	41.017	-12.983	54.000	AVERAGE

Note:

1. All Readings below 1GHz are Quasi-Peak, above are performed with peak and/or average measurements as necessary.
2. " * ", means this data is the worst emission level.
3. Measurement Level = Reading Level + Correct Factor

Test engineer: Fred Guo



5. Occupied Bandwidth

5.1. Test Limit

Systems using digital modulation techniques may operate in the 902 - 928 MHz, 2400 - 2483.5 MHz, and 5725- 5850 MHz band. The minimum 6 dB bandwidth shall be at least 500 kHz.

5.2. Test Procedures

The EUT was tested according to DTS test procedure of Oct 2002 KDB558074 for compliance to FCC 47CFR 15.247 requirements.

Set RBW = 100 kHz, Span greater than RBW.

5.3. Test Setup Layout

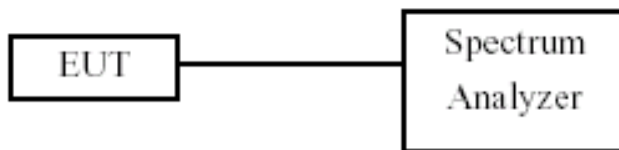

5.4. Measurement Equipment

Instrument/Ancillary	Model No.	Manufacturer	Serial No.	Calibration Date
Spectrum Analyzer	R&S	FSP40	100324	2009.11.02
Temperature/ Humidity Meter	Zhicheng	ZC1-11	CEP-TH-002	2009.10.19



5.5. Test Result and Data

Test Item	Occupied Bandwidth
Test Mode	Mode 1:Transmit by 802.11b (An0)
Test Date	2010-06-30

Channel No.	Frequency (MHz)	Measurement Level (kHz)	Required Limit (kHz)	Result
01	2412	8200	500	Pass
06	2437	8400	500	Pass
11	2462	8300	500	Pass

Channel 01 (2412MHz)

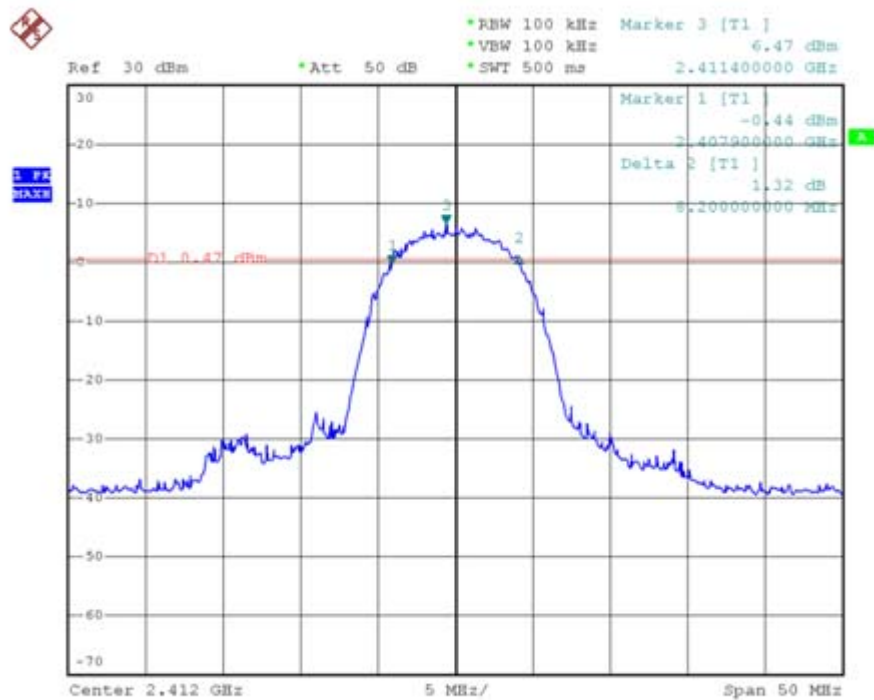



Channel 06 (2437MHz)

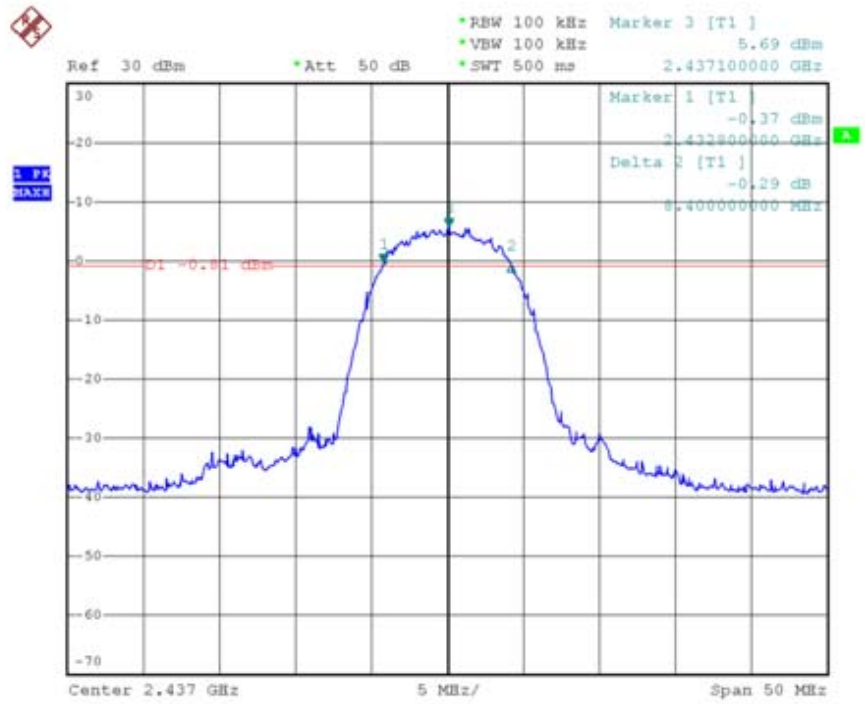

Channel 11 (2462MHz)

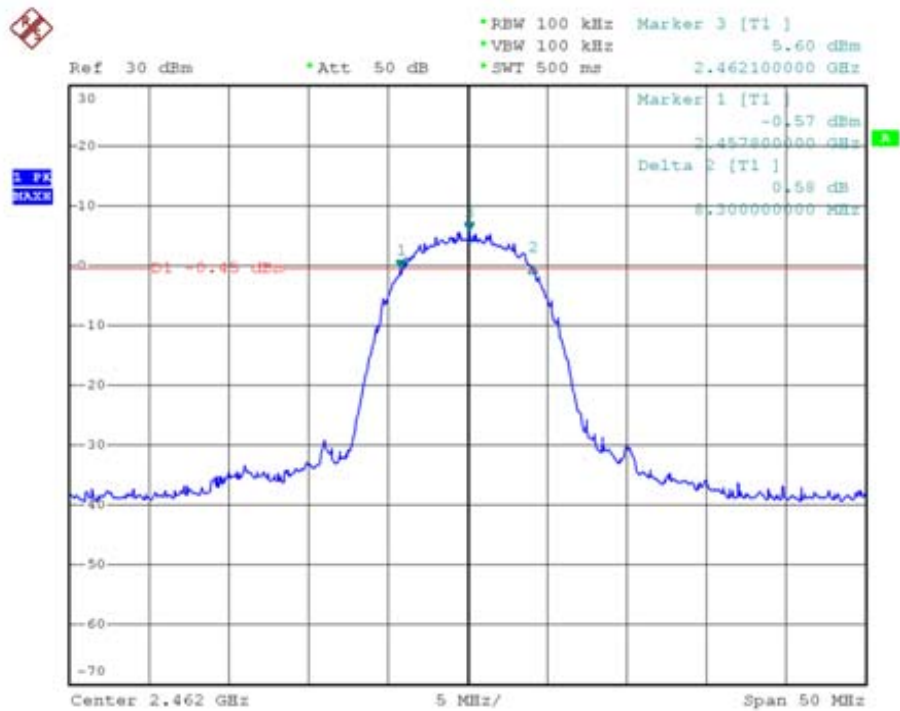



Test Item	Occupied Bandwidth
Test Mode	Mode 2:Transmit by 802.11g (An0)
Test Date	2010-06-30

Channel No.	Frequency (MHz)	Measurement Level (kHz)	Required Limit (kHz)	Result
01	2412	16000	500	Pass
06	2437	16300	500	Pass
11	2462	16300	500	Pass

Channel 01 (2412MHz)

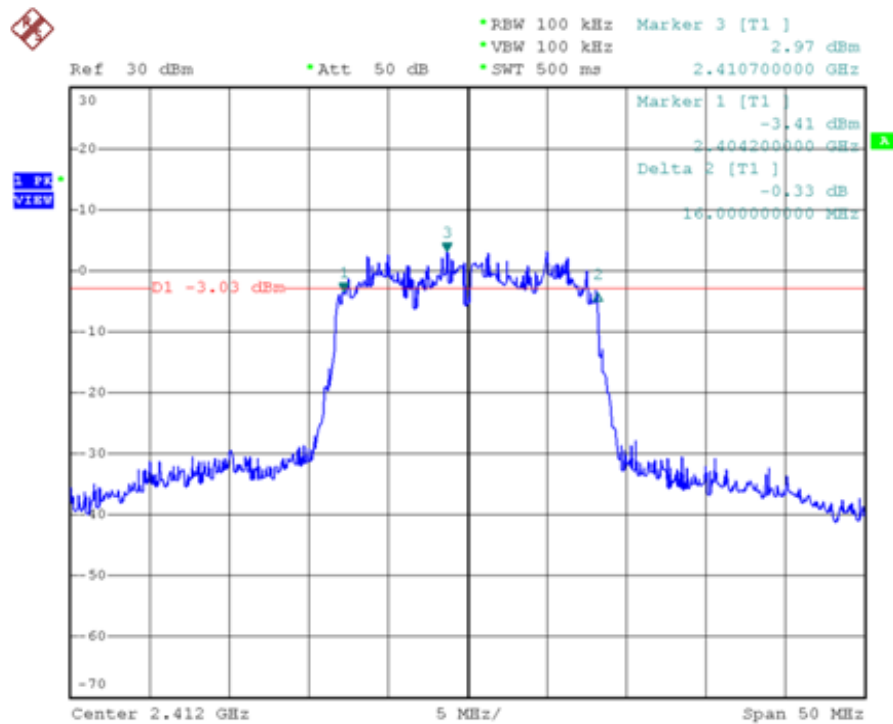



Channel 06 (2437MHz)

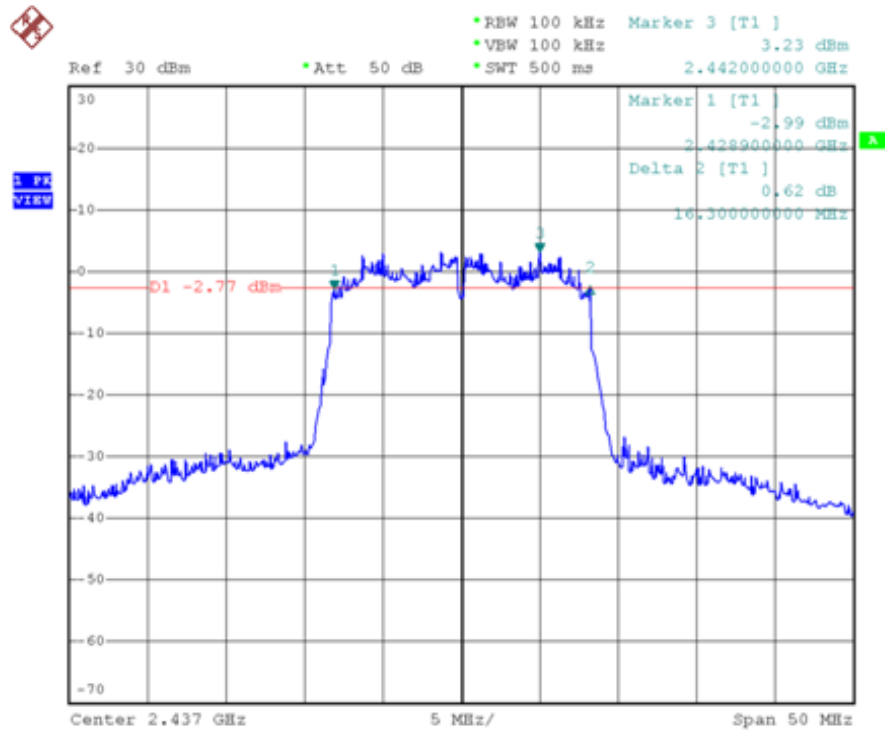

Channel 11 (2462MHz)

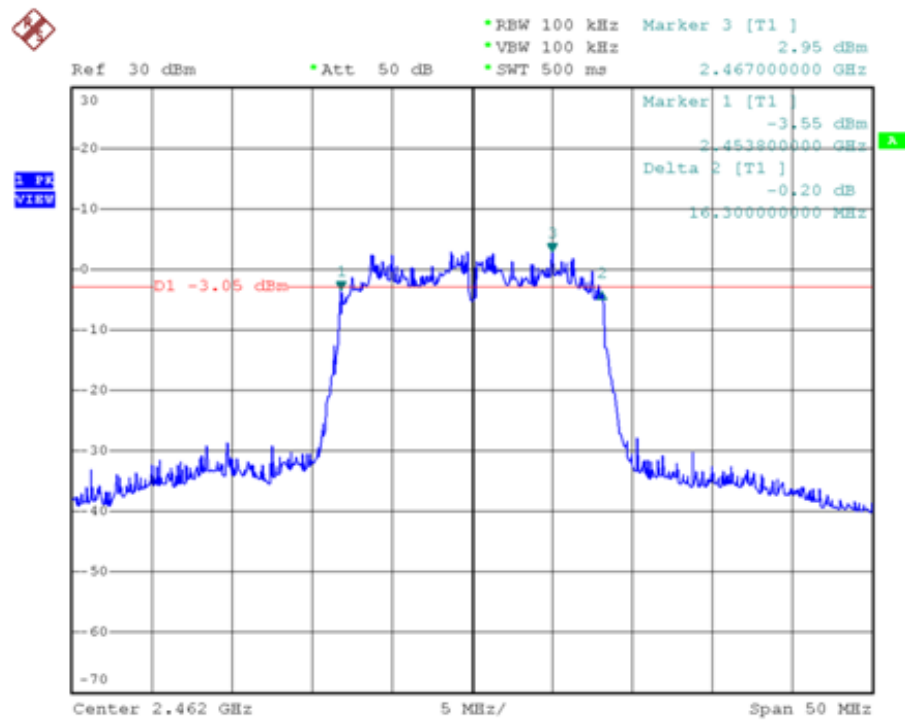



Test Item	Occupied Bandwidth
Test Mode	Mode 3: Transmit by 802.11n (20MHz) (An0)
Test Date	2010-06-30

Channel No.	Frequency (MHz)	Measurement Level (kHz)	Required Limit (kHz)	Result
01	2412	17600	500	Pass
06	2437	17500	500	Pass
11	2462	17500	500	Pass

Channel 01 (2412MHz)

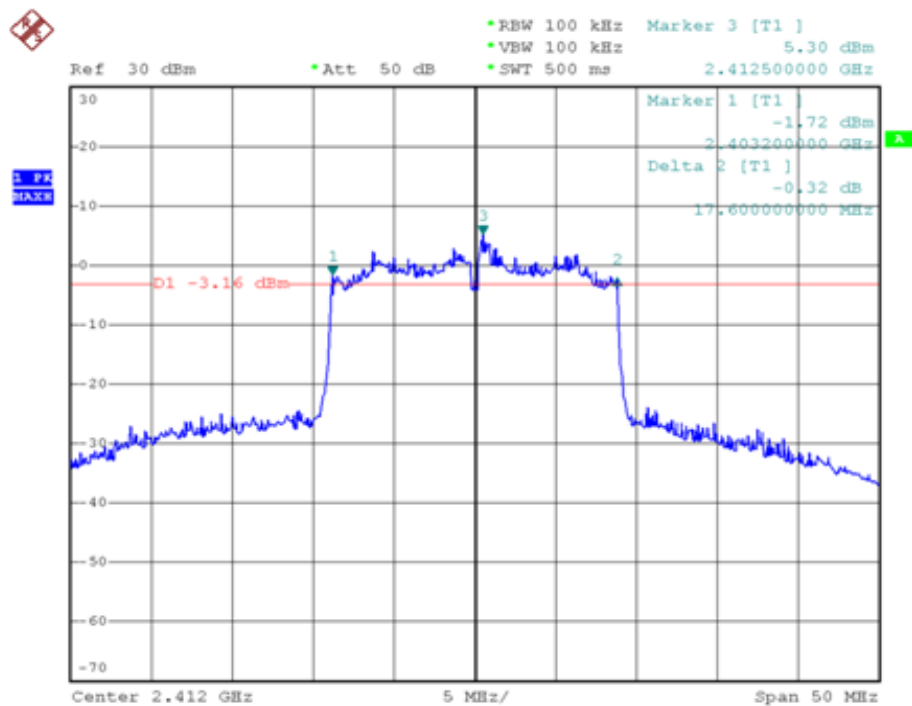



Channel 06 (2437MHz)

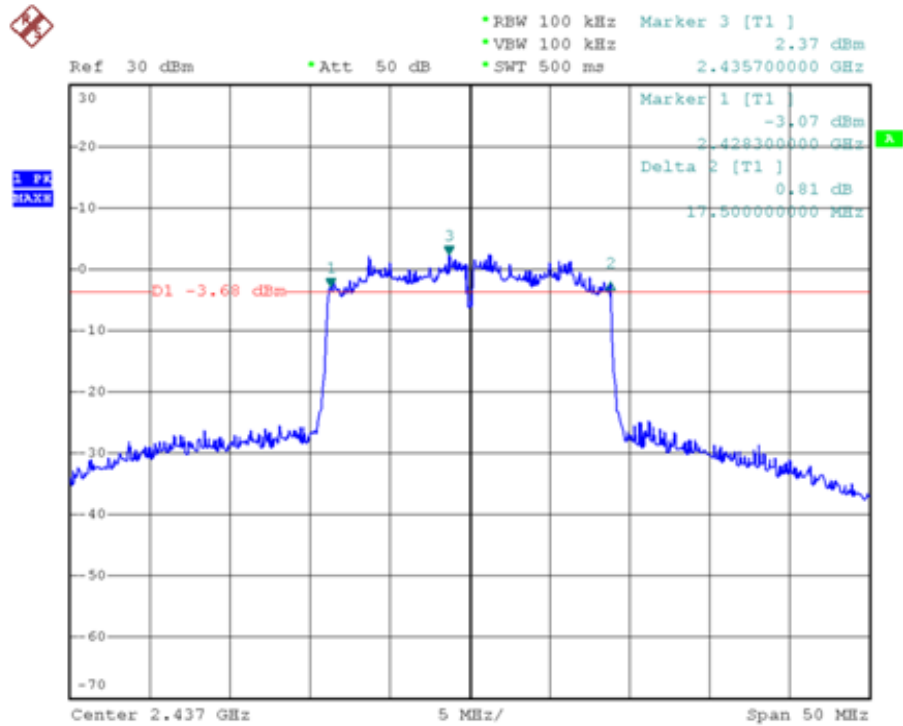

Channel 11 (2462MHz)

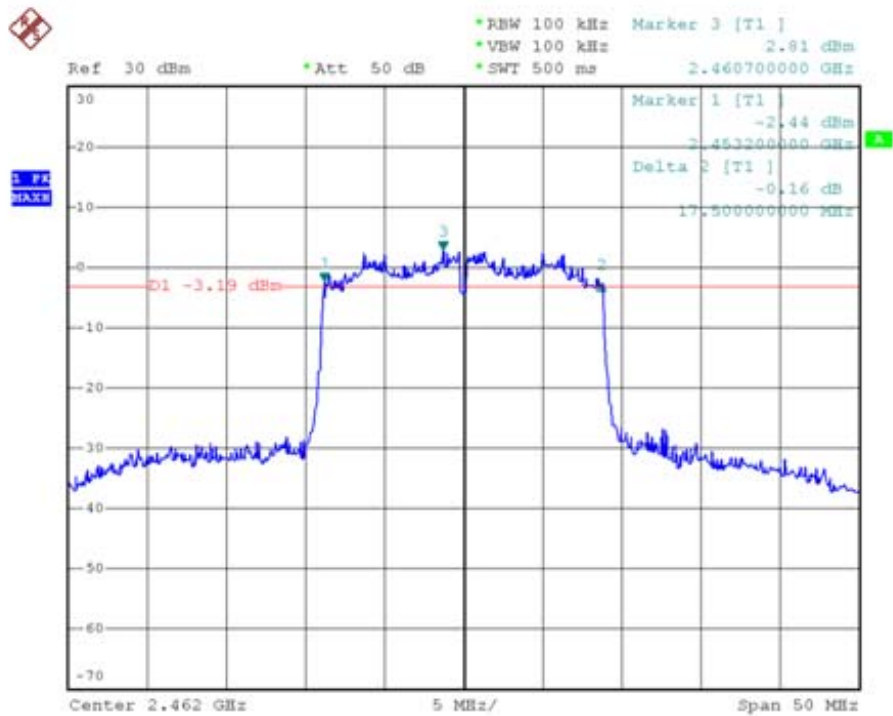



Test Item	Occupied Bandwidth
Test Mode	Mode 3: Transmit by 802.11n (20MHz) (An1)
Test Date	2010-06-30

Channel No.	Frequency (MHz)	Measurement Level (kHz)	Required Limit (kHz)	Result
01	2412	17500	500	Pass
06	2437	17600	500	Pass
11	2462	17600	500	Pass

Channel 01 (2412MHz)

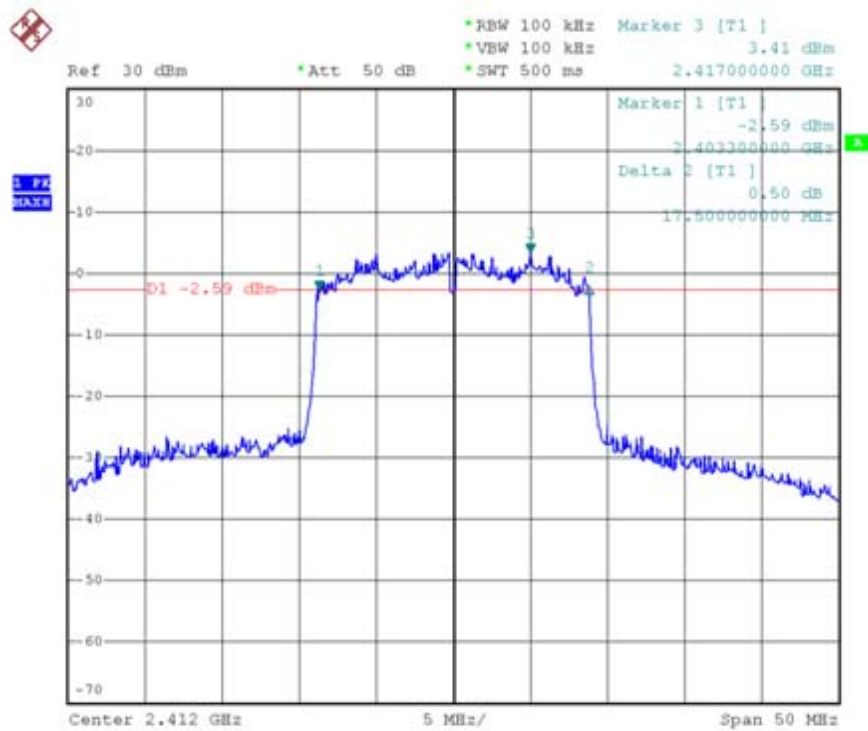



Channel 06 (2437MHz)

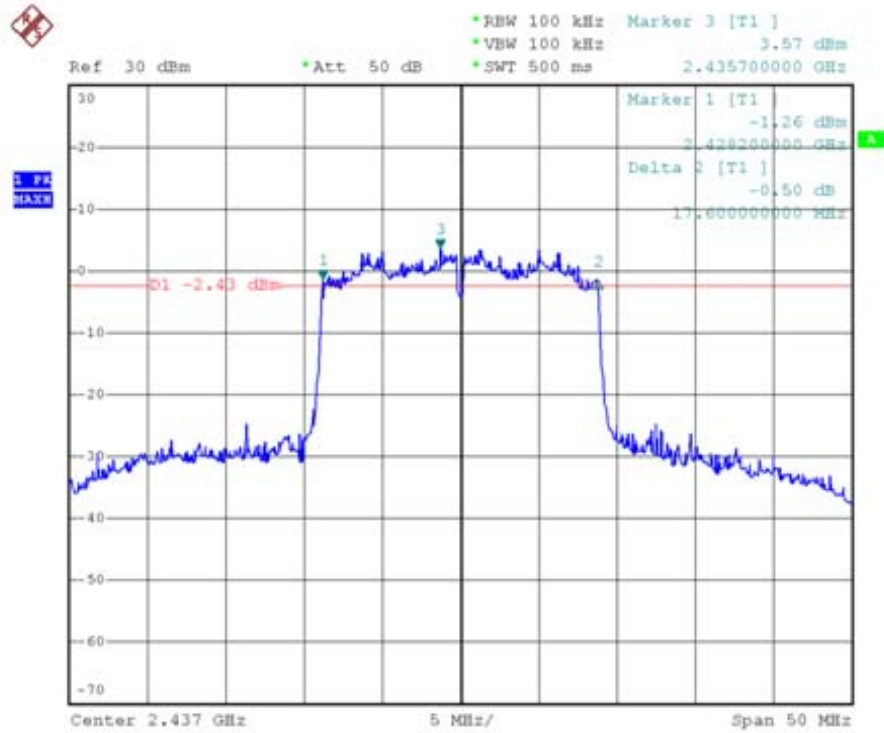

Channel 11 (2462MHz)

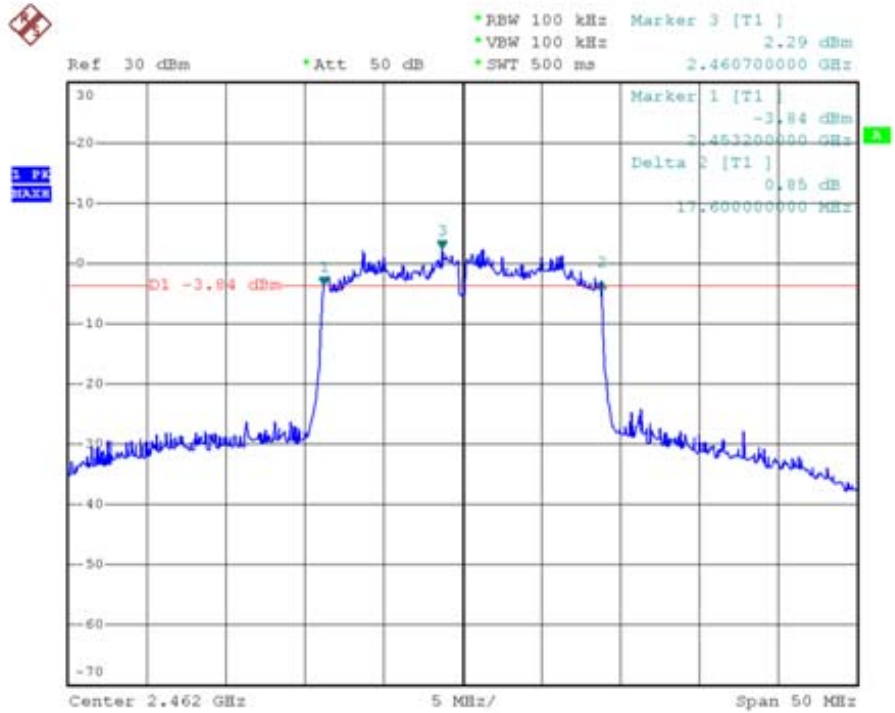



Test Item	Occupied Bandwidth
Test Mode	Mode 4: Transmit by 802.11n (40MHz) (An0)
Test Date	2010-06-30

Channel No.	Frequency (MHz)	Measurement Level (kHz)	Required Limit (kHz)	Result
03	2422	36200	500	Pass
06	2437	36400	500	Pass
09	2452	36400	500	Pass

Channel 03 (2422MHz)

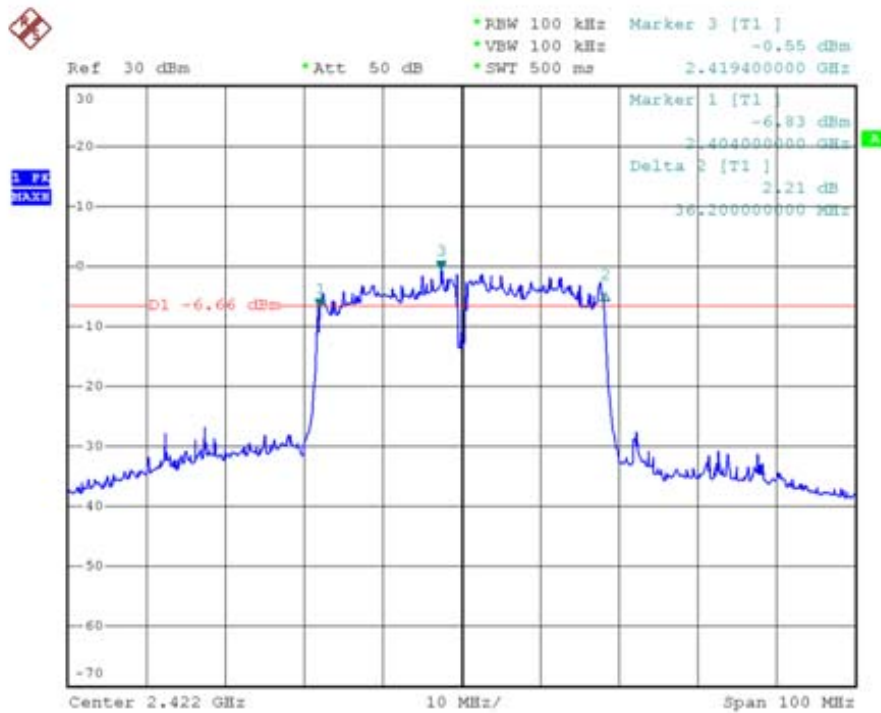



Channel 06 (2437MHz)

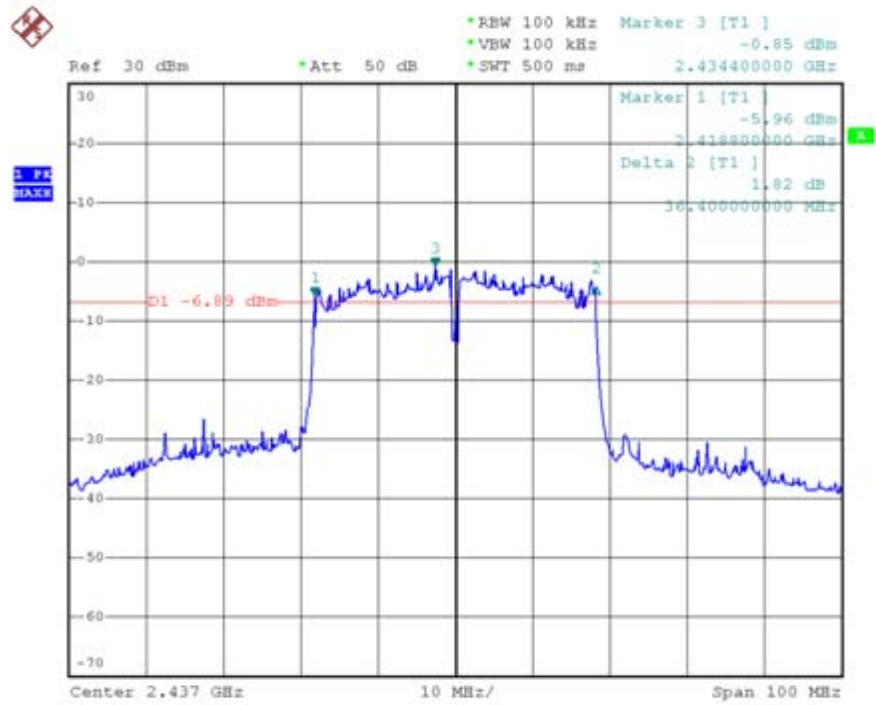

Channel 09 (2452MHz)

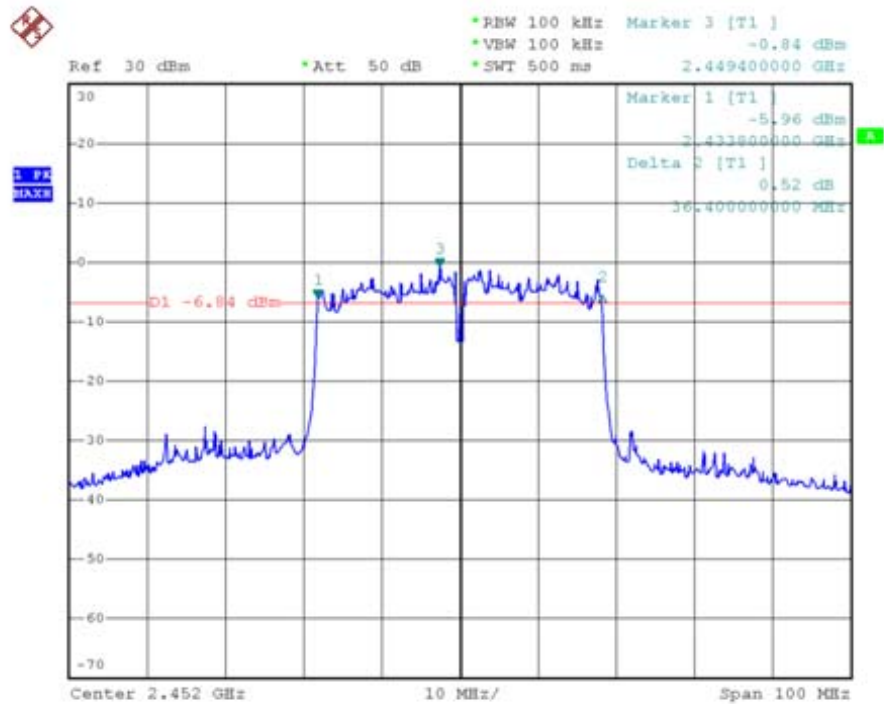



Channel 06 (2437MHz)

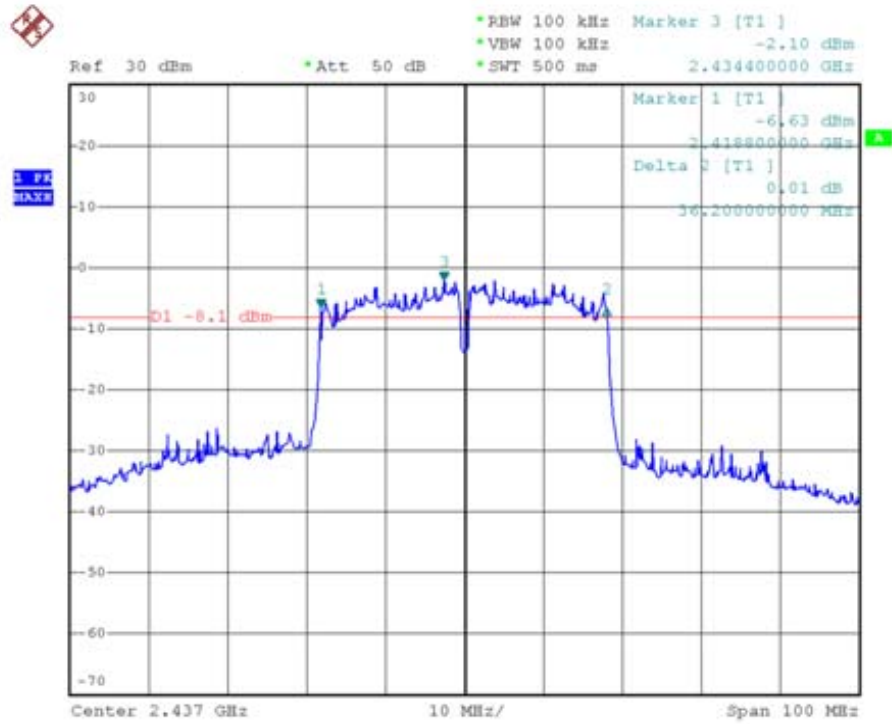

Channel 09 (2452MHz)

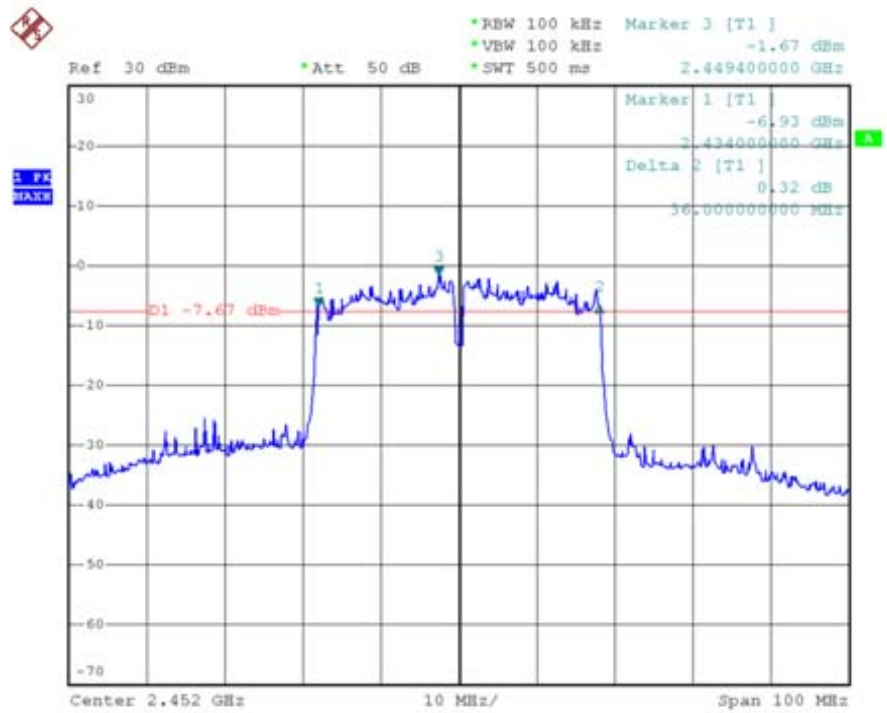



6. Maximum Peak Output Power

6.1. Test Limit

The maximum peak power shall be less 1Watt (30dBm).

The conducted output power limit is based on the use of antennas with directional gains that do not exceed 6 dBi. Except as shown in paragraph (c) of standard FCC part 15.247, if transmitting antennas of directional gain greater than 6 dBi are used, the conducted output power of the intentional radiator is reduced by 1dB for every 3dB that the directional gain of the antenna exceeds 6 dBi.

6.2. Test Procedure

The EUT was tested according to DTS test procedure of Oct 2002 KDB558074 for compliance to FCC 47CFR 15.247 requirements.

In the following, "T" is the transmission pulse duration over which the transmitter is on and transmitting at its maximum power control level. Measurements are performed with a spectrum analyzer. Three methods are provided to accommodate measurement limitations of the spectrum analyzer depending on signal parameters. Set resolution bandwidth (RBW) = 1 MHz. Set span to encompass the entire emission bandwidth (EBW) of the signal. Use automatic setting for analyzer sweep time (except in Method #2). Check the sweep time to determine which procedure to use.

As "T" \geq sweep time, the test procedure will be used as following:

1. Set span to encompass the entire emission bandwidth (EBW) of the signal.
2. Set RBW = 1 MHz.
3. Set VBW \geq 3 MHz.
4. Use sample detector mode if bin width (i.e., span/number of points in spectrum display) < 0.5 RBW. Otherwise use peak detector mode.
5. Use a video trigger with the trigger level set to enable triggering only on full power pulses. Transmitter must operate at full control power for entire sweep of every sweep. If the device transmits continuously, with no off intervals or reduced power intervals, the trigger may be set to "free run".
6. Trace average 100 traces in power averaging mode.
7. Compute power by integrating the spectrum across the 26 dB EBW of the signal. The integration can be performed using the spectrum analyzer's band power measurement function with band limits set equal to the EBW band edges or by summing power levels in each 1 MHz band in linear power terms. The 1 MHz band power levels to



be summed can be obtained by averaging, in linear power terms, power levels in each frequency bin across the 1 MHz.

6.3. Test Setup Layout

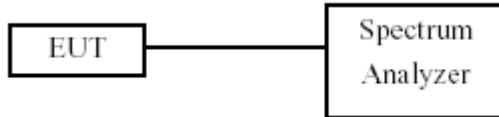

6.4. Measurement Equipment

Instrument/Ancillary	Model No.	Manufacturer	Serial No.	Calibration Date
Spectrum Analyzer	R&S	FSP40	100324	2009.11.02
Temperature/ Humidity Meter	Zhicheng	ZC1-11	CEP-TH-002	2009.10.19



6.5. Test Result and Data

Test Item	Maximum Peak Output Power
Test Mode	Mode 1: Transmit by 802.11b (An0)
Test Date	2010-06-30

Channel No.	Frequency (MHz)	Measurement (dBm)	Required Limit (dBm)	Result
01	2412	20.81	30 dBm	Pass
06	2437	20.72	30 dBm	Pass
11	2462	20.35	30 dBm	Pass

Channel 01 (2412MHz)

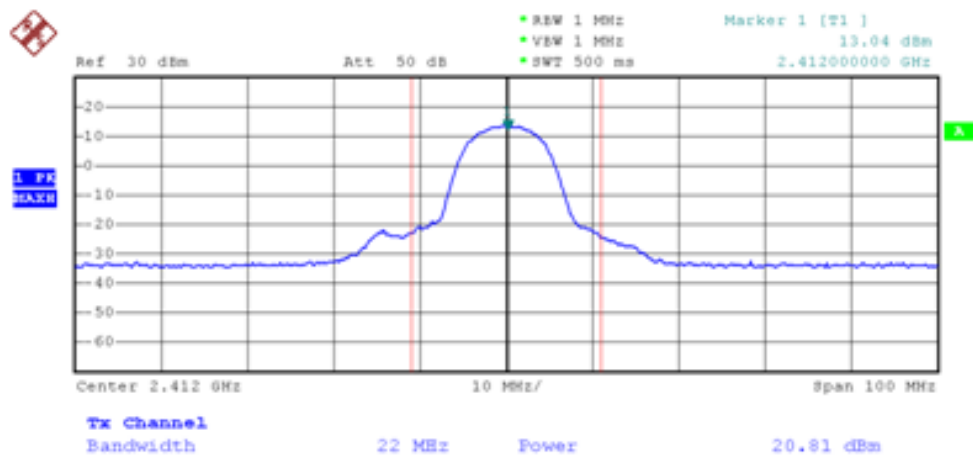



Channel 06 (2437MHz)

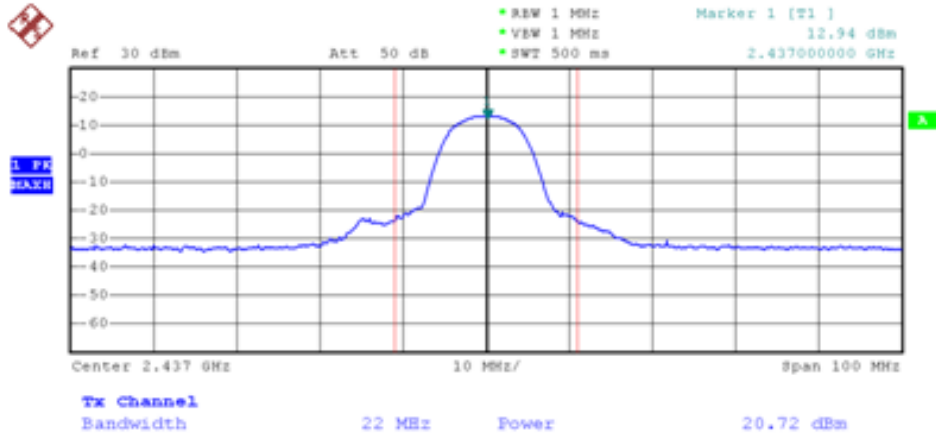

Channel 11 (2462MHz)

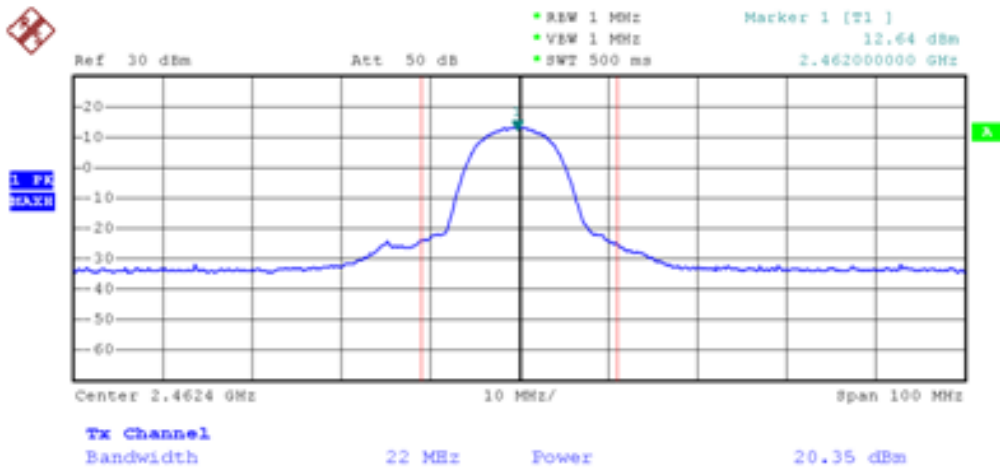



Test Item	Maximum Peak Output Power
Test Mode	Mode 2: Transmit by 802.11g (An0)
Test Date	2010-06-30

Channel No.	Frequency (MHz)	Measurement (dBm)	Required Limit (dBm)	Result
01	2412	21.76	30 dBm	Pass
06	2437	22.28	30 dBm	Pass
11	2462	21.63	30 dBm	Pass

Channel 01 (2412MHz)

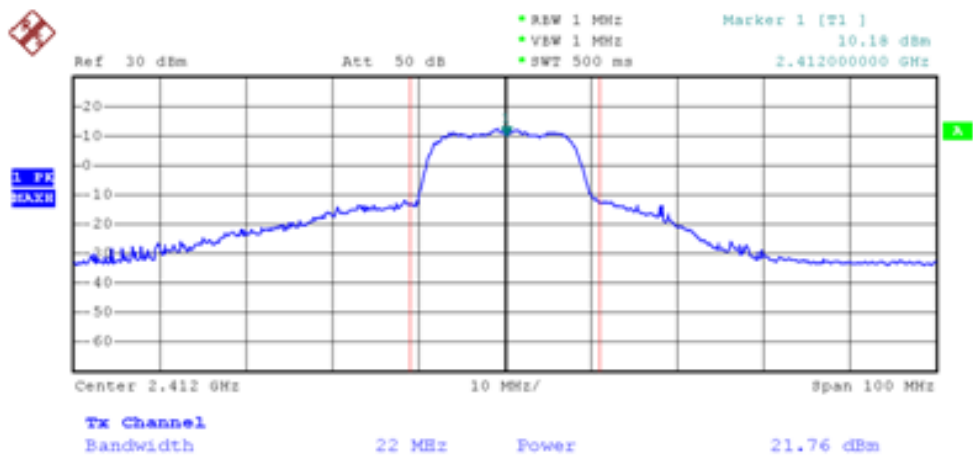

Channel 06 (2437MHz)

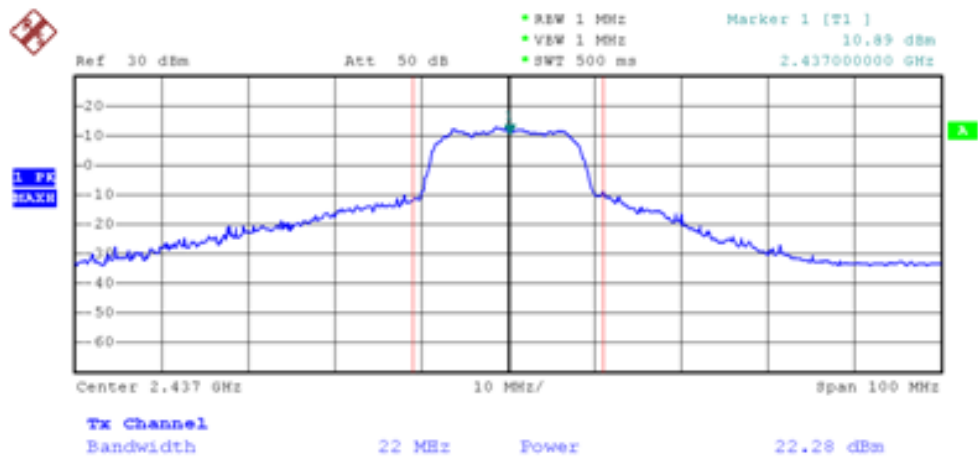



Channel 11 (2462MHz)

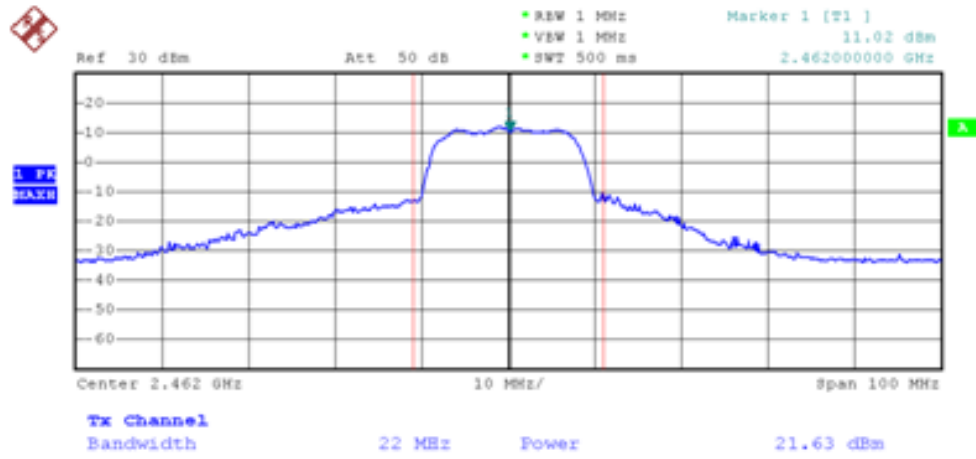



Test Item	Maximum Peak Output Power
Test Mode	Mode 3: Transmit by 802.11n (20MHz) (An0 and An1)
Test Date	2010-06-30

An0:

Channel No.	Frequency (MHz)	Measurement (dBm)	Required Limit (dBm)	Result
01	2412	23.11	30 dBm	Pass
06	2437	22.79	30 dBm	Pass
11	2462	22.27	30 dBm	Pass

An1:

Channel No.	Frequency (MHz)	Measurement (dBm)	Required Limit (dBm)	Result
01	2412	21.81	30 dBm	Pass
06	2437	22.02	30 dBm	Pass
11	2462	21.50	30 dBm	Pass

An0 and An1:

Channel No.	Frequency (MHz)	Measurement (dBm)	Required Limit (dBm)	Result
01	2412	25.52	30 dBm	Pass
06	2437	25.43	30 dBm	Pass
11	2462	24.91	30 dBm	Pass



Channel 01 (2412MHz) (An0)

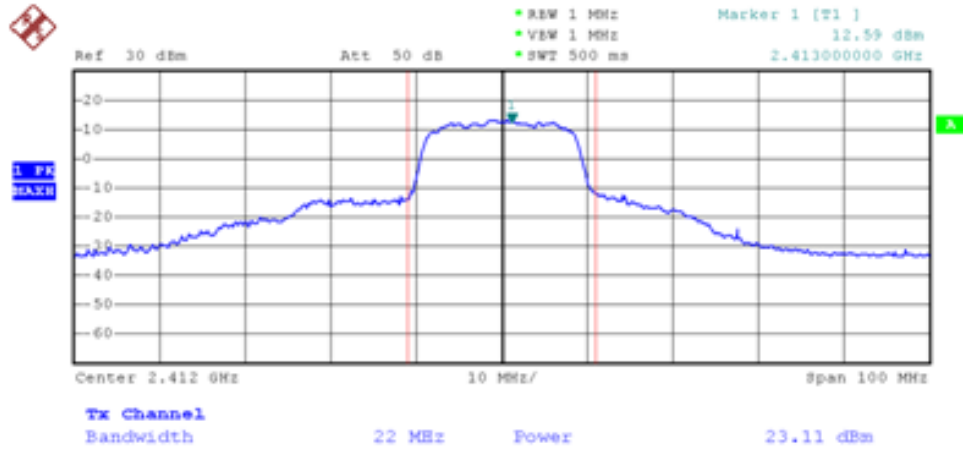

Channel 01 (2412MHz) (An1)

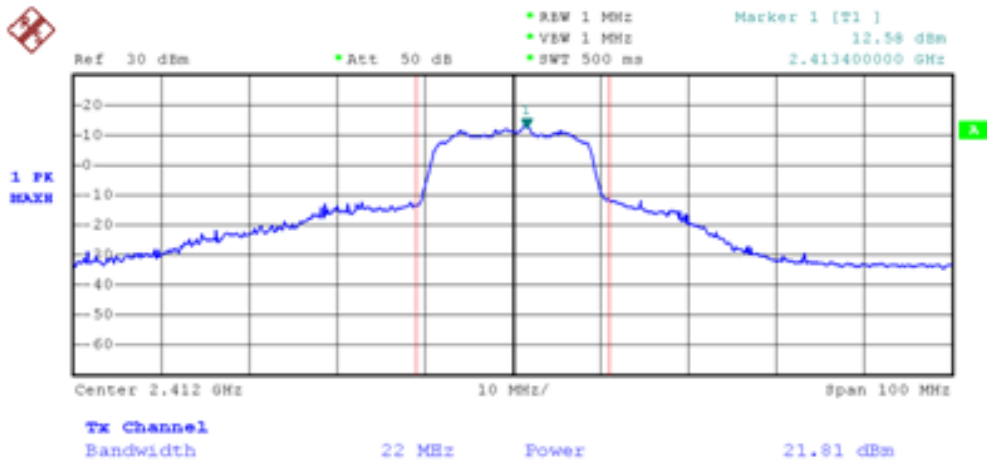



Channel 06 (2437MHz) (An0)

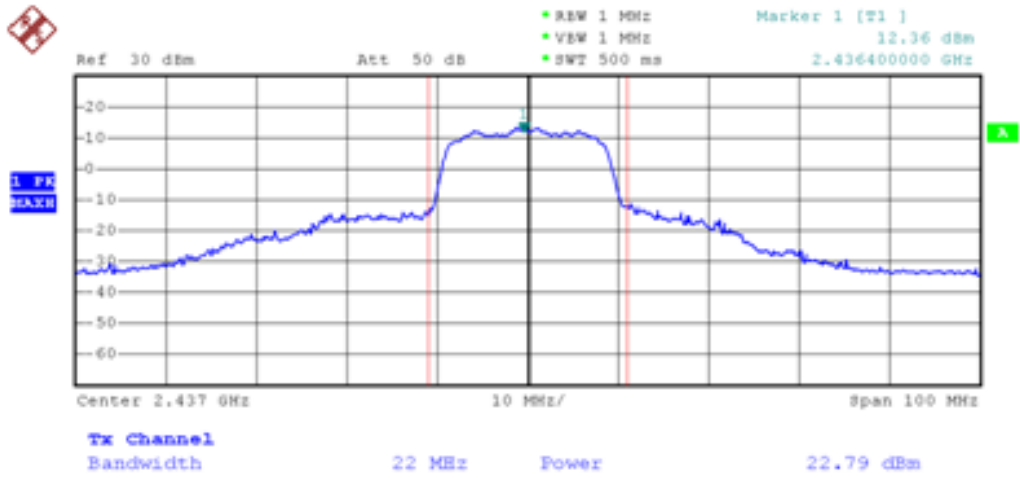

Channel 06 (2437MHz) (An1)

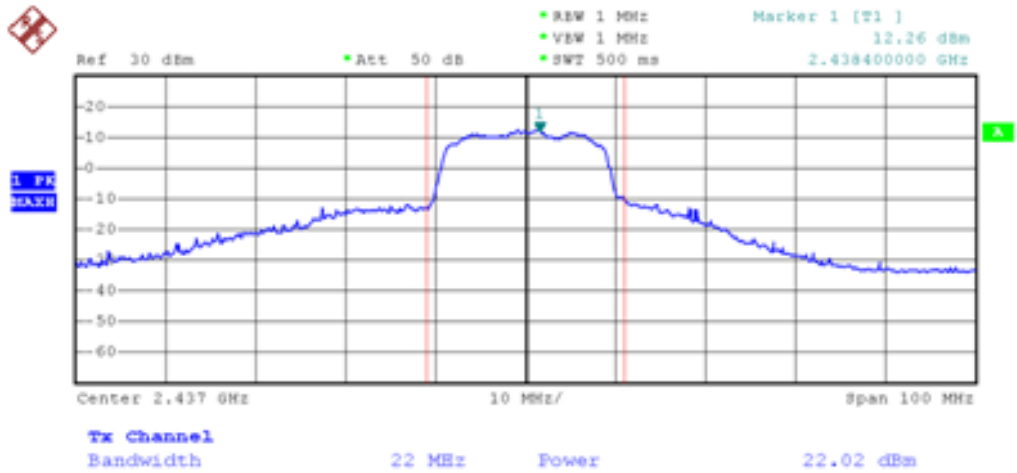



Channel 11 (2462MHz) (An0)

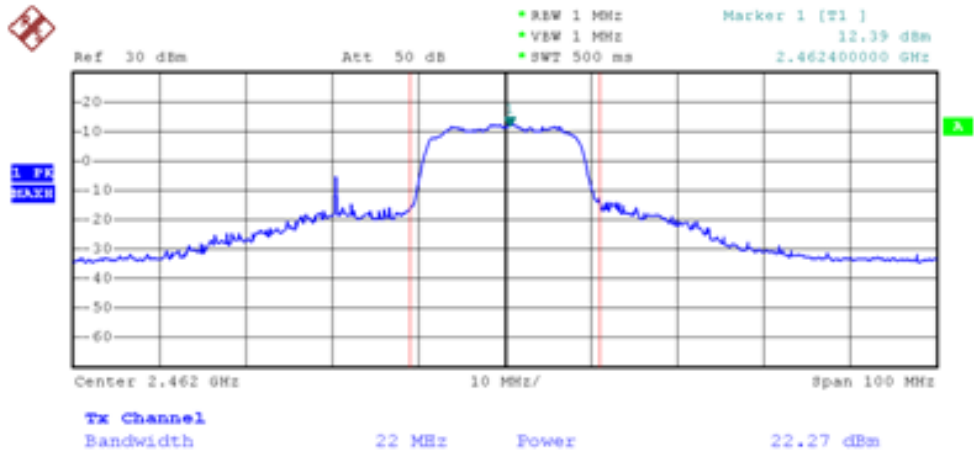

Channel 11 (2462MHz) (An1)

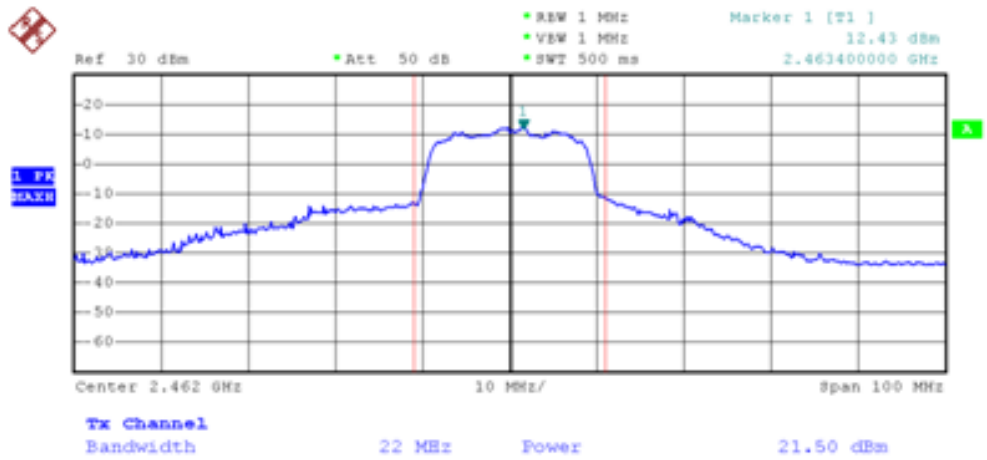



Test Item	Maximum Peak Output Power
Test Mode	Mode 4: Transmit by 802.11 n (40MHz) (An0 and An1)
Test Date	2010-06-30

An0:

Channel No.	Frequency (MHz)	Measurement (dBm)	Required Limit (dBm)	Result
03	2422	20.26	30 dBm	Pass
06	2437	19.95	30 dBm	Pass
09	2452	19.74	30 dBm	Pass

An1:

Channel No.	Frequency (MHz)	Measurement (dBm)	Required Limit (dBm)	Result
03	2422	21.37	30 dBm	Pass
06	2437	21.24	30 dBm	Pass
09	2452	21.04	30 dBm	Pass

An0 and An1:

Channel No.	Frequency (MHz)	Measurement (dBm)	Required Limit (dBm)	Result
03	2422	23.86	30 dBm	Pass
06	2437	23.65	30 dBm	Pass
09	2452	23.45	30 dBm	Pass



Channel 03 (2422MHz) (An0)

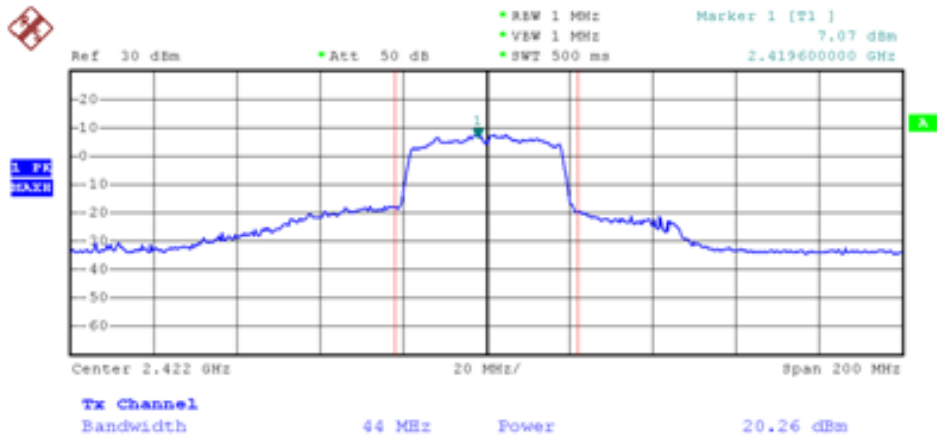

Channel 03 (2422MHz) (An1)

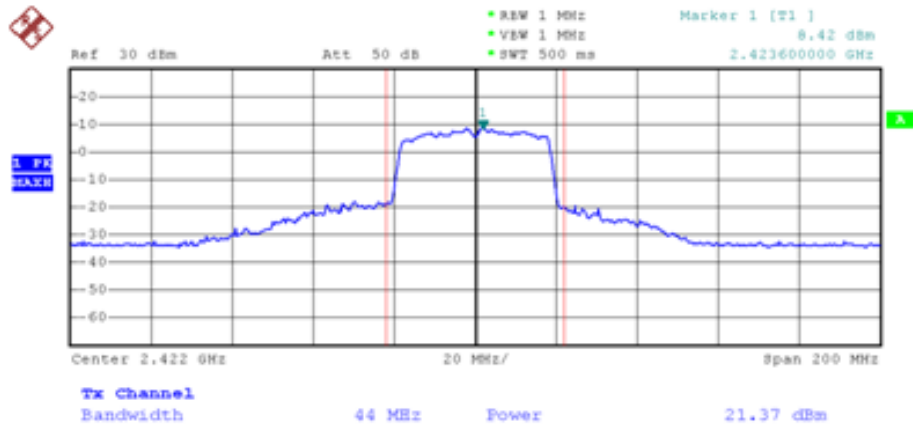



Channel 06 (2437MHz) (An0)

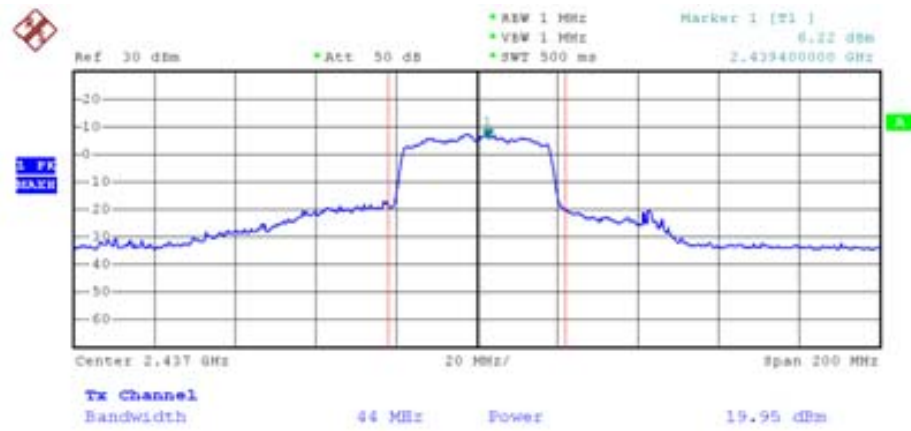

Channel 06 (2437MHz) (An1)

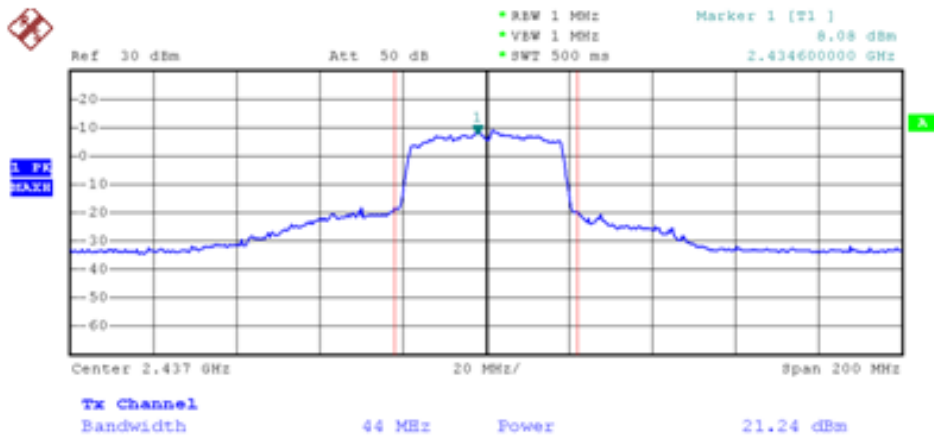



Channel 09 (2452MHz) (An0)

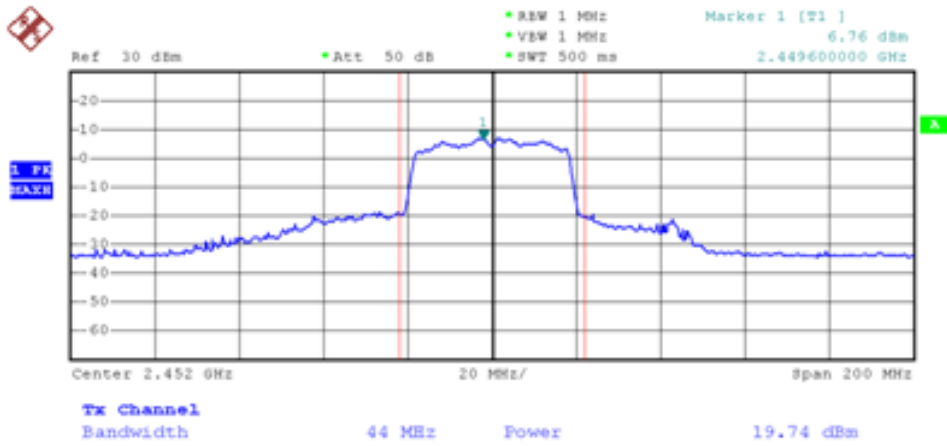

Channel 09 (2452MHz) (An1)

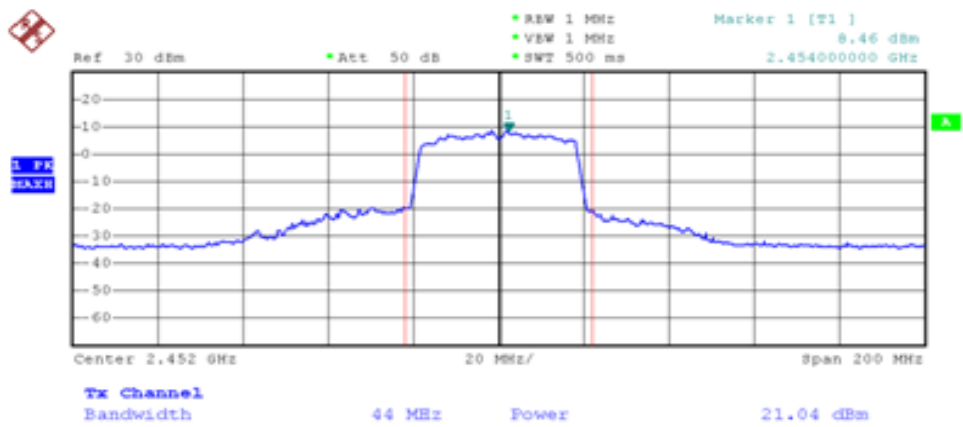



7. Band Edges

7.1. Test Limit

For RF Conducted requirement:

20 dB bandwidth of the emission is contained within the operation frequency band.

For RF Radiated requirement:

Radiated emissions which fall in the restricted bands, as defined in Section 15.205(a) of FCC part 15, must also comply with the radiated emission limits specified in Section 15.209(a) (see Section 15.205(c)).

7.2. Test Procedure

For RF Conducted Measurement:

The EUT was tested according to DTS test procedure of Oct 2002 KDB558074 for compliance to FCC 47CFR 15.247 requirements.

Set RBW = 100 kHz, Span greater than RBW.

For RF Radiated Measurement:

The EUT was setup according to ANSI C63.4, 2003 and tested according to DTS test procedure of Oct 2002 KDB558074 for compliance to FCC 47CFR 15.247 requirements.

The EUT is placed on a turn table which is 0.8 meter above ground plane. The antenna to EUT distance is 3 meters. The EUT is configured in accordance with ANSI C63.4. The EUT is set to transmit in a continuous mode.

For measurements below 1GHz the resolution bandwidth is set to 100kHz for peak detection measurements or 120kHz for quasi-peak detection measurements. Peak detection is used unless otherwise noted as quasi-peak.

For measurements above 1GHz the resolution bandwidth is set to 1MHz, then the video bandwidth is set to 1MHz for peak measurements and 10Hz for average measurements.

The spectrum from 30MHz to 26GHz is investigated with the transmitter set to the lowest, middle and highest channels in the 2.4GHz band.

The frequency range of interest is monitored at a fixed antenna height and EUT azimuth. The EUT is rotated through 360 degrees to maximize emissions received. The antenna is scanned from 1 to 4 meters above the ground plane to further maximize the emission. Measurements are Made with the antenna polarized in both the vertical and the horizontal positions.



7.3. Test Setup Layout

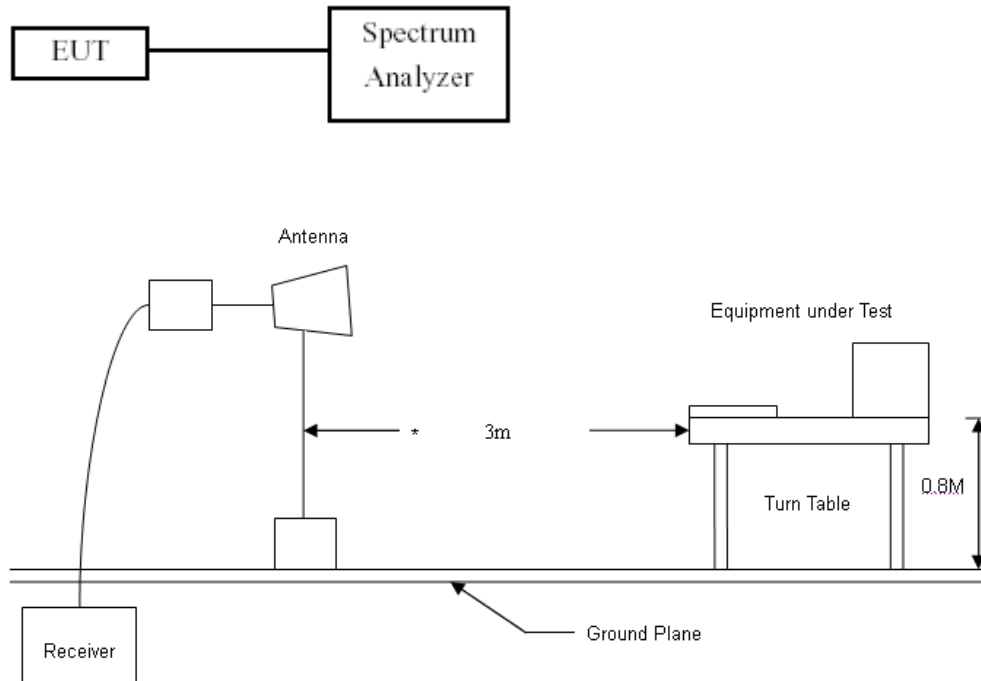

7.4. Measurement Equipment

Instrument/Ancillary	Model No.	Manufacturer	Serial No.	Calibration Date
Spectrum Analyzer	R&S	FSP40	100324	2009.11.02
H64 Amplifier	HP	8447F	3113A05582	2009.12.01
Preamplifier	Agilent	8449B	ED-HE-EMI-077	2010.02.10
Broad-Band Horn Antenna	Schwarzbeck	BBHA9120D	100363	2009.11.10
Temperature/ Humidity Meter	Zhicheng	ZC1-11	CEP-TH-002	2009.10.19



7.5. Test Result and Data

Engineer : Fred	
Site : EMC Lab AC 102	Time : 2010/06/29 - 14:02
Limit : FCC_15_03M_PK	Margin : 6
EUT : Wireless N FTTH Router	Probe : BBHA9120D(1-18GHz) - HORIZONTAL
Power : AC120V/60Hz	Note : Mode 1: Transmit by 802.11b (An0) (2412MHz)

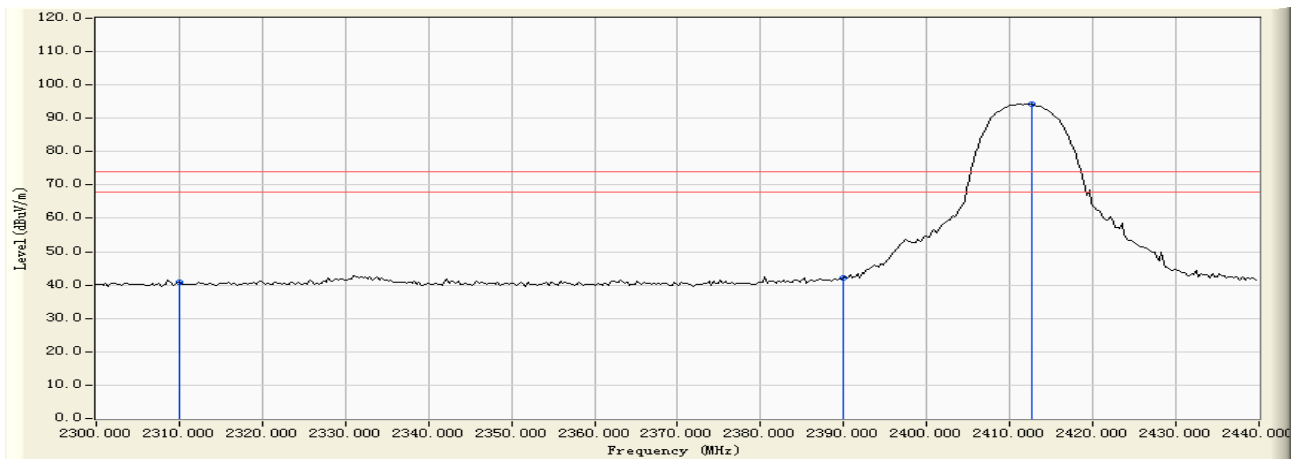

		Frequency (MHz)	Correct Factor (dB)	Reading Level (dBuV)	Measure Level (dBuV/m)	Margin (dB)	Limit (dBuV/m)	Detector Type
1		2310.000	-10.012	50.980	40.968	-33.032	74.000	PEAK
2		2390.000	-10.041	52.209	42.169	-31.831	74.000	PEAK
3	*	2412.615	-10.017	104.389	94.373	N/A	N/A	PEAK

Note:

1. All Readings below 1GHz are Quasi-Peak, above are performed with peak and/or average measurements as necessary.
2. Measurement Level = Reading Level + Correct Factor



Engineer : Fred	
Site : EMC Lab AC 102	Time : 2010/06/29 - 13:54
Limit : FCC_15_03M_PK	Margin : 6
EUT : Wireless N FTTH Router	Probe : BBHA9120D(1-18GHz) - VERTICAL
Power : AC120V/60Hz	Note : Mode 1: Transmit by 802.11b (An0) (2412MHz)

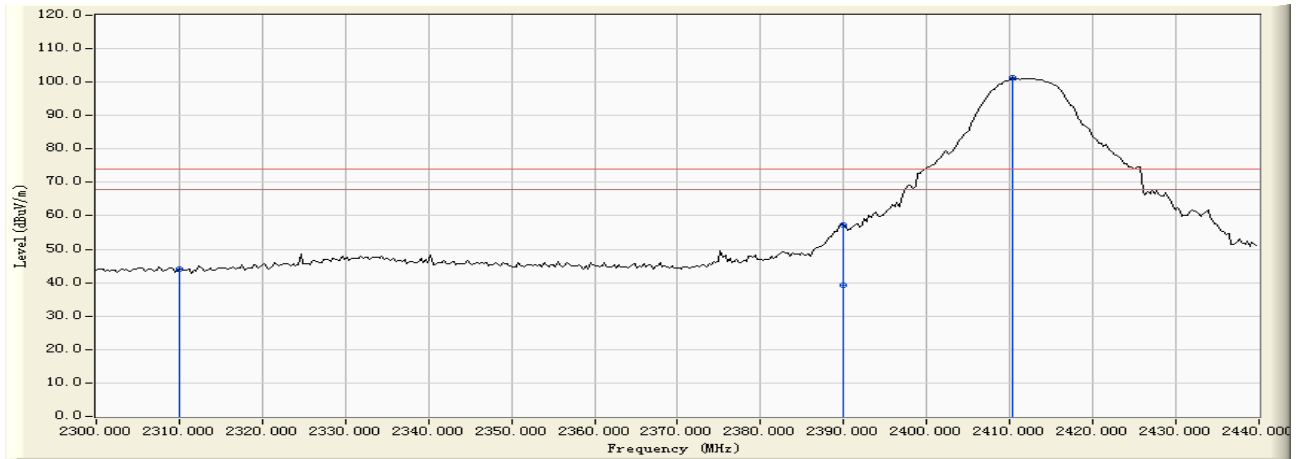

		Frequency (MHz)	Correct Factor (dB)	Reading Level (dBuV)	Measure Level (dBuV/m)	Margin (dB)	Limit (dBuV/m)	Detector Type
1		2310.000	-10.012	53.992	43.980	-30.020	74.000	PEAK
2		2390.000	-10.041	67.197	57.157	-16.843	74.000	PEAK
3	*	2410.379	-10.018	111.293	101.275	N/A	N/A	PEAK

Note:

1. All Readings below 1GHz are Quasi-Peak, above are performed with peak and/or average measurements as necessary.
2. Measurement Level = Reading Level + Correct Factor



Engineer : Fred	
Site : EMC Lab AC 102	Time : 2010/06/29 - 14:06
Limit : FCC_15_03M_PK	Margin : 6
EUT : Wireless N FTTH Router	Probe : BBHA9120D(1-18GHz) - HORIZONTAL
Power : AC120V/60Hz	Note : Mode 1: Transmit by 802.11b (An0) (2462MHz)

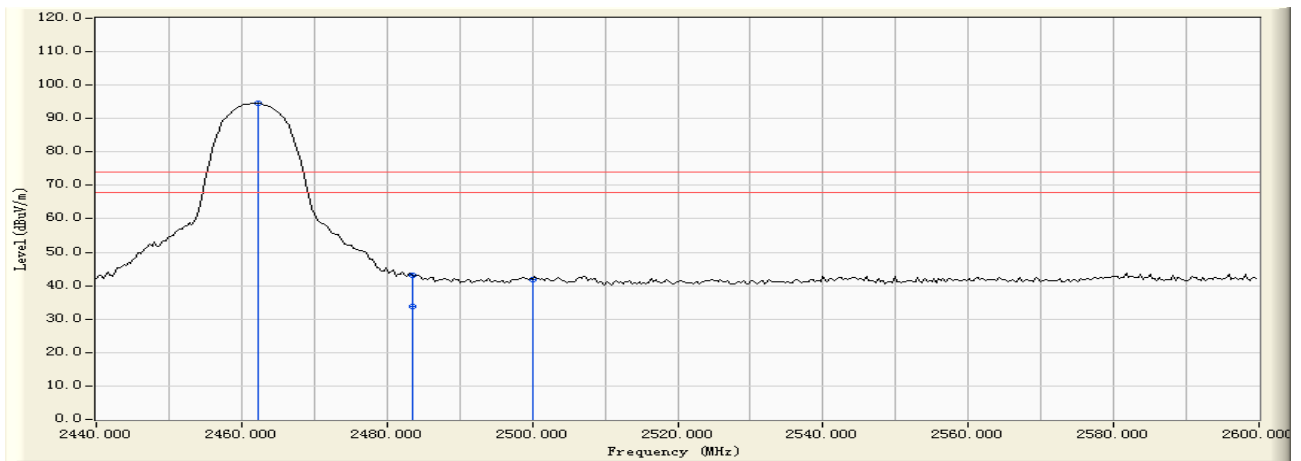

		Frequency (MHz)	Correct Factor (dB)	Reading Level (dBuV)	Measure Level (dBuV/m)	Margin (dB)	Limit (dBuV/m)	Detector Type
1	*	2462.355	-9.908	104.569	94.660	N/A	N/A	PEAK
2		2483.500	-9.856	52.842	42.986	-31.014	74.000	PEAK
3		2500.000	-9.810	51.675	41.865	-32.135	74.000	PEAK

Note:

1. All Readings below 1GHz are Quasi-Peak, above are performed with peak and/or average measurements as necessary.
2. Measurement Level = Reading Level + Correct Factor



Engineer : Fred	
Site : EMC Lab AC 102	Time : 2010/06/29 - 14:09
Limit : FCC_15_03M_PK	Margin : 6
EUT : Wireless N FTTH Router	Probe : BBHA9120D(1-18GHz) - VERTICAL
Power : AC120V/60Hz	Note : Mode 1: Transmit by 802.11b (An0) (2462MHz)

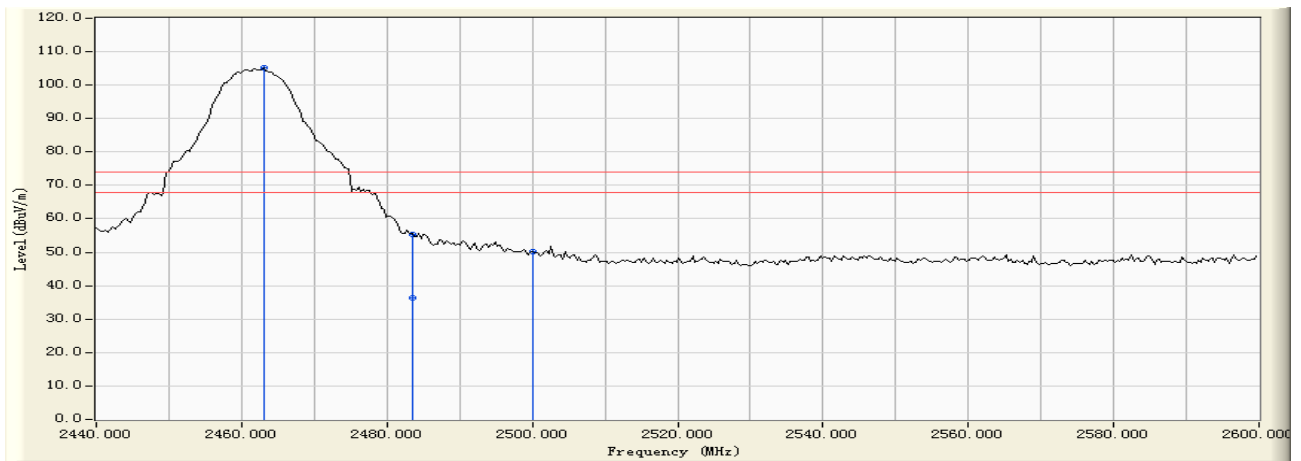

		Frequency (MHz)	Correct Factor (dB)	Reading Level (dBuV)	Measure Level (dBuV/m)	Margin (dB)	Limit (dBuV/m)	Detector Type
1	*	2462.994	-9.908	114.980	105.072	N/A	N/A	PEAK
2		2483.500	-9.856	65.313	55.457	-18.543	74.000	PEAK
3		2483.500	-9.856	46.310	36.454	-17.546	54.000	AVERAGE
4		2500.000	-9.810	59.837	50.027	-23.973	74.000	PEAK

Note:

1. All Readings below 1GHz are Quasi-Peak, above are performed with peak and/or average measurements as necessary.
2. Measurement Level = Reading Level + Correct Factor



Band Edge (20dBc RF Conducted Measurement)
Mode 1: Transmit by 802.11b (An0) (2412MHz)

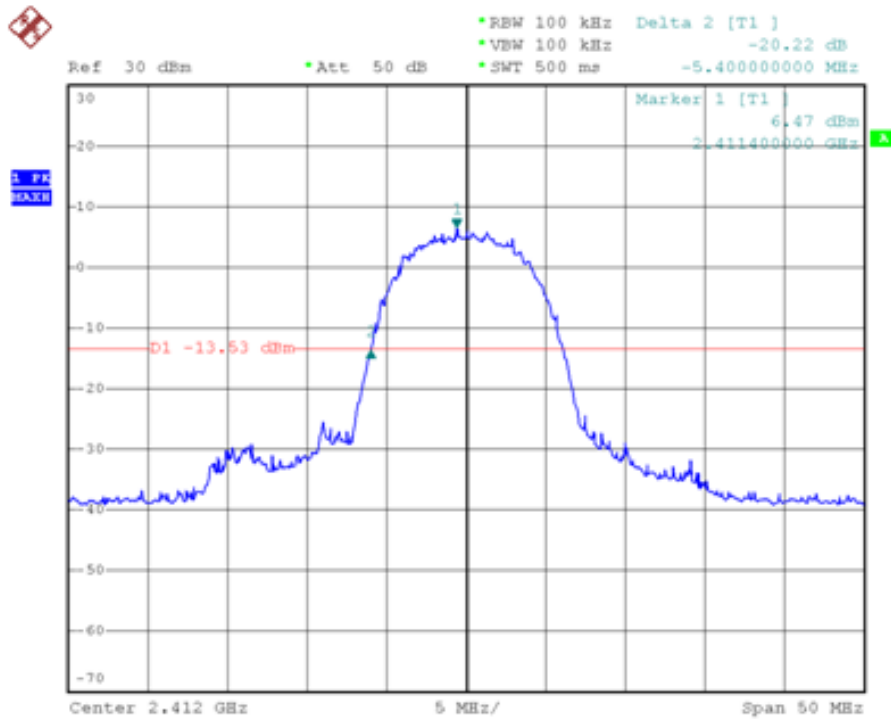

Band Edge (20dBc RF Conducted Measurement)
Mode 1: Transmit by 802.11b (An0) (2462MHz)

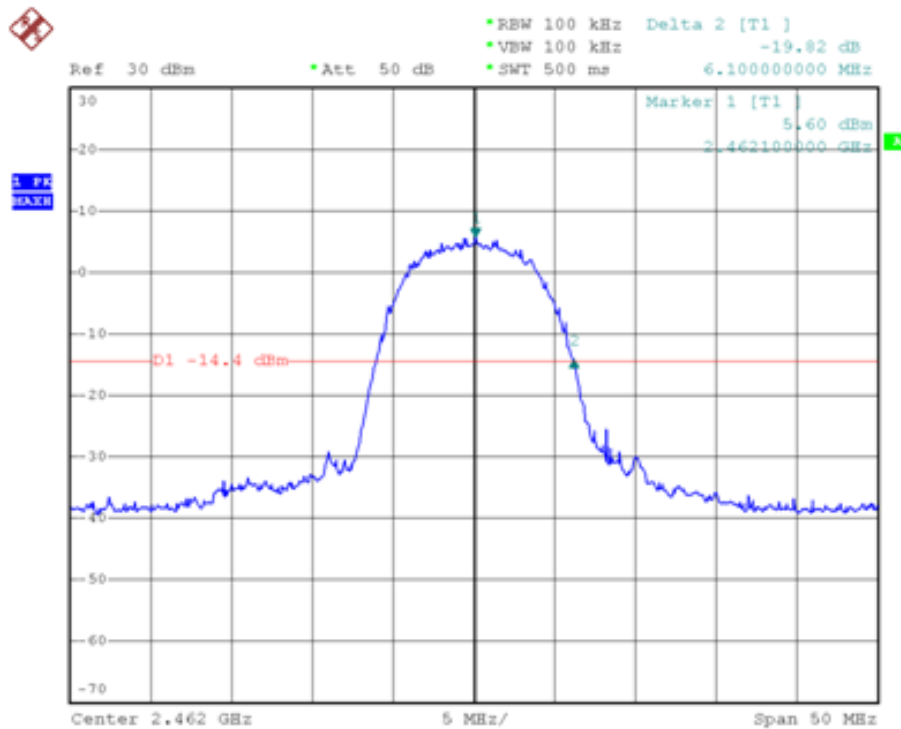



Engineer : Fred	
Site : EMC Lab AC 102	Time : 2010/06/29- 14:45
Limit : FCC_15_03M_PK	Margin : 6
EUT : Wireless N FTTH Router	Probe : BBHA9120D(1-18GHz) - HORIZONTAL
Power : AC120V/60Hz	Note : Mode 2: Transmit by 802.11g (An0) (2412MHz)

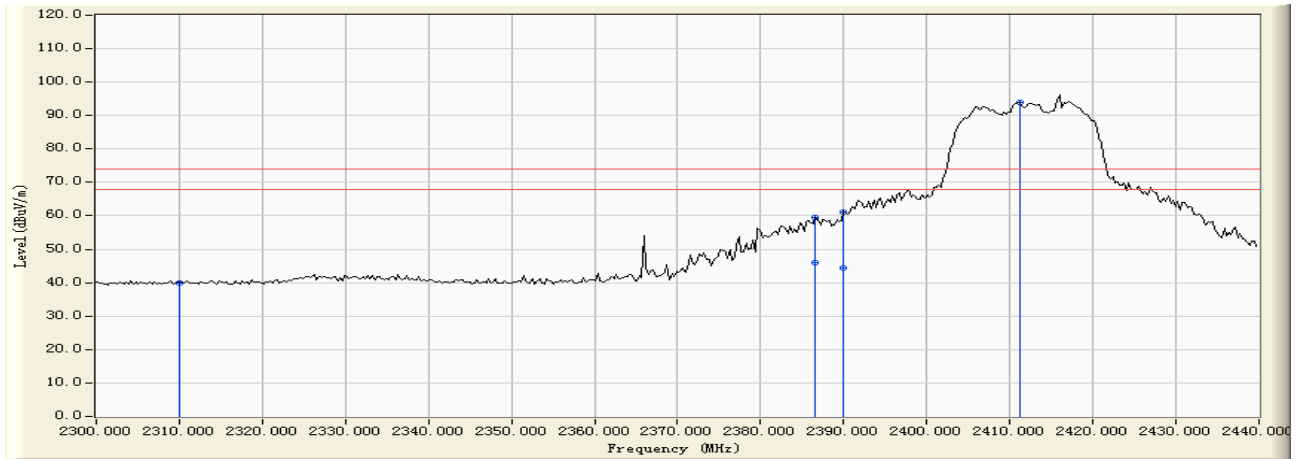

		Frequency (MHz)	Correct Factor (dB)	Reading Level (dBuV)	Measure Level (dBuV/m)	Margin (dB)	Limit (dBuV/m)	Detector Type
1		2310.000	-10.012	49.910	39.898	-34.102	74.000	PEAK
2		2386.627	-10.037	69.620	59.583	-14.417	74.000	PEAK
3		2390.000	-10.041	71.308	61.268	-12.732	74.000	PEAK
4	*	2411.218	-10.017	104.020	94.003	N/A	N/A	PEAK

Note:

1. All Readings below 1GHz are Quasi-Peak, above are performed with peak and/or average measurements as necessary.
2. Measurement Level = Reading Level + Correct Factor



Engineer : Fred	
Site : EMC Lab AC 102	Time : 2010/06/29- 14:43
Limit : FCC_15_03M_PK	Margin : 6
EUT : Wireless N FTTH Router	Probe : BBHA9120D(1-18GHz) - VERTICAL
Power : AC120V/60Hz	Note : Mode 2: Transmit by 802.11g (An0) (2412MHz)

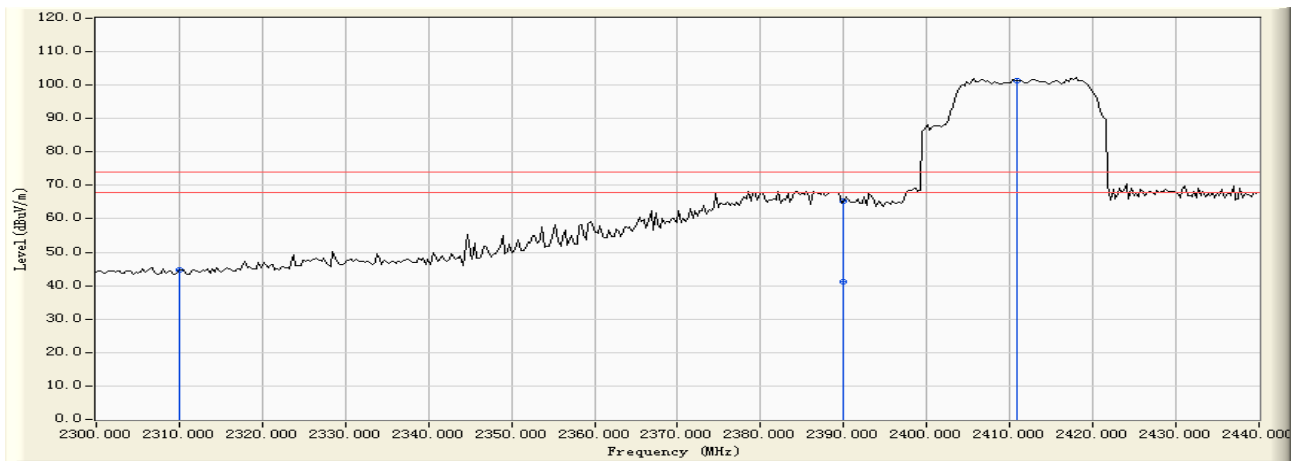

		Frequency (MHz)	Correct Factor (dB)	Reading Level (dBuV)	Measure Level (dBuV/m)	Margin (dB)	Limit (dBuV/m)	Detector Type
1		2310.000	-10.012	54.584	44.572	-29.428	74.000	PEAK
2		2390.000	-10.041	75.189	65.149	-8.851	74.000	PEAK
3	*	2410.938	-10.018	111.370	101.353	N/A	N/A	PEAK

Note:

1. All Readings below 1GHz are Quasi-Peak, above are performed with peak and/or average measurements as necessary.
2. Measurement Level = Reading Level + Correct Factor



Engineer : Fred	
Site : EMC Lab AC 102	Time : 2010/06/29- 14:47
Limit : FCC_15_03M_PK	Margin : 6
EUT : Wireless N FTTH Router	Probe : BBHA9120D(1-18GHz) - HORIZONTAL
Power : AC120V/60Hz	Note : Mode 2: Transmit by 802.11g (An0) (2462MHz)

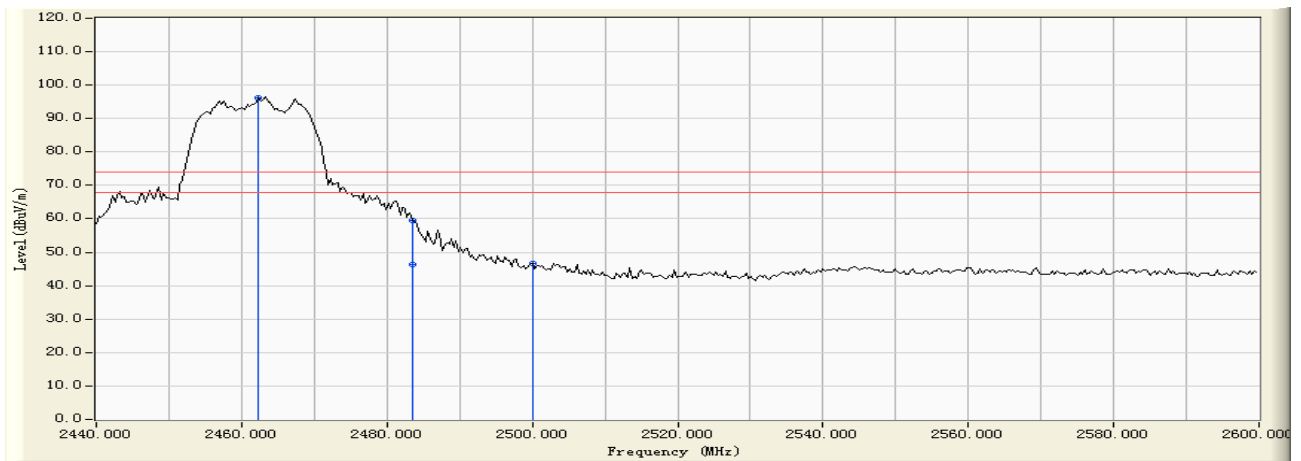

		Frequency (MHz)	Correct Factor (dB)	Reading Level (dBuV)	Measure Level (dBuV/m)	Margin (dB)	Limit (dBuV/m)	Detector Type
1	*	2462.355	-9.908	105.951	96.042	N/A	N/A	PEAK
2		2483.500	-9.856	69.479	59.623	-14.377	74.000	PEAK
3		2500.000	-9.810	56.431	46.621	-27.379	74.000	PEAK

Note:

1. All Readings below 1GHz are Quasi-Peak, above are performed with peak and/or average measurements as necessary.
2. Measurement Level = Reading Level + Correct Factor



Engineer : Fred	
Site : EMC Lab AC 102	Time : 2010/06/29- 14:48
Limit : FCC_15_03M_PK	Margin : 6
EUT : Wireless N FTTH Router	Probe : BBHA9120D(1-18GHz) - VERTICAL
Power : AC120V/60Hz	Note : Mode 2: Transmit by 802.11g (An0) (2462MHz)

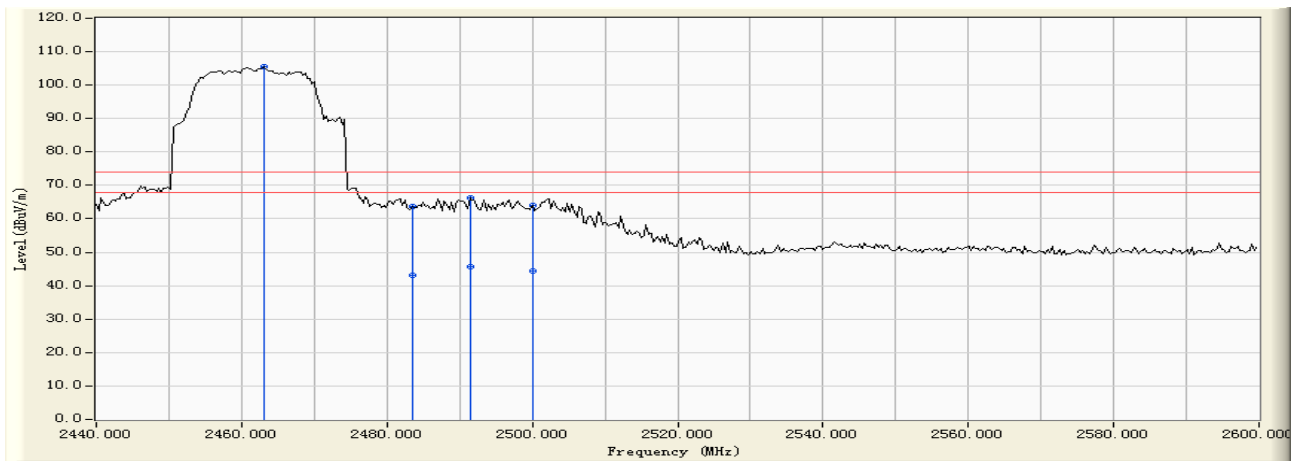

		Frequency (MHz)	Correct Factor (dB)	Reading Level (dBuV)	Measure Level (dBuV/m)	Margin (dB)	Limit (dBuV/m)	Detector Type
1	*	2462.994	-9.908	115.457	105.549	N/A	N/A	PEAK
2		2483.500	-9.856	73.602	63.746	-10.254	74.000	PEAK
3		2491.417	-9.838	76.082	66.244	-7.756	74.000	PEAK
4		2500.000	-9.810	73.774	63.964	-10.036	74.000	PEAK

Note:

1. All Readings below 1GHz are Quasi-Peak, above are performed with peak and/or average measurements as necessary.
2. Measurement Level = Reading Level + Correct Factor



Band Edge (20dBc RF Conducted Measurement)
Mode 2: Transmit by 802.11g (An0) (2412MHz)

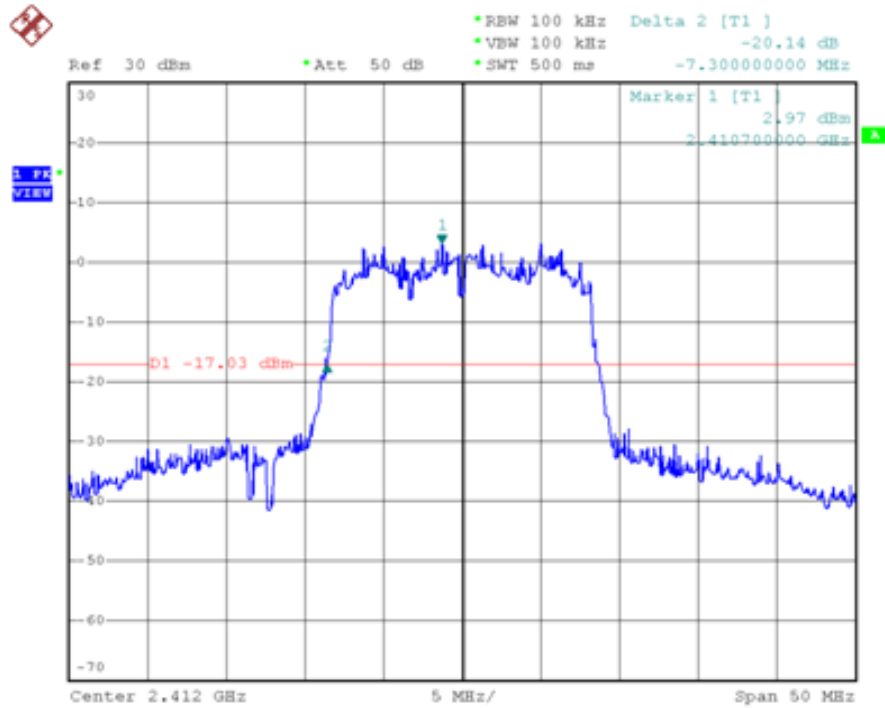

Band Edge (20dBc RF Conducted Measurement)
Mode 2: Transmit by 802.11g (An0) (2462MHz)

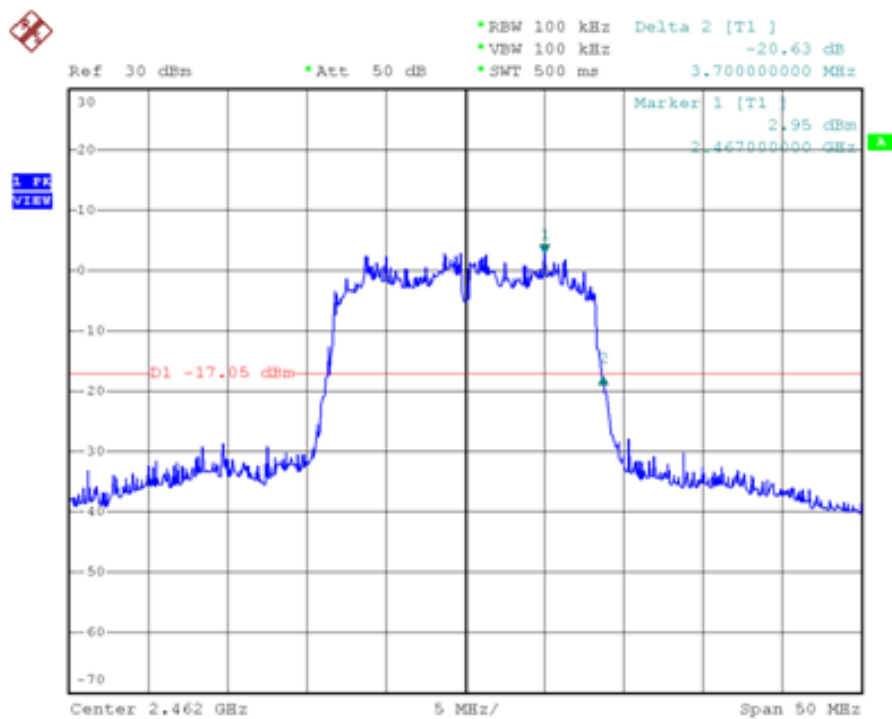



Engineer : Fred	
Site : EMC Lab AC 102	Time : 2010/06/29- 14:52
Limit : FCC_15_03M_PK	Margin : 6
EUT : Wireless N FTTH Router	Probe : BBHA9120D(1-18GHz) - HORIZONTAL
Power : AC120V/60Hz	Note : Mode 3: Transmit by 802.11n (20MHz) (An0 and An1) (2412MHz)

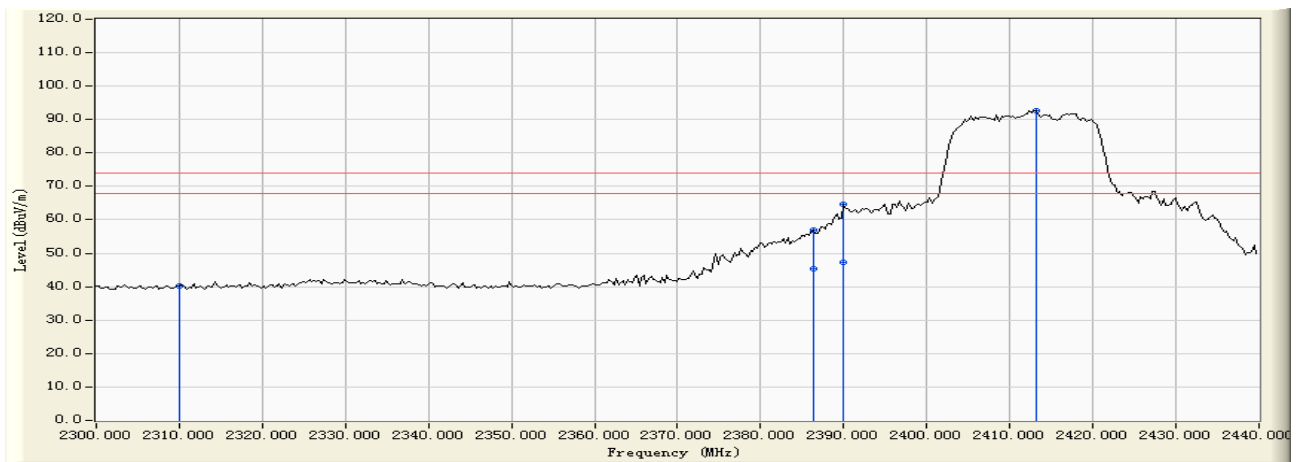

		Frequency (MHz)	Correct Factor (dB)	Reading Level (dBuV)	Measure Level (dBuV/m)	Margin (dB)	Limit (dBuV/m)	Detector Type
1		2310.000	-10.012	50.182	40.170	-33.830	74.000	PEAK
2		2386.347	-10.036	67.127	57.090	-16.910	74.000	PEAK
3		2390.000	-10.041	74.555	64.515	-9.485	74.000	PEAK
4	*	2413.174	-10.015	102.738	92.722	N/A	N/A	PEAK

Note:

1. All Readings below 1GHz are Quasi-Peak, above are performed with peak and/or average measurements as necessary.
2. Measurement Level = Reading Level + Correct Factor



Engineer : Fred	
Site : EMC Lab AC 102	Time : 2010/06/29- 14:51
Limit : FCC_15_03M_PK	Margin : 6
EUT : Wireless N FTTH Router	Probe : BBHA9120D(1-18GHz) - VERTICAL
Power : AC120V/60Hz	Note : Mode 3: Transmit by 802.11n (20MHz) (An0 and An1) (2412MHz)

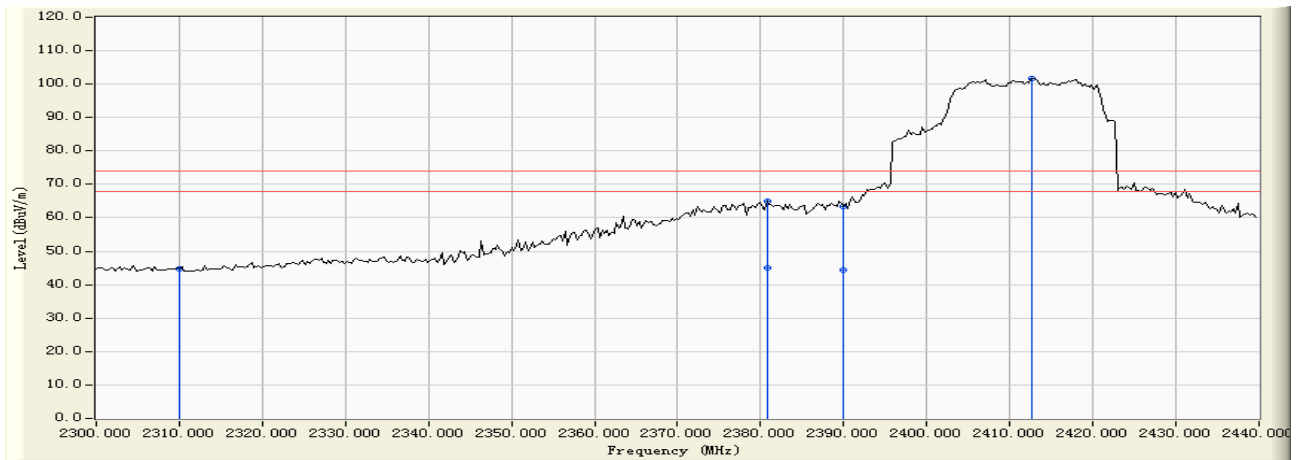

		Frequency (MHz)	Correct Factor (dB)	Reading Level (dBuV)	Measure Level (dBuV/m)	Margin (dB)	Limit (dBuV/m)	Detector Type
1		2310.000	-10.012	54.745	44.733	-29.267	74.000	PEAK
2		2380.759	-10.035	75.001	64.966	-9.034	74.000	PEAK
3		2390.000	-10.041	73.564	63.524	-10.476	74.000	PEAK
4	*	2412.615	-10.017	111.643	101.627	N/A	N/A	PEAK

Note:

1. All Readings below 1GHz are Quasi-Peak, above are performed with peak and/or average measurements as necessary.
2. Measurement Level = Reading Level + Correct Factor



Engineer : Fred	
Site : EMC Lab AC 102	Time : 2010/06/29- 14:55
Limit : FCC_15_03M_PK	Margin : 6
EUT : Wireless N FTTH Router	Probe : BBHA9120D(1-18GHz) - HORIZONTAL
Power : AC120V/60Hz	Note : Mode 3: Transmit by 802.11n (20MHz) (An0 and An1) (2462MHz)

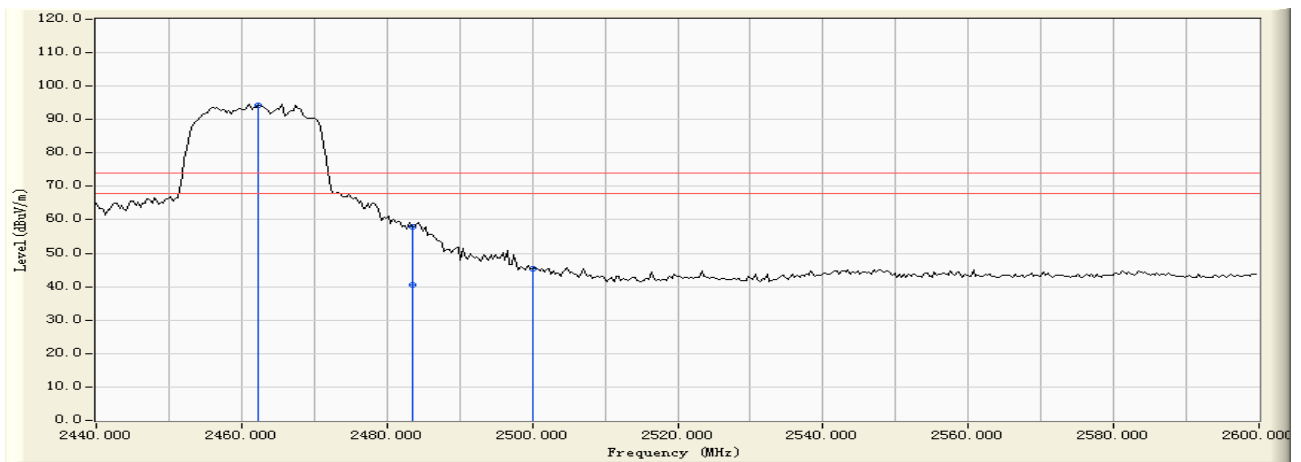

		Frequency (MHz)	Correct Factor (dB)	Reading Level (dBuV)	Measure Level (dBuV/m)	Margin (dB)	Limit (dBuV/m)	Detector Type
1	*	2462.355	-9.908	104.171	94.262	N/A	N/A	PEAK
2		2483.500	-9.856	67.742	57.886	-16.114	74.000	PEAK
3		2500.000	-9.810	55.166	45.356	-28.644	74.000	PEAK

Note:

1. All Readings below 1GHz are Quasi-Peak, above are performed with peak and/or average measurements as necessary.
2. Measurement Level = Reading Level + Correct Factor



Engineer : Fred	
Site : EMC Lab AC 102	Time : 2010/06/29- 14:56
Limit : FCC_15_03M_PK	Margin : 6
EUT : Wireless N FTTH Router	Probe : BBHA9120D(1-18GHz) - VERTICAL
Power : AC120V/60Hz	Note : Mode 3: Transmit by 802.11n (20MHz) (An0 and An1) (2462MHz)

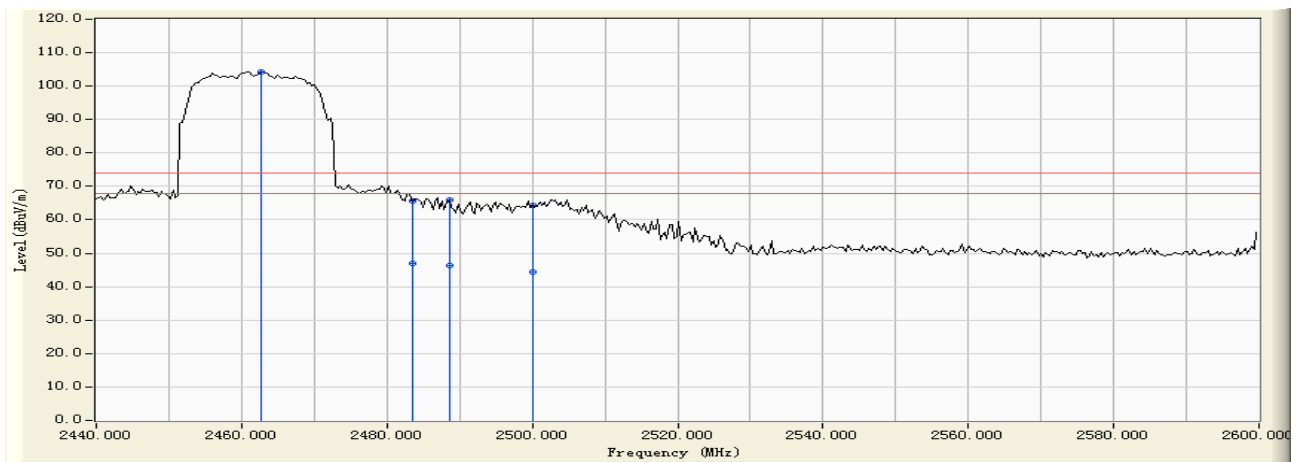

		Frequency (MHz)	Correct Factor (dB)	Reading Level (dBuV)	Measure Level (dBuV/m)	Margin (dB)	Limit (dBuV/m)	Detector Type
1	*	2462.675	-9.907	114.153	104.245	N/A	N/A	PEAK
2		2483.500	-9.856	75.382	65.526	-8.474	74.000	PEAK
3		2488.543	-9.847	75.832	65.985	-8.015	74.000	PEAK
4		2500.000	-9.810	74.232	64.422	-9.578	74.000	PEAK

Note:

1. All Readings below 1GHz are Quasi-Peak, above are performed with peak and/or average measurements as necessary.
2. Measurement Level = Reading Level + Correct Factor



Band Edge (20dBc RF Conducted Measurement)
Mode 3: Transmit by 802.11n (20MHz) (An0) (2412MHz)

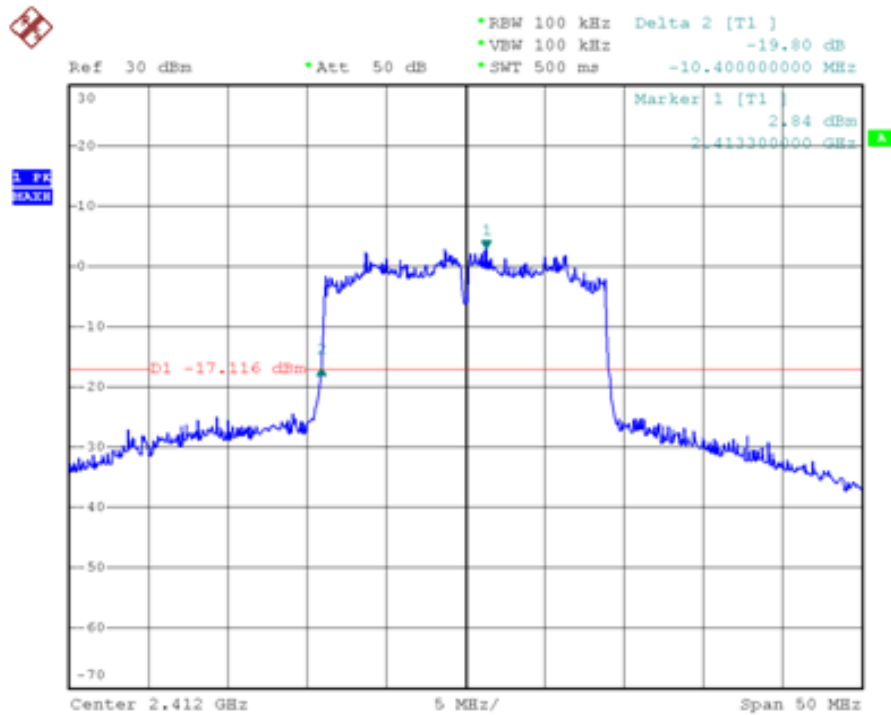

Band Edge (20dBc RF Conducted Measurement)
Mode 3: Transmit by 802.11n (20MHz) (An1) (2412MHz)

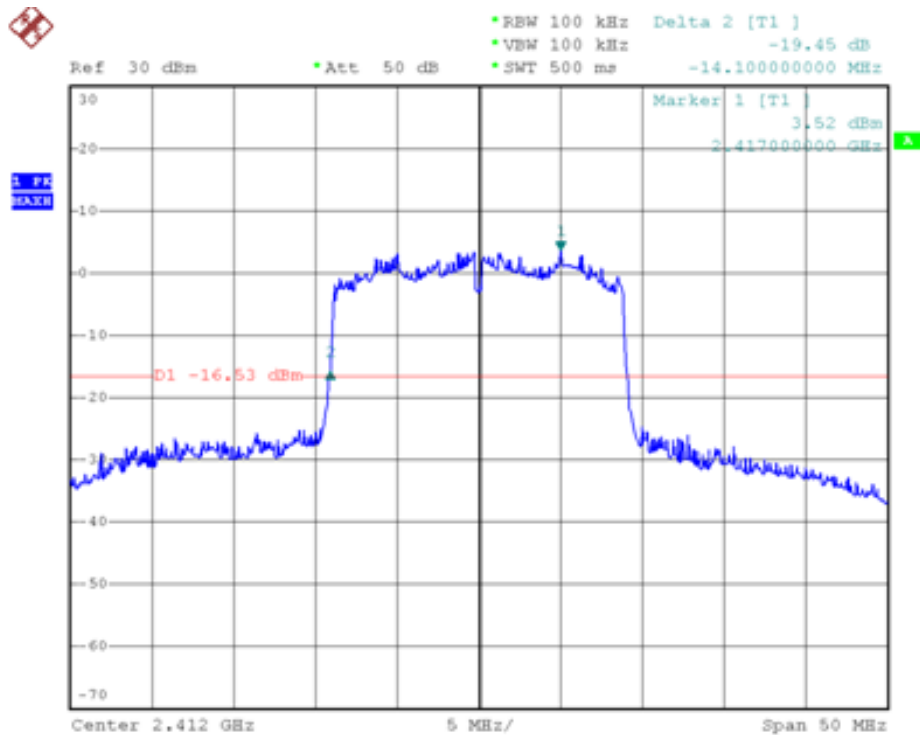



Band Edge (20dBc RF Conducted Measurement)
Mode 3: Transmit by 802.11n (20MHz) (An0) (2462MHz)

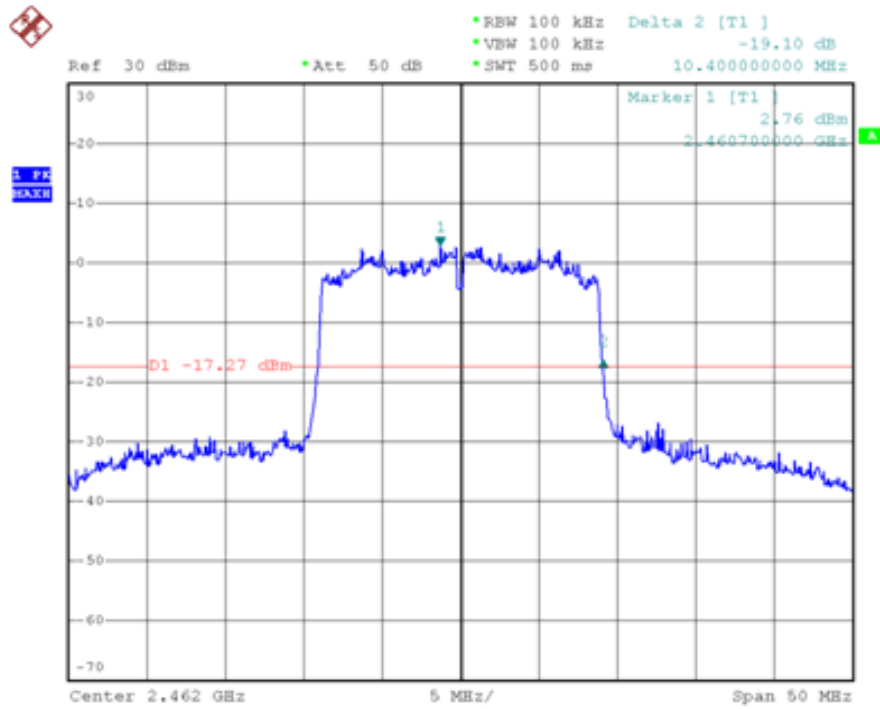

Band Edge (20dBc RF Conducted Measurement)
Mode 3: Transmit by 802.11n (20MHz) (An1) (2462MHz)

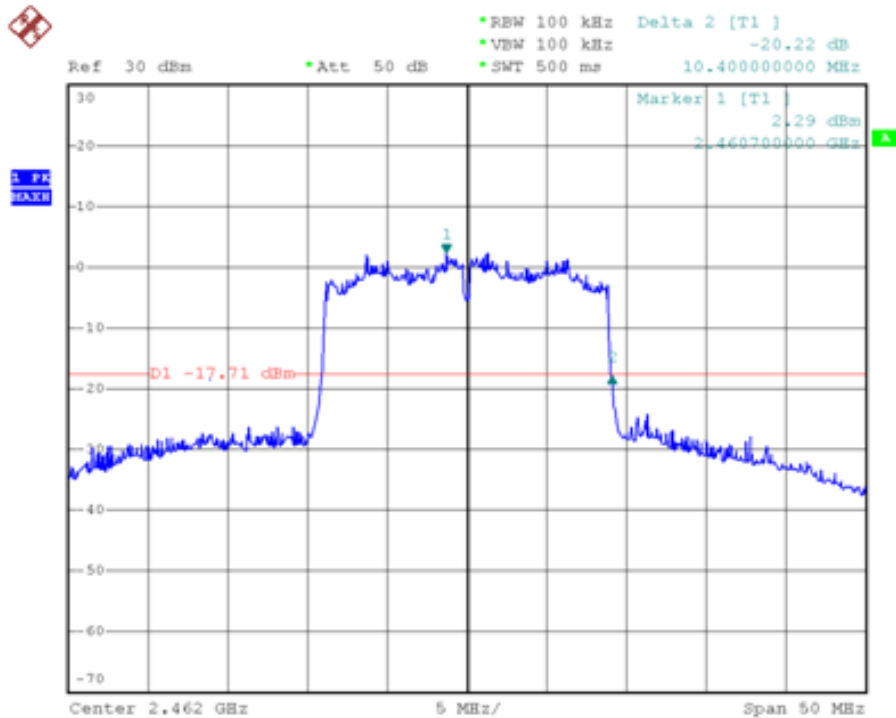



Engineer : Fred	
Site : EMC Lab AC 102	Time : 2010/06/29- 14:59
Limit : FCC_15_03M_PK	Margin : 6
EUT : Wireless N FTTH Router	Probe : BBHA9120D(1-18GHz) - HORIZONTAL
Power : AC120V/60Hz	Note : Mode 4: Transmit by 802.11n (40MHz) (An0 and An1) (2422MHz)

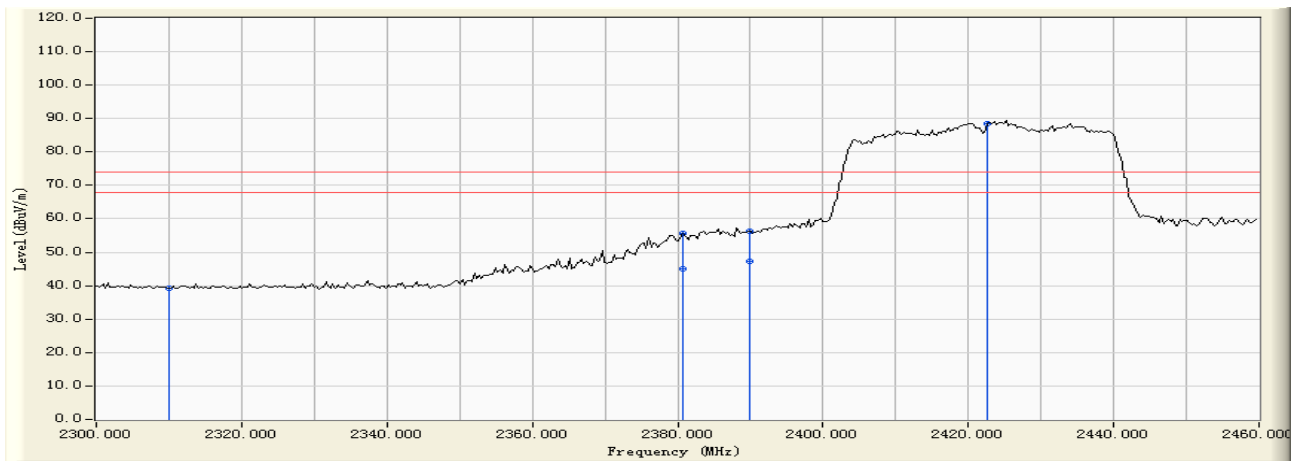

		Frequency (MHz)	Correct Factor (dB)	Reading Level (dBuV)	Measure Level (dBuV/m)	Margin (dB)	Limit (dBuV/m)	Detector Type
1		2310.000	-10.012	49.229	39.217	-34.783	74.000	PEAK
2		2380.798	-10.035	65.850	55.815	-18.185	74.000	PEAK
3		2390.000	-10.041	66.260	56.220	-17.780	74.000	PEAK
4	*	2422.635	-10.003	98.328	88.325	N/A	N/A	PEAK

Note:

1. All Readings below 1GHz are Quasi-Peak, above are performed with peak and/or average measurements as necessary.
2. Measurement Level = Reading Level + Correct Factor



Engineer : Fred	
Site : EMC Lab AC 102	Time : 2010/06/29- 14:58
Limit : FCC_15_03M_PK	Margin : 6
EUT : Wireless N FTTH Router	Probe : BBHA9120D(1-18GHz) - VERTICAL
Power : AC120V/60Hz	Note : Mode 4: Transmit by 802.11n (40MHz) (An0 and An1) (2422MHz)

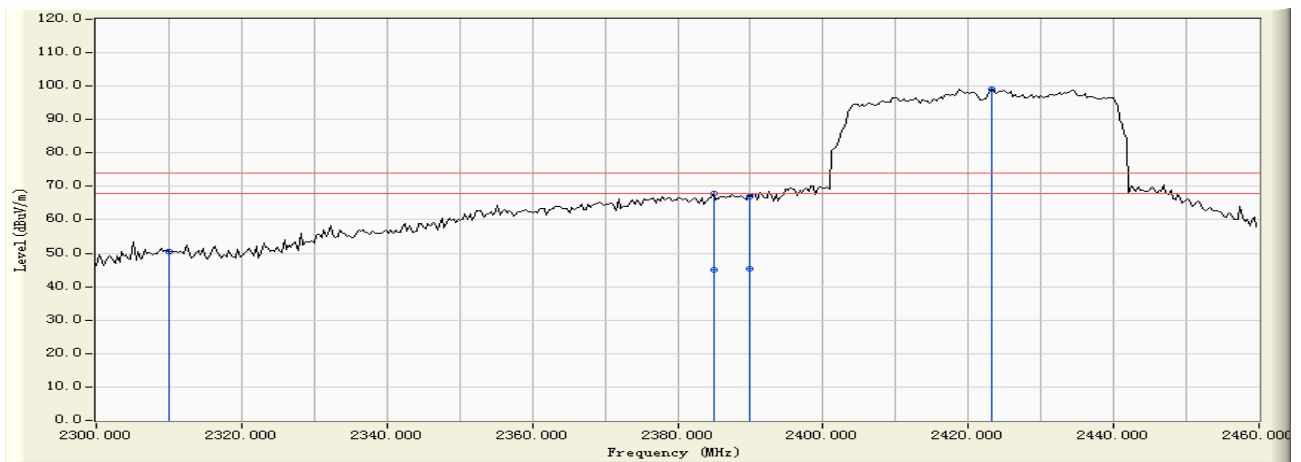

		Frequency (MHz)	Correct Factor (dB)	Reading Level (dBuV)	Measure Level (dBuV/m)	Margin (dB)	Limit (dBuV/m)	Detector Type
1		2310.000	-10.012	60.538	50.526	-23.474	74.000	PEAK
2		2384.950	-10.035	77.792	67.757	-6.243	74.000	PEAK
3		2390.000	-10.041	77.022	66.982	-7.018	74.000	PEAK
4	*	2423.273	-10.001	109.050	99.049	N/A	N/A	PEAK

Note:

1. All Readings below 1GHz are Quasi-Peak, above are performed with peak and/or average measurements as necessary.
2. Measurement Level = Reading Level + Correct Factor



Engineer : Fred	
Site : EMC Lab AC 102	Time : 2010/06/29- 15:01
Limit : FCC_15_03M_PK	Margin : 6
EUT : Wireless N FTTH Router	Probe : BBHA9120D(1-18GHz) - HORIZONTAL
Power : AC120V/60Hz	Note : Mode 4: Transmit by 802.11n (40MHz) (An0 and An1) (2452MHz)

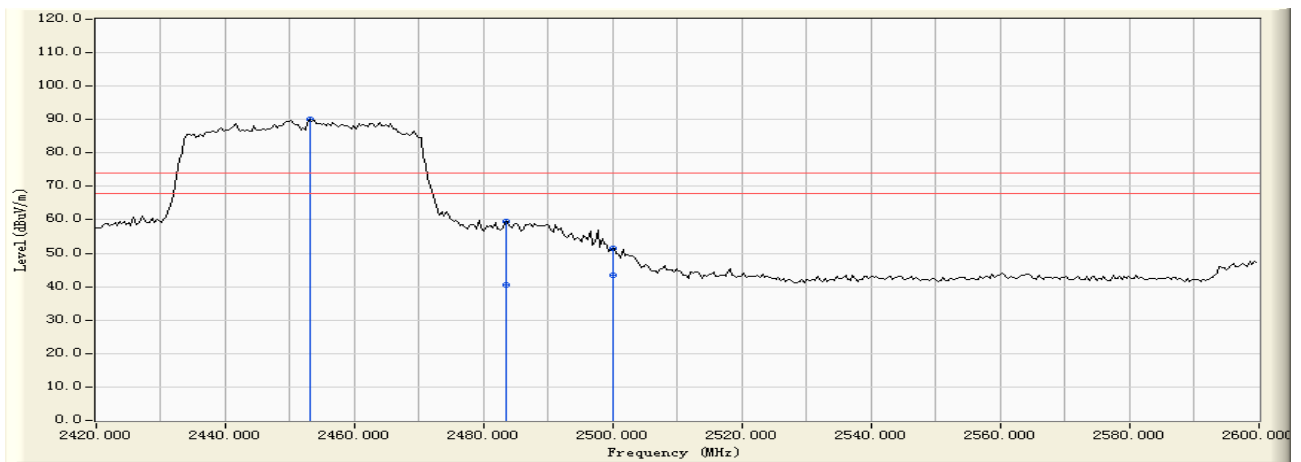

		Frequency (MHz)	Correct Factor (dB)	Reading Level (dBuV)	Measure Level (dBuV/m)	Margin (dB)	Limit (dBuV/m)	Detector Type
1	*	2453.054	-9.930	100.120	90.190	N/A	N/A	PEAK
2		2483.500	-9.856	69.344	59.488	-14.512	74.000	PEAK
3		2500.000	-9.810	61.128	51.318	-22.682	74.000	PEAK

Note:

1. All Readings below 1GHz are Quasi-Peak, above are performed with peak and/or average measurements as necessary.
2. Measurement Level = Reading Level + Correct Factor



Engineer : Fred	
Site : EMC Lab AC 102	Time : 2010/06/29- 15:03
Limit : FCC_15_03M_PK	Margin : 6
EUT : Wireless N FTTH Router	Probe : BBHA9120D(1-18GHz) - VERTICAL
Power : AC120V/60Hz	Note : Mode 4: Transmit by 802.11n (40MHz) (An0 and An1) (2452MHz)

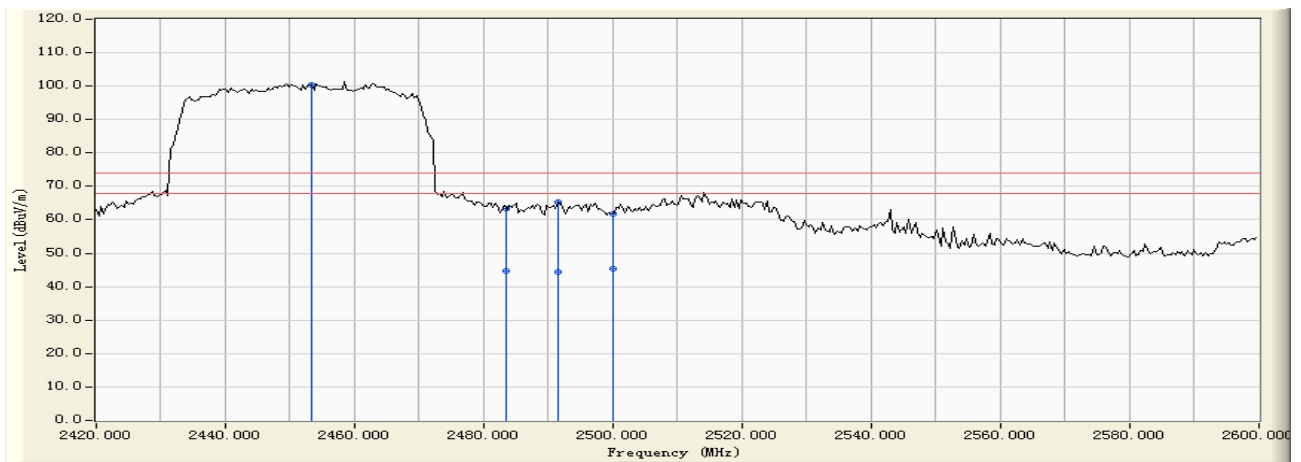

		Frequency (MHz)	Correct Factor (dB)	Reading Level (dBuV)	Measure Level (dBuV/m)	Margin (dB)	Limit (dBuV/m)	Detector Type
1	*	2453.413	-9.929	110.347	100.418	N/A	N/A	PEAK
2		2483.500	-9.856	73.186	63.330	-10.670	74.000	PEAK
3		2491.497	-9.838	75.028	65.190	-8.810	74.000	PEAK
4		2500.000	-9.810	71.717	61.907	-12.093	74.000	PEAK

Note:

1. All Readings below 1GHz are Quasi-Peak, above are performed with peak and/or average measurements as necessary.
2. Measurement Level = Reading Level + Correct Factor



Band Edge (20dBc RF Conducted Measurement)
Mode 4: Transmit by 802.11n (40MHz) (An0) (2422MHz)

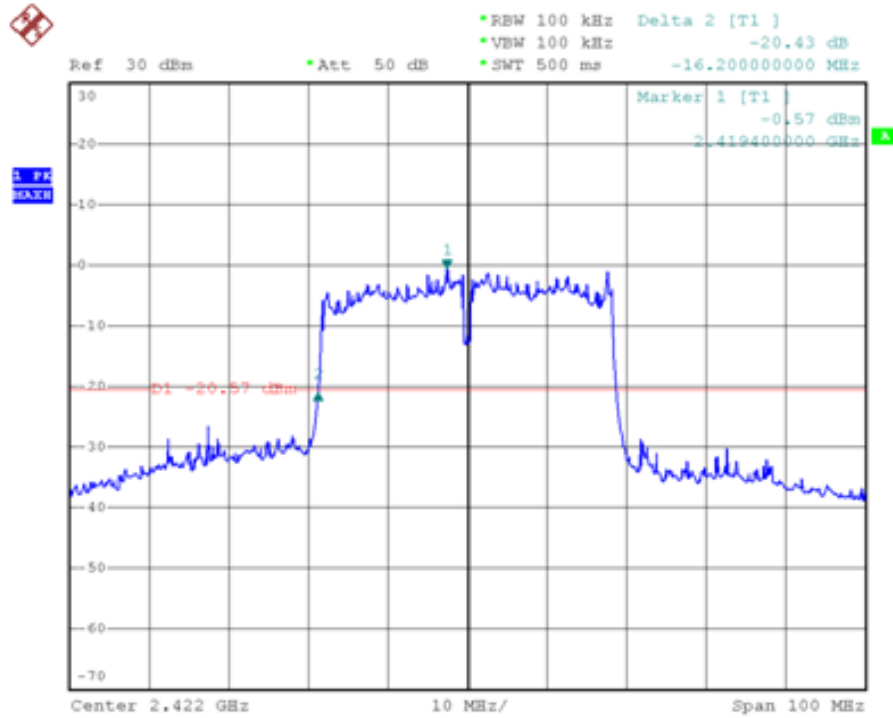

Band Edge (20dBc RF Conducted Measurement)
Mode 4: Transmit by 802.11n (40MHz) (An1) (2422MHz)

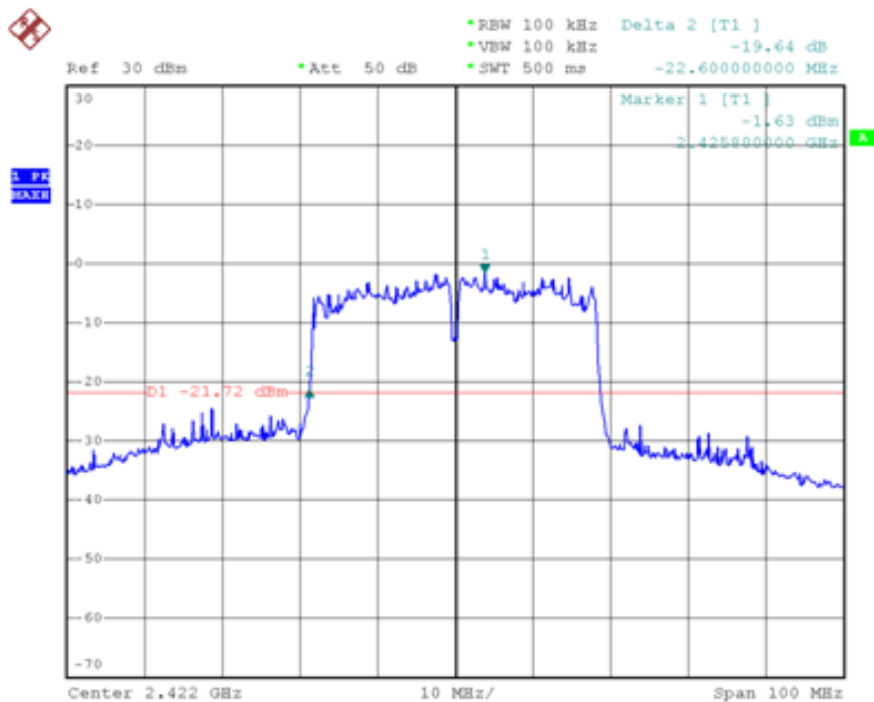



Band Edge (20dBc RF Conducted Measurement)
Mode 4: Transmit by 802.11 n (40MHz) (An0) (2452MHz)

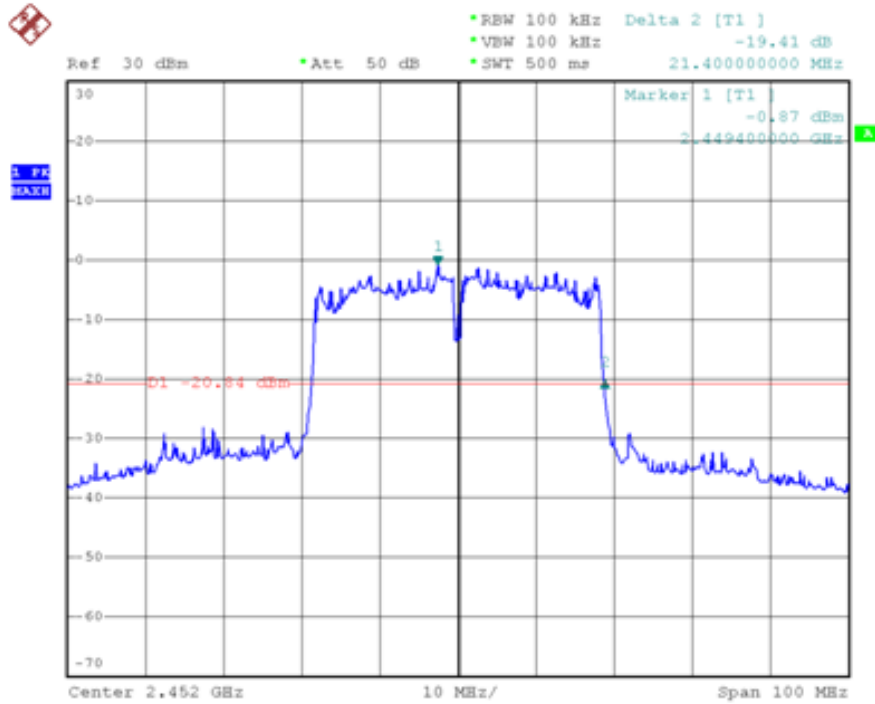

Band Edge (20dBc RF Conducted Measurement)
Mode 4: Transmit by 802.11 n (40MHz) (An1) (2452MHz)

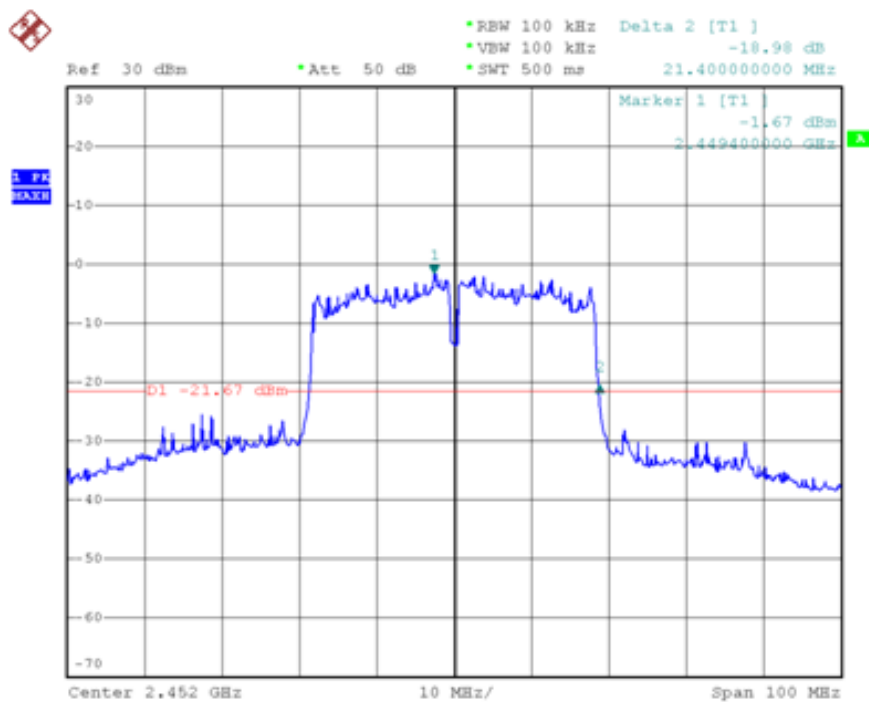



8. Power Spectral Density

8.1. Test Limit

For digitally modulated systems, the power spectral density conducted from the intentional radiated to the antenna shall not be greater than 8dBm in any 3kHz band during any time interval of continuous transmission.

8.2. Test Procedure

The EUT was tested according to DTS test procedure of Oct 2002 KDB558074 for compliance to FCC 47CFR 15.247 requirements.

Set RBW= 3 kHz, Set VBW \geq 9 kHz, Sweep time=Auto, Set detector=Peak detector.

8.3. Test Setup Layout

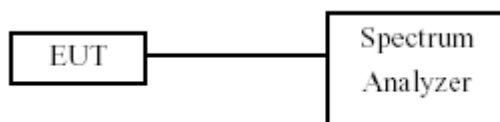

8.4. Measurement Equipment

Instrument/Ancillary	Model No.	Manufacturer	Serial No.	Calibration Date
Spectrum Analyzer	R&S	FSP40	100324	2009.11.02
Temperature/ Humidity Meter	Zhicheng	ZC1-11	CEP-TH-002	2009.10.19



8.5. Test Result and Data

Test Item	Power Spectral Density
Test Mode	Mode 1: Transmit by 802.11b (An0)
Test Date	2010-06-30

Channel	Frequency (MHz)	Power Spectral Density (dBm/3kHz)	Limit (dBm/3kHz)	Result
01	2412	-7.62	8	Pass
06	2437	-8.54	8	Pass
11	2462	-7.28	8	Pass

Channel 01 (2412MHz)

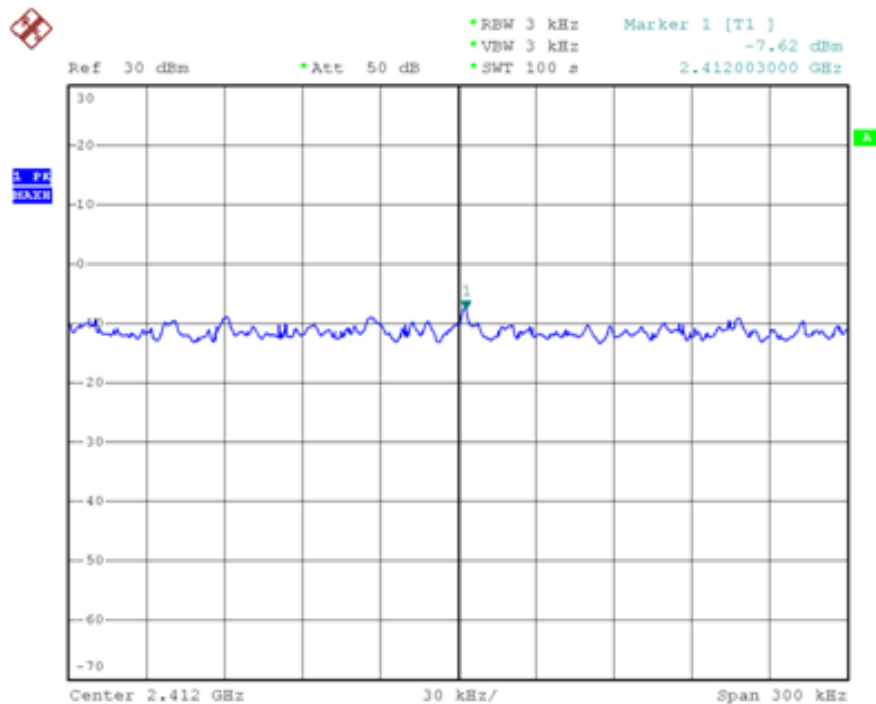



Channel 06 (2437MHz)

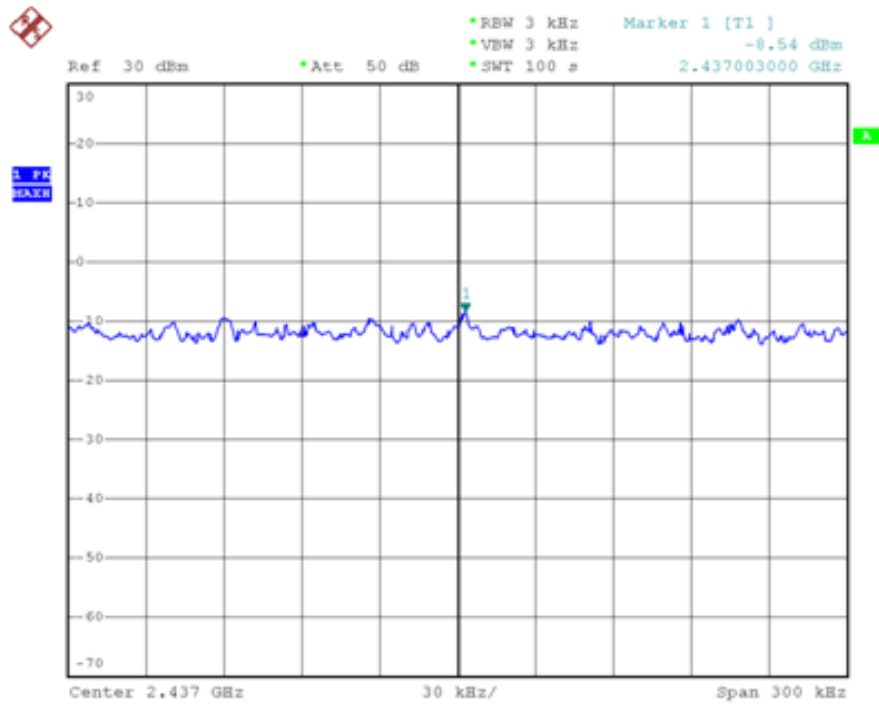

Channel 11 (2462MHz)

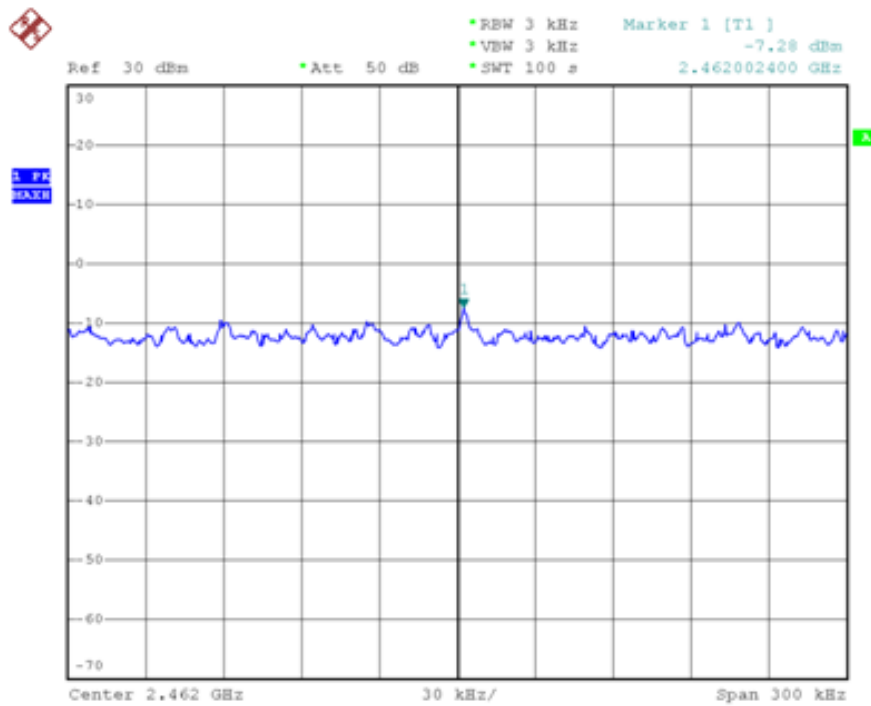



Test Item	Power Spectral Density
Test Mode	Mode 2: Transmit by 802.11g (An0)
Test Date	2010-06-30

Channel	Frequency (MHz)	Power Spectral Density (dBm/3kHz)	Limit (dBm/3kHz)	Result
01	2412	-15.39	8	Pass
06	2437	-12.77	8	Pass
11	2462	-14.60	8	Pass

Channel 01 (2412MHz)

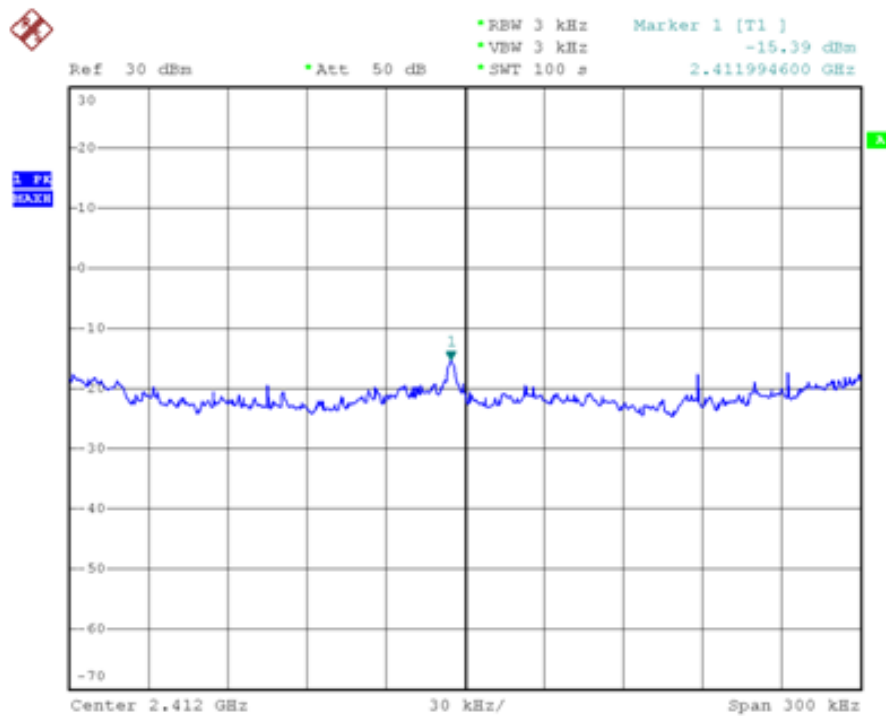



Channel 06 (2437MHz)

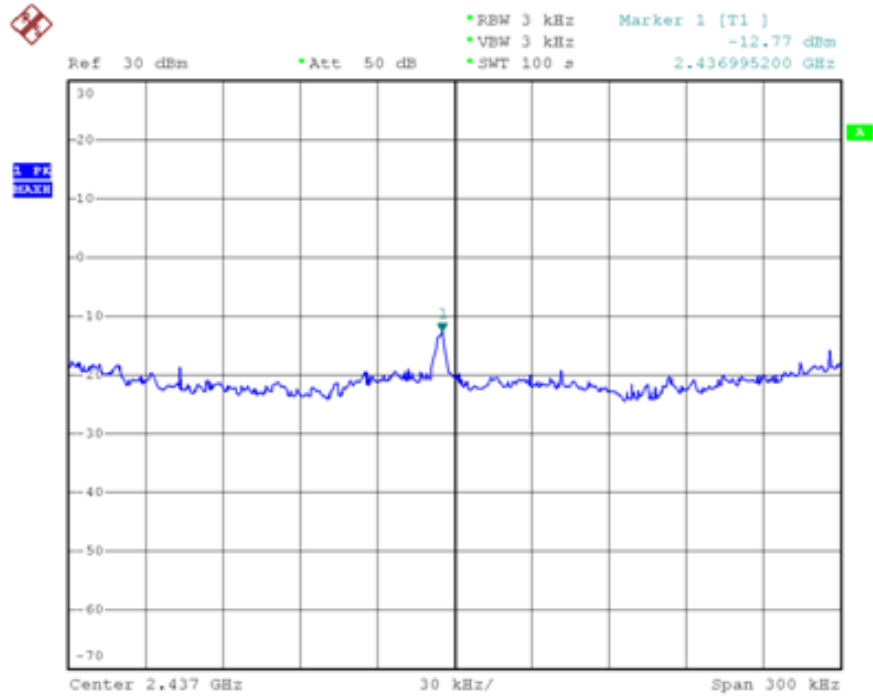

Channel 11 (2462MHz)

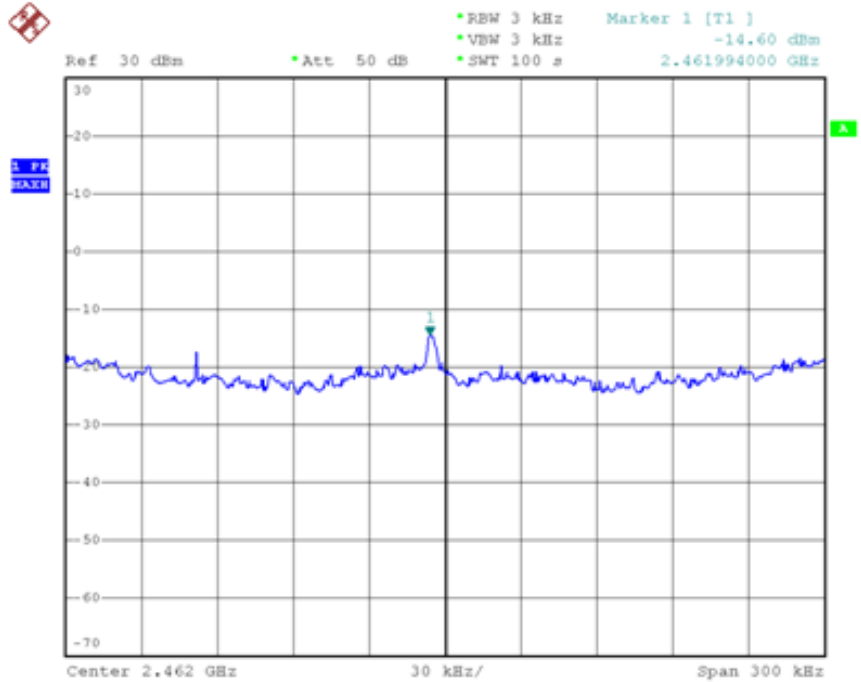



Test Item	Power Spectral Density
Test Mode	Mode 3: Transmit by 802.11n (20MHz) (An0)
Test Date	2010-06-30

Channel	Frequency (MHz)	Power Spectral Density (dBm/3kHz)	Limit (dBm/3kHz)	Result
01	2412	-18.12	8	Pass
06	2437	-20.11	8	Pass
11	2462	-18.11	8	Pass

Channel 01 (2412MHz)

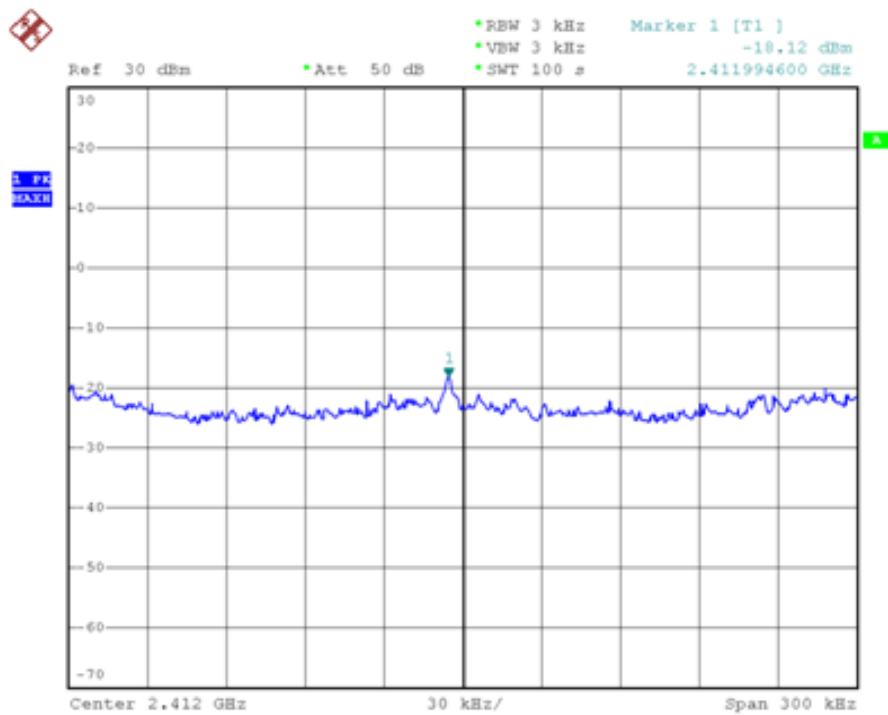



Channel 06 (2437MHz)

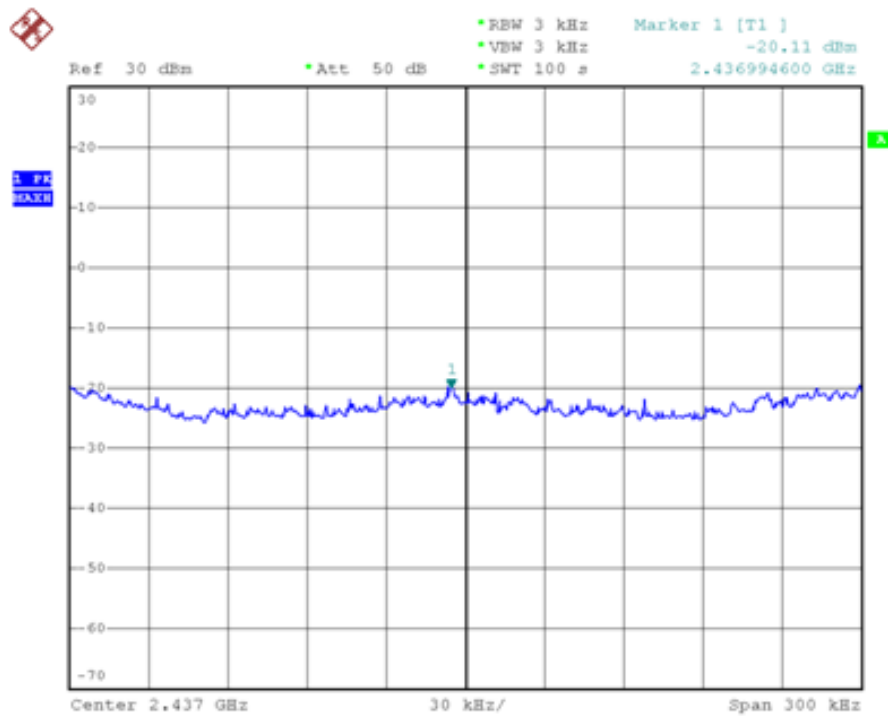

Channel 11 (2462MHz)

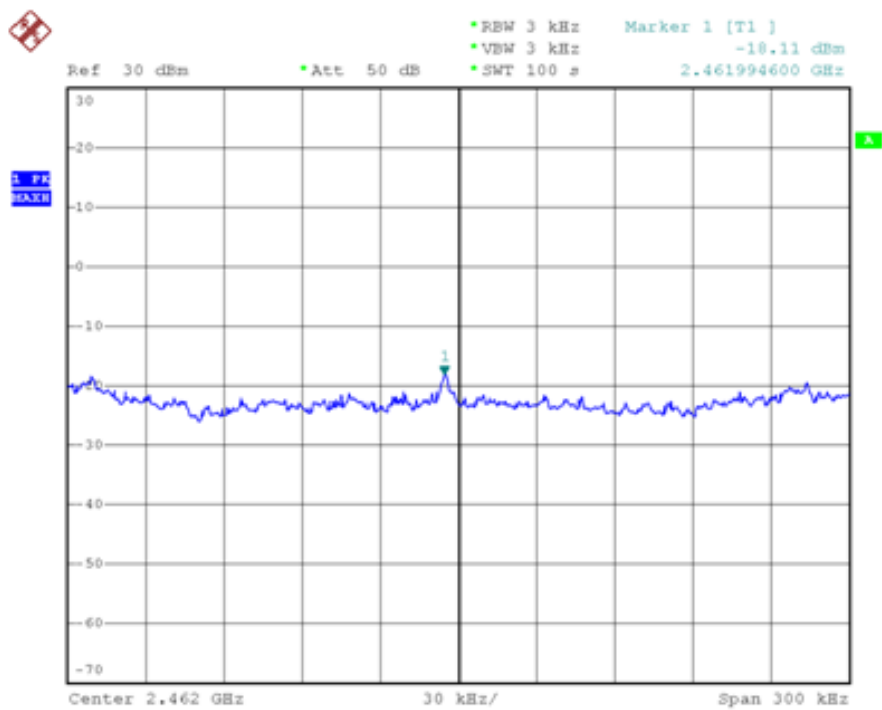



Test Item	Power Spectral Density
Test Mode	Mode 3: Transmit by 802.11n (20MHz) (An1)
Test Date	2010-06-30

Channel	Frequency (MHz)	Power Spectral Density (dBm/3kHz)	Limit (dBm/3kHz)	Result
01	2412	-17.46	8	Pass
06	2437	-17.32	8	Pass
11	2462	-18.11	8	Pass

Channel 01 (2412MHz)

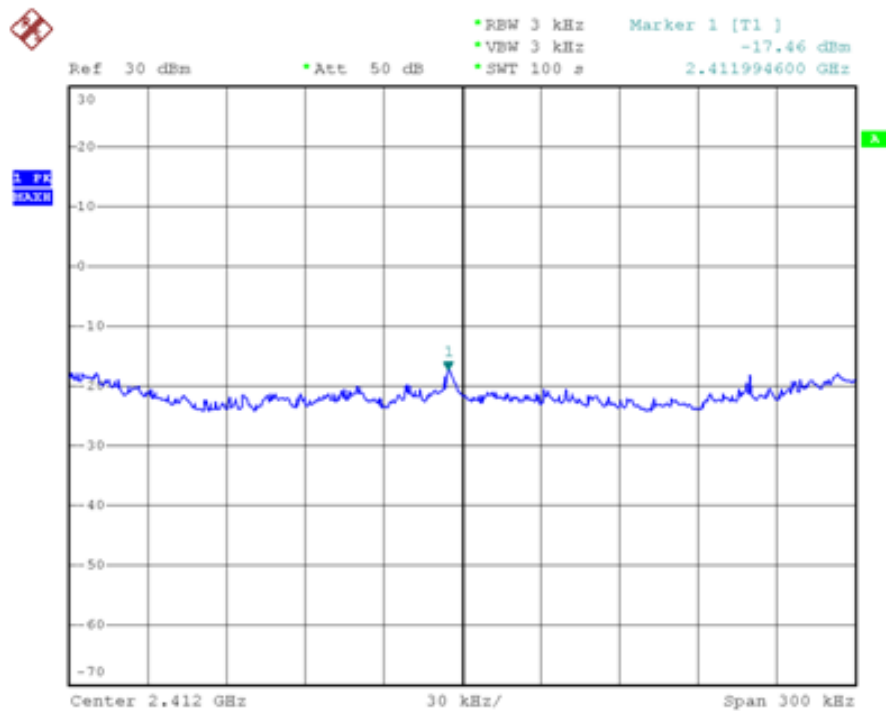



Channel 06 (2437MHz)

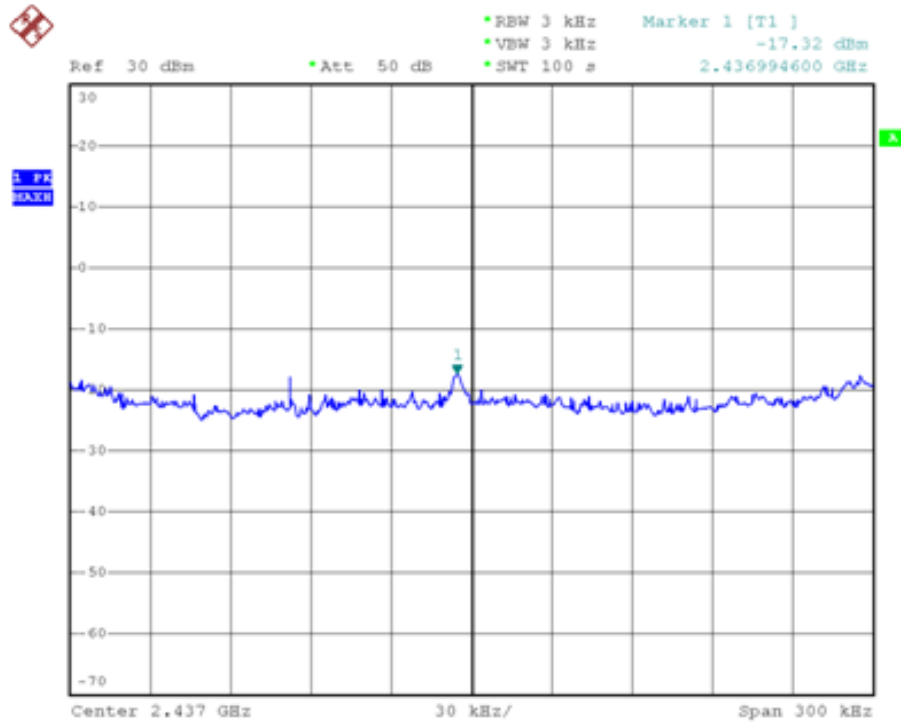

Channel 11 (2462MHz)

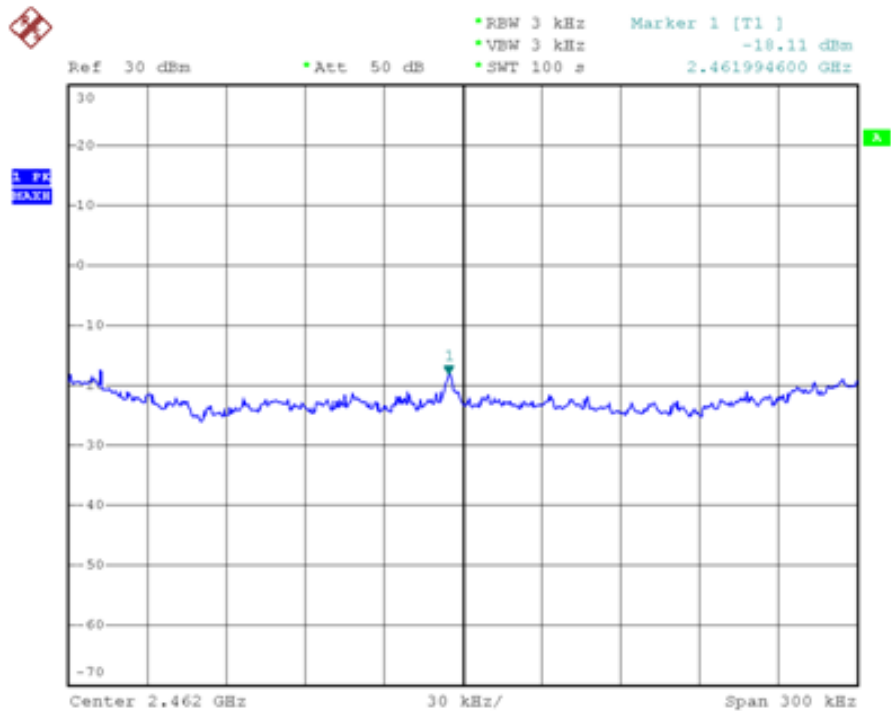



Test Item	Power Spectral Density
Test Mode	Mode 4: Transmit by 802.11n (40MHz) (An0)
Test Date	2010-06-30

Channel	Frequency (MHz)	Power Spectral Density (dBm/3kHz)	Limit (dBm/3kHz)	Result
03	2422	-17.00	8	Pass
06	2437	-17.36	8	Pass
09	2452	-20.09	8	Pass

Channel 03 (2422MHz)

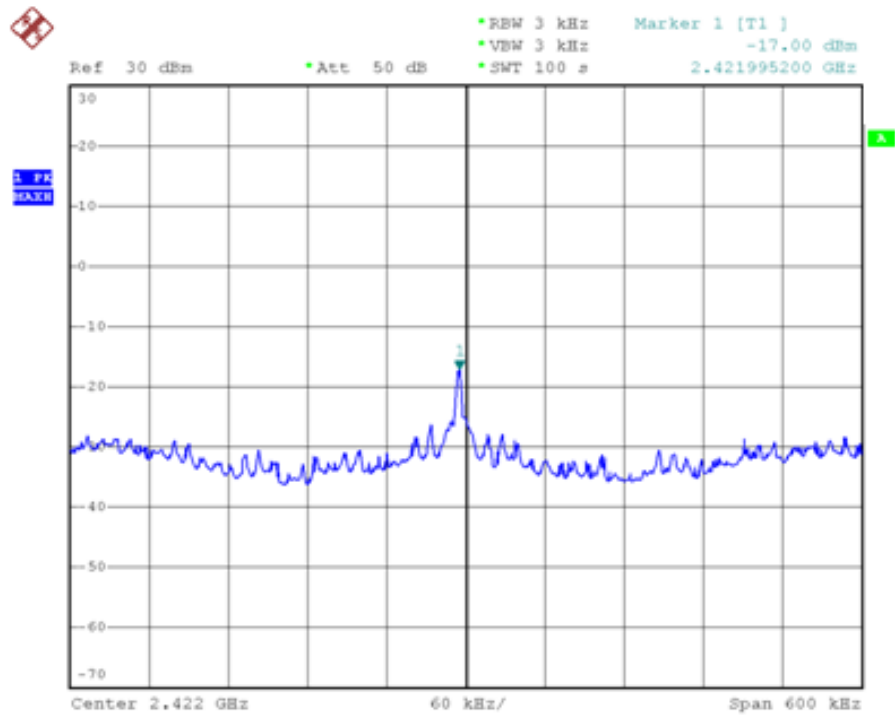



Channel 06 (2437MHz)

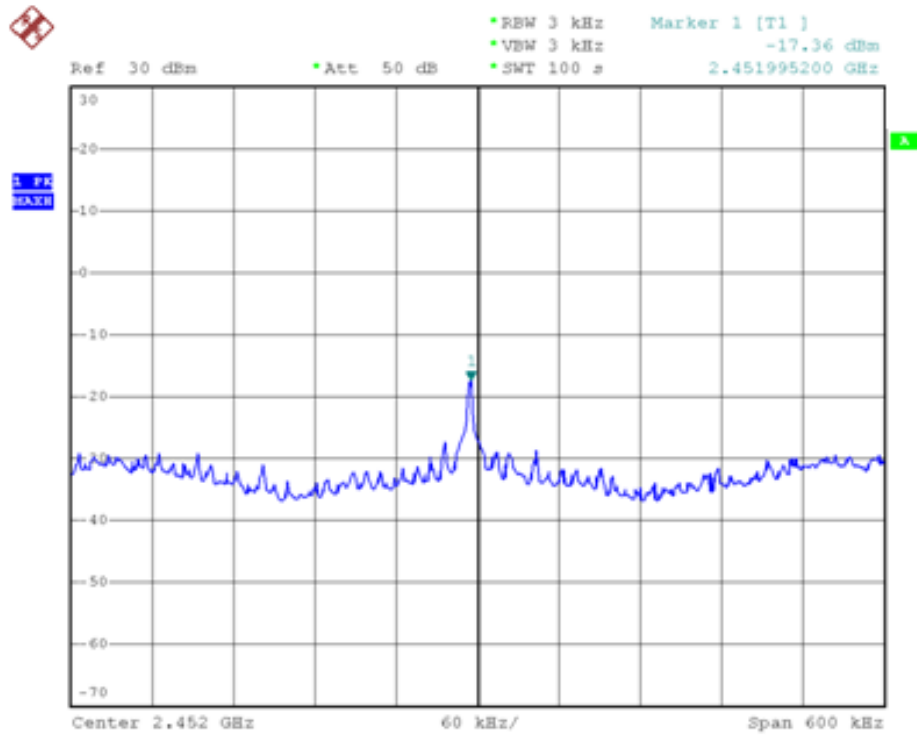

Channel 09 (2452MHz)

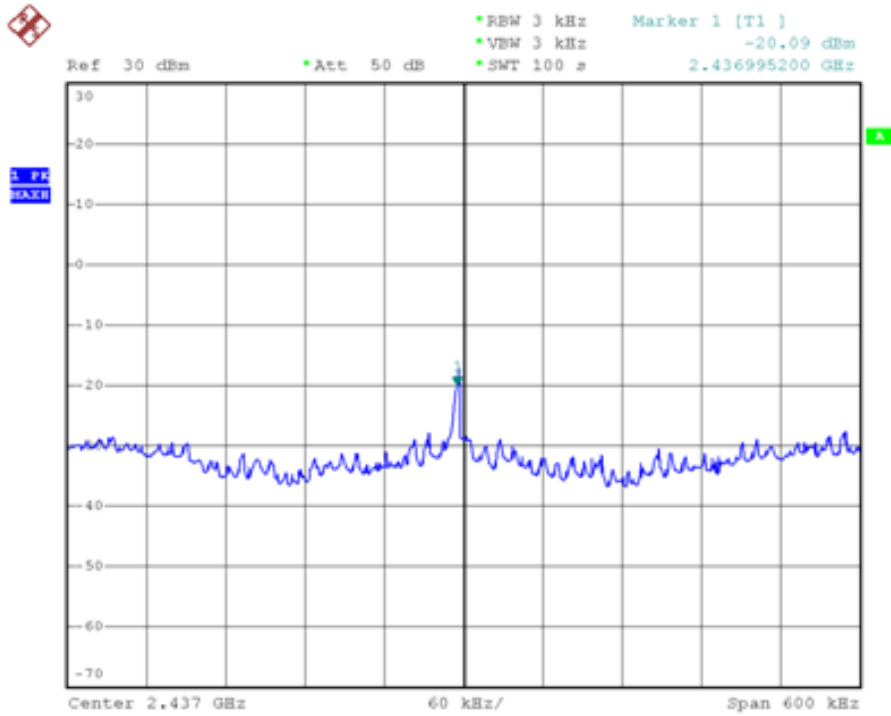



Test Item	Power Spectral Density
Test Mode	Mode 4: Transmit by 802.11n (40MHz) (An1)
Test Date	2010-06-30

Channel	Frequency (MHz)	Power Spectral Density (dBm/3kHz)	Limit (dBm/3kHz)	Result
03	2422	-21.07	8	Pass
06	2437	-23.88	8	Pass
09	2452	-24.28	8	Pass

Channel 03 (2422MHz)

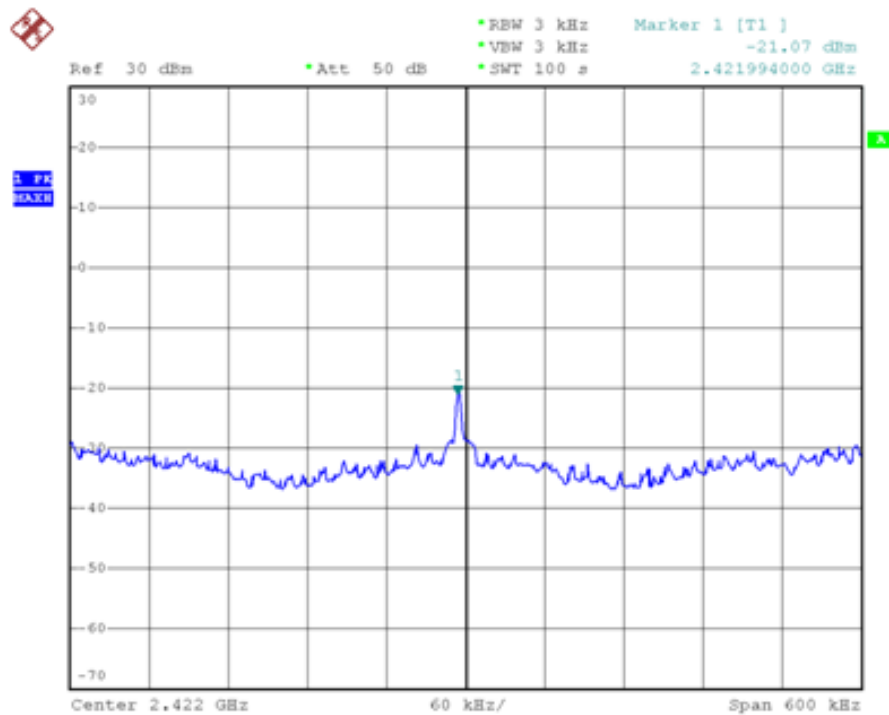



Channel 06 (2437MHz)

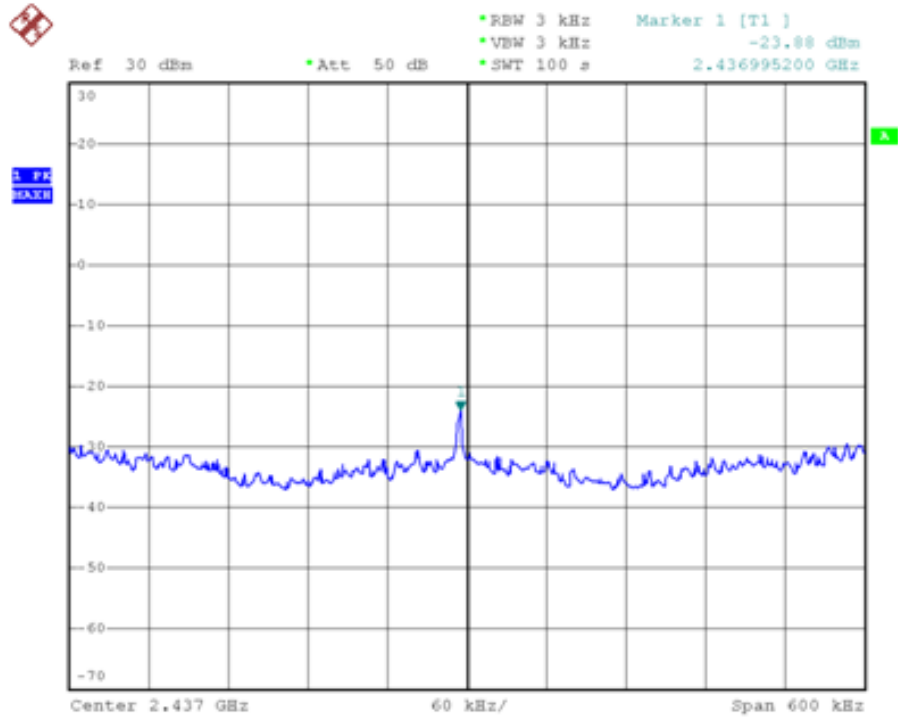

Channel 09 (2452MHz)

