

RF MEASUREMENT REPORT

FCC ID: I88EX2210-T0
Applicant: Zyxel Communications Corporation
Product: Dual-Band Wireless AX1800 Gigabit Ethernet Gateway
Model No.: EX2210-T0
Brand Name: ZYXEL
FCC Classification: Digital Transmission System (DTS)
FCC Rule Part(s): Part 15 Subpart C (Section 15.247)
Result: Complies
Test Date: April 09 ~ May 07, 2022

Reviewed By:

Kevin Guo

Approved By:

Robin Wu



The test results relate only to the samples tested.

This equipment has been shown to be capable of compliance with the applicable technical standards as indicated in the measurement report and was tested in accordance with the measurement procedures specified in ANSI C63.10-2013. Test results reported herein relate only to the item(s) tested.

The test report shall not be reproduced except in full without the written approval of MRT Technology (Suzhou) Co., Ltd.

Revision History

Report No.	Version	Description	Issue Date	Note
2203RSU090-U1	Rev. 01	Initial Report	05-26-2022	Valid

CONTENTS

Description	Page
1. General Information	5
1.1. Applicant	5
1.2. Manufacturer	5
1.3. Testing Facility	5
1.4. Product Information.....	6
1.5. Radio Specification	6
1.6. Working Frequencies	7
1.7. Antenna Details.....	7
2. Test Configuration	8
2.1. Test Mode.....	8
2.2. Test System Connection Diagram.....	8
2.3. Test Software	9
2.4. Applied Standards.....	9
2.5. Test Environment Condition	9
3. Antenna Requirements	10
4. Measuring Instrument	11
5. Measurement Uncertainty.....	12
6. Test Result.....	13
6.1. Summary.....	13
6.2. 6dB Bandwidth Measurement.....	14
6.2.1. Test Limit	14
6.2.2. Test Procedure	14
6.2.3. Test Setting	14
6.2.4. Test Setup	14
6.2.5. Test Result	14
6.3. Output Power Measurement	15
6.3.1. Test Limit	15
6.3.2. Test Procedure	15
6.3.3. Test Setting	15
6.3.4. Test Setup	15
6.3.5. Test Result	15
6.4. Power Spectral Density Measurement	16
6.4.1. Test Limit	16
6.4.2. Test Procedure	16
6.4.3. Test Setting	16

6.4.4.	Test Setup	17
6.4.5.	Test Result	17
6.5.	Conducted Band Edge and Out-of-Band Emissions Measurement	18
6.5.1.	Test Limit	18
6.5.2.	Test Procedure	18
6.5.3.	Test Settintg	18
6.5.4.	Test Setup	19
6.5.5.	Test Result	19
6.6.	Radiated Spurious Emission Measurement.....	20
6.6.1.	Test Limit	20
6.6.2.	Test Procedure	20
6.6.3.	Test Setting	20
6.6.4.	Test Setup	22
6.6.5.	Test Result	22
6.7.	Radiated Restricted Band Edge Measurement	23
6.7.1.	Test Limit	23
6.7.2.	Test Procedure	24
6.7.3.	Test Setting	24
6.7.4.	Test Setup	25
6.7.5.	Test Result	25
6.8.	AC Conducted Emissions Measurement	26
6.8.1.	Test Limit	26
6.8.2.	Test Setup	26
6.8.3.	Test Result	26
Appendix A – Test Result		27
A.1	Duty Cycle Test Result	27
A.2	6dB Bandwidth Test Result	28
A.3	Output Power Test Result	32
A.4	Power Spectral Density Test Result.....	34
A.5	Conducted Band Edge and Out-of-Band Emissions Test Result.....	41
A.6	Radiated Spurious Emission Test Result.....	66
A.7	Radiated Restricted Band Edge Test Result.....	74
A.8	AC Conducted Emissions Test Result	146
Appendix B – Test Setup Photograph		148
Appendix C – EUT Photograph		149

1.4. Product Information

Product Name	Dual-Band Wireless AX1800 Gigabit Ethernet Gateway
Model No.	EX2210-T0
Serial No.	S220Z08004458(Conducted) S220Z08004467(Radiated)
Wi-Fi Specification	802.11a/b/g/n/ac/ax
Antenna Information	Refer to clause 1.7
Operating Temperature	0°C to 40°C
Accessories	
Adapter	Model No.: MAUS-1201501801 Input Power: 100 - 240V ~ 50/60Hz, 0.5A Output Power: 12V dc 1.5A
Remark: The information of EUT was provided by the manufacturer, and the accuracy of the information shall be the responsibility of the manufacturer.	

1.5. Radio Specification

Frequency Range	802.11b/g/n-HT20/ax-HE20: 2412 ~ 2462MHz 802.11n-HT40/ax-HE40: 2022~2452MHz
Channel Number	802.11b/g/n-HT20/ax-HE20: 11 802.11n-HT40/ax-HE40: 9
Type of Modulation	802.11b: DSSS 802.11g/n: OFDM 802.11ax: OFDMA
Data Rate	802.11b: 1/2/5.5/11Mbps 802.11g: 6/9/12/18/24/36/48/54Mbps 802.11n: up to 300Mbps 802.11ax: up to 573.6Mbps

Note: For other features of this EUT, test report will be issued separately.

1.6. Working Frequencies

802.11b/g/n-HT20/ax-HE20

Channel	Frequency	Channel	Frequency	Channel	Frequency
01	2412 MHz	02	2417 MHz	03	2422 MHz
04	2427 MHz	05	2432 MHz	06	2437 MHz
07	2442 MHz	08	2447 MHz	09	2452 MHz
10	2457 MHz	11	2462 MHz	--	--

802.11n-HT40/ax-HE40

Channel	Frequency	Channel	Frequency	Channel	Frequency
03	2422 MHz	04	2427 MHz	05	2432 MHz
06	2437 MHz	07	2442 MHz	08	2447 MHz
09	2452 MHz	--	--	--	--

1.7. Antenna Details

Antenna Type	Frequency Band (MHz)	Tx Paths	Antenna Gain (dBi)		Beamforming Directional Gain (dBi)	CDD Directional Gain (dBi)	
			Ant 0	Ant 1		For Power	For PSD
PCB Antenna	2412 ~ 2462	2	3.5	2.9	6.51	3.5	6.51
	5180 ~ 5320	2	4.2	3.2	7.21	4.2	7.21
	5500 ~ 5720	2	4.0	3.3	7.01	4.0	7.01
	5745 ~ 5825	2	4.6	2.9	7.61	4.6	7.61

Remark:

- The EUT supports Cyclic Delay Diversity (CDD) mode and CDD signals are correlated. If all antennas have the same gain, G_{ANT} , Directional gain = $G_{ANT} + \text{Array Gain}$, where Array Gain is as follows.
 - For power spectral density (PSD) measurements on all devices, Array Gain = $10 \log(N_{ANT}/N_{SS})$ dB;
 - For power measurements on IEEE 802.11 devices, Array Gain = 0 dB for $N_{ANT} \leq 4$;
- The EUT also supports Beam Forming mode, and the Beam Forming support 802.11ac/ax. BF Directional gain = $G_{ANT} + 10 \log(N_{ANT})$. For beamforming operation, manufacturer automatically backs power down based on a $10 \log(N)$ factor based on CDD power.

2. Test Configuration

2.1. Test Mode

Mode 1: Transmit by 802.11b (11Mbps) (CDD Mode)
Mode 2: Transmit by 802.11g (6Mbps) (CDD Mode)
Mode 3: Transmit by 802.11n-HT20 (MCS0) (CDD Mode)
Mode 4: Transmit by 802.11n-HT40 (MCS0) (CDD Mode)
Mode 5: Transmit by 802.11ax-HE20 (MCS0) (CDD Mode)
Mode 6: Transmit by 802.11ax-HE40 (MCS0) (CDD Mode)

2.2. Test System Connection Diagram

The device was tested per the guidance ANSI C63.10: 2013 was used to reference the appropriate EUT setup for radiated emissions testing and AC line conducted testing.

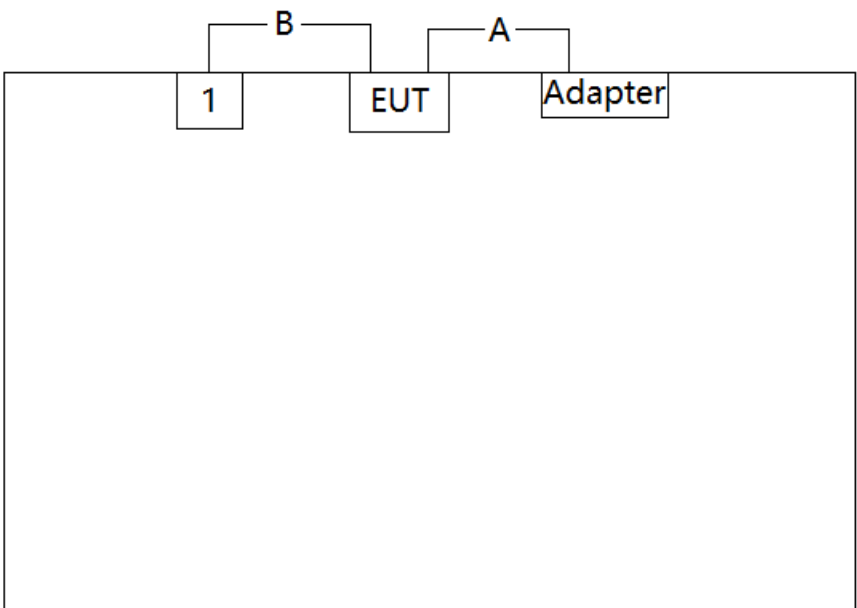
Connection Diagram – Radiated Emission testing & AC Conducted Emissions			
			
Cable Type		Cable Description	
A	Power Cable	Non shielded, 1.5m	
B	LAN Cable	Non shielded, 2.0m	
Product		Manufacturer	Model No.
1	Notebook	Lenovo	E495

2.3. Test Software

The test utility software used during testing was "QATool_Dbg.exe", and the version was UIv2.17_DLLv6.00.

Note: Final power setting please refer to operational description.

2.4. Applied Standards

According to the specifications of the manufacturer, the EUT must comply with the requirements of the following standards:

- FCC Part 15.247
- KDB 558074 D01v05r02
- KDB 662911 D01v02r01
- ANSI C63.10-2013

2.5. Test Environment Condition

Ambient Temperature	15 ~ 35°C
Relative Humidity	20 ~ 75%RH

3. Antenna Requirements

Excerpt from §15.203 of the FCC Rules/Regulations:

“An intentional radiator antenna shall be designed to ensure that no antenna other than that furnished by the responsible party can be used with the device. The use of a permanently attached antenna or of an antenna that uses a unique coupling to the intentional radiator shall be considered sufficient to comply with the provisions of this section.”

- The antenna of the device is **permanently attached**.
- There are no provisions for connection to an external antenna.

Conclusion:

The unit complies with the requirement of §15.203.

4. Measuring Instrument

Instrument	Manufacturer	Model No.	Asset No.	Cali. Interval	Cali. Due Date	Test Site
Preamplifier	Schwarzbeck	BBV 9721	MRTSUE06121	1 year	2022/6/9	SIP-AC3
Horn Antenna	Schwarzbeck	BBHA 9170	MRTSUE06598	1 year	2022/11/9	SIP-AC3
Horn Antenna	R&S	HF907	MRTSUE06611	1 year	2022/9/12	SIP-AC3
Thermohygrometer	testo	608-H1	MRTSUE06619	1 year	2022/11/2	SIP-AC3
Thermohygrometer	testo	608-H1	MRTSUE06622	1 year	2022/11/28	SIP-AC3
Preamplifier	EMCI	EMC012645SE	MRTSUE06642	1 year	2023/1/13	SIP-AC3
TRILOG Antenna	Schwarzbeck	VULB 9168	MRTSUE06646	1 year	2022/8/26	SIP-AC3
Loop Antenna	Schwarzbeck	FMZB 1519 B	MRTSUE06937	1 year	2023/3/14	SIP-AC3
EMI Test Receiver	R&S	ESR3	MRTSUE06185	1 year	2022/12/29	SIP-AC3
Signal Analyzer	Keysight	N9010B	MRTSUE06559	1 year	2022/6/24	SIP-AC3
Anechoic Chamber	RIKEN	SIP-AC3	MRTSUE06782	1 year	2022/12/23	SIP-AC3
Signal Analyzer	Keysight	N9030B	MRTSUE06395	1 year	2022/8/8	SIP-TR1
USB Power Sensor	Keysight	U2021XA	MRTSUE06595	1 year	2022/9/7	SIP-TR1
Thermohygrometer	testo	Testo 608-H1	MRTSUE11022	1 year	2022/11/2	SIP-TR1
Two-Line V-Network	R&S	ENV216	MRTSUE06003	1 year	2022/6/8	SIP-SR2
EMI Test Receiver	R&S	ESR3	MRTSUE06612	1 year	2022/6/24	SIP-SR2
Thermohygrometer	testo	608-H1	MRTSUE06621	1 year	2022/11/28	SIP-SR2
Shielding Room	MIX-BEP	SIP-SR2	MRTSUE06949	N/A	N/A	SIP-SR2

Software	Version	Function
EMI Software	V3.0.0	EMI Test Software
Controller_MF 7802BS	1.02	RE Antenna&turtable
Agilent Power Panel	V R03.09.00	Power

5. Measurement Uncertainty

Where relevant, the following test uncertainty levels have been estimated for tests performed on the EUT as specified in CISPR 16-4-2. This uncertainty represents an expanded uncertainty expressed at approximately the 95% confidence level using a coverage factor of $k = 2$.

AC Conducted Emission Measurement
Measurement Uncertainty for a Level of Confidence of 95% ($U=2Uc(y)$): 9kHz~150kHz: 3.74dB 150kHz~30MHz: 3.44dB
Radiated Disturbance
Measurement Uncertainty for a Level of Confidence of 95% ($U=2Uc(y)$): Horizontal: 30MHz~300MHz: 5.04dB 300MHz~1GHz: 4.95dB 1GHz~40GHz: 6.40dB Vertical: 30MHz~300MHz: 5.24dB 300MHz~1GHz: 6.03dB 1GHz~40GHz: 6.40dB
Spurious Emissions, Conducted
Measuring Uncertainty for a Level of Confidence of 95% ($U=2Uc(y)$): 0.78dB
Output Power
Measuring Uncertainty for a Level of Confidence of 95% ($U=2Uc(y)$): 1.13dB
Power Spectrum Density
Measuring Uncertainty for a Level of Confidence of 95% ($U=2Uc(y)$): 1.15dB
Occupied Bandwidth
Measuring Uncertainty for a Level of Confidence of 95% ($U=2Uc(y)$): 0.28%

6. Test Result

6.1. Summary

FCC Section(s)	Test Description	Test Condition	Verdict
15.247(a)(2)	6dB Bandwidth	Conducted	Pass
15.247(b)(3)	Output Power		Pass
15.247(e)	Power Spectral Density		Pass
15.247(d)	Band Edge / Out-of-Band Emissions		Pass
15.205 15.209	General Field Strength (Restricted Bands and Radiated Emission)	Radiated	Pass
15.207	AC Conducted Emissions 150kHz - 30MHz	Line Conducted	Pass

Remark:

- Determining compliance is based on the test results met the regulation limits or requirements declared by clients, and the test results don't take into account the value of measurement uncertainty.
- The analyzer plots shown in this section were all taken with a correction table loaded into the analyzer. The correction table was used to account for the losses of the cables and attenuators used as part of the system to connect the EUT to the analyzer at all frequencies of interest.
- For radiated emission tests, every axis (X, Y, Z) was also verified. The test results shown in the following sections represent the worst-case emissions.
- EUT supports one configuration only in 802.11ax full RU mode, i.e. 242 tone in 11ax-HE20 and 484 tone in 11ax-HE40.

6.2. 6dB Bandwidth Measurement

6.2.1. Test Limit

The minimum 6dB bandwidth shall be at least 500 kHz.

6.2.2. Test Procedure

ANSI C63.10 - 2013 - Section 11.8

6.2.3. Test Setting

1. The Spectrum's automatic bandwidth measurement capability was used to perform the 6dB bandwidth measurement. The "X" dB bandwidth parameter was set to $X = 6$. The bandwidth measurement was not influenced by any intermediate power nulls in the fundamental emission.
2. Set RBW = 100 kHz
3. VBW $\geq 3 \times$ RBW
4. Detector = Peak
5. Trace mode = Max hold
6. Sweep = Auto couple
7. Allow the trace to stabilize

6.2.4. Test Setup

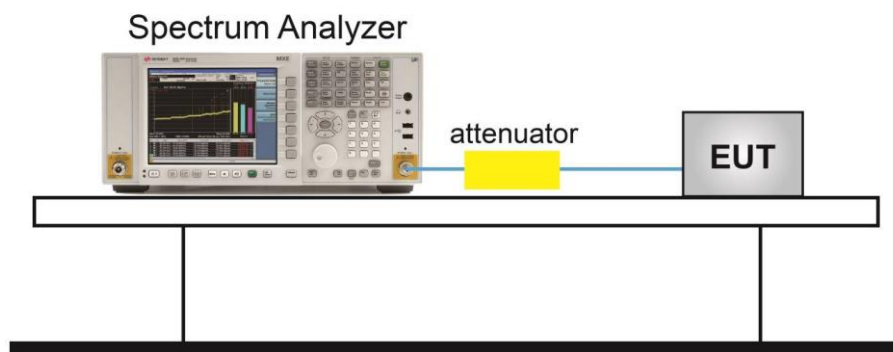

6.2.5. Test Result

Refer to Appendix A.2.

6.3. Output Power Measurement

6.3.1. Test Limit

The maximum output power shall be less 1 Watt (30dBm).

The conducted output power limit specified in paragraph FCC Part 15.247(b) of this section is based on the use of antennas with directional gains that do not exceed 6 dBi. If transmitting antennas of directional gain greater than 6 dBi are used, the conducted output power from the intentional radiator shall be reduced below the stated values in paragraphs FCC Part 15.247(b)(3) of this section, as appropriate, by the amount in dB that the directional gain of the antenna exceeds 6 dBi.

6.3.2. Test Procedure

ANSI C63.10 - 2013 - Section 11.9.2.3.2

6.3.3. Test Setting

Average Power Measurement

Average power measurements were performed only when the EUT was transmitting at its maximum power control level using a broadband power meter with a pulse sensor. The power meter implemented triggering and gating capabilities which were set up such that power measurements were recorded only during the ON time of the transmitter.

6.3.4. Test Setup

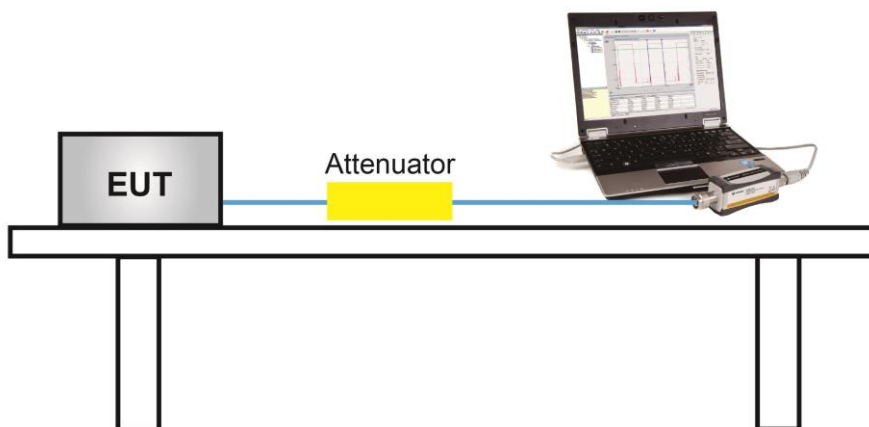

6.3.5. Test Result

Refer to Appendix A.3.

6.4. Power Spectral Density Measurement

6.4.1. Test Limit

The maximum permissible power spectral density is 8dBm in any 3 kHz band.

The same method of determining the conducted output power shall be used to determine the power spectral density.

6.4.2. Test Procedure

ANSI C63.10 - 2013 - Section 11.10.5

6.4.3. Test Setting

1. Measure the duty cycle (x) of the transmitter output signal.
2. Set instrument center frequency to DTS channel center frequency.
3. Set span to at least 1.5 times the OBW.
4. RBW = 10 kHz.
5. VBW = 30 kHz.
6. Detector = RMS.
7. Ensure that the number of measurement points in the sweep $\geq 2 \times \text{span}/\text{RBW}$.
8. Sweep time = auto couple.
9. Don't use sweep triggering. Allow sweep to "free run".
10. Employ trace averaging (RMS) mode over a minimum of 100 traces.
11. Use the peak marker function to determine the maximum amplitude level.
12. Add $10 \log (1/x)$, where x is the duty cycle measured in step (a), to the measured PSD to compute the average PSD during the actual transmission time. If measured value exceeds requirement specified by regulatory agency, then reduce RBW (but no less than 3 kHz) and repeat (note that this may require zooming in on the emission of interest and reducing the span to meet the minimum measurement point requirement as the RBW is reduced).

6.4.4. Test Setup

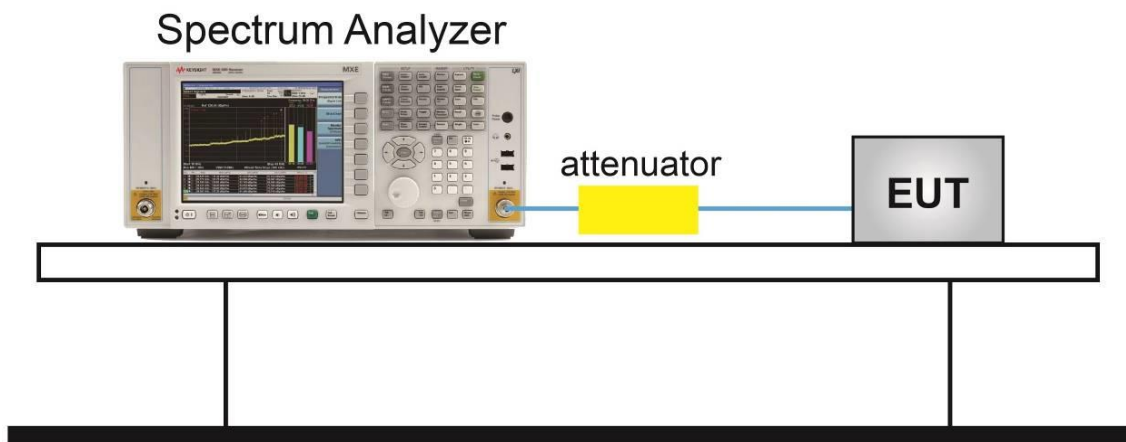

6.4.5. Test Result

Refer to Appendix A.4.

6.5. Conducted Band Edge and Out-of-Band Emissions Measurement

6.5.1. Test Limit

The limit for out-of-band spurious emissions at the band edge is 30dB below the fundamental emission level, as determined from the in-band power measurement of the DTS channel performed in a 100 kHz bandwidth per the PSD procedure.

6.5.2. Test Procedure

ANSI C63.10-2013 - Section 11.11

6.5.3. Test Setting

Reference level measurement

1. Set instrument center frequency to DTS channel center frequency
2. Set the span to ≥ 1.5 times the DTS bandwidth
3. Set the RBW = 100 kHz
4. Set the VBW $\geq 3 \times$ RBW
5. Detector = peak
6. Sweep time = auto couple
7. Trace mode = max hold
8. Allow trace to fully stabilize

Emission level measurement

1. Set the center frequency and span to encompass frequency range to be measured
2. RBW = 100kHz
3. VBW = 300kHz
4. Detector = Peak
5. Trace mode = max hold
6. Sweep time = auto couple
7. The trace was allowed to stabilize

6.5.4. Test Setup

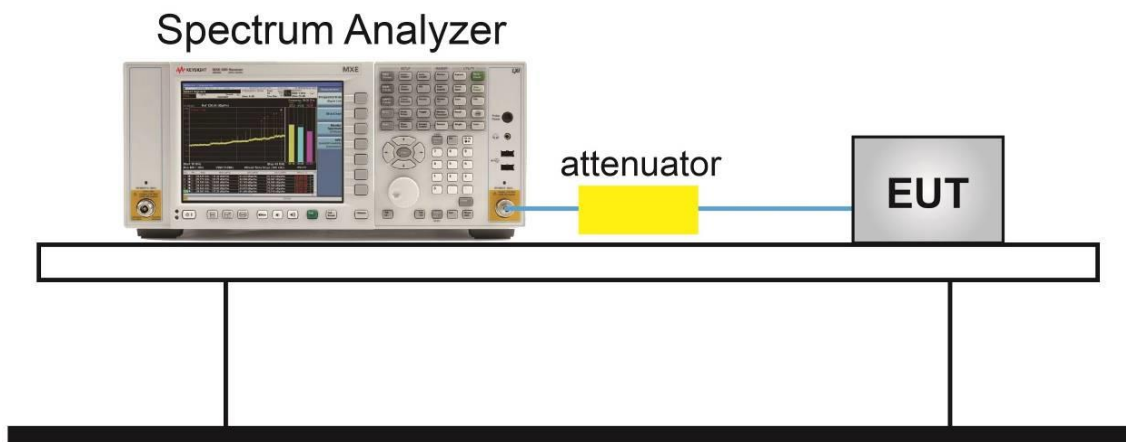

6.5.5. Test Result

Refer to Appendix A.5.

6.6. Radiated Spurious Emission Measurement

6.6.1. Test Limit

All out of band emissions appearing in a restricted band as specified in Section 15.205 of the Title 47 CFR must not exceed the limits shown in Table per Section 15.209.

FCC Part 15 Subpart C Paragraph 15.209		
Frequency [MHz]	Field Strength [uV/m]	Measured Distance [Meters]
0.009 - 0.490	2400/F (kHz)	300
0.490 - 1.705	24000/F (kHz)	30
1.705 - 30	30	30
30 - 88	100	3
88 - 216	150	3
216 - 960	200	3
Above 960	500	3

6.6.2. Test Procedure

ANSI C63.10 - 2013 - Section 11.11 & 11.12

ANSI C63.10 - 2013 - Section 6.3 (General Requirements)

ANSI C63.10 - 2013 - Section 6.4 (Standard test method below 30MHz)

ANSI C63.10 - 2013 - Section 6.5 (Standard test method above 30MHz to 1GHz)

ANSI C63.10 - 2013 - Section 6.6 (Standard test method above 1GHz)

6.6.3. Test Setting

Table 1 - RBW as a function of frequency

Frequency	RBW
9 ~ 150 kHz	200 ~ 300 Hz
0.15 ~ 30 MHz	9 ~ 10 kHz
30 ~ 1000 MHz	100 ~ 120 kHz
> 1000MHz	1MHz

Quasi-Peak Measurements below 1GHz

1. Analyzer center frequency was set to the frequency of the radiated spurious emission of interest
2. Span was set greater than 1MHz
3. RBW = as specified in Table 1
4. Detector = CISPR quasi-peak
5. Sweep time = auto couple
6. Trace was allowed to stabilize

Peak Measurements above 1GHz

1. Analyzer center frequency was set to the frequency of the radiated spurious emission of interest
2. RBW = 1MHz
3. VBW = 3MHz
4. Detector = peak
5. Sweep time = auto couple
6. Trace mode = max hold
7. Trace was allowed to stabilize

Average Measurements above 1GHz (Method VB)

1. Analyzer center frequency was set to the frequency of the radiated spurious emission of interest
2. RBW = 1MHz
3. VBW; If the EUT is configured to transmit with duty cycle $\geq 98\%$, set VBW = 10 Hz.
If the EUT duty cycle is $< 98\%$, set VBW $\geq 1/T$. T is the minimum transmission duration.
4. Detector = Peak
5. Sweep time = auto
6. Trace mode = max hold
7. Trace was allowed to stabilize

6.6.4. Test Setup

Below 1GHz Test Setup:

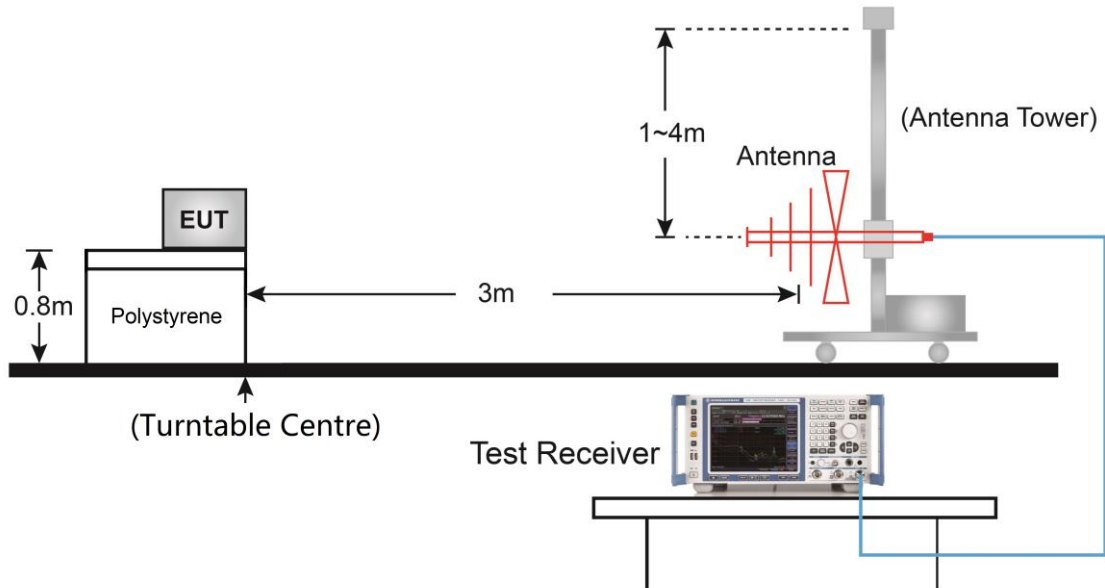

Above 1GHz Test Setup:

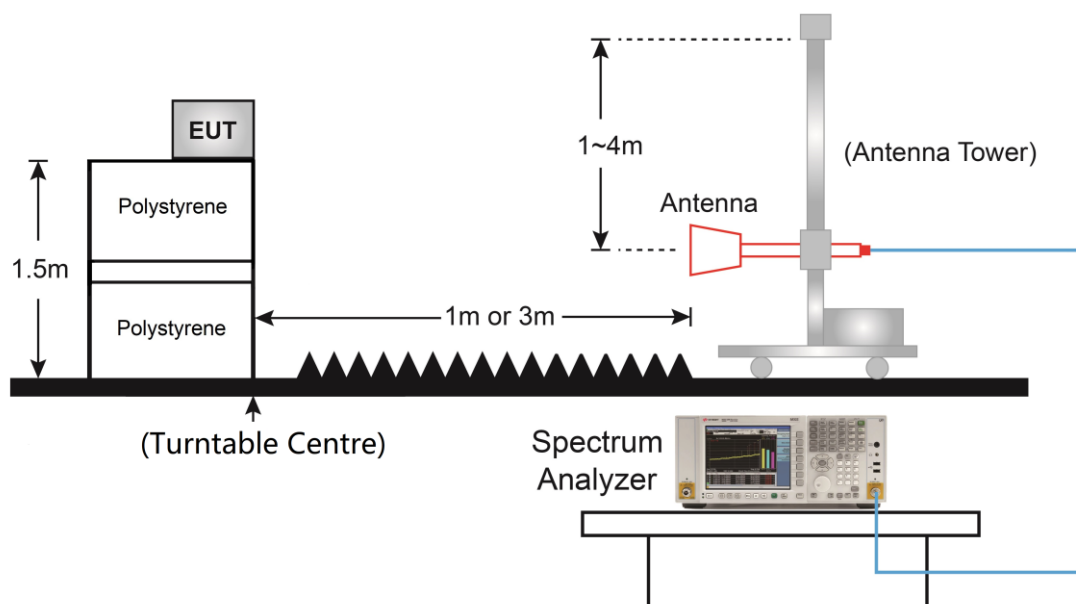

6.6.5. Test Result

Refer to Appendix A.6.

6.7. Radiated Restricted Band Edge Measurement

6.7.1. Test Limit

For 15.205 requirement:

Radiated emissions which fall in the restricted bands, as defined in Section 15.205(a) of FCC part 15, must also comply with the radiated emission limits specified in Section 15.209(a).

Frequency (MHz)	Frequency (MHz)	Frequency (MHz)	Frequency (GHz)
0.090 - 0.110	16.42 - 16.423	399.9 - 410	4.5 - 5.15
¹ 0.495 - 0.505	16.69475 - 16.69525	608 - 614	5.35 - 5.46
2.1735 - 2.1905	16.80425 - 16.80475	960 - 1240	7.25 - 7.75
4.125 - 4.128	25.5 - 25.67	1300 - 1427	8.025 - 8.5
4.17725 - 4.17775	37.5 - 38.25	1435 - 1626.5	9.0 - 9.2
4.20725 - 4.20775	73 - 74.6	1645.5 - 1646.5	9.3 - 9.5
6.215 - 6.218	74.8 - 75.2	1660 - 1710	10.6 - 12.7
6.26775 - 6.26825	108 - 121.94	1718.8 - 1722.2	13.25 - 13.4
6.31175 - 6.31225	123 - 138	2200 - 2300	14.47 - 14.5
8.291 - 8.294	149.9 - 150.05	2310 - 2390	15.35 - 16.2
8.362 - 8.366	156.52475 - 156.52525	2483.5 - 2500	17.7 - 21.4
8.37625 - 8.38675	156.7 - 156.9	2690 - 2900	22.01 - 23.12
8.41425 - 8.41475	162.0125 - 167.17	3260 - 3267	23.6 - 24.0
12.29 - 12.293	167.72 - 173.2	3332 - 3339	31.2 - 31.8
12.51975 - 12.52025	240 - 285	3345.8 - 3358	36.43 - 36.5
12.57675 - 12.57725	322 - 335.4	3600 - 4400	(²)
13.36 - 13.41	--	--	--

All out of band emissions appearing in a restricted band as specified in Section 15.205 of the Title 47CFR must not exceed the limits shown in Table per Section 15.209.

FCC Part 15 Subpart C Paragraph 15.209		
Frequency [MHz]	Field Strength [uV/m]	Measured Distance [Meters]
0.009 - 0.490	2400/F (kHz)	300
0.490 - 1.705	24000/F (kHz)	30
1.705 - 30	30	30
30 - 88	100	3
88 - 216	150	3
216 - 960	200	3
Above 960	500	3

6.7.2. Test Procedure

ANSI C63.10-2013 Section 6.3 & 6.6 & 11.13

6.7.3. Test Setting

Peak Field Strength Measurements

1. Analyzer center frequency was set to the frequency of the radiated spurious emission of interest
2. RBW = 1MHz
3. VBW = 3MHz
4. Detector = peak
5. Sweep time = auto couple
6. Trace mode = max hold
7. Trace was allowed to stabilize

Average Field Strength Measurements

1. Analyzer center frequency was set to the frequency of the radiated spurious emission of interest
2. RBW = 1MHz
3. VBW $\geq 1/T$
4. As an alternative, the instrument may be set to linear detector mode. Ensure that video filtering is applied in linear voltage domain (rather than in a log or dB domain). Some instruments require linear display mode in order to accomplish this. Others have a setting for Average-VBW Type, which can be set to "Voltage" regardless of the display mode
5. Detector = Peak
6. Sweep time = auto
7. Trace mode = max hold
8. Allow max hold to run for at least 50 times (1/duty cycle) traces

6.7.4. Test Setup

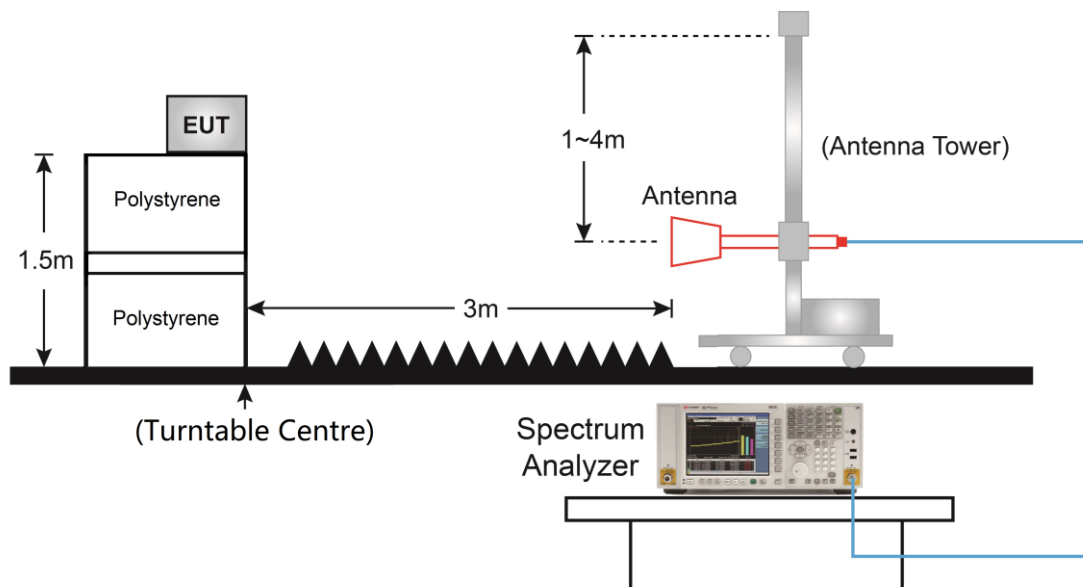

6.7.5. Test Result

Refer to Appendix A.7.

6.8. AC Conducted Emissions Measurement

6.8.1. Test Limit

FCC Part 15 Subpart C Paragraph 15.207 Limits		
Frequency (MHz)	QP (dBuV)	AV (dBuV)
0.15 - 0.50	66 - 56	56 - 46
0.50 - 5.0	56	46
5.0 - 30	60	50

Note 1: The lower limit shall apply at the transition frequencies.

Note 2: The limit decreases linearly with the logarithm of the frequency in the range 0.15MHz to 0.5MHz.

6.8.2. Test Setup

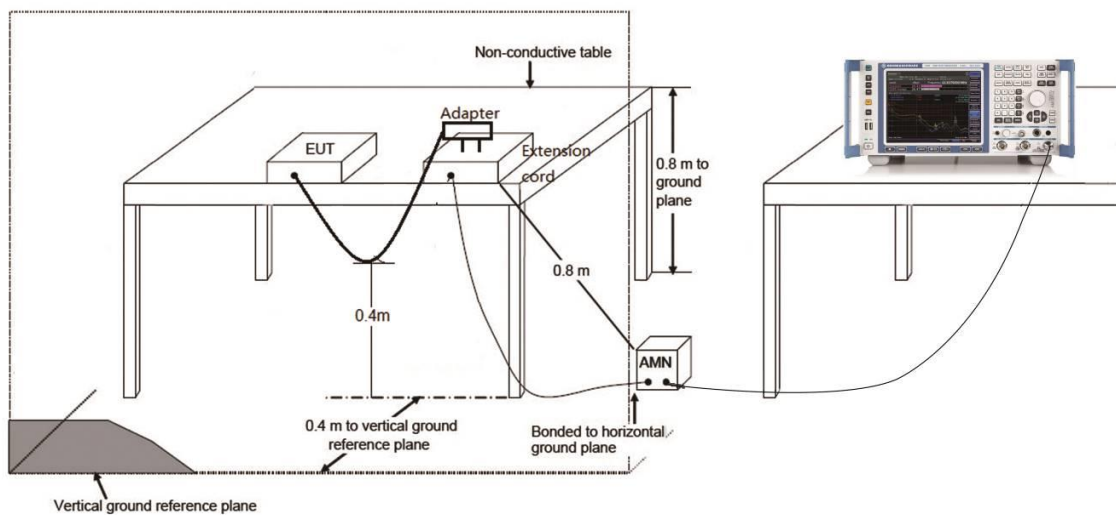

6.8.3. Test Result

Refer to Appendix A.8.

Appendix A – Test Result

A.1 Duty Cycle Test Result

Test Mode	Duty Cycle	Test Mode	Duty Cycle
802.11b	93.35%	802.11n-HT40	91.39%
802.11g	95.80%	802.11ax-HE20	84.02%
802.11n-HT20	95.13%	802.11ax-HE40	83.80%

Duty Cycle (T = Transmission Duration)

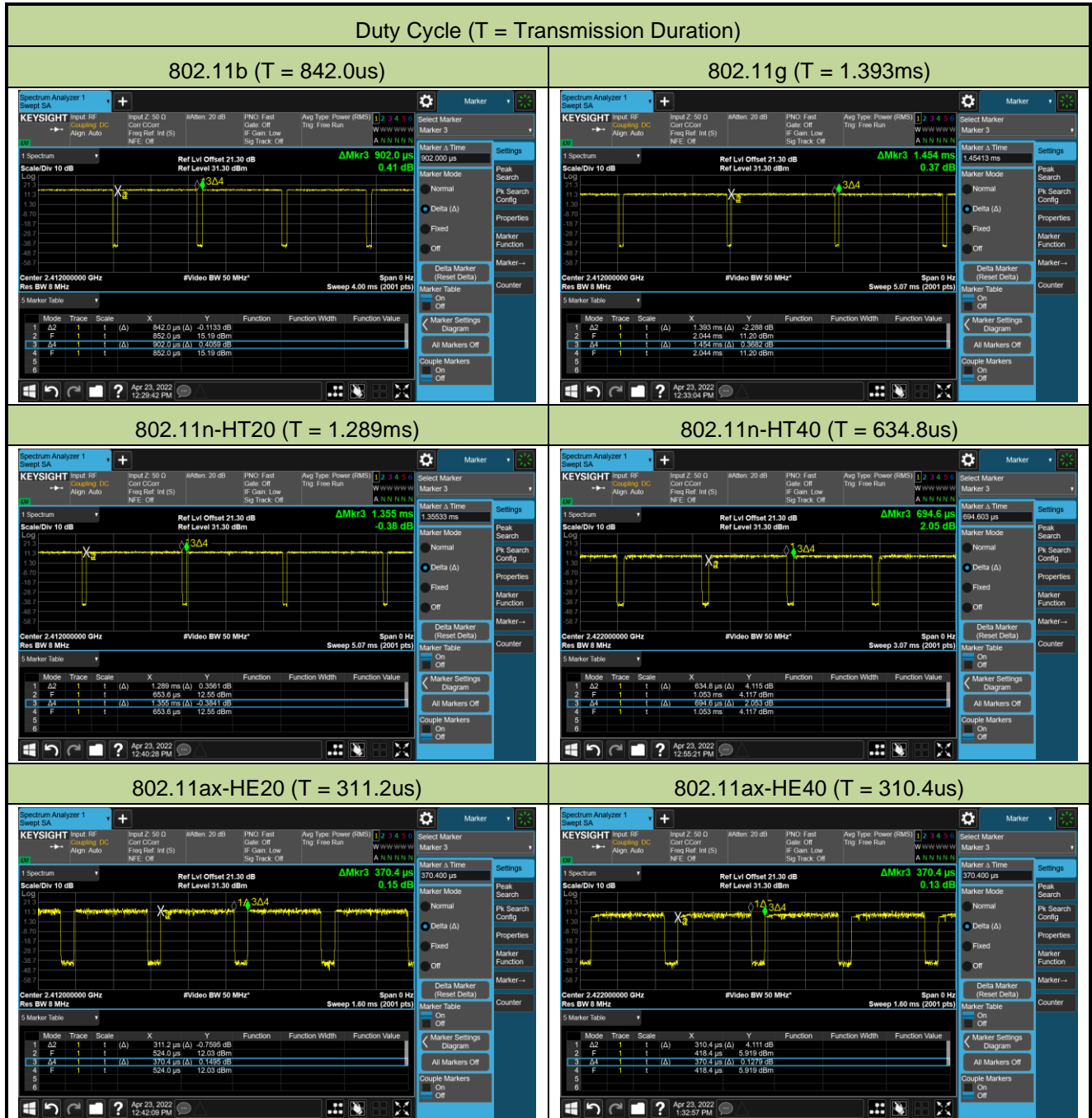

A.2 6dB Bandwidth Test Result

Test Site	SIP-TR1	Test Engineer	Nandy Zhang
Test Date	2022/04/24		

Test Mode	Data Rate / MCS	Channel No.	Frequency (MHz)	6dB Bandwidth (MHz)	Limit (MHz)
11b	11Mbps	01	2412	8.099	≥ 0.5
11b	11Mbps	06	2437	7.568	≥ 0.5
11b	11Mbps	11	2462	8.299	≥ 0.5
11g	6Mbps	01	2412	15.14	≥ 0.5
11g	6Mbps	06	2437	15.14	≥ 0.5
11g	6Mbps	11	2462	15.14	≥ 0.5
11n-HT20	MCS0	01	2412	15.14	≥ 0.5
11n-HT20	MCS0	06	2437	15.14	≥ 0.5
11n-HT20	MCS0	11	2462	15.31	≥ 0.5
11n-HT40	MCS0	03	2422	35.14	≥ 0.5
11n-HT40	MCS0	06	2437	35.15	≥ 0.5
11n-HT40	MCS0	09	2452	35.14	≥ 0.5
11ax-HE20	MCS0	01	2412	18.32	≥ 0.5
11ax-HE20	MCS0	06	2437	17.89	≥ 0.5
11ax-HE20	MCS0	11	2462	18.53	≥ 0.5
11ax-HE40	MCS0	03	2422	36.95	≥ 0.5
11ax-HE40	MCS0	06	2437	37.19	≥ 0.5
11ax-HE40	MCS0	09	2452	35.91	≥ 0.5

802.11b 6dB Bandwidth

Channel 01 (2412MHz)

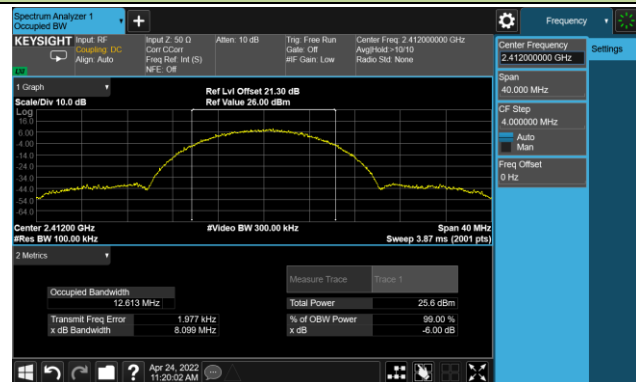

Channel 06 (2437MHz)



Channel 11 (2462MHz)

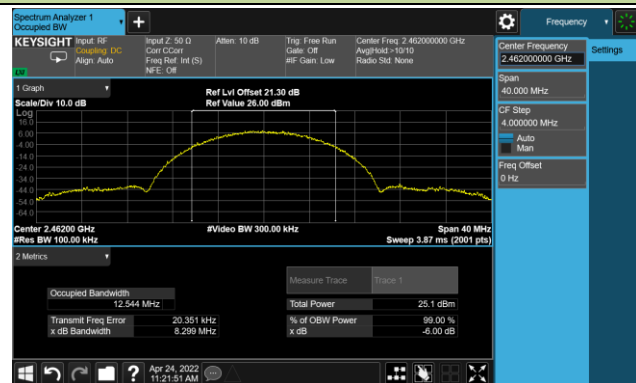

802.11g 6dB Bandwidth

Channel 01 (2412MHz)

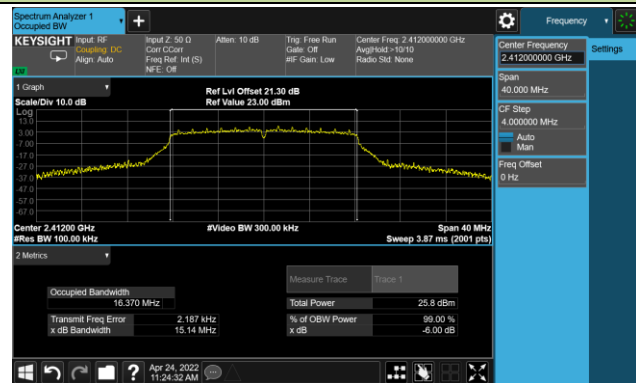

Channel 06 (2437MHz)

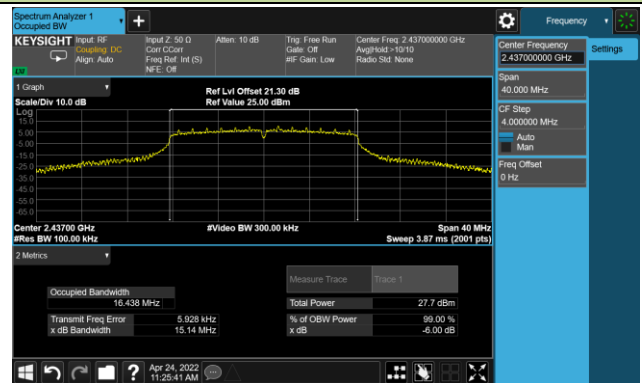

Channel 11 (2462MHz)

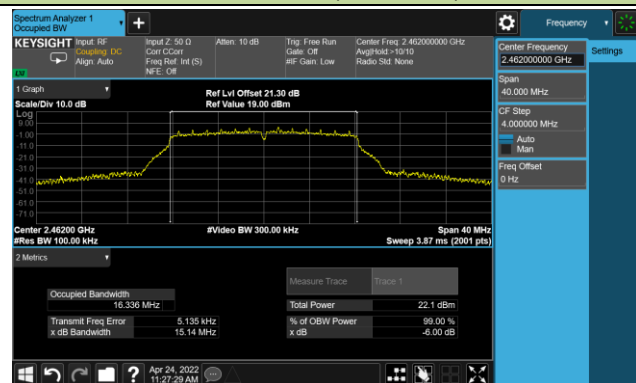

802.11n-HT20 6dB Bandwidth

Channel 01 (2412MHz)

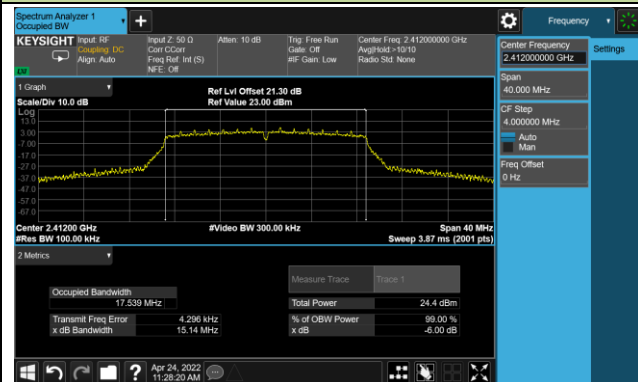

Channel 06 (2437MHz)

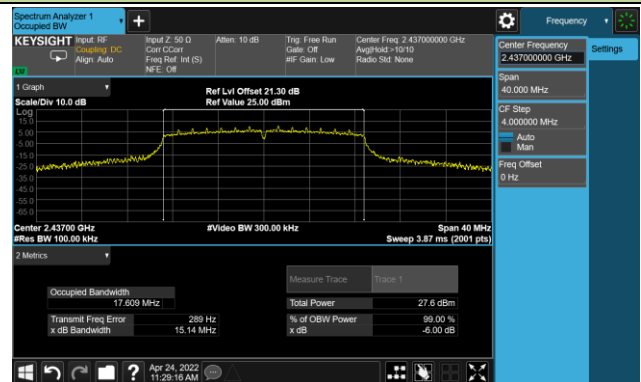

Channel 11 (2462MHz)

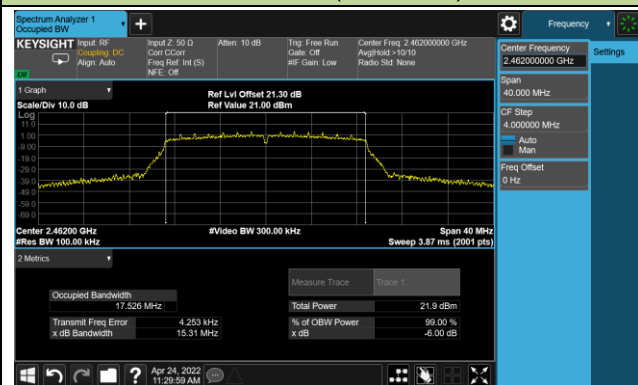

802.11n-HT40 6dB Bandwidth

Channel 03 (2422MHz)

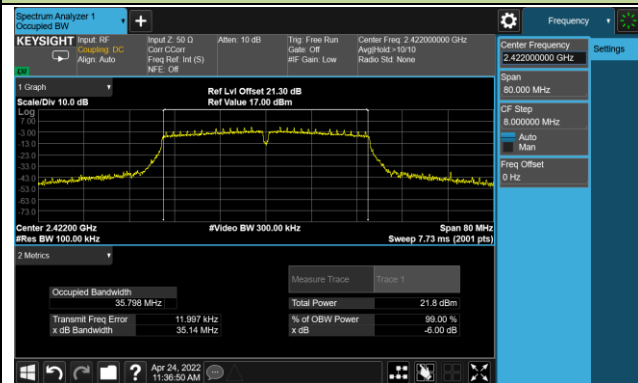

Channel 06 (2437MHz)

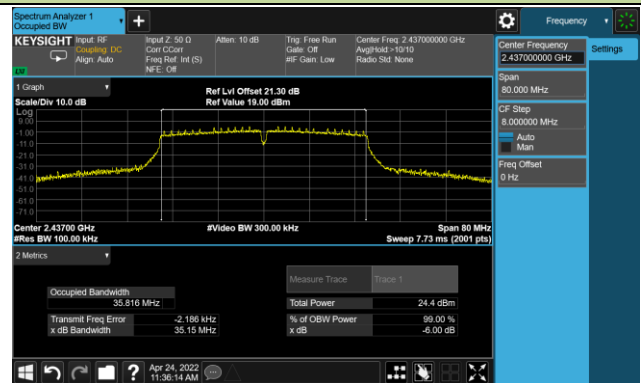

Channel 09 (2452MHz)

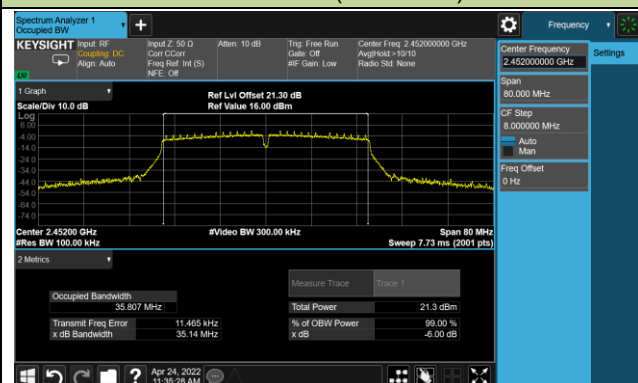

802.11ax-HE20 6dB Bandwidth

Channel 01 (2412MHz)

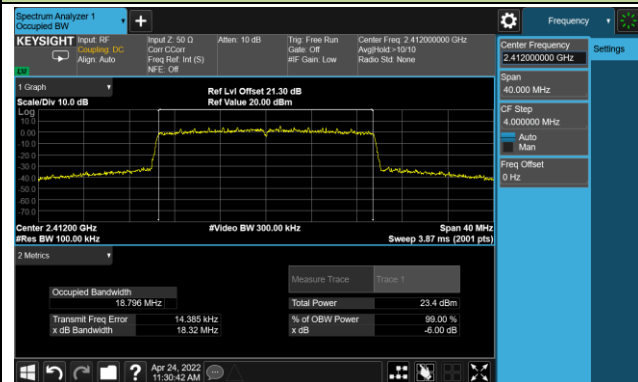

Channel 06 (2437MHz)

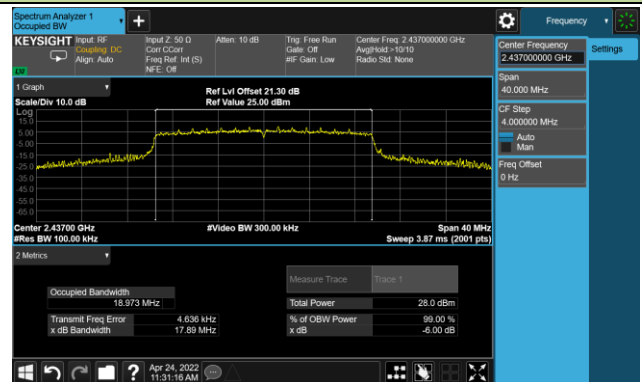

Channel 11 (2462MHz)

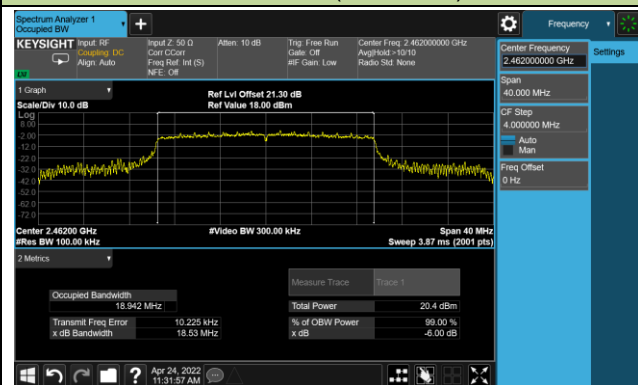

802.11ax-HE40 6dB Bandwidth

Channel 03 (2422MHz)

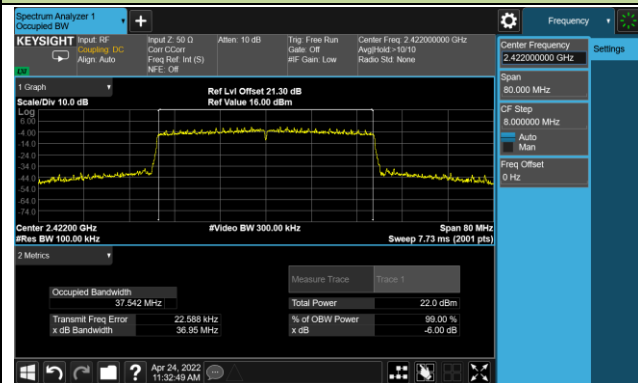

Channel 06 (2437MHz)

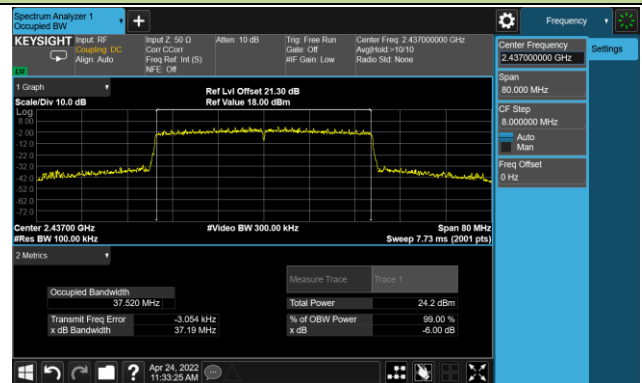

Channel 09 (2452MHz)

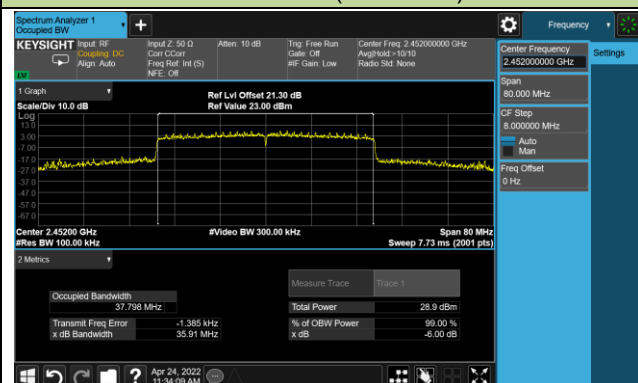

A.3 Output Power Test Result

Power output test was verified over all data rates of each mode shown as below, and then choose the maximum power output (gray marker) for final test of each channel.

Test Mode	Bandwidth (MHz)	Channel No.	Frequency (MHz)	Data Rate / MCS	Average Power (dBm)
802.11b	20	1	2412	1Mbps	16.58
				5.5Mbps	16.66
				11Mbps	17.05
802.11g	20	1	2412	6Mbps	17.95
				24Mbps	17.79
				54Mbps	16.69
802.11n	20	1	2412	MCS0	17.48
				MCS5	14.91
				MCS9	17.14
802.11n	40	3	2422	MCS0	14.78
				MCS5	12.90
				MCS9	14.44
802.11ax	20	1	2412	MCS0	16.04
				MCS6	14.26
				MCS11	12.01
802.11ax	40	3	2422	MCS0	14.34
				MCS6	12.62
				MCS11	10.26

Test Site	SIP-TR1	Test Engineer	Nandy Zhang
Test Date	2022/04/09		

Test Mode	Data Rate/ MCS	Channel No.	Freq. (MHz)	Average Power (dBm)		Total Average Power (dBm)	Limit (dBm)
				Ant 0	Ant 1		
11b	11Mbps	01	2412	17.05	16.51	19.80	≤ 30.00
11b	11Mbps	06	2437	18.40	18.50	21.46	≤ 30.00
11b	11Mbps	11	2462	15.83	15.91	18.88	≤ 30.00
11g	6Mbps	01	2412	17.95	18.46	21.22	≤ 30.00
11g	6Mbps	06	2437	21.01	20.72	23.88	≤ 30.00
11g	6Mbps	10	2457	17.49	17.55	20.53	≤ 30.00
11g	6Mbps	11	2462	16.22	15.44	18.86	≤ 30.00
11n-HT20	MCS0	01	2412	17.48	18.04	20.78	≤ 30.00
11n-HT20	MCS0	06	2437	20.57	20.68	23.64	≤ 30.00
11n-HT20	MCS0	09	2452	19.02	18.74	21.89	≤ 30.00
11n-HT20	MCS0	10	2457	16.91	16.74	19.84	≤ 30.00
11n-HT20	MCS0	11	2462	16.23	15.35	18.82	≤ 30.00
11n-HT40	MCS0	03	2422	14.78	15.31	18.06	≤ 30.00
11n-HT40	MCS0	06	2437	17.22	17.16	20.20	≤ 30.00
11n-HT40	MCS0	09	2452	13.55	13.66	16.62	≤ 30.00
11ax-HE20	MCS0	01	2412	16.04	16.59	19.33	≤ 30.00
11ax-HE20	MCS0	02	2417	18.08	18.45	21.28	≤ 30.00
11ax-HE20	MCS0	06	2437	20.56	20.67	23.63	≤ 30.00
11ax-HE20	MCS0	08	2447	17.56	18.32	20.97	≤ 30.00
11ax-HE20	MCS0	09	2452	17.87	17.21	20.56	≤ 30.00
11ax-HE20	MCS0	10	2457	16.31	17.24	19.81	≤ 30.00
11ax-HE20	MCS0	11	2462	13.01	13.40	16.22	≤ 30.00
11ax-HE40	MCS0	03	2422	14.34	14.79	17.58	≤ 30.00
11ax-HE40	MCS0	06	2437	16.31	16.51	19.42	≤ 30.00
11ax-HE40	MCS0	09	2452	13.35	13.59	16.48	≤ 30.00

Note: Total Average Power (dBm) = $10 \cdot \log \{10^{(\text{Ant 0 Average Power} / 10)} + 10^{(\text{Ant 1 Average Power} / 10)}\}$ (dBm).

A.4 Power Spectral Density Test Result

Test Site	SIP-TR1	Test Engineer	Nandy Zhang
Test Date	2022/04/16~2022/04/21		

Test Mode	Data Rate/ MCS	Channel No.	Freq. (MHz)	Average PSD (dBm/ 10kHz)		Duty Cycle (%)	Total PSD (dBm/10kHz)	Limit (dBm/ 3kHz)	Result
				Ant 0	Ant 1				
11b	11Mbps	01	2412	-9.12	-8.85	93.35	-5.67	≤ 7.49	Pass
11b	11Mbps	06	2437	-7.99	-8.15	93.35	-4.76	≤ 7.49	Pass
11b	11Mbps	11	2462	-10.37	-9.78	93.35	-6.76	≤ 7.49	Pass
11g	6Mbps	01	2412	-10.34	-9.88	95.80	-6.91	≤ 7.49	Pass
11g	6Mbps	06	2437	-7.12	-7.63	95.80	-4.17	≤ 7.49	Pass
11g	6Mbps	11	2462	-12.00	-12.81	95.80	-9.19	≤ 7.49	Pass
11n-HT20	MCS0	01	2412	-11.28	-10.53	95.13	-7.66	≤ 7.49	Pass
11n-HT20	MCS0	06	2437	-7.63	-7.83	95.13	-4.50	≤ 7.49	Pass
11n-HT20	MCS0	11	2462	-13.34	-12.55	95.13	-9.70	≤ 7.49	Pass
11n-HT40	MCS0	03	2422	-16.57	-15.17	91.39	-12.41	≤ 7.49	Pass
11n-HT40	MCS0	06	2437	-13.15	-13.05	91.39	-9.70	≤ 7.49	Pass
11n-HT40	MCS0	09	2452	-17.85	-17.25	91.39	-14.14	≤ 7.49	Pass
11ax-HE20	MCS0	01	2412	-13.91	-13.53	84.02	-9.95	≤ 7.49	Pass
11ax-HE20	MCS0	06	2437	-8.98	-8.58	84.02	-5.00	≤ 7.49	Pass
11ax-HE20	MCS0	11	2462	-16.50	-16.91	84.02	-12.94	≤ 7.49	Pass
11ax-HE40	MCS0	03	2422	-17.65	-16.44	83.80	-13.22	≤ 7.49	Pass
11ax-HE40	MCS0	06	2437	-15.69	-14.50	83.80	-11.27	≤ 7.49	Pass
11ax-HE40	MCS0	09	2452	-18.32	-17.47	83.80	-14.09	≤ 7.49	Pass

Note 1:

When EUT duty cycle > 98%, Total AV PSD = $10 \cdot \log(10^{(\text{Ant 0 Average PSD}/10)} + 10^{(\text{Ant 1 Average PSD}/10)})$.

When EUT duty cycle ≤ 98%, Total AV PSD = $10 \cdot \log(10^{(\text{Ant 0 Average PSD}/10)} + 10^{(\text{Ant 1 Average PSD}/10)}) + 10 \cdot \log(1/\text{Duty Cycle})$.

Note 2: PSD Limit (dBm/MHz) = 8 - (6.51 - 6) = 7.49 dBm/3kHz.

802.11b – Average PSD Ant 0

Channel 01 (2412MHz)

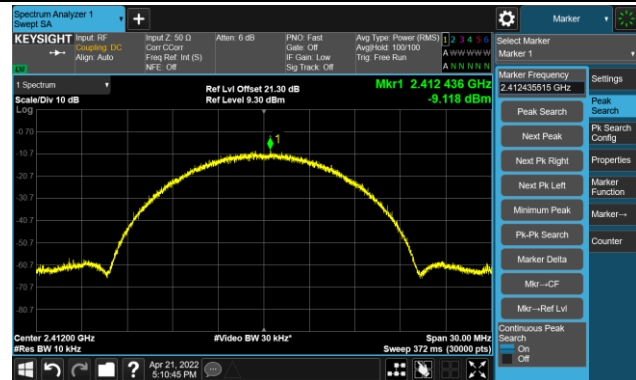

Channel 06 (2437MHz)

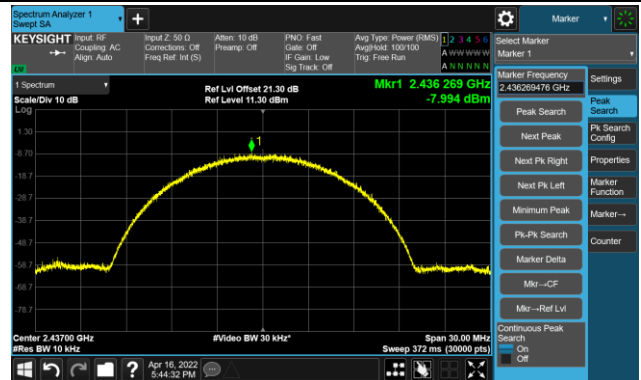

Channel 11 (2462MHz)

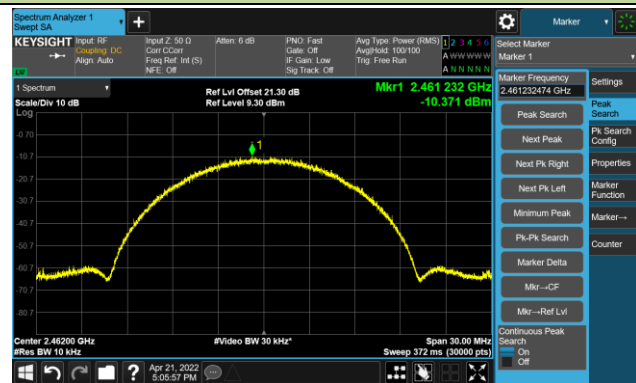

802.11g - Average PSD Ant 0

Channel 01 (2412MHz)

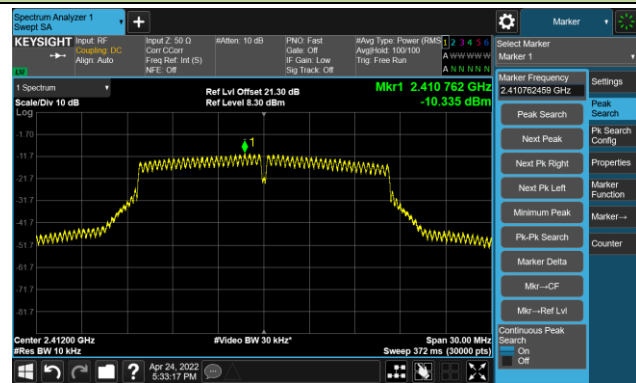

Channel 06 (2437MHz)

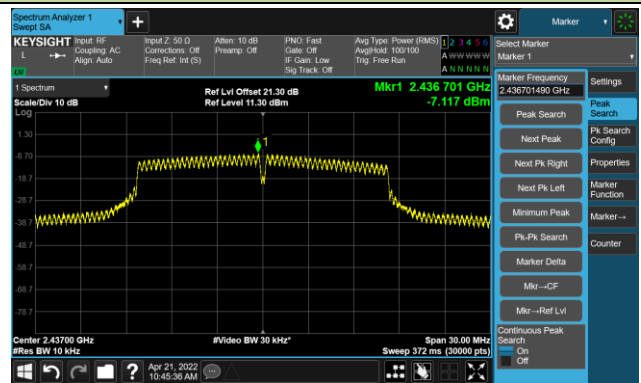

Channel 11 (2462MHz)

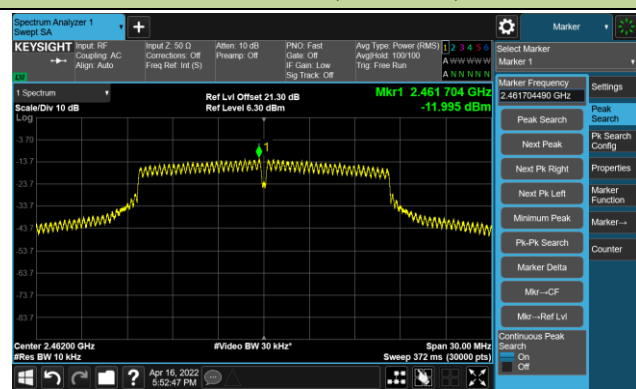

802.11n-HT20 - Average PSD Ant 0

Channel 01 (2412MHz)

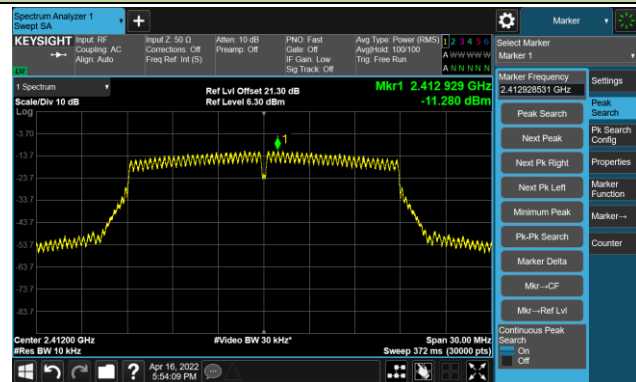

Channel 06 (2437MHz)

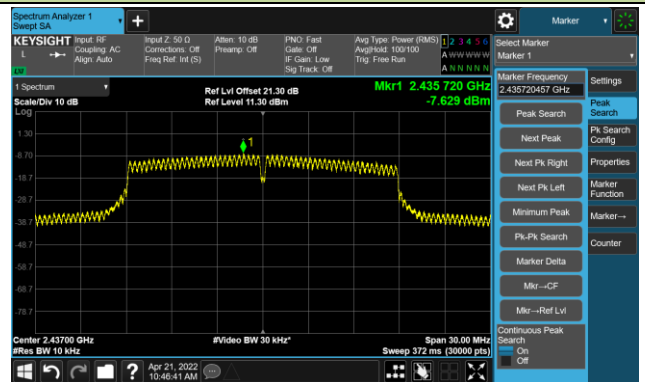

Channel 11 (2462MHz)

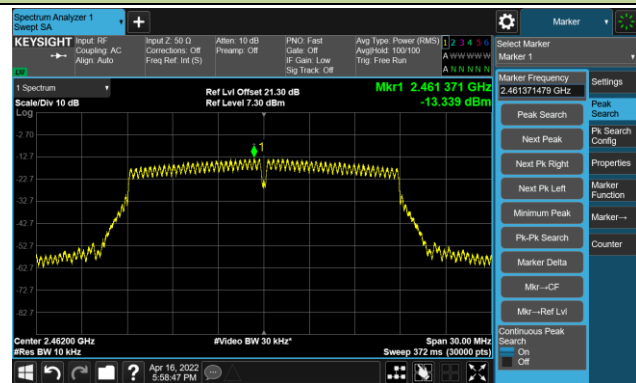

802.11n-HT40 - Average PSD Ant 0

Channel 03 (2422MHz)

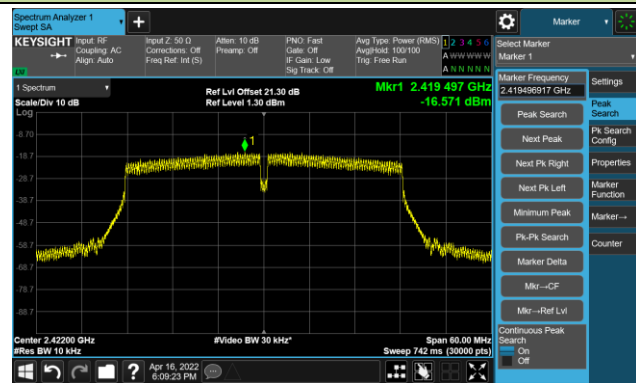

Channel 06 (2437MHz)

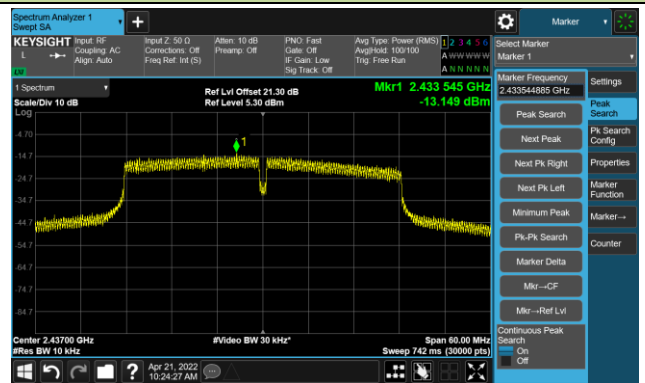

Channel 09 (2452MHz)



802.11ax-HE20 - Average PSD Ant 0

Channel 01 (2412MHz)



Channel 06 (2437MHz)

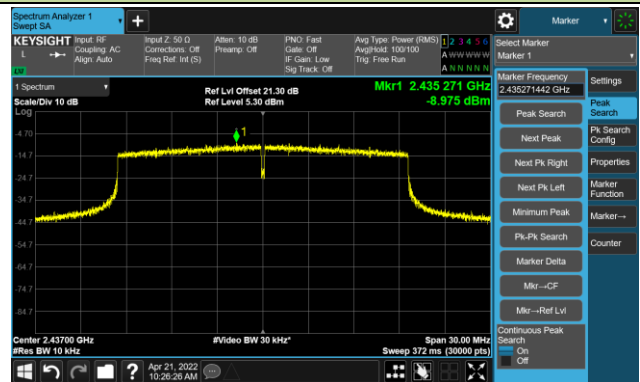

Channel 11 (2462MHz)

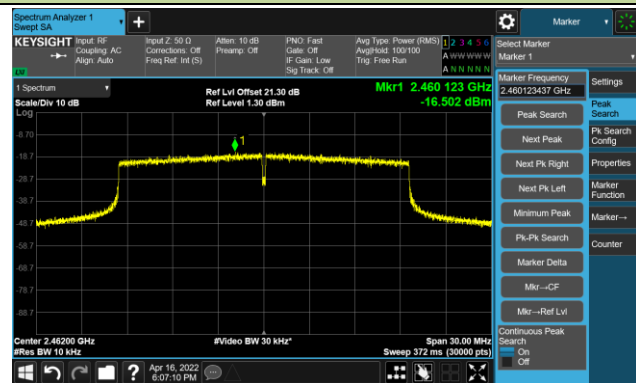

802.11ax-HE40 - Average PSD Ant 0

Channel 03 (2422MHz)



Channel 06 (2437MHz)

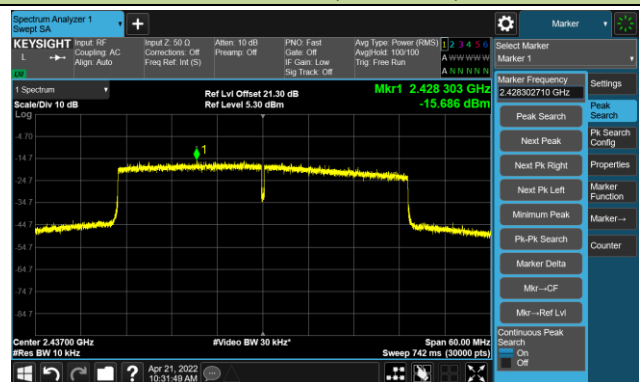

Channel 09 (2452MHz)



802.11b - Average PSD Ant 1

Channel 01 (2412MHz)

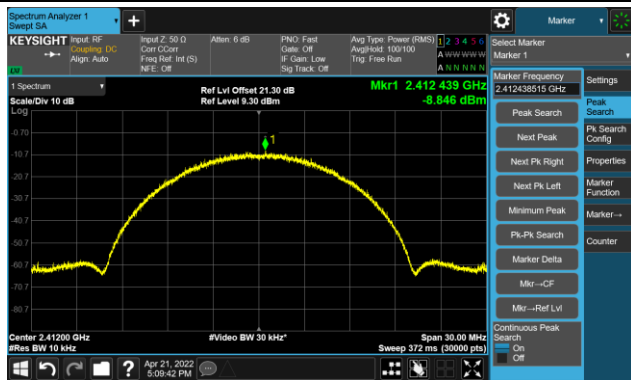

Channel 06 (2437MHz)

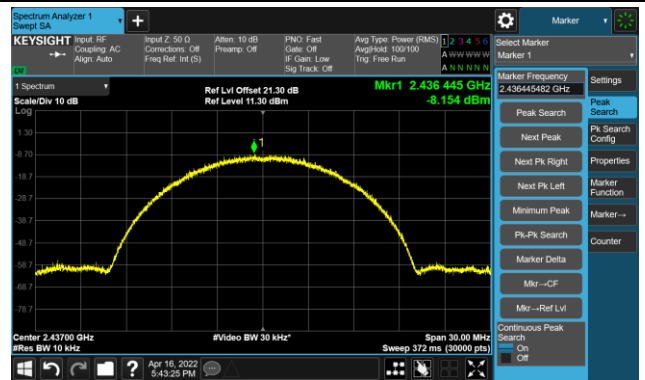

Channel 11 (2462MHz)

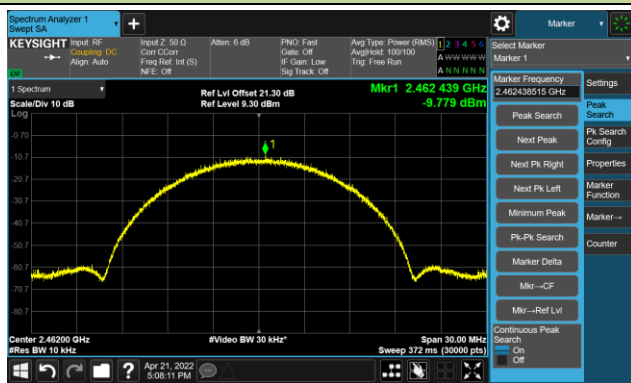

802.11g - Average PSD Ant 1

Channel 01 (2412MHz)

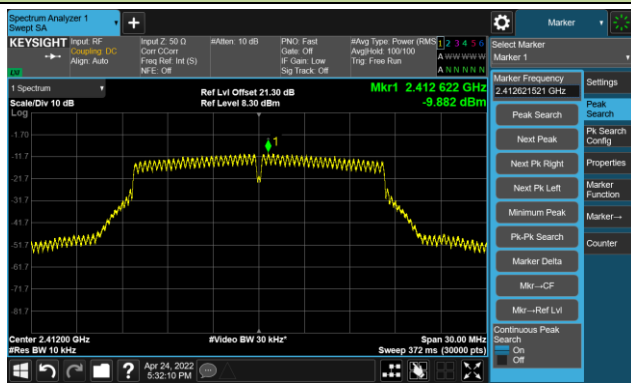

Channel 06 (2437MHz)

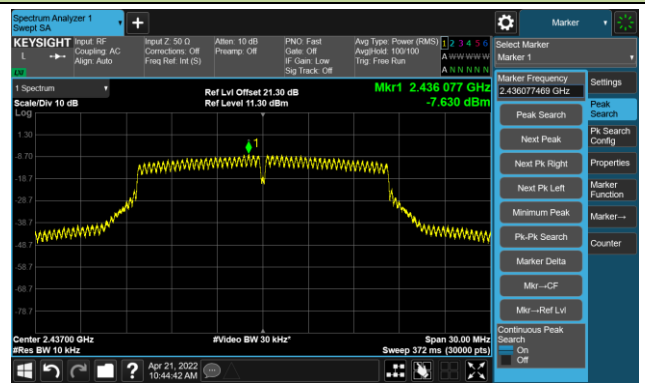

Channel 11 (2462MHz)

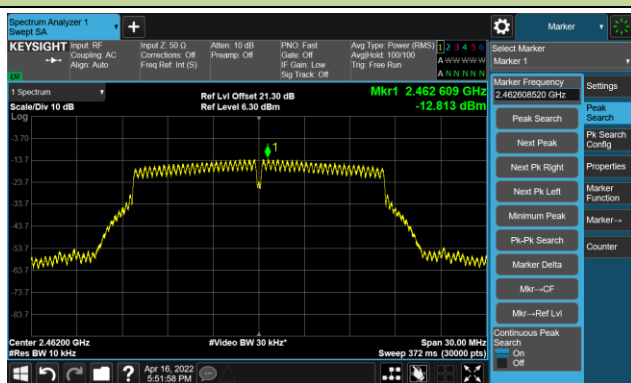

802.11n-HT20 - Average PSD Ant 1

Channel 01 (2412MHz)

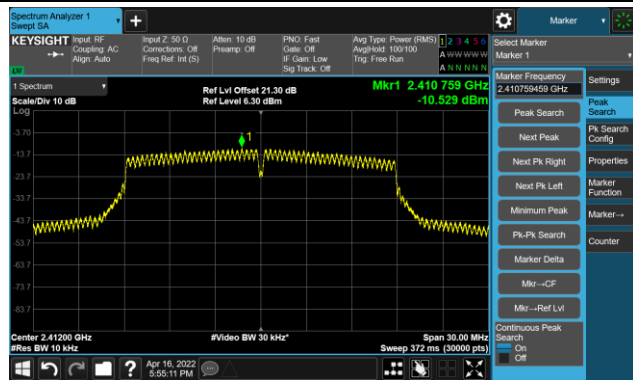

Channel 06 (2437MHz)

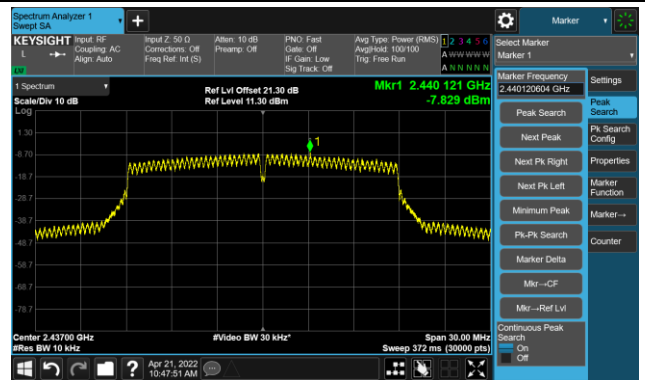

Channel 11 (2462MHz)

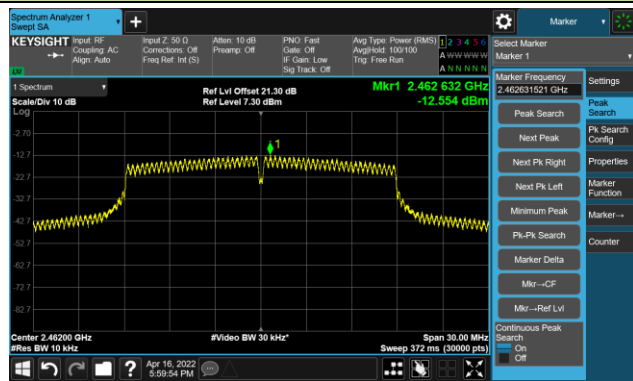

802.11n-HT40 - Average PSD Ant 1

Channel 03 (2422MHz)

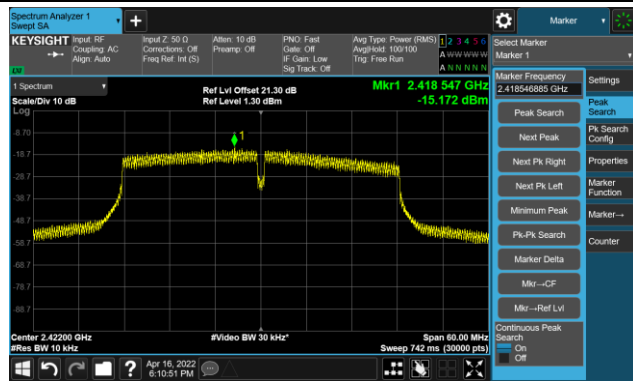

Channel 06 (2437MHz)

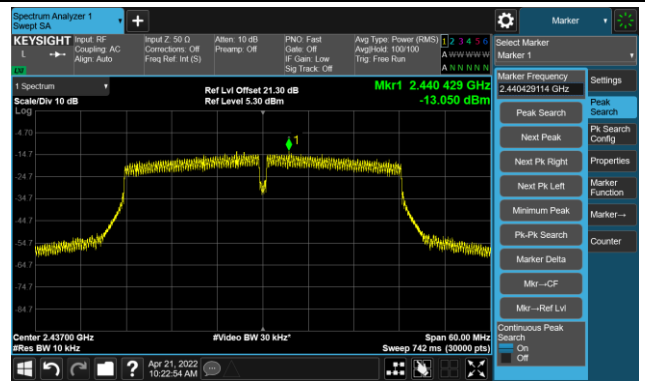

Channel 09 (2452MHz)

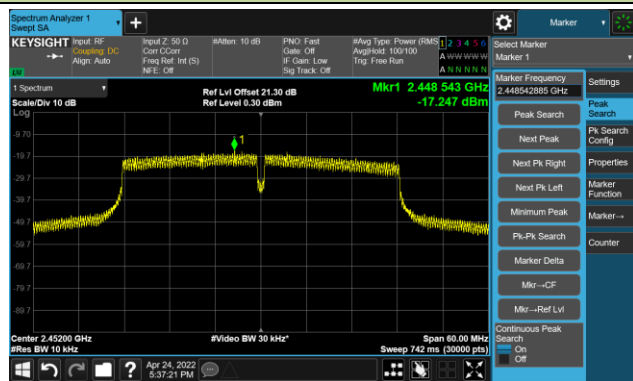

802.11ax-HE20 - Average PSD Ant 1

Channel 01 (2412MHz)

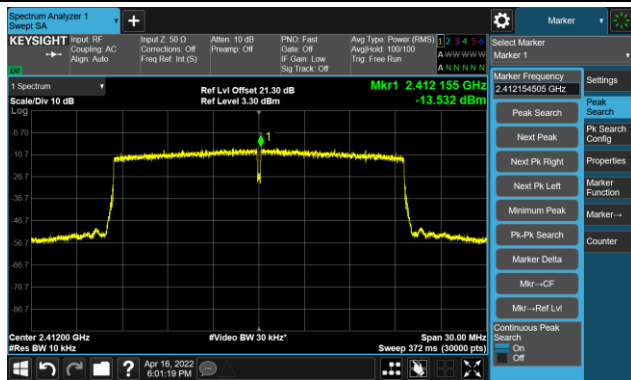

Channel 06 (2437MHz)

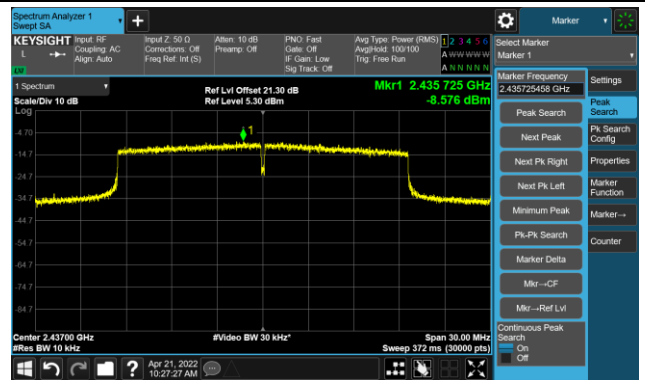

Channel 11 (2462MHz)

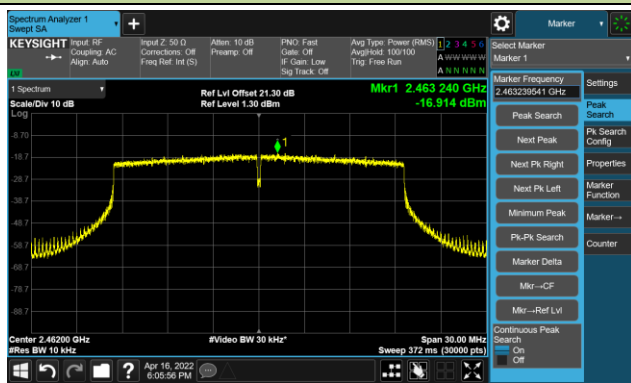

802.11ax-HE40 - Average PSD Ant 1

Channel 03 (2422MHz)



Channel 06 (2437MHz)



Channel 09 (2452MHz)



A.5 Conducted Band Edge and Out-of-Band Emissions Test Result

Test Site	SIP-TR1	Test Engineer	Nandy Zhang
Test Date	2022/04/24		

Test Mode	Data Rate / MCS	Channel No.	Frequency (MHz)	Limit
11b	11Mbps	01	2412	30dBc
11b	11Mbps	06	2437	30dBc
11b	11Mbps	11	2462	30dBc
11g	6Mbps	01	2412	30dBc
11g	6Mbps	06	2437	30dBc
11g	6Mbps	11	2462	30dBc
11n-HT20	MCS0	01	2412	30dBc
11n-HT20	MCS0	06	2437	30dBc
11n-HT20	MCS0	11	2462	30dBc
11n-HT40	MCS0	03	2422	30dBc
11n-HT40	MCS0	06	2437	30dBc
11n-HT40	MCS0	09	2452	30dBc
11ax-HE20	MCS0	01	2412	30dBc
11ax-HE20	MCS0	06	2437	30dBc
11ax-HE20	MCS0	11	2462	30dBc
11ax-HE40	MCS0	03	2422	30dBc
11ax-HE40	MCS0	06	2437	30dBc
11ax-HE40	MCS0	09	2452	30dBc

802.11b Out-of-Band Emissions – Ant 0

Channel 01 (2412MHz)

Reference Level

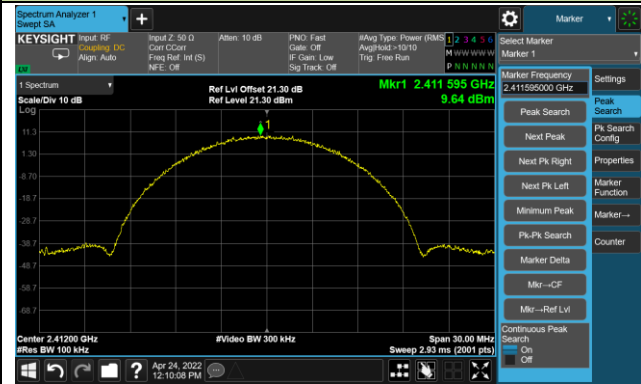

Low Band Edge

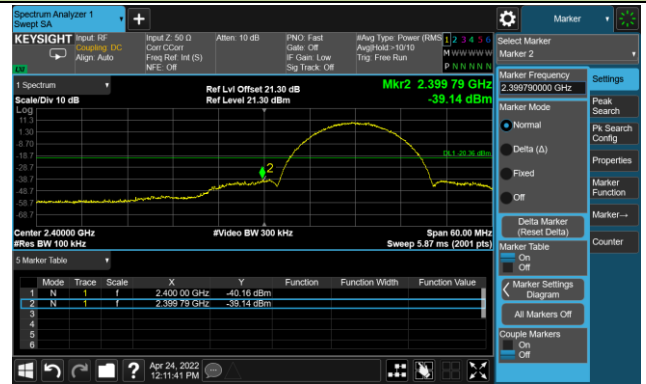

Spurious Emission

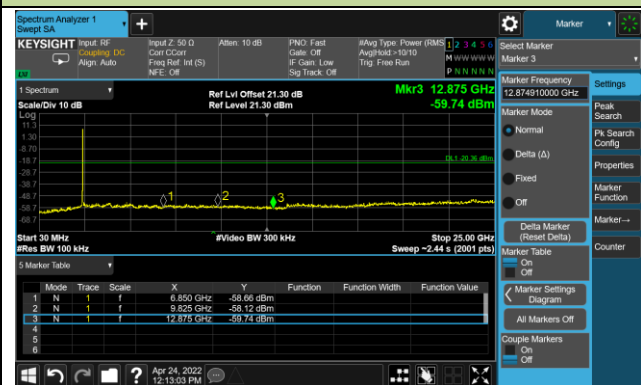

Channel 06 (2437MHz)

Reference Level



Spurious Emission

