

# RF MEASUREMENT REPORT

---

**FCC ID:** I88EX2210-T0  
**Applicant:** Zyxel Communications Corporation  
**Product:** Dual-Band Wireless AX1800 Gigabit Ethernet Gateway  
**Model No.:** EX2210-T0  
**Brand Name:** ZYXEL  
**FCC Classification:** Unlicensed National Information Infrastructure (NII)  
**FCC Rule Part(s):** Part 15 Subpart E (Section 15.407)  
**Result:** Complies  
**Test Date:** 2022-04-09 ~ 2022-05-07

**Reviewed By:**

\_\_\_\_\_  
Kevin Guo

**Approved By:**

\_\_\_\_\_  
Robin Wu



The test results relate only to the samples tested.

This equipment has been shown to be capable of compliance with the applicable technical standards as indicated in the measurement report and was tested in accordance with the measurement procedures specified in KDB789033. Test results reported herein relate only to the item(s) tested.

The test report shall not be reproduced except in full without the written approval of MRT Technology (Suzhou) Co., Ltd.

---

### Revision History

Report No.	Version	Description	Issue Date	Note
2203RSU090-U2	Rev. 01	Initial Report	2022-06-06	Valid

---

## CONTENTS

Description	Page
<b>1. General Information .....</b>	<b>6</b>
1.1. Applicant .....	6
1.2. Manufacturer.....	6
1.3. Testing Facility .....	6
1.4. Product Information .....	7
1.5. Radio Specification.....	7
1.6. Working Frequencies.....	8
1.7. Antenna Details .....	9
<b>2. Test Configuration .....</b>	<b>10</b>
2.1. Test Mode .....	10
2.2. Test System Connection Diagram .....	10
2.3. Test Software .....	11
2.4. Applied Standards .....	11
2.5. Test Environment Condition.....	11
<b>3. Antenna Requirements .....</b>	<b>12</b>
<b>4. Measuring Instrument .....</b>	<b>13</b>
<b>5. Measurement Uncertainty.....</b>	<b>14</b>
<b>6. Test Result.....</b>	<b>15</b>
6.1. Summary .....	15
6.2. 26dB & 99% Bandwidth Measurement.....	16
6.2.1. Test Limit.....	16
6.2.2. Test Procedure .....	16
6.2.3. Test Setting .....	16
6.2.4. Test Setup.....	17
6.2.5. Test Result .....	17
6.3. 6dB Bandwidth Measurement .....	18
6.3.1. Test Limit.....	18
6.3.2. Test Procedure .....	18
6.3.3. Test Setting .....	18
6.3.4. Test Setup.....	18
6.3.5. Test Result .....	18
6.4. Output Power Measurement.....	19
6.4.1. Test Limit.....	19
6.4.2. Test Procedure .....	19
6.4.3. Test Setting .....	19

6.4.4.	Test Setup.....	19
6.4.5.	Test Result.....	20
6.5.	Transmit Power Control Measurement.....	21
6.5.1.	Test Limit.....	21
6.5.2.	Test Procedure.....	21
6.5.3.	Test Setting.....	21
6.5.4.	Test Setup.....	21
6.5.5.	Test Result.....	21
6.6.	Power Spectral Density Measurement.....	22
6.6.1.	Test Limit.....	22
6.6.2.	Test Procedure.....	22
6.6.3.	Test Setting.....	22
6.6.4.	Test Setup.....	23
6.6.5.	Test Result.....	23
6.7.	Frequency Stability Measurement.....	24
6.7.1.	Test Limit.....	24
6.7.2.	Test Procedure.....	24
6.7.3.	Test Setup.....	25
6.7.4.	Test Result.....	25
6.8.	Radiated Spurious Emission Measurement.....	26
6.8.1.	Test Limit.....	26
6.8.2.	Test Procedure.....	26
6.8.3.	Test Setting.....	26
6.8.4.	Test Setup.....	28
6.8.5.	Test Result.....	28
6.9.	Radiated Restricted Band Edge Measurement.....	29
6.9.1.	Test Limit.....	29
6.9.2.	Test Procedure.....	31
6.9.3.	Test Setting.....	31
6.9.4.	Test Setup.....	32
6.9.5.	Test Result.....	32
6.10.	AC Conducted Emissions Measurement.....	33
6.10.1.	Test Limit.....	33
6.10.2.	Test Setup.....	33
6.10.3.	Test Result.....	33
<b>Appendix A – Test Result.....</b>		<b>34</b>
A.1	Duty Cycle Test Result.....	34
A.2	26dB Bandwidth Test Result.....	36
A.3	6dB Bandwidth Test Result.....	51

A.4	Output Power Test Result .....	56
A.5	Power Spectral Density Test Result.....	60
A.6	Frequency Stability Test Result.....	87
A.7	Radiated Spurious Emission Test Result.....	88
A.8	Radiated Restricted Band Edge Test Result.....	161
A.9	AC Conducted Emissions Test Result .....	283
<b>Appendix B – Test Setup Photograph .....</b>		<b>285</b>
<b>Appendix C – EUT Photograph .....</b>		<b>286</b>

## 1. General Information

### 1.1. Applicant

Zyxel Communications Corporation  
 No.2, Industry East Road IX, Science Park Hsinchu, Taiwan

### 1.2. Manufacturer

Zyxel Communications Corporation  
 No.2, Industry East Road IX, Science Park Hsinchu, Taiwan

### 1.3. Testing Facility

<input checked="" type="checkbox"/>	<p><b>Test Site – MRT Suzhou Laboratory</b></p> <hr/> <p><b>Laboratory Location (Suzhou - Wuzhong)</b>                      D8 Building, No.2 Tian'edang Rd., Wuzhong Economic Development Zone, Suzhou, China</p> <p><b>Laboratory Location (Suzhou - SIP)</b>                      4b Building, Liando U Valley, No.200 Xingpu Rd., Shengpu Town, Suzhou Industrial Park, China</p> <hr/> <p><b>Laboratory Accreditations</b></p> <p>A2LA: 3628.01 <span style="float: right;">CNAS: L10551</span>                      FCC: CN1166 <span style="float: right;">ISED: CN0001</span></p> <p>VCCI: <input type="checkbox"/>R-20025 <input type="checkbox"/>G-20034 <input type="checkbox"/>C-20020 <input type="checkbox"/>T-20020  <input type="checkbox"/>R-20141 <input type="checkbox"/>G-20134 <input type="checkbox"/>C-20103 <input type="checkbox"/>T-20104</p>
<input type="checkbox"/>	<p><b>Test Site – MRT Shenzhen Laboratory</b></p> <hr/> <p><b>Laboratory Location (Shenzhen)</b>                      1G, Building A, Junxiangda Building, Zhongshanyuan Road West, Nanshan District, Shenzhen, China</p> <hr/> <p><b>Laboratory Accreditations</b></p> <p>A2LA: 3628.02 <span style="float: right;">CNAS: L10551</span>                      FCC: CN1284 <span style="float: right;">ISED: CN0105</span></p>
<input type="checkbox"/>	<p><b>Test Site – MRT Taiwan Laboratory</b></p> <hr/> <p><b>Laboratory Location (Taiwan)</b>                      No. 38, Fuxing 2nd Rd., Guishan Dist., Taoyuan City 333, Taiwan (R.O.C.)</p> <hr/> <p><b>Laboratory Accreditations</b></p> <p>TAF: L3261-190725                      FCC: 291082, TW3261 <span style="float: right;">ISED: TW3261</span></p>

#### 1.4. Product Information

Product Name	Dual-Band Wireless AX1800 Gigabit Ethernet Gateway
Model No.	EX2210-T0
Serial No.	S220Z08004458(Conducted) S220Z08004467(Radiated)
Wi-Fi Specification	802.11a/b/g/n/ac/ax
Antenna Information	Refer to clause 1.7
Operating Temperature	0°C to 40°C
Accessories	
Adapter	Model No.: MAUS-1201501801 Input Power: 100 - 240V ~ 50/60Hz, 0.5A Output Power: 12V dc 1.5A
Remark: The information of EUT was provided by the manufacturer, and the accuracy of the information shall be the responsibility of the manufacturer.	

#### 1.5. Radio Specification

Frequency Range	For 802.11a/n-HT20/ac-VHT20/ax-HE20: 5180~5240MHz, 5260~5320MHz, 5500~5720MHz, 5745~5825MHz For 802.11n-HT40/ac-VHT40/ax-HE40: 5190~5230MHz, 5270~5310MHz, 5510~5710MHz, 5755~5795MHz For 802.11ac-VHT80/ax-HE80: 5210MHz, 5290MHz, 5530MHz, 5610 MHz, 5690MHz, 5775MHz
Type of Modulation	802.11a/n/ac: OFDM 802.11ax: OFDMA
Data Rate	802.11a: 6/9/12/18/24/36/48/54Mbps 802.11n: up to 300Mbps 802.11ac: up to 866.7Mbps 802.11ax: up to 1201Mbps

Note: For other features of this EUT, test report will be issued separately.

### 1.6. Working Frequencies

#### 802.11a/n-HT20/ac-VHT20/ax-HE20

Channel	Frequency	Channel	Frequency	Channel	Frequency
36	5180 MHz	40	5200 MHz	44	5220 MHz
48	5240 MHz	52	5260 MHz	56	5280 MHz
60	5300 MHz	64	5320 MHz	100	5500 MHz
104	5520 MHz	108	5540 MHz	112	5560 MHz
116	5580 MHz	120	5600 MHz	124	5620 MHz
128	5640 MHz	132	5660 MHz	136	5680 MHz
140	5700 MHz	144	5720 MHz	149	5745 MHz
153	5765 MHz	157	5785 MHz	161	5805 MHz
165	5825 MHz	--	--	--	--

#### 802.11n-HT40/ac-VHT40/ax-HE40

Channel	Frequency	Channel	Frequency	Channel	Frequency
38	5190 MHz	46	5230 MHz	54	5270 MHz
62	5310 MHz	102	5510 MHz	110	5550MHz
118	5590 MHz	126	5630 MHz	134	5670 MHz
142	5710 MHz	151	5755 MHz	159	5795 MHz

#### 802.11ac-VHT80/ax-HE80

Channel	Frequency	Channel	Frequency	Channel	Frequency
42	5210 MHz	58	5290 MHz	106	5530 MHz
122	5610 MHz	138	5690 MHz	155	5775 MHz



**1.7. Antenna Details**

Antenna Type	Frequency Band (MHz)	Tx Paths	Antenna Gain (dBi)		Beamforming Directional Gain (dBi)	CDD Directional Gain (dBi)	
			Ant 0	Ant 1		For Power	For PSD
PCB Antenna	2412 ~ 2462	2	3.5	2.9	6.51	3.5	6.51
	5180 ~ 5320	2	4.2	3.2	7.21	4.2	7.21
	5500 ~ 5720	2	4.0	3.9	7.01	4.0	7.01
	5745 ~ 5825	2	4.6	3.3	7.61	4.6	7.61

**Remark:**

- The EUT supports Cyclic Delay Diversity (CDD) mode and CDD signals are correlated.  
 If all antennas have the same gain,  $G_{ANT}$ , Directional gain =  $G_{ANT} + \text{Array Gain}$ , where Array Gain is as follows.
  - For power spectral density (PSD) measurements on all devices,  
 Array Gain =  $10 \log (N_{ANT} / N_{SS})$  dB;
  - For power measurements on IEEE 802.11 devices,  
 Array Gain = 0 dB for  $N_{ANT} \leq 4$ ;
- The EUT also supports Beam Forming mode, and the Beam Forming support 802.11ac/ax. BF Directional gain =  $G_{ANT} + 10 \log (N_{ANT})$ . For beamforming operation, manufacturer automatically backs power down based on a  $10 \log(N)$  factor based on CDD power.

## 2. Test Configuration

### 2.1. Test Mode

Mode 1: Transmit by 802.11a (6Mbps) (CDD Mode)
Mode 2: Transmit by 802.11ac-VHT20 (MCS0) (CDD Mode)
Mode 3: Transmit by 802.11ac-VHT40 (MCS0) (CDD Mode)
Mode 4: Transmit by 802.11ac-VHT80 (MCS0) (CDD Mode)
Mode 5: Transmit by 802.11ax-HE20 (MCS0) (CDD Mode)
Mode 6: Transmit by 802.11ax-HE40 (MCS0) (CDD Mode)
Mode 7: Transmit by 802.11ax-HE80 (MCS0) (CDD Mode)

Note 1: Due to the same modulation between 802.11n and 802.11ac, so 802.11n-HT20 and HT40 are covered by 802.11ac-VHT20 and VHT40 in this report, meanwhile, power level for 802.11n-HT20 and HT40 will not be greater than 802.11ac-VHT20 and VHT40.

### 2.2. Test System Connection Diagram

The device was tested per the guidance ANSI C63.10: 2013 was used to reference the appropriate EUT setup for radiated emissions testing and AC line conducted testing.

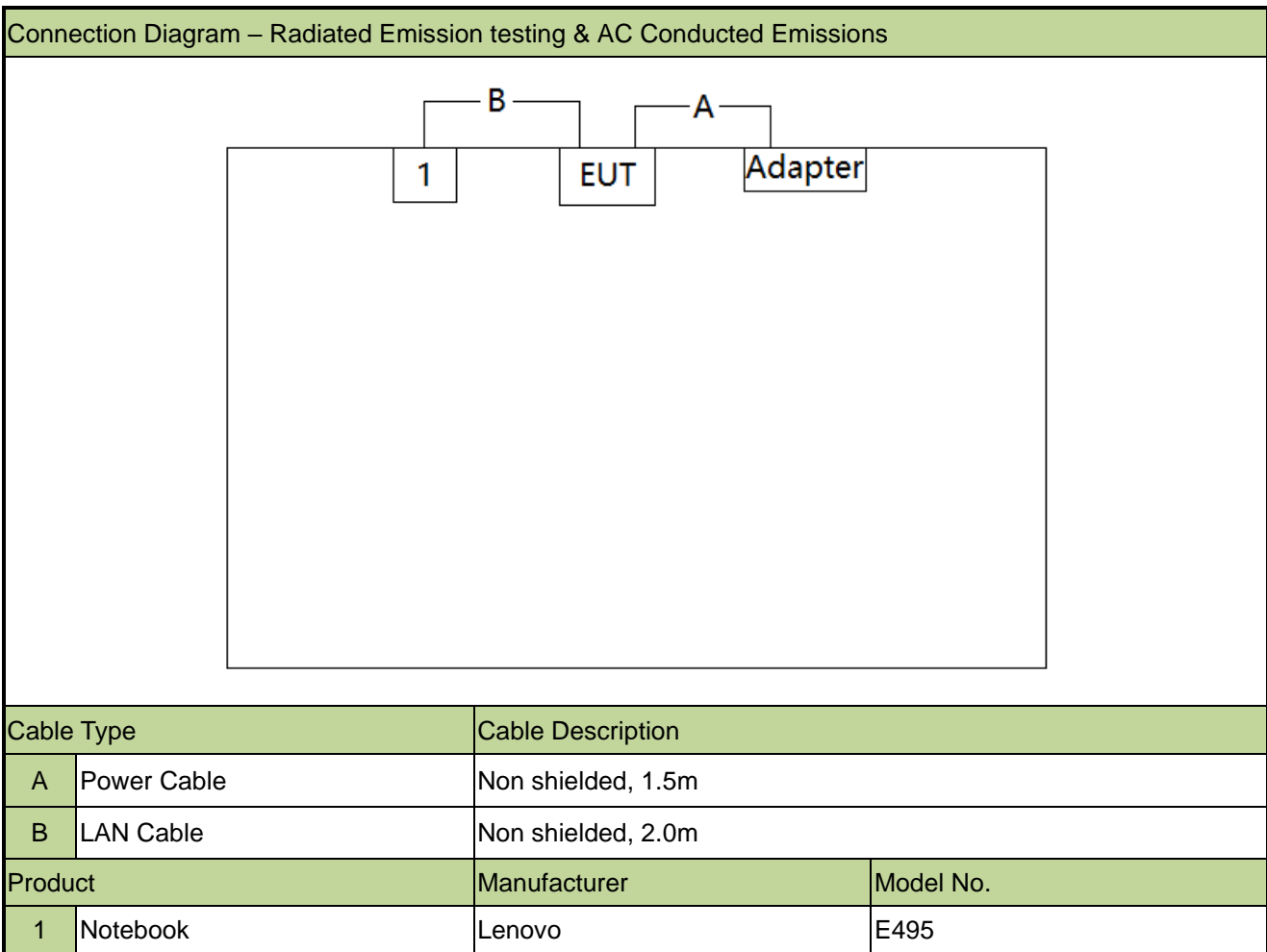

### 2.3. Test Software

The test utility software used during testing was “QATool\_Dbg.exe”, and the version was UIv2.17\_DLLv6.00.

Note: Final power setting please refer to operational description.

### 2.4. Applied Standards

According to the specifications of the manufacturer, the EUT must comply with the requirements of the following standards:

- FCC Part 15.407
- KDB 789033 D02v02r01
- KDB 662911 D01v02r01
- ANSI C63.10-2013

### 2.5. Test Environment Condition

Ambient Temperature	15 ~ 35°C
Relative Humidity	20 ~ 75%RH

### 3. Antenna Requirements

**Excerpt from §15.203 of the FCC Rules/Regulations:**

“An intentional radiator antenna shall be designed to ensure that no antenna other than that furnished by the responsible party can be used with the device. The use of a permanently attached antenna or of an antenna that uses a unique coupling to the intentional radiator shall be considered sufficient to comply with the provisions of this section.”

- The antenna of the device is **permanently attached**.
- There are no provisions for connection to an external antenna.

**Conclusion:**

The unit complies with the requirement of §15.203.

#### 4. Measuring Instrument

Instrument	Manufacturer	Model No.	Asset No.	Last Cali. Date	Cali. Due Date	Test Site
Preamplifier	Schwarzbeck	BBV 9721	MRTSUE06121	1 year	2022/6/9	SIP-AC3
Horn Antenna	Schwarzbeck	BBHA 9170	MRTSUE06598	1 year	2022/11/9	SIP-AC3
Horn Antenna	R&S	HF907	MRTSUE06611	1 year	2022/9/12	SIP-AC3
Thermohygrometer	testo	608-H1	MRTSUE06619	1 year	2022/11/2	SIP-AC3
Thermohygrometer	testo	608-H1	MRTSUE06622	1 year	2022/11/28	SIP-AC3
Preamplifier	EMCI	EMC012645SE	MRTSUE06642	1 year	2023/1/13	SIP-AC3
TRILOG Antenna	Schwarzbeck	VULB 9168	MRTSUE06646	1 year	2022/8/26	SIP-AC3
Loop Antenna	Schwarzbeck	FMZB 1519 B	MRTSUE06937	1 year	2023/3/14	SIP-AC3
EMI Test Receiver	R&S	ESR3	MRTSUE06185	1 year	2022/12/29	SIP-AC3
Signal Analyzer	Keysight	N9010B	MRTSUE06559	1 year	2022/6/24	SIP-AC3
Anechoic Chamber	RIKEN	SIP-AC3	MRTSUE06782	1 year	2022/12/23	SIP-AC3
Signal Analyzer	Keysight	N9030B	MRTSUE06395	1 year	2022/8/8	SIP-TR1
USB Power Sensor	Keysight	U2021XA	MRTSUE06595	1 year	2022/9/7	SIP-TR1
Thermohygrometer	testo	Testo 608-H1	MRTSUE11022	1 year	2022/11/2	SIP-TR1
Two-Line V-Network	R&S	ENV216	MRTSUE06003	1 year	2022/6/8	SIP-SR2
EMI Test Receiver	R&S	ESR3	MRTSUE06612	1 year	2022/6/24	SIP-SR2
Thermohygrometer	testo	608-H1	MRTSUE06621	1 year	2022/11/28	SIP-SR2
Shielding Room	MIX-BEP	SIP-SR2	MRTSUE06949	N/A	N/A	SIP-SR2

Software	Version	Function
EMI Software	V3.0.0	EMI Test Software
Controller_MF 7802BS	1.02	RE Antenna&turtable
Agilent Power Panel	V R03.09.00	Power

## 5. Measurement Uncertainty

Where relevant, the following test uncertainty levels have been estimated for tests performed on the EUT as specified in CISPR 16-4-2. This uncertainty represents an expanded uncertainty expressed at approximately the 95% confidence level using a coverage factor of  $k = 2$ .

<b>AC Conducted Emission Measurement</b>
Measurement Uncertainty for a Level of Confidence of 95% ( $U=2Uc(y)$ ): 9kHz~150kHz: 3.74dB 150kHz~30MHz: 3.44dB
<b>Radiated Disturbance</b>
Measurement Uncertainty for a Level of Confidence of 95% ( $U=2Uc(y)$ ): Horizontal: 30MHz~300MHz: 5.04dB 300MHz~1GHz: 4.95dB 1GHz~40GHz: 6.40dB Vertical: 30MHz~300MHz: 5.24dB 300MHz~1GHz: 6.03dB 1GHz~40GHz: 6.40dB
<b>Spurious Emissions, Conducted</b>
Measuring Uncertainty for a Level of Confidence of 95% ( $U=2Uc(y)$ ): 0.78dB
<b>Output Power</b>
Measuring Uncertainty for a Level of Confidence of 95% ( $U=2Uc(y)$ ): 1.13dB
<b>Power Spectrum Density</b>
Measuring Uncertainty for a Level of Confidence of 95% ( $U=2Uc(y)$ ): 1.15dB
<b>Occupied Bandwidth</b>
Measuring Uncertainty for a Level of Confidence of 95% ( $U=2Uc(y)$ ): 0.28%

## 6. Test Result

### 6.1. Summary

FCC Section(s)	Test Description	Test Condition	Verdict
15.407(a)	26dB Bandwidth	Conducted	Pass
15.407(e)	6dB Bandwidth		Pass
15.407(a)(1)(ii), (2), (3)(i)	Maximum Conducted Output Power		Pass
15.407(h)(1)	Transmit Power Control		Pass
15.407(a)(1)(ii), (2), (3)(i), (12)	Peak Power Spectral Density		Pass
15.407(g)	Frequency Stability		Pass
15.407(b)(1), (2), (3), (4)(i)	Undesirable Emissions	Radiated	Pass
15.205, 15.209 15.407(b)(8), (9), (10)	General Field Strength Limits (Restricted Bands and Radiated Emission Limits)		Pass
15.207	AC Conducted Emissions 150kHz - 30MHz	Line Conducted	Pass

#### Remark:

- Determining compliance is based on the test results met the regulation limits or requirements declared by clients, and the test results don't take into account the value of measurement uncertainty.
- The analyzer plots shown in this section were all taken with a correction table loaded into the analyzer. The correction table was used to account for the losses of the cables and attenuators used as part of the system to connect the EUT to the analyzer at all frequencies of interest.
- For radiated emission test, every axis (X, Y, Z) was also verified. The test results shown in the following sections represent the worst-case emissions.
- EUT supports one configuration only in 802.11ax full RU mode, i.e. 242 tone in 11ax-HE20, 484 tone in 11ax-HE40, 996 tone in 11ax-HE80.

## 6.2. 26dB & 99% Bandwidth Measurement

### 6.2.1. Test Limit

N/A

### 6.2.2. Test Procedure

KDB 789033 D02v02r01- Section II)C)1) (26dB Bandwidth)

KDB 789033 D02v02r01- Section II)D) (99% Bandwidth)

### 6.2.3. Test Setting

#### 26dB Bandwidth

1. The analyzers' automatic bandwidth measurement capability was used to perform the 26dB bandwidth
2. RBW = approximately 1% of the emission bandwidth.
3. VBW > RBW
4. Detector = Peak.
5. Trace mode = max hold.
6. Measure the maximum width of the emission that is 26 dB down from the maximum of the emission.  
Compare this with the RBW setting of the analyzer. Readjust RBW and repeat measurement as needed until the RBW/EBW ratio is approximately 1%.

#### 99% Bandwidth

1. Set center frequency to the nominal EUT channel center frequency.
2. RBW = 1% to 5% of the OBW
3. VBW  $\geq 3 \times$  RBW
4. Span = 1.5 times to 5 times the OBW
5. Detector = peak
6. Trace mode = max hold
7. Allow the trace to stabilize
8. Use the 99% power bandwidth function of the instrument.



#### 6.2.4. Test Setup

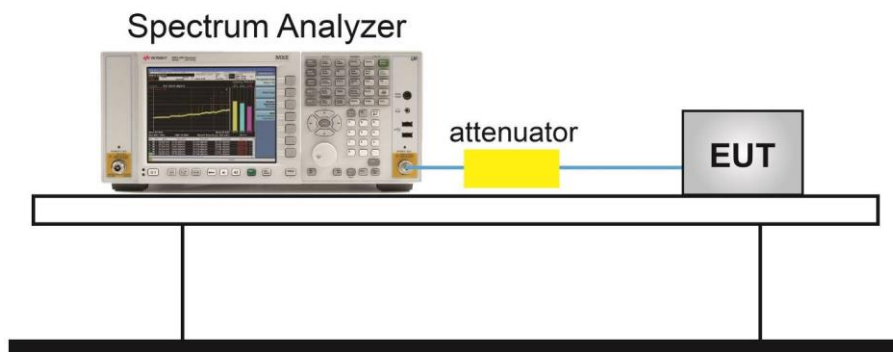

#### 6.2.5. Test Result

Refer to Appendix A.2.

### 6.3. 6dB Bandwidth Measurement

#### 6.3.1. Test Limit

The minimum 6dB bandwidth shall be at least 500 kHz.

#### 6.3.2. Test Procedure

KDB 789033 D02v02r01- Section II)C)2)

#### 6.3.3. Test Setting

1. Set center frequency to the nominal EUT channel center frequency.
2. RBW = 100 kHz.
3. VBW  $\geq 3 \times$  RBW.
4. Detector = Peak.
5. Trace mode = max hold.
6. Sweep = auto couple.
7. Allow the trace to stabilize.
8. Measure the maximum width of the emission that is constrained by the frequencies associated with the two outermost amplitude points (upper and lower frequencies) that are attenuated by 6 dB relative to the maximum level measured in the fundamental emission.

#### 6.3.4. Test Setup

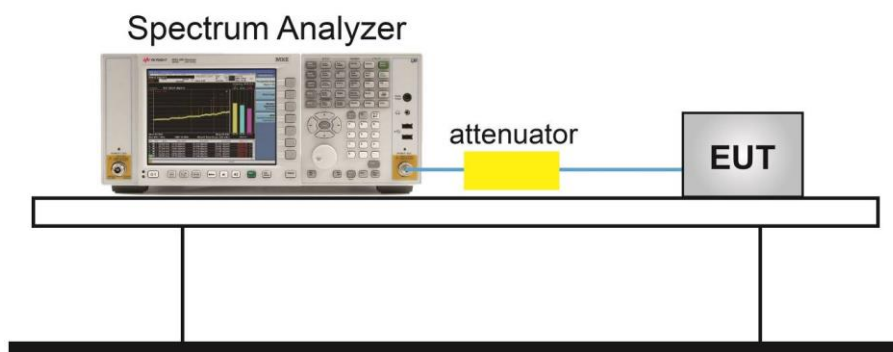

#### 6.3.5. Test Result

Refer to Appendix A.3.

## 6.4. Output Power Measurement

### 6.4.1. Test Limit

For the band 5.15-5.25 GHz, the maximum conducted output power over the frequency band of operation shall not exceed 1 W provided the maximum antenna gain does not exceed 6 dBi.

For the 5.25-5.35 GHz and 5.47-5.725 GHz bands, the maximum conducted output power over the frequency bands of operation shall not exceed the lesser of 250 mW or  $11 \text{ dBm} + 10 \log B$ , where B is the 26 dB emission bandwidth in megahertz.

For the band 5.725-5.85 GHz, the maximum conducted output power over the frequency band of operation shall not exceed 1 W (30dBm).

If transmitting antennas of directional gain greater than 6dBi are used, the maximum conducted output power shall be reduced by the amount in dB that the directional gain of the antenna exceeds 6dBi.

### 6.4.2. Test Procedure

KDB 789033D02v02r01- Section II)E)3)b) Method PM-G

### 6.4.3. Test Setting

#### Average Power Measurement

Average power measurements were performed only when the EUT was transmitting at its maximum power control level using a broadband power meter with a pulse sensor. The power meter implemented triggering and gating capabilities which were set up such that power measurements were recorded only during the ON time of the transmitter.

### 6.4.4. Test Setup

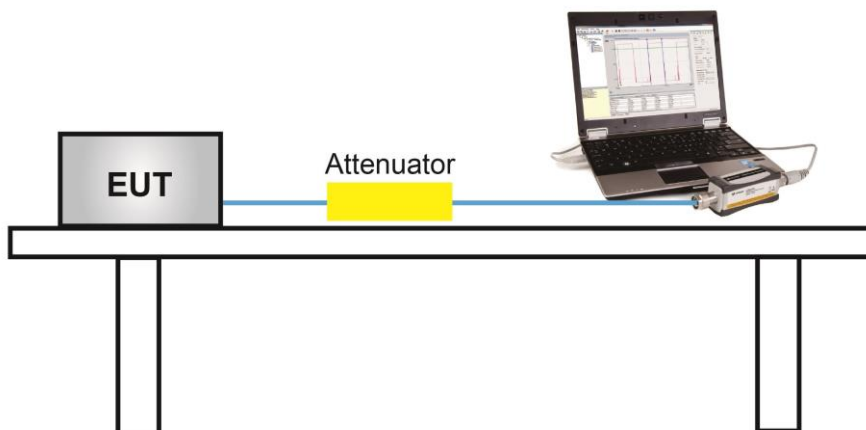

#### **6.4.5. Test Result**

Refer to Appendix A.4.

## 6.5. Transmit Power Control Measurement

### 6.5.1. Test Limit

The U-NII device is required to have the capability to operate at least 6 dB below the mean EIRP value of 30 dBm.

### 6.5.2. Test Procedure

KDB 789033 D02v01- Section II)E)3)b) Method PM-G

### 6.5.3. Test Setting

Average power measurements were performed only when the EUT was transmitting at its maximum power control level using a broadband power meter with a pulse sensor. The power meter implemented triggering and gating capabilities which were set up such that power measurements were recorded only during the ON time of the transmitter. The trace was averaged over 100 traces to obtain the final measured average power.

### 6.5.4. Test Setup

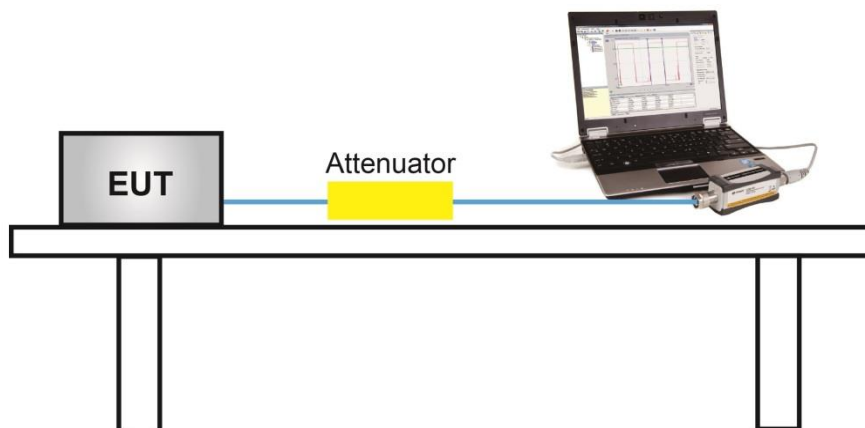

### 6.5.5. Test Result

Device supports TPC mechanism, details refer to the operational description.

## 6.6. Power Spectral Density Measurement

### 6.6.1. Test Limit

For the band 5.15-5.25 GHz, the maximum power spectral density shall not exceed 17 dBm in any 1 megahertz band.

For the 5.25-5.35 GHz and 5.47-5.725 GHz bands, the maximum power spectral density shall not exceed 11 dBm in any 1 megahertz band.

For the band 5.725-5.85 GHz, the maximum power spectral density shall not exceed 30 dBm in any 500-kHz band.

If transmitting antennas of directional gain greater than 6dBi are used, the peak power spectral density shall be reduced by the amount in dB that the directional gain of the antenna exceeds 6dBi.

### 6.6.2. Test Procedure

KDB 789033 D02v02r01-Section II)F)

### 6.6.3. Test Setting

1. Analyzer was set to the center frequency of the UNII channel under investigation
2. Span was set to encompass the entire 26dB EBW of the signal.
3. RBW = 1MHz (510kHz, if measurement bandwidth of Maximum PSD is specified in 500 kHz)
4. VBW = 3 × RBW
5. Number of sweep points  $\geq 2 \times (\text{span} / \text{RBW})$
6. Detector = power averaging (Average)
7. Sweep time = auto
8. Trace average at least 100 traces in power averaging (rms) mode; however, the number of traces to be averaged shall be increased above 100 as needed to ensure that the average accurately represents the true average over the on and off periods of the transmitter.
9. Use the peak search function on the instrument to find the peak of the spectrum and record its value.
10. Add  $10 \cdot \log(1/x)$ , where x is the duty cycle, to the measured power in order to compute the average power during the actual transmission times (because the measurement represents an average over both the on and off times of the transmission). For example, add  $10 \cdot \log(1/0.25) = 6$  dB if the duty cycle is 25 percent.

#### 6.6.4. Test Setup

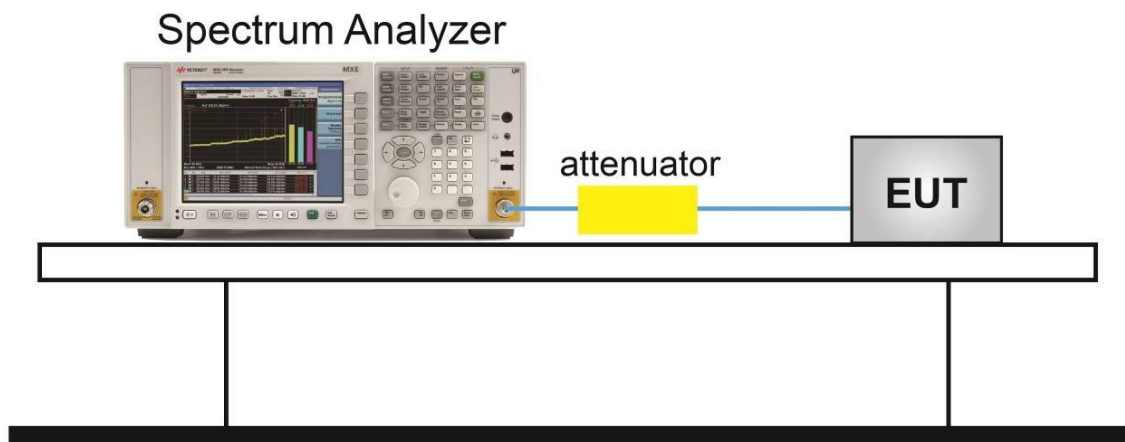

#### 6.6.5. Test Result

Refer to Appendix A.5.

## **6.7. Frequency Stability Measurement**

### **6.7.1. Test Limit**

Manufactures of U-NII devices are responsible for ensuring frequency stability such that an emission is maintained within the band of operation under all conditions of normal operation as specified in the user's manual.

### **6.7.2. Test Procedure**

#### **Frequency Stability Under Temperature Variations:**

The equipment under test was connected to an external AC or DC power supply and input rated voltage. RF output was connected to a frequency counter or spectrum analyzer via feed through attenuators. The EUT was placed inside the temperature chamber. Set the spectrum analyzer RBW low enough to obtain the desired frequency resolution and measure EUT 20°C operating frequency as reference frequency. Turn EUT off and set the chamber temperature to highest. After the temperature stabilized for approximately 30 minutes recorded the frequency. Repeat step measure with 10°C decreased per stage until the lowest temperature reached.

#### **Frequency Stability Under Voltage Variations:**

Set chamber temperature to 20°C. Use a variable AC power supply / DC power source to power the EUT and set the voltage to rated voltage. Set the spectrum analyzer RBW low enough to obtain the desired frequency resolution and recorded the frequency.

Reduce the input voltage to specify extreme voltage variation ( $\pm 15\%$ ) and endpoint, record the maximum frequency change.



### 6.7.3. Test Setup

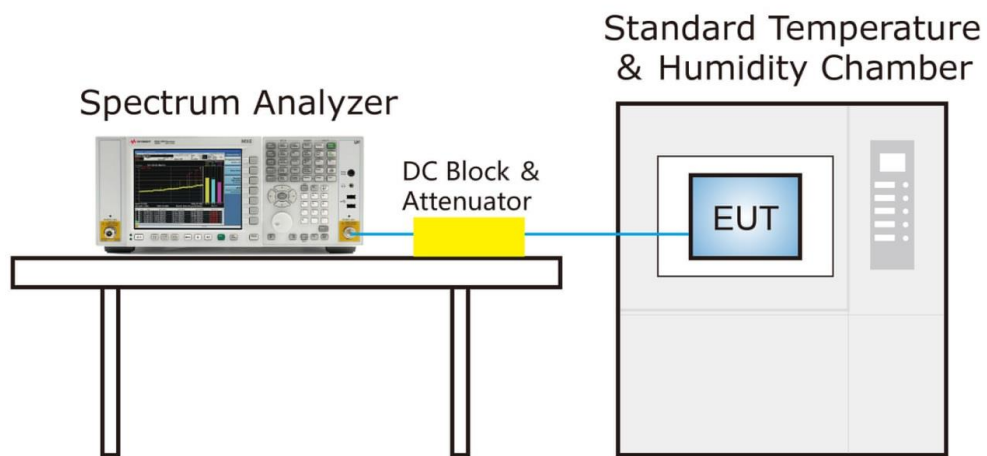

### 6.7.4. Test Result

Refer to Appendix A.6.

## 6.8. Radiated Spurious Emission Measurement

### 6.8.1. Test Limit

All out of band emissions appearing in a restricted band as specified in Section 15.205 of the Title 47 CFR must not exceed the limits shown in Table per Section 15.209.

FCC Part 15 Subpart C Paragraph 15.209		
Frequency [MHz]	Field Strength [uV/m]	Measured Distance [Meters]
0.009 - 0.490	2400/F (kHz)	300
0.490 - 1.705	24000/F (kHz)	30
1.705 - 30	30	30
30 - 88	100	3
88 - 216	150	3
216 - 960	200	3
Above 960	500	3

### 6.8.2. Test Procedure

KDB 789033 D02v02r01- Section II)G)

### 6.8.3. Test Setting

**Table 1 - RBW as a function of frequency**

Frequency	RBW
9 ~ 150 kHz	200 ~ 300 Hz
0.15 ~ 30 MHz	9 ~ 10 kHz
30 ~ 1000 MHz	100 ~ 120 kHz
> 1000MHz	1MHz

**Quasi-Peak Measurements below 1GHz**

1. Analyzer center frequency was set to the frequency of the radiated spurious emission of interest
2. Span was set greater than 1MHz
3. RBW = as specified in Table 1
4. Detector = CISPR quasi-peak
5. Sweep time = auto couple
6. Trace was allowed to stabilize

**Peak Measurements above 1GHz**

1. Analyzer center frequency was set to the frequency of the radiated spurious emission of interest
2. RBW = 1MHz
3. VBW = 3MHz
4. Detector = peak
5. Sweep time = auto couple
6. Trace mode = max hold
7. Trace was allowed to stabilize

**Average Measurements above 1GHz (Method VB)**

1. Analyzer center frequency was set to the frequency of the radiated spurious emission of interest
2. RBW = 1MHz
3. VBW; If the EUT is configured to transmit with duty cycle  $\geq 98\%$ , set VBW = 10 Hz.  
If the EUT duty cycle is  $< 98\%$ , set VBW  $\geq 1/T$ . T is the minimum transmission duration.
4. Detector = Peak
5. Sweep time = auto
6. Trace mode = max hold
7. Trace was allowed to stabilize

### 6.8.4. Test Setup

Below 1GHz Test Setup:

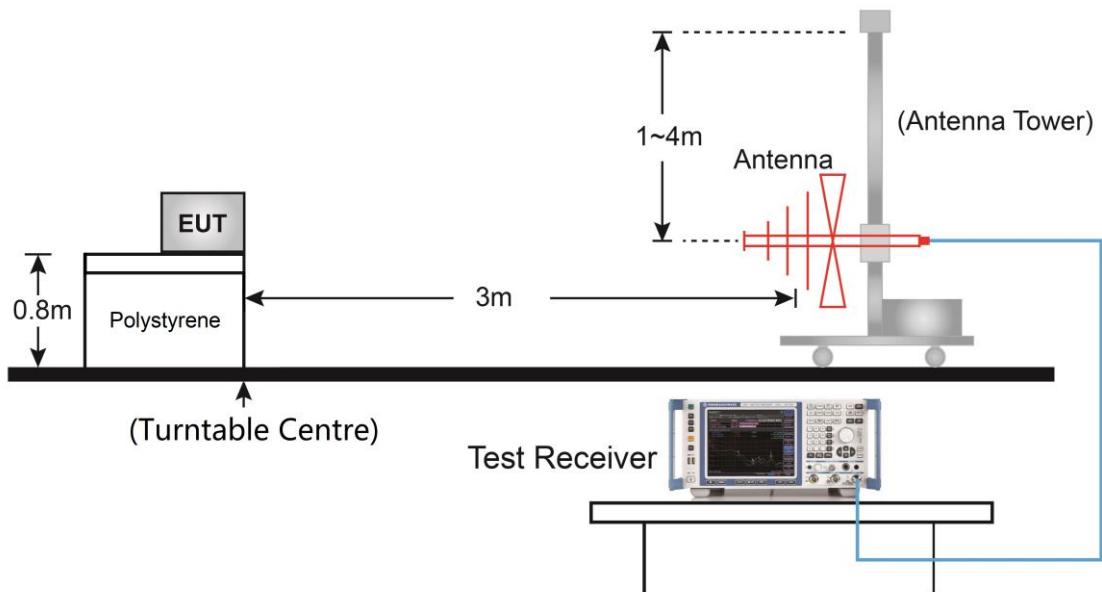

Above 1GHz Test Setup:

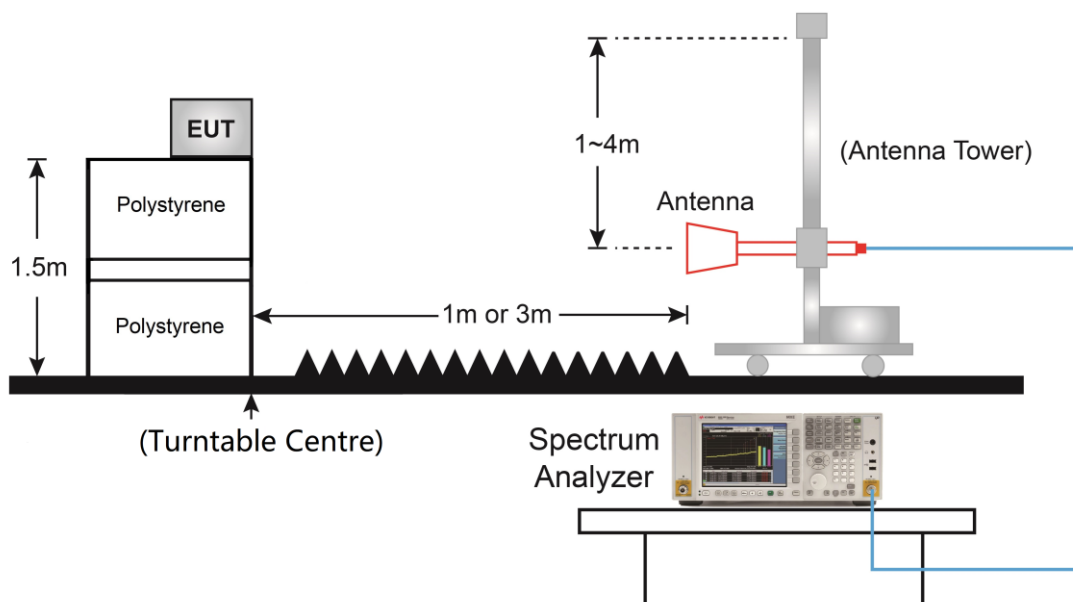

### 6.8.5. Test Result

Refer to Appendix A.7.

## 6.9. Radiated Restricted Band Edge Measurement

### 6.9.1. Test Limit

#### For 15.205 requirement:

Radiated emissions which fall in the restricted bands, as defined in Section 15.205(a) of FCC part 15, must also comply with the radiated emission limits specified in Section 15.209(a).

Frequency (MHz)	Frequency (MHz)	Frequency (MHz)	Frequency (GHz)
0.090 - 0.110	16.42 - 16.423	399.9 - 410	4.5 - 5.15
<sup>1</sup> 0.495 - 0.505	16.69475 - 16.69525	608 - 614	5.35 - 5.46
2.1735 - 2.1905	16.80425 - 16.80475	960 - 1240	7.25 - 7.75
4.125 - 4.128	25.5 - 25.67	1300 - 1427	8.025 - 8.5
4.17725 - 4.17775	37.5 - 38.25	1435 - 1626.5	9.0 - 9.2
4.20725 - 4.20775	73 - 74.6	1645.5 - 1646.5	9.3 - 9.5
6.215 - 6.218	74.8 - 75.2	1660 - 1710	10.6 - 12.7
6.26775 - 6.26825	108 - 121.94	1718.8 - 1722.2	13.25 - 13.4
6.31175 - 6.31225	123 - 138	2200 - 2300	14.47 - 14.5
8.291 - 8.294	149.9 - 150.05	2310 - 2390	15.35 - 16.2
8.362 - 8.366	156.52475 - 156.52525	2483.5 - 2500	17.7 - 21.4
8.37625 - 8.38675	156.7 - 156.9	2690 - 2900	22.01 - 23.12
8.41425 - 8.41475	162.0125 - 167.17	3260 - 3267	23.6 - 24.0
12.29 - 12.293	167.72 - 173.2	3332 - 3339	31.2 - 31.8
12.51975 - 12.52025	240 - 285	3345.8 - 3358	36.43 - 36.5
12.57675 - 12.57725	322 - 335.4	3600 - 4400	( <sup>2</sup> )
13.36 - 13.41	--	--	--

**For 15.407(b) requirement:**

For transmitters operating in the 5.15-5.25 GHz band: All emissions outside of the 5.15-5.35 GHz band shall not exceed an e.i.r.p. of -27 dBm/MHz.

For transmitters operating in the 5.25-5.35 GHz band: All emissions outside of the 5.15-5.35 GHz band shall not exceed an e.i.r.p. of -27 dBm/MHz.

For transmitters operating in the 5.47-5.725 GHz band: All emissions outside of the 5.47-5.725 GHz band shall not exceed an e.i.r.p. of -27 dBm/MHz.

For transmitters operating in the 5.725-5.85 GHz band: All emissions shall be limited to a level of -27 dBm/MHz at 75 MHz or more above or below the band edge increasing linearly to 10 dBm/MHz at 25 MHz above or below the band edge, and from 25 MHz above or below the band edge increasing linearly to a level of 15.6 dBm/MHz at 5 MHz above or below the band edge, and from 5 MHz above or below the band edge increasing linearly to a level of 27 dBm/MHz at the band edge.

Refer to KDB 789033 D02v02r01 G)2)c), as specified in § 15.407(b), emissions above 1000 MHz that are outside of the restricted bands are subject to a maximum emission limit of -27 dBm/MHz (or -17 dBm/MHz as specified in § 15.407(b)(4)). However, an out-of-band emission that complies with both the peak and average limits of § 15.209 is not required to satisfy the -27 dBm/MHz or -17 dBm/MHz maximum emission limit.

All out of band emissions appearing in a restricted band as specified in Section 15.205 of the Title 47CFR must not exceed the limits shown in Table per Section 15.209.

FCC Part 15 Subpart C Paragraph 15.209		
Frequency [MHz]	Field Strength [uV/m]	Measured Distance [Meters]
0.009 - 0.490	2400/F (kHz)	300
0.490 - 1.705	24000/F (kHz)	30
1.705 - 30	30	30
30 - 88	100	3
88 - 216	150	3
216 - 960	200	3
Above 960	500	3

### 6.9.2. Test Procedure

KDB 789033 D02v02r01- Section II)G)

### 6.9.3. Test Setting

#### **Peak Measurements above 1GHz**

1. Analyzer center frequency was set to the frequency of the radiated spurious emission of interest
2. RBW = 1MHz
3. VBW = 3MHz
4. Detector = Peak
5. Sweep time = Auto couple
6. Trace mode = Max hold
7. Trace was allowed to stabilize

#### **Average Measurements above 1GHz (Method VB)**

1. Analyzer center frequency was set to the frequency of the radiated spurious emission of interest
2. RBW = 1MHz
3. VBW; if the EUT is configured to transmit with duty cycle  $\geq 98\%$ , set VBW = 10Hz
4. If the EUT duty cycle is  $< 98\%$ , set VBW  $\geq 1/T$ . T is the minimum transmission duration
5. Detector = Peak
6. Sweep time = Auto
7. Trace mode = Max hold
8. Trace was allowed to stabilize

### 6.9.4. Test Setup

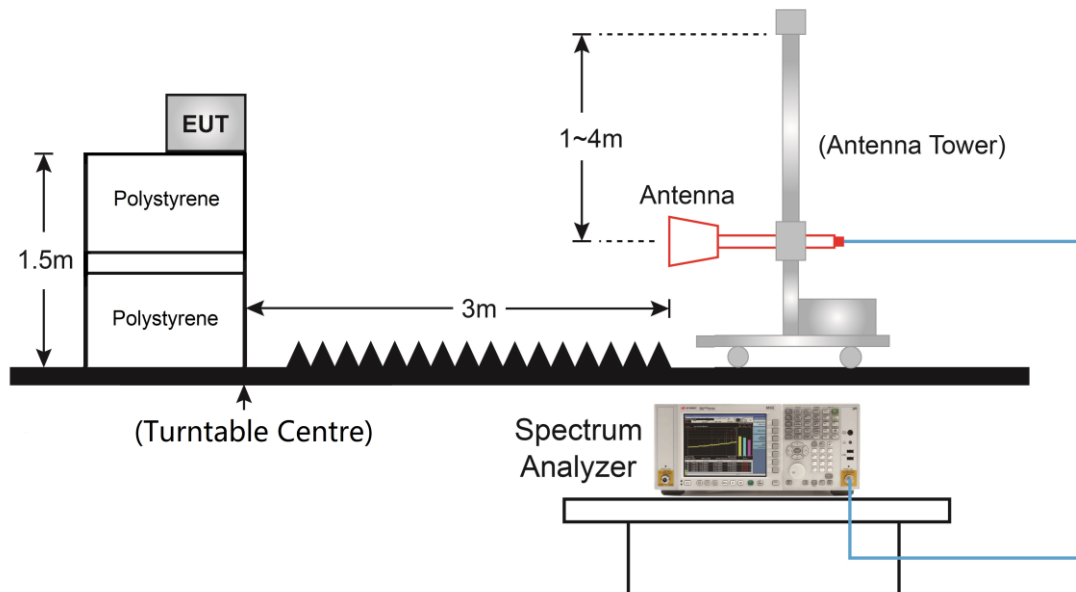

### 6.9.5. Test Result

Refer to Appendix A.8.



## 6.10. AC Conducted Emissions Measurement

### 6.10.1. Test Limit

FCC Part 15.207 Limits		
Frequency (MHz)	QP (dBuV)	AV (dBuV)
0.15 - 0.50	66 - 56	56 - 46
0.50 - 5.0	56	46
5.0 - 30	60	50

Note 1: The lower limit shall apply at the transition frequencies.

Note 2: The limit decreases linearly with the logarithm of the frequency in the range 0.15MHz to 0.5MHz.

### 6.10.2. Test Setup

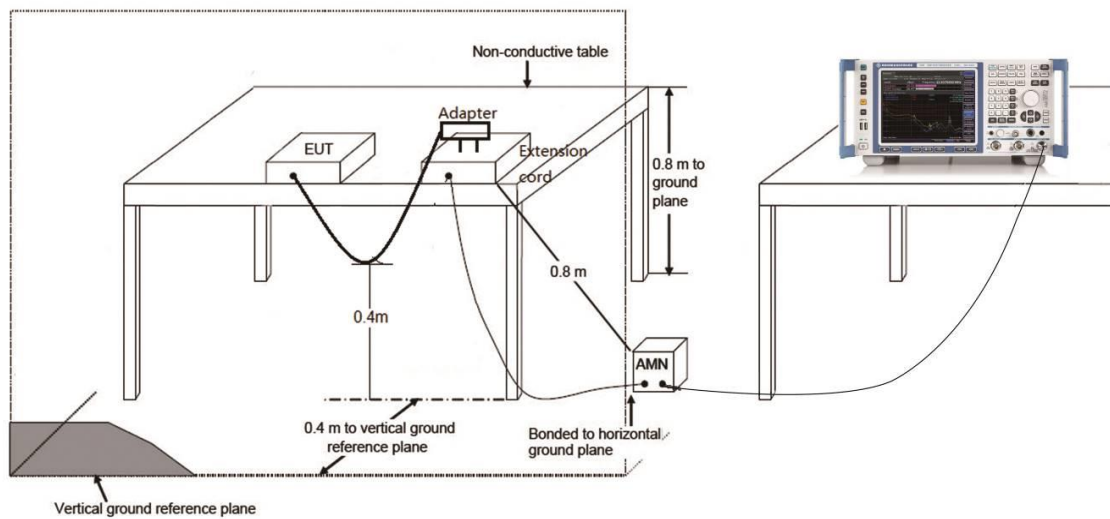

### 6.10.3. Test Result

Refer to Appendix A.9.

## Appendix A – Test Result

### A.1 Duty Cycle Test Result

Test Mode	Duty Cycle	Test Mode	Duty Cycle
802.11a	95.61%	802.11ax-HE20	84.20%
802.11ac-VHT20	95.57%	802.11ax-HE40	83.59%
802.11ac-VHT40	85.52%	802.11ax-HE80	83.30%
802.11ac-VHT80	84.49%	--	--

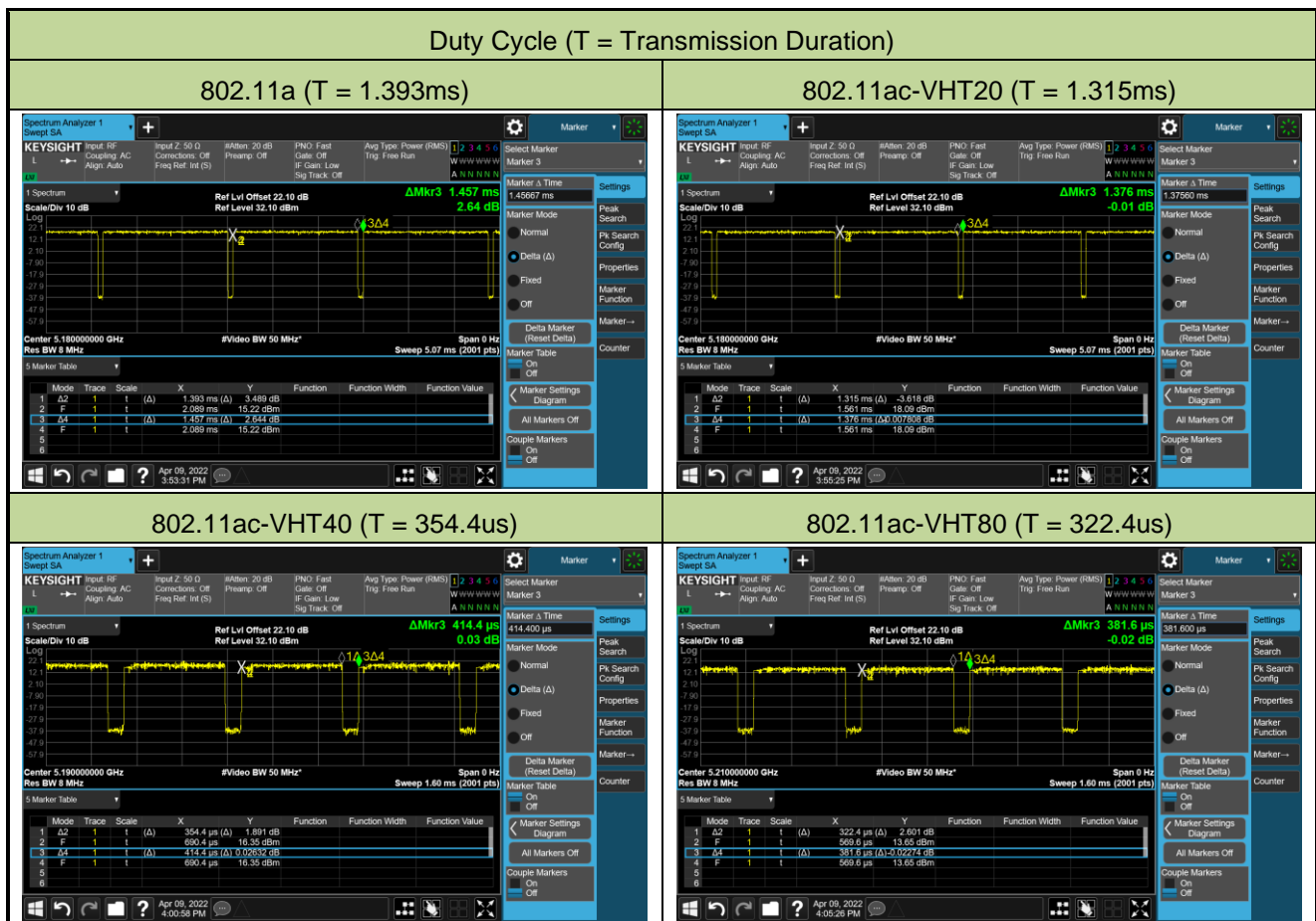

## Duty Cycle (T = Transmission Duration)

802.11ax-HE20 (T = 311.2us)

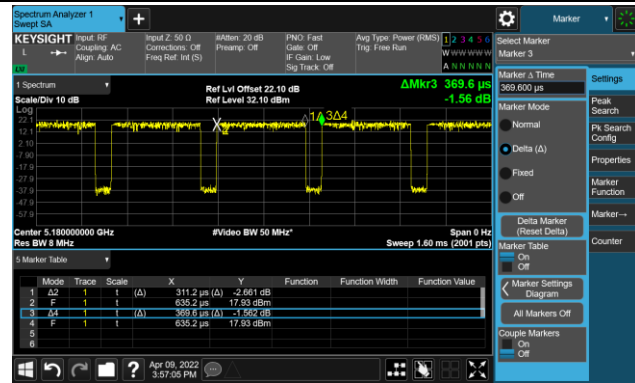

802.11ax-HE40 (T = 309.6us)

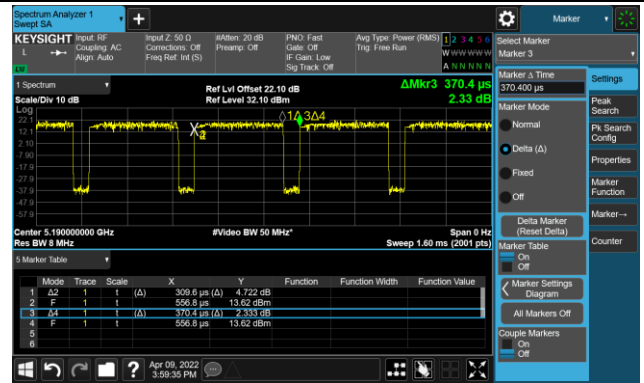

802.11ax-HE80 (T = 295.2us)

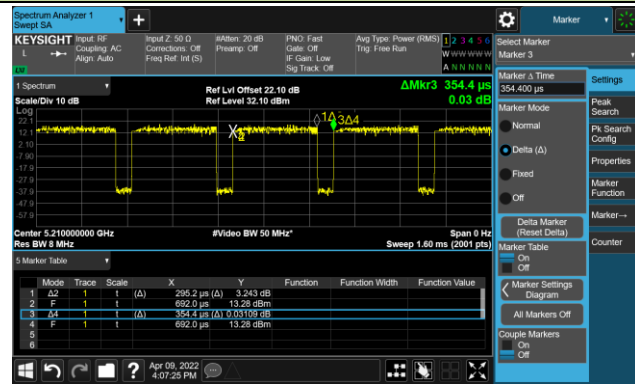

**A.2 26dB Bandwidth Test Result**

Test Site	SIP-TR1	Test Engineer	Nandy Zhang
Test Date	2022/04/25		

Test Mode	Data Rate/ MCS	Channel No.	Frequency (MHz)	26dB Bandwidth (MHz)	99% Bandwidth (MHz)
11a	6Mbps	36	5180	22.20	16.87
11a	6Mbps	44	5220	22.19	16.90
11a	6Mbps	48	5240	26.36	16.82
11a	6Mbps	52	5260	19.93	16.53
11a	6Mbps	60	5300	19.89	16.58
11a	6Mbps	64	5320	19.77	16.57
11a	6Mbps	100	5500	19.94	16.55
11a	6Mbps	116	5580	19.95	16.53
11a	6Mbps	140	5700	20.16	16.68
11a	6Mbps	144	5720	19.72	16.51
11a	6Mbps	149	5745	34.49	18.78
11a	6Mbps	157	5785	23.93	16.83
11a	6Mbps	165	5825	26.71	16.75
11ac-VHT20	MCS0	36	5180	24.11	17.79
11ac-VHT20	MCS0	44	5220	26.61	17.71
11ac-VHT20	MCS0	48	5240	23.81	17.69
11ac-VHT20	MCS0	52	5260	20.34	17.61
11ac-VHT20	MCS0	60	5300	20.20	17.55
11ac-VHT20	MCS0	64	5320	20.14	17.60
11ac-VHT20	MCS0	100	5500	20.08	17.58
11ac-VHT20	MCS0	116	5580	20.08	17.64
11ac-VHT20	MCS0	140	5700	20.01	17.54
11ac-VHT20	MCS0	144	5720	20.23	17.57
11ac-VHT20	MCS0	149	5745	34.80	18.46
11ac-VHT20	MCS0	157	5785	23.91	17.62
11ac-VHT20	MCS0	165	5825	27.26	17.83

Test Mode	Data Rate/ MCS	Channel No.	Frequency (MHz)	26dB Bandwidth (MHz)	99% Bandwidth (MHz)
11ac-VHT40	MCS0	38	5190	40.06	35.94
11ac-VHT40	MCS0	46	5230	75.18	38.92
11ac-VHT40	MCS0	54	5270	40.10	35.88
11ac-VHT40	MCS0	62	5310	40.03	35.91
11ac-VHT40	MCS0	102	5510	40.18	35.88
11ac-VHT40	MCS0	110	5550	39.44	35.87
11ac-VHT40	MCS0	134	5670	39.88	35.81
11ac-VHT40	MCS0	142	5710	39.79	35.84
11ac-VHT40	MCS0	151	5755	74.08	37.73
11ac-VHT40	MCS0	159	5795	67.37	36.45
11ac-VHT80	MCS0	42	5210	79.62	75.04
11ac-VHT80	MCS0	58	5290	79.49	74.92
11ac-VHT80	MCS0	106	5530	79.23	75.08
11ac-VHT80	MCS0	122	5610	79.52	75.13
11ac-VHT80	MCS0	138	5690	79.67	74.97
11ac-VHT80	MCS0	155	5775	95.14	75.28
11ax-HE20	MCS0	36	5180	23.27	19.06
11ax-HE20	MCS0	44	5220	25.11	19.04
11ax-HE20	MCS0	48	5240	20.75	18.85
11ax-HE20	MCS0	52	5260	22.58	18.92
11ax-HE20	MCS0	60	5300	22.58	18.92
11ax-HE20	MCS0	64	5320	23.99	18.92
11ax-HE20	MCS0	100	5500	24.29	18.88
11ax-HE20	MCS0	116	5580	25.66	18.86
11ax-HE20	MCS0	140	5700	23.77	18.94
11ax-HE20	MCS0	144	5720	25.58	19.01
11ax-HE20	MCS0	149	5745	31.43	19.17
11ax-HE20	MCS0	157	5785	32.91	19.07
11ax-HE20	MCS0	165	5825	26.76	19.06

Test Mode	Data Rate/ MCS	Channel No.	Frequency (MHz)	26dB Bandwidth (MHz)	99% Bandwidth (MHz)
11ax-HE40	MCS0	38	5190	39.40	37.55
11ax-HE40	MCS0	46	5230	73.14	38.84
11ax-HE40	MCS0	54	5270	40.11	37.51
11ax-HE40	MCS0	62	5310	39.74	37.54
11ax-HE40	MCS0	102	5510	39.71	37.48
11ax-HE40	MCS0	110	5550	39.60	37.48
11ax-HE40	MCS0	134	5670	39.80	37.61
11ax-HE40	MCS0	142	5710	39.69	37.50
11ax-HE40	MCS0	151	5755	70.70	38.85
11ax-HE40	MCS0	159	5795	74.74	38.14
11ax-HE80	MCS0	42	5210	79.80	76.50
11ax-HE80	MCS0	58	5290	79.97	76.43
11ax-HE80	MCS0	106	5530	79.95	76.61
11ax-HE80	MCS0	122	5610	80.04	76.81
11ax-HE80	MCS0	138	5690	80.27	76.60
11ax-HE80	MCS0	155	5775	79.90	76.68

Test Mode	Data Rate/ MCS	Channel No.	Frequency (MHz)	F <sub>H</sub> (MHz)	Limit (MHz)
802.11a	6Mbps	48	5240	5248.410	< 5250
802.11ac-VHT20	MCS0	48	5240	5248.845	< 5250
802.11ac-VHT40	MCS0	46	5230	5249.460	< 5250
802.11ac-VHT80	MCS0	42	5210	5247.519	< 5250
802.11ax-HE20	MCS0	48	5240	5249.424	< 5250
802.11ax-HE40	MCS0	46	5230	5249.420	< 5250
802.11ax-HE80	MCS0	42	5210	5248.252	< 5250

Note:  $F_H = \text{Centre frequency} + 99\% \text{ OBW} / 2$

For example, 802.11a 5240MHz,  $F_H = 5240 \text{ MHz} + 16.82 \text{ MHz} / 2 = 5248.410\text{MHz}$ .

802.11a 26dB Bandwidth

Channel 36 (5180MHz)



Channel 44 (5220MHz)



Channel 48 (5240MHz)

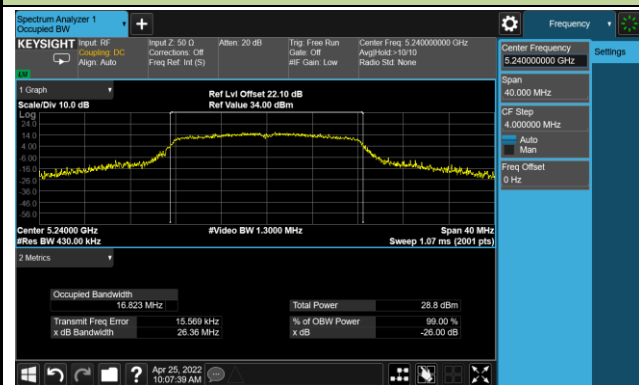

Channel 52 (5260MHz)



Channel 60 (5300MHz)



Channel 64 (5320MHz)



Channel 100 (5500MHz)

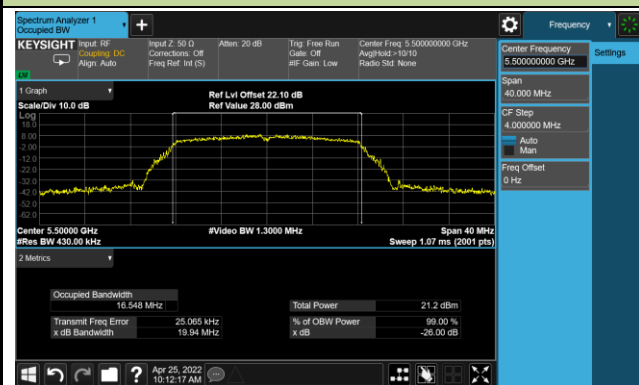

Channel 116 (5580MHz)

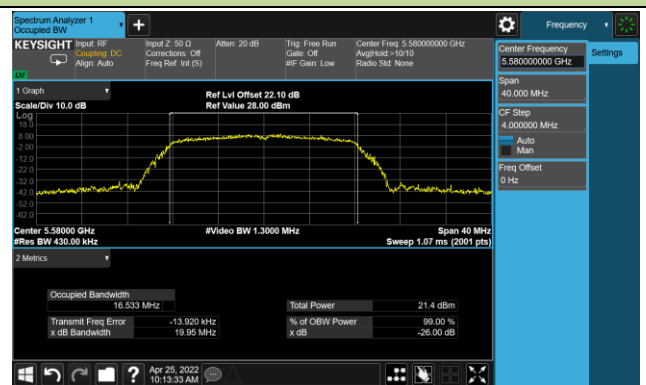

## 802.11a 26dB Bandwidth

## Channel 140 (5700MHz)

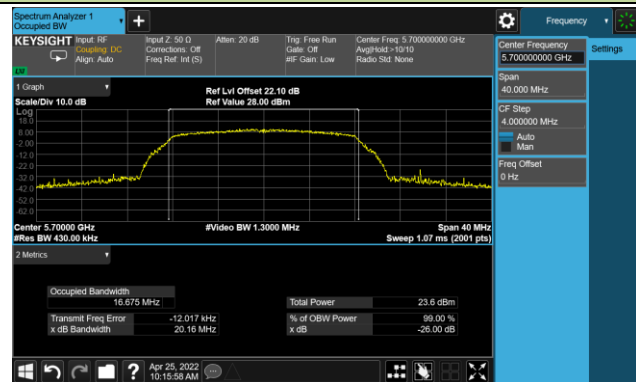

## Channel 144(5720MHz)

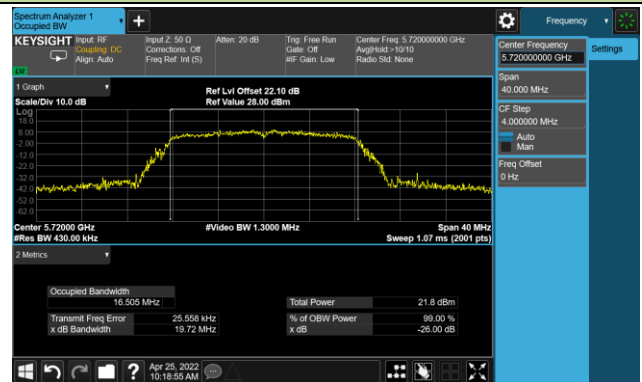

## Channel 149 (5745MHz)



## Channel 157 (5785MHz)

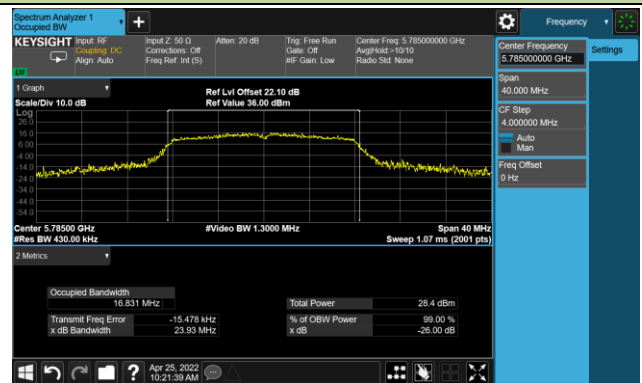

## Channel 165 (5825MHz)

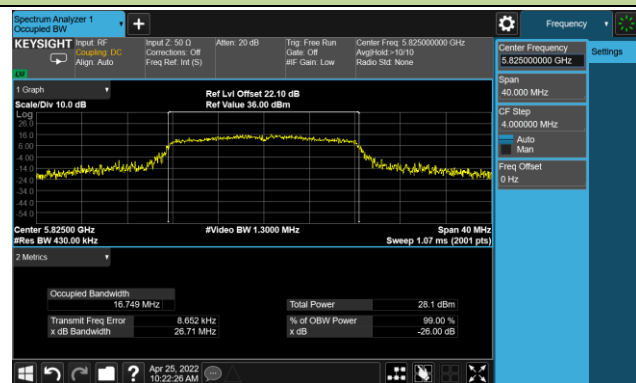



## 802.11ac-VHT20 26dB Bandwidth

Channel 36 (5180MHz)



Channel 44 (5220MHz)

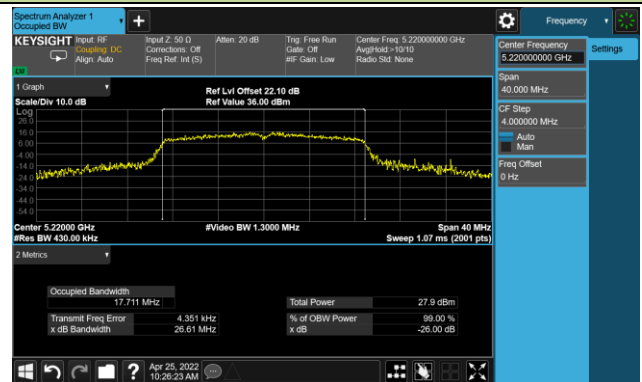

Channel 48 (5240MHz)

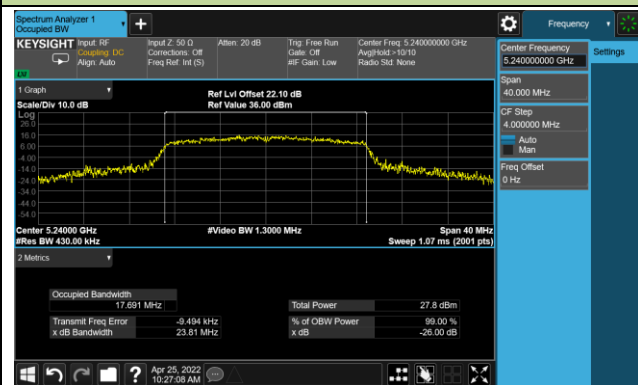

Channel 52 (5260MHz)

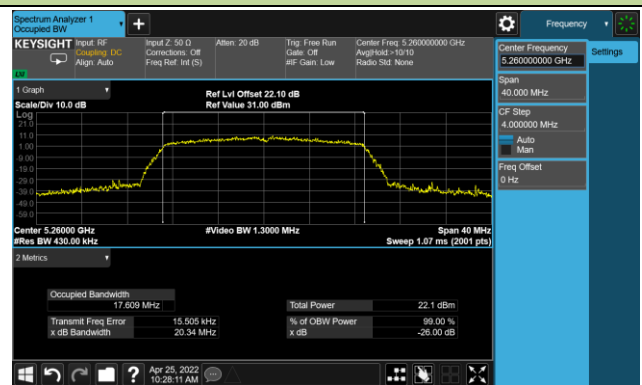

Channel 60 (5300MHz)



Channel 64 (5320MHz)

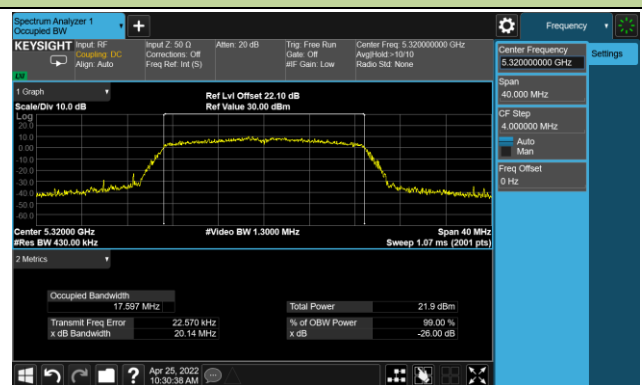

Channel 100 (5500MHz)

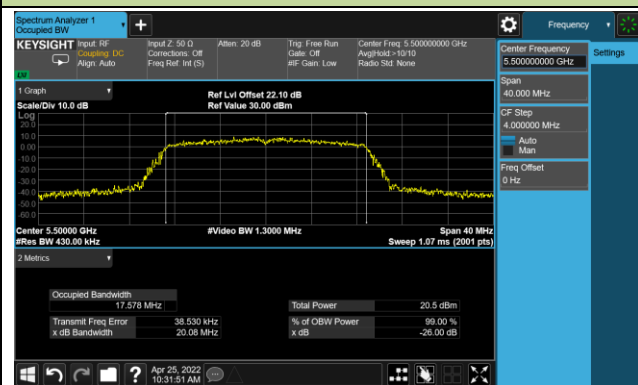

Channel 116 (5580MHz)

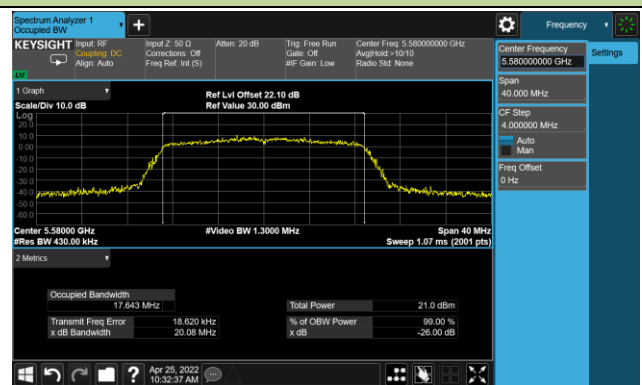

802.11ac-VHT20 26dB Bandwidth

Channel 140 (5700MHz)

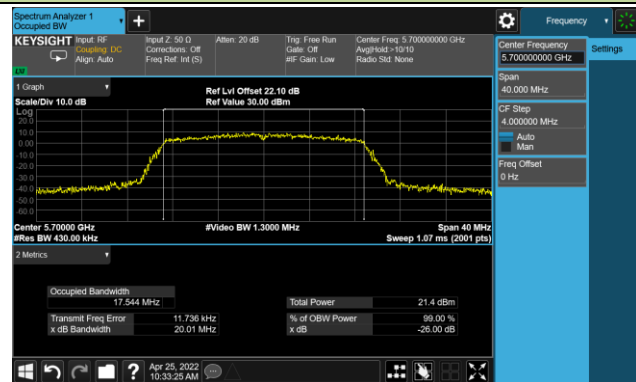

Channel 144(5720MHz)

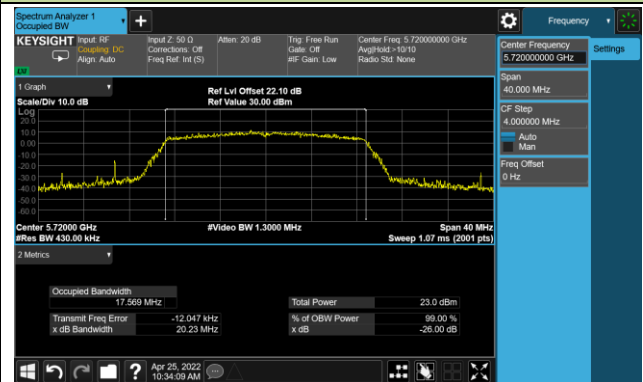

Channel 149 (5745MHz)

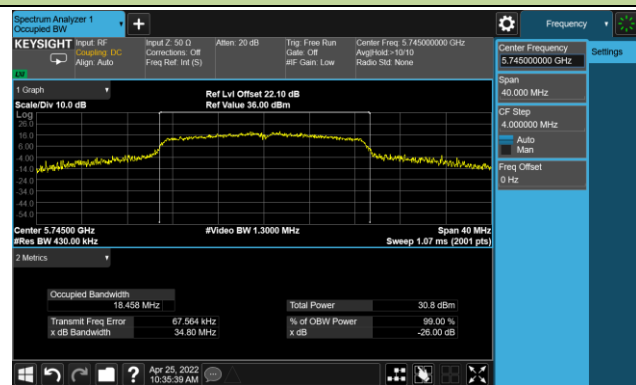

Channel 157 (5785MHz)

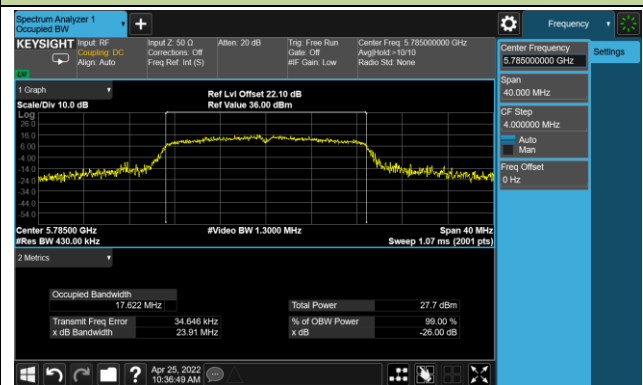

Channel 165 (5825MHz)

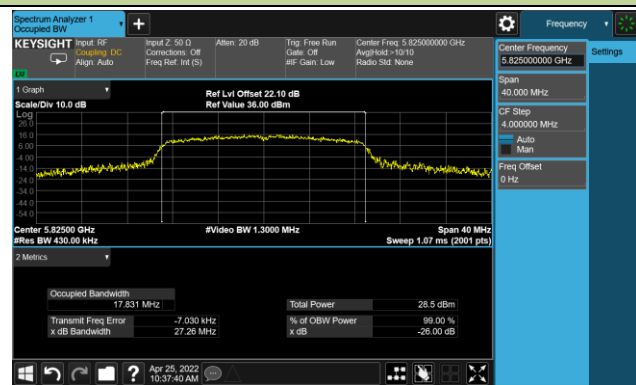

## 802.11ac-VHT40 26dB Bandwidth

Channel 38 (5190MHz)

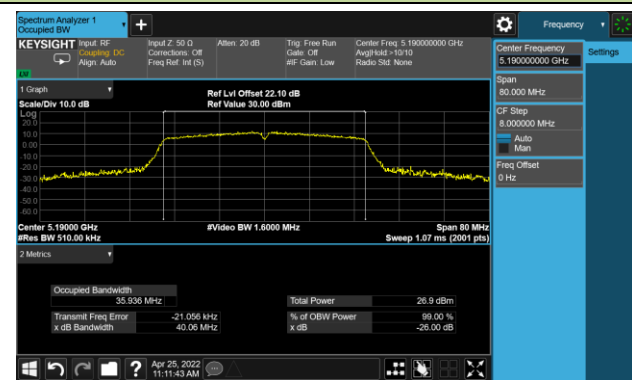

Channel 46 (5230MHz)

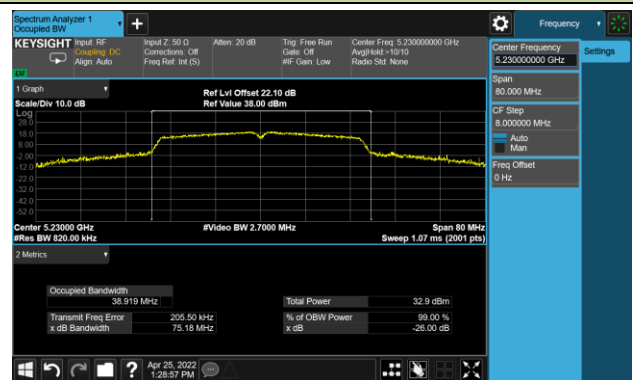

Channel 54 (5270MHz)

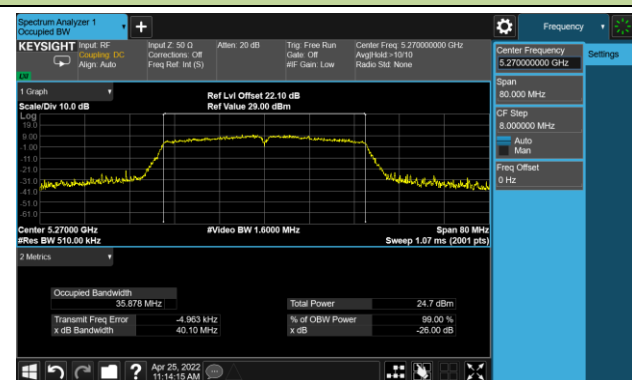

Channel 62 (5310MHz)

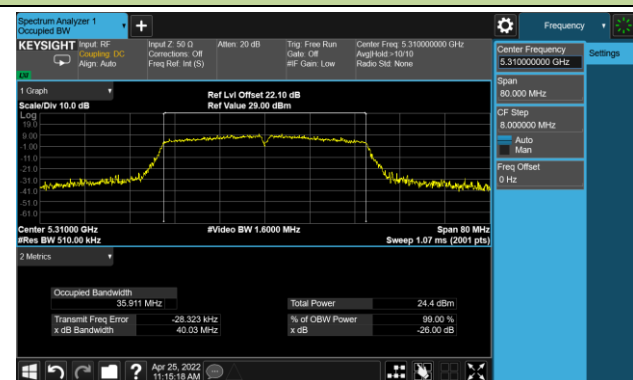

Channel 102 (5510MHz)

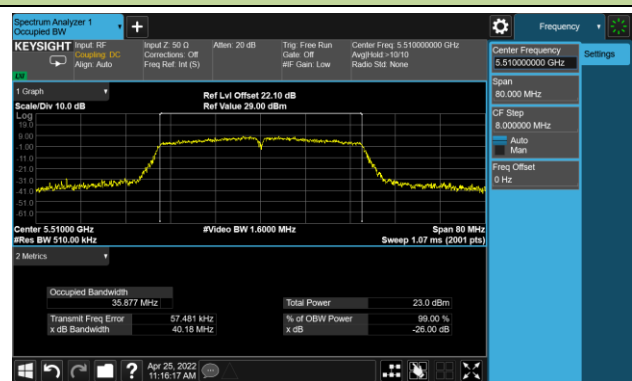

Channel 110 (5550MHz)

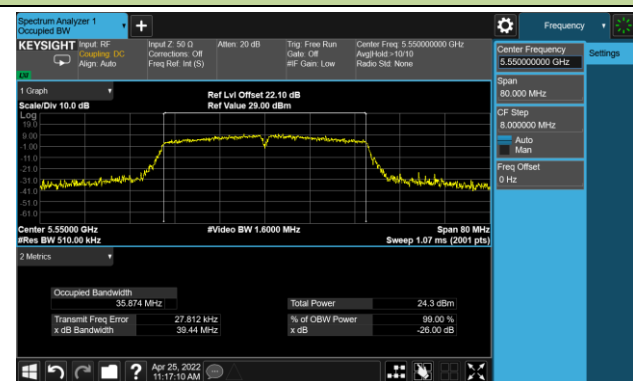

Channel 134 (5670MHz)



Channel 142(5710MHz)

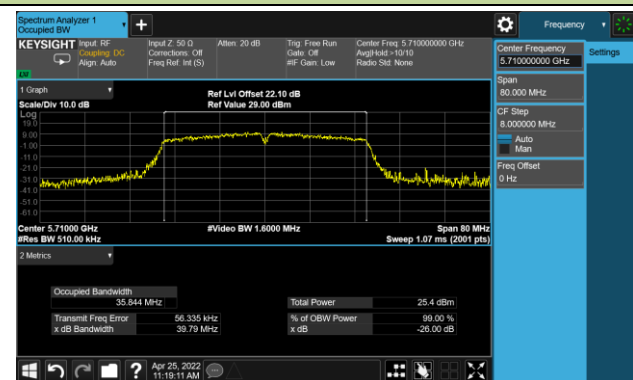

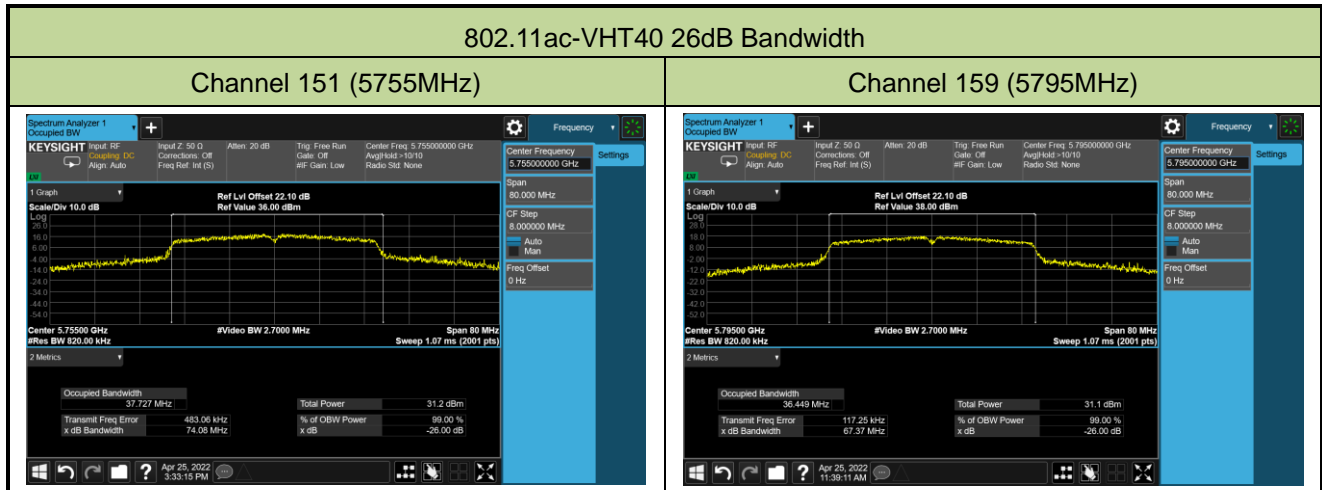

## 802.11ac-VHT80 26dB Bandwidth

Channel 42 (5210MHz)

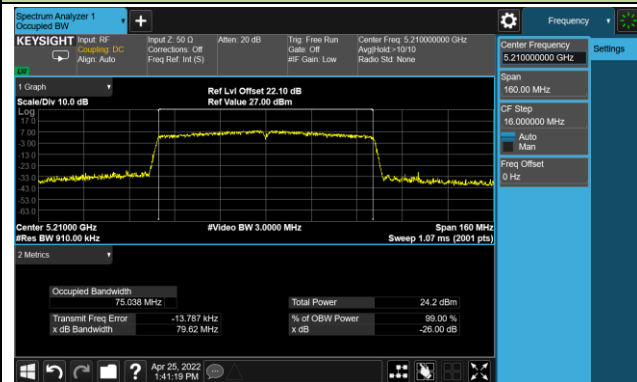

Channel 58 (5290MHz)

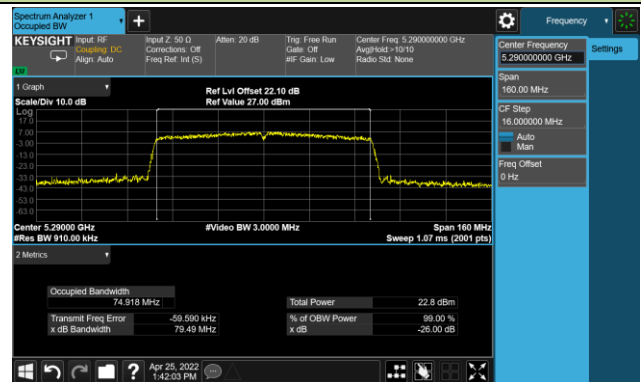

Channel 106 (5530MHz)

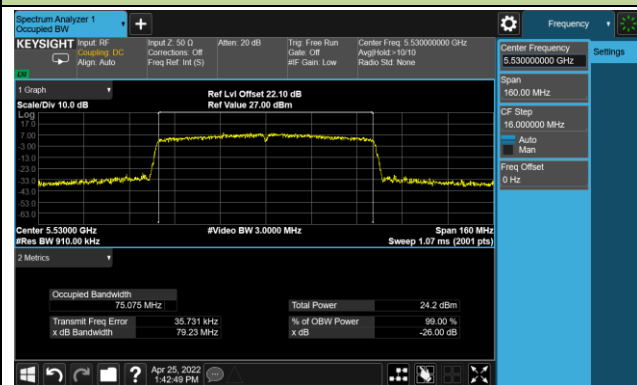

Channel 122 (5610MHz)

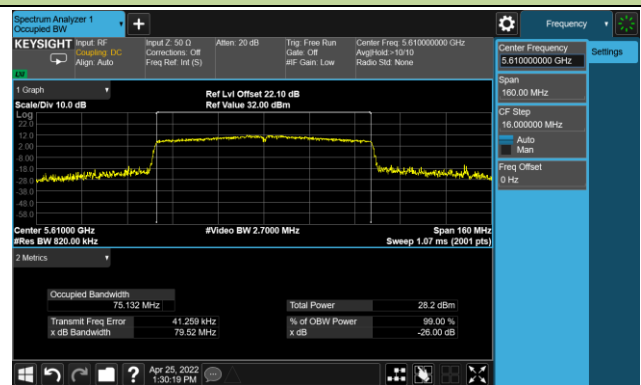

Channel 138 (5690MHz)

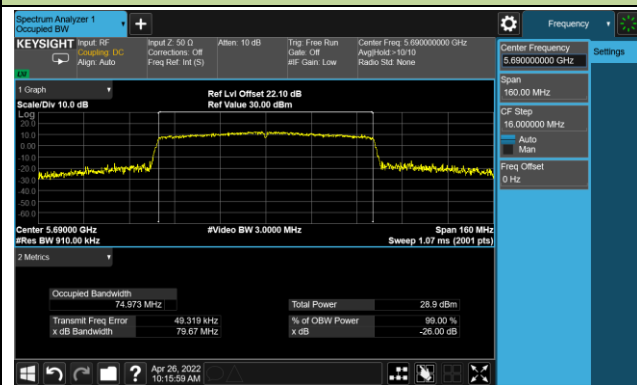

Channel 155 (5775MHz)

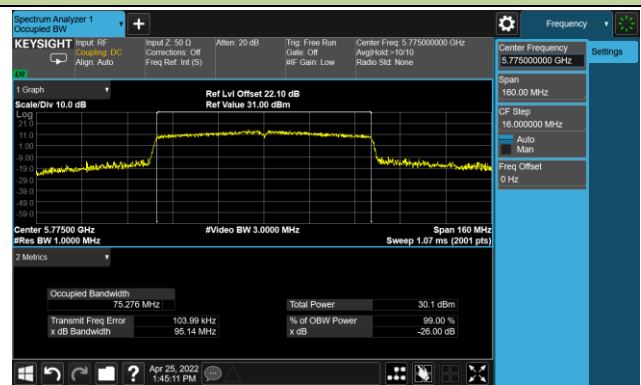

## 802.11ax-HE20 26dB Bandwidth

Channel 36 (5180MHz)

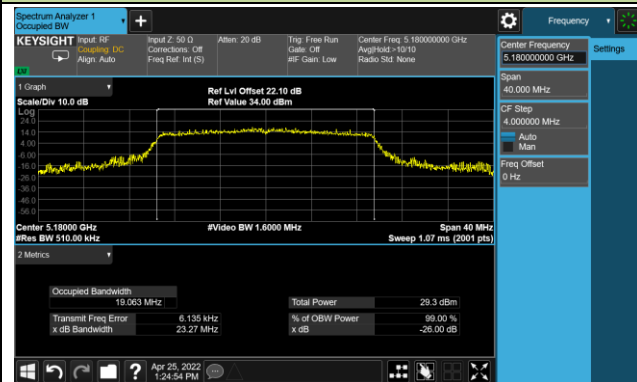

Channel 44 (5220MHz)

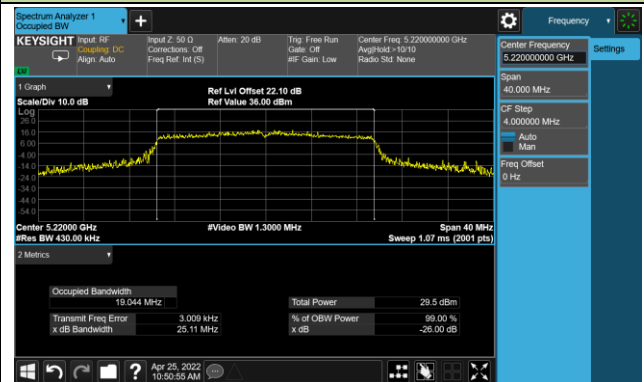

Channel 48 (5240MHz)

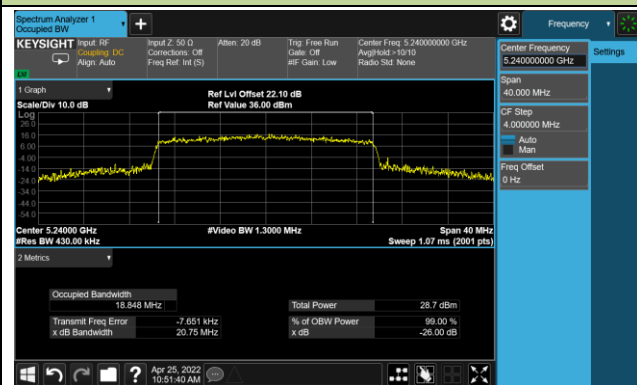

Channel 52 (5260MHz)

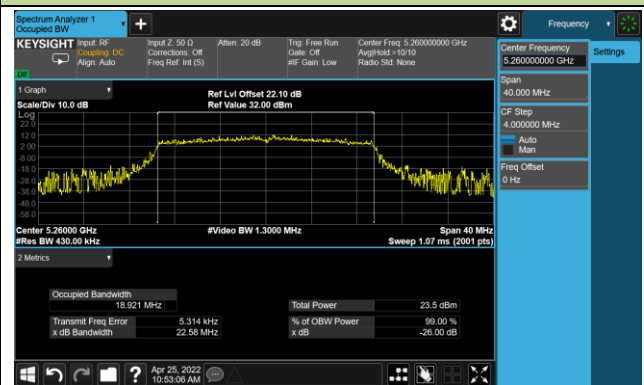

Channel 60 (5300MHz)

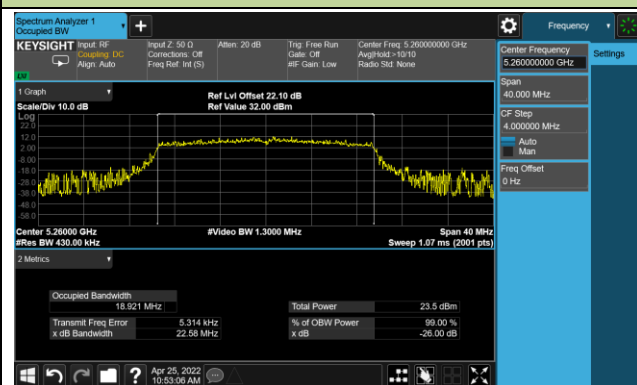

Channel 64 (5320MHz)

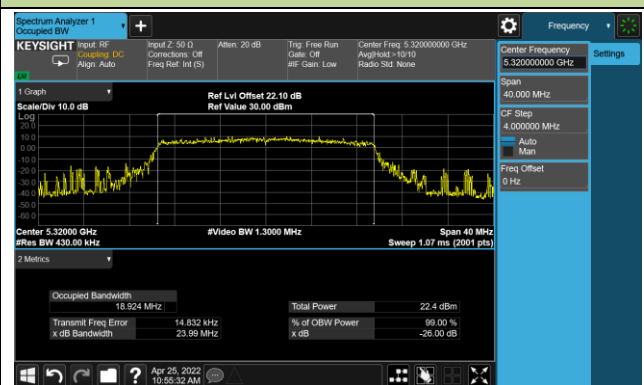

Channel 100 (5500MHz)

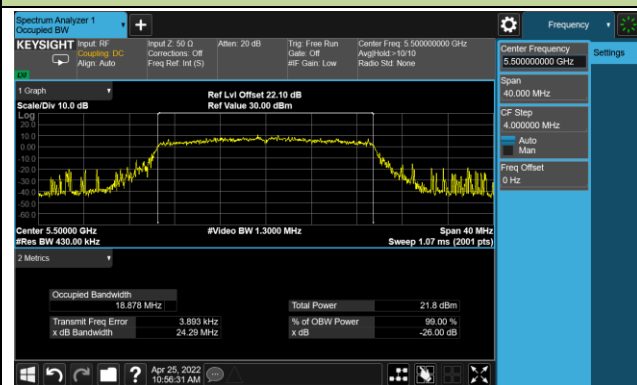

Channel 116 (5580MHz)

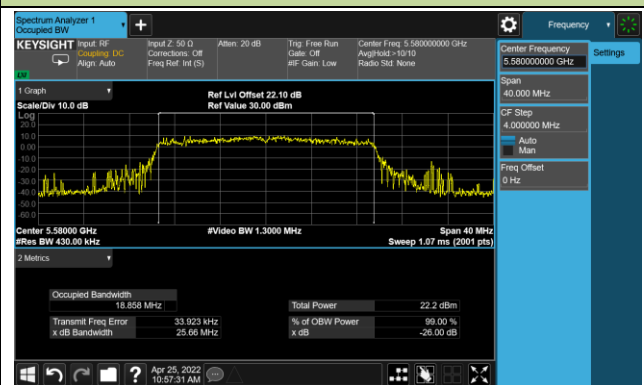

## 802.11ax-HE20 26dB Bandwidth

## Channel 140 (5700MHz)

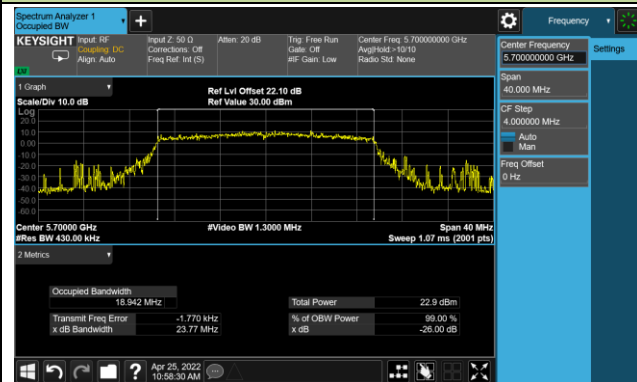

## Channel 144(5720MHz)

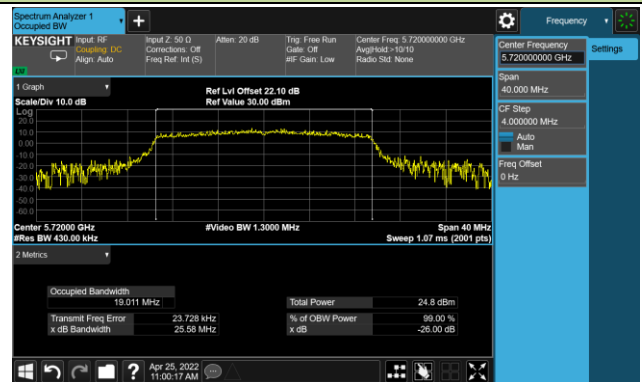

## Channel 149 (5745MHz)

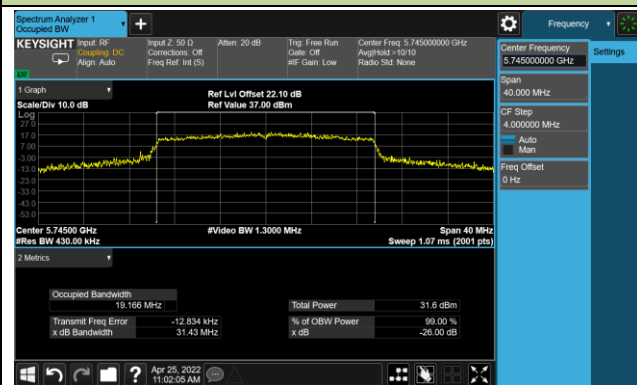

## Channel 157 (5785MHz)

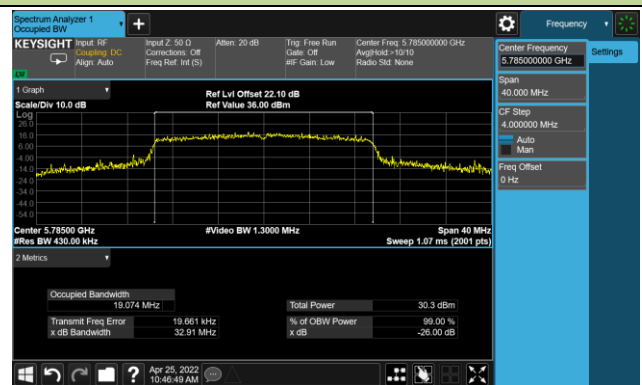

## Channel 165 (5825MHz)



802.11ax-HE40 26dB Bandwidth

Channel 38 (5190MHz)

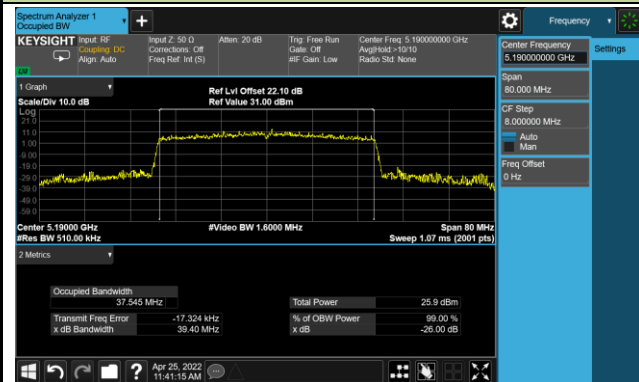

Channel 46 (5230MHz)



Channel 54 (5270MHz)

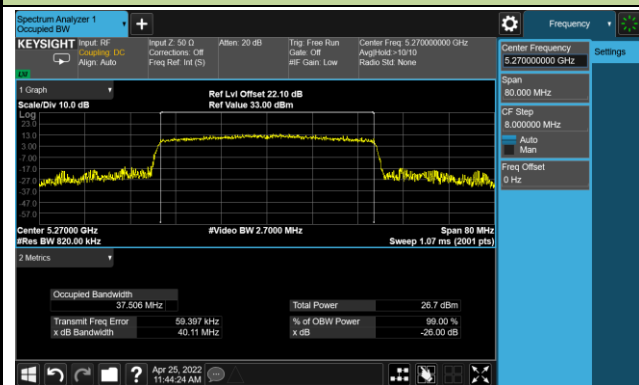

Channel 62 (5310MHz)

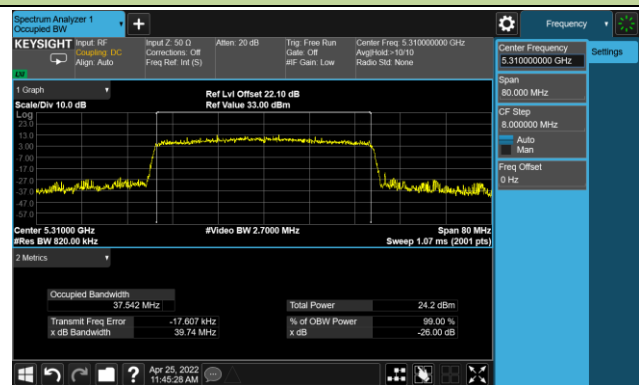

Channel 102 (5510MHz)

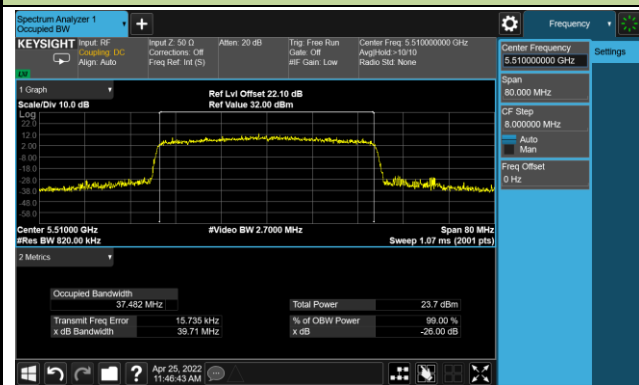

Channel 110 (5550MHz)

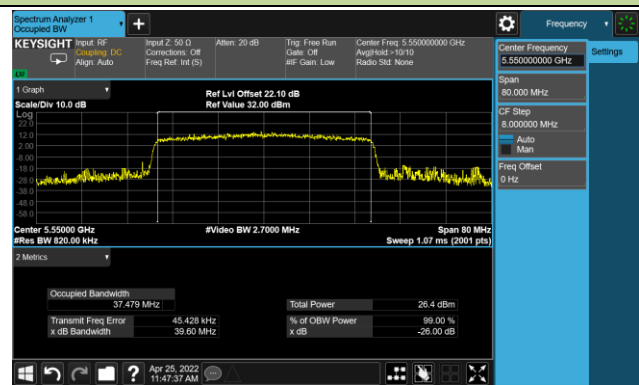

Channel 134 (5670MHz)

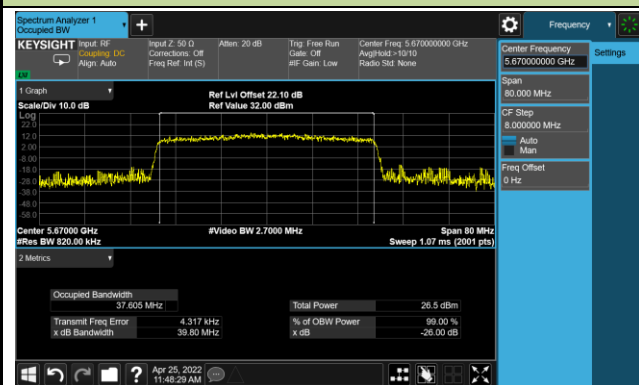

Channel 142(5710MHz)

