

# User's Guide

## EMG3435-Q20A

Dual-Band Wireless AC2600 Gigabit Ethernet Gateway

### Default Login Details

LAN IP Address	<a href="http://192.168.1.1">http://192.168.1.1</a> (Router Mode) <a href="http://192.168.1.2">http://192.168.1.2</a> (Access Point Mode)
Password	1234

Version 1.00 Edition 1, 03/2019

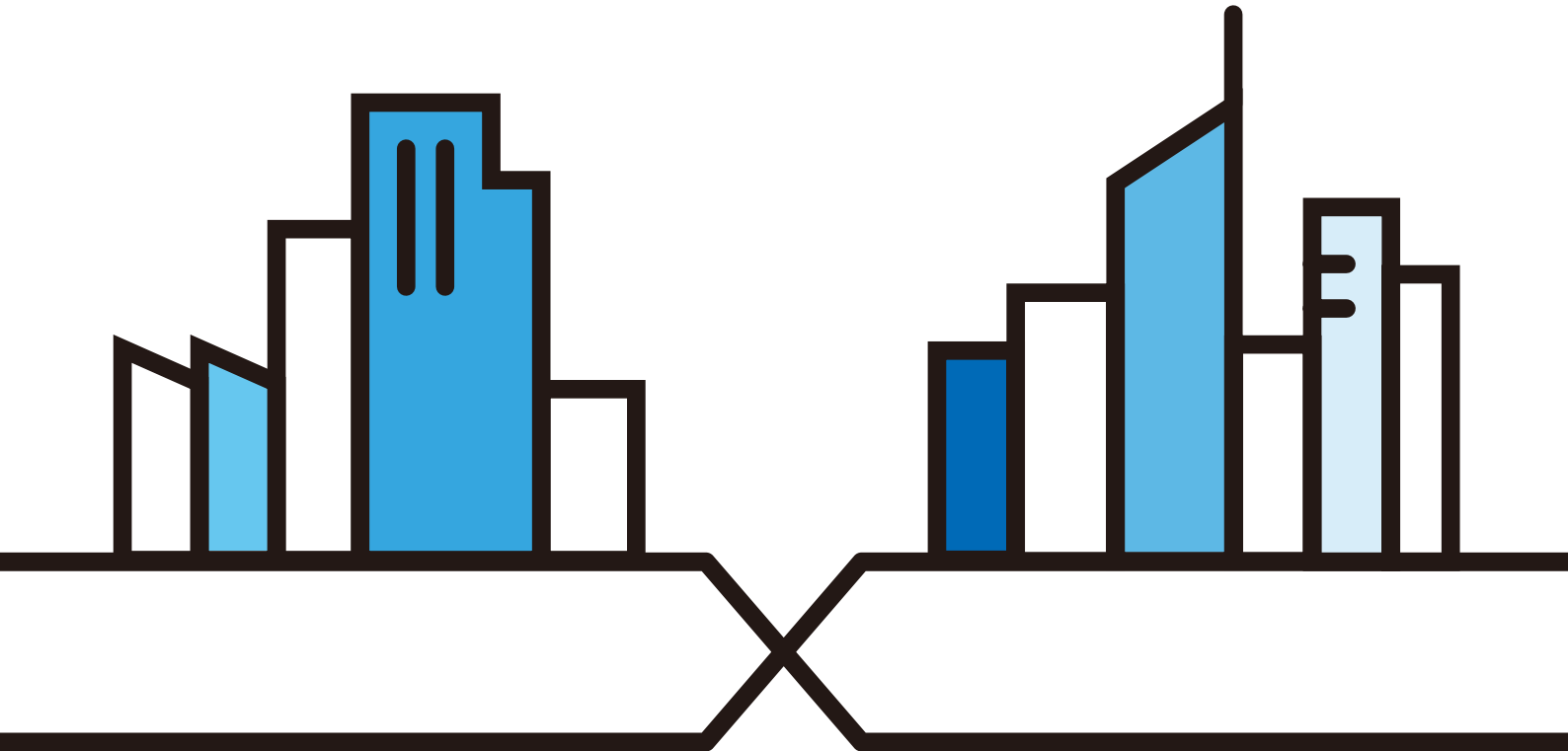

---

**IMPORTANT!**

**READ CAREFULLY BEFORE USE.**

**KEEP THIS GUIDE FOR FUTURE REFERENCE.**

Screenshots and graphics in this book may differ slightly from your product due to differences in your product firmware or your computer operating system. Every effort has been made to ensure that the information in this manual is accurate.

### **Related Documentation**

- Quick Start Guide

The Quick Start Guide shows how to connect the EMG3435-Q20A and access the Web Configurator wizards. It contains information on setting up your network and configuring for Internet access.

- More Information

Go to [support.zyxel.com](http://support.zyxel.com) to find other information on the EMG3435-Q20A.



# Contents Overview

<b>User's Guide</b> .....	<b>9</b>
Introduction .....	10
Introducing the Web Configurator .....	14
eaZy 123 Wizard .....	17
EMG3435-Q20A Modes .....	26
Easy Mode .....	27
Router Mode .....	35
Access Point Mode .....	41
Tutorials .....	48
<b>Technical Reference</b> .....	<b>58</b>
Status .....	59
WAN .....	72
Wireless LAN .....	93
LAN .....	112
Applications .....	117
Security .....	140
Maintenance .....	146
Troubleshooting .....	160

# Table of Contents

<b>Contents Overview .....</b>	<b>3</b>
<b>Table of Contents .....</b>	<b>4</b>
<b>Part I: User's Guide.....</b>	<b>9</b>
<b>Chapter 1</b>	
<b>Introduction .....</b>	<b>10</b>
1.1 Overview .....	10
1.2 Applications .....	10
1.3 Ways to Manage the EMG3435-Q20A .....	10
1.4 Good Habits for Managing the EMG3435-Q20A .....	10
1.5 Resetting the EMG3435-Q20A .....	11
1.5.1 How to Use the RESET Button .....	11
1.6 The WPS Button .....	11
1.7 LEDs .....	12
1.8 Hardware Installation .....	12
1.8.1 Pole Mounting .....	12
<b>Chapter 2</b>	
<b>Introducing the Web Configurator .....</b>	<b>14</b>
2.1 Overview .....	14
2.2 Accessing the Web Configurator .....	14
2.2.1 Login Screen .....	15
2.2.2 Change Default Password Screen .....	15
<b>Chapter 3</b>	
<b>eaZy 123 Wizard.....</b>	<b>17</b>
3.1 Overview .....	17
3.2 Accessing the eaZy 123 Wizard .....	17
3.3 Internet Type .....	19
3.3.1 WAN Selection Type: Automatic - DHCP .....	20
3.3.2 WAN Selection Type: PPPoE .....	20
3.3.3 WAN Selection Type: Static .....	21
3.4 Wireless Network .....	22
<b>Chapter 4</b>	
<b>EMG3435-Q20A Modes .....</b>	<b>26</b>

4.1 Overview .....	26
4.1.1 Web Configurator Modes .....	26
4.1.2 Device Modes .....	26
<b>Chapter 5</b>	
<b>Easy Mode .....</b>	<b>27</b>
5.1 Overview .....	27
5.2 What You Can Do .....	27
5.3 What You Need to Know .....	28
5.4 Navigation Panel .....	28
5.5 Network Map .....	29
5.6 Control Panel .....	30
5.6.1 Wi-Fi .....	31
5.6.2 Guest Wi-Fi .....	32
5.6.3 Parental Control .....	33
5.6.4 Notification .....	34
5.6.5 LED .....	34
<b>Chapter 6</b>	
<b>Router Mode .....</b>	<b>35</b>
6.1 Overview .....	35
6.2 Router Mode Status Screen .....	35
6.2.1 Navigation Panel .....	38
<b>Chapter 7</b>	
<b>Access Point Mode .....</b>	<b>41</b>
7.1 Overview .....	41
7.2 What You Can Do .....	41
7.3 What You Need to Know .....	41
7.3.1 Setting your EMG3435-Q20A to AP Mode .....	42
7.3.2 Accessing the Web Configurator in Access Point Mode .....	42
7.3.3 Configuring your WLAN and Maintenance Settings .....	43
7.4 AP Mode Status Screen .....	43
7.4.1 Navigation Panel .....	45
7.5 LAN Screen .....	45
<b>Chapter 8</b>	
<b>Tutorials .....</b>	<b>48</b>
8.1 Overview .....	48
8.2 Set Up a Wireless Network Using WPS .....	48
8.2.1 Push Button Configuration (PBC) .....	48
8.2.2 PIN Configuration .....	49
8.3 Connect to EMG3435-Q20A Wireless Network without WPS .....	50

8.3.1 Configure Your Notebook .....	52
8.4 Using Guest SSIDs on the EMG3435-Q20A .....	54
8.4.1 Configuring Security Settings of Guest SSIDs .....	55

## **Part II: Technical Reference..... 58**

### **Chapter 9 Status..... 59**

9.1 Overview .....	59
9.1.1 What You Can Do .....	59
9.2 Live Network Monitor Screen .....	59
9.3 Usage Monitor Screens .....	62
9.3.1 Internet Data Usage Monitor .....	62
9.3.2 Bandwidth History .....	63
9.3.3 Time Tracker .....	65
9.3.4 Data Usage Alert .....	65
9.4 Common Usage Screen .....	68
9.5 Download Traffic Statistics Screen .....	69
9.6 Client Tables Screen .....	70

### **Chapter 10 WAN..... 72**

10.1 Overview .....	72
10.2 What You Can Do .....	72
10.3 What You Need To Know .....	72
10.3.1 Configuring Your Internet Connection .....	73
10.4 Internet Connection Screen .....	75
10.4.1 IPoE Encapsulation .....	75
10.4.2 PPPoE Encapsulation .....	80
10.4.3 PPTP Encapsulation .....	84
10.5 NAT .....	87
10.5.1 General Screen .....	87
10.5.2 Port Trigger Screen .....	89
10.5.3 Passthrough Screen .....	89
10.6 Dynamic DNS Screen .....	91

### **Chapter 11 Wireless LAN..... 93**

11.1 Overview .....	93
11.1.1 What You Can Do .....	94
11.1.2 What You Should Know .....	94

11.2 Wireless Screen .....	97
11.3 Wireless Security .....	100
11.3.1 No Security .....	100
11.3.2 WPA-PSK/WPA2-PSK .....	101
11.3.3 WPA/WPA2 .....	102
11.4 Guest Wireless Screen .....	104
11.4.1 Guest Wireless Edit .....	105
11.5 MAC Filter Screen .....	106
11.6 Advanced Screen .....	107
11.7 WPS Screen .....	109
11.8 Scheduling Screen .....	110
<b>Chapter 12</b>	
<b>LAN .....</b>	<b>112</b>
12.1 Overview .....	112
12.2 What You Can Do .....	112
12.3 What You Need To Know .....	112
12.4 LAN IP Screen .....	113
12.5 Static DHCP Screen .....	114
12.6 IPv6 LAN Screen .....	115
<b>Chapter 13</b>	
<b>Applications .....</b>	<b>117</b>
13.1 Overview .....	117
13.1.1 What You Can Do .....	117
13.1.2 What You Need To Know .....	117
13.1.3 Before You Begin .....	118
13.2 Parental Control .....	119
13.2.1 General Screen .....	119
13.2.2 Notification Screen .....	122
13.3 Bandwidth Management .....	125
13.3.1 Bandwidth Screen .....	125
13.3.2 Priorities Screen .....	126
13.4 USB Media Sharing Screen .....	127
13.5 UPnP Screen .....	129
13.6 File Sharing .....	130
13.6.1 SAMBA Server Screen .....	130
13.6.2 FTP Server Screen .....	132
13.6.3 Example of Accessing Your Shared Files From a Computer .....	133
13.7 ONE Connect Screen .....	137
13.8 Technical Reference .....	138
<b>Chapter 14</b>	
<b>Security .....</b>	<b>140</b>

14.1 Overview .....	140
14.1.1 What You Can Do .....	140
14.1.2 What You Need To Know .....	140
14.2 IPv4 Firewall Screen .....	141
14.3 IPv6 Firewall Screen .....	143
<b>Chapter 15</b>	
<b>Maintenance.....</b>	<b>146</b>
15.1 Overview .....	146
15.2 What You Can Do .....	146
15.3 General Screen .....	146
15.4 Password Screen .....	147
15.5 Time Screen .....	148
15.6 Firmware Upgrade Screen .....	149
15.7 Backup/Restore Screen .....	151
15.8 Restart Screen .....	152
15.9 Language Screen .....	152
15.10 Remote Management Screen .....	153
15.10.1 Remote Access .....	153
15.10.2 Wake On LAN .....	155
15.11 Log Screen .....	156
15.12 System Operation Mode Overview .....	157
15.13 Operation Mode Screen .....	158
<b>Chapter 16</b>	
<b>Troubleshooting.....</b>	<b>160</b>
16.1 Overview .....	160
16.2 Power, Hardware Connections, and LEDs .....	160
16.3 EMG3435-Q20A Access and Login .....	161
16.4 Internet Access .....	162
16.5 Resetting the EMG3435-Q20A to Its Factory Defaults .....	164
16.6 Wireless Connections .....	164
16.7 USB Device Problems .....	166
Appendix A Customer Support .....	167
Appendix B Setting Up Your Computer's IP Address.....	173
Appendix C Common Services .....	193
Appendix D Legal Information .....	196
<b>Index.....</b>	<b>202</b>



---

# PART I

## User's Guide

---

# CHAPTER 1

# Introduction

## 1.1 Overview

This chapter introduces the main features and applications of the EMG3435-Q20A.

The EMG3435-Q20A extends the range of your existing wired network without additional wiring, providing easy network access to mobile users. You can set up a wireless network with other IEEE 802.11 a/b/g/n/ac compatible devices. The EMG3435-Q20A is able to function both 2.4GHz and 5GHz networks at the same time.

A range of services such as a firewall and content filtering are also available for secure Internet computing.

## 1.2 Applications

You can have the following networks with the EMG3435-Q20A:

- **Wired.** You can connect network devices via the Ethernet ports of the EMG3435-Q20A so that they can communicate with each other and access the Internet.
- **Wireless.** Wireless clients can connect to the EMG3435-Q20A to access network resources. You can use WPS (Wi-Fi Protected Setup) to create an instant network connection with another WPS-compatible device.
- **WAN.** Connect to a broadband modem/router for Internet access.

## 1.3 Ways to Manage the EMG3435-Q20A

Use any of the following methods to manage the EMG3435-Q20A.

- **WPS (Wi-Fi Protected Setup).** You can use the WPS button or the WPS section of the Web Configurator to set up a wireless network with your EMG3435-Q20A.
- **Web Configurator.** This is recommended for everyday management of the EMG3435-Q20A using a (supported) web browser.

## 1.4 Good Habits for Managing the EMG3435-Q20A

Do the following things regularly to make the EMG3435-Q20A more secure and to manage the EMG3435-Q20A more effectively.

- Change the password. Use a password that's not easy to guess and that consists of different types of characters, such as numbers and letters.
- Write down the password and put it in a safe place.
- Back up the configuration (and make sure you know how to restore it). Restoring an earlier working configuration may be useful if the device becomes unstable or even crashes. If you forget your password, you will have to reset the EMG3435-Q20A to its factory default settings. If you backed up an earlier configuration file, you would not have to totally re-configure the EMG3435-Q20A. You could simply restore your last configuration.

## 1.5 Resetting the EMG3435-Q20A

If you forget your password or IP address, or you cannot access the Web Configurator, you will need to use the **RESET** button at the back of the EMG3435-Q20A to reload the factory-default configuration file. This means that you will lose all configurations that you had previously saved, the password will be reset to "1234" and the IP address will be reset to "192.168.1.1".

### 1.5.1 How to Use the RESET Button

- 1 Make sure the power LED is on.
- 2 Press the **RESET** button for one to four seconds to restart/reboot the EMG3435-Q20A.
- 3 Press the **RESET** button for longer than five seconds to set the EMG3435-Q20A back to its factory-default configurations.

## 1.6 The WPS Button

Your EMG3435-Q20A supports Wi-Fi Protected Setup (WPS), which is an easy way to set up a secure wireless network. WPS is an industry standard specification, defined by the Wi-Fi Alliance.

WPS allows you to quickly set up a wireless network with strong security, without having to configure security settings manually. Each WPS connection works between two devices. Both devices must support WPS (check each device's documentation to make sure).

Depending on the devices you have, you can either press a button (on the device itself, or in its configuration utility) or enter a PIN (a unique Personal Identification Number that allows one device to authenticate the other) in each of the two devices. When WPS is activated on a device, it has two minutes to find another device that also has WPS activated. Then, the two devices connect and set up a secure network by themselves.

You can use the WPS button on the rear panel of the EMG3435-Q20A to activate WPS in order to quickly set up a wireless network with strong security.

- 1 Make sure the power LED is on (not blinking).
- 2 Press the WPS button for more than three seconds and release it. Press the WPS button on another WPS-enabled device within range of the EMG3435-Q20A.

Note: You must activate WPS in the EMG3435-Q20A and in another wireless device within two minutes of each other.

For more information on using WPS, see [Section 8.2 on page 48](#).

## 1.7 LEDs

The following figure shows the rear panel of the EMG3435-Q20A.

Figure 1 Rear Panel

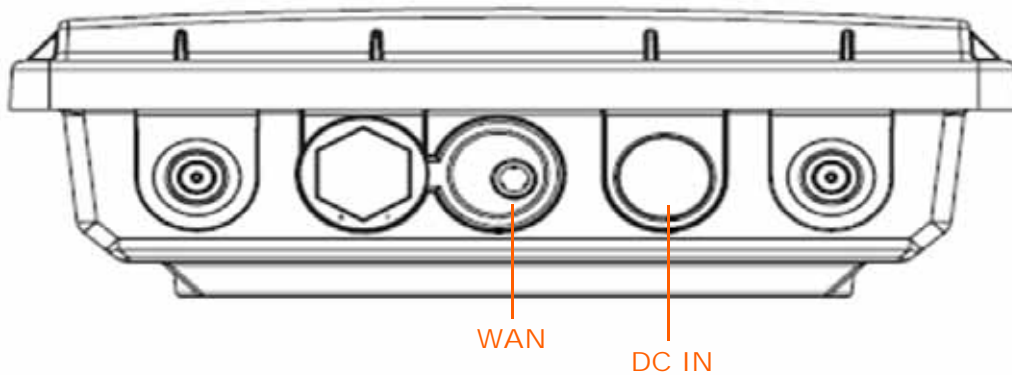

## 1.8 Hardware Installation

This chapter shows you how to mount the EMG3435-Q20A to a pole or on a wall.

Note: At the time of writing, the holes with grounding icons on the bottom don't work.

### 1.8.1 Pole Mounting

You can mount the EMG3435-Q20A to a pole using the following parts.

Table 1 Pole Mounting Parts

1	EMG3435-Q20A
2	Bracket for angle adjustment
3	U-bolt
4	M5 screw
5	<ul style="list-style-type: none"> <li>• M6 Screw</li> <li>• Spring Washer</li> <li>• Washer</li> </ul>
6	Bracket

The following figure introduces the specifications of the parts.

Figure 2 Specifications

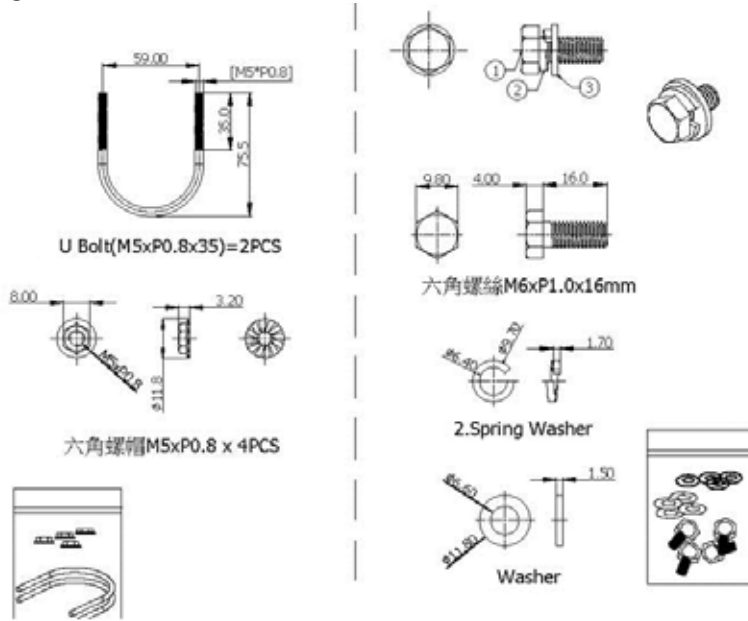

Follow the listed steps to mount the EMG3435-Q20A to a pole.

Figure 3 Pole Mounting Example

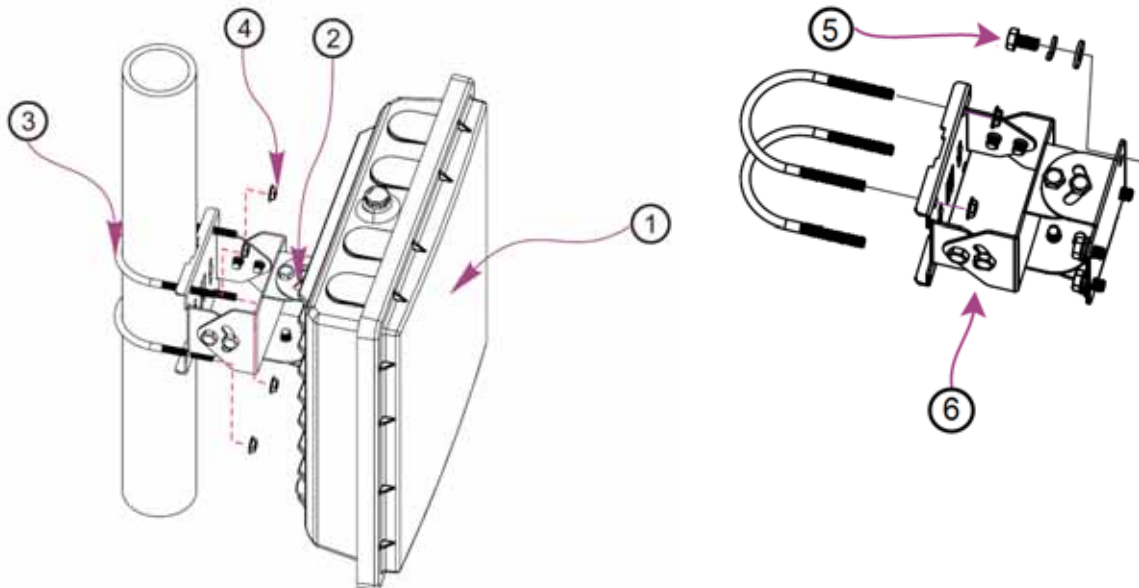

- 1 Use 3 and 4 to attach 6 to the pole.
- 2 Use 5 to attach the EMG3435-Q20A to 6 on the pole.
- 3 Use 2 to adjust the EMG3435-Q20A. You can have the EMG3435-Q20A tilt up, face forward, or tilt down.

# CHAPTER 2

# Introducing the Web Configurator

## 2.1 Overview

This chapter describes how to access the EMG3435-Q20A Web Configurator and provides an overview of its screens.

The Web Configurator is an HTML-based management interface that allows easy setup and management of the EMG3435-Q20A via Internet browser. Use a browser that supports HTML5, such as Internet Explorer 9.0 and later versions, Mozilla Firefox 21 and later versions, Safari 6.0 and later versions or Google Chrome 26.0 and later versions. The recommended screen resolution is 1024 by 768 pixels.

In order to use the Web Configurator you need to allow:

- Web browser pop-up windows from your device. Web pop-up blocking is enabled by default in Windows 7.
- JavaScript (enabled by default).
- Java permissions (enabled by default).

Refer to the Troubleshooting chapter ([Chapter 16 on page 160](#)) to see how to make sure these functions are allowed in Internet Explorer.

## 2.2 Accessing the Web Configurator

- 1 Make sure your EMG3435-Q20A hardware is properly connected and prepare your computer or computer network to connect to the EMG3435-Q20A (refer to the Quick Start Guide).
- 2 Launch your web browser.
- 3 The EMG3435-Q20A is in router mode by default. Type "http://192.168.1.1 or http://myrouter" as the website address. If the EMG3435-Q20A obtains a WAN IP address or a DNS server IP address in the same subnet as the LAN IP address 192.168.1.1, the default LAN IP address will be changed to 10.0.0.1 automatically. See [Auto-IP Change on page 74](#) for more information.

If the EMG3435-Q20A is in access point, the IP address is 192.168.1.2. See [Chapter 4 on page 26](#) for more information about the modes of the EMG3435-Q20A.

Your computer must be in the same subnet in order to access this website address.

## 2.2.1 Login Screen

Note: If this is the first time you are accessing the Web Configurator, you may be redirected to the eaZy123 wizard. Refer to [Chapter 3 on page 17](#) for the eaZy123 setup screens.

The Web Configurator initially displays the following login screen.

Figure 4 Login screen

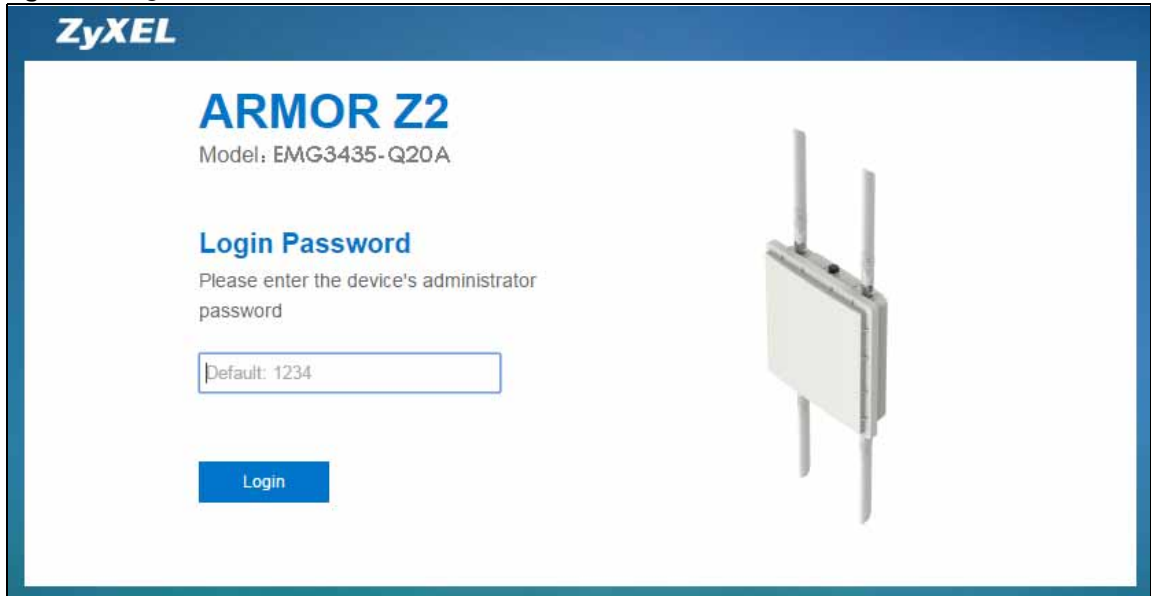

The following table describes the labels in this screen.

Table 2 Login screen

LABEL	DESCRIPTION
Password	Type "1234" (default) as the password. Click <b>Login</b> .

## 2.2.2 Change Default Password Screen

You should see a screen asking you to change your password (highly recommended) as shown next.

Figure 5 Change Default Password Screen

The following table describes the labels in this screen.

Table 3 Change Default Password Screen

LABEL	DESCRIPTION
Enter your new password here	Type a new password.
Confirm password	Retype the password for confirmation.
Skip	Click <b>Skip</b> if you do not want to change the password this time.
Change	Click <b>Change</b> to save your changes back to the EMG3435-Q20A.

Note: The management session automatically times out when the time period set in the **Administrator Inactivity Timer** field expires (default five minutes; go to [Chapter 15 on page 146](#) to change this). Simply log back into the EMG3435-Q20A if this happens.



# CHAPTER 3

## eaZy 123 Wizard

### 3.1 Overview

This chapter provides information on the eaZy 123 setup screens in the Web Configurator.

The Web Configurator's eaZy 123 setup wizard helps you configure your device to access the Internet. Refer to your ISP for your Internet account information. Leave a field blank if you don't have that information.

### 3.2 Accessing the eaZy 123 Wizard

Launch your web browser and type "http://192.168.1.1 or http://myrouter" as the website address. Type "1234" (default) as the password and click **Login**.

Note: The eaZy 123 wizard appears automatically when the EMG3435-Q20A is accessed for the first time or when you reset the EMG3435-Q20A to its default factory settings. If you didn't configure the wizard screens, you will be redirected to the login page when you connect to the Internet.

If you have already configured the wizard screens and want to open it again, click  on the upper right corner of any Web Configurator screen. The eaZy 123 wizard attempts to detect which WAN connection type you are using.

If the eaZy 123 wizard does not detect a connection type, you must select one from the drop-down list box. Check with your ISP to make sure you use the correct type.

If you do not have the Internet connection, the following screen opens.

Figure 6 Unable to continue: WAN



If you do not press the Wi-Fi button located on the EMG3435-Q20A's back panel, the following screen opens.

Figure 7 Unable to continue: Wi-Fi

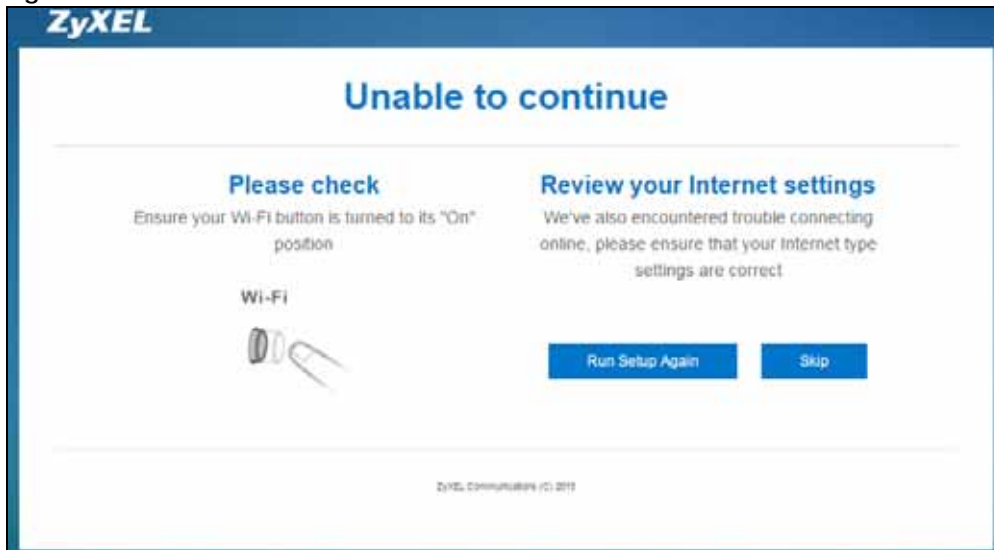

Note: If you get an error message, check your hardware connections. Make sure your Internet connection is up and running.

The wizard screen opens.

Figure 8 Detecting your Internet Connection Type

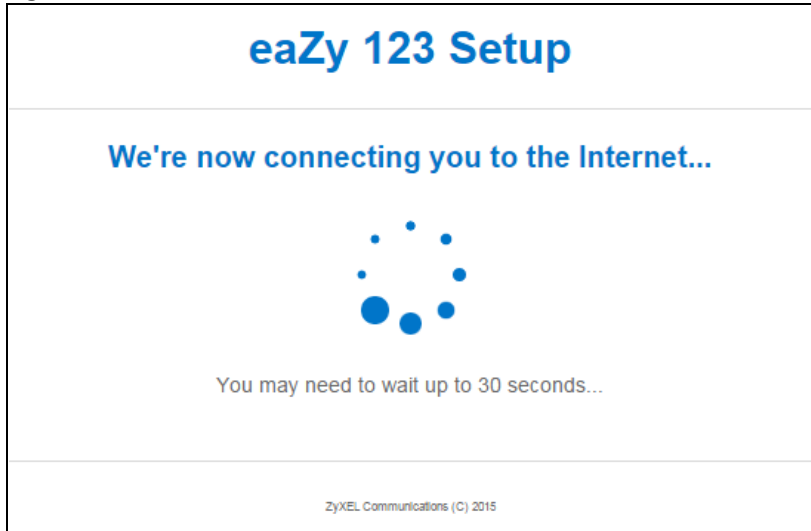
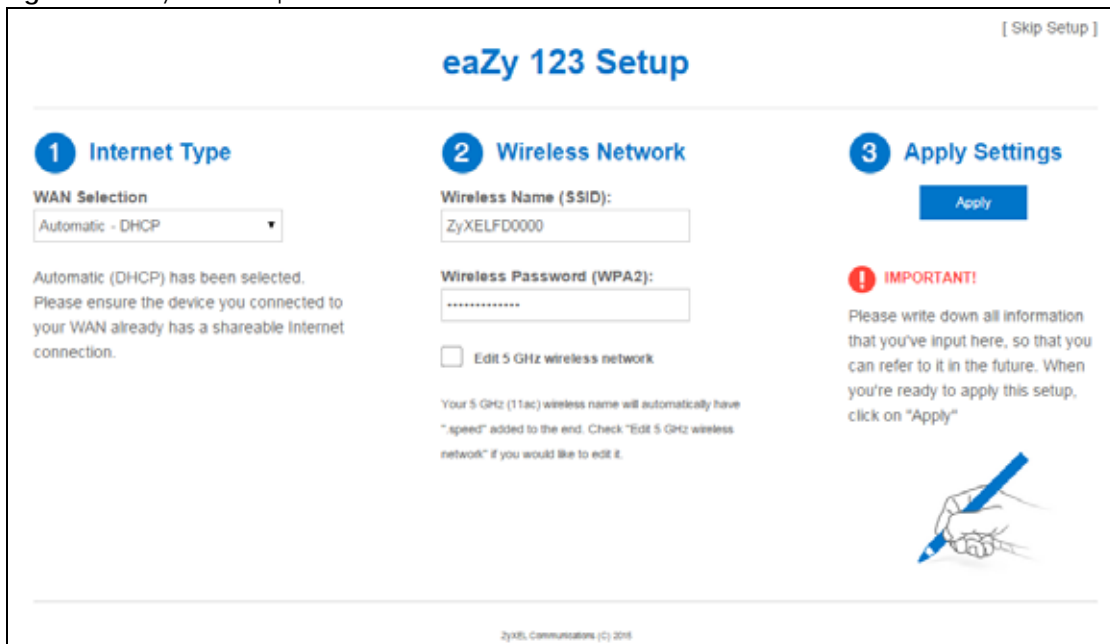

Figure 9 eaZy 123 Setup



### 3.3 Internet Type

The EMG3435-Q20A offers three WAN selection types. They are **Automatic - DHCP**, **PPPoE** or **Static**. Configure the Internet type settings on your EMG3435-Q20A in the first part. The following screen depends on your Internet connection type. Enter the details provided by your Internet Service Provider (ISP) in the fields (if any).

Check with your ISP to make sure you use the correct type. This wizard screen varies according to the connection type that you select.

### 3.3.1 WAN Selection Type: Automatic - DHCP

Select the **Automatic - DHCP** option if your ISP did not assign you a fixed IP address.

**Figure 10** WAN Selection Type: Automatic - DHCP

The screenshot shows the 'eaZy 123 Setup' wizard with three main sections: 1. Internet Type, 2. Wireless Network, and 3. Apply Settings. The first section, 'Internet Type', is highlighted with a blue box and contains a 'WAN Selection' dropdown menu set to 'Automatic - DHCP'. Below the dropdown, it states: 'Automatic (DHCP) has been selected. Please ensure the device you connected to your WAN already has a shareable Internet connection.' The second section, 'Wireless Network', includes fields for 'Wireless Name (SSID)' (ZyXELFD0000) and 'Wireless Password (WPA2)', along with an unchecked checkbox for 'Edit 5 GHz wireless network'. The third section, 'Apply Settings', features an 'Apply' button and an 'IMPORTANT!' warning: 'Please write down all information that you've input here, so that you can refer to it in the future. When you're ready to apply this setup, click on "Apply"'. A hand holding a pen icon is shown below the warning. The top right corner has a '[ Skip Setup ]' link, and the bottom center has 'ZyXEL Communications (c) 2016'.

### 3.3.2 WAN Selection Type: PPPoE

Point-to-Point Protocol over Ethernet (PPPoE) functions as a dial-up connection. PPPoE is an IETF (Internet Engineering Task Force) standard specifying how a host personal computer interacts with a broadband modem (for example DSL, cable, wireless, etc.) to achieve access to high-speed data networks.

For the service provider, PPPoE offers an access and authentication method that works with existing access control systems (for instance, RADIUS).

One of the benefits of PPPoE is the ability to let end users access one of multiple network services, a function known as dynamic service selection. This enables the service provider to easily create and offer new IP services for specific users.

Operationally, PPPoE saves significant effort for both the subscriber and the ISP/carrier, as it requires no specific configuration of the broadband modem at the subscriber's site.

By implementing PPPoE directly on the EMG3435-Q20A (rather than individual computers), the computers on the LAN do not need PPPoE software installed, since the EMG3435-Q20A does that part of the task. Furthermore, with NAT, all of the LAN's computers will have Internet access.

Figure 11 WAN Selection Type: PPPoE

The screenshot shows the 'eaZy 123 Setup' wizard. The first step, 'Internet Type', is highlighted with a blue border. It contains a dropdown menu for 'WAN Selection' set to 'PPPoE', a text field for 'PPPoE Username' with the placeholder 'youname@isp.com', a text field for 'PPPoE Password' with the placeholder 'yourisp-password', and a text field for 'Static IP (Optional)' with the placeholder '123.123.123.123'. Below these fields is a note: 'Please input your PPPoE username and password. This information is provided by your Internet Service Provider. Usually this internet type is for DSL users.' The second step, 'Wireless Network', includes a text field for 'Wireless Name (SSID)' with 'ZyXELFD0000', a text field for 'Wireless Password (WPA2)', a checked checkbox for 'Edit 5 GHz wireless network', a text field for '5 GHz Wireless Name (SSID)' with 'ZyXELFD0000.speed', and a text field for '5 GHz Wireless Password (WPA2)'. A note below states: 'Your 5 GHz (11ac) wireless name will automatically have "speed" added to the end. Check "Edit 5 GHz wireless network" if you would like to edit it.' The third step, 'Apply Settings', features an 'Apply' button and an 'IMPORTANT!' warning: 'Please write down all information that you've input here, so that you can refer to it in the future. When you're ready to apply this setup, click on "Apply"'. An illustration of a hand holding a pen is shown next to the warning.

The following table describes the labels in this screen.

Table 4 WAN Selection Type: PPPoE

LABEL	DESCRIPTION
WAN Selection	Select the <b>PPPoE</b> (Point-to-Point Protocol over Ethernet) option for a dial-up connection.
PPPoE Username	Type the user name given to you by your ISP.
PPPoE Password	Type the password associated with the user name above.
Static IP (Optional)	Enter the WAN IP address assigned by your ISP.

Note: If you get an error message, make sure you have entered the correct information provided by your ISP.

### 3.3.3 WAN Selection Type: Static

Choose **Static** as the **WAN Selection Type** when the WAN port is used as a regular Ethernet. Click **Next**.

Figure 12 WAN Selection Type: Static

The screenshot shows the 'eaZy 123 Setup' wizard. The first step, 'Internet Type', is highlighted with a blue box. It contains a 'WAN Selection' dropdown menu set to 'Static'. Below it are input fields for 'IP Address' (123.123.123.123), 'Subnet mask' (255.255.255.0), 'Gateway IP Address (Optional)' (8.8.8.8), and 'DNS Server' (8.8.8.8). A note below these fields says: 'Please input your static IP information. This information is provided by your Internet Service Provider.' The second step, 'Wireless Network', includes fields for 'Wireless Name (SSID)' (ZyXELBADB06), 'Wireless Password (WPA2)' (masked with dots), a checked checkbox for 'Edit 5 GHz wireless network', '5 GHz Wireless Name (SSID)' (ZyXELBADB06 speed), and '5 GHz Wireless Password (WPA2)' (masked with dots). A note below these fields says: 'Your 5 GHz (11ac) wireless name will automatically have "speed" added to the end. Check "Edit 5 GHz wireless network" if you would like to edit it.' The third step, 'Apply Settings', features an 'Apply' button and an 'IMPORTANT!' warning: 'Please write down all information that you've input here, so that you can refer to it in the future. When you're ready to apply this setup, click on "Apply"'. A hand holding a pen is shown writing on a notepad.

The following table describes the labels in this screen.

Table 5 WAN Selection Type: Static

LABEL	DESCRIPTION
WAN Selection	Select the <b>Static</b> option when the WAN port is using a fixed IP address.
IP Address	Enter the IP address provided by your ISP.
Subnet Mask	Enter the IP subnet mask in this field.
Gateway IP Address (Optional)	Enter the gateway IP address in this field.
DNS Server	Enter the DNS server IP address in this field.

Note: If you get an error screen, make sure your Internet connection is working and select the right WAN Selection Type. Contact your ISP if you are not sure of your Internet Connection type.

## 3.4 Wireless Network

Configure the wireless network settings on your EMG3435-Q20A in the second part. The default wireless security setting is WPA2-PSK.

Figure 13 Wireless Network

[ Skip Setup ]

## eaZy 123 Setup

### 1 Internet Type

WAN Selection  
PPPoE

PPPoE Username:  
youname@isp.com

PPPoE Password:  
yourisp-password

Static IP (Optional):  
123.123.123.123

Please input your PPPoE username and password. This information is provided by your Internet Service Provider. Usually this internet type is for DSL users.

### 2 Wireless Network

Wireless Name (SSID):  
ZyXELFD0000

Wireless Password (WPA2):  
.....

Edit 5 GHz wireless network

5 GHz Wireless Name (SSID):  
ZyXELFD0000.speed

5 GHz Wireless Password (WPA2):  
.....

Your 5 GHz (11ac) wireless name will automatically have "speed" added to the end. Check "Edit 5 GHz wireless network" if you would like to edit it.

### 3 Apply Settings

**Apply**

**! IMPORTANT!**

Please write down all information that you've input here, so that you can refer to it in the future. When you're ready to apply this setup, click on "Apply"

ZyXEL Communications (C) 2015

The following table describes the labels in this screen.

Table 6 Wireless Network

LABEL	DESCRIPTION
Wireless Name (SSID)	Enter a descriptive name for the wireless LAN.  Note: The setting here applies to 2.4 GHz wireless radios.  If you change this field on the EMG3435-Q20A, make sure all wireless stations use the same SSID in order to access the network.
Wireless Password (WPA2)	Type from 8 to 63 case-sensitive ASCII characters. You can set up the most secure wireless connection by configuring WPA in the wireless LAN screens.
Edit 5 GHz wireless network	Select this check box to configure different SSID and wireless security settings for the EMG3435-Q20A's 5 GHz wireless network.  If you do not select this option, the EMG3435-Q20A uses the same SSID and Wi-Fi key (you configured above) for the 5 GHz wireless network.
5GHz Wireless Name (SSID)	Enter a descriptive name for the wireless LAN.  If you change this field on the EMG3435-Q20A, make sure all wireless stations use the same SSID in order to access the network.
5GHz Wireless Password (WPA2)	Type from 8 to 63 case-sensitive ASCII characters. You can set up the most secure wireless connection by configuring WPA in the wireless LAN screens.

Click the **Apply** button in the third part to save your settings.

Figure 14 Apply your Wi-Fi settings

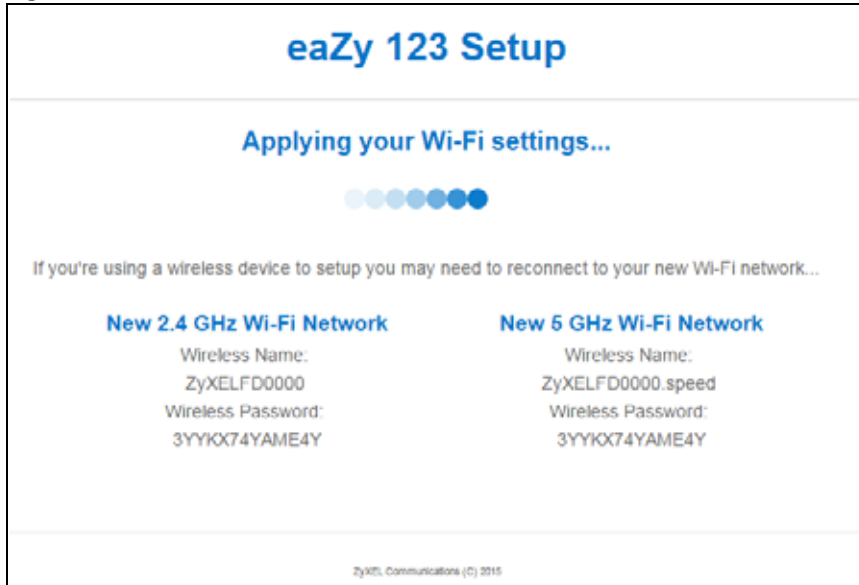

Congratulations! Open a web browser, such as Internet Explorer, to visit your favorite website.

Note: If you cannot access the Internet when your computer is connected to one of the EMG3435-Q20A's LAN ports, check your connections. Then turn the EMG3435-Q20A off, wait for a few seconds then turn it back on. If that does not work, log in to the web configurator again and check you have typed all information correctly. See the User's Guide for more suggestions.

Figure 15 Congratulations



You can click the **myZyXELcloud** button to go to <https://mycloud.zyxel.com>, where you can create an account and register your EMG3435-Q20A. At the time of writing, you can have free DDNS service to get



a domain name mapped to the EMG3435-Q20A's dynamic IP address. With DDNS, you can use the domain name to remotely access the EMG3435-Q20A's Web Configurator through the Internet.

You have successfully set up your EMG3435-Q20A to operate on your network and access the Internet.

# CHAPTER 4

## EMG3435-Q20A Modes

### 4.1 Overview

This chapter introduces the different modes available on your EMG3435-Q20A. First, the term “mode” refers to two things in this User’s Guide.

- **Web Configurator mode.** This refers to the Web Configurator interface you want to use for editing EMG3435-Q20A features.
- **Device mode.** This is the operating mode of your EMG3435-Q20A, or simply how the EMG3435-Q20A is being used in the network.

#### 4.1.1 Web Configurator Modes

This refers to the configuration interface of the Web Configurator, which has two modes:

- **Easy:** The Web Configurator shows this mode by default. Refer to [Chapter 5 on page 27](#) for more information on the screens in this mode. This interface may be sufficient for users who just want to use the device.
- **Expert:** Advanced users can change to this mode to customize all the functions of the EMG3435-Q20A. Click > **Expert Mode** after logging into the Web Configurator. The User’s Guide [Chapter 9 on page 59](#) through [Chapter 15 on page 158](#) discusses the screens in this mode.

#### 4.1.2 Device Modes

This refers to the operating mode of the EMG3435-Q20A, which can act as a:

- **Router:** This is the default device mode of the EMG3435-Q20A. Use this mode to connect the local network to another network, like the Internet. Go to [Section 6.2 on page 35](#) to view the **Status** screen in this mode.
- **Access Point:** Use this mode if you want to extend your network by allowing network devices to connect to the EMG3435-Q20A wirelessly. Go to [Section 7.4 on page 43](#) to view the **Status** screen in this mode.

For more information on these modes and to change the mode of your EMG3435-Q20A, refer to [Chapter 15 on page 158](#).

The menu for changing device modes is available in **Expert Mode** only.

Note: Choose your device mode carefully to avoid having to change it later.

When changing to another mode, the IP address of the EMG3435-Q20A changes. The running applications and services of the network devices connected to the EMG3435-Q20A can be interrupted.

# CHAPTER 5

## Easy Mode

### 5.1 Overview

The Web Configurator is set to **Easy Mode** by default. You can configure several key features of the EMG3435-Q20A in this mode. This mode is useful to users who are not fully familiar with some features that are usually intended for network administrators.

When you log in to the Web Configurator, the following screen opens.

Figure 16 Easy Mode

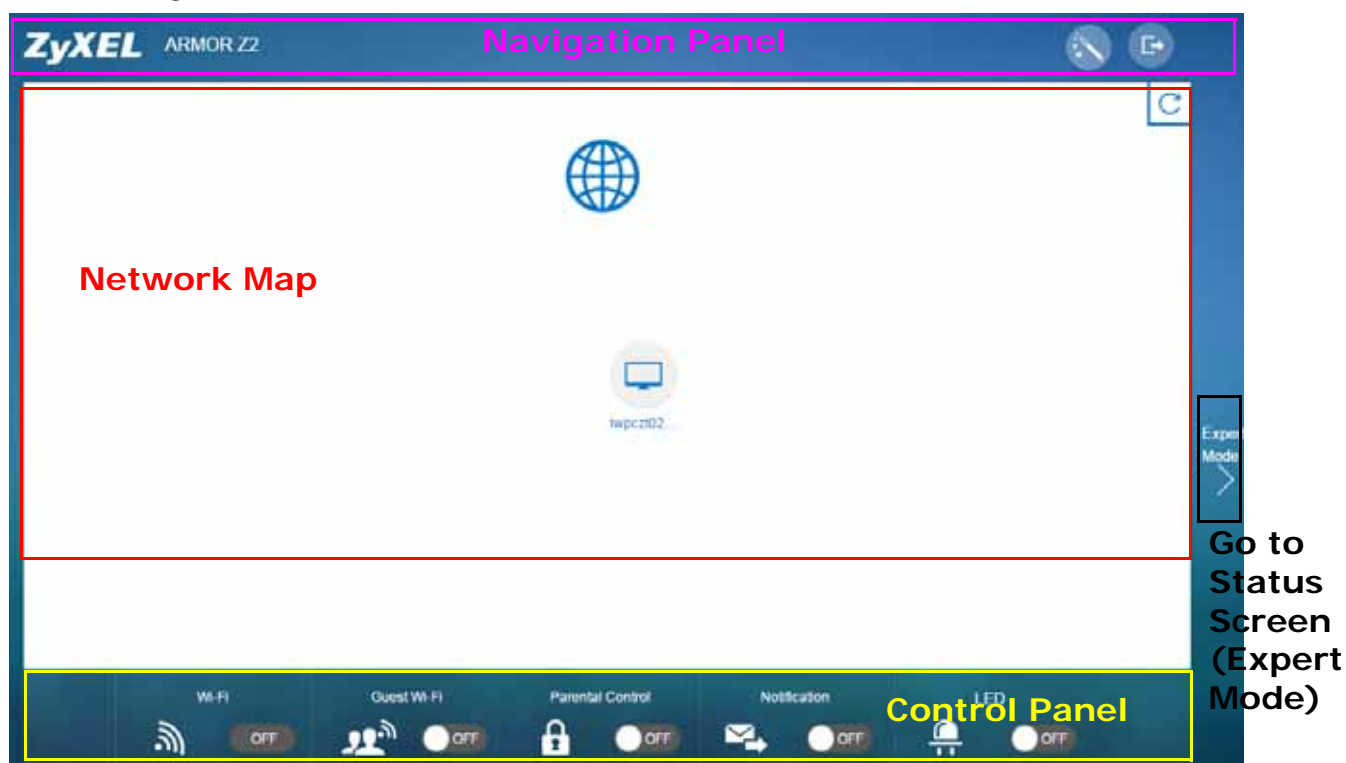

### 5.2 What You Can Do

You can do the following in this mode:

- Use this **Navigation Panel** to open the eaZy123 wizard or log out the EMG3435-Q20A ([Section 5.4 on page 28](#)).
- Use the **Network Map** screen to check if your EMG3435-Q20A is connected to the Internet ([Section 5.5 on page 29](#)).

- Use the **Control Panel** to configure and enable EMG3435-Q20A features, including guest Wi-Fi, wireless security, parental control and so on ([Section 5.6 on page 30](#)).

## 5.3 What You Need to Know

Between the different device modes, the **Control Panel** ([Section 5.6 on page 30](#)) changes depending on which features are applicable to the mode:

- **Router Mode:** All **Control Panel** features are available.
- **Access Point Mode:** **Parental Control** and **Notification** are not available.

## 5.4 Navigation Panel



Use this navigation panel to opt out of the **Easy** mode.

**Figure 17** Easy Mode: Navigation Panel



The following table describes the labels in this screen.

**Table 7** Easy Mode: Navigation Panel

ITEM	DESCRIPTION
 Firmware Notification	Click this icon to open a screen where you can click <b>Check here</b> to redirect your screen to the firmware upgrade page.  This icon only displays when new firmware is released.
 Wizard	Click this icon to open the eaZy123 wizard for the EMG3435-Q20A.
 Logout	Click this to end the Web Configurator session.

**Figure 18** Easy Mode: Navigation Panel: Firmware Notification

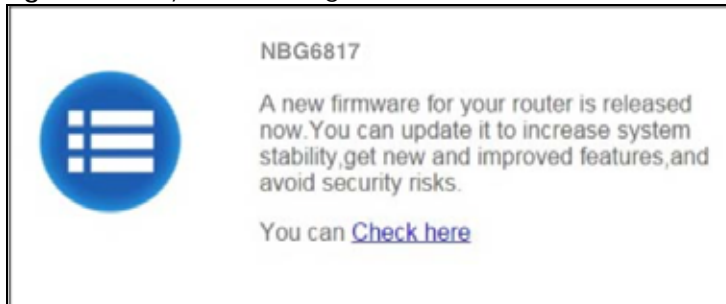

## 5.5 Network Map

When you log into the Web Configurator, the Network Map is shown as follows.

**Figure 19** Easy Mode: Network Map

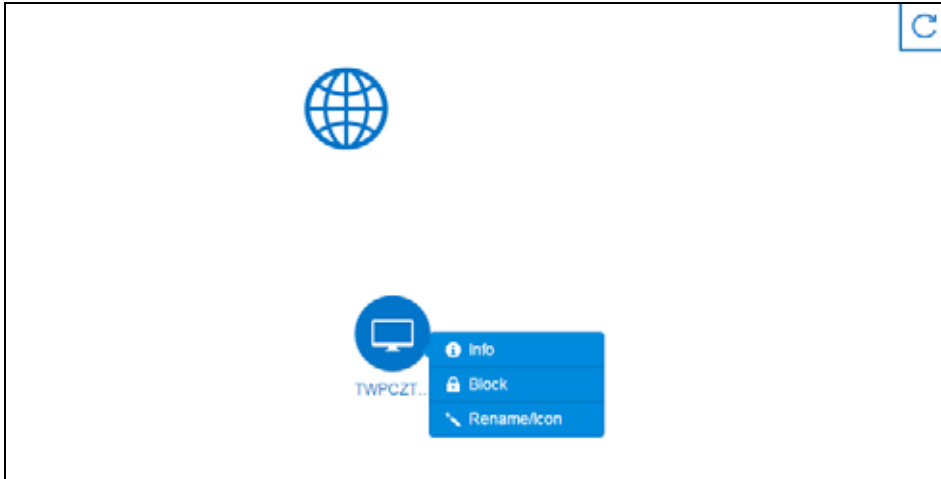

This screen displays whether the EMG3435-Q20A connects to the Internet. It also shows the devices connected to the EMG3435-Q20A, including those connecting wirelessly. Click the **Refresh** button to refresh the network map.

The following table describes the icons in this screen.

**Table 8** Easy Mode: Network Map





ITEM	DESCRIPTION
	This icon shows the EMG3435-Q20A's connection status. This icon is grayed out if the user is unable to access the Internet.
	Click this button to refresh the EMG3435-Q20A's connection status and the network map.
 Info	Click this to view the device's information that is currently connected to the EMG3435-Q20A.
 Block	Click this to block the device from accessing the Internet through the EMG3435-Q20A.
 Rename / Icon	Click this to rename the device or change the device's icon.

Figure 20 Easy Mode: Network Map: Info



Figure 21 Easy Mode: Network Map: Rename / Icon

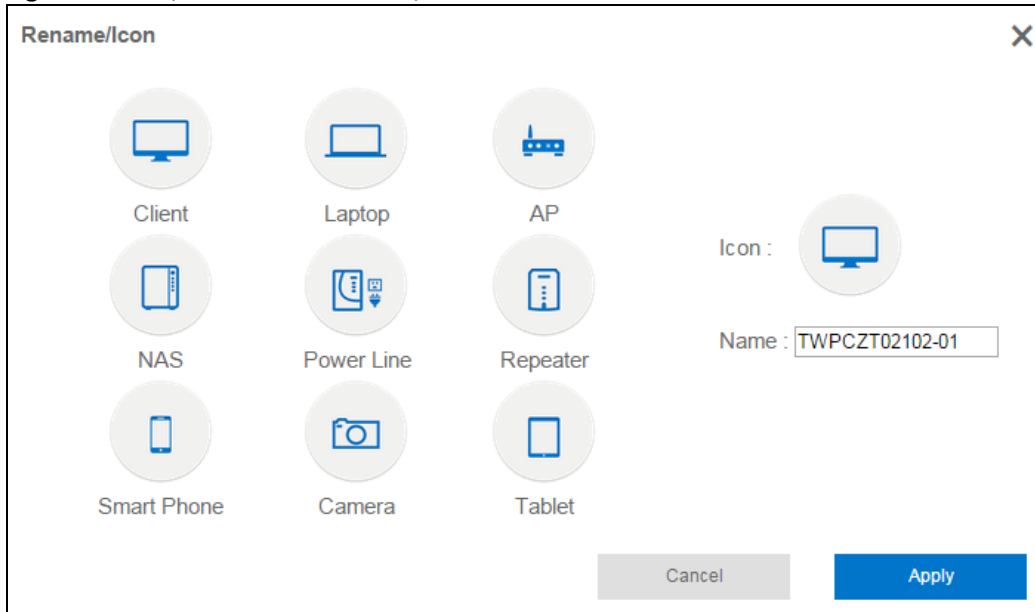

Click **Apply** to save your changes back to the EMG3435-Q20A. Click **Cancel** to reload the previous configuration for this screen.

## 5.6 Control Panel

The features configurable in **Easy Mode** are shown in the **Control Panel**.

Figure 22 Easy Mode: Control Panel

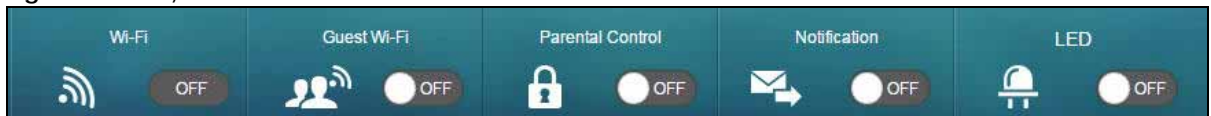

Switch **ON** to enable the feature. Otherwise, switch **OFF**. If the feature is turned on, the green light flashes. If it is turned off, the blue light flashes.

Additionally, click the feature to open a screen where you can edit its settings.

The following table describes the labels in this screen.

Table 9 Easy Mode: Control Panel

ITEM	DESCRIPTION
Wi-Fi	Click this to configure wireless radio, SSID, security mode and wireless password for the EMG3435-Q20A's default Wi-Fi network.  Refer to <a href="#">Section 5.6.1 on page 31</a> to see this screen.
Guest Wi-Fi	Click this to configure wireless and wireless security settings for the guest Wi-Fi network.
Parental Control	Switch <b>ON</b> to enable parental control, and click this to view the parental control rules. Otherwise, switch <b>OFF</b> .  Refer to <a href="#">Section 5.6.3 on page 33</a> to see this screen.
Notification	Switch <b>ON</b> to have the EMG3435-Q20A send e-mail notifications when the user(s) is connected to the EMG3435-Q20A for Internet access during the specified time periods. Otherwise, switch <b>OFF</b> .  Refer to <a href="#">Section 5.6.4 on page 34</a> to see this screen.
LED	Switch <b>ON</b> to have the EMG3435-Q20A's LEDs (lights) stay lit/blinking. Otherwise, switch <b>OFF</b> .

## 5.6.1 Wi-Fi

Use this screen to configure security for the EMG3435-Q20A's default wireless LAN. You can enter the SSID and select the wireless security mode in the following screen. See [Chapter 14 on page 140](#) for how to configure wireless network.

Note: You can enable the wireless function of your EMG3435-Q20A by first turning on the **WIFI** switch in the rear panel.

Figure 23 Easy Mode: Wi-Fi

Wi-Fi

Data transmitted wirelessly without encryption is not secure. Protect your network by enabling wireless security and choosing a password that is hard to guess.

Wireless Radio :

Network Name (SSID) :

Security Mode :

Password :

Verify Password :

Cancel Apply

The following table describes the labels in this screen.

Table 10 Easy Mode: Wi-Fi

LABEL	DESCRIPTION
Wireless Radio	Choose whether you want to apply the wireless security to <b>2.4G Hz</b> , <b>5G Hz</b> or <b>Both</b> wireless radios.
Network Name (SSID)	(Service Set IDentity) The SSID identifies the Service Set with which a wireless station is associated. Wireless stations associating to the access point (AP) must have the same SSID. Enter a descriptive name (up to 32 keyboard characters) for the wireless LAN.
Security Mode	Select <b>WPA2-PSK</b> to enable data encryption. Or Select <b>No Security</b> to allow wireless clients to communicate with the access points without any data encryption.
Password	This field appears when you choose wither <b>WPA2-PSK</b> as the security mode. Type a pre-shared key from 8 to 63 case-sensitive keyboard characters.
Verify Password	Type the password again to confirm.
Cancel	Click <b>Cancel</b> to reload the previous configuration for this screen.
Apply	Click <b>Apply</b> to save your changes back to the EMG3435-Q20A.

## 5.6.2 Guest Wi-Fi

This screen allows you to configure guest wireless network settings on the EMG3435-Q20A. Users connected to the guest wireless network can access the Internet via the EMG3435-Q20A, but not other networks connected to the EMG3435-Q20A. See [Chapter 11 on page 93](#) for how to enable and set up the guest wireless network.

Figure 24 Easy Mode: Guest Wi-Fi

**Guest Wi-Fi** X

You can setup a Guest Wi-Fi network to share your Internet access with your guests. Other LAN devices and services in your Host network will not be accessed by the Guest clients under this Guest network.

Wireless Radio : 2.4G Hz ▾

Network Name (SSID) : ZyXEL\_SSID3

Security Mode : WPA2-PSK ▾

Password :

Verify Password :

Cancel Apply



The following table describes the labels in this screen.

Table 11 Easy Mode: Guest Wi-Fi

LABEL	DESCRIPTION
Wireless Radio	Choose whether you want to apply the wireless settings to the <b>2.4G Hz</b> or <b>5G Hz</b> wireless radio.
Network Name (SSID)	The SSID (Service Set IDentity) identifies the Service Set with which a wireless client is associated. Enter a descriptive name (up to 32 printable characters found on a typical English language keyboard) for the guest wireless network.
Security Mode	Select <b>WPA2-PSK</b> to enable data encryption. Or select <b>No Security</b> to allow wireless clients to communicate with the EMG3435-Q20A without any data encryption.
Password	This field appears when you choose <b>WPA2-PSK</b> as the security mode. Type a pre-shared key from 8 to 63 case-sensitive keyboard characters.
Verify Password	Type the password again to confirm.
Cancel	Click <b>Cancel</b> to reload the previous configuration for this screen.
Apply	Click <b>Apply</b> to save your changes back to the EMG3435-Q20A.

### 5.6.3 Parental Control

Use this screen to view the parental control rules configured on the EMG3435-Q20A. See [Section 13.2 on page 119](#) for how to enable and configure parental control rules.

Figure 25 Easy Mode: Parental Control

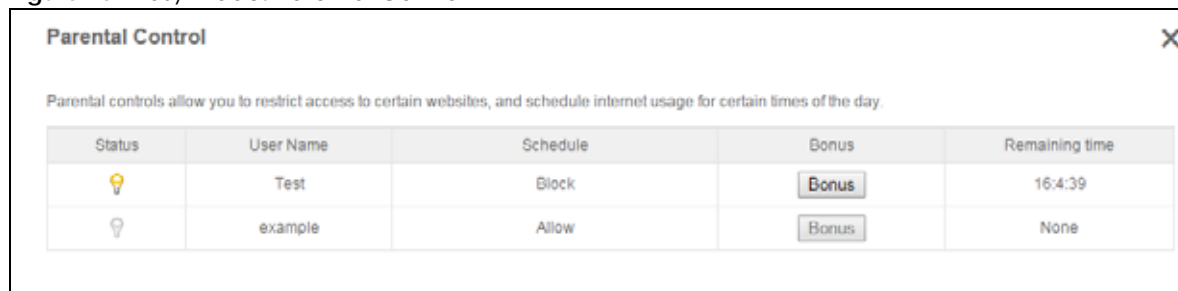

The screenshot shows the 'Parental Control' interface. At the top, it says 'Parental controls allow you to restrict access to certain websites, and schedule internet usage for certain times of the day.' Below this is a table with five columns: Status, User Name, Schedule, Bonus, and Remaining time. There are two rows of data. The first row has a yellow lightbulb icon for Status, 'Test' for User Name, 'Block' for Schedule, a 'Bonus' button for Bonus, and '16:4:39' for Remaining time. The second row has a gray lightbulb icon for Status, 'example' for User Name, 'Allow' for Schedule, a 'Bonus' button for Bonus, and 'None' for Remaining time.

Status	User Name	Schedule	Bonus	Remaining time
	Test	Block	<input type="button" value="Bonus"/>	16:4:39
	example	Allow	<input type="button" value="Bonus"/>	None

The following table describes the labels in this screen.

Table 12 Easy Mode: Parental Control

LABEL	DESCRIPTION
Status	This indicates whether the rule is active or not. A yellow bulb signifies that this rule is active. A gray bulb signifies that this rule is not active.
User Name	This shows the name of the user to which this rule applies.
Schedule	This shows whether the user is allowed to access the Internet ( <b>Allow</b> ) or not ( <b>Block</b> ).
Bonus	If the user is currently not permitted to access the Internet, you can click the <b>Bonus</b> to allow access for a specified period of time. A screen then displays allowing you to set how long (in minutes) the user is allowed to access the Internet. This button is grayed out if the user is now able to access the Internet.
Remaining time	This field displays the amount of Internet access time that remains for each user before the EMG3435-Q20A blocks the user from accessing the Internet. <b>None</b> means there is no extra Internet access time.

## 5.6.4 Notification

Use this screen to view the e-mail notification rules configured on the EMG3435-Q20A. See [Section 13.2.2 on page 122](#) for how to configure e-mail notification rules and e-mail settings.

**Figure 26** Easy Mode: Notification

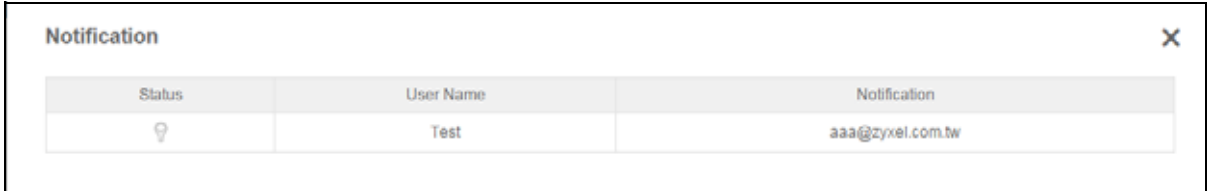

The following table describes the labels in this screen.

**Table 13** Easy Mode: Notification

LABEL	DESCRIPTION
Notification	
Status	This indicates whether the rule is active or not. A yellow bulb signifies that this rule is active. A gray bulb signifies that this rule is not active.
User Name	This shows the name of the user to which this rule applies.
Notification	This shows the e-mail address to which the notification is sent.

## 5.6.5 LED

Switch **ON** to turn on the LEDs (lights) on the EMG3435-Q20A. Otherwise, switch **OFF**.

# CHAPTER 6

## Router Mode

### 6.1 Overview

The EMG3435-Q20A is set to router mode by default. Routers are used to connect the local network to another network (for example, the Internet). In the figure below, the EMG3435-Q20A connects the local network (LAN1 ~ LAN4) to the Internet.

Figure 27 EMG3435-Q20A Network

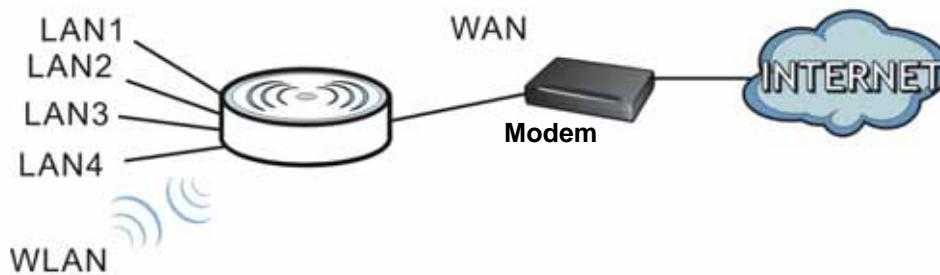

Note: After clicking **Login**, the **Easy Mode** appears. Refer to [Chapter 5 on page 27](#) for the **Easy Mode** screens. Change to **Expert Mode** to see the screens described in the sections following this.

### 6.2 Router Mode Status Screen

Click **Expert Mode** > **Status** > **System Status** to open the status screen.

Figure 28 Expert Mode: Status &gt; System Status: Router Mode

The screenshot shows the 'System Status' page in Expert Mode, Router Mode. It is divided into four main sections:

- Device Information:** A table with 'Item' and 'Data' columns. It lists Host Name (NBO6817), Model Number (NBO6817), Firmware Version (V1.00(ABCS.0)b5), Sys OP Mode (Router Mode), WAN Information (MAC Address: EA:5B:64:7F:93:8B, IP Address: 172.21.56.92, IP Subnet Mask: 255.255.255.0, Default Gateway: 172.21.56.254, IPv6 Address), LAN Information (MAC Address: BE:E5:CC:BE:DF:C7, IP Address: 192.168.1.1, IP Subnet Mask: 255.255.255.0, DHCP: Server, IPv6 Address), WLAN 2.4G Information (WLAN OP Mode: Access Point Mode, MAC Address: 11:03:7F:BA:DB:04, SSID: ZyXELBADB06, Channel, Security: WPA2-PSK), WLAN 5G Information (WLAN OP Mode: Access Point Mode, MAC Address: 11:03:7F:BA:DB:05, SSID: ZyXELBADB06.speed, Channel, Security: WPA2-PSK), and Firewall (Enable).
- System Status:** A table with 'Item' and 'Data' columns. It shows System Up Time (0day 0hr18min 52sec), Current Date/Time (2016-03-11/07:32:40), System Resource, - CPU Usage (9% with a progress bar), and - Memory Usage (36% with a progress bar).
- Interface Status:** A table with 'Interface', 'Status', and 'Rate' columns. It lists WAN (UP, 100M), LAN1 (Down), LAN2 (Down), LAN3 (UP, 1000M), LAN4 (Down), WLAN 2.4G (Down, N/A), and WLAN 5G (Down, N/A).
- Printer Information:** A table with 'Item' and 'Data' columns. It shows Printer Name (None).

The following table describes the labels shown in the **Status** screen.

Table 14 Expert Mode: Status &gt; System Status: Router Mode

LABEL	DESCRIPTION
Device Information	
Item	This column shows the type of data the EMG3435-Q20A is recording.
Data	This column shows the actual data recorded by the EMG3435-Q20A.
Host Name	This is the <b>System Name</b> you enter in the <b>Maintenance &gt; General</b> screen. It is for identification purposes.
Model Number	This is the model name of your device.
Firmware Version	This is the firmware version.
Sys OP Mode	This is the device mode ( <a href="#">Section 4.1.2 on page 26</a> ) to which the EMG3435-Q20A is set - <b>Router Mode</b> .
WAN Information	
MAC Address	This shows the WAN Ethernet adapter MAC Address of your device.
IP Address	This shows the WAN port's IP address.
IP Subnet Mask	This shows the WAN port's subnet mask.
Default Gateway	This shows the WAN port's gateway IP address.
IPv6 Address	This shows the IPv6 address of the EMG3435-Q20A on the WAN.
LAN Information	

Table 14 Expert Mode: Status &gt; System Status: Router Mode (continued)

LABEL	DESCRIPTION
MAC Address	This shows the LAN Ethernet adapter MAC Address of your device.
IP Address	This shows the LAN port's IP address.
IP Subnet Mask	This shows the LAN port's subnet mask.
DHCP	This shows the LAN port's DHCP role - <b>Server</b> or <b>Disable</b> .
IPv6 Address	This shows the IPv6 address of the EMG3435-Q20A on the LAN.
WLAN 2.4G Information	
WLAN OP Mode	This is the device mode ( <a href="#">Section 4.1.2 on page 26</a> ) to which the EMG3435-Q20A's wireless LAN is set - <b>Access Point Mode</b> .
MAC Address	This shows the 2.4GHz wireless adapter MAC Address of your device.
SSID	This shows a descriptive name used to identify the EMG3435-Q20A in the 2.4GHz wireless LAN.
Channel	This shows the channel number which you select manually.
Security	This shows the level of wireless security the EMG3435-Q20A is using.
WLAN 5G Information	
WLAN OP Mode	This is the device mode ( <a href="#">Section 4.1.2 on page 26</a> ) to which the EMG3435-Q20A's wireless LAN is set - <b>Access Point Mode</b> .
MAC Address	This shows the 5GHz wireless adapter MAC Address of your device.
SSID	This shows a descriptive name used to identify the EMG3435-Q20A in the 5GHz wireless LAN.
Channel	This shows the channel number which you select manually.
Security	This shows the level of wireless security the EMG3435-Q20A is using.
Firewall	This shows whether the firewall is enabled or not.
System Status	
System Up Time	This is the total time the EMG3435-Q20A has been on.
Current Date/Time	This field displays your EMG3435-Q20A's present date and time.
System Resource	
- CPU Usage	This displays what percentage of the EMG3435-Q20A's processing ability is currently used. When this percentage is close to 100%, the EMG3435-Q20A is running at full load, and the throughput is not going to improve anymore. If you want some applications to have more throughput, you should turn off other applications (for example, using bandwidth management.)
- Memory Usage	This shows what percentage of the heap memory the EMG3435-Q20A is using.
Interface Status	
Interface	This displays the EMG3435-Q20A port types. The port types are: <b>WAN</b> , <b>LAN</b> and <b>WLAN</b> .
Status	For the LAN and WAN ports, this field displays <b>Down</b> (line is down) or <b>Up</b> (line is up or connected). For the 2.4GHz/5GHz WLAN, it displays <b>Up</b> when the 2.4GHz/5GHz WLAN is enabled or <b>Down</b> when the 2.4G/5G WLAN is disabled.
Rate	For the LAN ports, this displays the port speed and duplex setting or is left blank when the line is disconnected. For the WAN port, it displays the port speed and duplex setting if you're using Ethernet encapsulation. This field displays <b>N/A</b> when the line is disconnected. For the 2.4GHz/5GHz WLAN, it displays the maximum transmission rate when the 2.4GHz/5GHz WLAN is enabled and <b>N/A</b> when the WLAN is disabled.

Table 14 Expert Mode: Status > System Status: Router Mode (continued)

LABEL	DESCRIPTION
Printer Information	
Printer Name	The EMG3435-Q20A can act as a print server and allows you to share a USB printer on your LAN. This displays the name of the printer connected to the EMG3435-Q20A's USB port.  Note: You need to manually install the printer driver in your computer and add the printer to your printer list.

## 6.2.1 Navigation Panel

Use the sub-menus on the navigation panel to configure EMG3435-Q20A features.

Figure 29 Expert Mode: Navigation Panel: Router Mode

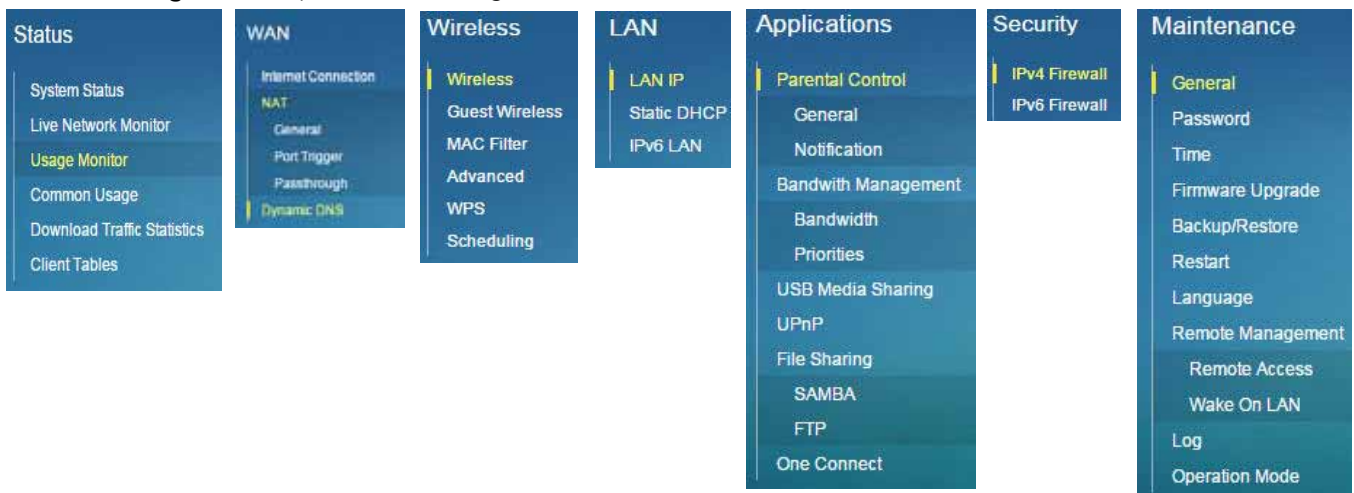

The following table describes the sub-menus.

Table 15 Expert Mode: Navigation Panel: Router Mode

LINK	TAB	FUNCTION
<b>Status</b>		
System Status		This screen shows the EMG3435-Q20A's general device, system and interface status information. Use this screen to access the wizard, and summary statistics tables.
Live Network Monitor		This screen shows transmission data rates between the EMG3435-Q20A and the Internet or connected devices.
Usage Monitor		This screen shows transmission data and bandwidth usage between the EMG3435-Q20A and the Internet or connected devices.
Common Usage		This screen shows the top five traffic flows transmitting from/to the selected LAN device(s).
Download Traffic Statistics		This screen shows the type and percentage of most download traffic.
Client Tables		Use this screen to view online clients information.
<b>WAN</b>		
Internet Connection		This screen allows you to configure ISP parameters, WAN IP address assignment, DNS servers and the WAN MAC address.

Table 15 Expert Mode: Navigation Panel: Router Mode (continued)

LINK	TAB	FUNCTION
NAT	General	Use this screen to enable NAT.  Use this screen to configure servers behind the EMG3435-Q20A and forward incoming service requests to the server(s) on your local network.
	Port Trigger	Use this screen to change your EMG3435-Q20A's port triggering settings.
	Passthrough	Use this screen to enable ALGs (Application Layer Gateway) and VPN pass-through settings.
Dynamic DNS		Use this screen to set up dynamic DNS.
<b>Wireless</b>		
Wireless		Use this screen to enable the wireless LAN and configure wireless LAN and wireless security settings.
Guest Wireless		Use this screen to configure multiple BSSs on the EMG3435-Q20A.
MAC Filter		Use the MAC filter screen to configure the EMG3435-Q20A to block access to devices or block the devices from accessing the EMG3435-Q20A.
Advanced		This screen allows you to configure advanced wireless settings.
WPS		Use this screen to configure WPS.
Scheduling		Use this screen to schedule the times the Wireless LAN is enabled.
<b>LAN</b>		
LAN IP		Use this screen to configure LAN IP address and subnet mask.  Use this screen to configure the IPv6 address for the EMG3435-Q20A on the LAN.  Use this screen to enable the EMG3435-Q20A's DHCP server.
Static DHCP		This screen allows you to assign IP addresses on the LAN to specific individual computers based on their MAC addresses.
IPv6 LAN		Use this screen to configure the IPv6 address for your EMG3435-Q20A on the LAN.
<b>Applications</b>		
Parental Control	General	Use this screen to enable parental control, set parental controls rules/schedules and block web sites containing certain keywords in the URL.
	Notification	Use this screen to send e-mail notifications, configure e-mail notification rules and e-mail settings.
Bandwidth Management	Bandwidth	Use this screen to enable StreamBoost. Use this screen to configure the maximum allowable bandwidth and enable automatic update.
	Priorities	Use this screen to change the priority of the connected devices.
USB Media Sharing		Use this screen to have the EMG3435-Q20A function as a DLNA-compliant media server, that lets DLNA-compliant media clients play video, audio, and photo content files stored on the connected USB storage device.
UPnP		Use this screen to enable UPnP on the EMG3435-Q20A.
File Sharing	SAMBA	Use this screen to enable file sharing through the EMG3435-Q20A.
	FTP	Use this screen to have the EMG3435-Q20A act as a FTP server.
One Connect		Use this screen to enable or disable Wi-Fi auto-configuration.
<b>Security</b>		
IPv4 Firewall		Use this screen to configure IPv4 firewall rules.
IPv6 Firewall		Use this screen to configure IPv6 firewall rules.
<b>Maintenance</b>		

Table 15 Expert Mode: Navigation Panel: Router Mode (continued)

LINK	TAB	FUNCTION
General		Use this screen to view and change administrative settings such as system and domain names.
Password		Use this screen to change the password of your EMG3435-Q20A.
Time		Use this screen to change your EMG3435-Q20A's time and date.
Firmware Upgrade		Use this screen to upload firmware to your EMG3435-Q20A.
Backup/Restore		Use this screen to backup and restore the configuration or reset the factory defaults to your EMG3435-Q20A.
Restart		This screen allows you to reboot the EMG3435-Q20A without turning the power off.
Language		This screen allows you to select the language you prefer.
Remote Management	Remote Access	Use this screen to configure through which interface(s) and from which IP address(es) users can use Telnet and HTTP/HTTPS to manage the EMG3435-Q20A.
	Wake On LAN	Use this screen to enable Wake on LAN to remotely turn on a device on the local network.
Log		Use this screen to view the list of activities recorded by your EMG3435-Q20A.
Operation Mode		This screen allows you to select whether your device acts as a router, or an access point.



# CHAPTER 7

## Access Point Mode

### 7.1 Overview

Use your EMG3435-Q20A as an access point (AP) if you already have a router or gateway on your network. In this mode your EMG3435-Q20A bridges a wired network (LAN) and wireless LAN (WLAN) in the same subnet. See the figure below for an example.

Figure 30 Wireless Internet Access in Access Point Mode

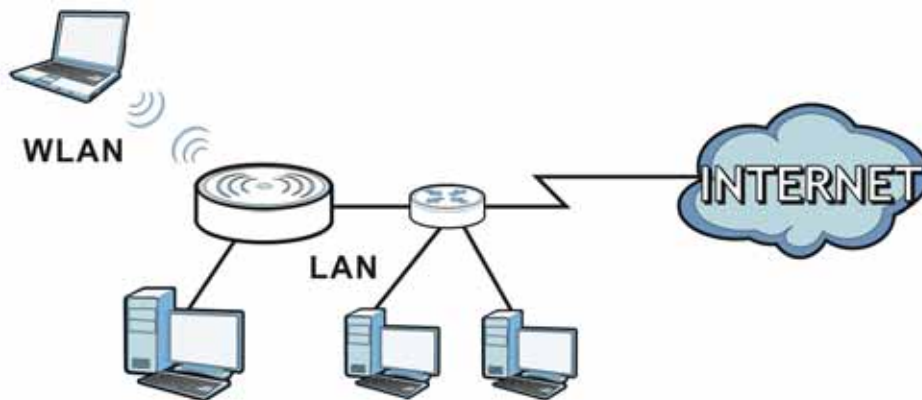

Many screens that are available in **Router Mode** are not available in **Access Point Mode**, such as bandwidth management and firewall.

### 7.2 What You Can Do

- Use the **Status** screen to view read-only information about your EMG3435-Q20A ([Section 7.4 on page 43](#)).
- Use the **LAN** screen to set the IP address for your EMG3435-Q20A acting as an access point ([Section 7.5 on page 45](#)).

### 7.3 What You Need to Know

See [Chapter 8 on page 48](#) for a tutorial on setting up a network with the EMG3435-Q20A as an access point.

### 7.3.1 Setting your EMG3435-Q20A to AP Mode

- 1 Log into the Web Configurator if you haven't already. See the Quick start Guide for instructions on how to do this.
- 2 To use your EMG3435-Q20A as an access point, go to **Expert Mode > Maintenance > Operation Mode** and select **Access Point Mode**.

**Figure 31** Changing to Access Point mode

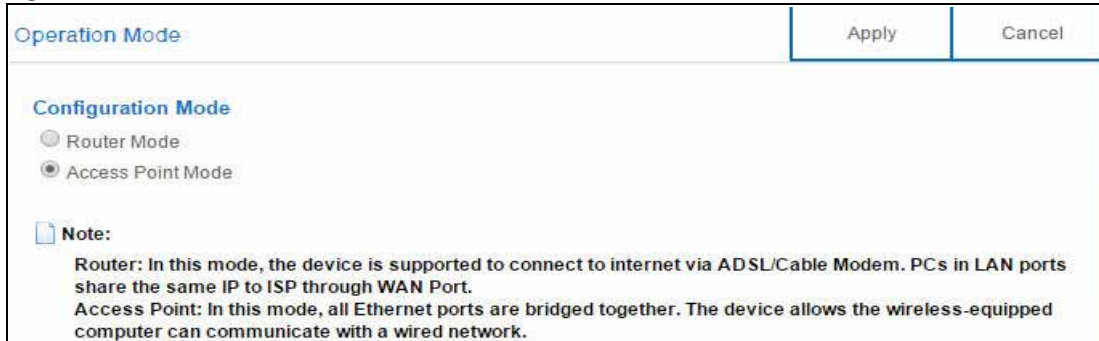

Note: You have to log in to the Web Configurator again when you change modes. As soon as you do, your EMG3435-Q20A is already in Access Point mode.

- 3 When you select **Access Point Mode**, the following pop-up message window appears.

**Figure 32** Pop up for Access Point mode

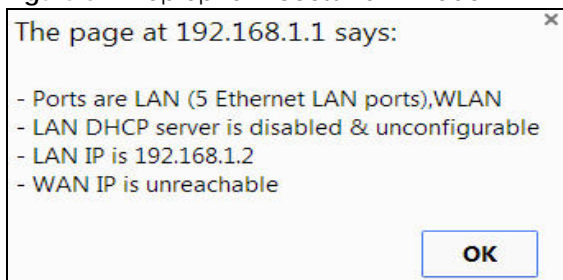

Click **OK**. Then click **Apply**. The Web Configurator refreshes once the change to Access Point mode is successful.

### 7.3.2 Accessing the Web Configurator in Access Point Mode

Log in to the Web Configurator in Access Point mode, do the following:

- 1 Connect your computer to the LAN port of the EMG3435-Q20A.
- 2 The default IP address of the EMG3435-Q20A is "192.168.1.2". In this case, your computer must have an IP address in the range between "192.168.1.3" and "192.168.1.254".
- 3 Click **Start > Run** on your computer in Windows. Type "cmd" in the dialog box. Enter "ipconfig" to show your computer's IP address. If your computer's IP address is not in the correct range then see [Appendix B on page 173](#) for information on changing your computer's IP address.

- After you've set your computer's IP address, open a web browser such as Internet Explorer and type "192.168.1.2" as the web address in your web browser.

Note: After clicking **Login**, the **Easy Mode** appears. Refer to [Section on page 27](#) for the **Easy Mode** screens. Change to **Expert Mode** to see the screens described in the sections following this.

### 7.3.3 Configuring your WLAN and Maintenance Settings

The configuration of wireless and maintenance settings in **Access Point Mode** is the same as for **Router Mode**.

- See [Chapter 11 on page 93](#) for information on the configuring your wireless network.
- See [Chapter 15 on page 146](#) for information on configuring your maintenance settings.

## 7.4 AP Mode Status Screen

Click **Expert Mode > Status** to open the **Status** screen.

**Figure 33** Expert Mode: Status > System Status: Access Point Mode

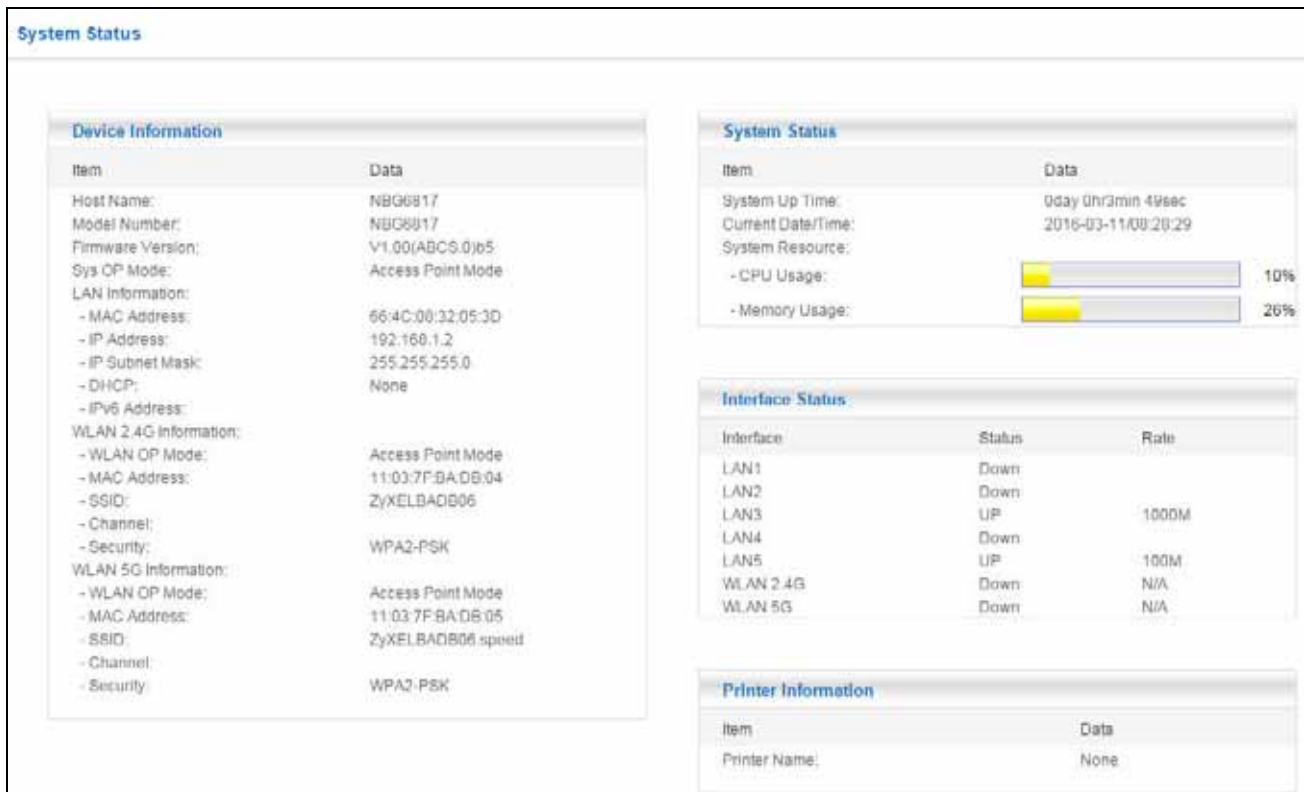

The following table describes the labels shown in the **Status** screen.

Table 16 Expert Mode: Status &gt; System Status: Access Point Mode

LABEL	DESCRIPTION
Device Information	
Host Name	This is the <b>System Name</b> you enter in the <b>Maintenance &gt; General</b> screen. It is for identification purposes.
Model Number	This is the model name of your device.
Firmware Version	This is the firmware version.
Sys OP Mode	This is the device mode ( <a href="#">Section 4.1.2 on page 26</a> ) to which the EMG3435-Q20A is set - <b>AP Mode</b> .
LAN Information	
MAC Address	This shows the LAN Ethernet adapter MAC Address of your device.
IP Address	This shows the LAN port's IP address.
IP Subnet Mask	This shows the LAN port's subnet mask.
DHCP	This shows the LAN port's DHCP role - <b>Client</b> or <b>None</b> .
IPv6 Address	This shows the IPv6 address of the EMG3435-Q20A on the LAN.
WLAN 2.4G Information	
WLAN OP Mode	This is the device mode ( <a href="#">Section 4.1.2 on page 26</a> ) to which the EMG3435-Q20A's wireless LAN is set - <b>Access Point Mode</b> .
MAC Address	This shows the 2.4GHz wireless adapter MAC Address of your device.
SSID	This shows a descriptive name used to identify the EMG3435-Q20A in the 2.4GHz wireless LAN.
Channel	This shows the channel number which you select manually.
Security	This shows the level of wireless security the EMG3435-Q20A is using.
WLAN 5G Information	
WLAN OP Mode	This is the device mode ( <a href="#">Section 4.1.2 on page 26</a> ) to which the EMG3435-Q20A's wireless LAN is set - <b>Access Point Mode</b> .
MAC Address	This shows the 5GHz wireless adapter MAC Address of your device.
SSID	This shows a descriptive name used to identify the EMG3435-Q20A in the 5GHz wireless LAN.
Channel	This shows the channel number which you select manually.
Security	This shows the level of wireless security the EMG3435-Q20A is using.
System Status	
Item	This column shows the type of data the EMG3435-Q20A is recording.
Data	This column shows the actual data recorded by the EMG3435-Q20A.
System Up Time	This is the total time the EMG3435-Q20A has been on.
Current Date/Time	This field displays your EMG3435-Q20A's present date and time.
System Resource	
- CPU Usage	This displays what percentage of the EMG3435-Q20A's processing ability is currently used. When this percentage is close to 100%, the EMG3435-Q20A is running at full load, and the throughput is not going to improve anymore. If you want some applications to have more throughput, you should turn off other applications.
- Memory Usage	This shows what percentage of the heap memory the EMG3435-Q20A is using.
Interface Status	
Interface	This displays the EMG3435-Q20A port types. The port types are: <b>LAN</b> and <b>WLAN</b> .
Status	For the LAN ports, this field displays <b>Down</b> (line is down) or <b>Up</b> (line is up or connected). For the 2.4GHz/5GHz WLAN, it displays <b>Up</b> when the 2.4GHz/5GHz WLAN is enabled or <b>Down</b> when the 2.4G/5G WLAN is disabled.

Table 16 Expert Mode: Status &gt; System Status: Access Point Mode (continued)

LABEL	DESCRIPTION
Rate	For the LAN ports, this displays the port speed and duplex setting or is left blank when the line is disconnected.  For the 2.4GHz/5GHz WLAN, it displays the maximum transmission rate when the 2.4GHz/5GHz WLAN is enabled and <b>N/A</b> when the WLAN is disabled.
Printer Information	
Printer Name	The EMG3435-Q20A can act as a print server and allows you to share a USB printer on your LAN. This displays the name of the printer connected to the EMG3435-Q20A's USB port.  Note: You need to manually install the printer driver in your computer and add the printer to your printer list.

## 7.4.1 Navigation Panel

Use the menu in the navigation panel to configure EMG3435-Q20A features in **Access Point Mode**.

**Figure 34** Expert Mode: Navigation Panel: Access Point Mode



Refer to [Table 15 on page 38](#) for descriptions of the labels shown in the navigation panel.

## 7.5 LAN Screen

Use this section to configure your LAN settings while in **Access Point Mode**.

Click **Expert Mode > LAN** to see the screen below.

Note: If you change the IP address of the EMG3435-Q20A in the screen below, you will need to log into the EMG3435-Q20A again using the new IP address.

Figure 35 LAN &gt; LAN IP

The table below describes the labels in the screen.

Table 17 LAN &gt; LAN IP

LABEL	DESCRIPTION
IP Address	
Obtain an IP Address Automatically	<p>When you enable this, the EMG3435-Q20A gets its IP address from the network's DHCP server (for example, your ISP). Users connected to the EMG3435-Q20A can now access the network (i.e., the Internet if the IP address is given by the ISP).</p> <p>The Web Configurator may no longer be accessible unless you know the IP address assigned by the DHCP server to the EMG3435-Q20A. You need to reset the EMG3435-Q20A to be able to access the Web Configurator again (see <a href="#">Section 15.7 on page 151</a> for details on how to reset the EMG3435-Q20A).</p> <p>Also when you select this, you cannot enter an IP address for your EMG3435-Q20A in the field below.</p>
Static IP Address	Click this if you want to specify the IP address of your EMG3435-Q20A. Or if your ISP or network administrator gave you a static IP address to access the network or the Internet.
IP Address	Type the IP address in dotted decimal notation. The default setting is 192.168.1.2. If you change the IP address you will have to log in again with the new IP address.
Subnet Mask	The subnet mask specifies the network number portion of an IP address. Your EMG3435-Q20A will automatically calculate the subnet mask based on the IP address that you assign. Unless you are implementing subnetting, use the subnet mask computed by the EMG3435-Q20A.
Default Gateway	Enter a gateway IP address (if your ISP or network administrator gave you one) in this field.
DNS Server	
First DNS Server Second DNS Server Third DNS Server	<p>Select <b>Obtained From ISP</b> if your ISP dynamically assigns DNS server information (and the EMG3435-Q20A's WAN IP address). The field to the right displays the (read-only) DNS server IP address that the ISP assigns.</p> <p>Select <b>User-Defined</b> if you have the IP address of a DNS server. Enter the DNS server's IP address in the field to the right. If you chose <b>User-Defined</b>, but leave the IP address set to 0.0.0.0, <b>User-Defined</b> changes to <b>None</b> after you click <b>Apply</b>. If you set a second choice to <b>User-Defined</b>, and enter the same IP address, the second <b>User-Defined</b> changes to <b>None</b> after you click <b>Apply</b>.</p> <p>Select <b>None</b> if you do not want to configure DNS servers. If you do not configure a DNS server, you must know the IP address of a computer in order to access it.</p>

Table 17 LAN > LAN IP (continued)

LABEL	DESCRIPTION
Apply	Click <b>Apply</b> to save your changes to the EMG3435-Q20A.
Cancel	Click <b>Cancel</b> to reload the previous configuration for this screen.

# CHAPTER 8

## Tutorials

### 8.1 Overview

This chapter provides tutorials for setting up your EMG3435-Q20A.

- [Set Up a Wireless Network Using WPS](#)
- [Connect to EMG3435-Q20A Wireless Network without WPS](#)
- [Using Guest SSIDs on the EMG3435-Q20A](#)

### 8.2 Set Up a Wireless Network Using WPS

This section gives you an example of how to set up wireless network using WPS. This example uses the EMG3435-Q20A as the AP and NWD210N as the wireless client which connects to a notebook.

Note: The wireless client must be a WPS-aware device (for example, a WPS USB adapter ).

There are two WPS methods for creating a secure connection via the web configurator or utility. This tutorial shows you how to do both.

- **Push Button Configuration (PBC)** - create a secure wireless network simply by pressing a button. See [Section 8.2.1 on page 48](#). This is the easier method.
- **PIN Configuration** - create a secure wireless network simply by entering a wireless client's PIN (Personal Identification Number) in the EMG3435-Q20A's interface. See [Section 8.2.2 on page 49](#). This is the more secure method, since one device can authenticate the other.

#### 8.2.1 Push Button Configuration (PBC)

- 1 Make sure that your EMG3435-Q20A is turned on. Make sure the **WIFI** button (at the back panel of the EMG3435-Q20A) is pushed in, and that the device is placed within range of your notebook.
- 2 Make sure that you have installed the wireless client (this example uses the NWD210N) driver and utility in your notebook.
- 3 In the wireless client utility, find the WPS settings. Enable WPS and press the WPS button (**Start** or **WPS** button)
- 4 Log into EMG3435-Q20A's Web Configurator and press the **Push Button** in the **Expert > Wireless > WPS** screen.



Note: Your EMG3435-Q20A has a WPS button located on its rear panel, as well as a WPS button in its configuration utility. Both buttons have exactly the same function; you can use one or the other.

Note: It doesn't matter which button is pressed first. You must press the second button within two minutes of pressing the first one.

The EMG3435-Q20A sends the proper configuration settings to the wireless client. This may take up to two minutes. Then the wireless client is able to communicate with the EMG3435-Q20A securely.

The following figure shows you an example to set up wireless network and security by pressing a button on both EMG3435-Q20A and wireless client (the NWD210N in this example).

Figure 36 Example WPS Process: PBC Method

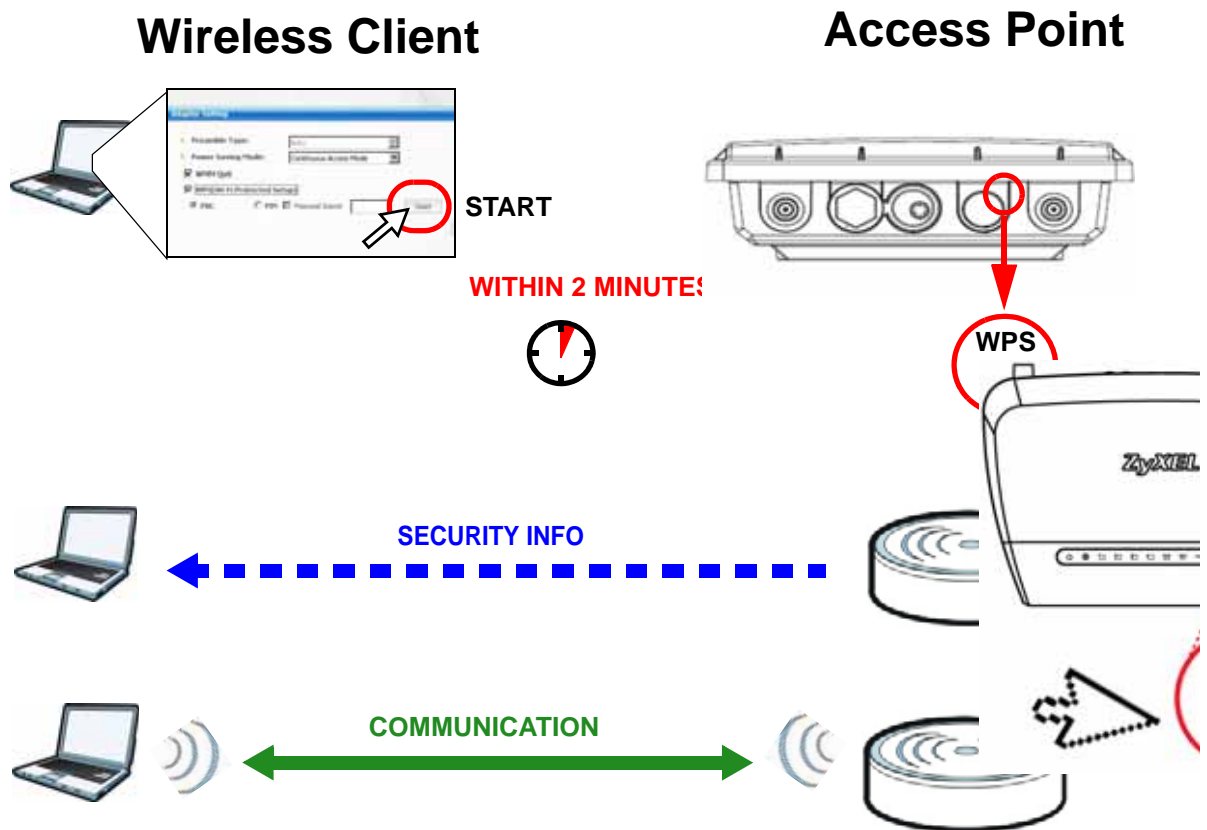

## 8.2.2 PIN Configuration

When you use the PIN configuration method, you need to use both EMG3435-Q20A's configuration interface and the client's utilities.

- 1 Launch your wireless client's configuration utility. Go to the WPS settings and select the PIN method to get a PIN number.
- 2 Enter the PIN number to the **PIN** field in the **Expert > Wireless > WPS** screen on the EMG3435-Q20A.

- Click **Start** buttons (or button next to the PIN field) on both the wireless client utility screen and the EMG3435-Q20A's **WPS** screen within two minutes.

The EMG3435-Q20A authenticates the wireless client and sends the proper configuration settings to the wireless client. This may take up to two minutes. Then the wireless client is able to communicate with the EMG3435-Q20A securely.

The following figure shows you the example to set up wireless network and security on EMG3435-Q20A and wireless client (ex. NWD210N in this example) by using PIN method.

**Figure 37** Example WPS Process: PIN Method

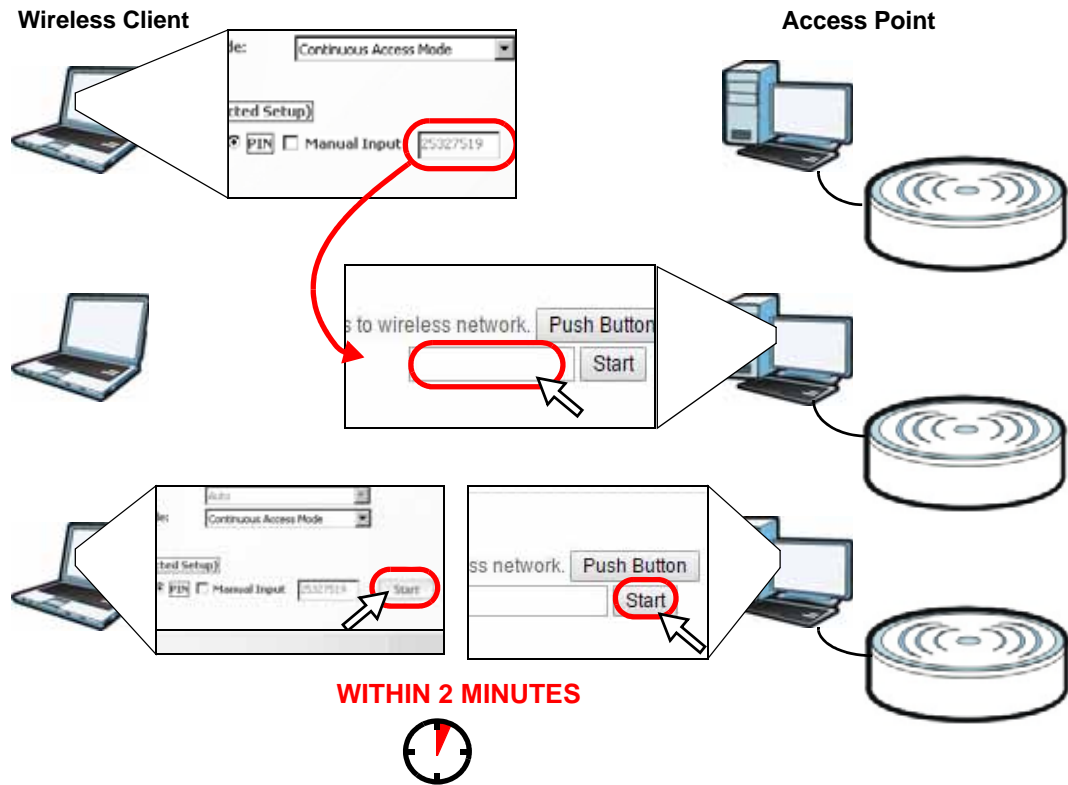

## 8.3 Connect to EMG3435-Q20A Wireless Network without WPS

This example shows you how to configure wireless security settings with the following parameters on your EMG3435-Q20A and connect your computer to the EMG3435-Q20A wireless network.

<b>Band</b>	2.4GHz
<b>SSID</b>	SSID_Example3
<b>Channel</b>	6
<b>Security</b>	WPA2-PSK (Pre-Shared Key: ThisismyWPA-PSKpre-sharedkey)

Follow the steps below to configure the wireless settings on your EMG3435-Q20A.

The instructions require that your hardware is connected (see the Quick Start Guide) and you are logged into the Web Configurator through your LAN connection (see [Section 2.2 on page 14](#)).

- 1 Make sure the **WIFI** switch (at the back panel of the EMG3435-Q20A) is set to **ON**.
- 2 Open the **Expert > Wireless > Wireless** screen in the AP's Web Configurator.
- 3 Confirm that the wireless LAN is enabled on the EMG3435-Q20A.
- 4 Select to configure the wireless settings for the 2.4GHz wireless radio.
- 5 Enter **SSID\_Example3** as the SSID and select **Channel-06** as the channel. Set security mode to **WPA2-PSK** and enter **ThisismyWPA-PSKpre-sharedkey** in the **Pre-Shared Key** field. Click **Apply**.

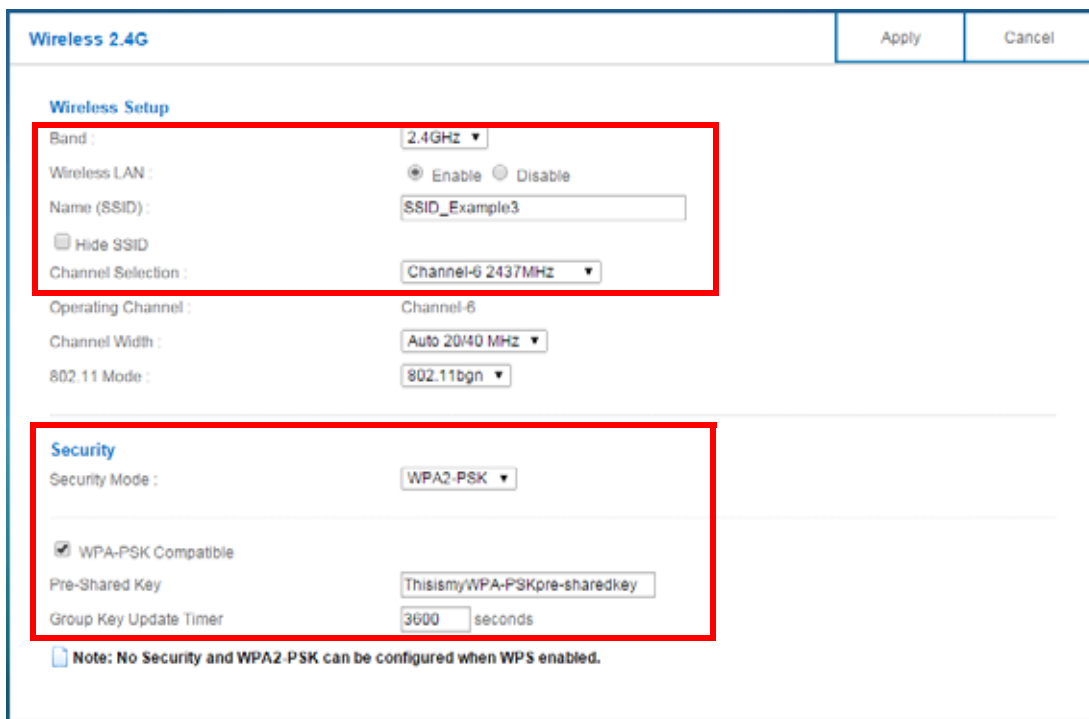

**Wireless 2.4G** Apply Cancel

**Wireless Setup**

Band : 2.4GHz ▾

Wireless LAN :  Enable  Disable

Name (SSID) : SSID\_Example3

Hide SSID

Channel Selection : Channel-6 2437MHz ▾

Operating Channel : Channel-6

Channel Width : Auto 20/40 MHz ▾

802.11 Mode : 802.11bgn ▾

**Security**

Security Mode : WPA2-PSK ▾

WPA-PSK Compatible

Pre-Shared Key : ThisismyWPA-PSKpre-sharedkey

Group Key Update Timer : 3600 seconds

**Note:** No Security and WPA2-PSK can be configured when WPS enabled.

- 6 Click **Expert > Status** to open the **Status** screen. Verify your wireless and wireless security settings under **Device Information** and check if the WLAN connection is up under **Interface Status**.

**System Status**

**Device Information**

Item	Data
Host Name:	NBG6817
Model Number:	NBG6817
Firmware Version:	V1.00(ABCS 0)0b6_test8
Sys OP Mode:	Router Mode
<b>WAN Information</b>	
- MAC Address:	1A:5A:3D:DB:6A:BF
- IP Address:	172.21.56.71
- IP Subnet Mask:	255.255.255.0
- Default Gateway:	172.21.56.254
- IPv6 Address:	
<b>LAN Information:</b>	
- MAC Address:	0E:E1:28:6C:E7:9E
- IP Address:	192.168.1.1
- IP Subnet Mask:	255.255.255.0
- DHCP:	Server
- IPv6 Address:	
<b>WLAN 2.4G Information:</b>	
- WLAN OP Mode:	Access Point Mode
- MAC Address:	11:03:7F:BA:DB:04
- SSID:	SSID_Example3
- Channel:	6
- Security:	WPA-PSK / WPA2-PSK
<b>WLAN 5G Information:</b>	
- WLAN OP Mode:	Access Point Mode
- MAC Address:	11:03:7F:BA:DB:05
- SSID:	ZyXELBADB05.speed
- Channel:	161
- Security:	WPA-PSK / WPA2-PSK
Firewall:	Enable

**System Status**

Item	Data
System Up Time:	0day 3hr 34min 58sec
Current Date/Time:	2016-05-03/14:58:35
<b>System Resource:</b>	
- CPU Usage:	15%
- Memory Usage:	42%

**Interface Status**

Interface	Status	Rate
WAN	UP	100M
LAN1	Down	
LAN2	UP	1000M
LAN3	Down	
LAN4	Down	
WLAN 2.4G	UP	800 M
WLAN 5G	UP	1733 M

**Printer Information**

Item	Data
Printer Name:	None

### 8.3.1 Configure Your Notebook

Note: In this example, we use the Zyxel NWD6505 wireless adapter as the wireless client and use the Windows built-in utility (Windows Zero Configuration (WZC)) to connect to the wireless network.

- 1 The EMG3435-Q20A supports IEEE 802.11a, IEEE 802.11b, IEEE 802.11g, IEEE 802.11n and IEEE 802.11ac wireless clients. Make sure that your notebook or computer's wireless adapter supports one of these standards.
- 2 Wireless adapters come with software sometimes called a "utility" that you install on your computer. See your wireless adapter's User's Guide for information on how to do that.
- 3 After you've installed the driver and attached the NWD6505 to your computer's USB port, right-click the **Wireless Network Connection** icon in your computer's system tray, select and click **View Available Wireless Networks**.

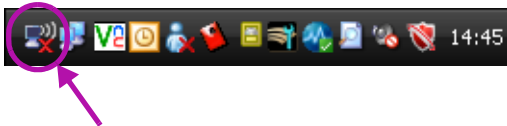

- 4 The **Wireless Network Connection** screen displays. Click **Refresh network list** to view the available wireless APs within range.

- 5 Select **SSID\_Example3** and click **Connect**.

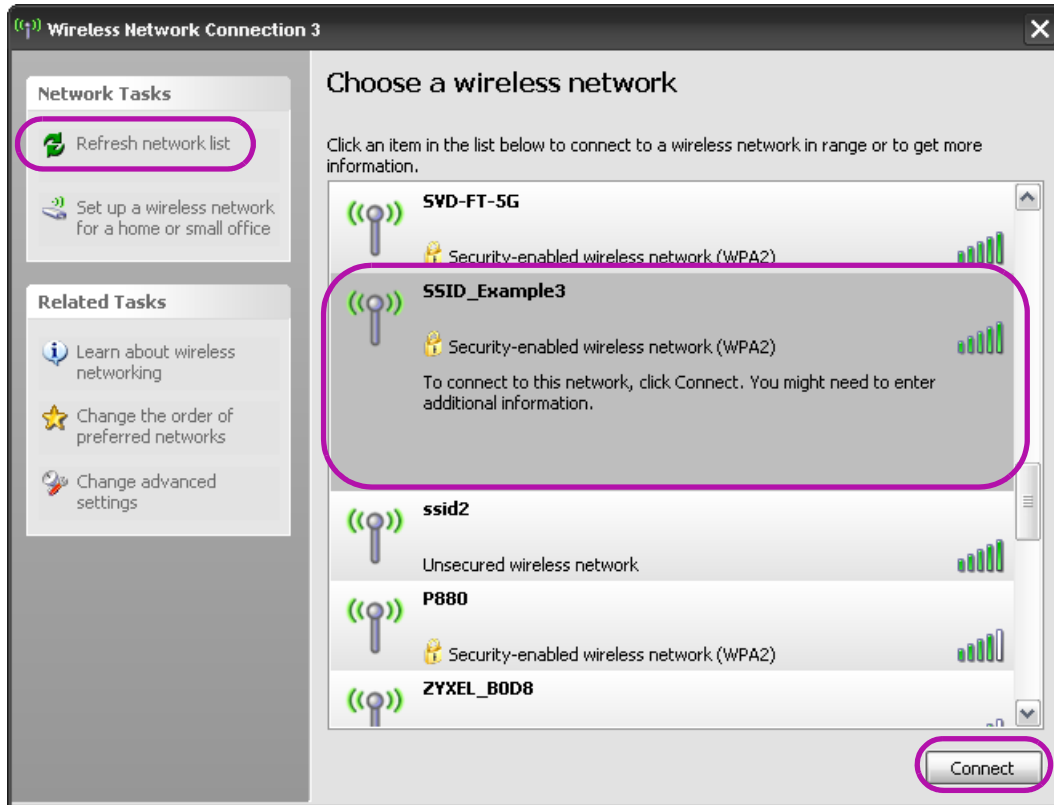

- 6 Type the security key in the following screen. Click **Connect**.

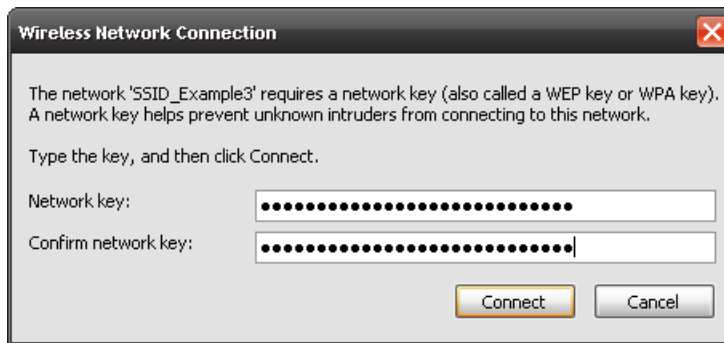

- 7 Check the status of your wireless connection in the screen below.

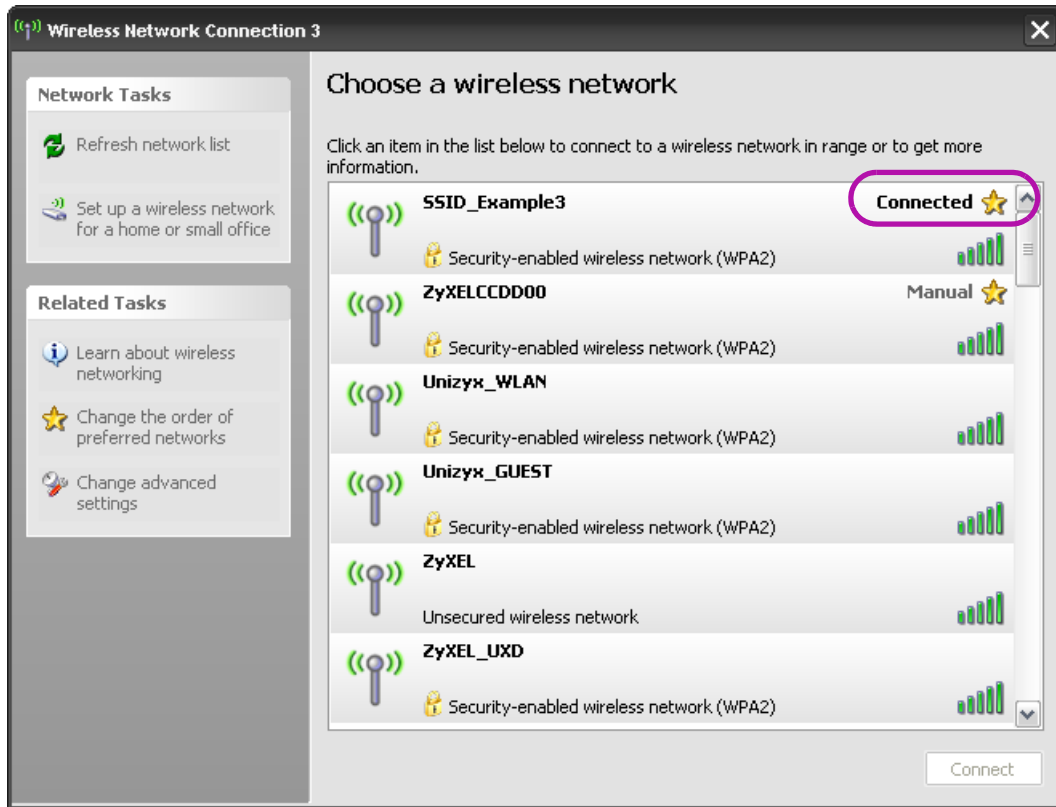

- 8 If the wireless client keeps trying to connect to or acquiring an IP address from the EMG3435-Q20A, make sure you entered the correct security key.
- If the connection has limited or no connectivity, make sure the DHCP server is enabled on the EMG3435-Q20A.

If your connection is successful, open your Internet browser and enter <http://www.zyxel.com> or the URL of any other web site in the address bar. If you are able to access the web site, your wireless connection is successfully configured.

## 8.4 Using Guest SSIDs on the EMG3435-Q20A

You can configure more than one guest SSID on a EMG3435-Q20A. See [Section 11.4 on page 104](#).

This allows you to configure multiple independent wireless networks on the EMG3435-Q20A as if there were multiple APs (virtual APs). Each guest SSID has its own wireless security type. That is, each SSID on the EMG3435-Q20A represents a different access point/wireless network to wireless clients in the network.

Clients can associate only with the SSIDs for which they have the correct security settings. Clients using different SSIDs can access the Internet and the wired network behind the EMG3435-Q20A (such as a printer).

For example, you may set up three wireless networks (A, B and C) in your office. A is for workers, B is for guests and C is specific to a VoIP device in the meeting room.

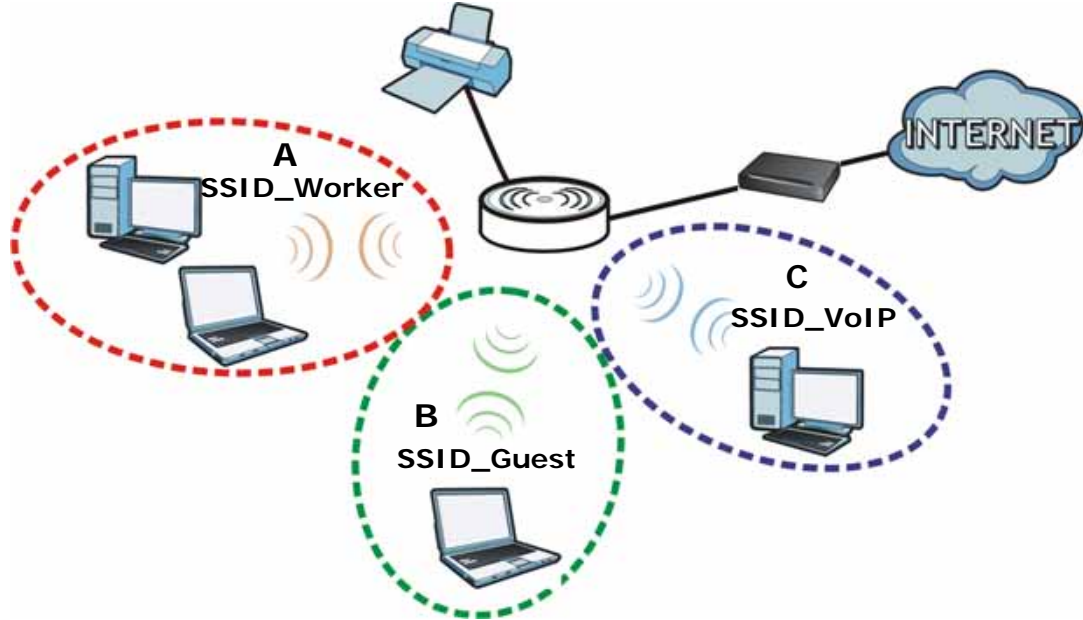

### 8.4.1 Configuring Security Settings of Guest SSIDs

The EMG3435-Q20A is in router mode by default.

This example shows you how to configure the SSIDs with the following parameters on your EMG3435-Q20A (in router mode).

SSID	SECURITY TYPE	KEY
SSID_Worker	WPA2-PSK WPA Compatible	DoNotStealMyWirelessNetwork
SSID_VoIP	WPA-PSK	VoIPOnly12345678
SSID_Guest	WPA-PSK	keyexample123

- 1 Connect your computer to the LAN port of the EMG3435-Q20A using an Ethernet cable.
- 2 The default IP address of the EMG3435-Q20A in router mode is "192.168.1.1". In this case, your computer must have an IP address in the range between "192.168.1.2" and "192.168.1.254".
- 3 Click **Start > Run** on your computer in Windows. Type "cmd" in the dialog box. Enter "ipconfig" to show your computer's IP address. If your computer's IP address is not in the correct range then see [Appendix B on page 173](#) for information on changing your computer's IP address.
- 4 After you've set your computer's IP address, open a web browser such as Internet Explorer and type "http://192.168.1.1" as the web address in your web browser.
- 5 Enter "1234" (default) as the password and click **Login**.
- 6 Type a new password and retype it to confirm, then click **Apply**. Otherwise, click **Ignore**.

- 7 The **Easy Mode** appears.
- 8 Go to **Expert > Wireless > Guest Wireless**. Click the **Edit** icon of the first entry to configure wireless and security settings for **SSID\_Worker**.



- 9 Configure the screen as follows. In this example, you enable **Intra-BSS Traffic** for **SSID\_Worker** to allow wireless clients in the same wireless network to communicate with each other. Click **Apply**.

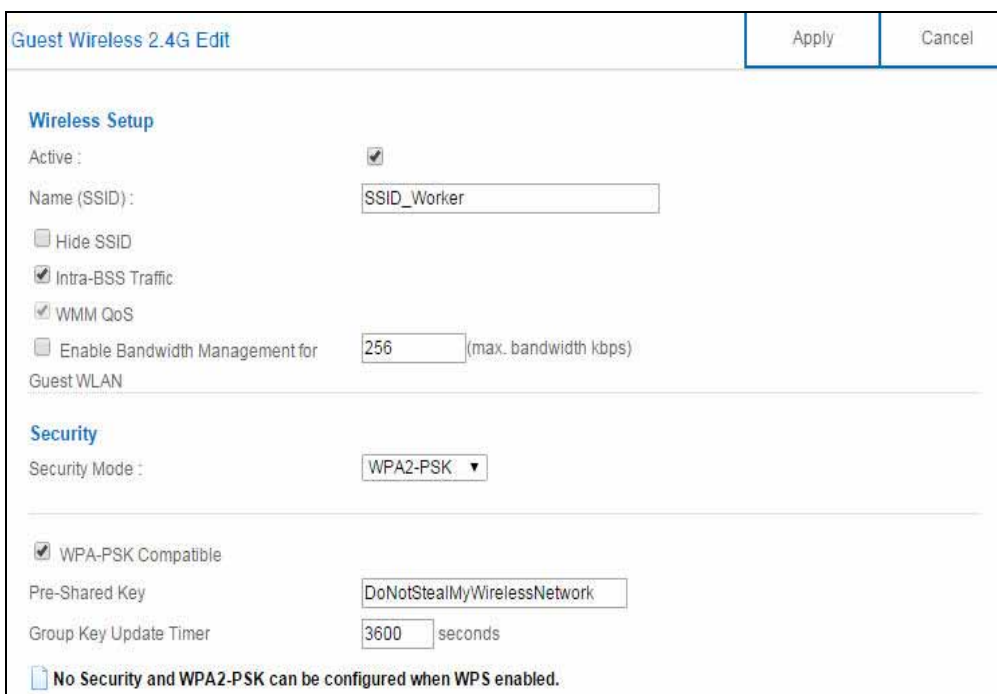

- 10 Click the **Edit** icon of the second entry to configure wireless and security settings for **SSID\_VoIP**.



- 11 Configure the screen as follows. You do not enable **Intra-BSS Traffic** for **SSID\_VoIP**. Click **Apply**.



Guest Wireless 2.4G Edit Apply Cancel

**Wireless Setup**

Active:

Name (SSID):

Hide SSID

Intra-BSS Traffic

WMM CoS

Enable Bandwidth Management for Guest WLAN  (max. bandwidth kbps)

---

**Security**

Security Mode:

Pre-Shared Key:

Group Key Update Timer:  seconds

No Security and WPA2-PSK can be configured when WPS enabled.

- 12 Click the **Edit** icon of the third entry to configure wireless and security settings for **SSID\_Guest**.

Guest Wireless 2.4G

Band:

**Guest Wireless Setup**

#	Status	SSID	Security	Remaining time	Edit
1		SSID_Worker	WPA2-PSK	0:0:0 <input type="text" value="Set"/>	
2		SSID_VoIP	WPA2-PSK	0:0:0 <input type="text" value="Set"/>	
3		ZyXEL_SSID3	No Security	0:0:0 <input type="text" value="Set"/>	

- 13 Configure the screen as follows. In this example, you enable **Intra-BSS Traffic** for **SSID\_Guest** to allow wireless clients in the same wireless network to communicate with each other. Select **Enable Guest WLAN** to allow clients to access the Internet only. Click **Apply**.

Guest Wireless 2.4G Edit Apply Cancel

**Wireless Setup**

Active:

Name (SSID):

Hide SSID

Intra-BSS Traffic

WMM CoS

Enable Bandwidth Management for Guest WLAN  (max. bandwidth kbps)

---

**Security**

Security Mode:

Pre-Shared Key:

Group Key Update Timer:  seconds

No Security and WPA2-PSK can be configured when WPS enabled.

---

# PART II

## Technical Reference

---

# CHAPTER 9

## Status

### 9.1 Overview

This chapter discusses read-only information related to the device state of the EMG3435-Q20A.

#### 9.1.1 What You Can Do

- Use the **Live Network Monitor** screen to view transmission data rates between the EMG3435-Q20A and the Internet or connected devices ([Section 9.2 on page 59](#)).
- Use the **Usage Monitor** screen to view transmission data and bandwidth usage between the EMG3435-Q20A and applications or connected devices ([Section 9.3 on page 62](#)).
- Use the **Common Usage** screen to view the top five traffic flows transmitting from/to the selected LAN device(s) ([Section Figure 48 on page 68](#)).
- Use the **Download Traffic Statistics** screen to view the type and percentage of most download traffic ([Section 9.5 on page 69](#)).
- Use the **Client Tables** screen to view the online clients information ([Section 9.6 on page 70](#)).

### 9.2 Live Network Monitor Screen

Use this screen to view the current upstream and downstream transmission speeds between the EMG3435-Q20A and the Internet and/or between the EMG3435-Q20A and the connected device(s) (represented by icons indicating the kind of network device), including those connecting wirelessly.

Click **Expert Mode > Status > Live Network Monitor**. The following screen displays. You can move your mouse over a device icon to view information about the device, such as the name, IP address, MAC address, device type and connection type.

Figure 38 Expert Mode &gt; Status &gt; Live Network Monitor

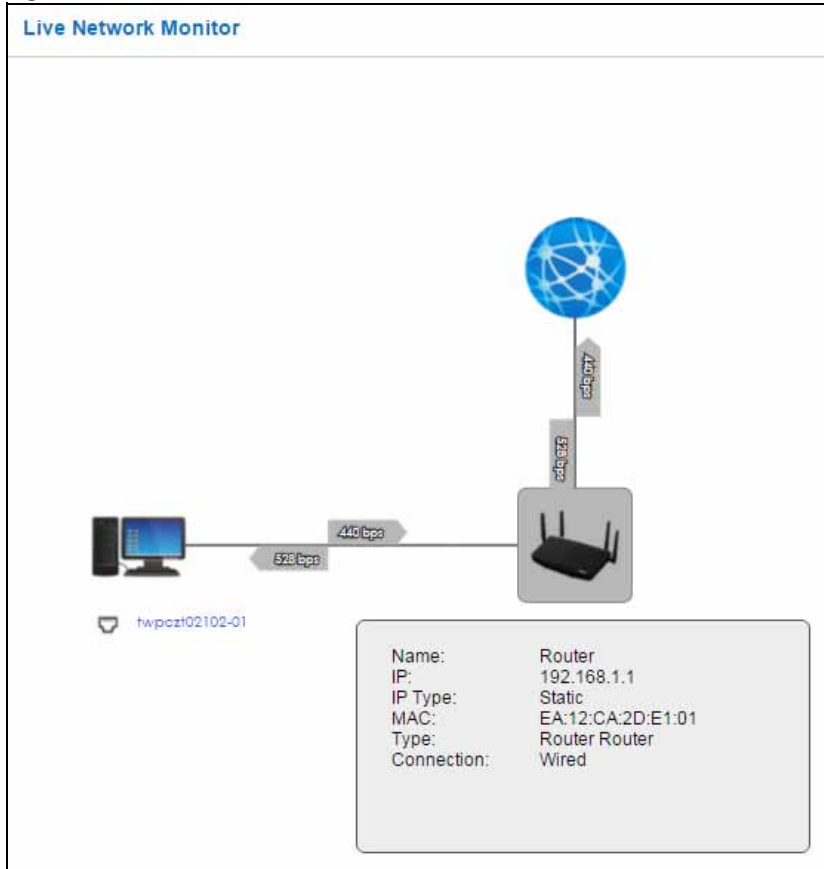

Click a device icon to go to a screen that displays the upstream/downstream bandwidth as a line graph. If you click the EMG3435-Q20A's icon, it also shows the transmission rate between the EMG3435-Q20A and each connected device. If you click a connected device's icon, you can see the current transmission rate for a traffic type. The green ball indicates the traffic flow is given enough bandwidth.

Figure 39 Expert Mode > Status > Live Network Monitor: Traffic Statistics (EMG3435-Q20A)

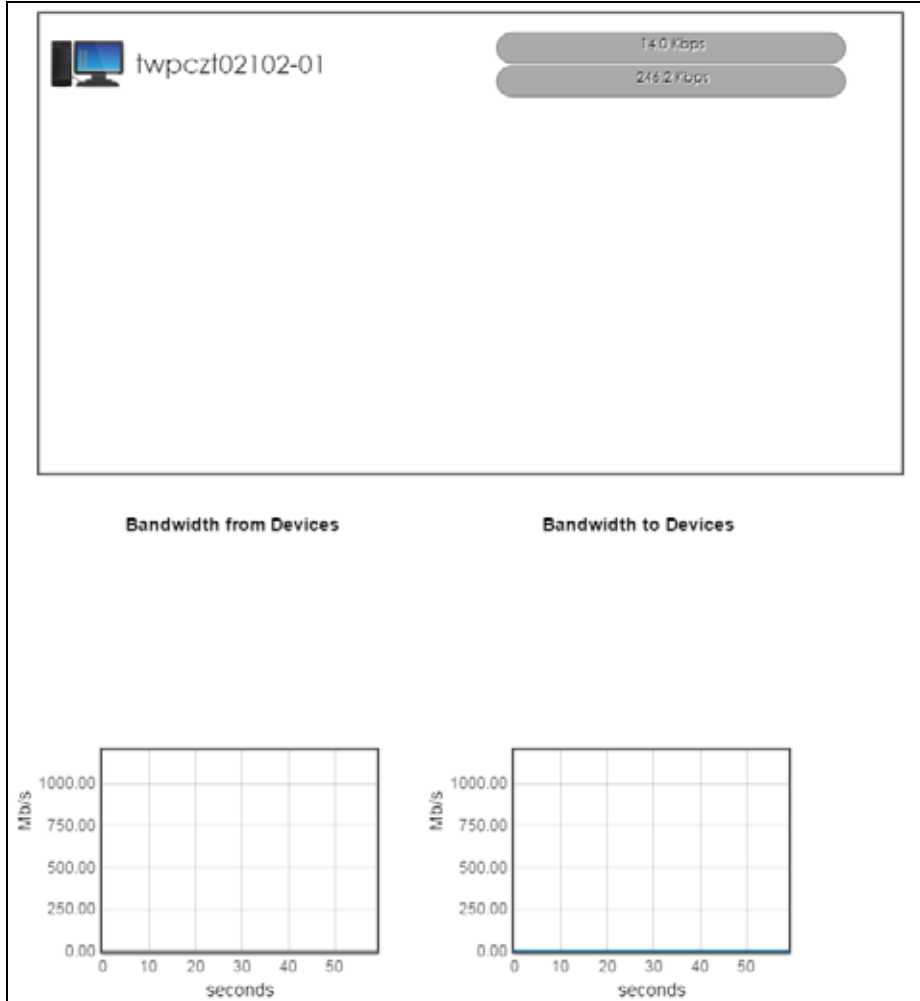

**Figure 40** Expert Mode > Status > Live Network Monitor: Traffic Statistics (Connected Device)

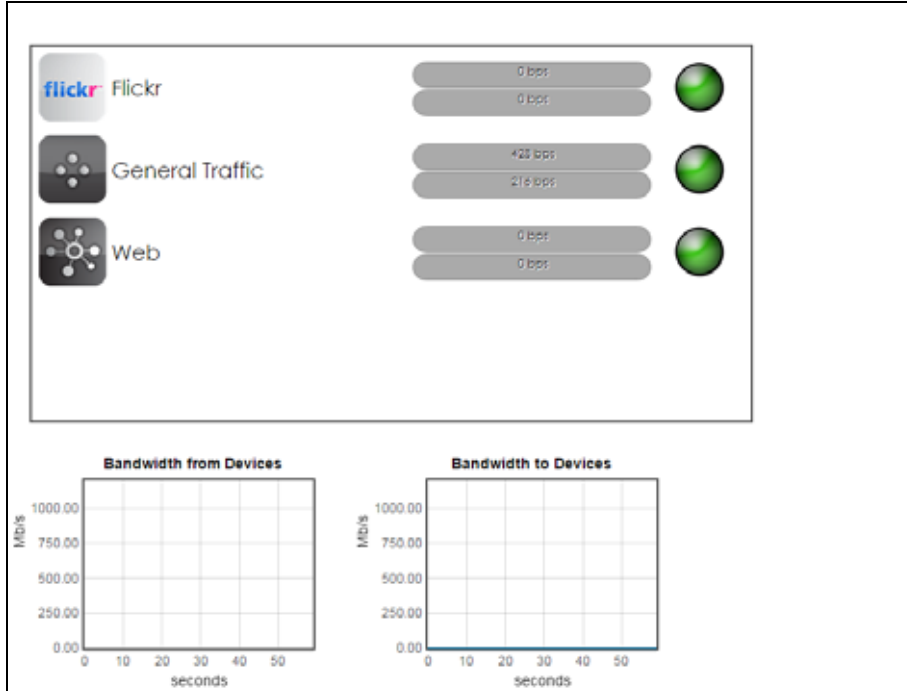

## 9.3 Usage Monitor Screens

- Use the **Internet Data Usage Monitor** screen to view the current amount of bandwidth being transmitted from/to the connected devices or applications ([Section 9.3.1 on page 62](#)).
- Use the **Bandwidth History** screen to view the upload/download peak being transmitted from/to the connected devices or applications ([Section 9.3.2 on page 63](#)).
- Use the **Time Tracker** screen to view the time period over which the traffic flow occurred from connected devices ([Section 9.3.3 on page 65](#)).
- Use the **Data Usage Alert** screen to view the amount of bandwidth and configure your data plan ([Section 9.3.4 on page 65](#)).

### 9.3.1 Internet Data Usage Monitor

Use this screen to view the current amount of bandwidth being transmitted from/to the connected LAN device(s) or applications. Select the device(s) or applications radio button to view the amount of uplink and downlink traffic by device(s) or applications.

Click **Expert Mode > Status > Usage Monitor > Internet Data Usage Monitor**. The following screen displays.

Figure 41 Expert Mode &gt; Status &gt; Usage Monitor &gt; Internet Data Usage Monitor: Device

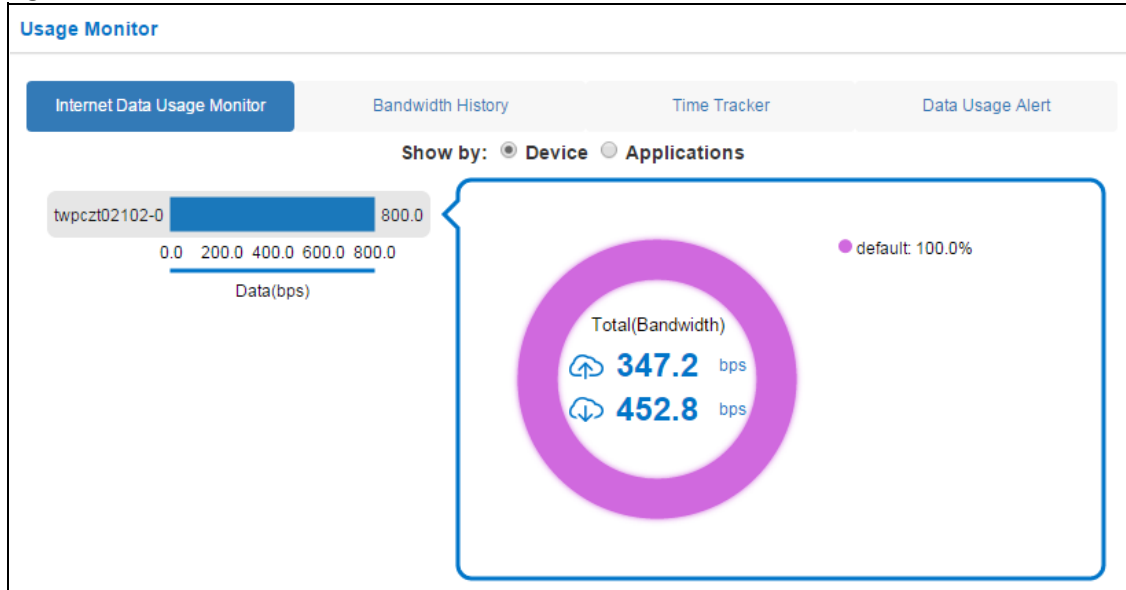
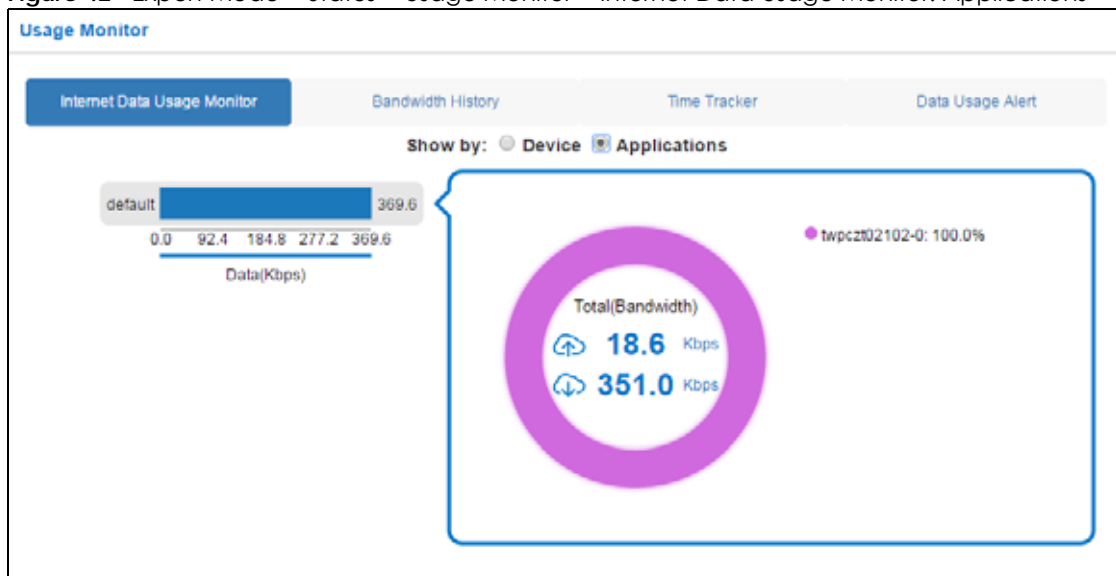

Figure 42 Expert Mode &gt; Status &gt; Usage Monitor &gt; Internet Data Usage Monitor: Applications



### 9.3.2 Bandwidth History

Use this screen to view the peak upload (green) and download (blue) bandwidth in the past day, week, month, or quarter. Bandwidth history can be displayed by selecting the connected LAN device(s) or applications radio button. Select the time period and device(s) (or applications) from the drop-down list box to view the corresponding upload/download bandwidth. You can put your mouse in the gray bar and drag it to view the peak upload and download bandwidth. You can also put your cursor in the graph to view graph details.

Click **Expert Mode > Status > Usage Monitor > Bandwidth History**. The following screen displays.

Figure 43 Expert Mode > Status > Usage Monitor > Bandwidth History: Device

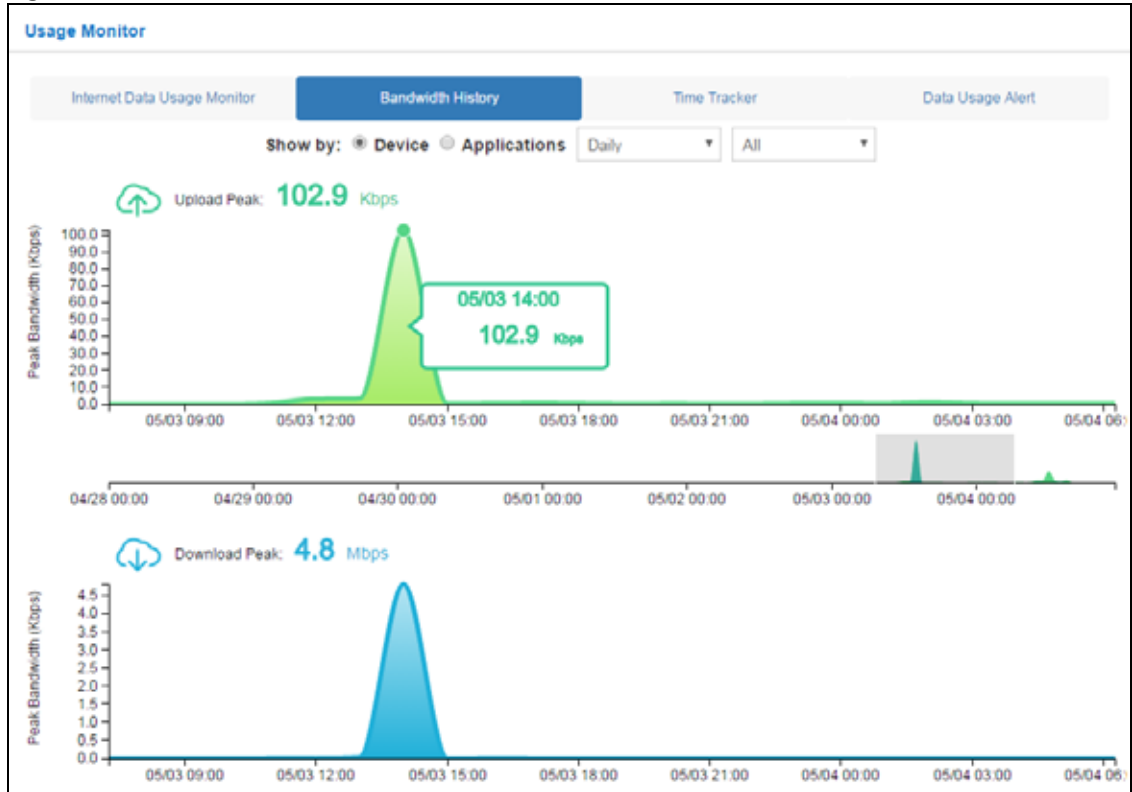
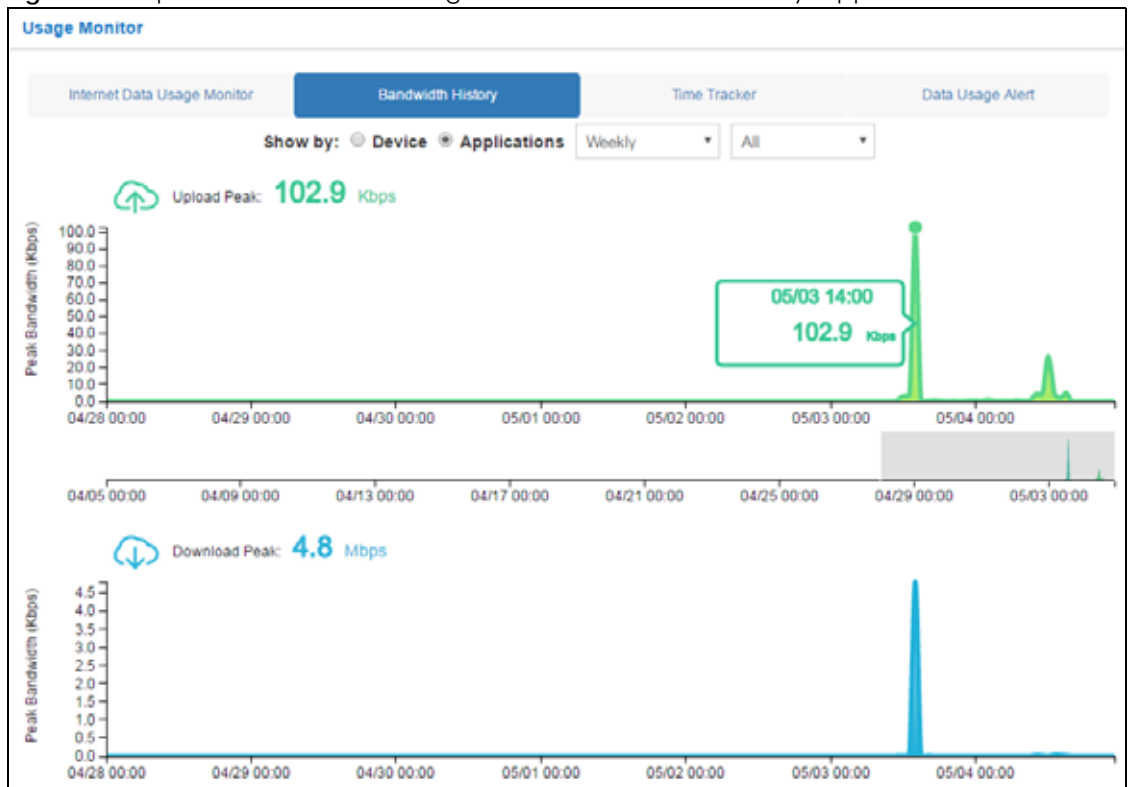



Figure 44 Expert Mode > Status > Usage Monitor > Bandwidth History: Applications





### 9.3.3 Time Tracker

Use this screen to view the time period over which the traffic flow occurred and the amount of uplink and downlink traffic generated in the past day, week, month, or quarter. Select the connected LAN device(s) from the drop-down list box and specify the time period to view the upload/download bandwidth. You can click the calendar icon (  ) to choose the specified date.

Click **Expert Mode > Status > Usage Monitor > Time Tracker**. The following screen displays.

**Figure 45** Expert Mode > Status > Usage Monitor > Time Tracker

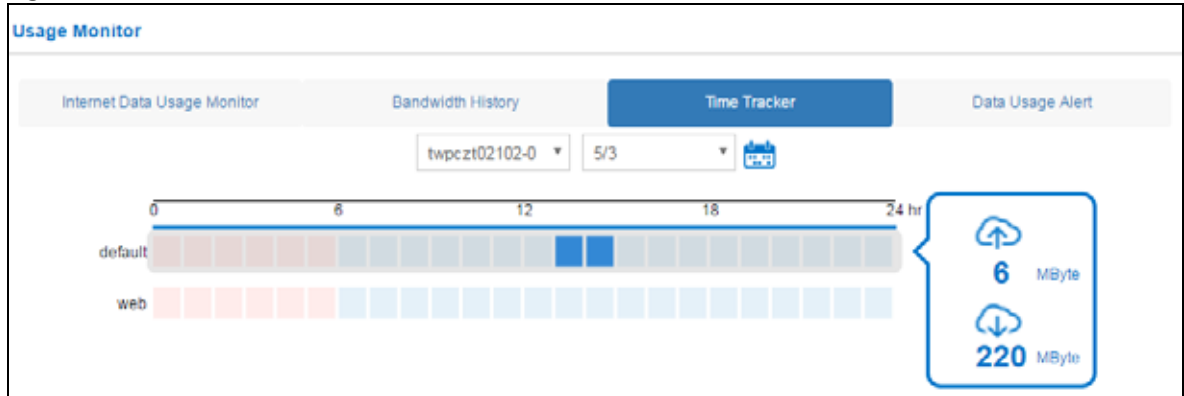

### 9.3.4 Data Usage Alert

View data usage, data history and configure a data plan from this screen.

#### Data Usage Alert

Use this screen to view the upload (green) and download (blue) bandwidth in the past day, week, month, or quarter. Data usage can be displayed by selecting the connected LAN device(s) or applications radio button. Select the time period and device(s) (or applications) from the drop-down list box to view the corresponding upload/download bandwidth. You can put your mouse in the gray bar and drag it to view the upload and download bandwidth. You can also put your cursor in the graph to view graph details.

Click **Expert Mode > Status > Usage Monitor > Data Usage Alert**. The following screen displays.

Figure 46 Expert Mode &gt; Status &gt; Usage Monitor &gt; Data Usage Alert



## Data History

Click **Data Usage** to view the remaining data usage allowed and remaining days to access the Internet. Use the **Data History** screen to view the upload (green) and download (blue) bandwidth in the past day, week, month, or quarter. Data history can be displayed by selecting the connected LAN device(s) or applications radio button. Select the time period and device(s) (or applications) from the drop-down list box to view the corresponding upload/download bandwidth. The following screen displays.

Figure 47 Expert Mode &gt; Status &gt; Usage Monitor &gt; Data Usage Alert &gt; Data Usage

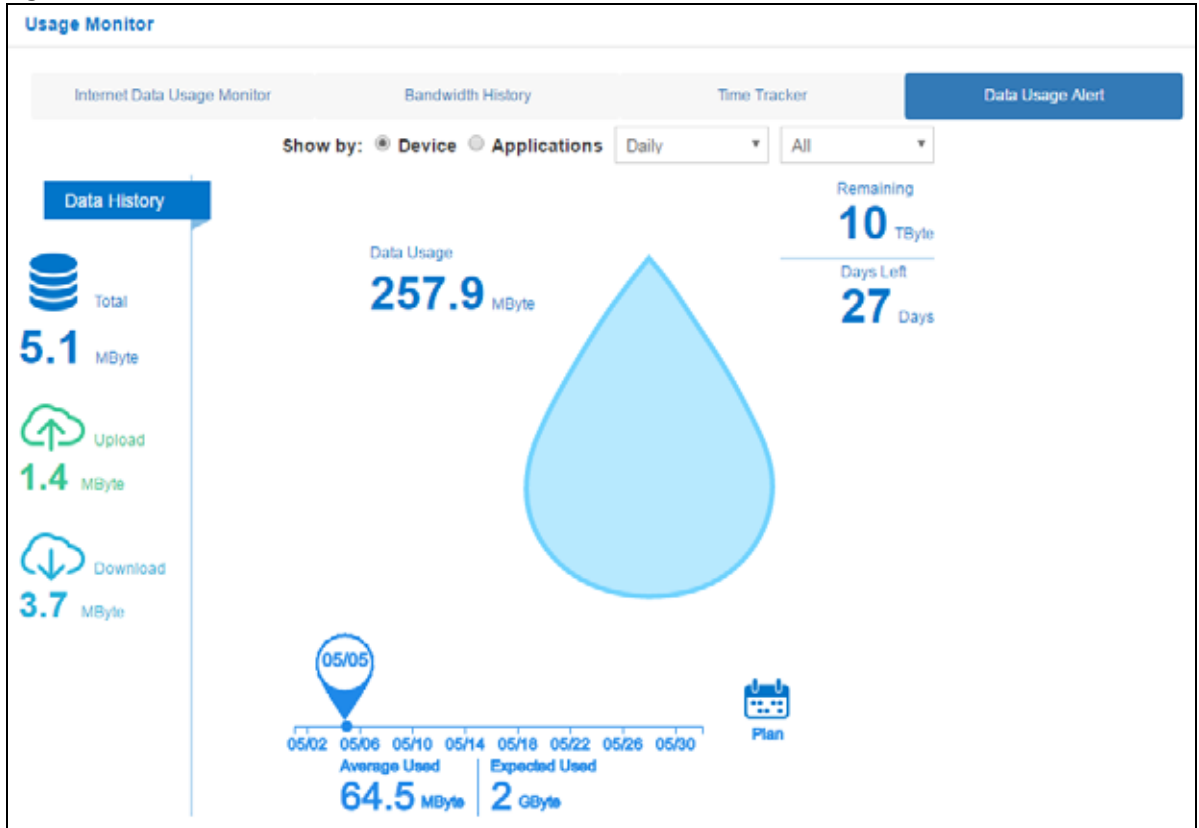

## Data Plan

Click the data plan icon (  ) to specify a data limit per month and the date data amounts used are reset. **Data Usage** displays the amount of data used from beginning. **Average Used** displays the average amount of data used from the beginning date to the current date, and **Expected Used** displays the expected amount data that will be used this month based on the **Average Used**. The following screen displays.

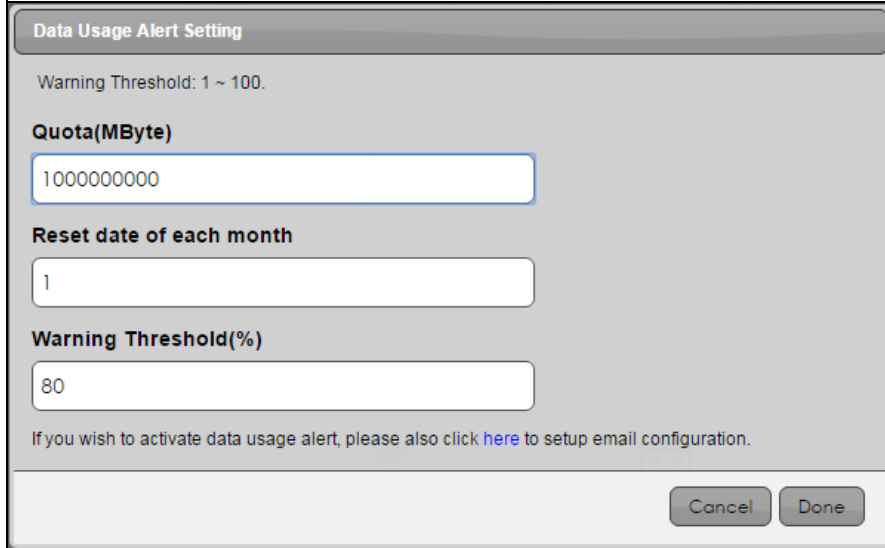
**Figure 48** Expert Mode > Status > Usage Monitor > Data Usage Alert > Data Usage > Plan

The screenshot shows a dialog box titled "Data Usage Alert Setting". It contains the following fields and text:

- Warning Threshold: 1 ~ 100.
- Quota(MByte)**: A text input field containing "1000000000".
- Reset date of each month**: A text input field containing "1".
- Warning Threshold(%)**: A text input field containing "80".
- At the bottom, there is a note: "If you wish to activate data usage alert, please also click [here](#) to setup email configuration."
- At the bottom right, there are two buttons: "Cancel" and "Done".

## 9.4 Common Usage Screen

Use this screen to view the top five traffic flows transmitting from/to the selected LAN device(s) in the past day, week or month.

Click **Expert Mode > Status > Common Usage** to open the **Common Usage** screen.

The y-axis shows the time period over which the traffic flow occurred. The x-axis shows the type of the traffic flow.

Figure 49 Expert Mode &gt; Status &gt; Common Usage

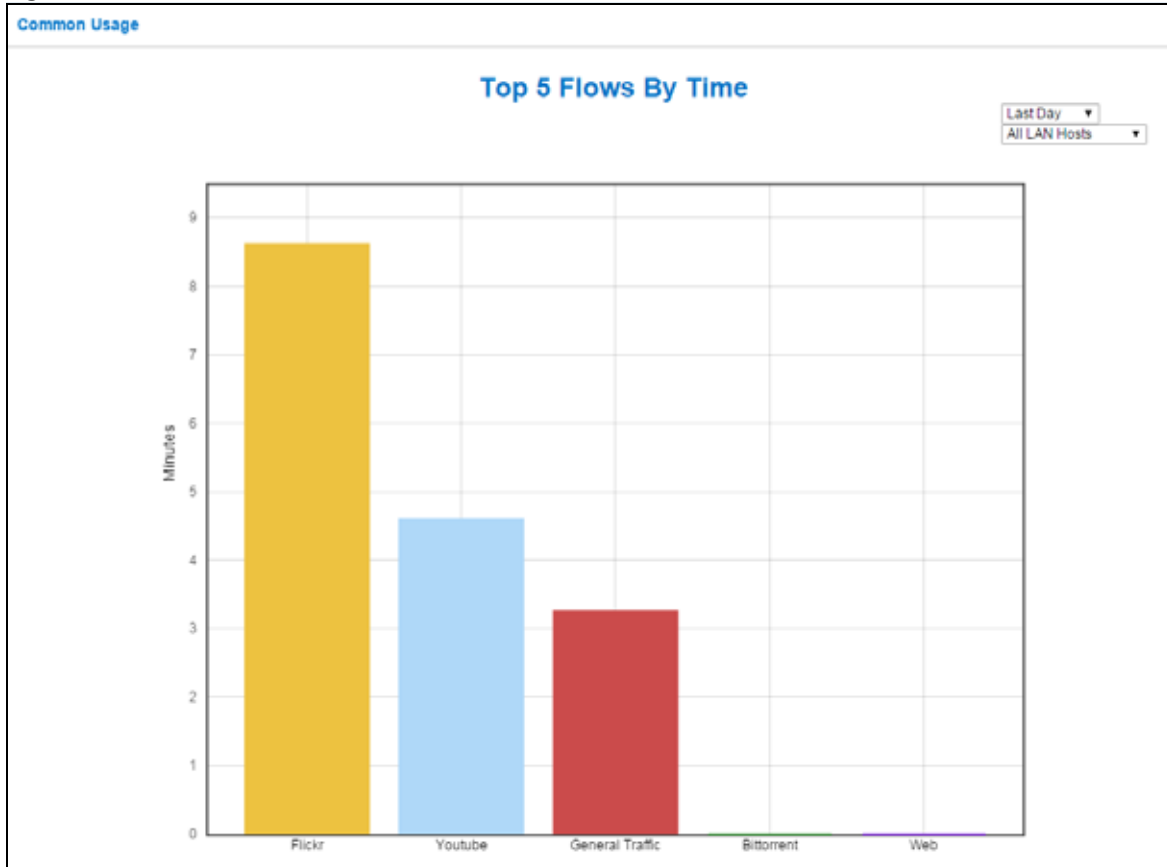

## 9.5 Download Traffic Statistics Screen

Use this screen to view the type and percentage of most download traffic on the EMG3435-Q20A.

Click **Expert Mode > Status > Download Traffic Statistics** to open the **Download Traffic Statistics** screen.

Figure 50 Expert Mode &gt; Status &gt; Download Traffic Statistics

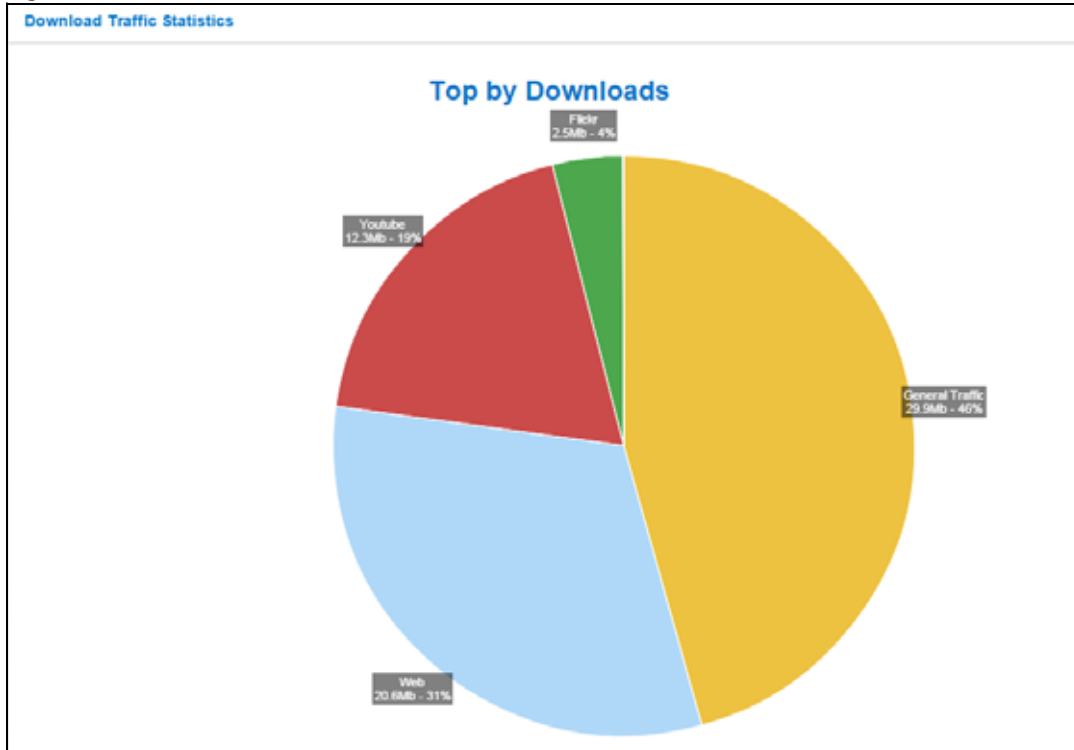

## 9.6 Client Tables Screen

You can configure the EMG3435-Q20A's LAN as a DHCP server or disable it. When configured as a server, the EMG3435-Q20A assigns IP addresses to the clients. If DHCP service is disabled, you must have another DHCP server on that network, or else the computer must be manually configured.

Use this screen to view the online clients information (including Host Name, IP Address, MAC Address, Interface/Rssi, and Lease time) of all network clients using the EMG3435-Q20A's DHCP server.

Click **Expert Mode > Status > Client Tables** to open the **Client Tables** screen.

Figure 51 Expert Mode &gt; Status &gt; Client Tables

Client Tables							Apply	Cancel
Interface: ALL								
DHCP Client Table								
#	Online	Host Name	IP Address	MAC Address	Interface/Rssi	Lease time	Reserve	
1		twpczt02102-01	192.168.1.88	c0:3f:d5:ba:9e:b7	LAN	2016-03-30 04:50	<input type="checkbox"/>	

The following table describes the labels in this screen.

Table 18 Expert Mode > Status > DHCP Table

LABEL	DESCRIPTION
Interface	Select the interface from the drop-down list box to display current DHCP client information.
#	This is the index number of the host computer.
Online	This field displays whether the connection to the host computer is up (a yellow bulb) or down (a gray bulb).
Host Name	This field displays the computer host name.
IP Address	This field displays the IP address relative to the # field listed above.
MAC Address	This field shows the MAC address of the computer with the name in the <b>Host Name</b> field.  Every Ethernet device has a unique MAC (Media Access Control) address which uniquely identifies a device. The MAC address is assigned at the factory and consists of six pairs of hexadecimal characters, for example, 00:A0:C5:00:00:02.
Interface/Rssi	This field displays the device's interface type or received signal strength indicator (RSSI) that is currently connected to the EMG3435-Q20A.
Lease time	This field displays the amount of time that the IP address is valid.
Reserve	Select this if you want to reserve the IP address for this specific MAC address.
Apply	Click <b>Apply</b> to save your changes back to the EMG3435-Q20A.
Cancel	Click <b>Cancel</b> to reload the previous configuration for this screen.

# CHAPTER 10

## WAN

### 10.1 Overview

This chapter discusses the EMG3435-Q20A's **WAN** screens. Use these screens to configure your EMG3435-Q20A for Internet access.

A WAN (Wide Area Network) connection is an outside connection to another network or the Internet. It connects your private networks such as a LAN (Local Area Network) and other networks, so that a computer in one location can communicate with computers in other locations.

Figure 52 LAN and WAN

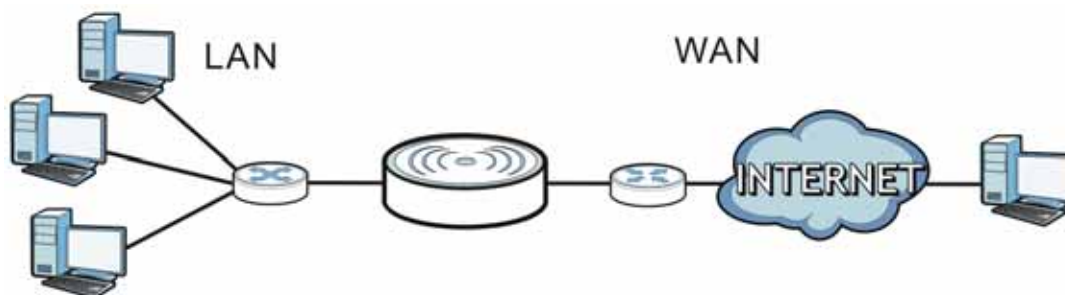

### 10.2 What You Can Do

- Use the **Internet Connection** screen to enter your ISP information and set how the computer acquires its IP, DNS and WAN MAC addresses ([Section 10.4 on page 75](#)).
- Use the **NAT > General** screen to enable NAT, set a default server and change your EMG3435-Q20A's port forwarding settings ([Section 10.5.1 on page 87](#)).
- Use the **NAT > Port Trigger** screen to configure your EMG3435-Q20A's trigger port settings ([Section 10.5.2 on page 89](#)).
- Use the **NAT > Passthrough** screen to configure your EMG3435-Q20A's ALGs and VPN pass-through settings ([Section 10.5.3 on page 89](#)).
- Use the **Dynamic DNS** screen to change your EMG3435-Q20A's DDNS settings ([Section 10.6 on page 91](#)).

### 10.3 What You Need To Know

The information in this section can help you configure the screens for your WAN connection, as well as enable/disable some advanced features of your EMG3435-Q20A.



## 10.3.1 Configuring Your Internet Connection

### Encapsulation Method

Encapsulation is used to include data from an upper layer protocol into a lower layer protocol. To set up a WAN connection to the Internet, you need to use the same encapsulation method used by your ISP (Internet Service Provider). If your ISP offers a dial-up Internet connection using PPPoE (PPP over Ethernet) or PPTP (Point-to-Point Tunneling Protocol), they should also provide a username and password (and service name) for user authentication.

### WAN IP Address

The WAN IP address is an IP address for the EMG3435-Q20A, which makes it accessible from an outside network. It is used by the EMG3435-Q20A to communicate with other devices in other networks. It can be static (fixed) or dynamically assigned by the ISP each time the EMG3435-Q20A tries to access the Internet.

If your ISP assigns you a static WAN IP address, they should also assign you the subnet mask and DNS server IP address(es) (and a gateway IP address if you use the Ethernet or ENET ENCAP encapsulation method).

### DNS Server Address Assignment

Use Domain Name System (DNS) to map a domain name to its corresponding IP address and vice versa, for instance, the IP address of [www.zyxel.com](http://www.zyxel.com) is 204.217.0.2. The DNS server is extremely important because without it, you must know the IP address of a computer before you can access it.

The EMG3435-Q20A can get the DNS server addresses in the following ways.

- 1 The ISP tells you the DNS server addresses, usually in the form of an information sheet, when you sign up. If your ISP gives you DNS server addresses, manually enter them in the DNS server fields.
- 2 If your ISP dynamically assigns the DNS server IP addresses (along with the EMG3435-Q20A's WAN IP address), set the DNS server fields to get the DNS server address from the ISP.

### WAN MAC Address

The MAC address screen allows users to configure the WAN port's MAC address by either using the factory default or cloning the MAC address from a computer on your LAN. Choose **Factory Default** to select the factory assigned default MAC Address.

Otherwise, click **Clone the computer's MAC address - IP Address** and enter the IP address of the computer on the LAN whose MAC you are cloning. Once it is successfully configured, the address will be copied to configuration file. It is recommended that you clone the MAC address prior to hooking up the WAN Port.

## Multicast

Traditionally, IP packets are transmitted in one of either two ways - Unicast (1 sender - 1 recipient) or Broadcast (1 sender - everybody on the network). Multicast delivers IP packets to a group of hosts on the network - not everybody and not just 1.

Figure 53 Multicast Example

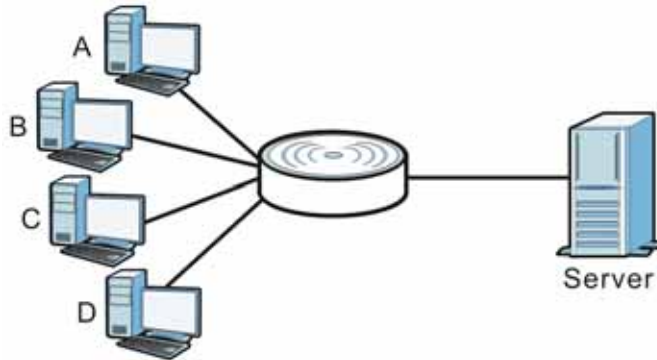

In the multicast example above, systems A and D comprise one multicast group. In multicasting, the server only needs to send one data stream and this is delivered to systems A and D.

IGMP (Internet Group Multicast Protocol) is a network-layer protocol used to establish membership in a multicast group - it is not used to carry user data. The EMG3435-Q20A supports both IGMP version 1 (**IGMP-v1**) and IGMP version 2 (**IGMP-v2**).

At start up, the EMG3435-Q20A queries all directly connected networks to gather group membership. After that, the EMG3435-Q20A periodically updates this information. IP multicasting can be enabled/disabled on the EMG3435-Q20A WAN interface in the Web Configurator (**WAN**). Select **None** to disable IP multicasting on these interfaces.

## Auto-IP Change

When the EMG3435-Q20A gets a WAN IP address or a DNS server IP address which is in the same subnet as the LAN IP address 192.168.1.1, Auto-IP-Change allows the EMG3435-Q20A to change its LAN IP address to 10.0.0.1 automatically. If the EMG3435-Q20A's original LAN IP address is 10.0.0.1 and the WAN IP address is in the same subnet, such as 10.0.0.3, the EMG3435-Q20A switches to use 192.168.1.1 as its LAN IP address.

Figure 54 Auto-IP-Change Example

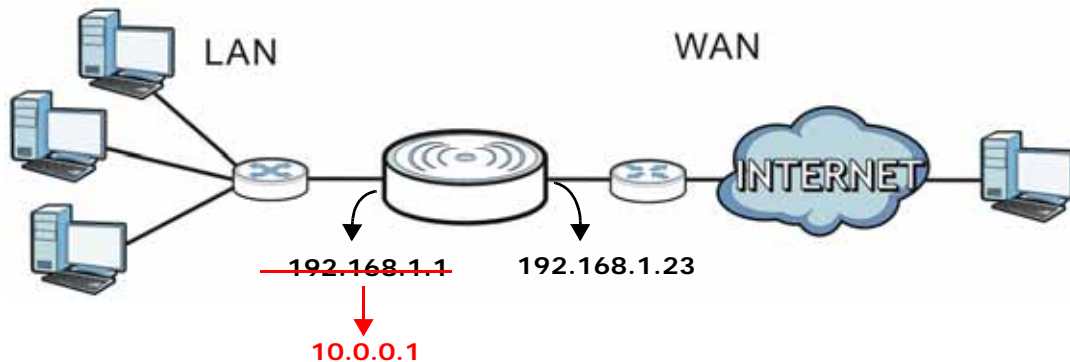

Auto-IP-Change only works under the following conditions:

- The EMG3435-Q20A must be in **Router Mode** (see [Section 15.12 on page 157](#) for more information) for Auto-IP-Change to become active.
- The EMG3435-Q20A is set to receive a dynamic WAN IP address.

## 10.4 Internet Connection Screen

Use this screen to change your EMG3435-Q20A's Internet access settings. Click **Expert Mode > WAN > Internet Connection**.

### 10.4.1 IPoE Encapsulation

This screen displays when you select **IPoE** encapsulation.

Figure 55 Expert Mode &gt; WAN &gt; Internet Connection: IPoE Encapsulation (IPv4 Only)

Internet Connection		Apply	Cancel
<b>ISP Parameters for Internet Access</b>			
Encapsulation :	IPoE ▼		
IPv4 / IPv6 :	IPv4 Only ▼		
<b>IP Address</b>			
<input checked="" type="radio"/> Obtain an IP Address Automatically(DHCP) <input type="radio"/> Static IP Address			
IP Address :	<input type="text"/>		
Subnet Mask :	<input type="text"/>		
Default Gateway :	<input type="text"/>		
MTU Size :	1500		
<b>DNS Server</b>			
First DNS Server :	Obtained From ISP ▼	<input type="text"/>	
Second DNS Server :	Obtained From ISP ▼	<input type="text"/>	
Third DNS Server :	Obtained From ISP ▼	<input type="text"/>	
<b>WAN MAC Address</b>			
<input checked="" type="radio"/> Factory default <input type="radio"/> Clone the computer's MAC address - IP Address <input type="text"/> <input type="radio"/> Set WAN MAC Address <input type="text"/>			
<b>IPv6 Tunneling</b>			
IPv6 Tunneling :	6RD ▼		
<input type="radio"/> Automatically configured by DHCP <input checked="" type="radio"/> Manually Configured			
Border Relay IPv4 Address:	<input type="text"/>		
Service Provider IPv6 Prefix:	<input type="text"/>		
Service Provider IPv6 Prefix length:	32	32-64	
IPv4 mask length:	0	0-32	
<b>IPv6 DNS Server</b>			
First DNS Server :	<input type="text"/>		
Second DNS Server :	<input type="text"/>		
Third DNS Server :	<input type="text"/>		
<b>Multicast Setup</b>			
Multicast Setup :	IGMPv1/v2 ▼		
<b>Auto-Subnet Configuration</b>			
<input checked="" type="checkbox"/> Enable Auto-IP-Change Mode			

The following table describes the labels in this screen.

Table 19 Network > WAN > Internet Connection: IPoE Encapsulation

LABEL	DESCRIPTION
ISP Parameters for Internet Access	
Encapsulation	You must choose the <b>IPoE</b> option when the WAN port is used as a regular Ethernet.
IPv4 / IPv6	Select <b>IPv4 Only</b> if you want the EMG3435-Q20A to run IPv4 only. Select <b>Dual Stack</b> to allow the EMG3435-Q20A to run IPv4 and IPv6 at the same time. Select <b>IPv6 Only</b> if you want the EMG3435-Q20A to run IPv6 only.
IP Address	
Obtain an IP Address Automatically (DHCP)	Select this option If your ISP did not assign you a fixed IP address. This is the default selection.
Static IP Address	Select this option If the ISP assigned a fixed IP address.
IP Address	Enter your WAN IP address in this field if you selected <b>Static IP Address</b> .
Subnet Mask	Enter the <b>Subnet Mask</b> in this field.
Default Gateway	Enter a gateway IP address (if your ISP gave you one) in this field.
MTU Size	Enter the MTU (Maximum Transmission Unit) size for each packet. If a larger packet arrives, the EMG3435-Q20A divides it into smaller fragments.
DNS Server	
First DNS Server	Select <b>Obtained From ISP</b> if your ISP dynamically assigns DNS server information (and the EMG3435-Q20A's WAN IP address). The field to the right displays the (read-only) DNS server IP address that the ISP assigns.  Select <b>User-Defined</b> if you have the IP address of a DNS server. Enter the DNS server's IP address in the field to the right.  Select <b>None</b> if you do not want to configure DNS servers. If you do not configure a DNS server, you must know the IP address of a computer in order to access it.
Second DNS Server	
Third DNS Server	
WAN MAC Address	
Once the WAN MAC address is successfully configured, the address will be copied to the configuration file. It will not change unless you change the setting or upload a different configuration file.	
Factory default	Select this option to have the WAN interface use the factory assigned default MAC address. By default, the EMG3435-Q20A uses the factory assigned MAC address to identify itself.
Clone the computer's MAC address - IP Address	Select this option to have the WAN interface use a different MAC address by cloning the MAC address of another device or computer. Enter the IP address of the device or computer whose MAC you are cloning.
Set WAN MAC Address	Select this option to have the WAN interface use a manually specified MAC address. Enter the MAC address in the fields.
IPv6 Tunneling	
Use IPv6 tunneling when the local network uses IPv6 and the ISP has an IPv4 network. When the EMG3435-Q20A has an IPv4 WAN address and you set <b>IPv4/IPv6</b> mode to <b>IPv4 Only</b> , you can enable IPv6 tunneling to encapsulate IPv6 packets in IPv4 packets to cross the ISP's IPv4 network.	

Table 19 Network &gt; WAN &gt; Internet Connection: IPoE Encapsulation (continued)

LABEL	DESCRIPTION
IPv6 Tunneling	<p>Select <b>None</b> to not allow IPv6 packets to cross IPv4 networks.</p> <p>Select <b>6RD</b> to enable 6RD. IPv6 Rapid Deployment (6RD) is an IPv6 transitioning process for stateless tunneling of IPv6 over IPv4. Enable 6RD to allow tunneling across an ISP's IPv4 only access network.</p> <p>Select <b>6to4</b> to transmit IPv6 packets over an IPv4 network. A 6to4 relay router is required to route 6to4 packets to a native IPv6 network.</p> <p>Select <b>6in4</b> if the EMG3435-Q20A has a public IPv4 address and you want to transmit your IPv6 packets to one and only one remote site whose LAN network is also an IPv6 network. You must know the WAN IP address of the remote gateway.</p>
6RD	<p>The EMG3435-Q20A generates a global IPv6 prefix from its IPv4 WAN address and tunnels IPv6 traffic to the ISP's Border Relay router to connect to the native IPv6 Internet. The local network can also use IPv4 services. The EMG3435-Q20A uses its configured IPv4 WAN IP to route IPv4 traffic to the IPv4 Internet.</p> <p>This is available only when you select <b>IPv4 Only</b> in the <b>IPv4/IPv6</b> field.</p>
Automatically configured by DHCP	Select this to have the EMG3435-Q20A detect the relay server's IP address automatically through DHCP.
Manually Configured	Select this if you have the IPv4 address of the relay server.
Border Relay IPv4 Address	Specify the relay server's IPv4 address.
Service Provider IPv6 Prefix	Enter an IPv6 prefix for tunneling IPv6 traffic to the ISP's Border Relay router and connecting to the native IPv6 Internet.
Service Provider IPv6 Prefix length	<p>Enter the IPv6 prefix length.</p> <p>An IPv6 prefix length specifies how many most significant bits (starting from the left) in the address compose the network address.</p>
IPv4 mask length	Enter the subnet mask number (1~32) for the IPv4 network.
6to4	<p>The EMG3435-Q20A should get a public IPv4 address for the WAN. The EMG3435-Q20A adds an IPv4 IP header to an IPv6 packet when transmitting the packet to the Internet. In reverse, the EMG3435-Q20A removes the IPv4 header from an IPv6 packet when receiving it from the Internet.</p> <p>This is available only when you select <b>IPv4 Only</b> in the <b>IPv4/IPv6</b> field.</p>
Relay Server IPv4 Address	Enter the IPv4 address of a 6to4 relay server which helps forward packets between 6to4 networks and native IPv6 networks.
6in4	<p>The EMG3435-Q20A encapsulates IPv6 packets within IPv4 packets across the Internet. You must know the WAN IP address of the remote gateway device. This mode is normally used for a site-to-site application such as two branch offices.</p> <p>This is available only when you select <b>IPv4 Only</b> in the <b>IPv4/IPv6</b> field.</p>
Remote IPv4 Address	Enter the IPv4 address of the remote gateway to which this interface tunnels traffic.
Remote IPv6 Address	Enter the IPv6 address of the remote gateway to which this interface tunnels traffic.
Local IPv6 Address	Enter the IPv6 address assigned by your ISP.
IPv6 Prefix	Enter the IPv6 prefix for this interface if you want to use a static IP address.
IPv6 DNS Server	This is available only when you select <b>IPv4 Only</b> in the <b>IPv4/IPv6</b> field and set <b>IPv6 Tunneling</b> to <b>6RD</b> , <b>6in4</b> or <b>6to4</b> .

Table 19 Network &gt; WAN &gt; Internet Connection: IPoE Encapsulation (continued)

LABEL	DESCRIPTION
First DNS Server Second DNS Server Third DNS Server	Specify the DNS server IPv6 address assigned by the ISP.
IPv6 Address This section is NOT available when you select <b>IPv4 Only</b> in the <b>IPv4/IPv6</b> field.	
Obtain an IP Address Automatically(DHCP )	<p>Select this option if you want to obtain an IPv6 address from a DHCPv6 server.</p> <ul style="list-style-type: none"> <li>• Select <b>DUID-LL (Default)</b> to have the EMG3435-Q20A use DUID-LL (DUID Based on Link-layer Address) for identification when exchanging DHCPv6 messages.</li> <li>• Select <b>DUID-LLT</b> to have the EMG3435-Q20A use DUID-LLT (DUID Based on Link-layer Address Plus Time) for identification when exchanging DHCPv6 messages.</li> </ul>
Static IP Address	Select this option if you have a fixed IPv6 address assigned by your ISP.
IPv6 Address	Enter the IPv6 address assigned by your ISP.
Prefix length	Enter the address prefix length to specify how many most significant bits in an IPv6 address compose the network address.
IPv6 Default Gateway	Enter the IPv6 address of the next-hop gateway. The gateway helps forward packets to their destinations.
Link Local Only	Select this option to use the link-local address which uniquely identifies a device on the local network (the LAN).
IPv6 DNS Server This is available only when you select <b>Dual Stack</b> or <b>IPv6 Only</b> in the <b>IPv4/IPv6</b> field.	
First DNS Server Second DNS Server Third DNS Server	<p>Select <b>Obtained From ISP</b> to have the EMG3435-Q20A get the IPv6 DNS server addresses from the ISP automatically.</p> <p>Select <b>User-Defined</b> and enter the IPv6 DNS server address assigned by the ISP to have the EMG3435-Q20A use the IPv6 DNS server addresses you configure manually.</p> <p>Select <b>None</b> if you do not want to configure DNS servers. If you do not configure a DNS server, you must know the IPv6 address of a computer in order to access it.</p>
Multicast Setup	
Multicast Setup	<p>Select <b>IGMPv1/v2</b> to enable multicasting. This applies to traffic routed from the WAN to the LAN.</p> <p>Select <b>None</b> to disable this feature. This may cause incoming traffic to be dropped or sent to all connected network devices.</p>
Auto-Subnet Configuration	
Enable Auto-IP-Change Mode	<p>Select this option to have the EMG3435-Q20A change its LAN IP address to 10.0.0.1 or 192.168.1.1 accordingly when the EMG3435-Q20A gets a dynamic WAN IP address in the same subnet as the LAN IP address.</p> <p>Select this option to have the EMG3435-Q20A change its LAN IP address to 10.0.0.1 or 192.168.1.1 accordingly when the EMG3435-Q20A gets a DNS server IP address in the same subnet as the LAN IP address.</p> <p>The NAT, DHCP server and firewall functions on the EMG3435-Q20A are still available in this mode.</p>
Apply	Click <b>Apply</b> to save your changes back to the EMG3435-Q20A.
Cancel	Click <b>Cancel</b> to begin configuring this screen afresh.

## 10.4.2 PPPoE Encapsulation

The EMG3435-Q20A supports PPPoE (Point-to-Point Protocol over Ethernet). PPPoE is an IETF standard (RFC 2516) specifying how a personal computer (PC) interacts with a broadband modem (DSL, cable, wireless, etc.) connection. The **PPP over Ethernet** option is for a dial-up connection using PPPoE.

For the service provider, PPPoE offers an access and authentication method that works with existing access control systems (for example Radius).

One of the benefits of PPPoE is the ability to let you access one of multiple network services, a function known as dynamic service selection. This enables the service provider to easily create and offer new IP services for individuals.

Operationally, PPPoE saves significant effort for both you and the ISP or carrier, as it requires no specific configuration of the broadband modem at the customer site.

By implementing PPPoE directly on the EMG3435-Q20A (rather than individual computers), the computers on the LAN do not need PPPoE software installed, since the EMG3435-Q20A does that part of the task. Furthermore, with NAT, all of the LANs' computers will have access.



This screen displays when you select **PPPoE** encapsulation.

**Figure 56** Network > WAN > Internet Connection: PPPoE Encapsulation (IPv4 Only)

Internet Connection		Apply	Cancel
<b>ISP Parameters for Internet Access</b>			
Encapsulation :	PPPoE ▼		
IPv4 / IPv6 :	IPv4 Only ▼		
<b>PPP Information</b>			
PPP Username :	<input type="text"/>		
PPP Password :	<input type="password"/>		
MTU Size :	1454		
PPP Auto Connect :	<input checked="" type="checkbox"/>		
IDLE Timeout [second] :	300		
PPPoE Service Name :	<input type="text"/>		
<b>WAN IP Address Assignment</b>			
<input type="radio"/> Get automatically from ISP			
<input checked="" type="radio"/> Use Fixed IP Address <input type="text"/>			
<b>DNS Server</b>			
First DNS Server :	User-Defined ▼	<input type="text"/>	
Second DNS Server :	User-Defined ▼	<input type="text"/>	
Third DNS Server :	User-Defined ▼	<input type="text"/>	
<b>WAN MAC Address</b>			
<input checked="" type="radio"/> Factory default			
<input type="radio"/> Clone the computer's MAC address - IP Address <input type="text"/>			
<input type="radio"/> Set WAN MAC Address <input type="text"/>			
<b>IPv6 Tunneling</b>			
IPv6 Tunneling :	6in4 ▼		
Remote IPv4 Address:	<input type="text"/>		
Remote IPv6 Address:	<input type="text"/>		
Local IPv6 Address:	<input type="text"/>		
IPv6 Prefix:	<input type="text"/>		
<b>IPv6 DNS Server</b>			
First DNS Server :	<input type="text"/>		
Second DNS Server :	<input type="text"/>		
Third DNS Server :	<input type="text"/>		
<b>Multicast Setup</b>			
Multicast Setup :	IGMPv1/v2 ▼		
<b>Auto-Subnet Configuration</b>			
<input checked="" type="checkbox"/> Enable Auto-IP-Change Mode			

The following table describes the labels in this screen.

Table 20 Network > WAN > Internet Connection: PPPoE Encapsulation

LABEL	DESCRIPTION
ISP Parameters for Internet Access	
Encapsulation	Select <b>PPPoE</b> if you connect to your Internet via dial-up.
IPv4 / IPv6	Select <b>IPv4 Only</b> if you want the EMG3435-Q20A to run IPv4 only. Select <b>Dual Stack</b> to allow the EMG3435-Q20A to run IPv4 and IPv6 at the same time. Select <b>IPv6 Only</b> if you want the EMG3435-Q20A to run IPv6 only.
PPP Information	
PPP Username	Type the user name given to you by your ISP.
PPP Password	Type the password associated with the user name above.
MTU Size	Enter the Maximum Transmission Unit (MTU) or the largest packet size per frame that your EMG3435-Q20A can receive and process.
PPP Auto Connect	Select this option if you do not want the connection to time out.
IDLE Timeout (second)	This value specifies the time in seconds that elapses before the router automatically disconnects from the PPPoE server.
PPPoE Service Name	Enter the PPPoE service name specified in the ISP account.
WAN IP Address Assignment	
Get automatically from ISP	Select this option if your ISP did not assign you a fixed IP address. This is the default selection.
Use Fixed IP Address	Select this option and enter your WAN IP address if the ISP assigned a fixed IP address.
DNS Server	
First DNS Server	Select <b>Obtained From ISP</b> if your ISP dynamically assigns DNS server information (and the EMG3435-Q20A's WAN IP address). The field to the right displays the (read-only) DNS server IP address that the ISP assigns.  Select <b>User-Defined</b> if you have the IP address of a DNS server. Enter the DNS server's IP address in the field to the right.  Select <b>None</b> if you do not want to configure DNS servers. If you do not configure a DNS server, you must know the IP address of a computer in order to access it.
Second DNS Server	
Third DNS Server	
WAN MAC Address	
The MAC address section allows users to configure the WAN port's MAC address by using the EMG3435-Q20A's MAC address, copying the MAC address from a computer on your LAN or manually entering a MAC address.	
Factory default	Select <b>Factory default</b> to use the factory assigned default MAC Address.
Clone the computer's MAC address - IP Address	Select <b>Clone the computer's MAC address - IP Address</b> and enter the IP address of the computer on the LAN whose MAC you are cloning.
Set WAN MAC Address	Select this option and enter the MAC address you want to use.
IPv6 Tunneling	
Use IPv6 tunneling when the local network uses IPv6 and the ISP has an IPv4 network. When the EMG3435-Q20A has an IPv4 WAN address and you set <b>IPv4/IPv6</b> mode to <b>IPv4 Only</b> , you can enable IPv6 tunneling to encapsulate IPv6 packets in IPv4 packets to cross the ISP's IPv4 network.	

Table 20 Network &gt; WAN &gt; Internet Connection: PPPoE Encapsulation (continued)

LABEL	DESCRIPTION
IPv6 Tunneling	<p>Select <b>None</b> to not allow IPv6 packets to cross IPv4 networks.</p> <p>Select <b>6RD</b> to enable 6RD. IPv6 Rapid Deployment (6RD) is an IPv6 transitioning process for stateless tunneling of IPv6 over IPv4. Enable 6RD to allow tunneling across an ISP's IPv4 only access network.</p> <p>Select <b>6to4</b> to transmit IPv6 packets over an IPv4 network. A 6to4 relay router is required to route 6to4 packets to a native IPv6 network.</p> <p>Select <b>6in4</b> if the EMG3435-Q20A has a public IPv4 address and you want to transmit your IPv6 packets to one and only one remote site whose LAN network is also an IPv6 network. You must know the WAN IP address of the remote gateway.</p>
<p><b>6RD</b></p> <p>The EMG3435-Q20A generates a global IPv6 prefix from its IPv4 WAN address and tunnels IPv6 traffic to the ISP's Border Relay router to connect to the native IPv6 Internet. The local network can also use IPv4 services. The EMG3435-Q20A uses its configured IPv4 WAN IP to route IPv4 traffic to the IPv4 Internet.</p> <p>This is available only when you select <b>IPv4 Only</b> in the <b>IPv4/IPv6</b> field.</p>	
Automatically configured by DHCP	Select this to have the EMG3435-Q20A detect the relay server's IP address automatically through DHCP.
Manually Configured	Select this if you have the IPv4 address of the relay server.
Border Relay IPv4 Address	Specify the relay server's IPv4 address.
Service Provider IPv6 Prefix	Enter an IPv6 prefix for tunneling IPv6 traffic to the ISP's Border Relay router and connecting to the native IPv6 Internet.
Service Provider IPv6 Prefix length	<p>Enter the IPv6 prefix length.</p> <p>An IPv6 prefix length specifies how many most significant bits (starting from the left) in the address compose the network address.</p>
IPv4 mask length	Enter the subnet mask number (1~32) for the IPv4 network.
<p><b>6to4</b></p> <p>The EMG3435-Q20A should get a public IPv4 address for the WAN. The EMG3435-Q20A adds an IPv4 IP header to an IPv6 packet when transmitting the packet to the Internet. In reverse, the EMG3435-Q20A removes the IPv4 header from an IPv6 packet when receiving it from the Internet.</p> <p>This is available only when you select <b>IPv4 Only</b> in the <b>IPv4/IPv6</b> field.</p>	
Relay Server IPv4 Address	Enter the IPv4 address of a 6to4 relay server which helps forward packets between 6to4 networks and native IPv6 networks.
<p><b>6in4</b></p> <p>The EMG3435-Q20A encapsulates IPv6 packets within IPv4 packets across the Internet. You must know the WAN IP address of the remote gateway device. This mode is normally used for a site-to-site application such as two branch offices.</p> <p>This is available only when you select <b>IPv4 Only</b> in the <b>IPv4/IPv6</b> field.</p>	
Remote IPv4 Address	Enter the IPv4 address of the remote gateway to which this interface tunnels traffic.
Remote IPv6 Address	Enter the IPv6 address of the remote gateway to which this interface tunnels traffic.
Local IPv6 Address	Enter the IPv6 address assigned by your ISP.
IPv6 Prefix	Enter the IPv6 prefix for this interface if you want to use a static IP address.

Table 20 Network &gt; WAN &gt; Internet Connection: PPPoE Encapsulation (continued)

LABEL	DESCRIPTION
IPv6 DNS Server	This is available only when you select <b>IPv4 Only</b> in the <b>IPv4/IPv6</b> field and set <b>IPv6 Tunneling</b> to <b>6RD</b> , <b>6in4</b> or <b>6to4</b> .
First DNS Server Second DNS Server Third DNS Server	Specify the DNS server IPv6 address assigned by the ISP.
IPv6 DNS Server	This is available only when you select <b>Dual Stack</b> or <b>IPv6 Only</b> in the <b>IPv4/IPv6</b> field.
First DNS Server Second DNS Server Third DNS Server	<p>Select <b>Obtained From ISP</b> to have the EMG3435-Q20A get the IPv6 DNS server addresses from the ISP automatically.</p> <p>Select <b>User-Defined</b> and enter the IPv6 DNS server address assigned by the ISP to have the EMG3435-Q20A use the IPv6 DNS server addresses you configure manually.</p> <p>Select <b>None</b> if you do not want to configure DNS servers. If you do not configure a DNS server, you must know the IPv6 address of a computer in order to access it.</p>
Multicast Setup	<p>Select <b>IGMPv1/v2</b> to enable multicasting. This applies to traffic routed from the WAN to the LAN.</p> <p>Select <b>None</b> to disable this feature. This may cause incoming traffic to be dropped or sent to all connected network devices.</p>
Auto-Subnet Configuration	<p>Select this option to have the EMG3435-Q20A change its LAN IP address to 10.0.0.1 or 192.168.1.1 accordingly when the EMG3435-Q20A gets a dynamic WAN IP address in the same subnet as the LAN IP address.</p> <p>Select this option to have the EMG3435-Q20A change its LAN IP address to 10.0.0.1 or 192.168.1.1 accordingly when the EMG3435-Q20A gets a DNS server IP address in the same subnet as the LAN IP address.</p> <p>The NAT, DHCP server and firewall functions on the EMG3435-Q20A are still available in this mode.</p>
Apply	Click <b>Apply</b> to save your changes back to the EMG3435-Q20A.
Cancel	Click <b>Cancel</b> to begin configuring this screen afresh.

### 10.4.3 PPTP Encapsulation

This screen displays when you select **PPTP** encapsulation.

Figure 57 Expert Mode &gt; WAN &gt; Internet Connection: PPTP Encapsulation (IPv4 Only)

Internet Connection		Apply	Cancel
<b>ISP Parameters for Internet Access</b>			
Encapsulation :	<input type="text" value="PPTP"/>		
IPv4 / IPv6 :	<input type="text" value="IPv4 Only"/>		
<b>PPTP Information</b>			
PPTP Username :	<input type="text"/>		
PPTP Password :	<input type="text"/>		
PPTP Encryption Type :	<input type="text" value="Auto"/>		
MTU Size :	<input type="text" value="1492"/>		
PPTP Auto Connect :	<input checked="" type="checkbox"/>		
IDLE Timeout [second] :	<input type="text" value="300"/>		
<b>PPTP CONFIGURATION</b>			
PPTP Server IP Address :	<input type="text"/>		
<input checked="" type="radio"/> Obtain an IP Address Automatically(DHCP) <input type="radio"/> Static IP Address			
IP Address :	<input type="text"/>		
Subnet Mask :	<input type="text"/>		
Default Gateway :	<input type="text"/>		
<b>WAN IP Address Assignment</b>			
<input checked="" type="radio"/> Get automatically from ISP <input type="radio"/> Use Fixed IP Address			
IP Address :	<input type="text"/>		
<b>DNS Server</b>			
First DNS Server :	<input type="text" value="Obtained From ISP"/>	<input type="text" value="172.21.65.1"/>	
Second DNS Server :	<input type="text" value="Obtained From ISP"/>	<input type="text" value="172.23.5.2"/>	
Third DNS Server :	<input type="text" value="Obtained From ISP"/>	<input type="text"/>	
<b>WAN MAC Address</b>			
<input checked="" type="radio"/> Factory default <input type="radio"/> Clone the computer's MAC address - <input type="text"/> <input type="radio"/> Set WAN MAC Address <input type="text"/>			
<b>IPv6 Tunneling</b>			
IPv6 Tunneling :	<input type="text" value="None"/>		
<b>Multicast Setup</b>			
Multicast Setup :	<input type="text" value="IGMPv1/v2"/>		
<b>Auto-Subnet Configuration</b>			
<input checked="" type="checkbox"/> Enable Auto-IP-Change Mode			

The following table describes the labels in this screen.

Table 21 Network > WAN > Internet Connection: PPTP Encapsulation

LABEL	DESCRIPTION
ISP Parameters for Internet Access	
Encapsulation	Select <b>PPTP</b> if you want to connect the Internet via point to point tunneling protocol.
IPv4 / IPv6	This field is greyed out. The PPTP encapsulation only supports IPv4.
PPTP Information	
PPTP Username	Enter the user name given to you by your ISP.
PPTP Password	Enter the password associated with the user name above.
PPTP Encryption Type	Use the drop-down list box to select the type of Microsoft Point-to-Point Encryption (MPPE). Options are:  <b>Auto</b> - This ISP account adjusts the encryption type automatically.  <b>No Encryption</b> - This ISP account does not use MPPE.  <b>MPPE 40</b> - This ISP account uses 40-bit MPPE.  <b>MPPE 128</b> - This ISP account uses 128-bit MMPE.
MTU Size	Enter the MTU (Maximum Transmission Unit) size for each packet. If a larger packet arrives, the EMG3435-Q20A divides it into smaller fragments.
PPTP Auto Connect	Select this option if you do not want the connection to time out.
IDLE Timeout [second]	Type the time in seconds that elapses before the router automatically disconnects from the PPTP server. 0 means no timeout.
PPTP CONFIGURATION	
PPTP Server IP Address	Enter the IP address of the PPTP server.
Obtain an IP Address Automatically(DHCP )	Select this radio button if the PPTP server did not assign you a fixed IP address.
Static IP Address	Select this radio button if the PPTP server assigned an IP address for your Internet connection.
IP Address	Enter the IP address provided by the PPTP server.
Subnet Mask	Enter the IP subnet mask in this field.
Default Gateway	Enter the gateway IP address in this field.
WAN IP Address Assignment	
Get automatically from ISP	Select this option If your ISP did not assign you a fixed IP address. This is the default selection.
Use Fixed IP Address	Select this option If the ISP assigned a fixed IP address.
IP Address	Enter your WAN IP address in this field if you selected <b>Static IP Address</b> .
DNS Server	
First DNS Server	Select <b>Obtained From ISP</b> if your ISP dynamically assigns DNS server information (and the EMG3435-Q20A's WAN IP address). The field to the right displays the (read-only) DNS server IP address that the ISP assigns.  Select <b>User-Defined</b> if you have the IP address of a DNS server. Enter the DNS server's IP address in the field to the right.  Select <b>None</b> if you do not want to configure DNS servers. If you do not configure a DNS server, you must know the IP address of a computer in order to access it.
Second DNS Server	
Third DNS Server	

Table 21 Network &gt; WAN &gt; Internet Connection: PPTP Encapsulation (continued)

LABEL	DESCRIPTION
WAN MAC Address	Once the WAN MAC address is successfully configured, the address will be copied to the configuration file. It will not change unless you change the setting or upload a different configuration file.
Factory default	Select this option to have the WAN interface use the factory assigned default MAC address. By default, the EMG3435-Q20A uses the factory assigned MAC address to identify itself.
Clone the computer's MAC address	Select this option to have the WAN interface use a different MAC address by cloning the MAC address of another device or computer. Enter the IP address of the device or computer whose MAC you are cloning.
Set WAN MAC Address	Select this option to have the WAN interface use a manually specified MAC address. Enter the MAC address in the fields.
Multicast Setup	
Multicast Setup	Select <b>IGMPv1/v2</b> to enable multicasting. This applies to traffic routed from the WAN to the LAN.  Select <b>None</b> to disable this feature. This may cause incoming traffic to be dropped or sent to all connected network devices.
Auto-Subnet Configuration	
Enable Auto-IP-Change Mode	Select this option to have the EMG3435-Q20A change its LAN IP address to 10.0.0.1 or 192.168.1.1 accordingly when the EMG3435-Q20A gets a dynamic WAN IP address in the same subnet as the LAN IP address.  Select this option to have the EMG3435-Q20A change its LAN IP address to 10.0.0.1 or 192.168.1.1 accordingly when the EMG3435-Q20A gets a DNS server IP address in the same subnet as the LAN IP address.  The NAT, DHCP server and firewall functions on the EMG3435-Q20A are still available in this mode.
Apply	Click <b>Apply</b> to save your changes back to the EMG3435-Q20A.
Cancel	Click <b>Cancel</b> to begin configuring this screen afresh.

## 10.5 NAT

Use this screen to change your EMG3435-Q20A's NAT (Network Address Translation) settings. Click **Expert Mode > WAN > NAT**.

### 10.5.1 General Screen

Use this screen to enable NAT, set a default server and configure your EMG3435-Q20A's port forwarding settings to forward incoming service requests to the server(s) on your local network. Click **Expert Mode > WAN > NAT > General**.

Figure 58 Expert Mode &gt; WAN &gt; NAT &gt; General

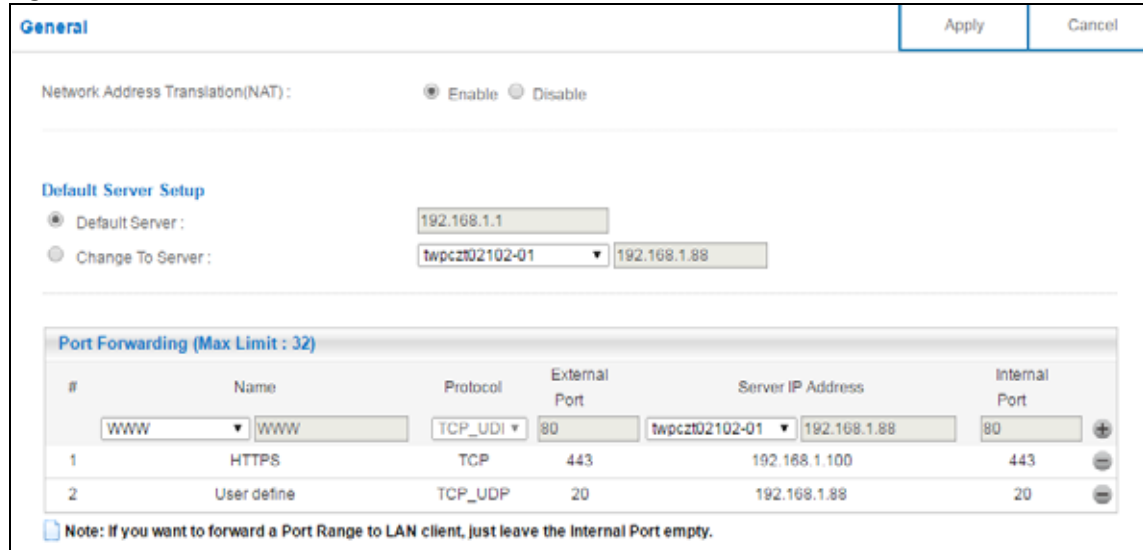

**General** Apply Cancel

Network Address Translation(NAT):  Enable  Disable

**Default Server Setup**

Default Server: 192.168.1.1

Change To Server: twpcz02102-01 192.168.1.88

**Port Forwarding (Max Limit : 32)**

#	Name	Protocol	External Port	Server IP Address	Internal Port
	WWW	TCP_UDP	80	twpcz02102-01 192.168.1.88	80
1	HTTPS	TCP	443	192.168.1.100	443
2	User define	TCP_UDP	20	192.168.1.88	20

Note: If you want to forward a Port Range to LAN client, just leave the Internal Port empty.

The following table describes the labels in this screen.

Table 22 Expert Mode &gt; WAN &gt; NAT &gt; General

LABEL	DESCRIPTION
General	
Network Address Translation (NAT)	Network Address Translation (NAT) allows the translation of an Internet protocol address used within one network (for example a private IP address used in a local network) to a different IP address known within another network (for example a public IP address used on the Internet).  Select <b>Enable</b> to activate NAT. Select <b>Disable</b> to turn it off.
Default Server Setup	
Default Server	You can decide whether you want to use the default server or specify a server manually. In addition to the servers for specified services, NAT supports a default server. A default server receives packets from ports that are not specified in the port forwarding summary table below.  Select this to use the default server.
Change To Server	Select this and manually enter the server's IP address.
Port Forwarding (Max Limit : 32)	
#	This is the number of an individual port forwarding server entry.
Name	Select a pre-defined service from the drop-down list box. The pre-defined service port number(s) and protocol will be displayed in the port forwarding summary table. Otherwise, select <b>User define</b> to manually enter the port number/range and select the <b>Protocol</b> .
Protocol	Select the transport layer protocol supported by this virtual server. Choices are <b>TCP</b> , <b>UDP</b> , or <b>TCP_UDP</b> .  If you have chosen a pre-defined service in the <b>Name</b> field, the protocol will be configured automatically.
External Port	This shows the port number(s) that identifies the service if you select a pre-defined service. If you select <b>User define</b> in the <b>Name</b> field, enter the port number(s) manually.
Server IP Address	Select <b>User define</b> to manually enter the inside IP address of the virtual server here.
Internal Port	This shows the port number(s) that identifies the service if you select a pre-defined service. If you select <b>User define</b> in the <b>Name</b> field, enter an internal port number manually or leave the field blank for port range forwarding.



Table 22 Expert Mode &gt; WAN &gt; NAT &gt; General (continued)

LABEL	DESCRIPTION
Add	Click <b>+</b> to add the rule in the port forwarding summary table.
Delete	Click <b>-</b> to remove a rule.
Apply	Click <b>Apply</b> to save your changes back to the EMG3435-Q20A.
Cancel	Click <b>Cancel</b> to begin configuring this screen afresh.

## 10.5.2 Port Trigger Screen

To change your EMG3435-Q20A's trigger port settings, click **Expert Mode > WAN > NAT > Port Trigger**. The screen appears as shown.

Note: Only one LAN computer can use a trigger port (range) at a time.

Figure 59 Expert Mode &gt; WAN &gt; NAT &gt; Port Trigger

The following table describes the labels in this screen.

Table 23 Expert Mode &gt; WAN &gt; NAT &gt; Port Trigger

LABEL	DESCRIPTION
Port Trigger Rules (Max Limit : 32)	
#	This is the rule index number (read-only).
Name	Type a unique name (up to 15 characters) for identification purposes. All characters are permitted - including spaces.
Incoming Port	Incoming is a port (or a range of ports) that a server on the WAN uses when it sends out a particular service. The EMG3435-Q20A forwards the traffic with this port (or range of ports) to the client computer on the LAN that requested the service. Type a port number or the starting port number in a range of port numbers.
End Port	Type a port number or the ending port number in a range of port numbers.
Trigger Port	The trigger port is a port (or a range of ports) that causes (or triggers) the EMG3435-Q20A to record the IP address of the LAN computer that sent the traffic to a server on the WAN. Type a port number or the starting port number in a range of port numbers.
End Port	Type a port number or the ending port number in a range of port numbers.
Add	Click <b>+</b> to add the rule in the port trigger summary table.
Delete	Click <b>-</b> to remove a rule.
Apply	Click <b>Apply</b> to save your changes back to the EMG3435-Q20A.
Cancel	Click <b>Cancel</b> to begin configuring this screen afresh.

## 10.5.3 Passthrough Screen

## ALG Overview

Application Layer Gateway (ALG) allows the following applications to operate properly through the EMG3435-Q20A's NAT.

- SIP - Session Initiation Protocol (SIP) - An application-layer protocol that can be used to create voice and multimedia sessions over Internet.
- H.323 - A teleconferencing protocol suite that provides audio, data and video conferencing.
- FTP - File Transfer Protocol - an Internet file transfer service.
- SNMP - Simple Network Management Protocol - An application-layer protocol that can be used to exchange management information between network devices.
- RTSP - Real Time Streaming Protocol - An application-layer protocol that can be used to stop, pause or play video and audio applications streaming on the Internet.
- IRC - Internet Relay Chat - An application-layer protocol that can control the relay chat applications and allow clients to have real-time communications with others on the Internet.

The ALG feature is only needed for traffic that goes through the EMG3435-Q20A's NAT.

To change your EMG3435-Q20A's ALGs and VPN pass-through settings, click **Expert Mode > WAN > NAT > Passthrough**. The screen appears as shown.

**Figure 60** Expert Mode > WAN > NAT > Passthrough

**Passthrough** Apply Cancel

**ALG Setup :**

FTP :  Enable  Disable

H.323 :  Enable  Disable

SIP :  Enable  Disable

SNMP :  Enable  Disable

RTSP :  Enable  Disable

IRC :  Enable  Disable

---

**VPN Passthrough :**

PPTP :  Enable  Disable

L2TP :  Enable  Disable

IPSEC :  Enable  Disable

The following table describes the labels in this screen.

**Table 24** Expert Mode > WAN > NAT > Passthrough

LABEL	DESCRIPTION
ALG Setup	
FTP	Select <b>Enable</b> to allow TCP packets with a specified port destination to pass through.
H.323	Select <b>Enable</b> to allow peer-to-peer H.323 calls.
SIP	Select <b>Enable</b> to make sure SIP (VoIP) works correctly with port-forwarding and address-mapping rules.
SNMP	Select <b>Enable</b> to allow a manager station to manage and monitor the EMG3435-Q20A through the network via SNMP.

Table 24 Expert Mode &gt; WAN &gt; NAT &gt; Passthrough (continued)

LABEL	DESCRIPTION
RTSP	Select <b>Enable</b> to have the EMG3435-Q20A detect RTSP traffic and help build RTSP sessions through its NAT.
IRC	Select <b>Enable</b> to allow clients to have real-time communications with others on the Internet.
VPN Passthrough	
PPTP	Select <b>Enable</b> to allow VPN clients to make outbound PPTP connections. It is required in order to connect to a PPTP VPN account. If <b>PPTP</b> is disabled, then when a client sends a request to a VPN server, the server will reply to the EMG3435-Q20A and the EMG3435-Q20A will drop the request. When <b>PPTP</b> is enabled, the EMG3435-Q20A will forward the reply from the VPN server to the client that initiated the request, and the connection will establish successfully.
L2TP	Select <b>Enable</b> to allow VPN clients to make outbound L2TP connections. It is required in order to connect to a L2TP VPN account. If <b>L2TP</b> is disabled, then when a client sends a request to a VPN server, the server will reply to the EMG3435-Q20A and the EMG3435-Q20A will drop the request. When <b>L2TP</b> is enabled, the EMG3435-Q20A will forward the reply from the VPN server to the client that initiated the request, and the connection will establish successfully.
IPSEC	Select <b>Enable</b> to allow VPN clients to make outbound IPsec connections. It is required in order to connect to a IPsec VPN account. If <b>IPSEC</b> is disabled, then when a client sends a request to a VPN server, the server will reply to the EMG3435-Q20A and the EMG3435-Q20A will drop the request. When <b>IPSEC</b> is enabled, the EMG3435-Q20A will forward the reply from the VPN server to the client that initiated the request, and the connection will establish successfully.
Apply	Click <b>Apply</b> to save your changes back to the EMG3435-Q20A.
Cancel	Click <b>Cancel</b> to begin configuring this screen afresh.

## 10.6 Dynamic DNS Screen

To change your EMG3435-Q20A's DDNS, click **Expert Mode > WAN > Dynamic DNS**. The screen appears as shown.

Figure 61 Expert Mode &gt; WAN &gt; Dynamic DNS

**Dynamic DNS** [Apply] [Cancel]

**Dynamic DNS Setup**

DNS maps a domain name to a corresponding IP address and vice versa. Similarly, Dynamic DNS (DDNS) maps a domain name to a dynamic IP address. With DDNS, you can use a domain name to access your ZyXEL device and home network regardless of the device's current (dynamic) IP address. The ZyXEL device must have a public WAN IP address to use Dynamic DNS.

Register at <https://mycloud.zyxel.com/> and get a free accessible-from-anywhere network name as well as other ZyXEL services.

Dynamic DNS :  Enable  Disable

Service Provider :  [DynDNS](#)

Host Name :

Username :

Password :

The following table describes the labels in this screen.

Table 25 Expert Mode > WAN > Dynamic DNS

LABEL	DESCRIPTION
Dynamic DNS Setup	
Dynamic DNS	Select <b>Enable</b> to use dynamic DNS. Select <b>Disable</b> to turn this feature off.
Service Provider	Select the name of your Dynamic DNS service provider.
Host Name	Enter a host names in the field provided. You can specify up to two host names in the field separated by a comma (",").
Username	Enter your user name.
Password	Enter the password assigned to you.
Apply	Click <b>Apply</b> to save your changes back to the EMG3435-Q20A.
Cancel	Click <b>Cancel</b> to begin configuring this screen afresh.

# CHAPTER 11

## Wireless LAN

### 11.1 Overview

This chapter discusses how to configure the wireless network settings in your EMG3435-Q20A. The EMG3435-Q20A is able to function both 2.4GHz and 5GHz network at the same time. You can have different wireless and wireless security settings for 2.4GHz and 5GHz wireless LANs. Click **Expert Mode > Wireless** to configure **wireless LAN 2.4G** or **wireless LAN 5G**.

See the appendices for more detailed information about wireless networks.

The following figure provides an example of a wireless network.

**Figure 62** Example of a Wireless Network

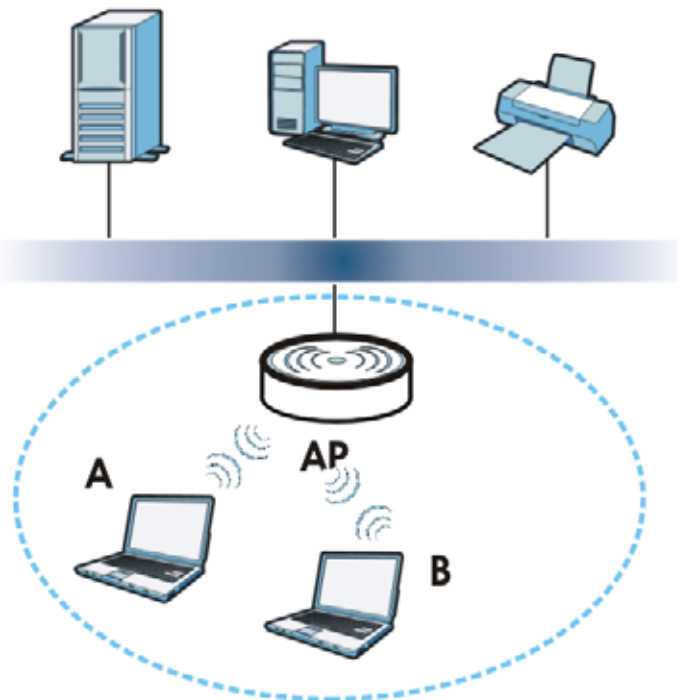

The wireless network is the part in the blue circle. In this wireless network, devices **A** and **B** are called wireless clients. The wireless clients use the access point (AP) to interact with other devices (such as the printer) or with the Internet. Your EMG3435-Q20A is the AP.

## 11.1.1 What You Can Do

- Use the **Wireless** screen to enable or disable the 2.4GHz or 5GHz wireless LAN, set up wireless security between the EMG3435-Q20A and the wireless clients, and make other basic configuration changes ([Section 11.2 on page 97](#)).
- Use the **Guest Wireless** screen to set up multiple wireless networks on your EMG3435-Q20A ([Section 11.4 on page 104](#)).
- Use the **MAC Filter** screen to allow or deny wireless stations based on their MAC addresses from connecting to the EMG3435-Q20A ([Section 11.5 on page 106](#)).
- Use the **Advanced** screen to allow intra-BSS networking and set the RTS/CTS Threshold ([Section 11.6 on page 107](#)).
- Use the **WPS** screen to quickly set up a wireless network with strong security, without having to configure security settings manually ([Section 11.7 on page 109](#)).
- Use the **Scheduling** screen to set the times your wireless LAN is turned on and off ([Section 11.8 on page 110](#)).

## 11.1.2 What You Should Know

Every wireless network must follow these basic guidelines.

- Every wireless client in the same wireless network must use the same SSID.  
The SSID is the name of the wireless network. It stands for Service Set IDentity.
- If two wireless networks overlap, they should use different channels.  
Like radio stations or television channels, each wireless network uses a specific channel, or frequency, to send and receive information.
- Every wireless client in the same wireless network must use security compatible with the AP.  
Security stops unauthorized devices from using the wireless network. It can also protect the information that is sent in the wireless network.

### Wireless Security Overview

The following sections introduce different types of wireless security you can set up in the wireless network.

#### SSID

Normally, the AP acts like a beacon and regularly broadcasts the SSID in the area. You can hide the SSID instead, in which case the AP does not broadcast the SSID. In addition, you should change the default SSID to something that is difficult to guess.

This type of security is fairly weak, however, because there are ways for unauthorized devices to get the SSID. In addition, unauthorized devices can still see the information that is sent in the wireless network.

#### MAC Address Filter

Every wireless client has a unique identification number, called a MAC address.<sup>1</sup> A MAC address is usually written using twelve hexadecimal characters<sup>2</sup>; for example, 00A0C5000002 or 00:A0:C5:00:00:02.

1. Some wireless devices, such as scanners, can detect wireless networks but cannot use wireless networks. These kinds of wireless devices might not have MAC addresses.

To get the MAC address for each wireless client, see the appropriate User's Guide or other documentation.

You can use the MAC address filter to tell the AP which wireless clients are allowed or not allowed to use the wireless network. If a wireless client is allowed to use the wireless network, it still has to have the correct settings (SSID, channel, and security). If a wireless client is not allowed to use the wireless network, it does not matter if it has the correct settings.

This type of security does not protect the information that is sent in the wireless network. Furthermore, there are ways for unauthorized devices to get the MAC address of an authorized wireless client. Then, they can use that MAC address to use the wireless network.

## User Authentication

You can make every user log in to the wireless network before they can use it. This is called user authentication. However, every wireless client in the wireless network has to support IEEE 802.1x to do this.

For wireless networks, there are two typical places to store the user names and passwords for each user.

- In the AP: this feature is called a local user database or a local database.
- In a RADIUS server: this is a server used in businesses more than in homes.

If your AP does not provide a local user database and if you do not have a RADIUS server, you cannot set up user names and passwords for your users.

Unauthorized devices can still see the information that is sent in the wireless network, even if they cannot use the wireless network. Furthermore, there are ways for unauthorized wireless users to get a valid user name and password. Then, they can use that user name and password to use the wireless network.

Local user databases also have an additional limitation that is explained in the next section.

## Encryption

Wireless networks can use encryption to protect the information that is sent in the wireless network. Encryption is like a secret code. If you do not know the secret code, you cannot understand the message.

The types of encryption you can choose depend on the type of user authentication. (See [page 95](#) for information about this.)

Table 26 Types of Encryption for Each Type of Authentication

	NO AUTHENTICATION	RADIUS SERVER
Weakest	No Security	WPA
↕	WPA-PSK	
Strongest	WPA2-PSK	WPA2

For example, if the wireless network has a RADIUS server, you can choose **WPA** or **WPA2**. If users do not log in to the wireless network, you can choose no encryption, **WPA-PSK**, or **WPA2-PSK**.

2. Hexadecimal characters are 0, 1, 2, 3, 4, 5, 6, 7, 8, 9, A, B, C, D, E, and F.

Usually, you should set up the strongest encryption that every wireless client in the wireless network supports. For example, suppose the AP does not have a local user database, and you do not have a RADIUS server. Therefore, there is no user authentication. Suppose the wireless network has two wireless clients. Device A only supports WPA, and device B supports WPA and WPA2. Therefore, you should set up **WPA** or **WPA-PSK** in the wireless network.

Note: It is recommended that wireless networks use **WPA-PSK**, **WPA**, or stronger encryption. IEEE 802.1x and WEP encryption are better than none at all, but it is still possible for unauthorized devices to figure out the original information pretty quickly.

Note: It is not possible to use **WPA-PSK**, **WPA** or stronger encryption with a local user database. In this case, it is better to set up stronger encryption with no authentication than to set up weaker encryption with the local user database.

When you select **WPA2** or **WPA2-PSK** in your EMG3435-Q20A, you can also select an option (**WPA/WPA-PSK Compatible**) to support WPA/WPA-PSK as well. In this case, if some wireless clients support WPA and some support WPA2, you should set up **WPA2-PSK** or **WPA2** (depending on the type of wireless network login) and select the **WPA/WPA-PSK Compatible** option in the EMG3435-Q20A.

Many types of encryption use a key to protect the information in the wireless network. The longer the key, the stronger the encryption. Every wireless client in the wireless network must have the same key.

## Guest WLAN

Guest WLAN allows you to set up a wireless network where users can access to Internet via the EMG3435-Q20A (**Z**), but not other networks connected to the **Z**. In the following figure, a guest user can access the Internet from the guest wireless network **A** via **Z** but not the home or company network **N**.

Note: The home or company network **N** and Guest WLAN network are independent networks.

Note: Only Router mode supports guest WLAN.

Figure 63 Guest Wireless LAN Network

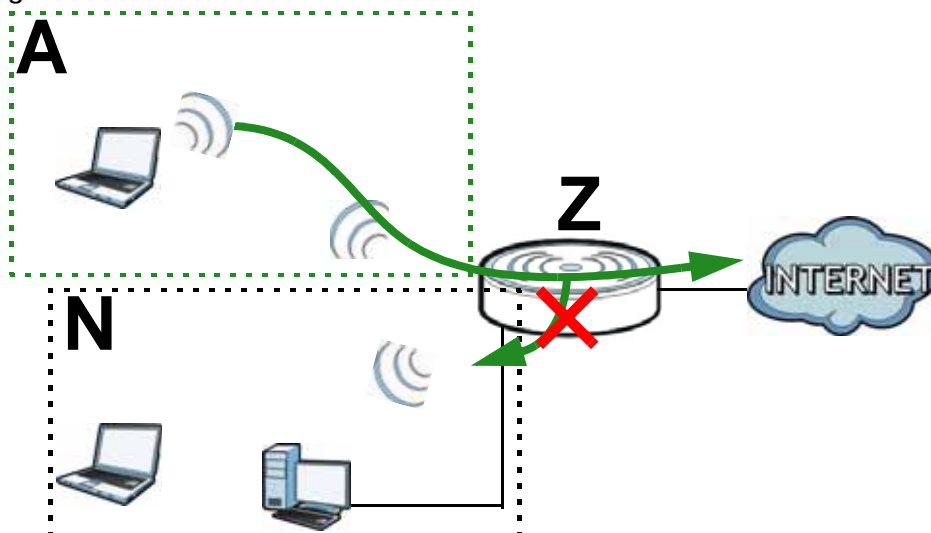



## Guest WLAN Bandwidth

The Guest WLAN Bandwidth function allows you to restrict the maximum bandwidth for the guest wireless network. Additionally, you can also define bandwidth for your home or office network. An example is shown next to define maximum bandwidth for your networks (**A** is Guest WLAN and **N** is home or company network.)

Figure 64 Example: Bandwidth for Different Networks

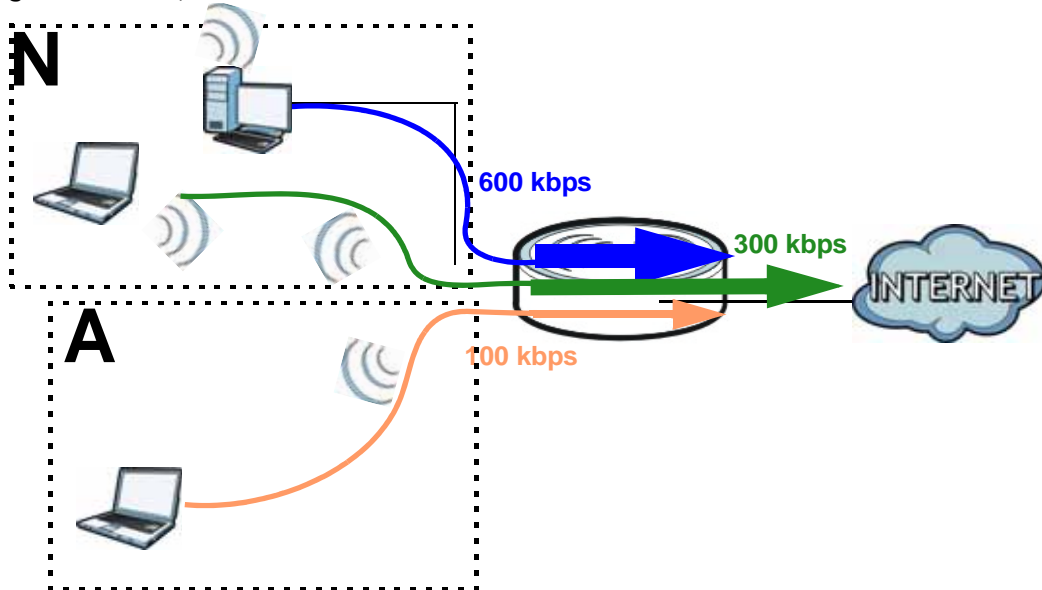

## WPS

WiFi Protected Setup (WPS) is an industry standard specification, defined by the WiFi Alliance. WPS allows you to quickly set up a wireless network with strong security, without having to configure security settings manually. Depending on the devices in your network, you can either press a button (on the device itself, or in its configuration utility) or enter a PIN (Personal Identification Number) in the devices. Then, they connect and set up a secure network by themselves. See how to set up a secure wireless network using WPS in the [Section 8.2 on page 48](#).

## 11.2 Wireless Screen

Use this screen to configure the SSID and wireless security of the EMG3435-Q20A's default wireless LAN.

Note: If you are configuring the EMG3435-Q20A from a computer connected to the wireless LAN and you change the EMG3435-Q20A's SSID, channel or security settings, you will lose your wireless connection when you press **Apply** to confirm. You must then change the wireless settings of your computer to match the EMG3435-Q20A's new settings.

Click **Expert Mode > Wireless**.

Figure 65 Expert Mode &gt; Wireless

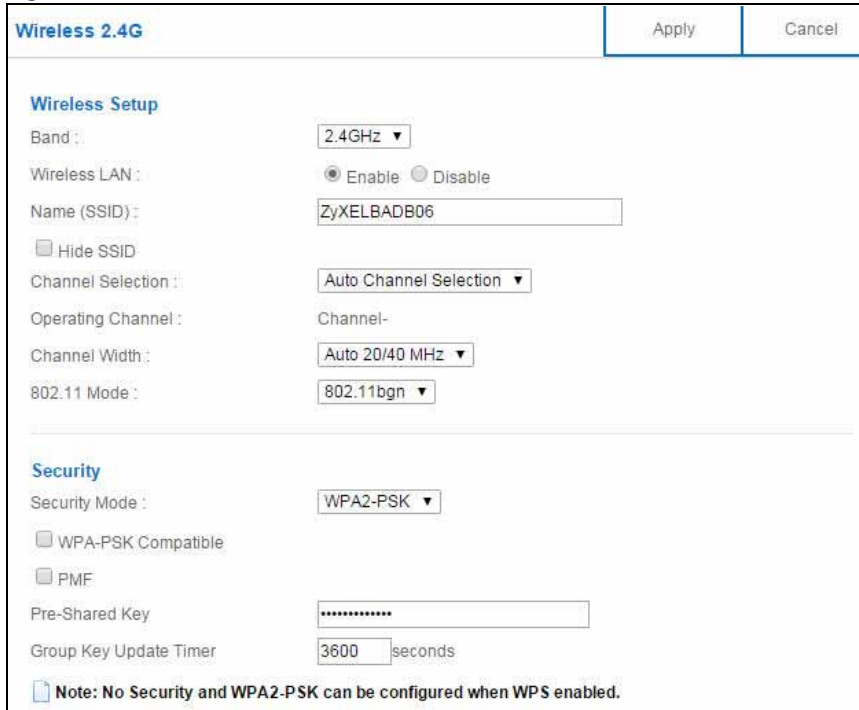

**Wireless 2.4G** Apply Cancel

**Wireless Setup**

Band : 2.4GHz ▾

Wireless LAN :  Enable  Disable

Name (SSID) : ZyXELBADB06

Hide SSID

Channel Selection : Auto Channel Selection ▾

Operating Channel : Channel-

Channel Width : Auto 20/40 MHz ▾

802.11 Mode : 802.11bgn ▾

---

**Security**

Security Mode : WPA2-PSK ▾

WPA-PSK Compatible

PMF

Pre-Shared Key : .....

Group Key Update Timer : 3600 seconds

Note: No Security and WPA2-PSK can be configured when WPS enabled.

The following table describes the general wireless LAN labels in this screen.

Table 27 Expert Mode &gt; Wireless

LABEL	DESCRIPTION
Wireless Setup	
Band	Select the frequency band to set whether you want to apply the wireless and security settings to the default <b>2.4GHz</b> or <b>5GHz</b> wireless LAN.
Wireless LAN	Select <b>Enable</b> to activate the 2.4GHz and/or 5GHz wireless LAN. Select <b>Disable</b> to turn it off. You can enable or disable both 2.4GHz and 5GHz wireless LANs by using the <b>WIFI</b> button located on the rear panel of the EMG3435-Q20A.
Name (SSID)	The SSID (Service Set IDentity) identifies the Service Set with which a wireless client is associated. Enter a descriptive name (up to 32 printable characters found on a typical English language keyboard) for the wireless LAN.
Hide SSID	Select this check box to hide the SSID in the outgoing beacon frame so a station cannot obtain the SSID through scanning using a site survey tool.
Channel Selection	Select a channel from the drop-down list box. The options vary depending on the frequency band and the country you are in. This option is only available if <b>Auto Channel Selection</b> is disabled.
Operating Channel	This displays the channel the EMG3435-Q20A is currently using.

Table 27 Expert Mode &gt; Wireless (continued)

LABEL	DESCRIPTION
Channel Width	<p>Select the wireless channel width used by EMG3435-Q20A.</p> <p>A standard 20MHz channel offers transfer speeds of up to 144Mbps (2.4GHz) or 217Mbps (5GHz) whereas a 40MHz channel uses two standard channels and offers speeds of up to 300Mbps (2.4GHz) or 450Mbps (5GHz). An IEEE 802.11ac-specific 80MHz channel offers speeds of up to 1.3 Gbps.</p> <p>The following are available only when you set <b>Band</b> to <b>2.4GHz</b>.</p> <p>Because not all devices support 40 MHz channels, select <b>Auto 20/40MHz</b> to allow the EMG3435-Q20A to adjust the channel bandwidth automatically.</p> <p><b>40MHz</b> (channel bonding or dual channel) bonds two adjacent radio channels to increase throughput. The wireless clients must also support 40 MHz. It is often better to use the 20 MHz setting in a location where the environment hinders the wireless signal.</p> <p>Select <b>20MHz</b> if you want to lessen radio interference with other wireless devices in your neighborhood or the wireless clients do not support channel bonding.</p> <p>The following are available only when you set <b>Band</b> to <b>5GHz</b>.</p> <p>Because not all devices support 40 MHz and/or 80 MHz channels, select <b>Auto</b> to allow the EMG3435-Q20A to adjust the channel bandwidth automatically.</p> <p><b>80+80MHz</b> bonds two non-adjacent 80MHz channels to increase throughput. The wireless clients may transmit/receive on both channels and use for the same purpose simultaneously.</p> <p><b>40MHz</b> (channel bonding or dual channel) bonds two adjacent radio channels to increase throughput. A 80 MHz channel consists of two adjacent 40 MHz channels. The wireless clients must also support 40 MHz or 80 MHz. It is often better to use the 20 MHz setting in a location where the environment hinders the wireless signal.</p> <p>Select <b>20MHz</b> if you want to lessen radio interference with other wireless devices in your neighborhood or the wireless clients do not support channel bonding.</p>
802.11 Mode	<p>If you set <b>Band</b> to <b>2.4GHz</b>, you can select from the following:</p> <ul style="list-style-type: none"> <li>• <b>802.11b</b>: allows either IEEE 802.11b or IEEE 802.11g compliant WLAN devices to associate with the EMG3435-Q20A. In this mode, all wireless devices can only transmit at the data rates supported by IEEE 802.11b.</li> <li>• <b>802.11g</b>: allows IEEE 802.11g compliant WLAN devices to associate with the Device. IEEE 802.11b compliant WLAN devices can associate with the EMG3435-Q20A only when they use the short preamble type.</li> <li>• <b>802.11bg</b>: allows either IEEE 802.11b or IEEE 802.11g compliant WLAN devices to associate with the EMG3435-Q20A. The EMG3435-Q20A adjusts the transmission rate automatically according to the wireless standard supported by the wireless devices.</li> <li>• <b>802.11n</b>: allows IEEE 802.11n compliant WLAN devices to associate with the EMG3435-Q20A. This can increase transmission rates, although IEEE 802.11b or IEEE 802.11g clients will not be able to connect to the EMG3435-Q20A.</li> <li>• <b>802.11gn</b>: allows either IEEE 802.11g or IEEE 802.11n compliant WLAN devices to associate with the EMG3435-Q20A. The transmission rate of your EMG3435-Q20A might be reduced.</li> <li>• <b>802.11 bgn</b>: allows IEEE802.11b, IEEE802.11g and IEEE802.11n compliant WLAN devices to associate with the EMG3435-Q20A. The transmission rate of your EMG3435-Q20A might be reduced.</li> </ul> <p>If you set <b>Band</b> to <b>5GHz</b>, you can select from the following:</p> <ul style="list-style-type: none"> <li>• <b>802.11a</b>: allows only IEEE 802.11a compliant WLAN devices to associate with the EMG3435-Q20A.</li> <li>• <b>802.11a/an</b>: allows both IEEE802.11n and IEEE802.11a compliant WLAN devices to associate with the EMG3435-Q20A. The transmission rate of your EMG3435-Q20A might be reduced.</li> <li>• <b>802.11a/an/ac</b>: allows IEEE802.11n, IEEE802.11a and IEEE 802.11ac compliant WLAN devices to associate with the EMG3435-Q20A.</li> </ul>
Security	

Table 27 Expert Mode &gt; Wireless (continued)

LABEL	DESCRIPTION
Security Mode	Select <b>WPA2-PSK</b> to add security on this wireless network. The wireless clients which want to associate to this network must have same wireless security settings as this device. After you select to use a security, additional options appears in this screen. See <a href="#">Section 11.3 on page 100</a> for detailed information on different security modes. Or you can select <b>No Security</b> to allow any client to associate this network without authentication.  Note: If the WPS function is enabled (default), only <b>No Security</b> and <b>WPA2-PSK</b> are available in this field.
Apply	Click <b>Apply</b> to save your changes back to the EMG3435-Q20A.
Cancel	Click <b>Cancel</b> to reload the previous configuration for this screen.

See the rest of this chapter for information on the other labels in this screen.

## 11.3 Wireless Security

The screen varies depending on what you select in the **Security Mode** field.

### 11.3.1 No Security

Select **No Security** to allow wireless clients to communicate with the access points without any data encryption.

Note: If you do not enable any wireless security on your EMG3435-Q20A, your network is accessible to any wireless networking device that is within range.

**Figure 66** Expert Mode > Wireless > Security Mode: No Security

The screenshot shows the configuration interface for the wireless network. At the top, there are 'Apply' and 'Cancel' buttons. The main content is divided into two sections: 'Wireless Setup' and 'Security'. In the 'Wireless Setup' section, the following settings are visible: Band is set to 2.4GHz; Wireless LAN is enabled; Name (SSID) is ZyXEL43D27E; Hide SSID is unchecked; Channel Selection is Channel-11 2462MHz; Operating Channel is Channel-11; Channel Width is Auto 20/40 MHz; and 802.11 Mode is 802.11bgn. In the 'Security' section, the Security Mode is set to No Security. A note at the bottom states: 'Note: No Security and WPA2-PSK can be configured when WPS enabled.'

The following table describes the labels in this screen.

Table 28 Expert Mode > Wireless > Security Mode: No Security

LABEL	DESCRIPTION
Security Mode	Choose <b>No Security</b> from the drop-down list box.
Apply	Click <b>Apply</b> to save your changes back to the EMG3435-Q20A.
Cancel	Click <b>Cancel</b> to reload the previous configuration for this screen.

### 11.3.2 WPA-PSK/WPA2-PSK

Select **WPA-PSK** or **WPA2-PSK** from the **Security Mode** list.

Note: WPA-PSK is not available if you enable WPS before you configure WPA-PSK in the **Expert Mode > Wireless > Wireless** screen.

Figure 67 Expert Mode > Wireless > Security Mode: WPA-PSK/WPA2-PSK

The screenshot shows the 'Wireless 2.4G' configuration page. At the top right are 'Apply' and 'Cancel' buttons. The page is divided into two sections: 'Wireless Setup' and 'Security'. In the 'Wireless Setup' section, 'Band' is set to '2.4GHz', 'Wireless LAN' is 'Enable', 'Name (SSID)' is 'ZyXELBADB06', 'Channel Selection' is 'Auto Channel Selection', 'Operating Channel' is 'Channel-', 'Channel Width' is 'Auto 20/40 MHz', and '802.11 Mode' is '802.11bgn'. In the 'Security' section, 'Security Mode' is 'WPA2-PSK', 'WPA-PSK Compatible' is unchecked, 'PMF' is unchecked, 'Pre-Shared Key' is masked with asterisks, and 'Group Key Update Timer' is '3600 seconds'. A note at the bottom states: 'Note: No Security and WPA2-PSK can be configured when WPS enabled.'

The following table describes the labels in this screen.

Table 29 Expert Mode > Wireless > Security Mode: WPA-PSK/WPA2-PSK

LABEL	DESCRIPTION
Security Mode	Select <b>WPA2-PSK</b> to enable data encryption.
WPA-PSK Compatible	This field appears when you choose <b>WPA2-PSK</b> as the <b>Security Mode</b> . Check this field to allow wireless devices using <b>WPA-PSK</b> security mode to connect to your EMG3435-Q20A.

Table 29 Expert Mode &gt; Wireless &gt; Security Mode: WPA-PSK/WPA2-PSK (continued)

LABEL	DESCRIPTION
PMF	Protected Management Frames (PMF) is a protection mechanism of action management frames.  Check this field to allow wireless devices using the PMF protection mechanism to connect to your EMG3435-Q20A.
Pre-Shared Key	<b>WPA-PSK/WPA2-PSK</b> uses a simple common password for authentication.  Type a pre-shared key from 8 to 63 case-sensitive keyboard characters.
Group Key Update Timer	The <b>Group Key Update Timer</b> is the rate at which the AP sends a new group key out to all clients.  The default is <b>3600</b> seconds (60 minutes).
Apply	Click <b>Apply</b> to save your changes back to the EMG3435-Q20A.
Cancel	Click <b>Cancel</b> to reload the previous configuration for this screen.

### 11.3.3 WPA/WPA2

Select **WPA2** from the **Security Mode** list.

Note: WPA or WPA2 is not available if you enable WPS before you configure WPA or WPA2 in the **Expert Mode > Wireless > Wireless** screen.

Figure 68 Expert Mode &gt; Wireless &gt; Security Mode: WPA/WPA2

Wireless 2.4G
Apply
Cancel

---

**Wireless Setup**

Band:

Wireless LAN:  Enable  Disable

Name (SSID):

Hide SSID

Channel Selection:

Operating Channel: Channel-11

Channel Width:

802.11 Mode:

---

**Security**

Security Mode:

---

WPA Compatible

Group Key Update Timer:  seconds

PMK Cache Period:  minutes

Pre-Authentication:  Enable  Disable

Authentication Server

IP Address:

Port Number:

Shared Secret:

Session Timeout(0 or 60~):  seconds

**Note: No Security and WPA2-PSK can be configured when WPS enabled.**

The following table describes the labels in this screen.

Table 30 Expert Mode &gt; Wireless &gt; Security Mode: WPA/WPA2

LABEL	DESCRIPTION
Security Mode	Select <b>WPA2</b> to enable data encryption.
WPA Compatible	This check box is available only when you select <b>WPA2-PSK</b> or <b>WPA2</b> in the <b>Security Mode</b> field.  Select the check box to have both WPA2 and WPA wireless clients be able to communicate with the EMG3435-Q20A even when the EMG3435-Q20A is using WPA2-PSK or WPA2.
Group Key Update Timer	The <b>Group Key Update Timer</b> is the rate at which the AP (if using <b>WPA-PSK/WPA2-PSK</b> key management) or RADIUS server (if using <b>WPA/WPA2</b> key management) sends a new group key out to all clients. The re-keying process is the WPA/WPA2 equivalent of automatically changing the WEP key for an AP and all stations in a WLAN on a periodic basis. Setting of the <b>Group Key Update Timer</b> is also supported in <b>WPA-PSK/WPA2-PSK</b> mode.
PMK Cache Period	This field is available only when you select <b>WPA2</b> .  Specify how often wireless clients have to resend usernames and passwords in order to stay connected. Enter a time interval between 10 and 999999 minutes.  Note: If wireless client authentication is done using a RADIUS server, the reauthentication timer on the RADIUS server has priority.

Table 30 Expert Mode &gt; Wireless &gt; Security Mode: WPA/WPA2 (continued)

LABEL	DESCRIPTION
Pre-Authentication	This field is available only when you select <b>WPA2</b> .  Pre-authentication enables fast roaming by allowing the wireless client (already connecting to an AP) to perform IEEE 802.1x authentication with another AP before connecting to it. Select <b>Enable</b> to turn on preauthentication in WAP2. Otherwise, select <b>Disable</b> .
Authentication Server	
IP Address	Enter the IP address of the external authentication server in dotted decimal notation.
Port Number	Enter the port number of the external authentication server.  You need not change this value unless your network administrator instructs you to do so with additional information.
Shared Secret	Enter a password (up to 127 alphanumeric characters) as the key to be shared between the external authentication server and the EMG3435-Q20A.  The key must be the same on the external authentication server and your EMG3435-Q20A. The key is not sent over the network.
Session Timeout	The EMG3435-Q20A automatically disconnects a wireless client from the wireless and wired networks after a period of inactivity. The wireless client needs to send the username and password again before it can use the wireless and wired networks again. Some wireless clients may prompt users for a username and password; other clients may use saved login credentials. In either case, there is usually a short delay while the wireless client logs in to the wireless network again.  Enter the time in seconds from 0 to 999999.
Apply	Click <b>Apply</b> to save your changes back to the EMG3435-Q20A.
Cancel	Click <b>Cancel</b> to reload the previous configuration for this screen.

## 11.4 Guest Wireless Screen

This screen allows you to enable and configure multiple guest wireless network settings on the EMG3435-Q20A.

You can configure up to four SSIDs to enable multiple BSSs (Basic Service Sets) on the EMG3435-Q20A. This allows you to use one access point to provide several BSSs simultaneously. You can then assign varying security types to different SSIDs. Wireless clients can use different SSIDs to associate with the same access point.

Click **Expert Mode > Wireless > Guest Wireless**. The following screen displays.

Figure 69 Expert Mode &gt; Wireless &gt; Guest Wireless

Guest Wireless Setup					
#	Status	SSID	Security	Remaining time	Edit
1		ZyXEL_SSID1	No Security	9:41:51 <input type="button" value="Set"/>	
2		ZyXEL_SSID2	No Security	0:0:0 <input type="button" value="Set"/>	
3		ZyXEL_SSID3	No Security	0:0:0 <input type="button" value="Set"/>	



The following table describes the labels in this screen.

Table 31 Expert Mode > Wireless > Guest Wireless

LABEL	DESCRIPTION
Band	Use <b>2.4GHz</b> or <b>5GHz</b> to set up the EMG3435-Q20A's guest Wi-Fi network.
#	This is the index number of each SSID profile.
Status	This shows whether the SSID profile is active (a yellow bulb) or not (a gray bulb).
SSID	An SSID profile is the set of parameters relating to one of the EMG3435-Q20A's BSSs. The SSID (Service Set Identifier) identifies the Service Set with which a wireless device is associated.  This field displays the name of the wireless profile on the network. When a wireless client scans for an AP to associate with, this is the name that is broadcast and seen in the wireless client utility.
Security	This field indicates the security mode of the SSID profile.
Remaining time	If the user is currently not permitted to access the Internet, you can click <b>Set</b> to allow access for a specified period of time. A screen then displays allowing you to set how long (in hours) the user is allowed to access the Internet.  This field displays the amount of Internet access time that remains for each user before the EMG3435-Q20A blocks the user from accessing the Internet.  <b>0:0:0</b> means there is no extra Internet access time.
Edit	Click the <b>Edit</b> icon to configure the SSID profile.

## 11.4.1 Guest Wireless Edit

Use this screen to edit an SSID profile. Click the **Edit** icon next to an SSID in the **Guest Wireless** screen. The following screen displays.

Figure 70 Expert Mode > Wireless > Guest Wireless > Guest Wireless Setup: Edit



**Guest Wireless 2.4G Edit** [Apply] [Cancel]

**Wireless Setup**

Active :

Name (SSID) :

Hide SSID

Intra-BSS Traffic Blocking

WMM QoS

Enable Bandwidth Management for Guest WLAN  (max. bandwidth kbps)

---

**Security**

Security Mode :

 No Security and WPA2-PSK can be configured when WPS enabled.

The following table describes the labels in this screen.

Table 32 Expert Mode > Wireless > Guest Wireless > Guest Wireless Setup: Edit

LABEL	DESCRIPTION
Active	Select this to activate the SSID profile.
Name (SSID)	The SSID (Service Set IDentity) identifies the Service Set with which a wireless client is associated. Enter a descriptive name (up to 32 printable characters found on a typical English language keyboard) for the wireless LAN.
Hide SSID	Select this check box to hide the SSID in the outgoing beacon frame so a station cannot obtain the SSID through scanning using a site survey tool.
Intra-BSS Traffic Blocking	A Basic Service Set (BSS) exists when all communications between wireless clients or between a wireless client and a wired network client go through one access point (AP).  Intra-BSS traffic is traffic between wireless clients in the BSS. When Intra-BSS is enabled, wireless clients can access the wired network and communicate with each other. When Intra-BSS is disabled, wireless clients can still access the wired network but cannot communicate with each other.
WMM QoS	Check this to have the EMG3435-Q20A automatically give a service a priority level according to the ToS value in the IP header of packets it sends.  WMM QoS (Wifi MultiMedia Quality of Service) gives high priority to voice and video, which makes them run more smoothly.
Enable Bandwidth Management for Guest WLAN	Select this to turn on bandwidth management for the Guest Wi-Fi network.
Maximum Bandwidth	Enter a number to specify maximum bandwidth the Guest Wi-Fi network can use.
Security Mode	Select <b>WPA-PSK</b> or <b>WPA2-PSK</b> to add security on this wireless network. The wireless clients which want to associate to this network must have same wireless security settings as this device. After you select to use a security, additional options appears in this screen. See <a href="#">Section 11.3 on page 100</a> for detailed information on different security modes. Or you can select <b>No Security</b> to allow any client to associate this network without authentication.  Note: If the WPS function is enabled (default), only <b>No Security</b> and <b>WPA2-PSK</b> are available in this field.
Apply	Click <b>Apply</b> to save your changes back to the EMG3435-Q20A.
Cancel	Click <b>Cancel</b> to reload the previous configuration for this screen.

## 11.5 MAC Filter Screen

The MAC filter screen allows you to configure the EMG3435-Q20A to give exclusive access to devices (**Allow**) or exclude devices from accessing the EMG3435-Q20A (**Deny**). Every Ethernet device has a unique MAC (Media Access Control) address. The MAC address is assigned at the factory and consists of six pairs of hexadecimal characters, for example, 00:A0:C5:00:00:02. You need to know the MAC address of the devices to configure this screen.

To change your EMG3435-Q20A's MAC filter settings, click **Expert Mode > Wireless > MAC Filter**. The screen appears as shown.

Figure 71 Expert Mode &gt; Wireless &gt; MAC Filter

**MAC Filter 2.4G** Apply Cancel

Band :

SSID Select :

MAC Address Filter :  Enable  Disable

Filter Action :  Allow  Deny

**MAC Filter Summary (Max Limit : 64)**

#	MAC Address	Add/Delete
<input type="text" value="User Defined"/>	<input type="text" value="00:00:00:00:00:00"/>	<input type="button" value="+"/>
1	AC:AC:AB:CC:BA:AC	<input type="button" value="-"/>

The following table describes the labels in this menu.

Table 33 Expert Mode &gt; Wireless &gt; MAC Filter

LABEL	DESCRIPTION
Band	Select the frequency band to set whether you want to apply the wireless and security settings to the default <b>2.4GHz</b> or <b>5GHz</b> wireless LAN.
SSID Select	This shows the SSID for which you are configuring MAC filtering.
MAC Address Filter	Select to turn on ( <b>Enable</b> ) or off ( <b>Disable</b> ) MAC address filtering.
Filter Action	Define the filter action for the list of MAC addresses in the <b>MAC Filter Summary</b> table.  Select <b>Allow</b> to permit access to the EMG3435-Q20A, MAC addresses not listed will be denied access to the EMG3435-Q20A.  Select <b>Deny</b> to block access to the EMG3435-Q20A, MAC addresses not listed will be allowed to access the EMG3435-Q20A.
MAC Filter Summary (Max Limit : 64)	
#	This is the index number of the MAC address. Select <b>Auto Detection</b> to automatically detect the MAC address of the wireless station that are allowed or denied access to the EMG3435-Q20A. Otherwise, select <b>User define</b> to enter the MAC address of the wireless station in the <b>MAC Address</b> field that are allowed or denied access to the EMG3435-Q20A.
MAC Address	This field displays the MAC address of the wireless station. If you select <b>User define</b> in the # field, enter the MAC address(es) manually.
Add/Delete	Click <input type="button" value="+"/> to add the rule in the MAC filter summary table.  Click <input type="button" value="-"/> to remove a rule.
Apply	Click <b>Apply</b> to save your changes back to the EMG3435-Q20A.
Cancel	Click <b>Cancel</b> to reload the previous configuration for this screen.

## 11.6 Advanced Screen

Use this screen to allow wireless advanced features, such as the output power, RTS/CTS Threshold settings.

Click **Expert Mode > Wireless > Advanced**. The screen appears as shown.

Figure 72 Expert Mode &gt; Wireless &gt; Advanced

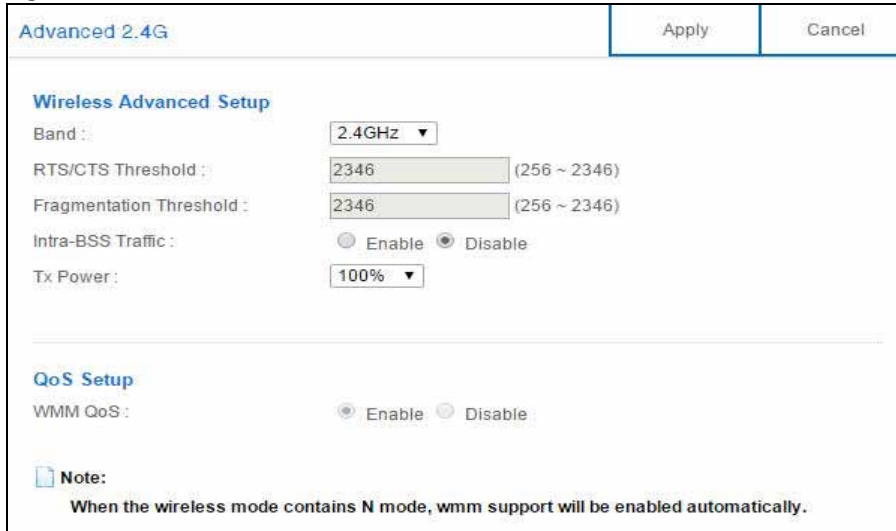

**Advanced 2.4G** Apply Cancel

**Wireless Advanced Setup**

Band : 2.4GHz ▼

RTS/CTS Threshold : 2346 (256 ~ 2346)

Fragmentation Threshold : 2346 (256 ~ 2346)

Intra-BSS Traffic :  Enable  Disable

Tx Power : 100% ▼

---

**QoS Setup**

WMM QoS :  Enable  Disable

**Note:**  
When the wireless mode contains N mode, wmm support will be enabled automatically.

The following table describes the labels in this screen.

Table 34 Expert Mode &gt; Wireless &gt; Advanced

LABEL	DESCRIPTION
Wireless Advanced Setup	
Band	Select the frequency band to set whether you want to apply the wireless and security settings to the default <b>2.4GHz</b> or <b>5GHz</b> wireless LAN.
RTS/CTS Threshold	Data with its frame size larger than this value will perform the RTS (Request To Send)/CTS (Clear To Send) handshake.  This field is not configurable and the EMG3435-Q20A automatically changes to use the maximum value if you select <b>802.11n</b> , <b>802.11an</b> , <b>802.11gn</b> or <b>802.11bgn</b> in the <b>Expert &gt; Wireless</b> screen.
Fragmentation Threshold	The threshold (number of bytes) for the fragmentation boundary for directed messages. It is the maximum data fragment size that can be sent.  This field is not configurable and the EMG3435-Q20A automatically changes to use the maximum value if you select <b>802.11n</b> , <b>802.11an</b> , <b>802.11gn</b> or <b>802.11bgn</b> in the <b>Expert &gt; Wireless</b> screen.
Intra-BSS Traffic	A Basic Service Set (BSS) exists when all communications between wireless clients or between a wireless client and a wired network client go through one access point (AP).  Intra-BSS traffic is traffic between wireless clients in the BSS. When you <b>Enable</b> Intra-BSS, wireless clients can access the wired network and communicate with each other. When you <b>Disable</b> Intra-BSS, wireless clients can still access the wired network but cannot communicate with each other.
Tx Power	Set the output power of the EMG3435-Q20A in this field. If there is a high density of APs in an area, decrease the output power of the EMG3435-Q20A to reduce interference with other APs. Select one of the following <b>100%</b> , <b>90%</b> , <b>75%</b> , <b>50%</b> , <b>25%</b> or <b>10%</b> .
QoS Setup	
WMM QoS	Select <b>Enable</b> to have the EMG3435-Q20A automatically give a service a priority level according to the ToS value in the IP header of packets it sends. WMM QoS (Wifi MultiMedia Quality of Service) gives high priority to voice and video, which makes them run more smoothly.  This field is not configurable and the EMG3435-Q20A automatically enables WMM QoS if you select <b>802.11n</b> , <b>802.11an</b> , <b>802.11gn</b> or <b>802.11bgn</b> in the <b>Expert &gt; Wireless</b> screen.

Table 34 Expert Mode &gt; Wireless &gt; Advanced (continued)

LABEL	DESCRIPTION
Apply	Click <b>Apply</b> to save your changes back to the EMG3435-Q20A.
Cancel	Click <b>Cancel</b> to reload the previous configuration for this screen.

## 11.7 WPS Screen

Use this screen to enable/disable WPS, view or generate a new PIN number and check current WPS status. To open this screen, click **Expert Mode > Wireless > WPS**.

Note: With WPS, wireless clients can only connect to the wireless network using the first SSID on the EMG3435-Q20A.

Figure 73 Expert Mode &gt; Wireless &gt; WPS

WPS 2.4G

Apply
Cancel

---

**WPS Setup**

Band : 2.4GHz

WPS :  Enable  Disable

PIN Code :  Enable  Disable

PIN Number : Generate

---

Click the Push Button to add WPS stations to wireless network. Push Button

Or input station's PIN number :  Start

---

**Note:**

1. The Push Button Configuration requires pressing a button on both the station and AP within 120 seconds.
2. You may find the PIN number in the station's utility.

---

**WPS Status**

Status : Configured Release Configuration

802.11 Mode : 802.11bgn

SSID : ZyXEL43D27E

Security : WPA2-PSK

---

**Note:**

If you enable WPS, the UPnP service will be turned on automatically.

The following table describes the labels in this screen.

Table 35 Expert Mode &gt; Wireless &gt; WPS

LABEL	DESCRIPTION
WPS Setup	
Band	Select the frequency band to set whether you want to apply the wireless and security settings to the default <b>2.4GHz</b> or <b>5GHz</b> wireless LAN.
WPS	Select <b>Enable</b> to turn on the WPS feature. Otherwise, select <b>Disable</b> .
PIN Code	Select <b>Enable</b> and click <b>Apply</b> to allow the PIN Configuration method. If you select <b>Disable</b> , you cannot create a new PIN number.
PIN Number	This is the WPS PIN (Personal Identification Number) of the EMG3435-Q20A. Enter this PIN in the configuration utility of the device you want to connect to the EMG3435-Q20A using WPS.  The PIN is not necessary when you use WPS push-button method.  Click <b>Generate</b> to generate a new PIN number.
Push Button	Use this button when you use the PBC (Push Button Configuration) method to configure wireless stations's wireless settings.  Click this to start WPS-aware wireless station scanning and the wireless security information synchronization.
Or input station's PIN number	Use this button when you use the PIN Configuration method to configure wireless station's wireless settings.  Type the same PIN number generated in the wireless station's utility. Then click <b>Start</b> to associate to each other and perform the wireless security information synchronization.
WPS Status	
Status	This displays <b>Configured</b> when the EMG3435-Q20A has connected to a wireless network using WPS or when <b>WPS Enable</b> is selected and wireless or wireless security settings have been changed. The current wireless and wireless security settings also appear in the screen.  This displays <b>Unconfigured</b> if WPS is disabled and there are no wireless or wireless security changes on the EMG3435-Q20A or you click <b>Release Configuration</b> to remove the configured wireless and wireless security settings.
Release Configuration	This button is only available when the WPS status displays <b>Configured</b> .  Click this button to remove all configured wireless and wireless security settings for WPS connections on the EMG3435-Q20A.
802.11 Mode	This is the 802.11 mode used. Only compliant WLAN devices can associate with the EMG3435-Q20A.
SSID	This is the name of the wireless network (the EMG3435-Q20A's first SSID).
Security	This is the type of wireless security employed by the network.
Apply	Click <b>Apply</b> to save your changes back to the EMG3435-Q20A.
Cancel	Click <b>Cancel</b> to reload the previous configuration for this screen.

## 11.8 Scheduling Screen

Use this screen to set the times your wireless LAN is turned on and off. Wireless LAN scheduling is disabled by default. The wireless LAN can be scheduled to turn on or off on certain days and at certain times. To open this screen, click **Expert Mode > Wireless > Scheduling**.

Figure 74 Expert Mode &gt; Wireless &gt; Scheduling

**Scheduling 2.4G** Apply Cancel

Band :  ▾

Wireless LAN Scheduling :  Enable  Disable

---

**Internet Access Schedule**

	0	1	2	3	4	5	6	7	8	9	10	11	12	13	14	15	16	17	18	19	20	21	22	23	24
Sun	Block	Block	Block	Block	Block	Block	Block	Block	Block	Block	Block	Block	Block	Block	Block	Block	Block	Block	Block	Block	Block	Block	Block	Block	Block
Mon	Block	Block	Block	Block	Block	Block	Block	Block	Block	Block	Block	Block	Block	Block	Block	Block	Block	Block	Block	Block	Block	Block	Block	Block	Block
Tue	Block	Block	Block	Block	Allow	Block	Block	Block	Block	Block	Block	Block	Block	Block	Block	Block	Block	Block	Block	Block	Block	Block	Block	Block	Block
Wed	Block	Block	Block	Block	Block	Block	Block	Block	Block	Block	Block	Block	Block	Block	Block	Block	Block	Block	Block	Block	Block	Block	Block	Block	Block
Thu	Block	Block	Block	Block	Block	Block	Block	Block	Block	Block	Block	Block	Block	Block	Block	Block	Block	Block	Block	Block	Block	Block	Block	Block	Block
Fri	Block	Block	Block	Block	Block	Block	Block	Block	Block	Block	Block	Block	Block	Block	Block	Block	Block	Block	Block	Block	Block	Block	Block	Block	Block
Sat	Block	Block	Block	Block	Block	Block	Block	Block	Block	Block	Block	Block	Block	Block	Block	Block	Block	Block	Block	Block	Block	Block	Block	Block	Block

Allow  Block

The following table describes the labels in this screen.

Table 36 Expert Mode &gt; Wireless &gt; Scheduling

LABEL	DESCRIPTION
Band	Select the frequency band to set whether you want to apply the wireless and security settings to the default <b>2.4GHz</b> or <b>5GHz</b> wireless LAN.
Wireless LAN Scheduling	Select <b>Enable</b> to activate the wireless LAN scheduling feature. Select <b>Disable</b> to turn it off.
Internet Access Schedule	The y-axis shows the time period in days. The x-axis shows the time period in hours. Click <b>Select All</b> or click gray blocks to specify days and times to turn the Wireless LAN on or off. If you click <b>Select All</b> you can not select any specific days and times. Click <b>Clean All</b> to remove all the wireless LAN scheduling.
Apply	Click <b>Apply</b> to save your changes back to the EMG3435-Q20A.
Cancel	Click <b>Cancel</b> to reload the previous configuration for this screen.

# CHAPTER 12

# LAN

## 12.1 Overview

This chapter describes how to configure LAN settings.

A Local Area Network (LAN) is a shared communication system to which many computers are attached. A LAN is a computer network limited to the immediate area, usually the same building or floor of a building.

**Figure 75** LAN Example

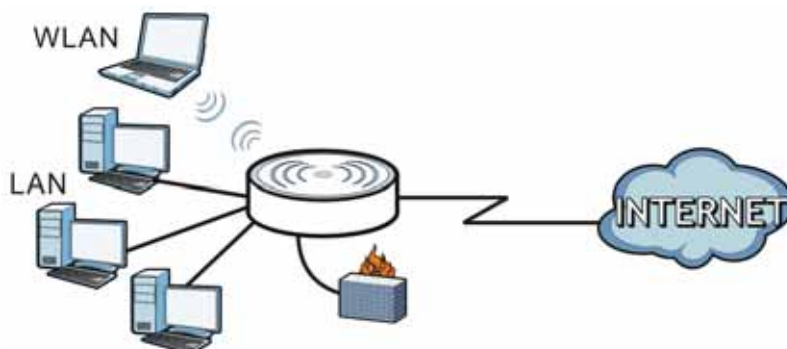

The LAN screens can help you configure a manage IP address, and partition your physical network into logical networks.

## 12.2 What You Can Do

- Use the **LAN IP** screen to configure the IPv4 and IPv6 addresses for your EMG3435-Q20A on the LAN ([Section 12.4 on page 113](#)).
- Use the **Static DHCP** screen to assign IP addresses on the LAN to specific individual computers based on their MAC Addresses ([Section 12.5 on page 114](#)).
- Use the **IPv6 LAN** screen to configure the IPv6 address for your EMG3435-Q20A on the LAN ([Section 12.6 on page 115](#)).

## 12.3 What You Need To Know

The actual physical connection determines whether the EMG3435-Q20A ports are LAN or WAN ports. There are two separate IP networks, one inside the LAN network and the other outside the WAN network as shown next.



Figure 76 LAN and WAN IP Addresses

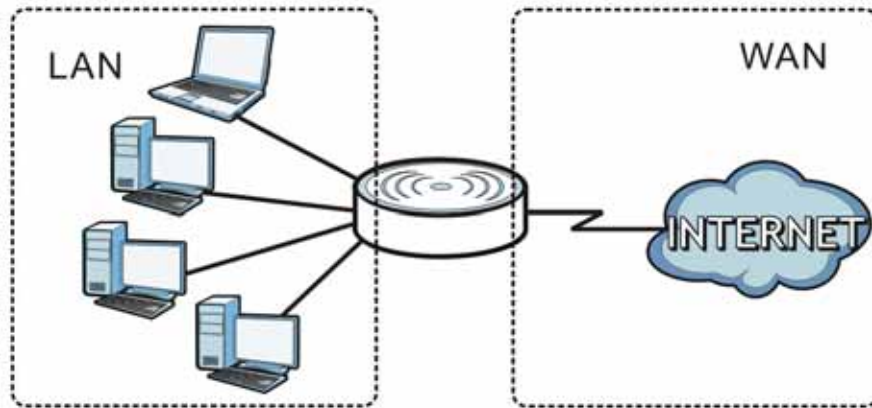

The LAN parameters of the EMG3435-Q20A are preset in the factory with the following values:

- IPv4 address of 192.168.1.1 with subnet mask of 255.255.255.0 (24 bits)
- DHCP server enabled with 128 client IPv4 addresses starting from 192.168.1.33.

These parameters should work for the majority of installations.

## 12.4 LAN IP Screen

Use this screen to change the IP address for your EMG3435-Q20A. Click **Expert Mode > LAN > LAN IP**.

Figure 77 Expert Mode &gt; LAN &gt; LAN IP

LAN IP		Apply	Cancel
IP Address :	<input type="text" value="192.168.1.1"/>		
IP Subnet Mask :	<input type="text" value="255.255.255.0"/>		
<hr/>			
DHCP Server :	<input checked="" type="radio"/> Enable <input type="radio"/> Disable		
IP Pool Starting Address :	<input type="text" value="192.168.1.33"/>		
Pool Size :	<input type="text" value="32"/>		

The following table describes the labels in this screen.

Table 37 Expert Mode &gt; LAN &gt; LAN IP

LABEL	DESCRIPTION
IP Address	Type the IP address of your EMG3435-Q20A in dotted decimal notation.
IP Subnet Mask	The subnet mask specifies the network number portion of an IP address. Your EMG3435-Q20A will automatically calculate the subnet mask based on the IP address that you assign. Unless you are implementing subnetting, use the subnet mask computed by the EMG3435-Q20A.

Table 37 Expert Mode &gt; LAN &gt; LAN IP (continued)

LABEL	DESCRIPTION
DHCP Server	Select <b>Enable</b> to activate DHCP for LAN.  DHCP (Dynamic Host Configuration Protocol, RFC 2131 and RFC 2132) allows individual clients (computers) to obtain TCP/IP configuration at startup from a server. Enable the DHCP server unless your ISP instructs you to do otherwise. Select <b>Disable</b> to stop the EMG3435-Q20A acting as a DHCP server. When configured as a server, the EMG3435-Q20A provides TCP/IP configuration for the clients. If not, DHCP service is disabled and you must have another DHCP server on your LAN, or else the computers must be manually configured. When set as a server, fill in the following four fields.
IP Pool Starting Address	This field specifies the first of the contiguous addresses in the IP address pool for LAN.
Pool Size	This field specifies the size, or count of the IP address pool for LAN.
Apply	Click <b>Apply</b> to save your changes back to the EMG3435-Q20A.
Cancel	Click <b>Cancel</b> to begin configuring this screen afresh.

## 12.5 Static DHCP Screen

This screen allows you to assign IP addresses on the LAN to specific individual computers based on their MAC addresses.

To change your EMG3435-Q20A's static DHCP settings, click **Expert Mode > LAN > Static DHCP**.

Figure 78 Expert Mode &gt;

#	MAC Address	IP Address	Add/Delete
1	c0:3f:d5:ba:9e:b7	192.168.1.88	+ -

The following table describes the labels on this screen.

Table 38 Expert Mode &gt; LAN &gt; Static DHCP

LABEL	DESCRIPTION
#	This is the index number of the static IP table entry (row). Select <b>Auto Detection</b> to automatically detect the MAC address of a computer on your LAN. Otherwise, select <b>User define</b> to enter the MAC address of a computer on your LAN in the <b>MAC Address</b> field.
MAC Address	This field displays the MAC address of a computer on your LAN. If you select <b>User define</b> in the # field, enter the MAC address(es) manually.
IP Address	This field displays the LAN IP address of a computer on your LAN. If you select <b>User define</b> in the # field, enter the IP address(es) manually.
Add/Delete	Click <b>+</b> to add the rule in the MAC filter summary table.  Click <b>-</b> to remove a rule.
Apply	Click <b>Apply</b> to save your changes with the EMG3435-Q20A.
Cancel	Click <b>Cancel</b> to begin configuring this screen afresh.

## 12.6 IPv6 LAN Screen

Use this screen to configure the IP address for your EMG3435-Q20A on the LAN. Click **Expert Mode > LAN > IPv6 LAN**.

**Figure 79** Expert Mode > LAN > IPv6 LAN

The following table describes the labels in this screen.

Table 39 Expert Mode > LAN > IPv6 LAN

LABEL	DESCRIPTION
LAN IPv6 Address Assignment	
Enable_DHCPv6-PD	Select this option to use DHCPv6 prefix delegation. The EMG3435-Q20A will obtain an IPv6 prefix from the ISP or a connected uplink router for the LAN.
Autoconfiguration Type	Select <b>SLAAC + RDNSS</b> to enable IPv6 stateless auto-configuration on this interface. The interface will generate an IPv6 IP address itself from a prefix obtained from an IPv6 router in the network. Select <b>SLAAC + Stateless DHCPv6</b> to enable IPv6 stateless auto-configuration on this interface. The interface will get an IPv6 address from an IPv6 router and the DHCP server. The IP address information gets through DHCPv6. Select <b>Stateful DHCPv6</b> to allow a DHCP server to assign and pass IPv6 network addresses, prefixes and other configuration information to DHCP clients.
IPv6 Address range (Start)	Enter the beginning of the range of IP addresses that this address object represents.
IPv6 Address range (End)	Enter the end of the range of IP address that this address object represents.
IPv6 Lifetime	Enter the IPv6 lifetime in the LAN.
Static IP Address	
Select this option to manually enter an IPv6 address if you want to use a static IP address.	
LAN IPv6 Address	Enter the LAN IPv6 address you want to assign to your EMG3435-Q20A in hexadecimal notation.

Table 39 Expert Mode &gt; LAN &gt; IPv6 LAN (continued)

LABEL	DESCRIPTION
LAN IPv6 Prefix Length (48~64)	Enter the 48 to 64 address prefix length to specify in an IPv6 address compose the network address.
Prefix Preferred Lifetime	Enter the preferred lifetime for the prefix.
Prefix Valid Lifetime	Enter the valid lifetime for the prefix.
Link Local Only Select this option to only use the link local address on the EMG3435-Q20A interfaces in the LAN.	
ULA Select this option to identify a unique local address of the EMG3435-Q20A in the LAN.	
RA period	
Minimum RA period	Enter the minimum time in seconds between router advertisement messages.
Apply	Click <b>Apply</b> to save your changes back to the EMG3435-Q20A.
Cancel	Click <b>Cancel</b> to begin configuring this screen afresh.

# CHAPTER 13

# Applications

## 13.1 Overview

This chapter shows you how to configure parental control, bandwidth management, USB media sharing, UPnP and file sharing.

### 13.1.1 What You Can Do

- Use the **Parental Control** screens to enable parental control, configure the parental control rules and schedules, and send e-mail notifications. ([Section 13.2 on page 119](#)).
- Use the **Bandwidth Management** screen to configure bandwidth management and the device priority ([Section 13.3 on page 125](#)).
- Use the **USB Media Sharing** screen to use the EMG3435-Q20A as a media server and allow DLNA-compliant devices to play media files stored in the attached USB device ([Section 13.4 on page 127](#)).
- Use the **UPnP** screen to enable UPnP on your EMG3435-Q20A ([Section 13.5 on page 129](#)).
- Use the **File Sharing** screen to allow file sharing via the EMG3435-Q20A using Windows Explorer, the workgroup name or FTP ([Section 13.6 on page 130](#)).
- Use the **One Connect** screen to enable or disable Wi-Fi auto-configuration ([Section 13.7 on page 137](#)).

### 13.1.2 What You Need To Know

The following terms and concepts may help as you read through this chapter.

#### Keyword Blocking URL Checking

The EMG3435-Q20A checks the URL's domain name (or IP address) and file path separately when performing keyword blocking.

The URL's domain name or IP address is the characters that come before the first slash in the URL. For example, with the URL [www.zyxel.com.tw/news/pressroom.php](http://www.zyxel.com.tw/news/pressroom.php), the domain name is [www.zyxel.com.tw](http://www.zyxel.com.tw).

The file path is the characters that come after the first slash in the URL. For example, with the URL [www.zyxel.com.tw/news/pressroom.php](http://www.zyxel.com.tw/news/pressroom.php), the file path is [news/pressroom.php](http://www.zyxel.com.tw/news/pressroom.php).

Since the EMG3435-Q20A checks the URL's domain name (or IP address) and file path separately, it will not find items that go across the two. For example, with the URL [www.zyxel.com.tw/news/pressroom.php](http://www.zyxel.com.tw/news/pressroom.php), the EMG3435-Q20A would find "tw" in the domain name ([www.zyxel.com.tw](http://www.zyxel.com.tw)). It would also find "news" in the file path ([news/pressroom.php](http://www.zyxel.com.tw/news/pressroom.php)) but it would not find "tw/news".

## DLNA

The Digital Living Network Alliance (DLNA) is a group of personal computer and electronics companies that works to make products compatible in a home network. DLNA clients play files stored on DLNA servers. The EMG3435-Q20A can function as a DLNA-compliant media server and stream files to DLNA-compliant media clients without any configuration.

## Workgroup name

This is the name given to a set of computers that are connected on a network and share resources such as a printer or files. Windows automatically assigns the workgroup name when you set up a network.

## File Systems

A file system is a way of storing and organizing files on your hard drive and storage device. Often different operating systems such as Windows or Linux have different file systems. The file-sharing feature on your EMG3435-Q20A supports New Technology File System (NTFS), File Allocation Table (FAT) and FAT32 file systems.

The EMG3435-Q20A uses Common Internet File System (CIFS) protocol for its file sharing functions. CIFS compatible computers can access the USB file storage devices connected to the EMG3435-Q20A. CIFS protocol is supported on Microsoft Windows, Linux Samba and other operating systems (refer to your systems specifications for CIFS compatibility).

## Samba

SMB is a client-server protocol used by Microsoft Windows systems for sharing files, printers, and so on.

Samba is a free SMB server that runs on most Unix and Unix-like systems. It provides an implementation of an SMB client and server for use with non-Microsoft operating systems.

## File Transfer Protocol

This is a method of transferring data from one computer to another over a network such as the Internet.

## Universal Plug-and-Play (UPnP)

UPnP hardware is identified as an icon in the Network Connections folder (Windows XP). Each UPnP compatible device installed on your network will appear as a separate icon. Selecting the icon of a UPnP device will allow you to access the information and properties of that device.

### 13.1.3 Before You Begin

Make sure the EMG3435-Q20A is connected to your network and turned on.

- 1 Connect the USB device to one of the EMG3435-Q20A's USB ports.
- 2 The EMG3435-Q20A detects the USB device and makes its contents available for browsing. If you are connecting a USB hard drive that comes with an external power supply, make sure it is connected to an appropriate power source that is on.

Note: If your USB device cannot be detected by the EMG3435-Q20A, see the troubleshooting for suggestions.

## 13.2 Parental Control

Parental Control allows you to block specific URLs. You can also define time periods and days during which the EMG3435-Q20A performs parental control on a specific user.

### 13.2.1 General Screen

Use this screen to enable parental control, view the parental control rules and schedules.

In **Expert mode**, click **Applications > Parental Control > General** to open the following screen.

**Figure 80** Expert Mode > Applications > Parental Control > General

#	Status	User Name	Schedule	Modify	Bonus	Remaining time
1		Test	Block		Bonus	0:28:25
2		example	Allow		Bonus	None

The following table describes the fields in this screen.

Table 40 Expert Mode > Applications > Parental Control > General

LABEL	DESCRIPTION
General	
Parental Control	Select <b>Enable</b> to activate parental control. Otherwise, select <b>Disable</b> to turn it off.
Add new rules	Click this if you want to configure a new parental control rule.
Parental Control Rules	
#	This shows the index number of the rule.
Status	This indicates whether the rule is active or not. A yellow bulb signifies that this rule is active. A gray bulb signifies that this rule is not active.
User Name	This shows the name of the user to which this rule applies.
Schedule	This shows whether the user is able to access the Internet through the EMG3435-Q20A ( <b>Allow</b> ) or not ( <b>Block</b> ) at the moment.
Modify	Click the <b>Edit</b> icon to go to the screen where you can edit the rule. Click the <b>Delete</b> icon to delete an existing rule.
Bonus	If the user is currently not permitted to access the Internet, you can click the <b>Bonus</b> to allow access for a specified period of time. A screen then displays allowing you to set how long (in minutes) the user is allowed to access the Internet.  This button is grayed out if the user is now able to access the Internet.

Table 40 Expert Mode > Applications > Parental Control > General

LABEL	DESCRIPTION
Remaining Time	This field displays the amount of Internet access time that remains for each user before the EMG3435-Q20A blocks the user from accessing the Internet.  <b>None</b> means there is no extra Internet access time.
Apply	Click <b>Apply</b> to save your changes.
Cancel	Click <b>Cancel</b> to restore your previously saved settings.

### 13.2.1.1 Add/Edit a Parental Control Rule

Click **Add new rules** in the **Parental Control** screen to add a new rule or click the **Edit** icon next to an existing rule to edit it. Use this screen to configure a restricted access schedule and/or URL filtering settings to block the users on your network from accessing certain web sites.

Figure 81 Expert Mode > Applications > Parental Control > General: Add/Edit new rules

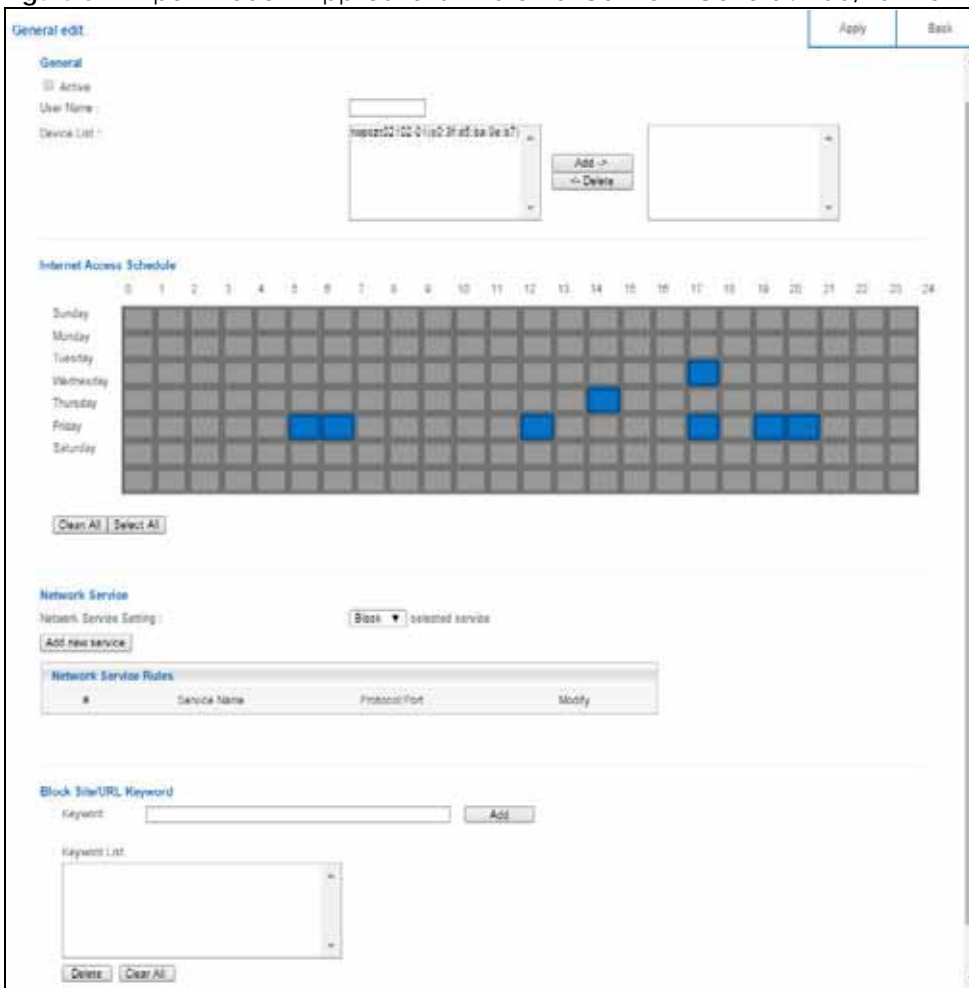



The following table describes the fields in this screen.

Table 41 Expert Mode > Applications > Parental Control > General: Add/Edit new rules

LABEL	DESCRIPTION
General	
Active	Select the checkbox to activate this parental control rule.
User Name	Enter a descriptive name for the user.
Device List	The left text box lists the system name of the LAN user device which is connected to the EMG3435-Q20A and assigned an IP address.  From the left text box, select the LAN user device to which you want to apply this rule and click <b>Add</b> to move it to the right text box.  To remove a user device, select it from the right text box and click <b>Delete</b> .
Internet Access Schedule	The y-axis shows the days that you want the EMG3435-Q20A to perform parental control and allow the user to access the Internet.  The x-axis shows the time period during which the LAN user is allowed access.  A blue block signifies that this rule is active. A gray block signifies that this rule is not active.
Clean All	Click <b>Clean All</b> to remove blocks you selected.
Select All	Click <b>Select All</b> to choose all blocks.
Network Service	
Network Service Setting	If you select <b>Block</b> , the EMG3435-Q20A prohibits the users from using the services listed below. If you select <b>Allow</b> , the EMG3435-Q20A blocks all services except ones listed below.
Add new service	Click this to show a screen in which you can add a new service rule. You can configure the <b>Service Name</b> , <b>Protocol</b> , and <b>Port</b> of the new rule.
#	This shows the index number of the rule. Select the checkbox next to the rule to activate it.
Service Name	This shows the name of the service.
Protocol:Port	This shows the protocol and the port of the service.
Modify	Click the <b>Edit</b> icon to go to the screen where you can edit the rule.  Click the <b>Delete</b> icon to delete an existing rule.
Block Site/URL Keyword	
Keyword	Enter a keyword and click <b>Add</b> to add it to the keyword list. This has the EMG3435-Q20A block access to the website URLs that contain the keyword.
Keyword List	Select a keyword and click <b>Delete</b> to remove it.  Click <b>Clear All</b> to remove all keywords from the keyword list.
Apply	Click <b>Apply</b> to save your settings back to the EMG3435-Q20A.
Back	Click <b>Back</b> to return to the previous screen.

### 13.2.1.2 Add/Edit a Service

Click **Add new service** in the **Parental Control > Add new rules** screen to add a new entry or click the **Edit** icon next to an existing entry to edit it. Use this screen to configure a service rule.

**Figure 82** Expert Mode > Applications > Parental Control > General: Add/Edit new rules: Add new service

The screenshot shows a web interface titled 'parental control edit'. At the top right, there are two buttons: 'Apply' and 'Back'. Below the title bar, there are three main input fields:

- Service Name:** A dropdown menu currently showing 'UserDefined' and an empty text input field below it.
- Protocol:** A dropdown menu currently showing 'TCP' and an empty text input field below it.
- Port:** An empty text input field.

Below the Port field, there is a small text note: '(Example:4091,5091-6892)'.

The following table describes the fields in this screen.

**Table 42** Expert Mode > Applications > Parental Control > General: Add/Edit new rules: Add new service

LABEL	DESCRIPTION
Service Name	Select the name of the service. Otherwise, select <b>UserDefined</b> and manually specify the protocol and the port of the service.  If you have chosen a pre-defined service in the <b>Service Name</b> field, this field will not be configurable.
Protocol	Select the transport layer protocol used for the service. Choices are <b>TCP</b> , <b>UDP</b> , or <b>TCP/UDP</b> .
Port	Enter the port of the service.  If you have chosen a pre-defined service in the <b>Service Name</b> field, this field will not be configurable.
Apply	Click <b>Apply</b> to save your settings with the EMG3435-Q20A.
Back	Click <b>Back</b> to return to the previous screen.

## 13.2.2 Notification Screen

Use this screen to have the EMG3435-Q20A send e-mail notifications when the user(s) is connected to the EMG3435-Q20A for Internet access during the specified time periods.

In **Expert** mode, click **Applications > Parental Control > Notification** to open the following screen.

**Figure 83** Expert Mode > Applications > Parental Control > Notification

The following table describes the fields in this screen.

**Table 43** Expert Mode > Applications > Parental Control > Notification

LABEL	DESCRIPTION
General	
E-mail Notification	Select <b>Enable</b> to activate e-mail notifications.
Add new rules	Click this if you want to configure a new parental monitor rule.
Notification Rules	
#	This shows the index number of the rule.
Status	This indicates whether the rule is active or not. A yellow bulb signifies that this rule is active. A gray bulb signifies that this rule is not active.
User Name	This shows the name of the user to which this rule applies.
Notification	This shows the e-mail address to which the notification is sent.
Modify	Click the <b>Edit</b> icon to go to the screen where you can edit the rule. Click the <b>Delete</b> icon to delete an existing rule.
Email Notification Configuration	
Mail Server	Select the mail server. Otherwise, select <b>UserDefined</b> and manually specify the mail server address and the port of the mail server.
Mail Server Address	Type the name or IP address of the outgoing SMTP server.
Mail Server Port	Enter the same port number here as is on the mail server for mail traffic.
Authentication Username	Type the user name to provide to the SMTP server for authentication when the notification is e-mailed.
Authentication Password	Type the password to provide to the SMTP server for authentication when the notification is e-mailed.
Mail From	Type the e-mail address from which the outgoing e-mail is delivered. This address is used in replies.

Table 43 Expert Mode &gt; Applications &gt; Parental Control &gt; Notification (continued)

LABEL	DESCRIPTION
E-Mail	Type the e-mail address (or addresses) to which the outgoing e-mail is delivered.
Apply	Click <b>Apply</b> to save your changes.
Cancel	Click <b>Cancel</b> to restore your previously saved settings.

### 13.2.2.1 Add/Edit a Notification Rule

Click **Add new rules** in the **Notification** screen to add a new rule or click the **Edit** icon next to an existing rule to edit it. Use this screen to set a schedule and have the EMG3435-Q20A send a notification when the specified user connects to the EMG3435-Q20A at the scheduled time.

Figure 84 Expert Mode &gt; Applications &gt; Notification: Add/Edit new rules

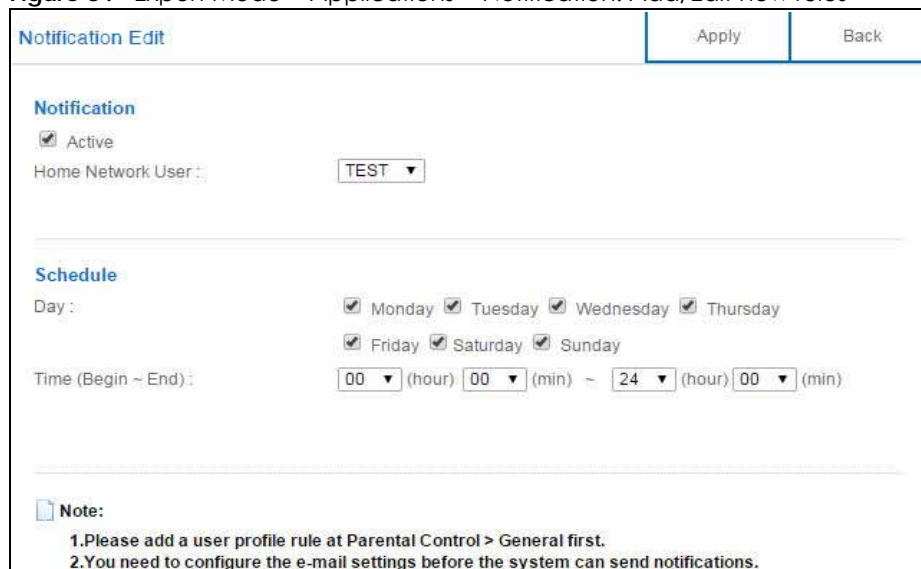

The following table describes the fields in this screen.

Table 44 Expert Mode &gt; Applications &gt; Notification: Add/Edit new rules

LABEL	DESCRIPTION
Notification	
Active	Select the checkbox to activate this notification rule.
Home Network User	Select the user that you want to apply this rule to from the drop-down list box.  Note: You should have configured a parental control rule already for the specified user.
Schedule	
Day	Select check boxes for the days that you want the EMG3435-Q20A to perform notification.
Time (Begin ~ End)	Define the time period during that you want the EMG3435-Q20A to perform notification.
Apply	Click <b>Apply</b> to save your settings back to the EMG3435-Q20A.
Back	Click <b>Back</b> to return to the previous screen.

## 13.3 Bandwidth Management

The EMG3435-Q20A supports the new StreamBoost technology, introduced by Qualcomm, to redistribute traffic over the EMG3435-Q20A for the best possible performance in a home network.

Streamboost is smart Quality of Service (QoS). Streamboost detects traffic flow and applies traffic shaping policies automatically. It gives each device and each application priority and provides the exact amount of bandwidth they need at a given time. This helps free up bandwidth for other applications or connected devices. If there is not enough bandwidth for optimal performance, Streamboost makes sure the application or device has the minimum acceptable bandwidth which is determined according to StreamBoost's cloud-based database.

Real-time application traffic (such as on-line games or communications) and video/audio streaming are given the highest priority. Downloads or torrent files are classified as best effort and placed lower than general network traffic (general browsing).

In the figure below, the StreamBoost-enabled EMG3435-Q20A differentiates incoming traffic flow going from the LAN device (A) or wireless device (B) to the Internet. It shapes traffic and gives priority and allocates bandwidth according to traffic types.

**Figure 85** StreamBoost Management Example

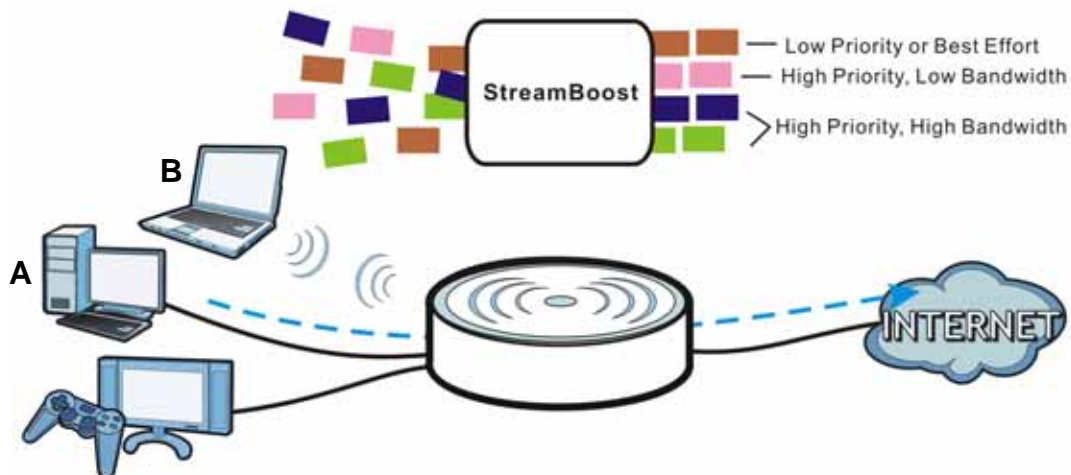

### 13.3.1 Bandwidth Screen

Use this screen to configure the maximum allowable bandwidth on the EMG3435-Q20A and allow the EMG3435-Q20A to get StreamBoost database updates automatically.

In **Expert** mode, click **Applications > Bandwidth Management > Bandwidth** to open the following screen.

Figure 86 Expert Mode &gt; Applications &gt; Bandwidth Management &gt; Bandwidth

The following table describes the labels in this screen.

Table 45 Expert Mode &gt; Applications &gt; Bandwidth Management &gt; Bandwidth

LABEL	DESCRIPTION
Enable StreamBoost	Select this option to turn on Streamboost management on the EMG3435-Q20A.
Up Limit (Mbps)	If you select <b>Automatic Bandwidth Detection</b> , this automatically displays the total amount of bandwidth that you can dedicate to uplink (or outgoing) traffic.  If you don't select <b>Automatic Bandwidth Detection</b> , set the total amount of bandwidth that you want to dedicate to uplink (or outgoing) traffic.  This is traffic from LAN/WLAN to WAN.
Down Limit (Mbps)	If you select <b>Automatic Bandwidth Detection</b> , this automatically displays the total amount of bandwidth that you can dedicate to downlink (or incoming) traffic.  If you don't select <b>Automatic Bandwidth Detection</b> , set the total amount of bandwidth that you want to dedicate to downlink (or incoming) traffic.  This is traffic from WAN to LAN/WLAN.
Enable Automatic Update	StreamBoost provides a cloud-based service to learn any new type of traffic which is not in its database and update the table in the EMG3435-Q20A for traffic detection and policies.  Select this option to have the EMG3435-Q20A automatically receives the StreamBoost table updates. When there is a new type of traffic which is not in the EMG3435-Q20A's table, the EMG3435-Q20A will capture some packets and send them to the StreamBoost cloud for analysis and database update.
Apply	Click <b>Apply</b> to save your customized settings.
Cancel	Click <b>Cancel</b> to begin configuring this screen afresh.

### 13.3.2 Priorities Screen

The StreamBoost engine on the EMG3435-Q20A can identify the types of connected devices (such as PC, smart phone, tablet, TV or game console) in your network. When there is not enough bandwidth to

support traffic of the same priority, the EMG3435-Q20A refers to the connected device priority. Traffic from the device with the lowest priority is classified as best-effort traffic.

Use this screen to prioritize the connected devices by clicking a device's arrow button to change its position in the list. Click **Save** to apply your settings. Otherwise, click **Cancel** to return the screen to its last-saved settings.

In **Expert** mode, click **Applications > Bandwidth Management > Priorities** to open the following screen.

**Figure 87** Expert Mode > Applications > Bandwidth Management > Priorities

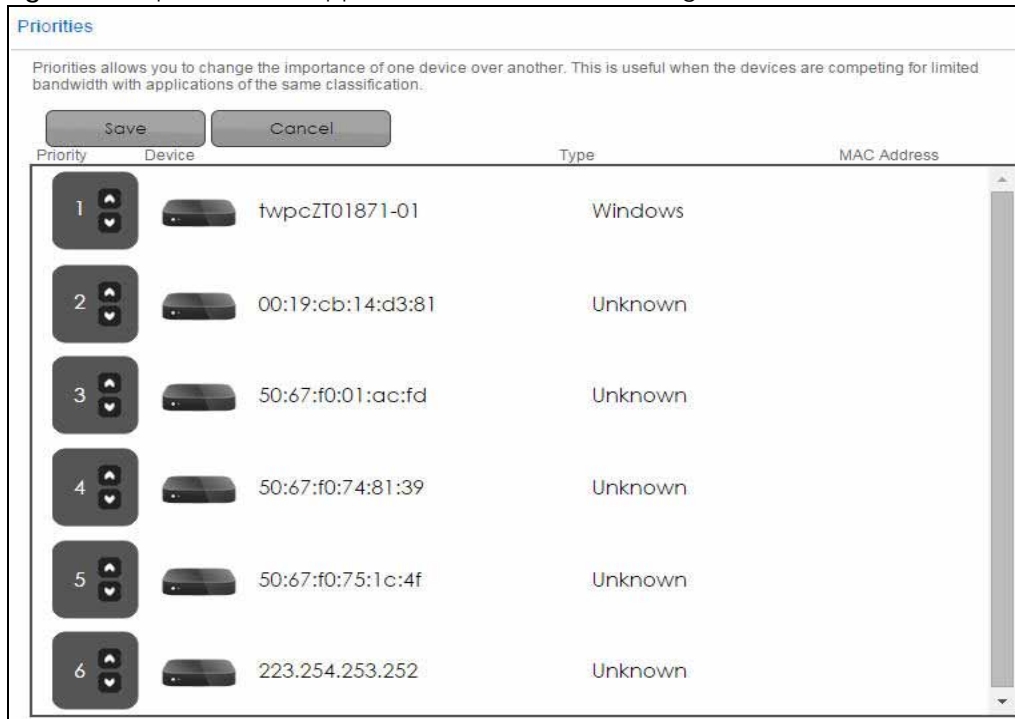

## 13.4 USB Media Sharing Screen

You can set up your EMG3435-Q20A to act as a media server to provide media (like video) to DLNA-compliant players, such as Windows Media Player, Zyxel DMAs (Digital Media Adapters), Xboxes or PS3s. The media server and clients must have IP addresses in the same subnet.

The EMG3435-Q20A media server enables you to:

- Publish all folders for everyone to play media files in the USB storage device connected to the EMG3435-Q20A.
- Use hardware-based media clients like the DMA-2500 to play the files.

**Note:** Anyone on your network can play the media files in the published folders. No user name and password nor other form of security is required.

The following figure is an overview of the EMG3435-Q20A's media server feature. DLNA devices **A** and **B** can access and play files on a USB device (**C**) which is connected to the EMG3435-Q20A (**D**).

Figure 88 Media Server Overview

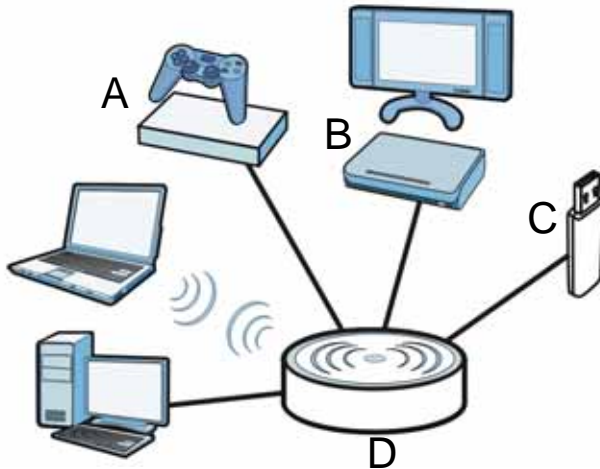

Use this screen to have the EMG3435-Q20A act as a DLNA-compliant media server that lets DLNA-compliant media clients on your network play video, music, and photos from the EMG3435-Q20A (without having to copy them to another computer).

In **Expert mode**, click **Applications > USB Media Sharing** to open the following screen.

Figure 89 Expert Mode &gt; Applications &gt; USB Media Sharing

The screenshot shows the 'USB Media Sharing' configuration window. At the top right are 'Apply' and 'Cancel' buttons. The main content is organized into sections:
 

- DLNA Setup:** 'Enable DLNA' with radio buttons for 'Enable' (selected) and 'Disable'.
- Enable Shared Media Types:** Two rows for 'USB1' and 'USB2'. Each row has three checked checkboxes for 'Photo', 'Music', and 'Video'.
- Rescan Media Contents:** A 'Rescan' button.
- Note:** A small icon followed by the text 'Maximum of 60,000 media files can be loaded.'

The following table describes the labels in this screen.

Table 46 Expert Mode &gt; Applications &gt; USB Media Sharing

LABEL	DESCRIPTION
DLNA Setup	
Enable DLNA	Select this to have the EMG3435-Q20A function as a DLNA-compliant media server.
Enable Shared Media Types	
USB1/USB2	Select the media type that you want to share on the USB device connected to the EMG3435-Q20A's USB port.
Rescan Media Contents	
Rescan	Click this button to have the EMG3435-Q20A scan the media files on the connected USB device and do indexing of the file list again so that DLNA clients can find the new files if any.



Table 46 Expert Mode &gt; Applications &gt; USB Media Sharing (continued)

LABEL	DESCRIPTION
Apply	Click <b>Apply</b> to save your changes back to the EMG3435-Q20A.
Cancel	Click <b>Cancel</b> to begin configuring this screen afresh.

## 13.5 UPnP Screen

Universal Plug and Play (UPnP) is a distributed, open networking standard that uses TCP/IP for simple peer-to-peer network connectivity between devices. A UPnP device can dynamically join a network, obtain an IP address, convey its capabilities and learn about other devices on the network. In turn, a device can leave a network smoothly and automatically when it is no longer in use.

Use this screen to enable UPnP on your EMG3435-Q20A.

In **Expert** mode, click **Applications > UPnP** to open the following screen.

Figure 90 Expert Mode &gt; Applications &gt; UPnP

#	Protocol	In Port	Out Port	IP Address
1	tcp	548	548	192.168.77.55
2	tcp	445	445	192.168.77.55
3	tcp	21	21	192.168.77.55
4	tcp	8000	80	192.168.77.55
5	tcp	8082	8082	192.168.77.55
6	udp	50657	50657	192.168.77.97
7	udp	59530	59530	192.168.77.46
8	udp	34851	34851	172.20.10.3
9	udp	18166	18166	172.20.10.3
10	tcp	34851	34851	172.20.10.3

The following table describes the fields in this screen.

Table 47 Expert Mode &gt; Applications &gt; UPnP

LABEL	DESCRIPTION
UPnP	Select <b>Enable</b> to activate UPnP. Be aware that anyone could use a UPnP application to open the web configurator's login screen without entering the EMG3435-Q20A's IP address (although you must still enter the password to access the web configurator).
Display	Select the page number from the drop-down list box to display the UPnP port mapping rules.
UPnP Portmap Table	
#	This is the number of an individual UPnP entry.
Protocol	This is the transport layer protocol used for the service.
In Port	<b>In Port</b> is a port that a LAN computer uses when it requests a particular service. This port is only applicable to the local network.  This field displays the port number of the UPnP entry.

Table 47 Expert Mode &gt; Applications &gt; UPnP (continued)

LABEL	DESCRIPTION
Out Port	<p><b>Out Port</b> is the well-known port that the WAN server uses to reply to the LAN computer that made the request using <b>In Port</b>.</p> <p>In the below example, <b>In Port</b> 8000 is paired with <b>Out Port</b> 80. A user on the WAN could enter <code>http://A.B.C.D:8000</code> to access the internal computer with private IP address 192.168.77.55 where A.B.C.D is the WAN IP address or URL of the EMG3435-Q20A.</p> <p>This field displays the port number of the UPnP entry.</p>
IP Address	This field displays the IP address of this UPnP entry.
Apply	Click <b>Apply</b> to save the setting to the EMG3435-Q20A.
Cancel	Click <b>Cancel</b> to return to the previously saved settings.

## 13.6 File Sharing

You can also share files on a USB memory stick or hard drive connected to your EMG3435-Q20A with users on your network.

The following figure is an overview of the EMG3435-Q20A's file-sharing server feature. Computers **A** and **B** can access files on a USB device (**C**) which is connected to the EMG3435-Q20A (**D**).

Figure 91 File Sharing Overview

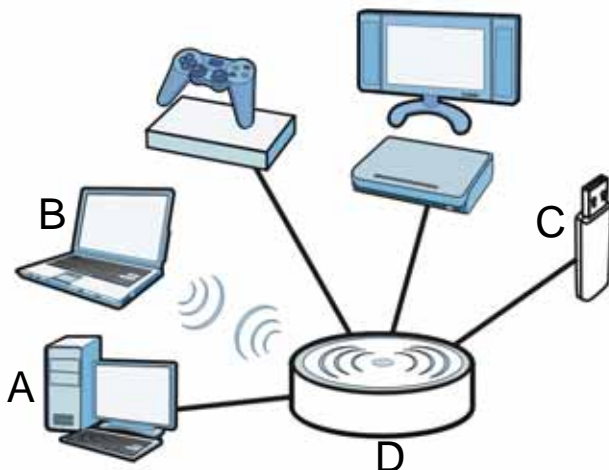

Note: The read and write performance may be affected by amount of file-sharing traffic on your network, type of connected USB device and your USB version (3.0 or 2.0).

### 13.6.1 SAMBA Server Screen

Use this screen to set up file-sharing via the EMG3435-Q20A using Windows Explorer or the workgroup name. You can also configure the workgroup name and create file-sharing user accounts.

In **Expert** mode, click **Applications** > **File Sharing** > **SAMBA** to open the following screen.

Figure 92 Expert Mode &gt; Applications &gt; File Sharing &gt; SAMBA

**SAMBA** Apply Cancel

**SAMBA Setup**

Enable SAMBA  Enable  Disable

Name

Work Group

Description

---

Require username and password  No  Yes

---

**User Accounts**

#	Enable	User Name	Password	USB1	USB2
1	<input type="checkbox"/>	<input type="text"/>	<input type="text"/>	None ▼	None ▼
2	<input type="checkbox"/>	<input type="text"/>	<input type="text"/>	None ▼	None ▼
3	<input type="checkbox"/>	<input type="text"/>	<input type="text"/>	None ▼	None ▼
4	<input type="checkbox"/>	<input type="text"/>	<input type="text"/>	None ▼	None ▼
5	<input type="checkbox"/>	<input type="text"/>	<input type="text"/>	None ▼	None ▼

The following table describes the labels in this screen.

Table 48 Expert Mode &gt; Applications &gt; File Sharing &gt; SAMBA

LABEL	DESCRIPTION
SAMBA Setup	
Enable SAMBA	Select this to enable file sharing through the EMG3435-Q20A using Windows Explorer or by browsing to your work group.
Name	Specify the name to identify the EMG3435-Q20A in a work group.
Work Group	You can add the EMG3435-Q20A to an existing or a new workgroup on your network. Enter the name of the workgroup which your EMG3435-Q20A automatically joins. You can set the EMG3435-Q20A's workgroup name to be exactly the same as the workgroup name to which your computer belongs to.  Note: The EMG3435-Q20A will not be able to join the workgroup if your local area network has restrictions set up that do not allow devices to join a workgroup. In this case, contact your network administrator.
Description	Enter the description of the EMG3435-Q20A in a work group.
Require username and password	Select <b>Yes</b> to need a user account for access to the connected USB stick from any computer. Otherwise, select <b>No</b> .
User Accounts	Before you can share files you need a user account. Configure the following fields to set up a file-sharing account.
#	This is the index number of the user account.
Enable	This field displays whether a user account is activated or not. Select the check box to enable the account. Clear the check box to disable the account.
User Name	Enter a user name that will be allowed to access the shared files. You can enter up to 20 characters. Only letters and numbers allowed.
Password	Enter the password used to access the shared files. You can enter up to 20 characters. Only letters and numbers are allowed. The password is case sensitive.

Table 48 Expert Mode &gt; Applications &gt; File Sharing &gt; SAMBA

LABEL	DESCRIPTION
USB1/USB2	Specify the user's access rights to the USB storage device which is connected to the EMG3435-Q20A's USB port.  <b>Read &amp; Write</b> - The user has read and write rights, meaning that the user can create and edit the files on the connected USB device.  <b>Read</b> - The user has read rights only and can not create or edit the files on the connected USB device.
Apply	Click <b>Apply</b> to save your changes back to the EMG3435-Q20A.
Cancel	Click <b>Cancel</b> to begin configuring this screen afresh.

## 13.6.2 FTP Server Screen

Use this screen to set up file sharing via the EMG3435-Q20A using FTP and create user accounts.

In **Expert** mode, click **Applications > File Sharing > FTP** to open the following screen.

Figure 93 Expert Mode &gt; Applications &gt; File Sharing &gt; FTP

#	Enable	User Name	Password	USB1	USB2	Upstream Bandwidth	Downstream Bandwidth
1	<input checked="" type="checkbox"/>	TEST	****	Read	Read	1000	1000
2	<input type="checkbox"/>			None	None		
3	<input type="checkbox"/>			None	None		
4	<input type="checkbox"/>			None	None		
5	<input type="checkbox"/>			None	None		

The following table describes the labels in this screen.

Table 49 Expert Mode &gt; Applications &gt; File Sharing &gt; FTP

LABEL	DESCRIPTION
Enable FTP	Select this to enable the FTP server on the EMG3435-Q20A for file sharing using FTP.
Port	You may change the server port number for FTP if needed, however you must use the same port number in order to use that service for file sharing.
User Accounts	Before you can share files you need a user account. Configure the following fields to set up a file-sharing account.
#	This is the index number of the user account.
Enable	This field displays whether a user account is activated or not. Select the check box to enable the account. Clear the check box to disable the account.
User Name	Enter a user name that will be allowed to access the shared files. You can enter up to 20 characters. Only letters and numbers allowed.
Password	Enter the password used to access the shared files. You can enter up to 20 characters. Only letters and numbers are allowed. The password is case sensitive.

Table 49 Expert Mode &gt; Applications &gt; File Sharing &gt; FTP

LABEL	DESCRIPTION
USB1/USB2	Specify the user's access rights to the USB storage device which is connected to the EMG3435-Q20A's USB port.  <b>Read &amp; Write</b> - The user has read and write rights, meaning that the user can create and edit the files on the connected USB device.  <b>Read</b> - The user has read rights only and can not create or edit the files on the connected USB device.  <b>None</b> - The user cannot access the files on the USB device(s) connected to the USB port.
Upstream Bandwidth	Enter the maximum bandwidth (in Kbps) allowed for incoming FTP traffic.
Downstream Bandwidth	Enter the maximum bandwidth (in Kbps) allowed for outgoing FTP traffic.
Apply	Click <b>Apply</b> to save your changes back to the EMG3435-Q20A.
Cancel	Click <b>Cancel</b> to begin configuring this screen afresh.

### 13.6.3 Example of Accessing Your Shared Files From a Computer

You can use Windows Explorer or FTP to access the USB storage devices connected to the EMG3435-Q20A.

This example shows you how to use Microsoft's Windows XP to browse your shared files. Refer to your operating system's documentation for how to browse your file structure.

#### Use Windows Explorer to Share Files

You should have enabled file sharing and create a user account (Bob/1234 for example) with read and write access to USB 1 in the **Applications > File Sharing > SAMBA** screen.

Open Windows Explorer to access the connected USB device using either Windows Explorer browser or by browsing to your workgroup.

- 1 In Windows Explorer's Address bar type a double backslash "\\\" followed by the IP address of the EMG3435-Q20A (the default IP address of the EMG3435-Q20A in router mode is 192.168.1.1) and press [ENTER]. A screen asking for password authentication appears. Type the user name and password (Bob and 1234 in this example) and click OK.

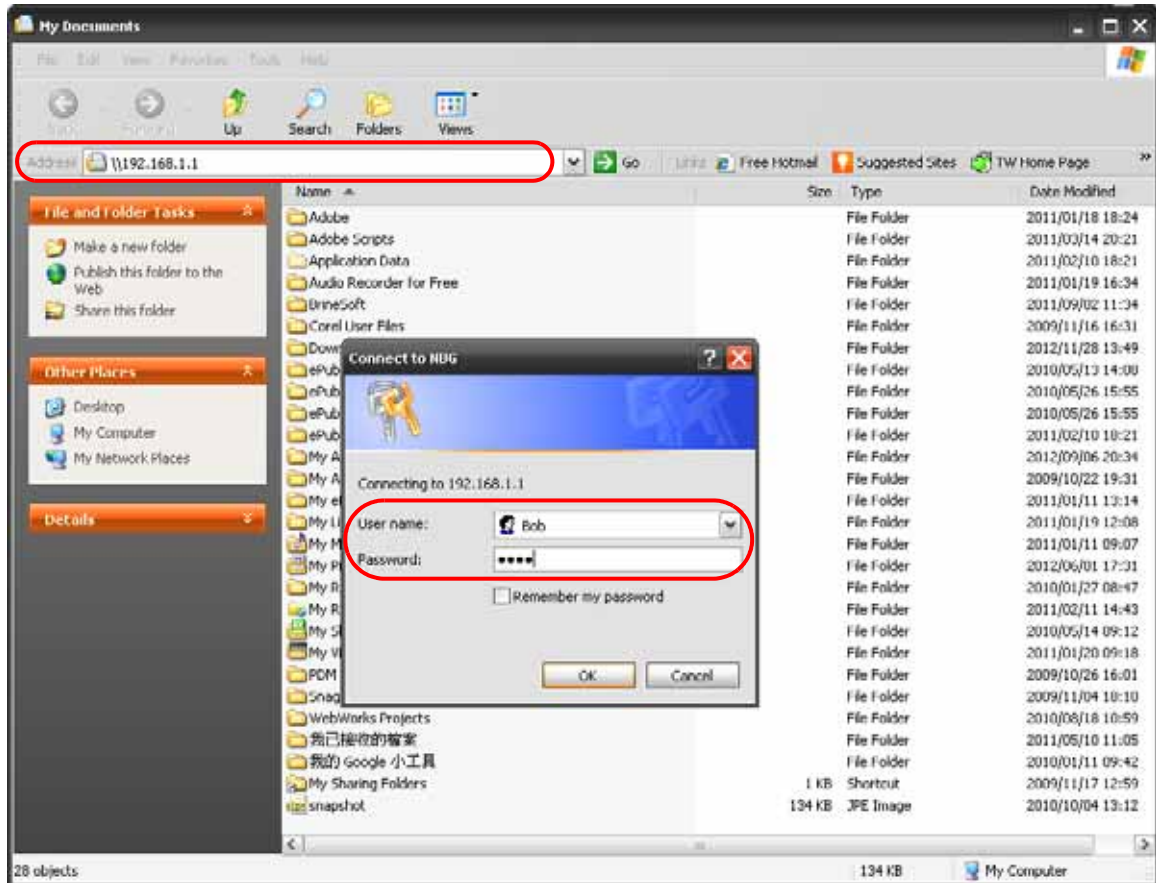

Note: Once you log into the shared folder via your EMG3435-Q20A, you do not have to relogin unless you restart your computer.

- 2 You can also use the workgroup name to access files by browsing to the workgroup folder using the folder tree on the left side of the screen. It is located under **My Network Places**. In this example the workgroup name is the default "Workgroup".

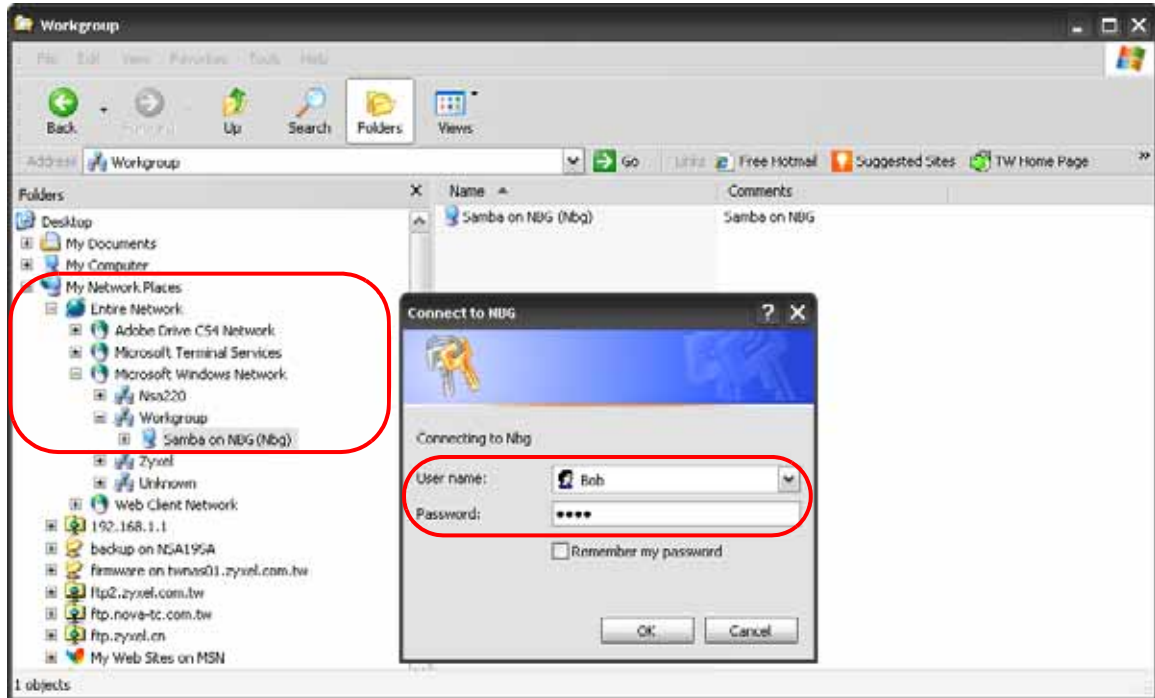

## Use FTP to Share Files

You can use FTP to access the USB storage devices connected to the EMG3435-Q20A. In this example, we use the web browser to share files via FTP from the LAN. The way or screen you log into the FTP server (on the EMG3435-Q20A) varies depending on your FTP client. See your FTP client documentation for more information.

You should have enabled file sharing and create a user account (Bob/1234 for example) with read and write access to USB 1 in the **Applications > File Sharing > FTP** screen.

- 1 In your web browser's address or URL bar type "ftp://" followed by the IP address of the EMG3435-Q20A (the default LAN IP address of the EMG3435-Q20A in router mode is 192.168.1.1) and click **Go** or press [ENTER].

- 2 A screen asking for password authentication appears. Enter the user name and password (you configured in the **Applications > File Sharing > FTP** screen) and click **Log On**.

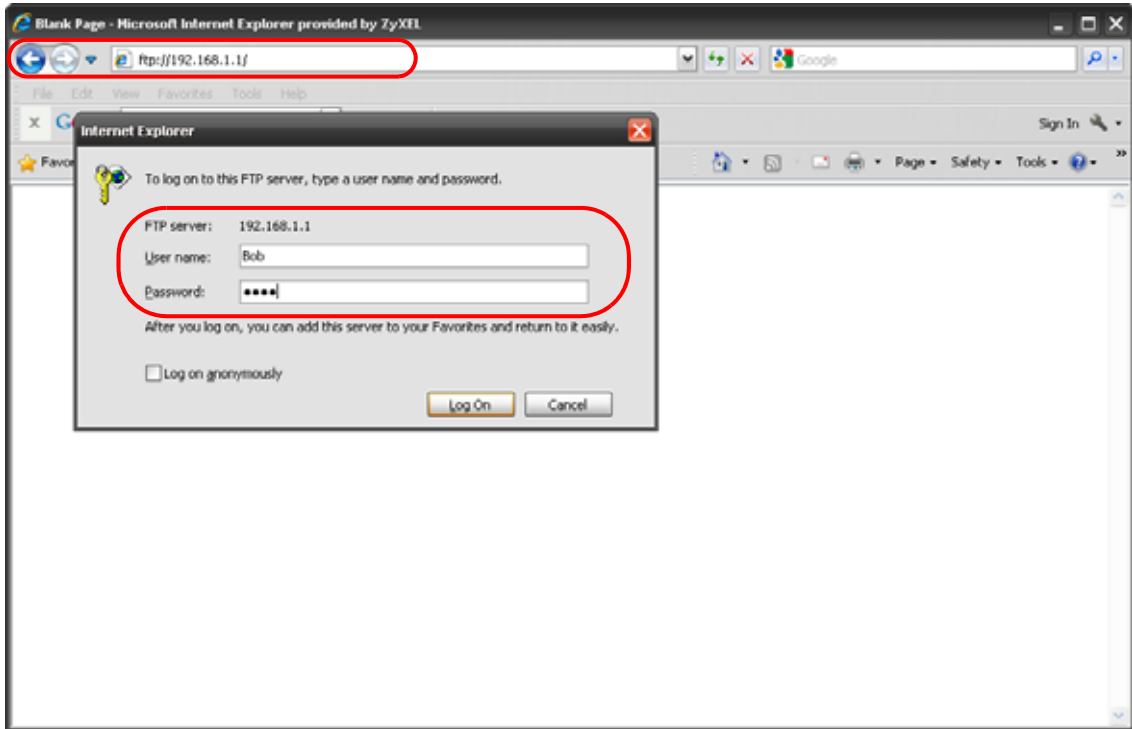

- 3 The screen changes and shows you the folder for the USB storage device connected to your EMG3435-Q20A. Double-click the folder to display the contents in it.

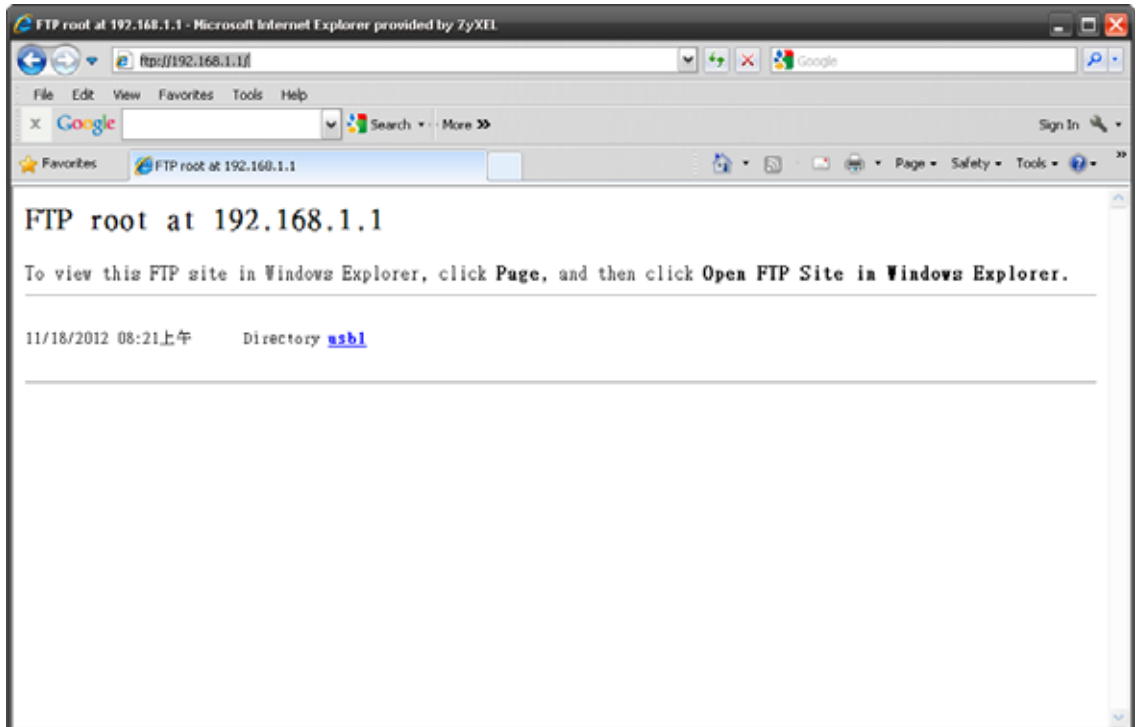



## 13.7 ONE Connect Screen

One Connect is a Zyxel-proprietary feature. It complies with the IEEE 1905.1 standard and allows auto-detection and auto-configuration.

If your wireless router supports Zyxel ONE Connect, EMG3435-Q20A for example, you can download and install the Zyxel ONE Connect App in your mobile device to check the connection status, do speed test, turn on or turn off the devices in your network, block or allow a device's access and set up a guest Wi-Fi network from the mobile device. You can even use the App to access the EMG3435-Q20A's web configurator. The mobile device with the App installed must be connected to the EMG3435-Q20A wirelessly.

Note: You have to go to <https://mycloud.zyxel.com> and pair your device again when you reset the EMG3435-Q20A.

**Figure 94** Zyxel ONE Connect App



Use this screen to enable or disable Wi-Fi auto-configuration on the EMG3435-Q20A.

In **Expert** mode, click **Applications** > **ONE Connect** to open the following screen.

**Figure 95** Mode NE



The following table describes the labels in this screen.

Table 50 Expert Mode > Applications > ONE Connect

LABEL	DESCRIPTION
ONE Connect	
QR Code	Scan the QR code and go to a website to download the Zyxel ONE Connect App in your mobile device. One is for the iTunes App Store, and the other is for Google Play.

Table 50 Expert Mode &gt; Applications &gt; ONE Connect

LABEL	DESCRIPTION
ONE Connect Compatible Devices	
Automatically Update AP/ Repeater Wi-Fi Settings	Select <b>Enable</b> to allow the EMG3435-Q20A to automatically update the wireless settings on the APs or wireless repeaters (which also support Zyxel One Connect) in its network. Select <b>Disable</b> to turn this feature off if you want to have the APs or repeaters in the network use different wireless settings.
Apply	Click <b>Apply</b> to save your changes back to the EMG3435-Q20A.
Cancel	Click <b>Cancel</b> to begin configuring this screen afresh.

## 13.8 Technical Reference

The following section contains additional technical information about the EMG3435-Q20A features described in this chapter.

### Customizing Keyword Blocking URL Checking

You can use commands to set how much of a website's URL the content filter is to check for keyword blocking. See the appendices for information on how to access and use the command interpreter.

#### Domain Name or IP Address URL Checking

By default, the EMG3435-Q20A checks the URL's domain name or IP address when performing keyword blocking.

This means that the EMG3435-Q20A checks the characters that come before the first slash in the URL.

For example, with the URL [www.zyxel.com.tw/news/pressroom.php](http://www.zyxel.com.tw/news/pressroom.php), content filtering only searches for keywords within [www.zyxel.com.tw](http://www.zyxel.com.tw).

#### Full Path URL Checking

Full path URL checking has the EMG3435-Q20A check the characters that come before the last slash in the URL.

For example, with the URL [www.zyxel.com.tw/news/pressroom.php](http://www.zyxel.com.tw/news/pressroom.php), full path URL checking searches for keywords within [www.zyxel.com.tw/news/](http://www.zyxel.com.tw/news/).

Use the `ip urlfilter customize actionFlags 6 [disable | enable]` command to extend (or not extend) the keyword blocking search to include the URL's full path.

#### File Name URL Checking

Filename URL checking has the EMG3435-Q20A check all of the characters in the URL.

For example, filename URL checking searches for keywords within the URL [www.zyxel.com.tw/news/pressroom.php](http://www.zyxel.com.tw/news/pressroom.php).

Use the `ip urlfilter customize actionFlags 8 [disable | enable]` command to extend (or not extend) the keyword blocking search to include the URL's complete filename.

### **NAT Traversal**

UPnP NAT traversal automates the process of allowing an application to operate through NAT. UPnP network devices can automatically configure network addressing, announce their presence in the network to other UPnP devices and enable exchange of simple product and service descriptions. NAT traversal allows the following:

- Dynamic port mapping
- Learning public IP addresses
- Assigning lease times to mappings

Windows Messenger is an example of an application that supports NAT traversal and UPnP.

See the NAT chapter for more information on NAT.

### **Cautions with UPnP**

The automated nature of NAT traversal applications in establishing their own services and opening firewall ports may present network security issues. Network information and configuration may also be obtained and modified by users in some network environments.

When a UPnP device joins a network, it announces its presence with a multicast message. For security reasons, the EMG3435-Q20A allows multicast messages on the LAN only.

All UPnP-enabled devices may communicate freely with each other without additional configuration. Disable UPnP if this is not your intention.

# CHAPTER 14

## Security

### 14.1 Overview

Use these screens to enable and configure the firewall that protects your EMG3435-Q20A and your LAN from unwanted or malicious traffic.

Enable the firewall to protect your LAN computers from attacks by hackers on the Internet and control access between the LAN and WAN. By default the firewall:

- allows traffic that originates from your LAN computers to go to all of the networks.
- blocks traffic that originates on the other networks from going to the LAN.

The following figure illustrates the default firewall action. User **A** can initiate an IM (Instant Messaging) session from the LAN to the WAN (1). Return traffic for this session is also allowed (2). However other traffic initiated from the WAN is blocked (3 and 4).

Figure 96 Default Firewall Action

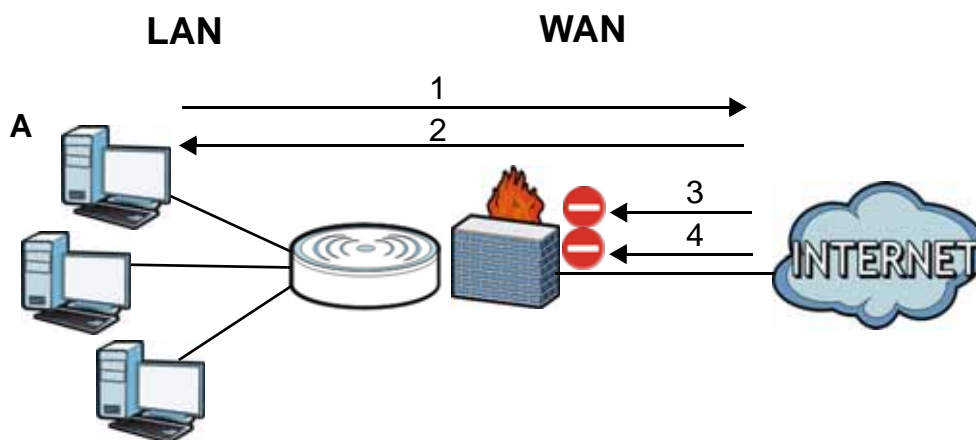

#### 14.1.1 What You Can Do

- Use the **IPv4 Firewall** screen to enable or disable the EMG3435-Q20A's IPv4 firewall ([Section 14.2 on page 141](#)).
- Use the **IPv6 Firewall** screen to enable or disable the EMG3435-Q20A's IPv6 firewall ([Section 14.3 on page 143](#)).

#### 14.1.2 What You Need To Know

The following terms and concepts may help as you read through this chapter.

## About the EMG3435-Q20A Firewall

The EMG3435-Q20A's firewall feature physically separates the LAN and the WAN and acts as a secure gateway for all data passing between the networks.

It is a stateful inspection firewall and is designed to protect against Denial of Service attacks when activated (click the **IPv4 Firewall** or **IPv6 Firewall** tab under **Security** and then click the **Enable Firewall** check box). The EMG3435-Q20A's purpose is to allow a private Local Area Network (LAN) to be securely connected to the Internet. The EMG3435-Q20A can be used to prevent theft, destruction and modification of data, as well as log events, which may be important to the security of your network.

The EMG3435-Q20A is installed between the LAN and a broadband modem connecting to the Internet. This allows it to act as a secure gateway for all data passing between the Internet and the LAN.

The EMG3435-Q20A has one Ethernet WAN port and four Ethernet LAN ports, which are used to physically separate the network into two areas. The WAN (Wide Area Network) port attaches to the broadband (cable or DSL) modem to the Internet.

The LAN (Local Area Network) port attaches to a network of computers, which needs security from the outside world. These computers will have access to Internet services such as e-mail, FTP and the World Wide Web. However, "inbound access" is not allowed (by default) unless the remote host is authorized to use a specific service.

## Guidelines For Enhancing Security With Your Firewall

- 1 Change the default password via Web Configurator.
- 2 Think about access control before you connect to the network in any way, including attaching a modem to the port.
- 3 Limit who can access your router.
- 4 Don't enable any local service (such as NTP) that you don't use. Any enabled service could present a potential security risk. A determined hacker might be able to find creative ways to misuse the enabled services to access the firewall or the network.
- 5 For local services that are enabled, protect against misuse. Protect by configuring the services to communicate only with specific peers, and protect by configuring rules to block packets for the services at specific interfaces.
- 6 Protect against IP spoofing by making sure the firewall is active.
- 7 Keep the firewall in a secured (locked) room.

## 14.2 IPv4 Firewall Screen

Use this screen to enable or disable the EMG3435-Q20A's IPv4 firewall. Click **Expert Mode > Security > IPv4 Firewall** to open the firewall setup screen.

Figure 97 Expert Mode &gt; Security &gt; IPv4 Firewall

**IPv4 Firewall** Apply Cancel

**ICMP**  
Respond to Ping on:

---

**Firewall Setup**  
Enable Firewall

---

**Enable Firewall Rule**  
Enable Firewall Rule   
Filter table type  DROP  ACCEPT

---

**Add Firewall Rule**  
Service Name :   
MAC Address :   
Dest IP Address :   
Source IP Address :   
Protocol :   
Dest Port Range :  -   
Source Port Range :  -

---

**Firewall Rule (Max Limit : 64)**

#	Service Name	MAC Address	Dest IP	Source IP	Protocol	Dest Port Range	Source Port Range
1	TEST	00:AC:AB:AA:00:AA	192.168.1.100	0.0.0.0	TCP	-	-

The following table describes the labels in this screen.

Table 51 Expert Mode &gt; Security &gt; IPv4 Firewall

LABEL	DESCRIPTION
ICMP	Internet Control Message Protocol is a message control and error-reporting protocol between a host server and a gateway to the Internet. ICMP uses Internet Protocol (IP) datagrams, but the messages are processed by the TCP/IP software and directly apparent to the application user.
Respond to Ping on	The EMG3435-Q20A will not respond to any incoming Ping requests when <b>Disable</b> is selected. Select <b>LAN</b> to reply to incoming LAN Ping requests. Select <b>WAN</b> to reply to incoming WAN Ping requests. Otherwise select <b>LAN&amp;WAN</b> to reply to all incoming LAN and WAN Ping requests.
Firewall Setup	
Enable Firewall	Select this check box to activate the firewall. The EMG3435-Q20A performs access control and protects against Denial of Service (DoS) attacks when the firewall is activated.
Enable Firewall Rule	
Enable Firewall Rule	Select this check box to activate the firewall rules that you define (see Add Firewall Rule below).
Filter table type	Select <b>DROP</b> to silently discard the packets which meet the firewall rules. The others are accepted.  Select <b>ACCEPT</b> to allow the passage of the packets which meet the firewall rules. The others are blocked.

Table 51 Expert Mode &gt; Security &gt; IPv4 Firewall (continued)

LABEL	DESCRIPTION
Add Firewall Rule	
Service Name	Enter a name that identifies or describes the firewall rule.
MAC Address	Enter the MAC address of the computer for which the firewall rule applies.
Dest IP Address	Enter the IP address of the computer to which traffic for the application or service is entering. The EMG3435-Q20A applies the firewall rule to traffic initiating from this computer.
Source IP Address	Enter the IP address of the computer that initializes traffic for the application or service. The EMG3435-Q20A applies the firewall rule to traffic initiating from this computer.
Protocol	Select the protocol ( <b>TCP</b> , <b>UDP</b> or <b>ICMP</b> ) used to transport the packets for which you want to apply the firewall rule.
Dest Port Range	This is the port number/range of the destination that define the traffic type, for example TCP port 80 defines web traffic.
Source Port Range	This is the port number/range of the source that define the traffic type, for example TCP port 80 defines web traffic.
Add Rule	Click <b>Add Rule</b> to save the firewall rule.
Firewall Rule	
#	This is your firewall rule number. The ordering of your rules is important as rules are applied in turn.
Service Name	This is a name that identifies or describes the firewall rule.
MAC adresse	This is the MAC address of the computer for which the firewall rule applies.
Dest IP	This is the IP address of the computer to which traffic for the application or service is entering.
Source IP	This is the IP address of the computer from which traffic for the application or service is initialized.
Protocol	This is the protocol ( <b>TCP</b> , <b>UDP</b> or <b>ICMP</b> ) used to transport the packets for which you want to apply the firewall rule.
Dest Port Range	This is the port number/range of the destination that define the traffic type, for example TCP port 80 defines web traffic.
Source Port Range	This is the port number/range of the source that define the traffic type, for example TCP port 80 defines web traffic.
Delete	Click  to remove the firewall rule.
Apply	Click <b>Apply</b> to save the settings.
Cancel	Click <b>Cancel</b> to start configuring this screen again.

## 14.3 IPv6 Firewall Screen

This chapter shows you how to enable and create IPv6 firewall rules to filter IPv6 traffic.

Click **Expert Mode > Security > IPv6 Firewall**. The **IPv6 Firewall** screen appears as shown.

**Figure 98** Expert Mode > Security > IPv6 Firewall

The following table describes the labels in this screen.

**Table 52** Expert Mode > Security > IPv6 Firewall

LABEL	DESCRIPTION
Enable Firewall Rule	
Enable Firewall Rule	Select this check box to activate the firewall rules that you define (see <b>Add Firewall Rule</b> below).
Action	Select <b>DROP</b> to silently discard the packets which meet the firewall rules. The others are accepted.  Select <b>ACCEPT</b> to allow the passage of the packets which meet the firewall rules. The others are blocked.
Add Firewall Rule	
Service Name	Enter a name that identifies or describes the firewall rule.
MAC Address	Enter the MAC address of the computer for which the firewall rule applies.
Dest IP Address	Enter the IPv6 address of the computer to which traffic for the application or service is entering.  The EMG3435-Q20A applies the firewall rule to traffic destined for this computer.
Source IP Address	Enter the IPv6 address of the computer that initializes traffic for the application or service.  The EMG3435-Q20A applies the firewall rule to traffic initiating from this computer.
Protocol	Select the protocol ( <b>TCP</b> , <b>UDP</b> or <b>ICMPv6</b> ) used to transport the packets for which you want to apply the firewall rule.
Dest Port Range	Enter the port number/range of the destination that defines the traffic type, for example TCP port 80 defines web traffic.
Source Port Range	Enter the port number/range of the source that defines the traffic type, for example TCP port 80 defines web traffic.



Table 52 Expert Mode &gt; Security &gt; IPv6 Firewall (continued)

LABEL	DESCRIPTION
Add Rule	Click <b>Add Rule</b> to save the firewall rule.
Firewall Rule	
#	This is your firewall rule number. The ordering of your rules is important as rules are applied in turn.
ServiceName	This is a name that identifies or describes the firewall rule.
MAC Address	This is the MAC address of the computer for which the firewall rule applies.
Dest IP	This is the IP address of the computer to which traffic for the application or service is entering.
Source IP	This is the IP address of the computer to which traffic for the application or service is initialized.
Protocol	This is the protocol ( <b>TCP</b> , <b>UDP</b> or <b>ICMPv6</b> ) used to transport the packets for which you want to apply the firewall rule.
Dest Port Range	This is the port number/range of the destination that defines the traffic type, for example TCP port 80 defines web traffic.
Source Port Range	This is the port number/range of the source that defines the traffic type, for example TCP port 80 defines web traffic.
Delete	Click  to remove the firewall rule.
Apply	Click <b>Apply</b> to save the settings.
Cancel	Click <b>Cancel</b> to restore your previously saved settings.

# CHAPTER 15

## Maintenance

### 15.1 Overview

This chapter provides information on the **Maintenance** screens.

### 15.2 What You Can Do

- Use the **General** screen to set the timeout period of the management session ([Section 15.3 on page 146](#)).
- Use the **Password** screen to change your EMG3435-Q20A's system password ([Section 15.4 on page 147](#)).
- Use the **Time** screen to change your EMG3435-Q20A's time and date ([Section 15.5 on page 148](#)).
- Use the **Firmware Upgrade** screen to upload firmware to your EMG3435-Q20A ([Section 15.6 on page 149](#)).
- Use the **Backup/Restore** screen to view information related to factory defaults, backup configuration, and restoring configuration ([Section 15.7 on page 151](#)).
- Use the **Restart** screen to reboot the EMG3435-Q20A without turning the power off ([Section 15.8 on page 152](#)).
- Use the **Language** screen to change the language for the Web Configurator ([Section 15.9 on page 152](#)).
- Use the **Remote Management** screen to configure the interface/s from which the EMG3435-Q20A can be managed remotely and specify a secure client that can manage the EMG3435-Q20A. ([Section 15.10 on page 153](#)).
- Use the **Log** screen to see the logs for the activity on the EMG3435-Q20A ([Section 15.11 on page 156](#)).
- Use the **Operation Mode** screen to select how you want to use your EMG3435-Q20A ([Section 15.13 on page 158](#)).

### 15.3 General Screen

Use this screen to set the management session timeout period. Click **Expert Mode > Maintenance > General**. The following screen displays.

Figure 99 Expert Mode &gt; Maintenance &gt; General

General		Apply	Cancel
System Name :	<input type="text" value="NBG6817"/>		
Domain Name :	<input type="text" value="local"/>		
Administrator Inactivity Timer :	<input type="text" value="0"/>		(minutes, 0 means no timeout)

The following table describes the labels in this screen.

Table 53 Expert Mode &gt; Maintenance &gt; General

LABEL	DESCRIPTION
System Name	System Name is a unique name to identify the EMG3435-Q20A in an Ethernet network.
Domain Name	Enter the domain name you want to give to the EMG3435-Q20A.
Administrator Inactivity Timer	Type how many minutes a management session can be left idle before the session times out. The default is 5 minutes. After it times out you have to log in with your password again. Very long idle timeouts may have security risks. A value of "0" means a management session never times out, no matter how long it has been left idle (not recommended).
Apply	Click <b>Apply</b> to save your changes back to the EMG3435-Q20A.
Cancel	Click <b>Cancel</b> to begin configuring this screen afresh.

## 15.4 Password Screen

It is strongly recommended that you change your EMG3435-Q20A's password.

If you forget your EMG3435-Q20A's password (or IP address), you will need to reset the device. See [Section 15.8 on page 152](#) for details.

Click **Expert Mode > Maintenance > Password**. The screen appears as shown.

Figure 100 Expert Mode &gt; Maintenance &gt; Password

Password		Apply	Cancel
Old Password :	<input type="text"/>		
New Password :	<input type="text"/>		
Retype to Confirm :	<input type="text"/>		

The following table describes the labels in this screen.

Table 54 Expert Mode &gt; Maintenance &gt; Password

LABEL	DESCRIPTION
Old Password	Type the default password or the existing password you use to access the system in this field.
New Password	Type your new system password (up to 30 characters). Note that as you type a password, the screen displays an asterisk (*) for each character you type.
Retype to Confirm	Type the new password again in this field.

Table 54 Expert Mode &gt; Maintenance &gt; Password (continued)

LABEL	DESCRIPTION
Apply	Click <b>Apply</b> to save your changes back to the EMG3435-Q20A.
Cancel	Click <b>Cancel</b> to begin configuring this screen afresh.

## 15.5 Time Screen

Use this screen to configure the EMG3435-Q20A's time based on your local time zone. To change your EMG3435-Q20A's time and date, click **Expert Mode > Maintenance > Time**. The screen appears as shown.

Figure 101 Expert Mode &gt; Maintenance &gt; Time

The following table describes the labels in this screen.

Table 55 Expert Mode &gt; Maintenance &gt; Time

LABEL	DESCRIPTION
Current Time and Date	
Current Time	This field displays the time of your EMG3435-Q20A. Each time you reload this page, the EMG3435-Q20A synchronizes the time with the time server.
Current Date	This field displays the date of your EMG3435-Q20A. Each time you reload this page, the EMG3435-Q20A synchronizes the date with the time server.
Time and Date Setup	
Manual	Select this radio button to enter the time and date manually. If you configure a new time and date, Time Zone and Daylight Saving at the same time, the new time and date you entered has priority and the Time Zone and Daylight Saving settings do not affect it.

Table 55 Expert Mode &gt; Maintenance &gt; Time (continued)

LABEL	DESCRIPTION
New Time (hh:mm:ss)	This field displays the last updated time from the time server or the last time configured manually.  When you select <b>Manual</b> , enter the new time in this field and then click <b>Apply</b> .
New Date (yyyy/mm/dd)	This field displays the last updated date from the time server or the last date configured manually.  When you select <b>Manual</b> , enter the new date in this field and then click <b>Apply</b> .
Get from Time Server	Select this radio button to have the EMG3435-Q20A get the time and date from the time server you specified below.
User Defined Time Server Address	Select <b>User Defined Time Server Address</b> and enter the IP address or URL (up to 20 extended ASCII characters in length) of your time server. Check with your ISP/network administrator if you are unsure of this information.
Time Zone Setup	
Time Zone	Choose the time zone of your location. This will set the time difference between your time zone and Greenwich Mean Time (GMT).
Daylight Savings	Daylight saving is a period from late spring to early fall when many countries set their clocks ahead of normal local time by one hour to give more daytime light in the evening.  Select this option if you use Daylight Saving Time.
Start Date	Configure the day and time when Daylight Saving Time starts if you selected <b>Daylight Savings</b> . The <b>at</b> field uses the 24 hour format. Here are a couple of examples:  Daylight Saving Time starts in most parts of the United States on the second Sunday of March. Each time zone in the United States starts using Daylight Saving Time at 2 A.M. local time. So in the United States you would select <b>Second, Sunday, March</b> and select <b>2</b> in the <b>at</b> field.  Daylight Saving Time starts in the European Union on the last Sunday of March. All of the time zones in the European Union start using Daylight Saving Time at the same moment (1 A.M. GMT or UTC). So in the European Union you would select <b>Last, Sunday, March</b> . The time you select in the <b>at</b> field depends on your time zone. In Germany for instance, you would select <b>2</b> because Germany's time zone is one hour ahead of GMT or UTC (GMT+1).
End Date	Configure the day and time when Daylight Saving Time ends if you selected <b>Daylight Savings</b> . The <b>at</b> field uses the 24 hour format. Here are a couple of examples:  Daylight Saving Time ends in the United States on the first Sunday of November. Each time zone in the United States stops using Daylight Saving Time at 2 A.M. local time. So in the United States you would select <b>First, Sunday, November</b> and select <b>2</b> in the <b>at</b> field.  Daylight Saving Time ends in the European Union on the last Sunday of October. All of the time zones in the European Union stop using Daylight Saving Time at the same moment (1 A.M. GMT or UTC). So in the European Union you would select <b>Last, Sunday, October</b> . The time you select in the <b>at</b> field depends on your time zone. In Germany for instance, you would select <b>2</b> because Germany's time zone is one hour ahead of GMT or UTC (GMT+1).
Apply	Click <b>Apply</b> to save your changes back to the EMG3435-Q20A.
Cancel	Click <b>Cancel</b> to begin configuring this screen afresh.

## 15.6 Firmware Upgrade Screen

Find firmware at [www.zyxel.com](http://www.zyxel.com) in a file that uses the version number and project code with a "\*.bin" extension, e.g., "V1.00(ABCS.0)C0.bin". The upload process uses HTTP (Hypertext Transfer Protocol) and may take up to two minutes. After a successful upload, the system will reboot.

Click **Expert Mode > Maintenance > Firmware Upgrade**. Follow the instructions in this screen to upload firmware to your EMG3435-Q20A.

**Figure 102** Expert Mode > Maintenance > Firmware Upgrade

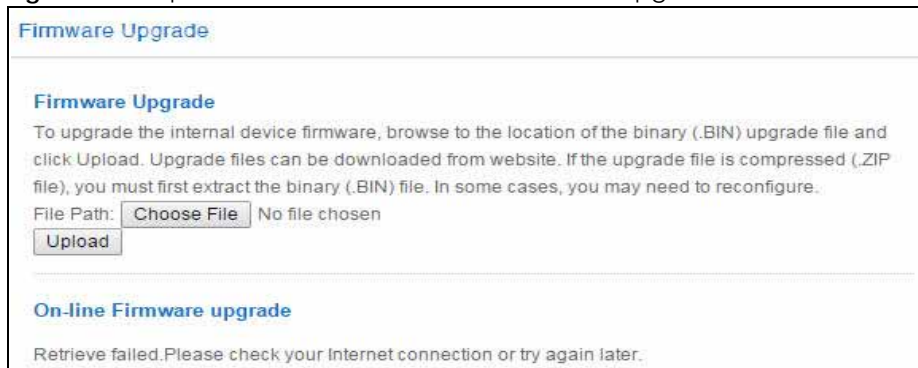

The following table describes the labels in this screen.

**Table 56** Expert Mode > Maintenance > Firmware Upgrade

LABEL	DESCRIPTION
File Path	Click <b>Choose File</b> to find the location of the file you want to upload in this field.
Choose File	Click <b>Choose File</b> to find the .bin file you want to upload. Remember that you must decompress compressed (.zip) files before you can upload them.
Upload	Click <b>Upload</b> to begin the upload process. This process may take up to two minutes.
Check for Latest Firmware Now	Click this to check for the latest updated firmware.

Note: Do not turn off the EMG3435-Q20A while firmware upload is in progress!

After you see the **Firmware Upload In Process** screen, wait two minutes before logging into the EMG3435-Q20A again.

The EMG3435-Q20A automatically restarts in this time causing a temporary network disconnect. In some operating systems, you may see the following icon on your desktop.

**Figure 103** Network Temporarily Disconnected



After several minutes, log in again and check your new firmware version in the **Status** screen.

If the upload was not successful, an error message appears. Click **Return** to go back to the **Firmware Upgrade** screen.

## 15.7 Backup/Restore Screen

Backup configuration allows you to back up (save) the EMG3435-Q20A's current configuration to a file on your computer. Once your EMG3435-Q20A is configured and functioning properly, it is highly recommended that you back up your configuration file before making configuration changes. The backup configuration file will be useful in case you need to return to your previous settings.

Restore configuration allows you to upload a new or previously saved configuration file from your computer to your EMG3435-Q20A.

Click **Expert Mode > Maintenance > Backup/Restore**. Information related to factory defaults, backup configuration, and restoring configuration appears as shown next.

**Figure 104** Expert Mode > Maintenance > Backup/Restore

The screenshot shows a web interface for the EMG3435-Q20A. At the top, it says 'Backup/Restore'. Below this, there are three sections:

- Backup Configuration:** A heading followed by the instruction 'Click Backup to save the current configuration of your system to your computer.' and a 'Backup' button.
- Restore Configuration:** A heading followed by the instruction 'To restore a previously saved configuration file to your system, browse to the location of the configuration file and click Upload.' Below this is a 'File Path:' label, a 'Choose File' button, and the text 'No file chosen'. An 'Upload' button is located below the file path field.
- Back to Factory Defaults:** A heading followed by the instruction 'Click Reset to clear all user-entered configuration information and return to factory defaults. After resetting, the' and a list of default settings: '- Password will be 1234', '- LAN IP address will be 192.168.1.1', and '- DHCP will be reset to server'. A 'Reset' button is at the bottom of this section.

The following table describes the labels in this screen.

**Table 57** Expert Mode > Maintenance > Backup/Restore

LABEL	DESCRIPTION
Backup	Click <b>Backup</b> to save the EMG3435-Q20A's current configuration to your computer.
File Path	Click <b>Choose File</b> to find the location of the file you want to upload in this field.
Choose File	Click <b>Choose File</b> to find the file you want to upload. Remember that you must decompress compressed (.ZIP) files before you can upload them.

Table 57 Expert Mode &gt; Maintenance &gt; Backup/Restore (continued)

LABEL	DESCRIPTION
Upload	<p>Click <b>Upload</b> to begin the upload process.</p> <p>Note: Do not turn off the EMG3435-Q20A while configuration file upload is in progress.</p> <p>After you see a "configuration upload successful" screen, you must then wait one minute before logging into the EMG3435-Q20A again. The EMG3435-Q20A automatically restarts in this time causing a temporary network disconnect.</p> <p>If you see an error screen, click Back to return to the Backup/Restore screen.</p>
Reset	<p>Pressing the <b>Reset</b> button in this section clears all user-entered configuration information and returns the EMG3435-Q20A to its factory defaults.</p> <p>You can also press the <b>RESET</b> button on the rear panel to reset the factory defaults of your EMG3435-Q20A. Refer to the chapter about introducing the Web Configurator for more information on the <b>RESET</b> button.</p>

Note: If you uploaded the default configuration file you may need to change the IP address of your computer to be in the same subnet as that of the default EMG3435-Q20A IP address (192.168.1.1). See [Appendix B on page 173](#) for details on how to set up your computer's IP address.

## 15.8 Restart Screen

System restart allows you to reboot the EMG3435-Q20A without turning the power off.

Click **Expert Mode > Maintenance > Restart** to open the following screen.

**Figure 105** Expert Mode > Maintenance > Restart

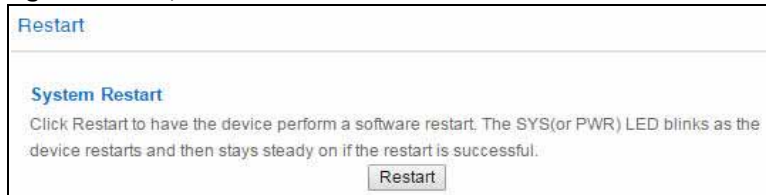

Click **Restart** to have the EMG3435-Q20A reboot. This does not affect the EMG3435-Q20A's configuration.

## 15.9 Language Screen

Use this screen to change the language for the Web Configurator.

Select the language you prefer and click **Apply**. The Web Configurator language changes after a while without restarting the EMG3435-Q20A. Click **Expert Mode > Maintenance > Language** to open the following screen.



**Figure 106** Expert Mode > Maintenance > Language

The screenshot shows a web interface for language selection. At the top left, the word "Language" is displayed in blue. To its right are two buttons: "Apply" and "Cancel". Below this, the text "Language selection :" is followed by a dropdown menu currently set to "English".

## 15.10 Remote Management Screen

Remote Management allows you to manage your EMG3435-Q20A from a remote location through the LAN/WLAN or WAN interface.

### 15.10.1 Remote Access

Use this screen to change your EMG3435-Q20A's remote management settings. You can use Telnet, HTTP or HTTPS to access and manage the EMG3435-Q20A.

Click **Expert Mode > Maintenance > Remote Management > Remote Access** to open the following screen.

**Figure 107** Expert Mode > Maintenance > Remote Management > Remote Access

**Remote Access** Apply Cancel

**WWW**

Port:

Access Status:

Secured Client IP Address:  All  Selected

**Note:**

1. For UPnP to function normally, the HTTP service must be available for LAN computers using UPnP.
2. You may also need to create a Firewall rule.

---

**Telnet**

Port:

Access Status:

Secured Client IP Address:  All  Selected

**Note:**

You may also need to create a Firewall rule.

---

**HTTPS**

Port:

Access Status:

Secured Client IP Address:  All  Selected

**Note:**

You may also need to create a Firewall rule.

The following table describes the labels in this screen.

**Table 58** Expert Mode > Maintenance > Remote Management > WAN Access

LABEL	DESCRIPTION
WWW	
Port	You may change the server port number for a service if needed, however you must use the same port number in order to use that service for remote management.
Access Status	Select the interface(s) through which a computer may access the EMG3435-Q20A using this service.
Secured Client IP Address	Select <b>All</b> to allow all computers to access the EMG3435-Q20A. Otherwise, check <b>Selected</b> and specify the IP address of the computer that can access the EMG3435-Q20A.
Telnet	

Table 58 Expert Mode &gt; Maintenance &gt; Remote Management &gt; WAN Access

LABEL	DESCRIPTION
Port	You may change the server port number for a service if needed, however you must use the same port number in order to use that service for remote management.
Access Status	Select the interface(s) through which a computer may access the EMG3435-Q20A using this service.
Secured Client IP Address	Select <b>All</b> to allow all computes to access the EMG3435-Q20A. Otherwise, check <b>Selected</b> and specify the IP address of the computer that can access the EMG3435-Q20A.
HTTPS	
Port	You may change the server port number for a service if needed, however you must use the same port number in order to use that service for remote management.
Access Status	Select the interface(s) through which a computer may access the EMG3435-Q20A using this service.
Secured Client IP Address	Select <b>All</b> to allow all computes to access the EMG3435-Q20A. Otherwise, check <b>Selected</b> and specify the IP address of the computer that can access the EMG3435-Q20A.
Apply	Click <b>Apply</b> to save your changes back to the EMG3435-Q20A.
Cancel	Click <b>Cancel</b> to begin configuring this screen afresh.

## 15.10.2 Wake On LAN

Wake On LAN (WoL) allows you to remotely turn on a device on the network, such as a computer, storage device or media server. To use this feature the remote hardware (for example the network adapter on a computer) must support Wake On LAN using the "Magic Packet" method.

You need to know the MAC address of the remote device. It may be on a label on the device.

Use this screen to remotely turn on a device on the network. Click the **Expert Mode > Maintenance > Remote Management > Wake On LAN** to open the following screen.

Figure 108 Expert Mode &gt; Maintenance &gt; Remote Management &gt; Wake On LAN

**Wake On LAN** Apply Cancel

**Wake On LAN over WAN Settings**

Enable Wake On Lan over WAN:  Enable  Disable

Port:

---

**Wake On LAN**

Wake MAC Address:

**Note:**  
Please insert the MAC Address in this format 00:00:00:00:00:00

The following table describes the labels in this screen.

Table 59 Expert Mode > Maintenance > Remote Management > Wake On LAN

LABEL	DESCRIPTION
Wake On LAN over WAN Settings	
Enable Wake On LAN over WAN	Select <b>Enable</b> to have the EMG3435-Q20A forward a WoL "Magic Packet" to all devices on the LAN if the packet comes from the WAN or remote network and uses the port number specified in the <b>Port</b> field. A LAN device whose hardware supports Wake on LAN then will be powered on if it is turned off previously.
Port	Type a port number from which a WoL packet is forwarded to the LAN.
Wake On LAN	
Wake MAC Address	This field displays the hostname and MAC address of the LAN device by default. Otherwise, select <b>User define</b> to enter the MAC Address of the device on the network that will be turned on.  A MAC address consists of six hexadecimal character pairs.
Start	Click this to have the EMG3435-Q20A generate a WoL packet and forward it to turn the specified device on.  A screen pops up displaying MAC address error if you input the MAC address incorrectly.
Apply	Click <b>Apply</b> to save your changes back to the EMG3435-Q20A.
Cancel	Click <b>Cancel</b> to begin configuring this screen afresh.

## 15.11 Log Screen

The Web Configurator allows you to look at all of the EMG3435-Q20A's logs in one location.

You can configure which logs to display in the Log screen. Select the logs you wish to display. Click **Apply** to save your settings. Click **Cancel** to start the screen afresh.

Use this screen to see the logged messages for the EMG3435-Q20A. The log wraps around and deletes the old entries after it fills. Select what logs you want to see from the **Display** drop list. The log choices depend on your settings above this screen. Click **Refresh** to renew the log screen. Click **Clear Log** to delete all the logs.

Figure 109 Expert Mode &gt; Maintenance &gt; Log

**Log** Apply Cancel

**Active Log and Alert**

Log

System Errors

On-line Firmware upgrade

Access Control

---

Display: All Logs Refresh Clear Log

**Summary**

#	Time	Message
1	2015 Jan 29 17:16:54	user.notice netprobe: netprb_info_collect: Enter
2	2015 Jan 29 17:16:44	user.notice netprobe: netprb_info_collect: Enter
3	2015 Jan 29 17:16:34	user.notice netprobe: netprb_info_collect: Enter
4	2015 Jan 29 17:16:29	daemon.info aperture-controller.sh: Sleeping 300 seconds...
5	2015 Jan 29 17:16:29	daemon.info aperture-controller.sh: Test returned -1, bw up 0 / down 0
6	2015 Jan 29 17:16:28	daemon.info aperture[14833]: (INFO) Aperture shutting down.
7	2015 Jan 29 17:16:28	daemon.info aperture[14833]: (INFO) Discarding outlier

## 15.12 System Operation Mode Overview

The **Sys OP Mode** (System Operation Mode) function lets you configure your EMG3435-Q20A as a router or access point. You can choose between **Router Mode**, and **Access Point Mode** depending on your network topology and the features you require from your device.

The following describes the device modes available in your EMG3435-Q20A.

### Router

A router connects your local network with another network, such as the Internet. The router has two IP addresses, the LAN IP address and the WAN IP address.

Figure 110 LAN and WAN IP Addresses in Router Mode

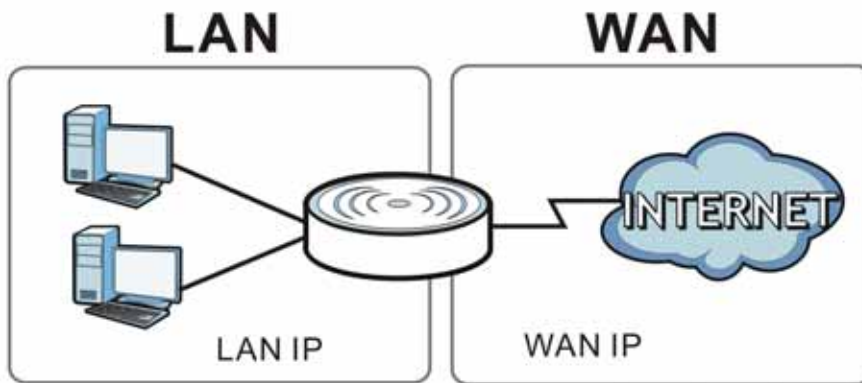

### Access Point

An access point enabled all ethernet ports to be bridged together and be in the same subnet. To connect to the Internet, another device, such as a router, is required.

Figure 111 Access Point Mode

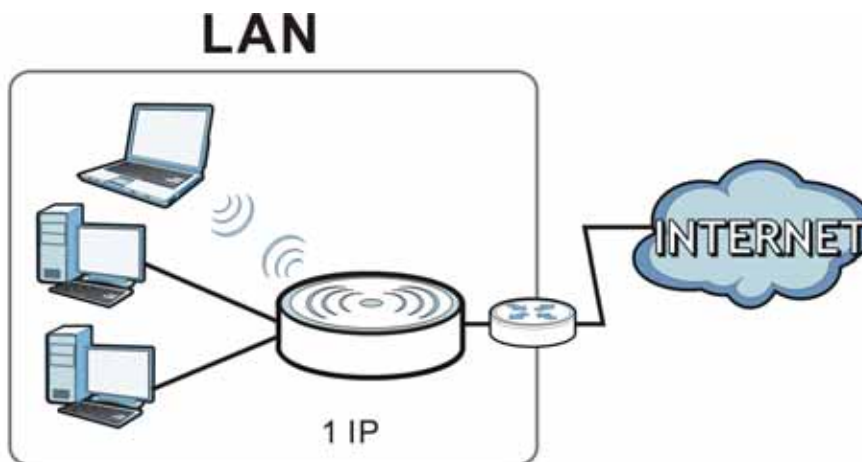

## 15.13 Operation Mode Screen

Use this screen to select how you want to use your EMG3435-Q20A.

Figure 112 Expert Mode &gt; Maintenance &gt; Operation Mode



**Operation Mode** Apply Cancel

**Configuration Mode**

Router Mode  
 Access Point Mode

**Note:**

**Router:** In this mode, the device is supported to connect to internet via ADSL/Cable Modem. PCs in LAN ports share the same IP to ISP through WAN Port.

**Access Point:** In this mode, all Ethernet ports are bridged together. The device allows the wireless-equipped computer can communicate with a wired network.

The following table describes the labels in the **Operation Mode** screen.

Table 60 Expert Mode &gt; Maintenance &gt; Operation Mode

LABEL	DESCRIPTION
Configuration Mode	
Router Mode	Select <b>Router Mode</b> if your device routes traffic between a local network and another network such as the Internet. This mode offers services such as a firewall or bandwidth management.  You can configure the IP address settings on your WAN port. Contact your ISP or system administrator for more information on appropriate settings.
Access Point Mode	Select <b>Access Point Mode</b> if your device bridges traffic between clients on the same network. <ul style="list-style-type: none"> <li>In <b>Access Point Mode</b>, all Ethernet ports have the same IP address.</li> <li>All ports on the rear panel of the device are LAN ports, including the port labeled WAN. There is no WAN port.</li> <li>The DHCP server on your device is disabled.</li> <li>Router functions (such as NAT, bandwidth management, remote management, firewall and so on) are not available when the EMG3435-Q20A is in <b>Access Point Mode</b>.</li> <li>The IP address of the device on the local network is set to 192.168.1.2.</li> </ul>
Apply	Click <b>Apply</b> to save your settings.
Cancel	Click <b>Cancel</b> to return your settings to the default ( <b>Router</b> ).

Note: If you select the incorrect system operation Mode you may not be able to connect to the Internet.

# CHAPTER 16

## Troubleshooting

### 16.1 Overview

This chapter offers some suggestions to solve problems you might encounter. The potential problems are divided into the following categories.

- [Power, Hardware Connections, and LEDs](#)
- [EMG3435-Q20A Access and Login](#)
- [Internet Access](#)
- [Resetting the EMG3435-Q20A to Its Factory Defaults](#)
- [Wireless Connections](#)
- [USB Device Problems](#)

### 16.2 Power, Hardware Connections, and LEDs

---

[The EMG3435-Q20A does not turn on. None of the LEDs turn on.](#)

---

- 1 Make sure you are using the power adaptor or cord included with the EMG3435-Q20A.
- 2 Make sure the power adaptor or cord is connected to the EMG3435-Q20A and plugged in to an appropriate power source. Make sure the power source is turned on.
- 3 Disconnect and re-connect the power adaptor or cord to the EMG3435-Q20A.
- 4 If the problem continues, contact the vendor.

---

[One of the LEDs does not behave as expected.](#)

---

- 1 Make sure you understand the normal behavior of the LED. See [Section 1.7 on page 12](#).
- 2 Check the hardware connections. See the Quick Start Guide.
- 3 Inspect your cables for damage. Contact the vendor to replace any damaged cables.
- 4 Disconnect and re-connect the power adaptor to the EMG3435-Q20A.



- 5 If the problem continues, contact the vendor.

## 16.3 EMG3435-Q20A Access and Login

---

### I don't know the IP address of my EMG3435-Q20A.

---

- 6 The default IP address of the EMG3435-Q20A in **Router Mode** is **192.168.1.1**. If the EMG3435-Q20A obtains a WAN IP address in the same subnet as the LAN IP address 192.168.1.1, the default LAN IP address will be changed to 10.0.0.1 automatically. See [Auto-IP Change on page 74](#) for more information. The default IP address of the EMG3435-Q20A in **Access Point Mode** is **192.168.1.2**.
- 7 If you changed the IP address and have forgotten it, you might get the IP address of the EMG3435-Q20A in **Router Mode** by looking up the IP address of the default gateway for your computer. To do this in most Windows computers, click **Start > Run**, enter **cmd**, and then enter **ipconfig**. The IP address of the **Default Gateway** might be the IP address of the EMG3435-Q20A (it depends on the network), so enter this IP address in your Internet browser.
- 8 If your EMG3435-Q20A in **Access Point Mode** is a DHCP client, you can find your IP address from the DHCP server. This information is only available from the DHCP server which allocates IP addresses on your network. Find this information directly from the DHCP server or contact your system administrator for more information.
- 9 Reset your EMG3435-Q20A to change all settings back to their default. This means your current settings are lost. See [Section 16.5 on page 164](#) in the **Troubleshooting** for information on resetting your EMG3435-Q20A.

### I forgot the password.

---

- 1 The default password is **1234**.
- 2 If this does not work, you have to reset the device to its factory defaults. See [Section 16.5 on page 164](#).

### I cannot see or access the **Login** screen in the Web Configurator.

---

- 1 Make sure you are using the correct IP address.
- 2 The default IP address of the EMG3435-Q20A in **Router Mode** is **192.168.1.1**. If the EMG3435-Q20A obtains a WAN IP address in the same subnet as the LAN IP address 192.168.1.1, the default LAN IP address will be changed to 10.0.0.1 automatically. See [Auto-IP Change on page 74](#) for more information. The default IP address of the EMG3435-Q20A in **Access Point Mode** is **192.168.1.2**.
  - If you changed the IP address ([Section 12.4 on page 113](#)), use the new IP address.

- If you changed the IP address and have forgotten it, see the troubleshooting suggestions for [I don't know the IP address of my EMG3435-Q20A](#).
- 3 Check the hardware connections, and make sure the LEDs are behaving as expected. See the Quick Start Guide.
  - 4 Make sure your Internet browser does not block pop-up windows and has JavaScript and Java enabled.
  - 5 Make sure your computer is in the same subnet as the EMG3435-Q20A. (If you know that there are routers between your computer and the EMG3435-Q20A, skip this step.)
    - If there is a DHCP server on your network, make sure your computer is using a dynamic IP address. See [Section 12.4 on page 113](#).
    - If there is no DHCP server on your network, make sure your computer's IP address is in the same subnet as the EMG3435-Q20A. See [Section 12.4 on page 113](#).
  - 6 Reset the device to its factory defaults, and try to access the EMG3435-Q20A with the default IP address. See [Section 1.5 on page 11](#).
  - 7 If the problem continues, contact the network administrator or vendor, or try one of the advanced suggestions.

#### Advanced Suggestions

- Try to access the EMG3435-Q20A using another service, such as Telnet. If you can access the EMG3435-Q20A, check the remote management settings and firewall rules to find out why the EMG3435-Q20A does not respond to HTTP.
- If your computer is connected to the **WAN** port or is connected wirelessly, use a computer that is connected to a **LAN/ETHERNET** port.

---

[I can see the Login screen, but I cannot log in to the EMG3435-Q20A.](#)

---

- 1 Make sure you have entered the password correctly. The default password is **1234**. This field is case-sensitive, so make sure [Caps Lock] is not on.
- 2 This can happen when you fail to log out properly from your last session. Try logging in again after 5 minutes.
- 3 Disconnect and re-connect the power adaptor or cord to the EMG3435-Q20A.
- 4 If this does not work, you have to reset the device to its factory defaults. See [Section 16.5 on page 164](#).

## 16.4 Internet Access

---

[I cannot access the Internet.](#)

---

- 1 Check the hardware connections, and make sure the LEDs are behaving as expected. See the Quick Start Guide.
- 2 Go to **Expert > Maintenance > Operation Mode**. Check your System Operation Mode setting.
  - If the EMG3435-Q20A is in **Router Mode**, make sure the WAN port is connected to a broadband modem or router with Internet access. Your computer and the EMG3435-Q20A should be in the same subnet.
  - If the EMG3435-Q20A is in **Access Point Mode**, make sure the WAN port is connected to a broadband modem or router with Internet access and your computer is set to obtain a dynamic IP address.
- 3 If the EMG3435-Q20A is in **Router Mode**, make sure you entered your ISP account information correctly in the wizard or the WAN screen. These fields are case-sensitive, so make sure [Caps Lock] is not on.
- 4 If you are trying to access the Internet wirelessly, make sure the wireless settings in the wireless client are the same as the settings in the AP.
- 5 Disconnect all the cables from your device, and follow the directions in the Quick Start Guide again.
- 6 If the problem continues, contact your ISP.

---

I cannot access the Internet anymore. I had access to the Internet (with the EMG3435-Q20A), but my Internet connection is not available anymore.

---

- 1 Check the hardware connections, and make sure the LEDs are behaving as expected. See the Quick Start Guide and [Section 1.7 on page 12](#).
- 2 Reboot the EMG3435-Q20A.
- 3 If the problem continues, contact your ISP.

---

The Internet connection is slow or intermittent.

---

- 1 There might be a lot of traffic on the network. Look at the LEDs, and check [Section 1.7 on page 12](#). If the EMG3435-Q20A is sending or receiving a lot of information, try closing some programs that use the Internet, especially peer-to-peer applications.
- 2 Check the signal strength. If the signal strength is low, try moving the EMG3435-Q20A closer to the AP if possible, and look around to see if there are any devices that might be interfering with the wireless network (for example, microwaves, other wireless networks, and so on).
- 3 Reboot the EMG3435-Q20A.
- 4 If the problem continues, contact the network administrator or vendor, or try one of the advanced suggestions.

**Advanced Suggestion**

- Check the settings for QoS. If it is disabled, you might consider activating it.

## 16.5 Resetting the EMG3435-Q20A to Its Factory Defaults

If you reset the EMG3435-Q20A, you lose all of the changes you have made. The EMG3435-Q20A re-loads its default settings, and the password resets to **1234**. You have to make all of your changes again.

---

You will lose all of your changes when you push the **RESET** button.

---

To reset the EMG3435-Q20A:

- 1 Make sure the power LED is on.
- 2 Press the **RESET** button for one to four seconds to restart/reboot the EMG3435-Q20A.
- 3 Press the **RESET** button for longer than five seconds to set the EMG3435-Q20A back to its factory-default configurations.

If the EMG3435-Q20A restarts automatically, wait for the EMG3435-Q20A to finish restarting, and log in to the Web Configurator. The password is "1234".

If the EMG3435-Q20A does not restart automatically, disconnect and reconnect the EMG3435-Q20A's power. Then, follow the directions above again.

## 16.6 Wireless Connections

---

I cannot access the EMG3435-Q20A or ping any computer from the WLAN.

---

- 1 Make sure the wireless LAN is enabled on the EMG3435-Q20A.
- 2 Make sure the wireless adapter on your computer is working properly.
- 3 Make sure the wireless adapter installed on your computer is IEEE 802.11 compatible and supports the same wireless standard as the EMG3435-Q20A.
- 4 Make sure your computer (with a wireless adapter installed) is within the transmission range of the EMG3435-Q20A.
- 5 Check that both the EMG3435-Q20A and the wireless adapter on your computer are using the same wireless and wireless security settings.
- 6 Make sure traffic between the WLAN and the LAN is not blocked by the firewall on the EMG3435-Q20A.

- 7 Make sure you allow the EMG3435-Q20A to be remotely accessed through the WLAN interface. Check your remote management settings.
- See the chapter on [Wireless LAN](#) in the User's Guide for more information.

---

[I set up URL keyword blocking, but I can still access a website that should be blocked.](#)

---

Make sure that you enable parental control in the **Parental Control** screen, set up rules and turn on the rules. Make sure that the keywords that you type are listed in the rule's **Keyword List**.

If a keyword that is listed in the **Keyword List** is not blocked when it is found in a URL, customize the keyword blocking using commands. See the [Keyword Blocking URL Checking](#) section in the [Applications](#) chapter.

---

[I cannot access the Web Configurator after I switched to AP mode.](#)

---

When you change from router mode to AP mode, your computer must have an IP address in the range between "192.168.1.3" and "192.168.1.254".

Refer to [Appendix B on page 173](#) for instructions on how to change your computer's IP address.

---

[What factors may cause intermittent or unstabled wireless connection? How can I solve this problem?](#)

---

The following factors may cause interference:

- Obstacles: walls, ceilings, furniture, and so on.
- Building Materials: metal doors, aluminum studs.
- Electrical devices: microwaves, monitors, electric motors, cordless phones, and other wireless devices.

To optimize the speed and quality of your wireless connection, you can:

- Move your wireless device closer to the AP if the signal strength is low.
- Reduce wireless interference that may be caused by other wireless networks or surrounding wireless electronics such as cordless phones.
- Place the AP where there are minimum obstacles (such as walls and ceilings) between the AP and the wireless client.
- Reduce the number of wireless clients connecting to the same AP simultaneously, or add additional APs if necessary.
- Try closing some programs that use the Internet, especially peer-to-peer applications. If the wireless client is sending or receiving a lot of information, it may have too many programs open that use the Internet.
- Position the antennas for best reception. If the AP is placed on a table or floor, point the antennas upwards. If the AP is placed at a high position, point the antennas downwards. Try pointing the antennas in different directions and check which provides the strongest signal to the wireless clients.

## 16.7 USB Device Problems

---

I cannot access or see a USB device that is connected to the EMG3435-Q20A.

---

- 1 Disconnect the problematic USB device, then reconnect it to the EMG3435-Q20A.
- 2 Ensure that the USB device has power.
- 3 Check your cable connections.
- 4 Restart the EMG3435-Q20A by disconnecting the power and then reconnecting it.
- 5 If the USB device requires a special driver, install the driver from the installation disc that came with the device. After driver installation, reconnect the USB device to the EMG3435-Q20A and try to connect to it again with your computer.
- 6 If the problem persists, contact your vendor.

What kind of USB devices do the EMG3435-Q20A support?

---

- 1 It is strongly recommended to use version 2.0 or higher USB storage devices (such as NTFS or FAT32 file system, USB hard drives) and/or USB devices. Other USB products are not guaranteed to function properly with the EMG3435-Q20A.
- 2 The EMG3435-Q20A do not support 3G/4G USB dongles.

# APPENDIX A

## Customer Support

In the event of problems that cannot be solved by using this manual, you should contact your vendor. If you cannot contact your vendor, then contact a Zyxel office for the region in which you bought the device.

See <https://www.zyxel.com/homepage.shtml> and also [https://www.zyxel.com/about\\_zyxel/zyxel\\_worldwide.shtml](https://www.zyxel.com/about_zyxel/zyxel_worldwide.shtml) for the latest information.

Please have the following information ready when you contact an office.

### Required Information

- Product model and serial number.
- Warranty Information.
- Date that you received your device.
- Brief description of the problem and the steps you took to solve it.

### Corporate Headquarters (Worldwide)

#### Taiwan

- Zyxel Communications Corporation
- <https://www.zyxel.com>

### Asia

#### China

- Zyxel Communications (Shanghai) Corp.
- Zyxel Communications (Beijing) Corp.
- Zyxel Communications (Tianjin) Corp.
- <https://www.zyxel.com/cn/zh/>

#### India

- Zyxel Technology India Pvt Ltd
- <https://www.zyxel.com/in/en/>

#### Kazakhstan

- Zyxel Kazakhstan
- <https://www.zyxel.kz>

## **Korea**

- Zyxel Korea Corp.
- <http://www.zyxel.kr>

## **Malaysia**

- Zyxel Malaysia Sdn Bhd.
- <http://www.zyxel.com.my>

## **Pakistan**

- Zyxel Pakistan (Pvt.) Ltd.
- <http://www.zyxel.com.pk>

## **Philippines**

- Zyxel Philippines
- <http://www.zyxel.com.ph>

## **Singapore**

- Zyxel Singapore Pte Ltd.
- <http://www.zyxel.com.sg>

## **Taiwan**

- Zyxel Communications Corporation
- <https://www.zyxel.com/tw/zh/>

## **Thailand**

- Zyxel Thailand Co., Ltd
- <https://www.zyxel.com/th/th/>

## **Vietnam**

- Zyxel Communications Corporation-Vietnam Office
- <https://www.zyxel.com/vn/vi>

## **Europe**

### **Belarus**

- Zyxel BY
- <https://www.zyxel.by>

### **Belgium**

- Zyxel Communications B.V.
- <https://www.zyxel.com/be/nl/>



- <https://www.zyxel.com/be/fr/>

## **Bulgaria**

- Zyxel България
- <https://www.zyxel.com/bg/bg/>

## **Czech Republic**

- Zyxel Communications Czech s.r.o
- <https://www.zyxel.com/cz/cs/>

## **Denmark**

- Zyxel Communications A/S
- <https://www.zyxel.com/dk/da/>

## **Estonia**

- Zyxel Estonia
- <https://www.zyxel.com/ee/et/>

## **Finland**

- Zyxel Communications
- <https://www.zyxel.com/fi/fi/>

## **France**

- Zyxel France
- <https://www.zyxel.fr>

## **Germany**

- Zyxel Deutschland GmbH
- <https://www.zyxel.com/de/de/>

## **Hungary**

- Zyxel Hungary & SEE
- <https://www.zyxel.com/hu/hu/>

## **Italy**

- Zyxel Communications Italy
- <https://www.zyxel.com/it/it/>

## **Latvia**

- Zyxel Latvia
- <https://www.zyxel.com/lv/lv/>

## **Lithuania**

- Zyxel Lithuania
- <https://www.zyxel.com/lt/lt/>

## **Netherlands**

- Zyxel Benelux
- <https://www.zyxel.com/nl/nl/>

## **Norway**

- Zyxel Communications
- <https://www.zyxel.com/no/no/>

## **Poland**

- Zyxel Communications Poland
- <https://www.zyxel.com/pl/pl/>

## **Romania**

- Zyxel Romania
- <https://www.zyxel.com/ro/ro/>

## **Russia**

- Zyxel Russia
- <https://www.zyxel.com/ru/ru/>

## **Slovakia**

- Zyxel Communications Czech s.r.o. organizacna zlozka
- <https://www.zyxel.com/sk/sk/>

## **Spain**

- Zyxel Communications ES Ltd
- <https://www.zyxel.com/es/es/>

## **Sweden**

- Zyxel Communications
- <https://www.zyxel.com/se/sv/>

## **Switzerland**

- Studerus AG
- <https://www.zyxel.ch/de>
- <https://www.zyxel.ch/fr>

## **Turkey**

- Zyxel Turkey A.S.
- <https://www.zyxel.com/tr/tr/>

## **UK**

- Zyxel Communications UK Ltd.
- <https://www.zyxel.com/uk/en/>

## **Ukraine**

- Zyxel Ukraine
- <http://www.ua.zyxel.com>

## **South America**

### **Argentina**

- Zyxel Communications Corporation
- <https://www.zyxel.com/co/es/>

### **Brazil**

- Zyxel Communications Brasil Ltda.
- <https://www.zyxel.com/br/pt/>

### **Colombia**

- Zyxel Communications Corporation
- <https://www.zyxel.com/co/es/>

### **Ecuador**

- Zyxel Communications Corporation
- <https://www.zyxel.com/co/es/>

### **South America**

- Zyxel Communications Corporation
- <https://www.zyxel.com/co/es/>

## **Middle East**

### **Israel**

- Zyxel Communications Corporation
- <http://il.zyxel.com/>

## **Middle East**

- Zyxel Communications Corporation
- <https://www.zyxel.com/me/en/>

## **North America**

### **USA**

- Zyxel Communications, Inc. - North America Headquarters
- <https://www.zyxel.com/us/en/>

## **Oceania**

### **Australia**

- Zyxel Communications Corporation
- <https://www.zyxel.com/au/en/>

## **Africa**

### **South Africa**

- Nology (Pty) Ltd.
- <https://www.zyxel.com/za/en/>

# APPENDIX B

## Setting Up Your Computer's IP Address

Note: Your specific EMG3435-Q20A may not support all of the operating systems described in this appendix. See the product specifications for more information about which operating systems are supported.

This appendix shows you how to configure the IP settings on your computer in order for it to be able to communicate with the other devices on your network. Windows Vista/XP/2000, Mac OS 9/OS X, and all versions of UNIX/LINUX include the software components you need to use TCP/IP on your computer.

If you manually assign IP information instead of using a dynamic IP, make sure that your network's computers have IP addresses that place them in the same subnet.

In this appendix, you can set up an IP address for:

- [Windows 7](#) on [page 173](#)
- [Mac OS X: 10.3 and 10.4](#) on [page 177](#)
- [Mac OS X: 10.5 and 10.6](#) on [page 180](#)
- [Linux: Ubuntu 8 \(GNOME\)](#) on [page 183](#)
- [Linux: openSUSE 10.3 \(KDE\)](#) on [page 187](#)

### Windows 7

This section shows screens from Windows 7 Enterprise.

- 1 Click **Start > Control Panel**.

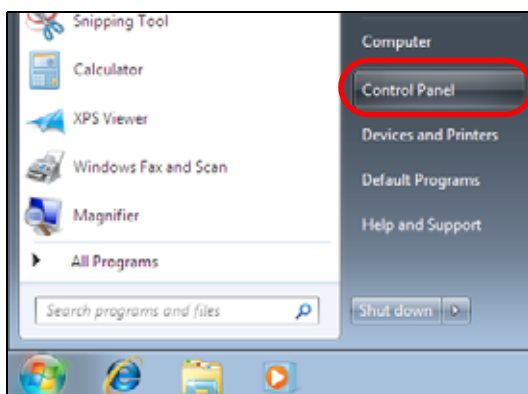

- 2 In the **Control Panel**, click **View network status and tasks** under the **Network and Internet** category.



3 Click **Change adapter settings**.

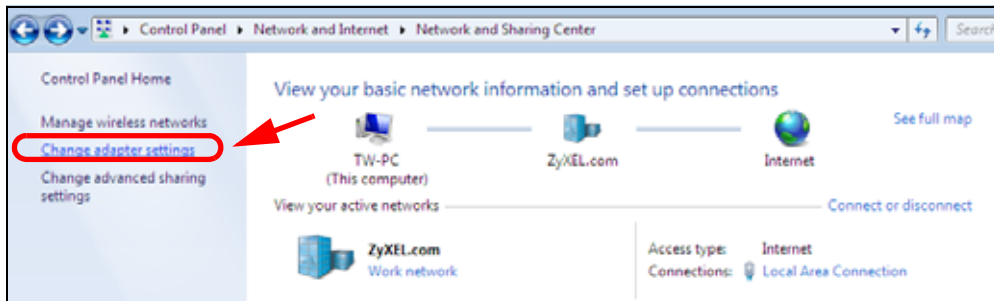

4 Double click **Local Area Connection** and then select **Properties**.

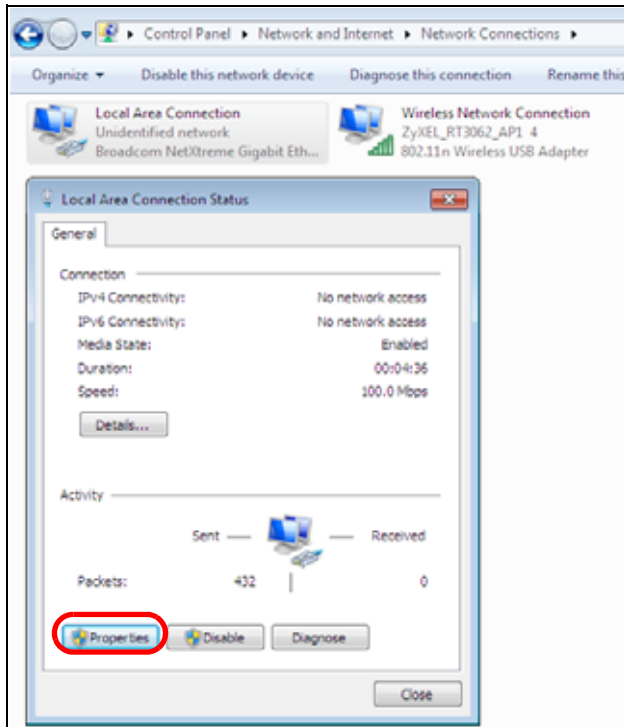

Note: During this procedure, click **Continue** whenever Windows displays a screen saying that it needs your permission to continue.

- 5 Select **Internet Protocol Version 4 (TCP/IPv4)** and then select **Properties**.

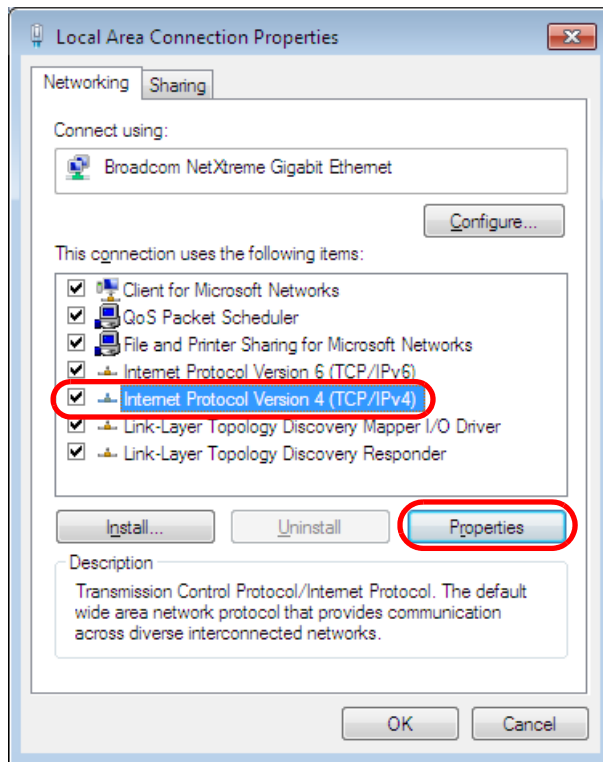

- 6 The **Internet Protocol Version 4 (TCP/IPv4) Properties** window opens.

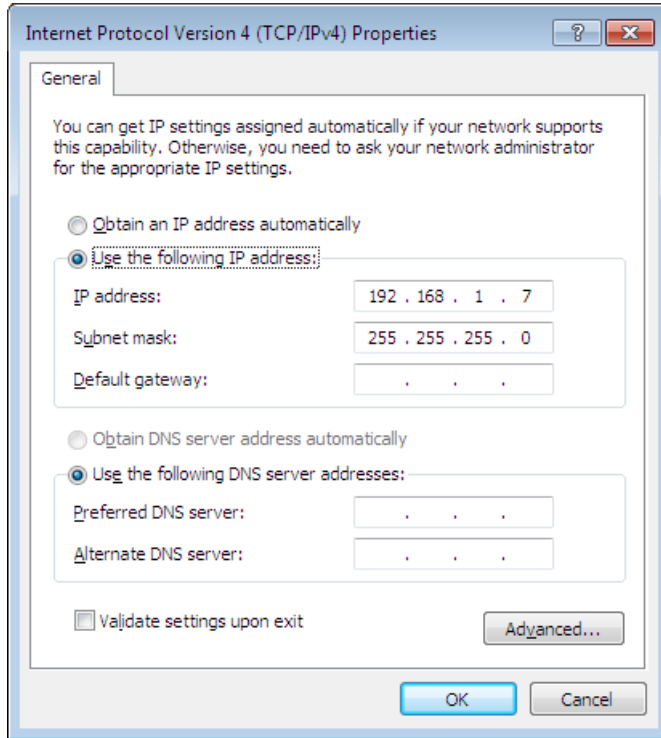

- 7 Select **Obtain an IP address automatically** if your network administrator or ISP assigns your IP address dynamically.

Select **Use the following IP Address** and fill in the **IP address**, **Subnet mask**, and **Default gateway** fields if you have a static IP address that was assigned to you by your network administrator or ISP. You may also have to enter a **Preferred DNS server** and an **Alternate DNS server**, if that information was provided. Click **Advanced** if you want to configure advanced settings for IP, DNS and WINS.

- 8 Click **OK** to close the **Internet Protocol (TCP/IP) Properties** window.
- 9 Click **OK** to close the **Local Area Connection Properties** window.

## Verifying Settings

- 1 Click **Start > All Programs > Accessories > Command Prompt**.
- 2 In the **Command Prompt** window, type "ipconfig" and then press [ENTER].
- 3 The IP settings are displayed as follows.



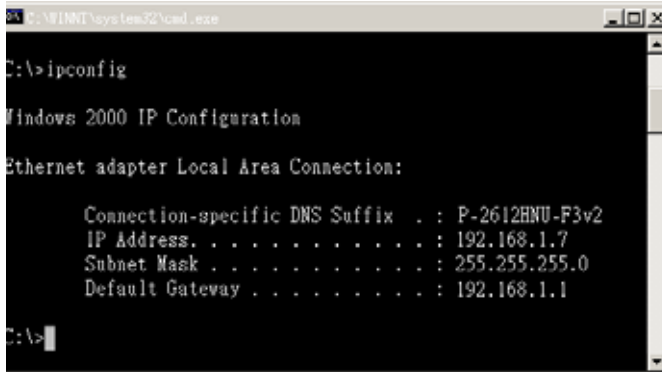

## Mac OS X: 10.3 and 10.4

The screens in this section are from Mac OS X 10.4 but can also apply to 10.3.

- 1 Click **Apple** > **System Preferences**.



- 2 In the **System Preferences** window, click the **Network** icon.



- 3 When the **Network** preferences pane opens, select **Built-in Ethernet** from the network connection type list, and then click **Configure**.

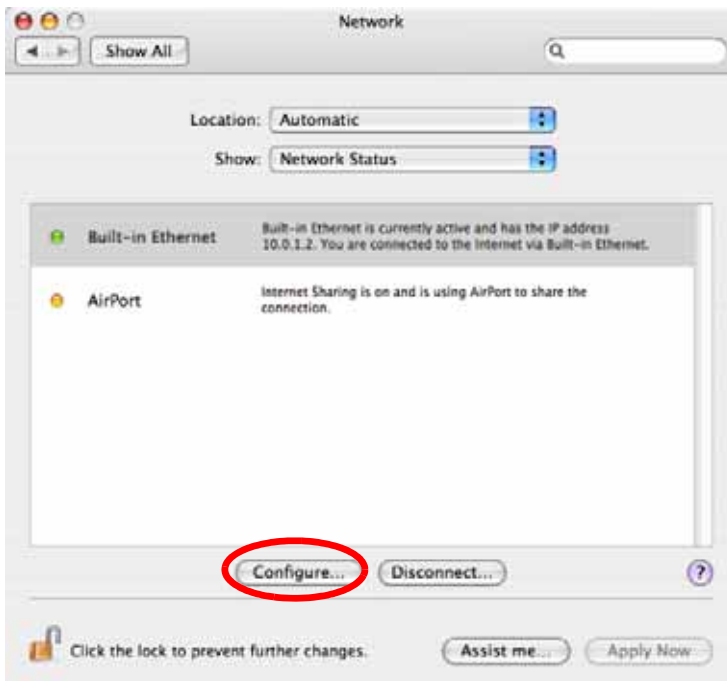

- 4 For dynamically assigned settings, select **Using DHCP** from the **Configure IPv4** list in the **TCP/IP** tab.

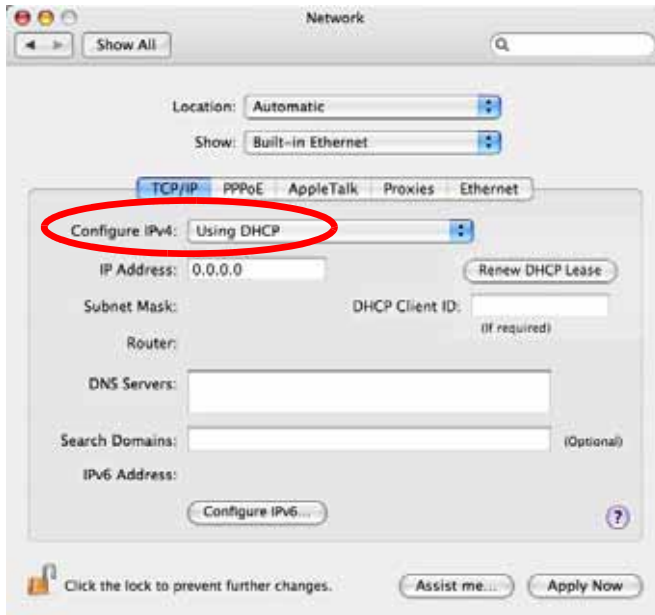

- 5 For statically assigned settings, do the following:
- From the **Configure IPv4** list, select **Manually**.
  - In the **IP Address** field, type your IP address.
  - In the **Subnet Mask** field, type your subnet mask.
  - In the **Router** field, type the IP address of your device.

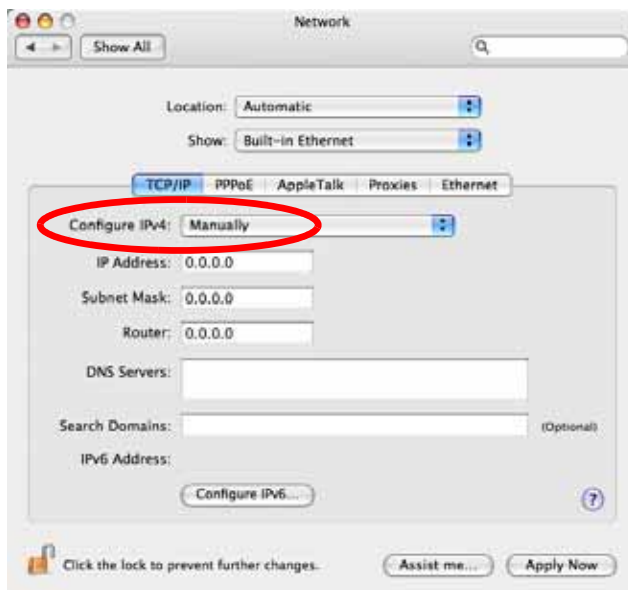

- 6 Click **Apply Now** and close the window.

## Verifying Settings

Check your TCP/IP properties by clicking **Applications > Utilities > Network Utilities**, and then selecting the appropriate **Network Interface** from the **Info** tab.

Figure 113 Mac OS X 10.4: Network Utility

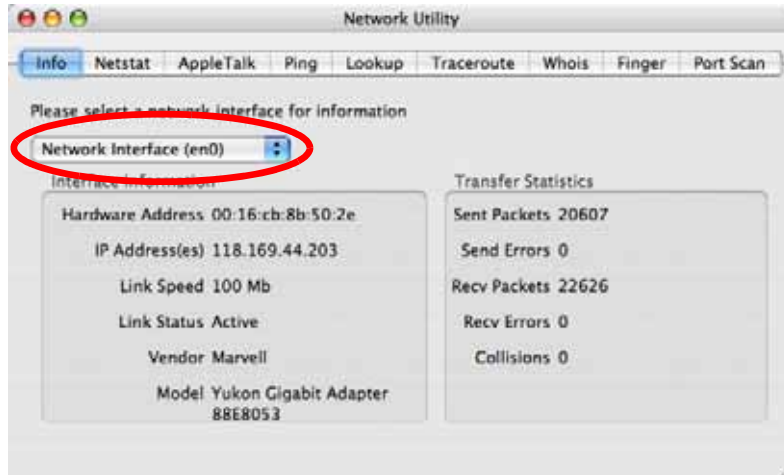

## Mac OS X: 10.5 and 10.6

The screens in this section are from Mac OS X 10.5 but can also apply to 10.6.

- 1 Click **Apple > System Preferences**.

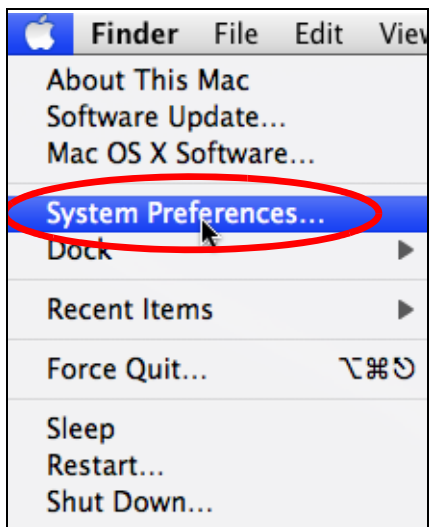

- 2 In System Preferences, click the **Network** icon.



- 3 When the **Network** preferences pane opens, select **Ethernet** from the list of available connection types.

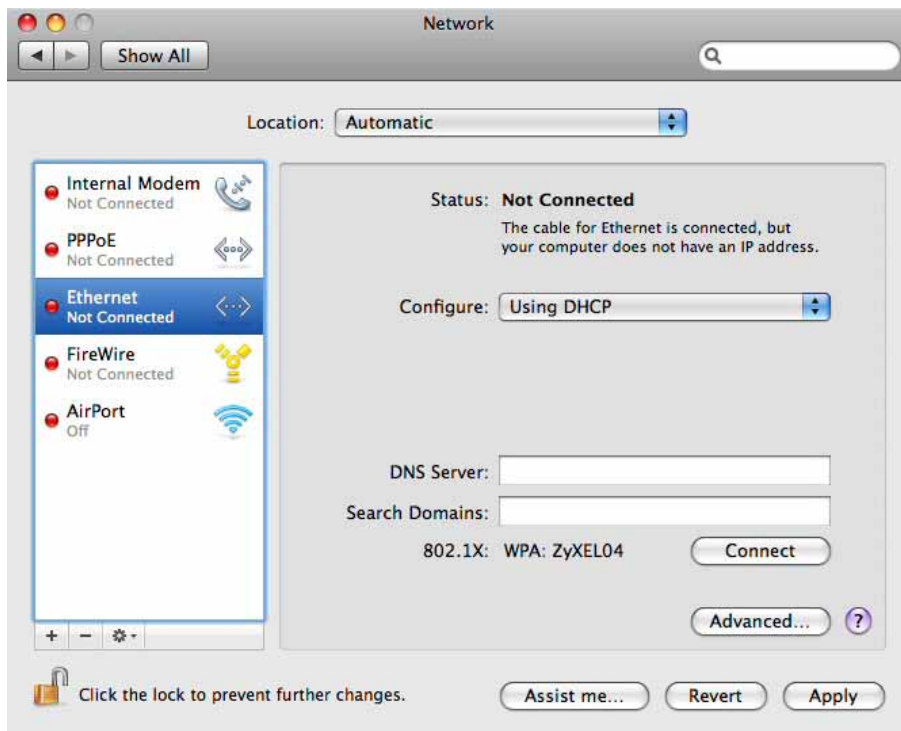

- 4 From the **Configure** list, select **Using DHCP** for dynamically assigned settings.

- 5 For statically assigned settings, do the following:
  - From the **Configure** list, select **Manually**.
  - In the **IP Address** field, enter your IP address.
  - In the **Subnet Mask** field, enter your subnet mask.
  - In the **Router** field, enter the IP address of your EMG3435-Q20A.

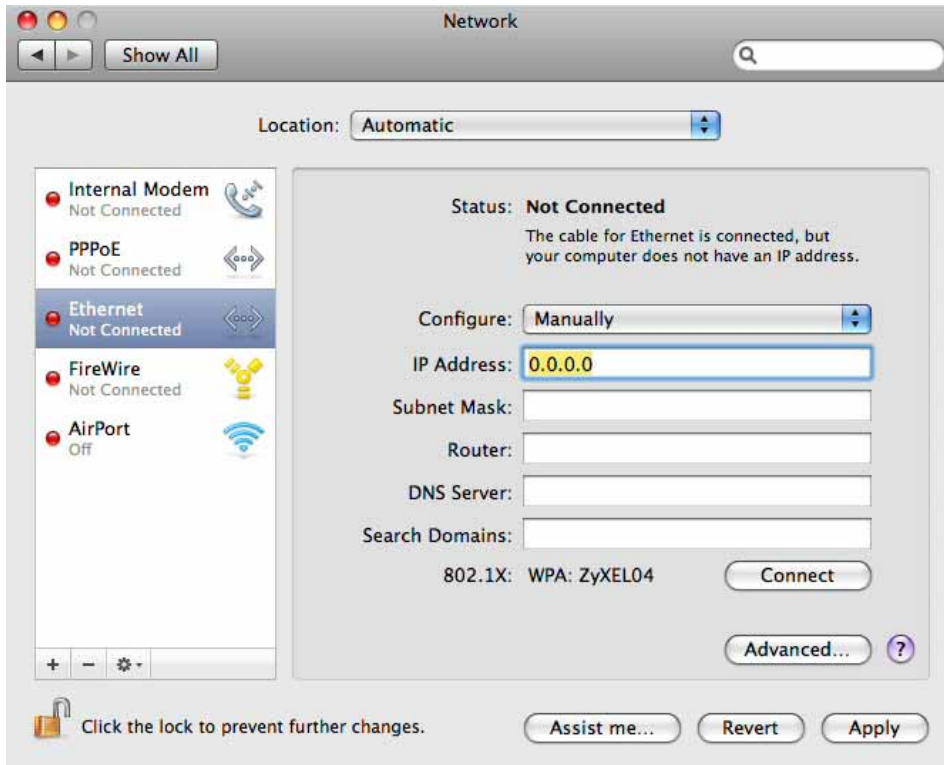

- 6 Click **Apply** and close the window.

## Verifying Settings

Check your TCP/IP properties by clicking **Applications > Utilities > Network Utilities**, and then selecting the appropriate **Network interface** from the **Info** tab.

Figure 114 Mac OS X 10.5: Network Utility

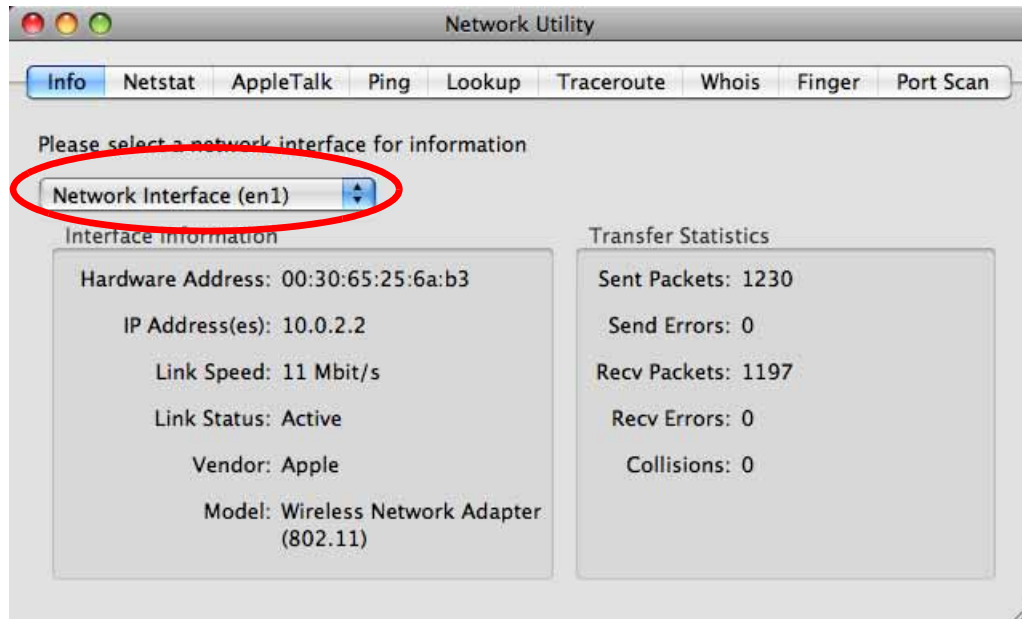

## Linux: Ubuntu 8 (GNOME)

This section shows you how to configure your computer's TCP/IP settings in the GNU Object Model Environment (GNOME) using the Ubuntu 8 Linux distribution. The procedure, screens and file locations may vary depending on your specific distribution, release version, and individual configuration. The following screens use the default Ubuntu 8 installation.

Note: Make sure you are logged in as the root administrator.

Follow the steps below to configure your computer IP address in GNOME:

- 1 Click **System > Administration > Network**.

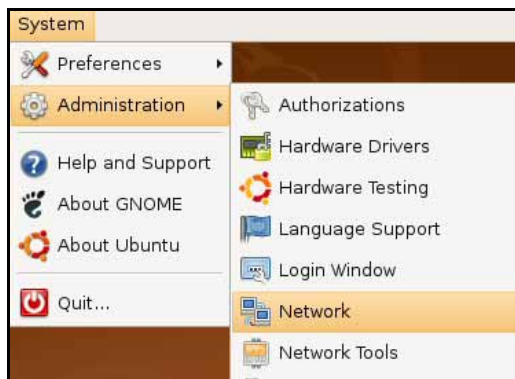

- 2 When the **Network Settings** window opens, click **Unlock** to open the **Authenticate** window. (By default, the **Unlock** button is greyed out until clicked.) You cannot make changes to your configuration unless you first enter your admin password.

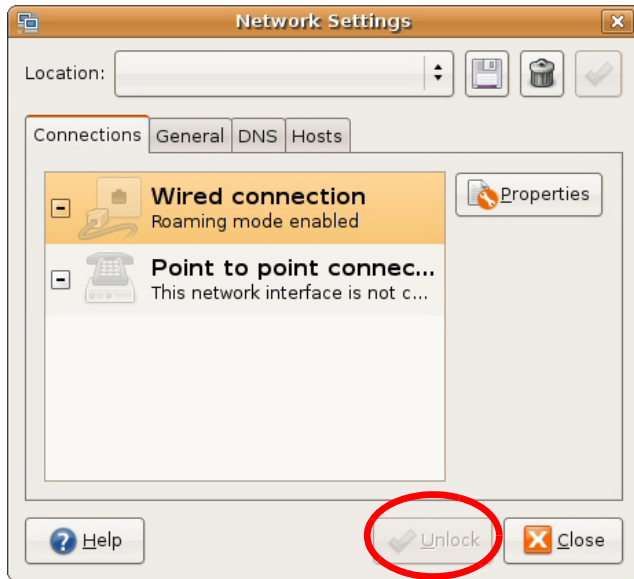

- 3 In the **Authenticate** window, enter your admin account name and password then click the **Authenticate** button.



- 4 In the **Network Settings** window, select the connection that you want to configure, then click **Properties**.



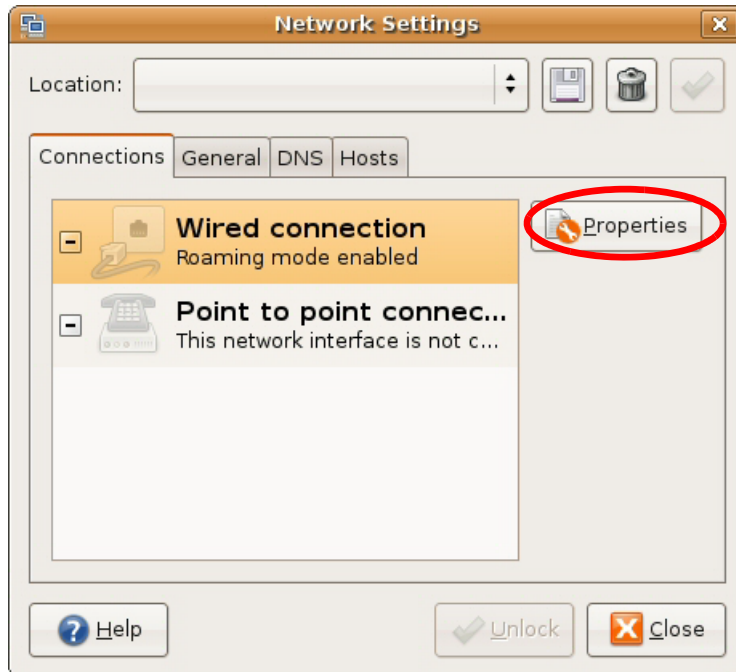

- 5 The **Properties** dialog box opens.

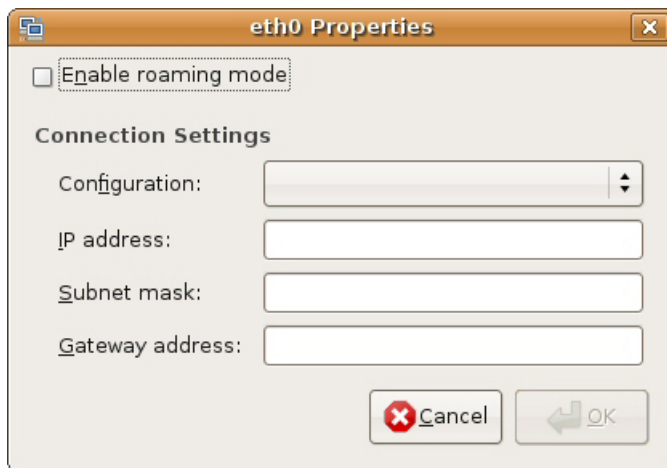

- In the **Configuration** list, select **Automatic Configuration (DHCP)** if you have a dynamic IP address.
  - In the **Configuration** list, select **Static IP address** if you have a static IP address. Fill in the **IP address**, **Subnet mask**, and **Gateway address** fields.
- 6 Click **OK** to save the changes and close the **Properties** dialog box and return to the **Network Settings** screen.
- 7 If you know your DNS server IP address(es), click the **DNS** tab in the **Network Settings** window and then enter the DNS server information in the fields provided.

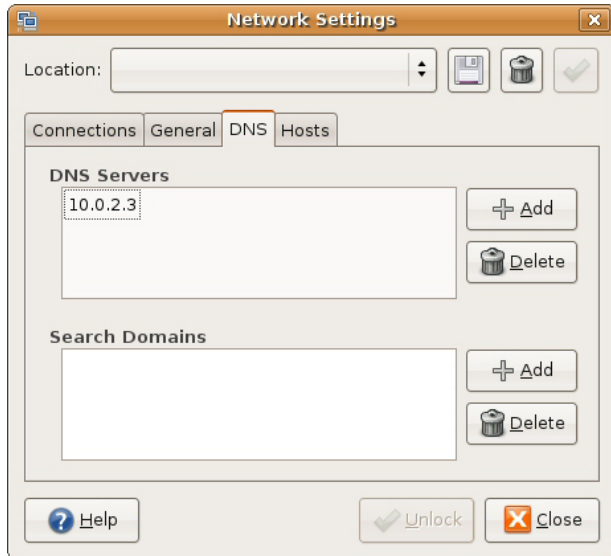

- 8 Click the **Close** button to apply the changes.

## Verifying Settings

Check your TCP/IP properties by clicking **System > Administration > Network Tools**, and then selecting the appropriate **Network device** from the **Devices** tab. The **Interface Statistics** column shows data if your connection is working properly.

Figure 115 Ubuntu 8: Network Tools

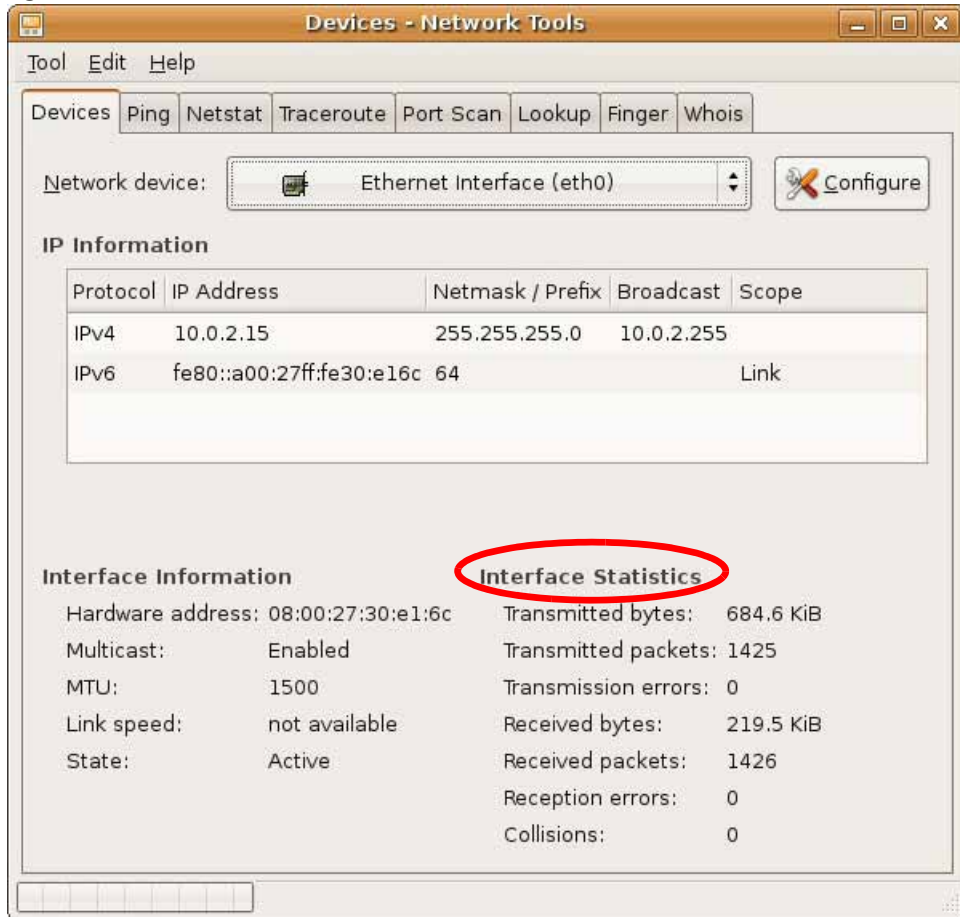

## Linux: openSUSE 10.3 (KDE)

This section shows you how to configure your computer's TCP/IP settings in the K Desktop Environment (KDE) using the openSUSE 10.3 Linux distribution. The procedure, screens and file locations may vary depending on your specific distribution, release version, and individual configuration. The following screens use the default openSUSE 10.3 installation.

Note: Make sure you are logged in as the root administrator.

Follow the steps below to configure your computer IP address in the KDE:

- 1 Click K Menu > Computer > Administrator Settings (YaST).

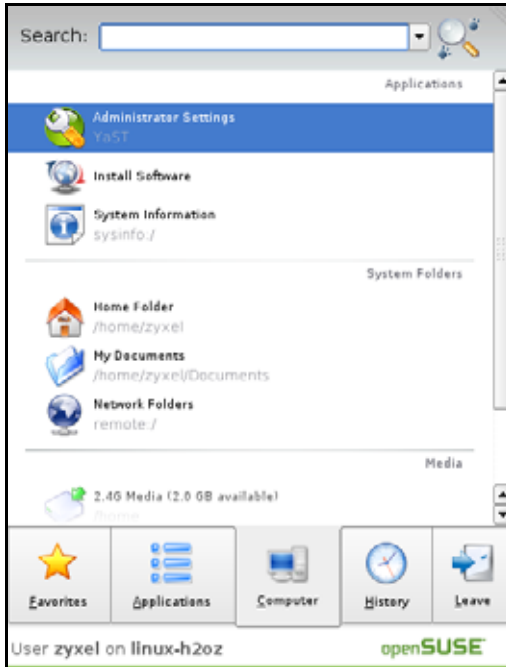

- 2 When the **Run as Root - KDE su** dialog opens, enter the admin password and click **OK**.



- 3 When the **YaST Control Center** window opens, select **Network Devices** and then click the **Network Card** icon.

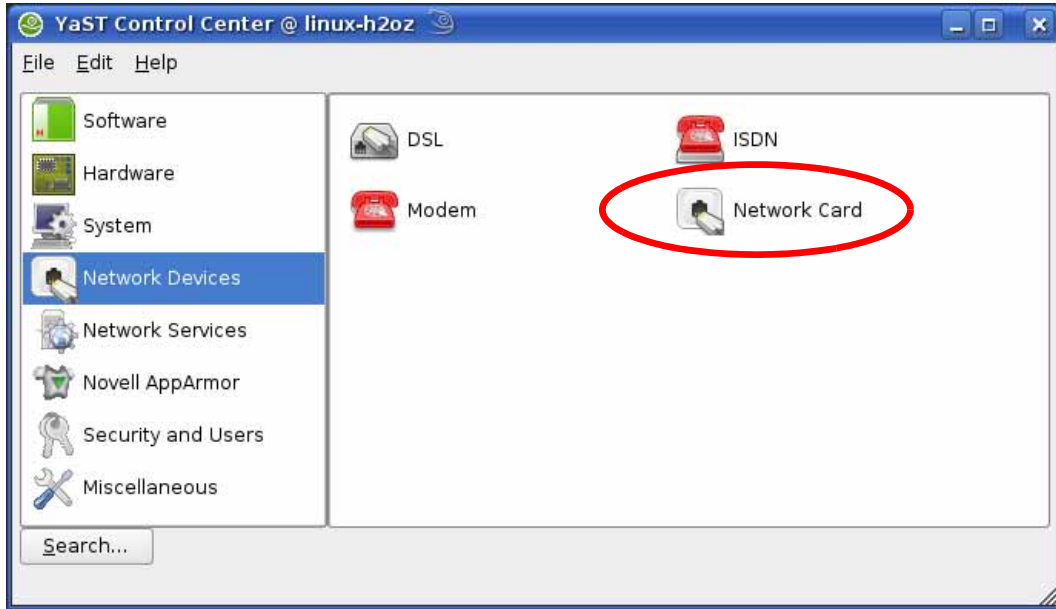

- 4 When the **Network Settings** window opens, click the **Overview** tab, select the appropriate connection **Name** from the list, and then click the **Configure** button.

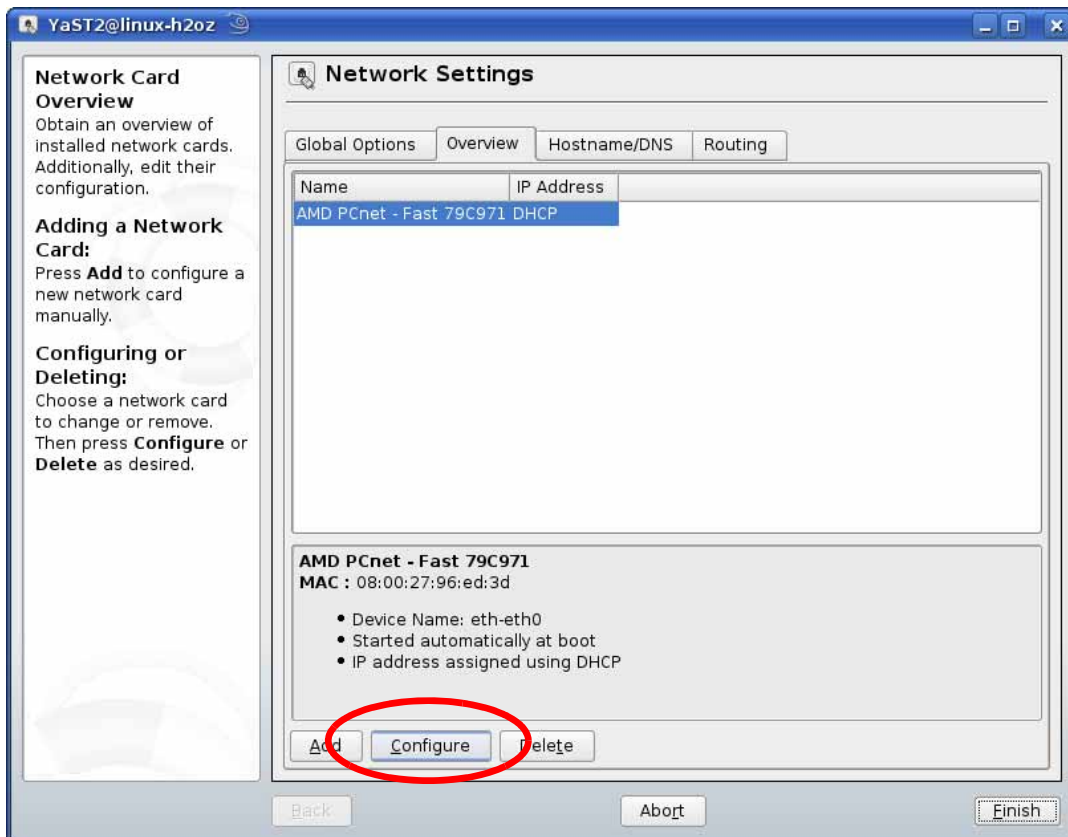

- 5 When the **Network Card Setup** window opens, click the **Address** tab

Figure 116 openSUSE 10.3: Network Card Setup

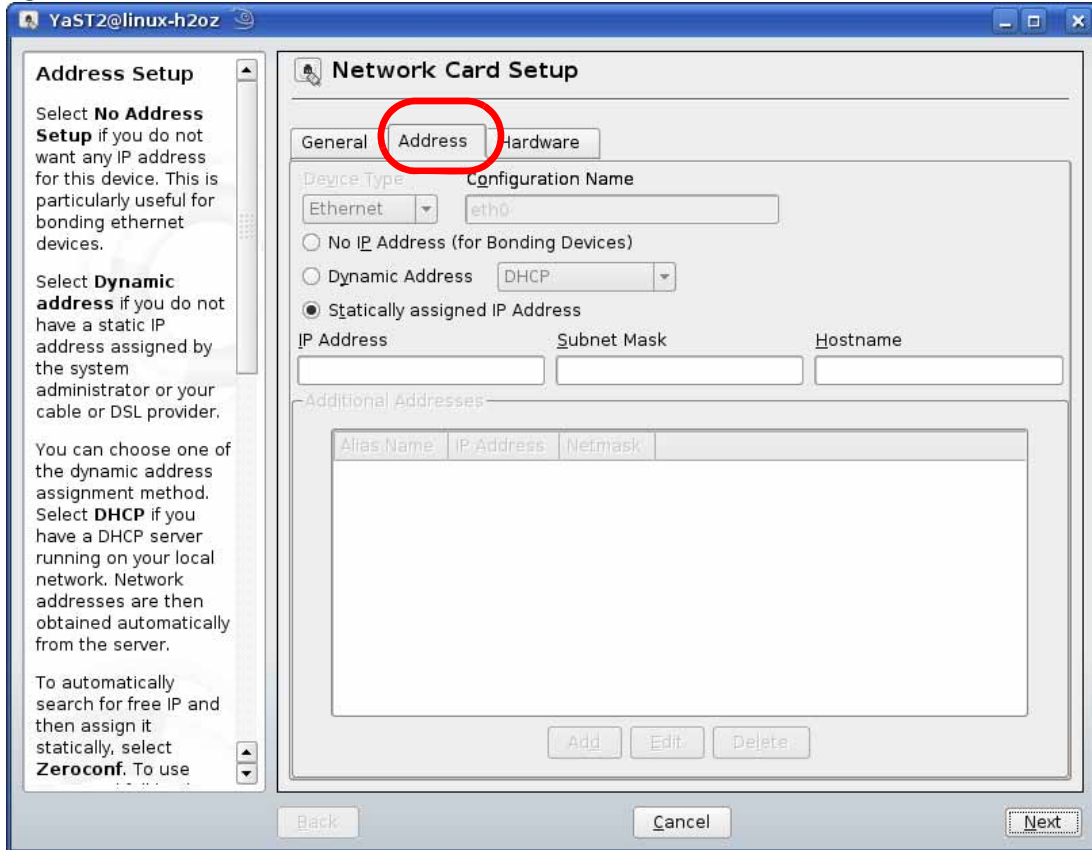

- 6 Select **Dynamic Address (DHCP)** if you have a dynamic IP address.  
Select **Statically assigned IP Address** if you have a static IP address. Fill in the **IP address**, **Subnet mask**, and **Hostname** fields.
- 7 Click **Next** to save the changes and close the **Network Card Setup** window.
- 8 If you know your DNS server IP address(es), click the **Hostname/DNS** tab in **Network Settings** and then enter the DNS server information in the fields provided.

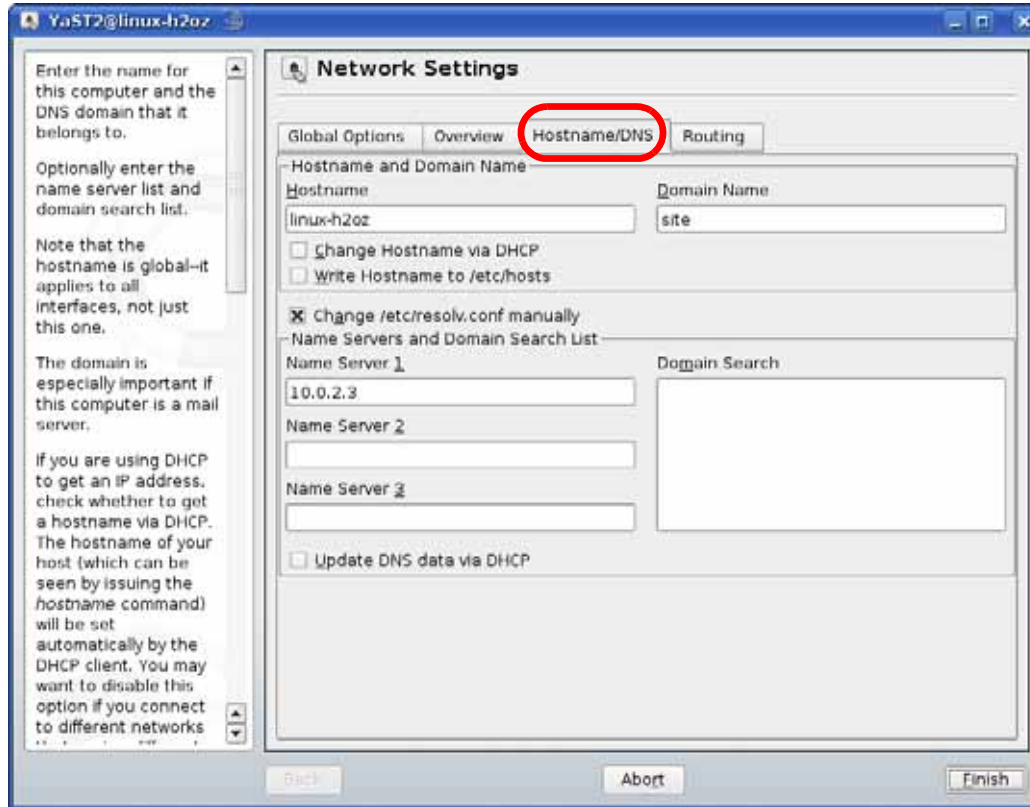

- 9 Click **Finish** to save your settings and close the window.

## Verifying Settings

Click the **KNetwork Manager** icon on the **Task bar** to check your TCP/IP properties. From the **Options** sub-menu, select **Show Connection Information**.

**Figure 117** openSUSE 10.3: KNetwork Manager

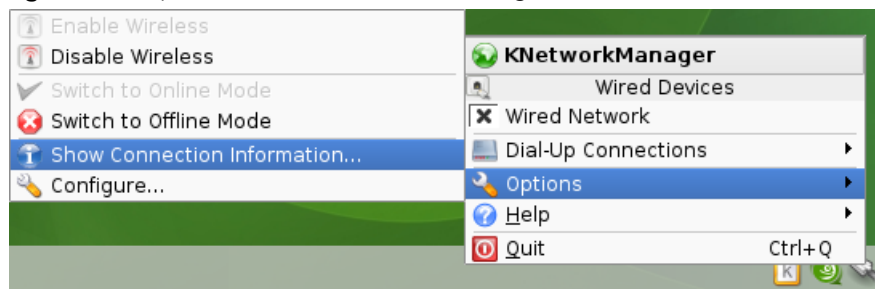

When the **Connection Status - KNetwork Manager** window opens, click the **Statistics** tab to see if your connection is working properly.

Figure 118 openSUSE: Connection Status - KNetwork Manager

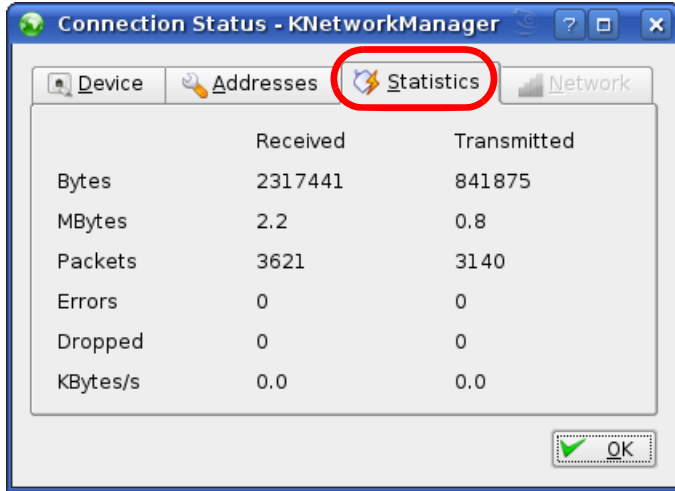



# APPENDIX C

## Common Services

The following table lists some commonly-used services and their associated protocols and port numbers. For a comprehensive list of port numbers, ICMP type/code numbers and services, visit the IANA (Internet Assigned Number Authority) web site.

- **Name:** This is a short, descriptive name for the service. You can use this one or create a different one, if you like.
- **Protocol:** This is the type of IP protocol used by the service. If this is **TCP/UDP**, then the service uses the same port number with TCP and UDP. If this is **USER-DEFINED**, the **Port(s)** is the IP protocol number, not the port number.
- **Port(s):** This value depends on the **Protocol**. Please refer to RFC 1700 for further information about port numbers.
  - If the **Protocol** is **TCP, UDP, or TCP/UDP**, this is the IP port number.
  - If the **Protocol** is **USER**, this is the IP protocol number.
- **Description:** This is a brief explanation of the applications that use this service or the situations in which this service is used.

Table 61 Commonly Used Services

NAME	PROTOCOL	PORT(S)	DESCRIPTION
AH (IPSEC_TUNNEL)	User-Defined	51	The IPSEC AH (Authentication Header) tunneling protocol uses this service.
AIM/New-ICQ	TCP	5190	AOL's Internet Messenger service. It is also used as a listening port by ICQ.
AUTH	TCP	113	Authentication protocol used by some servers.
BGP	TCP	179	Border Gateway Protocol.
BOOTP_CLIENT	UDP	68	DHCP Client.
BOOTP_SERVER	UDP	67	DHCP Server.
CU-SEEME	TCP UDP	7648 24032	A popular videoconferencing solution from White Pines Software.
DNS	TCP/UDP	53	Domain Name Server, a service that matches web names (for example <a href="http://www.zyxel.com">www.zyxel.com</a> ) to IP numbers.
ESP (IPSEC_TUNNEL)	User-Defined	50	The IPSEC ESP (Encapsulation Security Protocol) tunneling protocol uses this service.
FINGER	TCP	79	Finger is a UNIX or Internet related command that can be used to find out if a user is logged on.
FTP	TCP TCP	20 21	File Transfer Program, a program to enable fast transfer of files, including large files that may not be possible by e-mail.
H.323	TCP	1720	NetMeeting uses this protocol.
HTTP	TCP	80	Hyper Text Transfer Protocol - a client/server protocol for the world wide web.
HTTPS	TCP	443	HTTPS is a secured http session often used in e-commerce.

Table 61 Commonly Used Services (continued)

NAME	PROTOCOL	PORT(S)	DESCRIPTION
ICMP	User-Defined	1	Internet Control Message Protocol is often used for diagnostic or routing purposes.
ICQ	UDP	4000	This is a popular Internet chat program.
IGMP (MULTICAST)	User-Defined	2	Internet Group Management Protocol is used when sending packets to a specific group of hosts.
IKE	UDP	500	The Internet Key Exchange algorithm is used for key distribution and management.
IRC	TCP/UDP	6667	This is another popular Internet chat program.
MSN Messenger	TCP	1863	Microsoft Networks' messenger service uses this protocol.
NEW-ICQ	TCP	5190	An Internet chat program.
NEWS	TCP	144	A protocol for news groups.
NFS	UDP	2049	Network File System - NFS is a client/server distributed file service that provides transparent file sharing for network environments.
NNTP	TCP	119	Network News Transport Protocol is the delivery mechanism for the USENET newsgroup service.
PING	User-Defined	1	Packet INternet Groper is a protocol that sends out ICMP echo requests to test whether or not a remote host is reachable.
POP3	TCP	110	Post Office Protocol version 3 lets a client computer get e-mail from a POP3 server through a temporary connection (TCP/IP or other).
PPTP	TCP	1723	Point-to-Point Tunneling Protocol enables secure transfer of data over public networks. This is the control channel.
PPTP_TUNNEL (GRE)	User-Defined	47	PPTP (Point-to-Point Tunneling Protocol) enables secure transfer of data over public networks. This is the data channel.
RCMD	TCP	512	Remote Command Service.
REAL_AUDIO	TCP	7070	A streaming audio service that enables real time sound over the web.
REXEC	TCP	514	Remote Execution Daemon.
RLOGIN	TCP	513	Remote Login.
RTELNET	TCP	107	Remote Telnet.
RTSP	TCP/UDP	554	The Real Time Streaming (media control) Protocol (RTSP) is a remote control for multimedia on the Internet.
SFTP	TCP	115	Simple File Transfer Protocol.
SMTP	TCP	25	Simple Mail Transfer Protocol is the message-exchange standard for the Internet. SMTP enables you to move messages from one e-mail server to another.
SNMP	TCP/UDP	161	Simple Network Management Program.
SNMP-TRAPS	TCP/UDP	162	Traps for use with the SNMP (RFC:1215).
SQL-NET	TCP	1521	Structured Query Language is an interface to access data on many different types of database systems, including mainframes, midrange systems, UNIX systems and network servers.
SSH	TCP/UDP	22	Secure Shell Remote Login Program.

Table 61 Commonly Used Services (continued)

NAME	PROTOCOL	PORT(S)	DESCRIPTION
STRM WORKS	UDP	1558	Stream Works Protocol.
SYSLOG	UDP	514	Syslog allows you to send system logs to a UNIX server.
TACACS	UDP	49	Login Host Protocol used for (Terminal Access Controller Access Control System).
TELNET	TCP	23	Telnet is the login and terminal emulation protocol common on the Internet and in UNIX environments. It operates over TCP/IP networks. Its primary function is to allow users to log into remote host systems.
TFTP	UDP	69	Trivial File Transfer Protocol is an Internet file transfer protocol similar to FTP, but uses the UDP (User Datagram Protocol) rather than TCP (Transmission Control Protocol).
VDOLIVE	TCP	7000	Another videoconferencing solution.

# APPENDIX D

## Legal Information

### Copyright

Copyright © 2018 by Zyxel Communications Corporation.

The contents of this publication may not be reproduced in any part or as a whole, transcribed, stored in a retrieval system, translated into any language, or transmitted in any form or by any means, electronic, mechanical, magnetic, optical, chemical, photocopying, manual, or otherwise, without the prior written permission of Zyxel Communications Corporation.

Published by Zyxel Communications Corporation. All rights reserved.

### Disclaimer

Zyxel does not assume any liability arising out of the application or use of any products, or software described herein. Neither does it convey any license under its patent rights nor the patent rights of others. Zyxel further reserves the right to make changes in any products described herein without notice. This publication is subject to change without notice.

### Regulatory Notice and Statement

#### UNITED STATES of AMERICA



The following information applies if you use the product within USA area.

#### FCC EMC Statement

- The device complies with Part 15 of FCC rules. Operation is subject to the following two conditions:
  - (1) This device may not cause harmful interference, and
  - (2) This device must accept any interference received, including interference that may cause undesired operation.
- Changes or modifications not expressly approved by the party responsible for compliance could void the user's authority to operate the device.
- This product has been tested and complies with the specifications for a Class B digital device, pursuant to Part 15 of the FCC Rules. These limits are designed to provide reasonable protection against harmful interference in a residential installation. This device generates, uses, and can radiate radio frequency energy and, if not installed and used according to the instructions, may cause harmful interference to radio communications. However, there is no guarantee that interference will not occur in a particular installation.
- If this device does cause harmful interference to radio or television reception, which is found by turning the device off and on, the user is encouraged to try to correct the interference by one or more of the following measures:
  - Reorient or relocate the receiving antenna
  - Increase the separation between the devices
  - Connect the equipment to an outlet other than the receiver's
  - Consult a dealer or an experienced radio/TV technician for assistance

#### FCC Radiation Exposure Statement

- This device complies with FCC RF radiation exposure limits set forth for an uncontrolled environment.
- This transmitter must be at least 41 cm from the user and must not be co-located or operating in conjunction with any other antenna or transmitter.
- 

#### Safety Warning

- Do not open the device, opening or removing covers can expose you to dangerous high voltage points or other risks please, contact your vendor for further information.
- Caution! The RJ-45 jacks are not used for telephone line connection.

- Ne pas ouvrir l'appareil, l'ouverture ou le retrait des couvercles peut vous exposer à des points comportant des tensions élevées ou à d'autres risques. Veuillez contacter votre vendeur pour plus d'informations.
- Attention! Les câbles RJ-45 ne doivent pas être utilisés pour les connexions téléphoniques.

**Professional installation instruction**

- 1 Installation personal  
This product is designed for specific application and needs to be installed by a qualified personal who has RF and related rule knowledge. The general user shall not attempt to install or change the setting.
- 2 Installation location  
The product shall be installed at a location where the radiating antenna can be kept 41cm from nearby person in normal operation condition to meet regulatory RF exposure requirement.
- 3 External antenna  
Use only the antennas which have been approved by the applicant. The non-approved antenna(s) may produce unwanted spurious or excessive RF transmitting power which may lead to the violation of FCC limit and is prohibited.
- 4 Installation procedure  
Please refer to user's manual for the detail.
- 5 Warning  
Please carefully select the installation position and make sure that the final output power does not exceed the limit set force in relevant rules. The violation of the rule could lead to serious federal penalty.

**EUROPEAN UNION**



The following information applies if you use the product within the European Union.

**Declaration of Conformity with Regard to EU Directive 2014/53/EU (Radio Equipment Directive, RED)**

- Compliance information for 2.4GHz and/or 5GHz wireless products relevant to the EU and other Countries following the EU Directive 2014/53/EU (RED). And this product may be used in all EU countries (and other countries following the EU Directive 2014/53/EU) without any limitation except for the countries mentioned below table:
- In the majority of the EU and other European countries, the 5GHz bands have been made available for the use of wireless local area networks (LANs). Later in this document you will find an overview of countries in which additional restrictions or requirements or both are applicable. The requirements for any country may evolve. Zyxel recommends that you check with the local authorities for the latest status of their national regulations for the 5GHz wireless LANs.
- This equipment should be installed and operated with a minimum distance of 20cm between the radio equipment and your body.
- The maximum RF power operating for each band as follows:
  - the band 2,400 to 2,483.5 MHz is 87.70 mW,
  - the 5,470 MHz to 5,725 MHz is 935.41 mW.

Български (Bulgarian)	С настоящото Zyxel декларира, че това оборудване е в съответствие със съществените изисквания и другите приложими разпоредбите на Директива 2014/53/ЕС. <b>National Restrictions</b> <ul style="list-style-type: none"> <li>• The Belgian Institute for Postal Services and Telecommunications (BIPT) must be notified of any outdoor wireless link having a range exceeding 300 meters. Please check <a href="http://www.bipt.be">http://www.bipt.be</a> for more details.</li> <li>• Draadloze verbindingen voor buitengebruik en met een reikwijdte van meer dan 300 meter dienen aangemeld te worden bij het Belgisch Instituut voor postdiensten en telecommunicatie (BIPT). Zie <a href="http://www.bipt.be">http://www.bipt.be</a> voor meer gegevens.</li> <li>• Les liaisons sans fil pour une utilisation en extérieur d'une distance supérieure à 300 mètres doivent être notifiées à l'Institut Belge des services Postaux et des Télécommunications (IBPT). Visitez <a href="http://www.ibpt.be">http://www.ibpt.be</a> pour de plus amples détails.</li> </ul>
Español (Spanish)	Por medio de la presente Zyxel declara que el equipo cumple con los requisitos esenciales y cualesquiera otras disposiciones aplicables o exigibles de la Directiva 2014/53/UE..
Čeština (Czech)	Zyxel tímto prohlašuje, že tento zařízený je ve shodě se základními požadavky a dalšími příslušnými ustanoveními směrnice 2014/53/EU.
Dansk (Danish)	Undertegnede Zyxel erklærer herved, at følgende udstyr overholder de væsentlige krav og øvrige relevante krav i direktiv 2014/53/EU. <b>National Restrictions</b> <ul style="list-style-type: none"> <li>• In Denmark, the band 5150 - 5350 MHz is also allowed for outdoor usage.</li> <li>• I Danmark må frekvensbåndet 5150 - 5350 også anvendes udendørs.</li> </ul>
Deutsch (German)	Hiermit erklärt Zyxel, dass sich das Gerät Ausstattung in Übereinstimmung mit den grundlegenden Anforderungen und den übrigen einschlägigen Bestimmungen der Richtlinie 2014/53/EU befindet.
Eesti keel (Estonian)	Käesolevaga kinnitab Zyxel seadme seadmed vastavust direktiivi 2014/53/EL põhinõuetele ja nimetatud direktiivist tulenevatele teistele asjakohastele sätetele.

## Appendix D Legal Information

Ελληνικά (Greek)	ΜΕ ΤΗΝ ΠΑΡΟΥΣΑ Ζyxel ΔΗΛΩΝΕΙ ΟΤΙ εξοπλισμός ΣΥΜΜΟΡΦΩΝΕΤΑΙ ΠΡΟΣ ΤΙΣ ΟΥΣΙΩΔΕΙΣ ΑΠΑΙΤΗΣΕΙΣ ΚΑΙ ΤΙΣ ΛΟΙΠΕΣ ΣΧΕΤΙΚΕΣ ΔΙΑΤΑΞΕΙΣ ΤΗΣ ΟΔΗΓΙΑΣ 2014/53/ΕΕ.
English	Hereby, Zyxel declares that this device is in compliance with the essential requirements and other relevant provisions of Directive 2014/53/EU.
Français (French)	Par la présente Zyxel déclare que l'appareil équipements est conforme aux exigences essentielles et aux autres dispositions pertinentes de la directive 2014/53/UE.
Hrvatski (Croatian)	Zyxel ovime izjavljuje da je radijska oprema tipa u skladu s Direktivom 2014/53/UE.
Íslenska (Icelandic)	Hér með lýsir, Zyxel því yfir að þessi búnaður er í samræmi við grunnkröfur og önnur viðeigandi ákvæði tilskipunar 2014/53/UE.
Italiano (Italian)	Con la presente Zyxel dichiara che questo attrezzatura è conforme ai requisiti essenziali ed alle altre disposizioni pertinenti stabilite dalla direttiva 2014/53/UE. <b>National Restrictions</b> <ul style="list-style-type: none"> <li>This product meets the National Radio Interface and the requirements specified in the National Frequency Allocation Table for Italy. Unless this wireless LAN product is operating within the boundaries of the owner's property, its use requires a "general authorization." Please check <a href="http://www.sviluppoeconomico.gov.it/">http://www.sviluppoeconomico.gov.it/</a> for more details.</li> <li>Questo prodotto è conforme alle specifiche di Interfaccia Radio Nazionali e rispetta il Piano Nazionale di ripartizione delle frequenze in Italia. Se non viene installato all'interno del proprio fondo, l'utilizzo di prodotti Wireless LAN richiede una "Autorizzazione Generale". Consultare <a href="http://www.sviluppoeconomico.gov.it/">http://www.sviluppoeconomico.gov.it/</a> per maggiori dettagli.</li> </ul>
Latviešu valoda (Latvian)	Ar šo Zyxel deklarē, ka iekārtas atbilst Direktīvas 2014/53/ES būtiskajām prasībām un citiem ar to saistītajiem noteikumiem. <b>National Restrictions</b> <ul style="list-style-type: none"> <li>The outdoor usage of the 2.4 GHz band requires an authorization from the Electronic Communications Office. Please check <a href="http://www.esd.lv">http://www.esd.lv</a> for more details.</li> <li>2.4 GHz frekvenču joslas izmantošanai ārpus telpām nepieciešama atļauja no Elektronisko sakaru direkcijas. Vairāk informācijas: <a href="http://www.esd.lv">http://www.esd.lv</a>.</li> </ul>
Lietuvių kalba (Lithuanian)	Šiuo Zyxel deklaruoja, kad šis įranga atitinka esminius reikalavimus ir kitas 2014/53/ES Direktyvos nuostatas.
Magyar (Hungarian)	Alulírott, Zyxel nyilatkozom, hogy a berendezés megfelel a vonatkozó alapvető követelményeknek és az 2014/53/EU irányelv egyéb előírásainak.
Malti (Maltese)	Hawnhekk, Zyxel, jiddikjara li dan tagħmir jikkonforma mal-htigijiet essenzjali u ma provvedimenti oħrajn rilevanti li hemm fid-Direttiva 2014/53/UE.
Nederlands (Dutch)	Hierbij verklaart Zyxel dat het toestel uitrusting in overeenstemming is met de essentiële eisen en de andere relevante bepalingen van richtlijn 2014/53/EU.
Polski (Polish)	Niniejszym Zyxel oświadcza, że sprzęt jest zgodny z zasadniczymi wymogami oraz pozostałymi stosownymi postanowieniami Dyrektywy 2014/53/UE.
Português (Portuguese)	Zyxel declara que este equipamento está conforme com os requisitos essenciais e outras disposições da Directiva 2014/53/UE.
Română (Romanian)	Prin prezenta, Zyxel declară că acest echipament este în conformitate cu cerințele esențiale și alte prevederi relevante ale Directivei 2014/53/UE.
Slovenčina (Slovak)	Zyxel týmto vyhlasuje, že zariadenia spĺňa základné požiadavky a všetky príslušné ustanovenia Smernice 2014/53/EÚ.
Slovenščina (Slovene)	Zyxel izjavlja, da je ta oprema v skladu z bistvenimi zahtevami in ostalimi relevantnimi določili direktive 2014/53/EU.
Suomi (Finnish)	Zyxel vakuuttaa täten että laitteet tyyppinen laite on direktiivin 2014/53/EU oleellisten vaatimusten ja sitä koskevien direktiivin muiden ehtojen mukainen.
Svenska (Swedish)	Härmed intygar Zyxel att denna utrustning står i överensstämmelse med de väsentliga egenskapskrav och övriga relevanta bestämmelser som framgår av direktiv 2014/53/EU.
Norsk (Norwegian)	Erklærer herved Zyxel at dette utstyret er i samsvar med de grunnleggende kravene og andre relevante bestemmelser i direktiv 2014/53/EU.

### Notes:

- Although Norway, Switzerland and Liechtenstein are not EU member states, the EU Directive 2014/53/EU has also been implemented in those countries.
- The regulatory limits for maximum output power are specified in EIRP. The EIRP level (in dBm) of a device can be calculated by adding the gain of the antenna used (specified in dBi) to the output power available at the connector (specified in dBm).

## List of national codes

COUNTRY	ISO 3166 2 LETTER CODE	COUNTRY	ISO 3166 2 LETTER CODE
Austria	AT	Liechtenstein	LI
Belgium	BE	Lithuania	LT
Bulgaria	BG	Luxembourg	LU
Croatia	HR	Malta	MT
Cyprus	CY	Netherlands	NL
Czech Republic	CZ	Norway	NO
Denmark	DK	Poland	PL
Estonia	EE	Portugal	PT
Finland	FI	Romania	RO
France	FR	Serbia	RS
Germany	DE	Slovakia	SK
Greece	GR	Slovenia	SI
Hungary	HU	Spain	ES
Iceland	IS	Switzerland	CH
Ireland	IE	Sweden	SE
Italy	IT	Turkey	TR
Latvia	LV	United Kingdom	GB

## Safety Warnings

- Do not use this product near water, for example, in a wet basement or near a swimming pool.
- Do not expose your device to dampness, dust or corrosive liquids.
- Do not store things on the device.
- Do not obstruct the device ventilation slots as insufficient airflow may harm your device. For example, do not place the device in an enclosed space such as a box or on a very soft surface such as a bed or sofa.
- Do not install, use, or service this device during a thunderstorm. There is a remote risk of electric shock from lightning.
- Connect ONLY suitable accessories to the device.
- Do not open the device or unit. Opening or removing covers can expose you to dangerous high voltage points or other risks. ONLY qualified service personnel should service or disassemble this device. Please contact your vendor for further information.
- Make sure to connect the cables to the correct ports.
- Place connecting cables carefully so that no one will step on them or stumble over them.
- Always disconnect all cables from this device before servicing or disassembling.
- Do not remove the plug and connect it to a power outlet by itself; always attach the plug to the power adaptor first before connecting it to a power outlet.
- Do not allow anything to rest on the power adaptor or cord and do NOT place the product where anyone can walk on the power adaptor or cord.
- Please use the provided or designated connection cables/power cables/ adaptors. Connect it to the right supply voltage (for example, 110V AC in North America or 230V AC in Europe). If the power adaptor or cord is damaged, it might cause electrocution. Remove it from the device and the power source, repairing the power adapter or cord is prohibited. Contact your local vendor to order a new one.
- Do not use the device outside, and make sure all the connections are indoors. There is a remote risk of electric shock from lightning.
- CAUTION: Risk of explosion if battery is replaced by an incorrect type, dispose of used batteries according to the instruction. Dispose them at the applicable collection point for the recycling of electrical and electronic devices. For detailed information about recycling of this product, please contact your local city office, your household waste disposal service or the store where you purchased the product.
- The following warning statements apply, where the disconnect device is not incorporated in the device or where the plug on the power supply cord is intended to serve as the disconnect device.
  - For permanently connected devices, a readily accessible disconnect device shall be incorporated external to the device;
  - For pluggable devices, the socket-outlet shall be installed near the device and shall be easily accessible.
- The means of power cord of adapter should be connected to a socket-outlet with earthing connection.
- "This product is intended to be supplied by a Listed Power Adapter or DC power source marked "L.P.S." (or "Limited Power Source"), rated 12Vdc, 3.0A minimum, Tma = 40 degree C minimum. If need further assistance, please contact ZYXEL for further information."

## Environment Statement

## ErP (Energy-related Products)

Zyxel products put on the EU market in compliance with the requirement of the European Parliament and the Council published Directive 2009/125/EC establishing a framework for the setting of ecodesign requirements for energy-related products (recast), so called as "ErP Directive (Energy-related Products directive) as well as ecodesign requirement laid down in applicable implementing measures, power consumption has satisfied regulation requirements which are:

Network standby power consumption < 8W, and/or

Off mode power consumption < 0.5W, and/or

Standby mode power consumption < 0.5W.  
Wireless setting, please refer to "Wireless" chapter for more detail.

**European Union - Disposal and Recycling Information**

The symbol below means that according to local regulations your product and/or its battery shall be disposed of separately from domestic waste. If this product is end of life, take it to a recycling station designated by local authorities. At the time of disposal, the separate collection of your product and/or its battery will help save natural resources and ensure that the environment is sustainable development.

Die folgende Symbol bedeutet, dass Ihr Produkt und/oder seine Batterie gemäß den örtlichen Bestimmungen getrennt vom Hausmüll entsorgt werden muss. Wenden Sie sich an eine Recyclingstation, wenn dieses Produkt das Ende seiner Lebensdauer erreicht hat. Zum Zeitpunkt der Entsorgung wird die getrennte Sammlung von Produkt und/oder seiner Batterie dazu beitragen, natürliche Ressourcen zu sparen und die Umwelt und die menschliche Gesundheit zu schützen.

El símbolo de abajo indica que según las regulaciones locales, su producto y/o su batería deberán depositarse como basura separada de la doméstica. Cuando este producto alcance el final de su vida útil, llévelo a un punto limpio. Cuando llegue el momento de desechar el producto, la recogida por separado éste y/o su batería ayudará a salvar los recursos naturales y a proteger la salud humana y medioambiental.

Le symbole ci-dessous signifie que selon les réglementations locales votre produit et/ou sa batterie doivent être éliminés séparément des ordures ménagères. Lorsque ce produit atteint sa fin de vie, amenez-le à un centre de recyclage. Au moment de la mise au rebut, la collecte séparée de votre produit et/ou de sa batterie aidera à économiser les ressources naturelles et protéger l'environnement et la santé humaine.

Il simbolo sotto significa che secondo i regolamenti locali il vostro prodotto e/o batteria deve essere smaltito separatamente dai rifiuti domestici. Quando questo prodotto raggiunge la fine della vita di servizio portarlo a una stazione di riciclaggio. Al momento dello smaltimento, la raccolta separata del vostro prodotto e/o della sua batteria aiuta a risparmiare risorse naturali e a proteggere l'ambiente e la salute umana.

Symbolen innebär att enligt lokal lagstiftning ska produkten och/eller dess batteri kastas separat från hushållsavfallet. När den här produkten når slutet av sin livslängd ska du ta den till en återvinningsstation. Vid tiden för kasseringen bidrar du till en bättre miljö och mänsklig hälsa genom att göra dig av med den på ett återvinningsställe.



**About the Symbols**

Various symbols are used in this product to ensure correct usage, to prevent danger to the user and others, and to prevent property damage. The meaning of these symbols are described below. It is important that you read these descriptions thoroughly and fully understand the contents.

**Explanation of the Symbols**

SYMBOL	EXPLANATION
	Alternating current (AC): AC is an electric current in which the flow of electric charge periodically reverses direction.
	Direct current (DC): DC is the unidirectional flow or movement of electric charge carriers.
	Earth; ground: A wiring terminal intended for connection of a Protective Earthing Conductor.
	Class II equipment: The method of protection against electric shock in the case of class II equipment is either double insulation or reinforced insulation.

**Viewing Certifications**

Go to <http://www.zyxel.com> to view this product's documentation and certifications.



## Zyxel Limited Warranty

Zyxel warrants to the original end user (purchaser) that this product is free from any defects in material or workmanship for a specific period (the Warranty Period) from the date of purchase. The Warranty Period varies by region. Check with your vendor and/or the authorized Zyxel local distributor for details about the Warranty Period of this product. During the warranty period, and upon proof of purchase, should the product have indications of failure due to faulty workmanship and/or materials, Zyxel will, at its discretion, repair or replace the defective products or components without charge for either parts or labor, and to whatever extent it shall deem necessary to restore the product or components to proper operating condition. Any replacement will consist of a new or re-manufactured functionally equivalent product of equal or higher value, and will be solely at the discretion of Zyxel. This warranty shall not apply if the product has been modified, misused, tampered with, damaged by an act of God, or subjected to abnormal working conditions.

### Note

Repair or replacement, as provided under this warranty, is the exclusive remedy of the purchaser. This warranty is in lieu of all other warranties, express or implied, including any implied warranty of merchantability or fitness for a particular use or purpose. Zyxel shall in no event be held liable for indirect or consequential damages of any kind to the purchaser.

To obtain the services of this warranty, contact your vendor. You may also refer to the warranty policy for the region in which you bought the device at [http://www.zyxel.com/web/support\\_warranty\\_info.php](http://www.zyxel.com/web/support_warranty_info.php).

## Registration

Register your product online to receive e-mail notices of firmware upgrades and information at [www.zyxel.com](http://www.zyxel.com) for global products, or at [www.us.zyxel.com](http://www.us.zyxel.com) for North American products.

## Open Source Licenses

This product contains in part some free software distributed under GPL license terms and/or GPL like licenses. Open source licenses are provided with the firmware package. You can download the latest firmware at [www.zyxel.com](http://www.zyxel.com). To obtain the source code covered under those Licenses, please contact [support@zyxel.com.tw](mailto:support@zyxel.com.tw) to get it.

# Index

## A

Address Assignment [73](#)  
ALG [90](#)  
    and NAT [90](#)  
    and security policy [90](#)  
AP [10](#)  
AP Mode  
    menu [45](#)  
    status screen [43](#)  
AP+Bridge [10](#)  
Application Layer Gateway, see ALG

## B

Bridge/Repeater [10](#)

## C

certifications [199](#)  
    viewing [200](#)  
Channel [37, 44](#)  
channel [94](#)  
Configuration  
    restore [151, 154, 156](#)  
contact information [167](#)  
content filtering  
    by keyword (in URL) [117](#)  
copyright [196](#)  
CPU usage [37, 44](#)  
customer support [167](#)

## D

Daylight saving [149](#)  
DDNS

    service providers [143](#)  
DHCP [59](#)  
    see also Dynamic Host Configuration Protocol  
DHCP server [59, 113](#)  
Digital Living Network Alliance [118](#)  
disclaimer [196](#)  
DLNA [118, 127](#)  
    indexing [128](#)  
    overview [127](#)  
    rescan [128](#)  
DLNA-compliant client [118](#)  
DNS Server [73](#)  
Domain Name System. See DNS.  
duplex setting [37, 45](#)  
Dynamic Host Configuration Protocol [59](#)  
DynDNS [143](#)  
DynDNS see also DDNS [143](#)

## E

encryption [95](#)  
    and local (user) database [96](#)  
    key [96](#)  
    WPA compatible [96](#)  
ESSID [164](#)

## F

file sharing [130](#)  
    access right [132, 133](#)  
    bandwidth [133](#)  
    example [133](#)  
    FTP [132, 137](#)  
    overview [130](#)  
    Samba [130](#)  
    user account [131, 132](#)  
    Windows Explorer [130](#)  
    work group [130](#)

Firewall  
 guidelines [141](#)  
 ICMP packets [143](#)

firewall  
 stateful inspection [140](#)

Firmware upload [149](#)  
 file extension  
 using HTTP

firmware version [36, 44](#)

FTP  
 ALG [90](#)

## G

General wireless LAN screen [97](#)

Guest WLAN [96](#)

Guest WLAN Bandwidth [97](#)

## H

H.323  
 ALG [90](#)

## I

IGMP [74](#)  
 see also Internet Group Multicast Protocol  
 version

IGMP version [74](#)

Internet Group Multicast Protocol [74](#)

IP Address [113](#)

## L

LAN [112](#)  
 LAN overview [112](#)  
 LAN setup [112](#)  
 Language [152](#)  
 Link type [37, 44](#)  
 local (user) database [95](#)

and encryption [96](#)  
 Local Area Network [112](#)

## M

MAC [106](#)

MAC address [73, 94](#)  
 cloning [73](#)

MAC address filter [94](#)

MAC address filtering [106](#)

MAC filter [106](#)

managing the device  
 good habits [10](#)  
 using the web configurator. See web configurator.  
 using the WPS. See WPS.

MBSSID [10](#)

Media access control [106](#)

media client [127](#)

media file [127, 128](#)  
 type [128](#)

media server  
 overview [127](#)

media file play [127](#)

Memory usage [37, 44](#)

mode [10](#)

Multicast [74](#)  
 IGMP [74](#)

## N

NAT  
 and ALG [90](#)

NAT Traversal [139](#)

Navigation Panel [38, 45](#)

navigation panel [38, 45](#)

## O

operating mode [10](#)

**P**

Point-to-Point Protocol over Ethernet **80**  
port speed **37, 45**  
PPPoE **80**  
    dial-up connection

**Q**

Quality of Service (QoS) **109**

**R**

RADIUS server **95**  
Reset button **11**  
Reset the device **11**  
Restore configuration **151, 154, 156**  
Roaming **107**  
Router Mode  
    status screen **35**  
RTS/CTS Threshold **94, 107, 108**

**S**

Samba **118**  
Scheduling **110**  
security policy  
    and ALG **90**  
Service Set **98, 106**  
Service Set IDentification **98, 106**  
Service Set IDentity. See SSID.  
SIP  
    ALG **90**  
SSID **37, 44, 94, 98, 106**  
stateful inspection firewall **140**  
Static DHCP **63, 68**  
Status **35**  
StreamBoost  
    bandwidth **125**  
    device priority **126**  
    example **125**

Subnet Mask **113**  
System General Setup **146**  
System restart **152**

**T**

TCP/IP configuration **59**  
Time setting **148**

**U**

Universal Plug and Play **129**  
    Application **139**  
    Security issues **139**  
UPnP **129**  
user authentication **95**  
    local (user) database **95**  
    RADIUS server **95**

**V**

VoIP pass through  
    see also ALG

**W**

WAN (Wide Area Network) **72**  
WAN MAC address **73**  
warranty **201**  
    note **201**  
Web Configurator  
    how to access **14**  
    Overview **14**  
web configurator **10**  
WEP Encryption **101**  
windows media player **127**  
wireless channel **164**  
wireless LAN **164**  
wireless LAN scheduling **110**  
Wireless network

- basic guidelines [94](#)
- channel [94](#)
- encryption [95](#)
- example [93](#)
- MAC address filter [94](#)
- overview [93](#)
- security [94](#)
- SSID [94](#)
- Wireless security [94](#)
  - overview [94](#)
  - type [94](#)
- wireless security [164](#)
- Wireless tutorial [48](#)
- Wizard setup [17](#)
- WLAN button [11](#)
- work group [118](#)
  - name [118](#)
  - Windows [118](#)
- WPA compatible [96](#)
- WPS [10](#)