

FCC Test Report

Report No.: RF170913E07-1

FCC ID: I88EMG2881-T20A

Test Model: EMG2881-T20A

Received Date: Sep. 13, 2017

Test Date: Oct. 02 to 06, 2017

Issued Date: Jan. 09, 2018

Applicant: Zyxel Communications Corporation

Address: No.2 Industry East RD. IX, Hsinchu Science Park, Hsinchu 30075, Taiwan

Issued By: Bureau Veritas Consumer Products Services (H.K.) Ltd., Taoyuan Branch
Hsin Chu Laboratory

Lab Address: E-2, No.1, Li Hsin 1st Road, Hsinchu Science Park, Hsinchu City 300,
Taiwan R.O.C.

Test Location : E-2, No.1, Li Hsin 1st Road, Hsinchu Science Park, Hsinchu City 300,
Taiwan R.O.C.

**FCC Registration /
Designation Number:** 723255 / TW2022



This report is for your exclusive use. Any copying or replication of this report to or for any other person or entity, or use of our name or trademark, is permitted only with our prior written permission. This report sets forth our findings solely with respect to the test samples identified herein. The results set forth in this report are not indicative or representative of the quality or characteristics of the lot from which a test sample was taken or any similar or identical product unless specifically and expressly noted. Our report includes all of the tests requested by you and the results thereof based upon the information that you provided to us. You have 60 days from date of issuance of this report to notify us of any material error or omission caused by our negligence, provided, however, that such notice shall be in writing and shall specifically address the issue you wish to raise. A failure to raise such issue within the prescribed time shall constitute your unqualified acceptance of the completeness of this report, the tests conducted and the correctness of the report contents. Unless specific mention, the uncertainty of measurement has been explicitly taken into account to declare the compliance or non-compliance to the specification. The report must not be used by the client to claim product certification, approval, or endorsement by TAF or any government agencies.

Table of Contents

Release Control Record	4
1 Certificate of Conformity	5
2 Summary of Test Results	6
2.1 Measurement Uncertainty	6
2.2 Modification Record	6
3 General Information	7
3.1 General Description of EUT	7
3.2 Description of Test Modes	10
3.2.1 Test Mode Applicability and Tested Channel Detail	11
3.3 Duty Cycle of Test Signal	13
3.4 Description of Support Units	14
3.4.1 Configuration of System under Test	14
3.5 General Description of Applied Standard	15
4 Test Types and Results	16
4.1 Radiated Emission and Bandedge Measurement	16
4.1.1 Limits of Radiated Emission and Bandedge Measurement	16
4.1.2 Test Instruments	17
4.1.3 Test Procedure	19
4.1.4 Deviation from Test Standard	19
4.1.5 Test Setup	20
4.1.6 EUT Operating Condition	21
4.1.7 Test Results	22
4.2 Conducted Emission Measurement	42
4.2.1 Limits of Conducted Emission Measurement	42
4.2.2 Test Instruments	42
4.2.3 Test Procedure	43
4.2.4 Deviation from Test Standard	43
4.2.5 Test Setup	43
4.2.6 EUT Operating Condition	43
4.2.7 Test Results	44
4.3 Transmit Power Measurement	46
4.3.1 Limits of Transmit Power Measurement	46
4.3.2 Test Setup	46
4.3.3 Test Instruments	46
4.3.4 Test Procedure	46
4.3.5 Deviation from Test Standard	46
4.3.6 EUT Operating Condition	46
4.3.7 Test Result	47
4.4 Occupied Bandwidth Measurement	50
4.4.1 Test Setup	50
4.4.2 Test Instruments	50
4.4.3 Test Procedure	50
4.4.4 Test Results	51
4.5 Peak Power Spectral Density Measurement	55
4.5.1 Limits of Peak Power Spectral Density Measurement	55
4.5.2 Test Setup	55
4.5.3 Test Instruments	55
4.5.4 Test Procedure	56
4.5.5 Deviation from Test Standard	56
4.5.6 EUT Operating Condition	56
4.5.7 Test Results	57
4.6 Frequency Stability Measurement	63
4.6.1 Limits of Frequency Stability Measurement	63

4.6.2	Test Setup.....	63
4.6.3	Test Instruments	63
4.6.4	Test Procedure	63
4.6.5	Deviation from Test Standard	63
4.6.6	EUT Operating Condition	63
4.6.7	Test Results	64
4.7	6dB Bandwidth Measurement	65
4.7.1	Limits of 6dB Bandwidth Measurement.....	65
4.7.2	Test Setup.....	65
4.7.3	Test Instruments	65
4.7.4	Test Procedure	65
4.7.5	Deviation from Test Standard	65
4.7.6	EUT Operating Condition	65
4.7.7	Test Results	66
5	Pictures of Test Arrangements.....	68
	Annex A- Radiated Out of Band Emission (OOBE) Measurement (For U-NII-3 band)	69
	Appendix – Information on the Testing Laboratories	73

Release Control Record

Issue No.	Description	Date Issued
RF170913E07-1	Original release.	Jan. 09, 2018

1 Certificate of Conformity

Product: Dual Band Wireless AC1300 Gigabit Ethernet Gateway

Brand: ZYXEL

Test Model: EMG2881-T20A

Sample Status: ENGINEERING SAMPLE

Applicant: Zyxel Communications Corporation

Test Date: Oct. 02 to 06, 2017

Standard: 47 CFR FCC Part 15, Subpart E (Section 15.407)
ANSI C63.10: 2013

The above equipment has been tested by **Bureau Veritas Consumer Products Services (H.K.) Ltd., Taoyuan Branch**, and found compliance with the requirement of the above standards. The test record, data evaluation & Equipment Under Test (EUT) configurations represented herein are true and accurate accounts of the measurements of the sample's EMC characteristics under the conditions specified in this report.

Prepared by : Cindy Hsin , **Date:** Jan. 09, 2018
Cindy Hsin / Specialist

Approved by : May Chen , **Date:** Jan. 09, 2018
May Chen / Manager

2 Summary of Test Results

47 CFR FCC Part 15, Subpart E (Section 15.407)			
FCC Clause	Test Item	Result	Remarks
15.407(b)(6)	AC Power Conducted Emissions	Pass	Meet the requirement of limit. Minimum passing margin is -13.11dB at 5.75781MHz.
15.407(b)(1/2/3/4(i/ii)/6)	Radiated Emissions & Band Edge Measurement*	Pass	Meet the requirement of limit. Minimum passing margin is -0.5dB at 5150.00MHz, 11510.00MHz, 11590.00MHz, 17325.00MHz.
15.407(a)(1/2/3)	Max Average Transmit Power	Pass	Meet the requirement of limit.
---	Occupied Bandwidth Measurement	-	Reference only.
15.407(a)(1/2/3)	Peak Power Spectral Density	Pass	Meet the requirement of limit.
15.407(e)	6dB bandwidth	Pass	Meet the requirement of limit. (U-NII-3 Band only)
15.407(g)	Frequency Stability	Pass	Meet the requirement of limit.
15.203	Antenna Requirement	Pass	Antenna connector is i-pex(MHF) not a standard connector.

*For U-NII-3 band compliance with rule part 15.407(b)(4)(i), the OOB test plots were recorded in Annex A.

2.1 Measurement Uncertainty

Where relevant, the following measurement uncertainty levels have been estimated for tests performed on the EUT as specified in CISPR 16-4-2:

Measurement	Frequency	Expanded Uncertainty (k=2) (±)
Conducted Emissions at mains ports	150kHz ~ 30MHz	1.84 dB
Radiated Emissions up to 1 GHz	30MHz ~ 1GHz	5.32 dB
Radiated Emissions above 1 GHz	1GHz ~ 6GHz	5.14 dB
	6GHz ~ 18GHz	5.04 dB
	18GHz ~ 40GHz	5.25 dB

2.2 Modification Record

There were no modifications required for compliance.

3 General Information

3.1 General Description of EUT

Product	Dual Band Wireless AC1300 Gigabit Ethernet Gateway
Brand	ZYXEL
Test Model	EMG2881-T20A
RF CPU Model No.	MT7621
RF Chip Model No.	2.4GHz: MT7615D 5GHz: MT7615D
FW	V3.10(ABKX.0)b1
Status of EUT	ENGINEERING SAMPLE
Power Supply Rating	DC 12V from Adapter
Modulation Type	CCK, DQPSK, DBPSK for DSSS 64QAM, 16QAM, QPSK, BPSK for OFDM 256QAM for OFDM in 11ac mode.
Modulation Technology	DSSS, OFDM
Transfer Rate	802.11b: up to 11Mbps 802.11a/g: up to 54Mbps 802.11n: up to 300Mbps 802.11ac: up to 866.7Mbps
Operating Frequency	2.4GHz: 2.412 ~ 2.462GHz 5GHz: 5.18GHz ~ 5.24GHz, 5.745GHz ~ 5.825GHz
Number of Channel	2.4GHz: 802.11b, 802.11g, 802.11n (HT20): 11 802.11n (HT40): 7 5GHz: 802.11a, 802.11n (HT20), 802.11ac (VHT20): 9 802.11n (HT40), 802.11ac (VHT40): 4 802.11ac (VHT80): 2
Output Power	2.4GHz: 579.966mW 5.18 ~ 5.24GHz CDD Mode: 880.11mW Beamforming Mode: 773.666mW 5.745 ~ 5.825GHz CDD Mode: 684.156mW Beamforming Mode: 684.156mW
Antenna Type	Refer to Note
Antenna Connector	Refer to Note
Accessory Device	Adapter x 1
Data Cable Supplied	Ethernet cable x 1 (Unshielded, 1.5m)

Note:

1. Simultaneously transmission condition.

Condition	Technology	
1	WLAN 2.4GHz	WLAN 5GHz

Note: The emission of the simultaneous operation has been evaluated and no non-compliance was found.

2. The EUT power needs to be supplied from power adapters, the information is as below table:

Brand	Model No.	Spec.
Frecom	F18L10-120150SPAU	Input: 100-240V, 0.6A, 50/60Hz Output: 12V, 1.5A DC Cable (unshielded, 1.5m)

3. The antennas provided to the EUT, please refer to the following table:

Transmitter Circuit.	Brand	Model	Antenna Gain(dBi) Including cable loss	Frequency range	Antenna Type	Connecter Type	Cable Length
Chain 0	CINGXIN	A176-17042802	2.97	2.4~2.4835GHz	PCB	i-pex(MHF)	60mm
			2.99	5.15~5.85GHz			
Chain 1	CINGXIN	A176-17042801	2.75	2.4~2.4835GHz	PCB	i-pex(MHF)	150mm
			2.97	5.15~5.85GHz			

4. The EUT incorporates a MIMO function:

For 2.4GHz					
MODULATION MODE	DATA RATE (MCS)	TX & RX CONFIGURATION		NON-TXBF Mode	TXBF Mode
802.11b	1 ~ 11Mbps	2TX	2RX	v	-
802.11g	6 ~ 54Mbps	2TX	2RX	v	-
802.11n (HT20)	MCS 0~7	2TX	2RX	v	-
	MCS 8~15	2TX	2RX	v	-
802.11n (HT40)	MCS 0~7	2TX	2RX	v	-
	MCS 8~15	2TX	2RX	v	-
For 5GHz					
MODULATION MODE	DATA RATE (MCS)	TX & RX CONFIGURATION		NON-TXBF Mode	TXBF Mode
802.11a	6 ~ 54Mbps	2TX	2RX	v	-
802.11n (HT20)	MCS 0~7	2TX	2RX	v	v
	MCS 8~15	2TX	2RX	v	v
802.11n (HT40)	MCS 0~7	2TX	2RX	v	v
	MCS 8~15	2TX	2RX	v	v
802.11ac (VHT20)	MCS0~8 Nss=1	2TX	2RX	v	v
	MCS0~8 Nss=2	2TX	2RX	v	v
802.11ac (VHT40)	MCS0~9 Nss=1	2TX	2RX	v	v
	MCS0~9 Nss=2	2TX	2RX	v	v
802.11ac (VHT80)	MCS0~9 Nss=1	2TX	2RX	v	v
	MCS0~9 Nss=2	2TX	2RX	v	v

Note:

- All of modulation mode support beamforming function except 2.4GHz and 802.11a modulation mode.
- The EUT support Beamforming and CDD mode, therefore both mode were investigated and the worst case scenario was identified. The worst case data were presented in test report.
- The modulation and bandwidth are similar for 802.11n mode for 20MHz (40MHz) and 802.11ac mode for 20MHz (40MHz), therefore investigated worst case to representative mode in test report. (Final test mode refer section 3.2.1)

5. The power setting are list as below:

Modulation Mode	Frequency (MHz)	Power Setting (CDD)	Power Setting (Beamforming)
802.11a	5180	12	-
	5200	17	-
	5240	1B	-
	5745	0B	-
	5785	0C	-
	5825	0B	-
802.11ac (VHT20)	5180	13	13
	5200	16	16
	5240	16	16
	5745	10	10
	5785	10	10
	5825	0F	0F
802.11ac (VHT40)	5190	0C	0C
	5230	18	18
	5755	17	17
	5795	16	16
802.11ac (VHT80)	5210	5	5
	5775	18	18

6. The above EUT information is declared by manufacturer and for more detailed features description, please refer to the manufacturer's specifications or user's manual.

3.2 Description of Test Modes

FOR 5180 ~ 5240MHz

4 channels are provided for 802.11a, 802.11n (HT20), 802.11ac (VHT20):

Channel	Frequency	Channel	Frequency
36	5180MHz	44	5220MHz
40	5200MHz	48	5240MHz

2 channels are provided for 802.11n (HT40), 802.11ac (VHT40):

Channel	Frequency	Channel	Frequency
38	5190MHz	46	5230MHz

1 channel is provided for 802.11ac (VHT80):

Channel	Frequency
42	5210MHz

FOR 5745 ~ 5825MHz:

5 channels are provided for 802.11a, 802.11n (HT20), 802.11ac (VHT20):

Channel	Frequency	Channel	Frequency
149	5745MHz	161	5805MHz
153	5765MHz	165	5825MHz
157	5785MHz		

2 channels are provided for 802.11n (HT40), 802.11ac (VHT40):

Channel	Frequency	Channel	Frequency
151	5755MHz	159	5795MHz

1 channel is provided for 802.11ac (VHT80):

Channel	Frequency
155	5775MHz

3.2.1 Test Mode Applicability and Tested Channel Detail

EUT Configure Mode	Applicable To				Description
	RE \geq 1G	RE $<$ 1G	PLC	APCM	
-	√	√	√	√	-

Where **RE \geq 1G**: Radiated Emission above 1GHz **RE $<$ 1G**: Radiated Emission below 1GHz
PLC: Power Line Conducted Emission **APCM**: Antenna Port Conducted Measurement

Radiated Emission Test (Above 1GHz):

- Pre-Scan has been conducted to determine the worst-case mode from all possible combinations between available modulations, data rates and antenna ports (if EUT with antenna diversity architecture).
- Following channel(s) was (were) selected for the final test as listed below.

CDD Mode						
Mode	FREQ. Band (MHz)	Available Channel	Tested Channel	Modulation Technology	Modulation Type	Data Rate (Mbps)
802.11a	5180-5240	36 to 48	36, 40, 48	OFDM	BPSK	6
802.11ac (VHT20)		36 to 48	36, 40, 48	OFDM	BPSK	6.5
802.11ac (VHT40)		38 to 46	38, 46	OFDM	BPSK	13.5
802.11ac (VHT80)		42	42	OFDM	BPSK	29.3
802.11a	5745-5825	149 to 165	149, 157, 165	OFDM	BPSK	6
802.11ac (VHT20)		149 to 165	149, 157, 165	OFDM	BPSK	6.5
802.11ac (VHT40)		151 to 159	151, 159	OFDM	BPSK	13.5
802.11ac (VHT80)		155	155	OFDM	BPSK	29.3

Radiated Emission Test (Below 1GHz):

- Pre-Scan has been conducted to determine the worst-case mode from all possible combinations between available modulations, data rates and antenna ports (if EUT with antenna diversity architecture).
- Following channel(s) was (were) selected for the final test as listed below.

CDD Mode						
Mode	FREQ. Band (MHz)	Available Channel	Tested Channel	Modulation Technology	Modulation Type	Data Rate (Mbps)
802.11a	5180-5240 5745-5825	36 to 48 149 to 165	48	OFDM	BPSK	6

Power Line Conducted Emission Test:

- Pre-Scan has been conducted to determine the worst-case mode from all possible combinations between available modulations, data rates and antenna ports (if EUT with antenna diversity architecture).
- Following channel(s) was (were) selected for the final test as listed below.

CDD Mode						
Mode	FREQ. Band (MHz)	Available Channel	Tested Channel	Modulation Technology	Modulation Type	Data Rate (Mbps)
802.11a	5180-5240 5745-5825	36 to 48 149 to 165	48	OFDM	BPSK	6

Antenna Port Conducted Measurement:

- This item includes all test value of each mode, but only includes spectrum plot of worst value of each mode.
- Pre-Scan has been conducted to determine the worst-case mode from all possible combinations between available modulations, data rates and antenna ports (if EUT with antenna diversity architecture).
- Following channel(s) was (were) selected for the final test as listed below.

CDD Mode						
Mode	FREQ. Band (MHz)	Available Channel	Tested Channel	Modulation Technology	Modulation Type	Data Rate (Mbps)
802.11a	5180-5240	36 to 48	36, 40, 48	OFDM	BPSK	6
802.11ac (VHT20)		36 to 48	36, 40, 48	OFDM	BPSK	6.5
802.11ac (VHT40)		38 to 46	38, 46	OFDM	BPSK	13.5
802.11ac (VHT80)		42	42	OFDM	BPSK	29.3
802.11a	5745-5825	149 to 165	149, 157, 165	OFDM	BPSK	6
802.11ac (VHT20)		149 to 165	149, 157, 165	OFDM	BPSK	6.5
802.11ac (VHT40)		151 to 159	151, 159	OFDM	BPSK	13.5
802.11ac (VHT80)		155	155	OFDM	BPSK	29.3
Beamforming Mode (Output power only)						
Mode	FREQ. Band (MHz)	Available Channel	Tested Channel	Modulation Technology	Modulation Type	Data Rate (Mbps)
802.11ac (VHT20)	5180-5240	36 to 48	36, 40, 48	OFDM	BPSK	6.5
802.11ac (VHT40)		38 to 46	38, 46	OFDM	BPSK	13.5
802.11ac (VHT80)		42	42	OFDM	BPSK	29.3
802.11ac (VHT20)	5745-5825	149 to 165	149, 157, 165	OFDM	BPSK	6.5
802.11ac (VHT40)		151 to 159	151, 159	OFDM	BPSK	13.5
802.11ac (VHT80)		155	155	OFDM	BPSK	29.3

Test Condition:

Applicable To	Environmental Conditions	Input Power	Tested By
RE \geq 1G	25deg. C, 65%RH	120Vac, 60Hz	Jyunchun Lin
RE $<$ 1G	25deg. C, 65%RH	120Vac, 60Hz	Nelson Teng
PLC	25deg. C, 75%RH	120Vac, 60Hz	Andy Ho
APCM	25deg. C, 60%RH	120Vac, 60Hz	Robert Cheng

3.3 Duty Cycle of Test Signal

If duty cycle of test signal is < 98%, duty factor shall be considered.

802.11a: Duty cycle = $1.393/1.725 = 0.808$, Duty factor = $10 * \log(1/0.808) = 0.93$

802.11ac (VHT20): Duty cycle = $1.313/1.655 = 0.793$, Duty factor = $10 * \log(1/0.793) = 1.01$

802.11ac (VHT40): Duty cycle = $0.654/0.992 = 0.659$, Duty factor = $10 * \log(1/0.659) = 1.81$

802.11ac (VHT80): Duty cycle = $0.322/0.669 = 0.481$, Duty factor = $10 * \log(1/0.481) = 3.18$

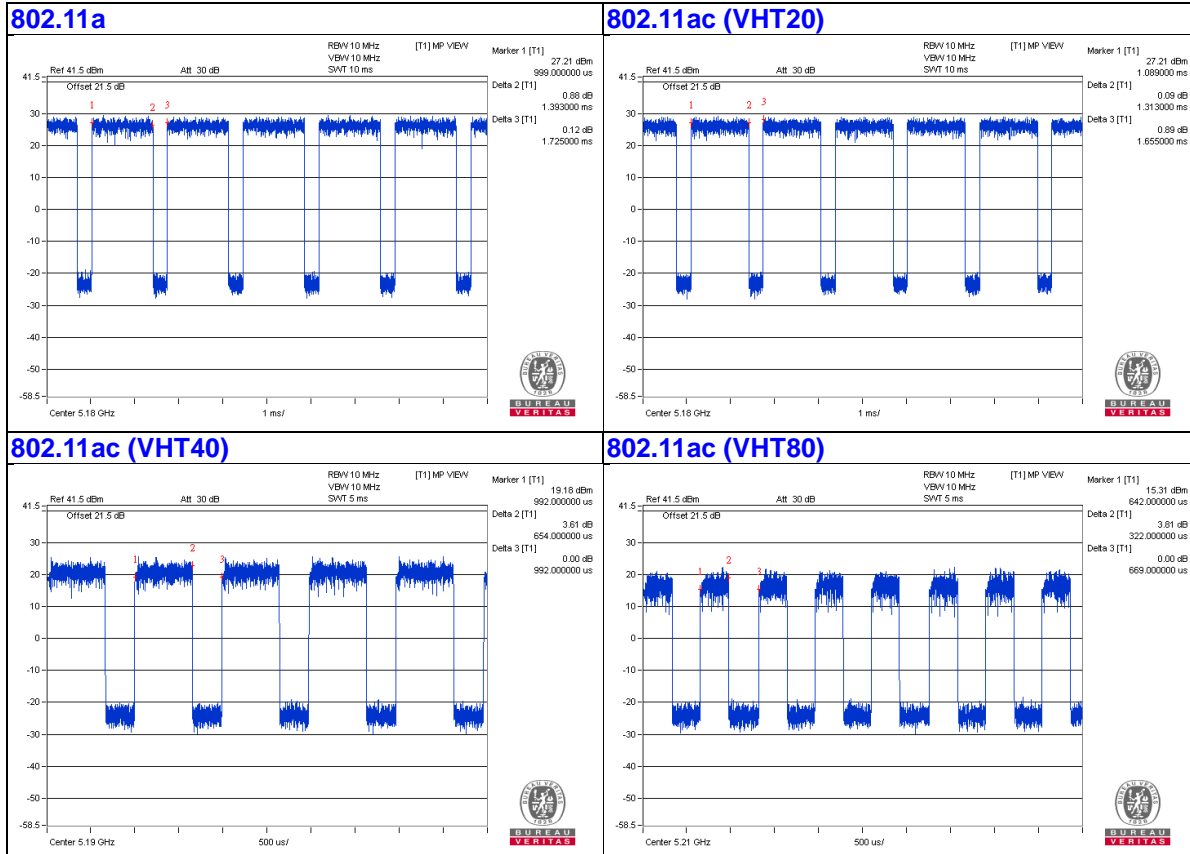

3.4 Description of Support Units

The EUT has been tested as an independent unit together with other necessary accessories or support units. The following support units or accessories were used to form a representative test configuration during the tests.

ID	Product	Brand	Model No.	Serial No.	FCC ID	Remarks
A.	Laptop	DELL	E6420	B92T3R1	FCC DoC	Provided by Lab

Note:

1. All power cords of the above support units are non-shielded (1.8m).

ID	Descriptions	Qty.	Length (m)	Shielding (Yes/No)	Cores (Qty.)	Remarks
1.	DC Cable	1	1.5	No	0	Supplied by client
2.	RJ-45 Cable	1	10	No	0	Provided by Lab

3.4.1 Configuration of System under Test

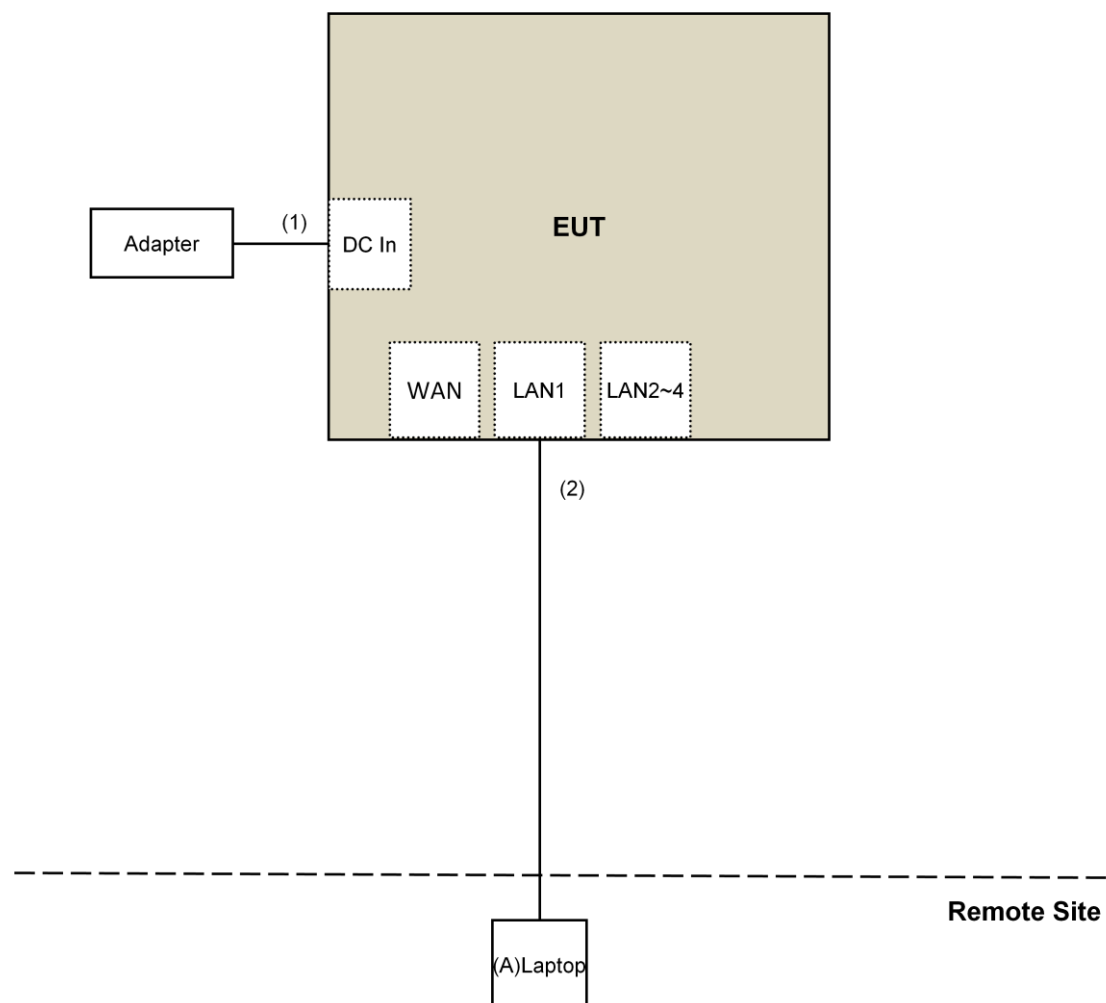

Note: The test configuration was defined by the client requirement.

3.5 General Description of Applied Standard

The EUT is a RF Product. According to the specifications of the manufacturer, it must comply with the requirements of the following standards:

FCC Part 15, Subpart E (15.407)
KDB 789033 D02 General UNII Test Procedure New Rules v02r01
KDB 662911 D01 Multiple Transmitter Output v02r01
ANSI C63.10-2013

All test items have been performed and recorded as per the above standards.

NOTE: The EUT has been verified to comply with the requirements of FCC Part 15, Subpart B, Class B (DoC). The test report has been issued separately.

4 Test Types and Results

4.1 Radiated Emission and Bandedge Measurement

4.1.1 Limits of Radiated Emission and Bandedge Measurement

Radiated emissions which fall in the restricted bands must comply with the radiated emission limits specified as below table.

Frequencies (MHz)	Field Strength (microvolts/meter)	Measurement Distance (meters)
0.009 ~ 0.490	2400/F(kHz)	300
0.490 ~ 1.705	24000/F(kHz)	30
1.705 ~ 30.0	30	30
30 ~ 88	100	3
88 ~ 216	150	3
216 ~ 960	200	3
Above 960	500	3

NOTE:

1. The lower limit shall apply at the transition frequencies.
2. Emission level (dBuV/m) = 20 log Emission level (uV/m).
3. For frequencies above 1000MHz, the field strength limits are based on average detector, however, the peak field strength of any emission shall not exceed the maximum permitted average limits, specified above by more than 20dB under any condition of modulation.

Limits of unwanted emission out of the restricted bands

Applicable To		Limit	
789033 D02 General UNII Test Procedure New Rules v01r04		Field Strength at 3m	
		PK:74 (dBuV/m)	AV:54 (dBuV/m)
Frequency Band	Applicable To	EIRP Limit	Equivalent Field Strength at 3m
5150~5250 MHz	15.407(b)(1)	PK:-27 (dBm/MHz)	PK:68.2(dBuV/m)
5250~5350 MHz	15.407(b)(2)		
5470~5725 MHz	15.407(b)(3)		
5725~5850 MHz	<input checked="" type="checkbox"/> 15.407(b)(4)(i)	PK:-27 (dBm/MHz) ^{*1} PK:10 (dBm/MHz) ^{*2} PK:15.6 (dBm/MHz) ^{*3} PK:27 (dBm/MHz) ^{*4}	PK: 68.2(dBuV/m) ^{*1} PK:105.2 (dBuV/m) ^{*2} PK: 110.8(dBuV/m) ^{*3} PK:122.2 (dBuV/m) ^{*4}
	<input type="checkbox"/> 15.407(b)(4)(ii)	Emission limits in section 15.247(d)	
^{*1} beyond 75 MHz or more above of the band edge.		^{*2} below the band edge increasing linearly to 10 dBm/MHz at 25 MHz above.	
^{*3} below the band edge increasing linearly to a level of 15.6 dBm/MHz at 5 MHz above.		^{*4} from 5 MHz above or below the band edge increasing linearly to a level of 27 dBm/MHz at the band edge.	

Note:

The following formula is used to convert the equipment isotropic radiated power (eirp) to field strength:

$$E = \frac{1000000\sqrt{30P}}{3} \mu\text{V/m, where P is the eirp (Watts).}$$

4.1.2 Test Instruments

DESCRIPTION & MANUFACTURER	MODEL NO.	SERIAL NO.	CALIBRATED DATE	CALIBRATED UNTIL
Test Receiver Agilent	N9038A	MY50010156	July 12, 2017	July 11, 2018
Pre-Amplifier ^(*) EMCI	EMC001340	980142	Jan. 20, 2016	Jan. 19, 2018
Loop Antenna ^(*) Electro-Metrics	EM-6879	264	Dec. 16, 2016	Dec. 15, 2018
RF Cable	NA	LOOPCAB-001 LOOPCAB-002	Jan. 17, 2017	Jan. 16, 2018
Pre-Amplifier Mini-Circuits	ZFL-1000VH2B	AMP-ZFL-05	May 06, 2017	May 05, 2018
Trilog Broadband Antenna SCHWARZBECK	VULB 9168	9168-361	Dec. 29, 2016	Dec. 28, 2017
RF Cable	8D	966-3-1 966-3-2 966-3-3	Apr. 01, 2017	Mar. 31, 2018
Fixed attenuator Mini-Circuits	UNAT-5+	PAD-3m-3-01	Oct. 05, 2016	Oct. 04, 2017
Horn_Antenna SCHWARZBECK	BBHA9120-D	9120D-406	Dec. 28, 2016	Dec. 27, 2017
Pre-Amplifier EMCI	EMC12630SE	980384	Feb. 02, 2017	Feb. 01, 2018
RF Cable	EMC104-SM-SM-1200 EMC104-SM-SM-2000 EMC104-SM-SM-5000	160922 150317 150322	Feb. 02, 2017 Mar. 29, 2017 Mar. 29, 2017	Feb. 01, 2018 Mar. 28, 2018 Mar. 28, 2018
Spectrum Analyzer Keysight	N9030A	MY54490679	July 25, 2017	July 24, 2018
Pre-Amplifier EMCI	EMC184045SE	980386	Feb. 02, 2017	Feb. 01, 2018
Horn_Antenna SCHWARZBECK	BBHA 9170	BBHA9170608	Dec. 15, 2016	Dec. 14, 2017
RF Cable	SUCOFLEX 102	36432/2 36433/2	Jan. 15, 2017	Jan. 14, 2018
Software	ADT_Radiated_V8.7.08	NA	NA	NA
Antenna Tower & Turn Table Max-Full	MF-7802	MF780208406	NA	NA
Boresight Antenna Fixture	FBA-01	FBA-SIP01	NA	NA
Spectrum Analyzer R&S	FSv40	100964	July 01, 2017	June 30, 2018
Power meter Anritsu	ML2495A	0824006	June 26, 2017	June 25, 2018
Power sensor Anritsu	MA2411B	0738172	June 26, 2017	June 25, 2018
Temperature & Humidity Chamber Giant Force	GTH-150-40-SP-AR	MAA0812-008	Jan. 11, 2017	Jan. 10, 2018
DC Power Supply Topward	6603D	795558	NA	NA
Digital Multimeter FLUKE	87III	73680266	Nov. 10, 2016	Nov. 09, 2017

Note:

1. The calibration interval of the above test instruments is 12 months and the calibrations are traceable to NML/ROC and NIST/USA.
2. *The calibration interval of the above test instruments is 24 months and the calibrations are traceable to NML/ROC and NIST/USA.
3. The test was performed in 966 Chamber No. 3.
4. Loop antenna was used for all emissions below 30 MHz.
- 5 The CANADA Site Registration No. is 20331-1
6. Tested Date: Oct. 02, 2017

4.1.3 Test Procedure

For Radiated emission below 30MHz

- a. The EUT was placed on the top of a rotating table 0.8 meters above the ground at a 3 meter chamber room. The table was rotated 360 degrees to determine the position of the highest radiation.
- b. The EUT was set 3 meters away from the interference-receiving antenna, which was mounted on the top of a variable-height antenna tower.
- c. Both X and Y axes of the antenna are set to make the measurement.
- d. For each suspected emission, the EUT was arranged to its worst case and the rotatable table was turned from 0 degrees to 360 degrees to find the maximum reading.
- e. The test-receiver system was set to Quasi-Peak Detect Function and Specified Bandwidth with Maximum Hold Mode.

NOTE:

1. The resolution bandwidth and video bandwidth of test receiver/spectrum analyzer is 9kHz at frequency below 30MHz.

For Radiated emission above 30MHz

- a. The EUT was placed on the top of a rotating table 0.8 meters (for 30MHz ~ 1GHz) / 1.5 meters (for above 1GHz) above the ground at 3 meter chamber room for test. The table was rotated 360 degrees to determine the position of the highest radiation.
- b. The EUT was set 3 meters away from the interference-receiving antenna, which was mounted on the top of a variable-height antenna tower.
- c. The height of antenna is varied from one meter to four meters above the ground to determine the maximum value of the field strength. Both horizontal and vertical polarizations of the antenna are set to make the measurement.
- d. For each suspected emission, the EUT was arranged to its worst case and then the antenna was tuned to heights from 1 meter to 4 meters and the rotatable table was turned from 0 degrees to 360 degrees to find the maximum reading.
- e. The test-receiver system was set to quasi-peak detect function and specified bandwidth with maximum hold mode when the test frequency is below 1 GHz.
- f. The test-receiver system was set to peak and average detect function and specified bandwidth with maximum hold mode when the test frequency is above 1 GHz. If the peak reading value also meets average limit, measurement with the average detector is unnecessary.

Note:

1. The resolution bandwidth and video bandwidth of test receiver/spectrum analyzer is 120kHz for Quasi-peak detection (QP) at frequency below 1GHz.
2. The resolution bandwidth of test receiver/spectrum analyzer is 1 MHz and the video bandwidth is 3 MHz for Peak detection (PK) at frequency above 1GHz.
3. The resolution bandwidth of test receiver/spectrum analyzer is 1MHz and the video bandwidth is $\geq 1/T$ (Duty cycle < 98%) or 10Hz (Duty cycle $\geq 98\%$) for Average detection (AV) at frequency above 1GHz.
4. All modes of operation were investigated and the worst-case emissions are reported.

4.1.4 Deviation from Test Standard

No deviation.

4.1.5 Test Setup

For Radiated emission below 30MHz

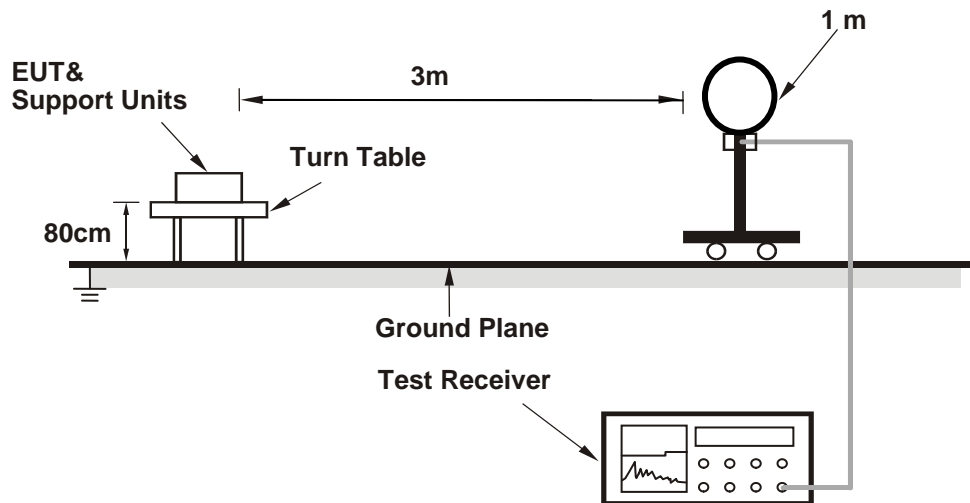

For Radiated emission 30MHz to 1GHz

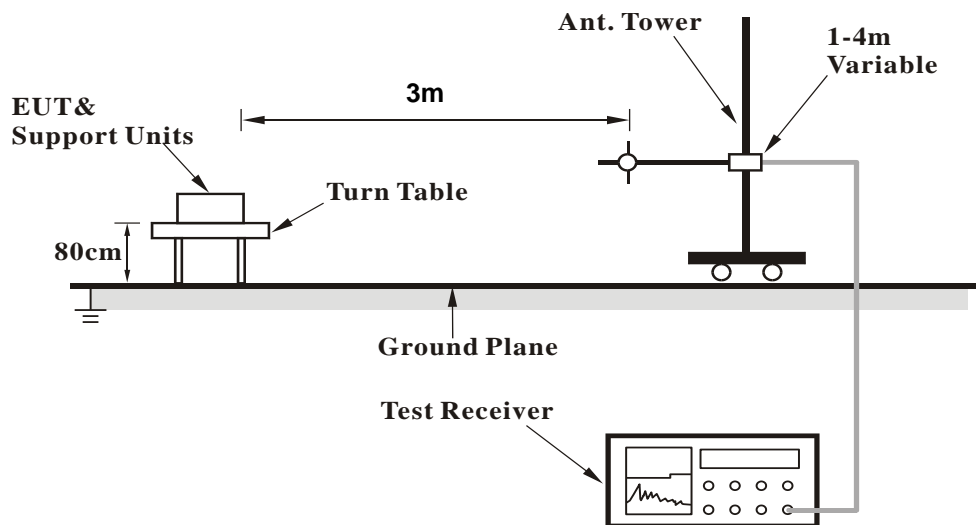

For Radiated emission above 1GHz

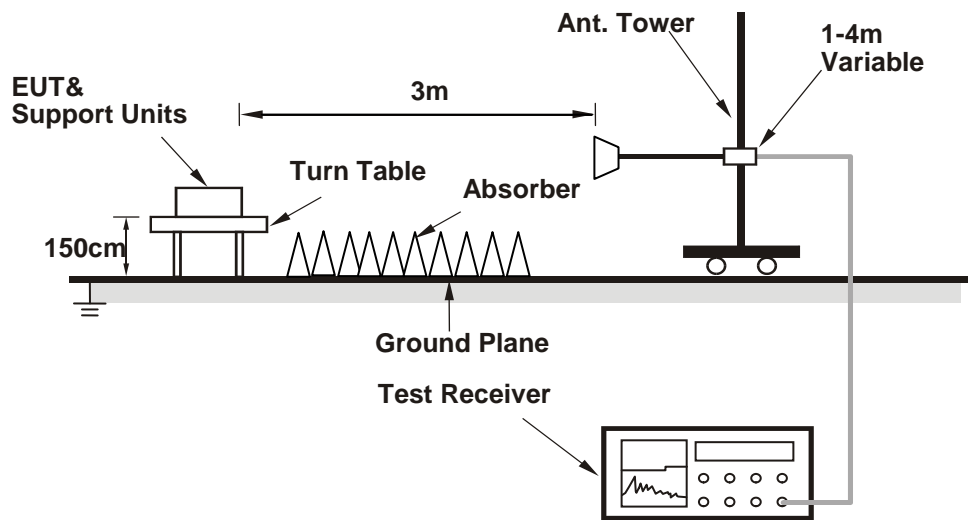

For the actual test configuration, please refer to the attached file (Test Setup Photo).

4.1.6 EUT Operating Condition

- a. Connected the EUT with the Laptop which is placed on remote site.
- b. Controlling software (MT7615 QA 0.0.1.71) has been activated to set the EUT on specific status.

4.1.7 Test Results

Above 1GHz Data:

802.11a

CHANNEL	TX Channel 36	DETECTOR FUNCTION	Peak (PK)
FREQUENCY RANGE	1GHz ~ 40GHz		Average (AV)

ANTENNA POLARITY & TEST DISTANCE: HORIZONTAL AT 3 M								
NO.	FREQ. (MHz)	EMISSION LEVEL (dBuV/m)	LIMIT (dBuV/m)	MARGIN (dB)	ANTENNA HEIGHT (m)	TABLE ANGLE (Degree)	RAW VALUE (dBuV)	CORRECTION FACTOR (dB/m)
1	5150.00	65.2 PK	74.0	-8.8	2.48 H	328	61.5	3.7
2	5150.00	53.0 AV	54.0	-1.0	2.48 H	328	49.3	3.7
3	*5180.00	114.2 PK			2.48 H	328	110.5	3.7
4	*5180.00	106.4 AV			2.48 H	328	102.7	3.7
5	#10360.00	60.4 PK	74.0	-13.6	2.76 H	233	47.4	13.0
6	#10360.00	49.1 AV	54.0	-4.9	2.76 H	233	36.1	13.0
7	15540.00	64.2 PK	74.0	-9.8	1.82 H	50	51.1	13.1
8	15540.00	50.5 AV	54.0	-3.5	1.82 H	50	37.4	13.1
ANTENNA POLARITY & TEST DISTANCE: VERTICAL AT 3 M								
NO.	FREQ. (MHz)	EMISSION LEVEL (dBuV/m)	LIMIT (dBuV/m)	MARGIN (dB)	ANTENNA HEIGHT (m)	TABLE ANGLE (Degree)	RAW VALUE (dBuV)	CORRECTION FACTOR (dB/m)
1	5150.00	66.8 PK	74.0	-7.2	1.01 V	128	63.1	3.7
2	5150.00	53.4 AV	54.0	-0.6	1.01 V	128	49.7	3.7
3	*5180.00	114.6 PK			1.01 V	128	110.9	3.7
4	*5180.00	106.8 AV			1.01 V	128	103.1	3.7
5	#10360.00	59.3 PK	74.0	-14.7	1.10 V	234	46.3	13.0
6	#10360.00	48.2 AV	54.0	-5.8	1.10 V	234	35.2	13.0
7	15540.00	56.2 PK	74.0	-17.8	2.64 V	30	43.1	13.1
8	15540.00	46.2 AV	54.0	-7.8	2.64 V	30	33.1	13.1

REMARKS:

1. Emission Level(dBuV/m) = Raw Value(dBuV) + Correction Factor(dB/m)
2. Correction Factor(dB/m) = Antenna Factor(dB/m) + Cable Factor(dB) – Pre-Amplifier Factor(dB)
3. The other emission levels were very low against the limit.
4. Margin value = Emission Level – Limit value
5. " * ": Fundamental frequency.
6. " # ": The radiated frequency is out of the restricted band.

CHANNEL	TX Channel 40	DETECTOR FUNCTION	Peak (PK)
FREQUENCY RANGE	1GHz ~ 40GHz		Average (AV)

ANTENNA POLARITY & TEST DISTANCE: HORIZONTAL AT 3 M

NO.	FREQ. (MHz)	EMISSION LEVEL (dBuV/m)	LIMIT (dBuV/m)	MARGIN (dB)	ANTENNA HEIGHT (m)	TABLE ANGLE (Degree)	RAW VALUE (dBuV)	CORRECTION FACTOR (dB/m)
1	5150.00	65.1 PK	74.0	-8.9	2.54 H	317	61.4	3.7
2	5150.00	53.0 AV	54.0	-1.0	2.54 H	317	49.3	3.7
3	*5200.00	114.2 PK			2.54 H	317	110.5	3.7
4	*5200.00	106.4 AV			2.54 H	317	102.7	3.7
5	5350.00	61.7 PK	74.0	-12.3	2.54 H	317	57.6	4.1
6	5350.00	50.3 AV	54.0	-3.7	2.54 H	317	46.2	4.1
7	#10400.00	60.8 PK	74.0	-13.2	2.76 H	244	47.8	13.0
8	#10400.00	49.5 AV	54.0	-4.5	2.76 H	244	36.5	13.0
9	15600.00	64.1 PK	74.0	-9.9	1.86 H	58	50.8	13.3
10	15600.00	50.5 AV	54.0	-3.5	1.86 H	58	37.2	13.3

ANTENNA POLARITY & TEST DISTANCE: VERTICAL AT 3 M

NO.	FREQ. (MHz)	EMISSION LEVEL (dBuV/m)	LIMIT (dBuV/m)	MARGIN (dB)	ANTENNA HEIGHT (m)	TABLE ANGLE (Degree)	RAW VALUE (dBuV)	CORRECTION FACTOR (dB/m)
1	5150.00	66.1 PK	74.0	-7.9	1.03 V	120	62.4	3.7
2	5150.00	53.5 AV	54.0	-0.5	1.03 V	120	49.8	3.7
3	*5200.00	118.1 PK			1.03 V	120	114.4	3.7
4	*5200.00	107.9 AV			1.03 V	120	104.2	3.7
5	5350.00	62.1 PK	74.0	-11.9	1.03 V	120	58.0	4.1
6	5350.00	50.9 AV	54.0	-3.1	1.03 V	120	46.8	4.1
7	#10400.00	58.4 PK	74.0	-15.6	1.17 V	233	45.4	13.0
8	#10400.00	45.4 AV	54.0	-8.6	1.17 V	233	32.4	13.0
9	15600.00	63.5 PK	74.0	-10.5	2.60 V	22	50.2	13.3
10	15600.00	50.3 AV	54.0	-3.7	2.60 V	22	37.0	13.3

REMARKS:

- Emission Level(dBuV/m) = Raw Value(dBuV) + Correction Factor(dB/m)
- Correction Factor(dB/m) = Antenna Factor(dB/m) + Cable Factor(dB) – Pre-Amplifier Factor(dB)
- The other emission levels were very low against the limit.
- Margin value = Emission Level – Limit value
- " * ": Fundamental frequency.
- " # ": The radiated frequency is out of the restricted band.

CHANNEL	TX Channel 48	DETECTOR FUNCTION	Peak (PK)
FREQUENCY RANGE	1GHz ~ 40GHz		Average (AV)

ANTENNA POLARITY & TEST DISTANCE: HORIZONTAL AT 3 M

NO.	FREQ. (MHz)	EMISSION LEVEL (dBuV/m)	LIMIT (dBuV/m)	MARGIN (dB)	ANTENNA HEIGHT (m)	TABLE ANGLE (Degree)	RAW VALUE (dBuV)	CORRECTION FACTOR (dB/m)
1	*5240.00	118.4 PK			2.51 H	323	114.6	3.8
2	*5240.00	109.2 AV			2.51 H	323	105.4	3.8
3	5350.00	64.6 PK	74.0	-9.4	2.51 H	323	60.5	4.1
4	5350.00	52.5 AV	54.0	-1.5	2.51 H	323	48.4	4.1
5	#10480.00	60.1 PK	74.0	-13.9	2.73 H	224	46.9	13.2
6	#10480.00	49.0 AV	54.0	-5.0	2.73 H	224	35.8	13.2
7	15720.00	64.0 PK	74.0	-10.0	1.80 H	41	50.4	13.6
8	15720.00	50.3 AV	54.0	-3.7	1.80 H	41	36.7	13.6

ANTENNA POLARITY & TEST DISTANCE: VERTICAL AT 3 M

NO.	FREQ. (MHz)	EMISSION LEVEL (dBuV/m)	LIMIT (dBuV/m)	MARGIN (dB)	ANTENNA HEIGHT (m)	TABLE ANGLE (Degree)	RAW VALUE (dBuV)	CORRECTION FACTOR (dB/m)
1	*5240.00	119.7 PK			1.03 V	116	115.9	3.8
2	*5240.00	110.0 AV			1.03 V	116	106.2	3.8
3	5350.00	65.9 PK	74.0	-8.1	1.03 V	116	61.8	4.1
4	5350.00	53.2 AV	54.0	-0.8	1.03 V	116	49.1	4.1
5	#10480.00	58.6 PK	74.0	-15.4	1.15 V	244	45.4	13.2
6	#10480.00	45.4 AV	54.0	-8.6	1.15 V	244	32.2	13.2
7	15720.00	63.5 PK	74.0	-10.5	2.66 V	23	49.9	13.6
8	15720.00	50.0 AV	54.0	-4.0	2.66 V	23	36.4	13.6

REMARKS:

1. Emission Level(dBuV/m) = Raw Value(dBuV) + Correction Factor(dB/m)
2. Correction Factor(dB/m) = Antenna Factor(dB/m) + Cable Factor(dB) – Pre-Amplifier Factor(dB)
3. The other emission levels were very low against the limit.
4. Margin value = Emission Level – Limit value
5. " * ": Fundamental frequency.
6. " # ": The radiated frequency is out of the restricted band.

CHANNEL	TX Channel 149	DETECTOR FUNCTION	Peak (PK)
FREQUENCY RANGE	1GHz ~ 40GHz		Average (AV)

ANTENNA POLARITY & TEST DISTANCE: HORIZONTAL AT 3 M

NO.	FREQ. (MHz)	EMISSION LEVEL (dBuV/m)	LIMIT (dBuV/m)	MARGIN (dB)	ANTENNA HEIGHT (m)	TABLE ANGLE (Degree)	RAW VALUE (dBuV)	CORRECTION FACTOR (dB/m)
1	*5745.00	116.9 PK			2.51 H	10	112.5	4.4
2	*5745.00	105.5 AV			2.51 H	10	101.1	4.4
3	11490.00	67.3 PK	74.0	-6.7	1.86 H	100	53.8	13.5
4	11490.00	51.1 AV	54.0	-2.9	1.86 H	100	37.6	13.5
5	#17235.00	69.1 PK	74.0	-4.9	2.13 H	30	51.8	17.3
6	#17235.00	53.4 AV	54.0	-0.6	2.13 H	30	36.1	17.3

ANTENNA POLARITY & TEST DISTANCE: VERTICAL AT 3 M

NO.	FREQ. (MHz)	EMISSION LEVEL (dBuV/m)	LIMIT (dBuV/m)	MARGIN (dB)	ANTENNA HEIGHT (m)	TABLE ANGLE (Degree)	RAW VALUE (dBuV)	CORRECTION FACTOR (dB/m)
1	*5745.00	115.5 PK			2.25 V	159	111.1	4.4
2	*5745.00	106.5 AV			2.25 V	159	102.1	4.4
3	11490.00	65.4 PK	74.0	-8.6	1.00 V	21	51.9	13.5
4	11490.00	49.5 AV	54.0	-4.5	1.00 V	21	36.0	13.5
5	#17235.00	67.4 PK	74.0	-6.6	3.99 V	345	50.1	17.3
6	#17235.00	51.6 AV	54.0	-2.4	3.99 V	345	34.3	17.3

REMARKS:

1. Emission Level(dBuV/m) = Raw Value(dBuV) + Correction Factor(dB/m)
2. Correction Factor(dB/m) = Antenna Factor(dB/m) + Cable Factor(dB) – Pre-Amplifier Factor(dB)
3. The other emission levels were very low against the limit.
4. Margin value = Emission Level – Limit value
5. " * ": Fundamental frequency.
6. " # ": The radiated frequency is out of the restricted band.

CHANNEL	TX Channel 157	DETECTOR FUNCTION	Peak (PK)
FREQUENCY RANGE	1GHz ~ 40GHz		Average (AV)

ANTENNA POLARITY & TEST DISTANCE: HORIZONTAL AT 3 M

NO.	FREQ. (MHz)	EMISSION LEVEL (dBuV/m)	LIMIT (dBuV/m)	MARGIN (dB)	ANTENNA HEIGHT (m)	TABLE ANGLE (Degree)	RAW VALUE (dBuV)	CORRECTION FACTOR (dB/m)
1	*5785.00	117.2 PK			2.48 H	4	112.8	4.4
2	*5785.00	105.9 AV			2.48 H	4	101.5	4.4
3	11570.00	67.8 PK	74.0	-6.2	1.95 H	96	54.3	13.5
4	11570.00	51.5 AV	54.0	-2.5	1.95 H	96	38.0	13.5
5	#17355.00	69.9 PK	74.0	-4.1	2.14 H	33	51.9	18.0
6	#17355.00	53.4 AV	54.0	-0.6	2.14 H	33	35.4	18.0

ANTENNA POLARITY & TEST DISTANCE: VERTICAL AT 3 M

NO.	FREQ. (MHz)	EMISSION LEVEL (dBuV/m)	LIMIT (dBuV/m)	MARGIN (dB)	ANTENNA HEIGHT (m)	TABLE ANGLE (Degree)	RAW VALUE (dBuV)	CORRECTION FACTOR (dB/m)
1	*5785.00	118.5 PK			2.16 V	121	114.1	4.4
2	*5785.00	107.1 AV			2.16 V	121	102.7	4.4
3	11570.00	59.2 PK	74.0	-14.8	1.17 V	238	45.7	13.5
4	11570.00	45.7 AV	54.0	-8.3	1.17 V	238	32.2	13.5
5	#17355.00	63.7 PK	74.0	-10.3	2.70 V	37	45.7	18.0
6	#17355.00	50.0 AV	54.0	-4.0	2.70 V	37	32.0	18.0

REMARKS:

1. Emission Level(dBuV/m) = Raw Value(dBuV) + Correction Factor(dB/m)
2. Correction Factor(dB/m) = Antenna Factor(dB/m) + Cable Factor(dB) – Pre-Amplifier Factor(dB)
3. The other emission levels were very low against the limit.
4. Margin value = Emission Level – Limit value
5. " * ": Fundamental frequency.
6. " # ": The radiated frequency is out of the restricted band.

CHANNEL	TX Channel 165	DETECTOR FUNCTION	Peak (PK)
FREQUENCY RANGE	1GHz ~ 40GHz		Average (AV)

ANTENNA POLARITY & TEST DISTANCE: HORIZONTAL AT 3 M

NO.	FREQ. (MHz)	EMISSION LEVEL (dBuV/m)	LIMIT (dBuV/m)	MARGIN (dB)	ANTENNA HEIGHT (m)	TABLE ANGLE (Degree)	RAW VALUE (dBuV)	CORRECTION FACTOR (dB/m)
1	*5825.00	115.6 PK			2.57 H	6	111.2	4.4
2	*5825.00	106.6 AV			2.57 H	6	102.2	4.4
3	11650.00	67.4 PK	74.0	-6.6	1.80 H	86	53.7	13.7
4	11650.00	51.2 AV	54.0	-2.8	1.80 H	86	37.5	13.7
5	#17475.00	68.9 PK	74.0	-5.1	2.17 H	34	50.3	18.6
6	#17475.00	53.4 AV	54.0	-0.6	2.17 H	34	34.8	18.6

ANTENNA POLARITY & TEST DISTANCE: VERTICAL AT 3 M

NO.	FREQ. (MHz)	EMISSION LEVEL (dBuV/m)	LIMIT (dBuV/m)	MARGIN (dB)	ANTENNA HEIGHT (m)	TABLE ANGLE (Degree)	RAW VALUE (dBuV)	CORRECTION FACTOR (dB/m)
1	*5825.00	115.1 PK			2.38 V	145	110.7	4.4
2	*5825.00	105.6 AV			2.38 V	145	101.2	4.4
3	11650.00	59.1 PK	74.0	-14.9	1.09 V	244	45.4	13.7
4	11650.00	45.7 AV	54.0	-8.3	1.09 V	244	32.0	13.7
5	#17475.00	63.2 PK	74.0	-10.8	2.60 V	25	44.6	18.6
6	#17475.00	49.7 AV	54.0	-4.3	2.60 V	25	31.1	18.6

REMARKS:

1. Emission Level(dBuV/m) = Raw Value(dBuV) + Correction Factor(dB/m)
2. Correction Factor(dB/m) = Antenna Factor(dB/m) + Cable Factor(dB) – Pre-Amplifier Factor(dB)
3. The other emission levels were very low against the limit.
4. Margin value = Emission Level – Limit value
5. " * ": Fundamental frequency.
6. " # ": The radiated frequency is out of the restricted band.

802.11ac (VHT20)

CHANNEL	TX Channel 36	DETECTOR FUNCTION	Peak (PK)
FREQUENCY RANGE	1GHz ~ 40GHz		Average (AV)

ANTENNA POLARITY & TEST DISTANCE: HORIZONTAL AT 3 M

NO.	FREQ. (MHz)	EMISSION LEVEL (dBuV/m)	LIMIT (dBuV/m)	MARGIN (dB)	ANTENNA HEIGHT (m)	TABLE ANGLE (Degree)	RAW VALUE (dBuV)	CORRECTION FACTOR (dB/m)
1	5150.00	64.9 PK	74.0	-9.1	2.51 H	319	61.2	3.7
2	5150.00	52.6 AV	54.0	-1.4	2.51 H	319	48.9	3.7
3	*5180.00	114.4 PK			2.43 H	341	110.7	3.7
4	*5180.00	106.7 AV			2.43 H	341	103.0	3.7
5	#10360.00	60.5 PK	74.0	-13.5	2.70 H	226	47.5	13.0
6	#10360.00	49.4 AV	54.0	-4.6	2.70 H	226	36.4	13.0
7	15540.00	64.6 PK	74.0	-9.4	1.88 H	39	51.5	13.1
8	15540.00	50.8 AV	54.0	-3.2	1.88 H	39	37.7	13.1

ANTENNA POLARITY & TEST DISTANCE: VERTICAL AT 3 M

NO.	FREQ. (MHz)	EMISSION LEVEL (dBuV/m)	LIMIT (dBuV/m)	MARGIN (dB)	ANTENNA HEIGHT (m)	TABLE ANGLE (Degree)	RAW VALUE (dBuV)	CORRECTION FACTOR (dB/m)
1	5150.00	64.9 PK	74.0	-9.1	1.00 V	113	61.2	3.7
2	5150.00	53.5 AV	54.0	-0.5	1.00 V	113	49.8	3.7
3	*5180.00	116.1 PK			1.00 V	113	112.4	3.7
4	*5180.00	106.2 AV			1.00 V	113	102.5	3.7
5	#10360.00	59.0 PK	74.0	-15.0	1.02 V	241	46.0	13.0
6	#10360.00	47.8 AV	54.0	-6.2	1.02 V	241	34.8	13.0
7	15540.00	56.0 PK	74.0	-18.0	2.60 V	20	42.9	13.1
8	15540.00	46.0 AV	54.0	-8.0	2.60 V	20	32.9	13.1

REMARKS:

- Emission Level(dBuV/m) = Raw Value(dBuV) + Correction Factor(dB/m)
- Correction Factor(dB/m) = Antenna Factor(dB/m) + Cable Factor(dB) – Pre-Amplifier Factor(dB)
- The other emission levels were very low against the limit.
- Margin value = Emission Level – Limit value
- " * ": Fundamental frequency.
- " # ": The radiated frequency is out of the restricted band.

CHANNEL	TX Channel 40	DETECTOR FUNCTION	Peak (PK)
FREQUENCY RANGE	1GHz ~ 40GHz		Average (AV)

ANTENNA POLARITY & TEST DISTANCE: HORIZONTAL AT 3 M

NO.	FREQ. (MHz)	EMISSION LEVEL (dBuV/m)	LIMIT (dBuV/m)	MARGIN (dB)	ANTENNA HEIGHT (m)	TABLE ANGLE (Degree)	RAW VALUE (dBuV)	CORRECTION FACTOR (dB/m)
1	5150.00	64.7 PK	74.0	-9.3	2.50 H	338	61.0	3.7
2	5150.00	52.7 AV	54.0	-1.3	2.50 H	338	49.0	3.7
3	*5200.00	114.4 PK			2.50 H	338	110.7	3.7
4	*5200.00	106.5 AV			2.50 H	338	102.8	3.7
5	5350.00	64.2 PK	74.0	-9.8	2.50 H	338	60.1	4.1
6	5350.00	50.7 AV	54.0	-3.3	2.50 H	338	46.6	4.1
7	#10400.00	60.8 PK	74.0	-13.2	2.74 H	236	47.8	13.0
8	#10400.00	49.5 AV	54.0	-4.5	2.74 H	236	36.5	13.0
9	15600.00	64.8 PK	74.0	-9.2	1.85 H	45	51.5	13.3
10	15600.00	50.9 AV	54.0	-3.1	1.85 H	45	37.6	13.3

ANTENNA POLARITY & TEST DISTANCE: VERTICAL AT 3 M

NO.	FREQ. (MHz)	EMISSION LEVEL (dBuV/m)	LIMIT (dBuV/m)	MARGIN (dB)	ANTENNA HEIGHT (m)	TABLE ANGLE (Degree)	RAW VALUE (dBuV)	CORRECTION FACTOR (dB/m)
1	5150.00	65.5 PK	74.0	-8.5	1.03 V	117	61.8	3.7
2	5150.00	53.5 AV	54.0	-0.5	1.03 V	117	49.8	3.7
3	*5200.00	119.3 PK			1.03 V	117	115.6	3.7
4	*5200.00	108.9 AV			1.03 V	117	105.2	3.7
5	5350.00	60.9 PK	74.0	-13.1	1.03 V	117	56.8	4.1
6	5350.00	51.2 AV	54.0	-2.8	1.03 V	117	47.1	4.1
7	#10400.00	58.6 PK	74.0	-15.4	1.14 V	242	45.6	13.0
8	#10400.00	45.5 AV	54.0	-8.5	1.14 V	242	32.5	13.0
9	15600.00	63.7 PK	74.0	-10.3	2.64 V	30	50.4	13.3
10	15600.00	50.6 AV	54.0	-3.4	2.64 V	30	37.3	13.3

REMARKS:

- Emission Level(dBuV/m) = Raw Value(dBuV) + Correction Factor(dB/m)
- Correction Factor(dB/m) = Antenna Factor(dB/m) + Cable Factor(dB) – Pre-Amplifier Factor(dB)
- The other emission levels were very low against the limit.
- Margin value = Emission Level – Limit value
- " * ": Fundamental frequency.
- " # ": The radiated frequency is out of the restricted band.

CHANNEL	TX Channel 48	DETECTOR FUNCTION	Peak (PK)
FREQUENCY RANGE	1GHz ~ 40GHz		Average (AV)

ANTENNA POLARITY & TEST DISTANCE: HORIZONTAL AT 3 M

NO.	FREQ. (MHz)	EMISSION LEVEL (dBuV/m)	LIMIT (dBuV/m)	MARGIN (dB)	ANTENNA HEIGHT (m)	TABLE ANGLE (Degree)	RAW VALUE (dBuV)	CORRECTION FACTOR (dB/m)
1	5150.00	64.5 PK	74.0	-9.5	2.55 H	329	60.8	3.7
2	5150.00	52.5 AV	54.0	-1.5	2.55 H	329	48.8	3.7
3	*5240.00	114.6 PK			2.55 H	329	110.8	3.8
4	*5240.00	106.6 AV			2.55 H	329	102.8	3.8
5	5350.00	64.3 PK	74.0	-9.7	2.55 H	329	60.2	4.1
6	5350.00	51.1 AV	54.0	-2.9	2.55 H	329	47.0	4.1
7	#10480.00	60.6 PK	74.0	-13.4	2.80 H	244	47.4	13.2
8	#10480.00	49.3 AV	54.0	-4.7	2.80 H	244	36.1	13.2
9	15720.00	64.8 PK	74.0	-9.2	1.82 H	45	51.2	13.6
10	15720.00	52.6 AV	54.0	-1.4	1.82 H	45	39.0	13.6

ANTENNA POLARITY & TEST DISTANCE: VERTICAL AT 3 M

NO.	FREQ. (MHz)	EMISSION LEVEL (dBuV/m)	LIMIT (dBuV/m)	MARGIN (dB)	ANTENNA HEIGHT (m)	TABLE ANGLE (Degree)	RAW VALUE (dBuV)	CORRECTION FACTOR (dB/m)
1	5150.00	66.5 PK	74.0	-7.5	1.23 V	129	62.8	3.7
2	5150.00	53.3 AV	54.0	-0.7	1.23 V	129	49.6	3.7
3	*5240.00	119.5 PK			1.23 V	129	115.7	3.8
4	*5240.00	109.4 AV			1.23 V	129	105.6	3.8
5	5350.00	63.9 PK	74.0	-10.1	1.23 V	129	59.8	4.1
6	5350.00	51.1 AV	54.0	-2.9	1.23 V	129	47.0	4.1
7	#10480.00	58.2 PK	74.0	-15.8	1.18 V	224	45.0	13.2
8	#10480.00	45.5 AV	54.0	-8.5	1.18 V	224	32.3	13.2
9	15720.00	63.3 PK	74.0	-10.7	2.61 V	21	49.7	13.6
10	15720.00	50.2 AV	54.0	-3.8	2.61 V	21	36.6	13.6

REMARKS:

1. Emission Level(dBuV/m) = Raw Value(dBuV) + Correction Factor(dB/m)
2. Correction Factor(dB/m) = Antenna Factor(dB/m) + Cable Factor(dB) – Pre-Amplifier Factor(dB)
3. The other emission levels were very low against the limit.
4. Margin value = Emission Level – Limit value
5. " * ": Fundamental frequency.
6. " # ": The radiated frequency is out of the restricted band.

CHANNEL	TX Channel 149	DETECTOR FUNCTION	Peak (PK)
FREQUENCY RANGE	1GHz ~ 40GHz		Average (AV)

ANTENNA POLARITY & TEST DISTANCE: HORIZONTAL AT 3 M

NO.	FREQ. (MHz)	EMISSION LEVEL (dBuV/m)	LIMIT (dBuV/m)	MARGIN (dB)	ANTENNA HEIGHT (m)	TABLE ANGLE (Degree)	RAW VALUE (dBuV)	CORRECTION FACTOR (dB/m)
1	*5745.00	115.6 PK			1.76 H	12	111.2	4.4
2	*5745.00	105.4 AV			1.76 H	12	101.0	4.4
3	11490.00	70.0 PK	74.0	-4.0	1.00 H	57	56.5	13.5
4	11490.00	53.4 AV	54.0	-0.6	1.00 H	57	39.9	13.5
5	#17235.00	64.1 PK	74.0	-9.9	1.69 H	105	46.8	17.3
6	#17235.00	52.1 AV	54.0	-1.9	1.69 H	105	34.8	17.3

ANTENNA POLARITY & TEST DISTANCE: VERTICAL AT 3 M

NO.	FREQ. (MHz)	EMISSION LEVEL (dBuV/m)	LIMIT (dBuV/m)	MARGIN (dB)	ANTENNA HEIGHT (m)	TABLE ANGLE (Degree)	RAW VALUE (dBuV)	CORRECTION FACTOR (dB/m)
1	*5745.00	116.9 PK			1.42 V	150	112.5	4.4
2	*5745.00	106.6 AV			1.42 V	150	102.2	4.4
3	11490.00	68.1 PK	74.0	-5.9	1.13 V	25	54.6	13.5
4	11490.00	51.8 AV	54.0	-2.2	1.13 V	25	38.3	13.5
5	#17235.00	62.2 PK	74.0	-11.8	1.79 V	52	44.9	17.3
6	#17235.00	50.5 AV	54.0	-3.5	1.79 V	52	33.2	17.3

REMARKS:

1. Emission Level(dBuV/m) = Raw Value(dBuV) + Correction Factor(dB/m)
2. Correction Factor(dB/m) = Antenna Factor(dB/m) + Cable Factor(dB) – Pre-Amplifier Factor(dB)
3. The other emission levels were very low against the limit.
4. Margin value = Emission Level – Limit value
5. " * ": Fundamental frequency.
6. " # ": The radiated frequency is out of the restricted band.

CHANNEL	TX Channel 157	DETECTOR FUNCTION	Peak (PK)
FREQUENCY RANGE	1GHz ~ 40GHz		Average (AV)

ANTENNA POLARITY & TEST DISTANCE: HORIZONTAL AT 3 M

NO.	FREQ. (MHz)	EMISSION LEVEL (dBuV/m)	LIMIT (dBuV/m)	MARGIN (dB)	ANTENNA HEIGHT (m)	TABLE ANGLE (Degree)	RAW VALUE (dBuV)	CORRECTION FACTOR (dB/m)
1	*5785.00	115.3 PK			1.81 H	24	110.9	4.4
2	*5785.00	105.3 AV			1.81 H	24	100.9	4.4
3	11570.00	67.1 PK	74.0	-6.9	1.01 H	56	53.6	13.5
4	11570.00	53.3 AV	54.0	-0.7	1.01 H	56	39.8	13.5
5	#17355.00	62.8 PK	74.0	-11.2	1.50 H	163	44.8	18.0
6	#17355.00	50.0 AV	54.0	-4.0	1.50 H	163	32.0	18.0

ANTENNA POLARITY & TEST DISTANCE: VERTICAL AT 3 M

NO.	FREQ. (MHz)	EMISSION LEVEL (dBuV/m)	LIMIT (dBuV/m)	MARGIN (dB)	ANTENNA HEIGHT (m)	TABLE ANGLE (Degree)	RAW VALUE (dBuV)	CORRECTION FACTOR (dB/m)
1	*5785.00	116.4 PK			1.55 V	166	112.0	4.4
2	*5785.00	106.4 AV			1.55 V	166	102.0	4.4
3	11570.00	68.4 PK	74.0	-5.6	1.08 V	21	54.9	13.5
4	11570.00	51.9 AV	54.0	-2.1	1.08 V	21	38.4	13.5
5	#17355.00	62.5 PK	74.0	-11.5	1.77 V	61	44.5	18.0
6	#17355.00	50.6 AV	54.0	-3.4	1.77 V	61	32.6	18.0

REMARKS:

1. Emission Level(dBuV/m) = Raw Value(dBuV) + Correction Factor(dB/m)
2. Correction Factor(dB/m) = Antenna Factor(dB/m) + Cable Factor(dB) – Pre-Amplifier Factor(dB)
3. The other emission levels were very low against the limit.
4. Margin value = Emission Level – Limit value
5. " * ": Fundamental frequency.
6. " # ": The radiated frequency is out of the restricted band.

CHANNEL	TX Channel 165	DETECTOR FUNCTION	Peak (PK)
FREQUENCY RANGE	1GHz ~ 40GHz		Average (AV)

ANTENNA POLARITY & TEST DISTANCE: HORIZONTAL AT 3 M

NO.	FREQ. (MHz)	EMISSION LEVEL (dBuV/m)	LIMIT (dBuV/m)	MARGIN (dB)	ANTENNA HEIGHT (m)	TABLE ANGLE (Degree)	RAW VALUE (dBuV)	CORRECTION FACTOR (dB/m)
1	*5825.00	114.4 PK			1.79 H	13	110.0	4.4
2	*5825.00	104.5 AV			1.79 H	13	100.1	4.4
3	11650.00	69.9 PK	74.0	-4.1	1.51 H	90	56.2	13.7
4	11650.00	53.0 AV	54.0	-1.0	1.51 H	90	39.3	13.7
5	#17475.00	64.1 PK	74.0	-9.9	1.65 H	185	45.5	18.6
6	#17475.00	50.0 AV	54.0	-4.0	1.65 H	185	31.4	18.6

ANTENNA POLARITY & TEST DISTANCE: VERTICAL AT 3 M

NO.	FREQ. (MHz)	EMISSION LEVEL (dBuV/m)	LIMIT (dBuV/m)	MARGIN (dB)	ANTENNA HEIGHT (m)	TABLE ANGLE (Degree)	RAW VALUE (dBuV)	CORRECTION FACTOR (dB/m)
1	*5825.00	115.7 PK			1.65 V	170	111.3	4.4
2	*5825.00	105.8 AV			1.65 V	170	101.4	4.4
3	11650.00	68.0 PK	74.0	-6.0	1.12 V	25	54.3	13.7
4	11650.00	51.4 AV	54.0	-2.6	1.12 V	25	37.7	13.7
5	#17475.00	62.6 PK	74.0	-11.4	1.77 V	49	44.0	18.6
6	#17475.00	50.8 AV	54.0	-3.2	1.77 V	49	32.2	18.6

REMARKS:

1. Emission Level(dBuV/m) = Raw Value(dBuV) + Correction Factor(dB/m)
2. Correction Factor(dB/m) = Antenna Factor(dB/m) + Cable Factor(dB) – Pre-Amplifier Factor(dB)
3. The other emission levels were very low against the limit.
4. Margin value = Emission Level – Limit value
5. " * ": Fundamental frequency.
6. " # ": The radiated frequency is out of the restricted band.

802.11ac (VHT40)

CHANNEL	TX Channel 38	DETECTOR FUNCTION	Peak (PK)
FREQUENCY RANGE	1GHz ~ 40GHz		Average (AV)

ANTENNA POLARITY & TEST DISTANCE: HORIZONTAL AT 3 M								
NO.	FREQ. (MHz)	EMISSION LEVEL (dBuV/m)	LIMIT (dBuV/m)	MARGIN (dB)	ANTENNA HEIGHT (m)	TABLE ANGLE (Degree)	RAW VALUE (dBuV)	CORRECTION FACTOR (dB/m)
1	5150.00	63.8 PK	74.0	-10.2	1.51 H	8	60.1	3.7
2	5150.00	51.8 AV	54.0	-2.2	1.51 H	8	48.1	3.7
3	*5190.00	114.0 PK			1.51 H	8	110.3	3.7
4	*5190.00	102.1 AV			1.51 H	8	98.4	3.7
5	5350.00	46.4 PK	74.0	-27.6	1.51 H	8	42.3	4.1
6	5350.00	45.0 AV	54.0	-9.0	1.51 H	8	40.9	4.1
7	#10380.00	60.5 PK	74.0	-13.5	2.70 H	251	47.4	13.1
8	#10380.00	49.2 AV	54.0	-4.8	2.70 H	251	36.1	13.1
9	15570.00	65.0 PK	74.0	-9.0	1.89 H	56	51.7	13.3
10	15570.00	51.1 AV	54.0	-2.9	1.89 H	56	37.8	13.3

ANTENNA POLARITY & TEST DISTANCE: VERTICAL AT 3 M								
NO.	FREQ. (MHz)	EMISSION LEVEL (dBuV/m)	LIMIT (dBuV/m)	MARGIN (dB)	ANTENNA HEIGHT (m)	TABLE ANGLE (Degree)	RAW VALUE (dBuV)	CORRECTION FACTOR (dB/m)
1	5150.00	64.8 PK	74.0	-9.2	1.16 V	136	61.1	3.7
2	5150.00	53.5 AV	54.0	-0.5	1.16 V	136	49.8	3.7
3	*5190.00	114.3 PK			1.16 V	136	110.6	3.7
4	*5190.00	102.5 AV			1.16 V	136	98.8	3.7
5	5350.00	57.6 PK	74.0	-16.4	1.16 V	136	53.5	4.1
6	5350.00	46.5 AV	54.0	-7.5	1.16 V	136	42.4	4.1
7	#10380.00	66.3 PK	74.0	-7.7	1.05 V	20	53.2	13.1
8	#10380.00	50.2 AV	54.0	-3.8	1.05 V	20	37.1	13.1
9	15570.00	62.6 PK	74.0	-11.4	1.83 V	72	49.3	13.3
10	15570.00	50.2 AV	54.0	-3.8	1.83 V	72	36.9	13.3

REMARKS:

1. Emission Level(dBuV/m) = Raw Value(dBuV) + Correction Factor(dB/m)
2. Correction Factor(dB/m) = Antenna Factor(dB/m) + Cable Factor(dB) – Pre-Amplifier Factor(dB)
3. The other emission levels were very low against the limit.
4. Margin value = Emission Level – Limit value
5. " * ": Fundamental frequency.
6. " # ": The radiated frequency is out of the restricted band.

CHANNEL	TX Channel 46	DETECTOR FUNCTION	Peak (PK)
FREQUENCY RANGE	1GHz ~ 40GHz		Average (AV)

ANTENNA POLARITY & TEST DISTANCE: HORIZONTAL AT 3 M

NO.	FREQ. (MHz)	EMISSION LEVEL (dBuV/m)	LIMIT (dBuV/m)	MARGIN (dB)	ANTENNA HEIGHT (m)	TABLE ANGLE (Degree)	RAW VALUE (dBuV)	CORRECTION FACTOR (dB/m)
1	5150.00	61.8 PK	74.0	-12.2	1.46 H	14	58.1	3.7
2	5150.00	50.8 AV	54.0	-3.2	1.46 H	14	47.1	3.7
3	*5230.00	114.0 PK			1.46 H	14	110.2	3.8
4	*5230.00	101.9 AV			1.46 H	14	98.1	3.8
5	5350.00	62.3 PK	74.0	-11.7	1.46 H	14	58.2	4.1
6	5350.00	53.3 AV	54.0	-0.7	1.46 H	14	49.2	4.1
7	#10460.00	60.2 PK	74.0	-13.8	2.72 H	260	47.1	13.1
8	#10460.00	49.2 AV	54.0	-4.8	2.72 H	260	36.1	13.1
9	15690.00	64.9 PK	74.0	-9.1	1.94 H	55	51.1	13.8
10	15690.00	51.0 AV	54.0	-3.0	1.94 H	55	37.2	13.8

ANTENNA POLARITY & TEST DISTANCE: VERTICAL AT 3 M

NO.	FREQ. (MHz)	EMISSION LEVEL (dBuV/m)	LIMIT (dBuV/m)	MARGIN (dB)	ANTENNA HEIGHT (m)	TABLE ANGLE (Degree)	RAW VALUE (dBuV)	CORRECTION FACTOR (dB/m)
1	5150.00	62.0 PK	74.0	-12.0	1.25 V	144	58.3	3.7
2	5150.00	51.6 AV	54.0	-2.4	1.25 V	144	47.9	3.7
3	*5230.00	116.8 PK			1.25 V	144	113.0	3.8
4	*5230.00	104.7 AV			1.25 V	144	100.9	3.8
5	5350.00	62.7 PK	74.0	-11.3	1.25 V	144	58.6	4.1
6	5350.00	53.4 AV	54.0	-0.6	1.25 V	144	49.3	4.1
7	#10460.00	66.3 PK	74.0	-7.7	1.10 V	11	53.2	13.1
8	#10460.00	50.0 AV	54.0	-4.0	1.10 V	11	36.9	13.1
9	15690.00	62.4 PK	74.0	-11.6	1.80 V	60	48.6	13.8
10	15690.00	49.9 AV	54.0	-4.1	1.80 V	60	36.1	13.8

REMARKS:

1. Emission Level(dBuV/m) = Raw Value(dBuV) + Correction Factor(dB/m)
2. Correction Factor(dB/m) = Antenna Factor(dB/m) + Cable Factor(dB) – Pre-Amplifier Factor(dB)
3. The other emission levels were very low against the limit.
4. Margin value = Emission Level – Limit value
5. " * ": Fundamental frequency.
6. " # ": The radiated frequency is out of the restricted band.

CHANNEL	TX Channel 151	DETECTOR FUNCTION	Peak (PK)
FREQUENCY RANGE	1GHz ~ 40GHz		Average (AV)

ANTENNA POLARITY & TEST DISTANCE: HORIZONTAL AT 3 M

NO.	FREQ. (MHz)	EMISSION LEVEL (dBuV/m)	LIMIT (dBuV/m)	MARGIN (dB)	ANTENNA HEIGHT (m)	TABLE ANGLE (Degree)	RAW VALUE (dBuV)	CORRECTION FACTOR (dB/m)
1	*5755.00	113.8 PK			2.02 H	10	109.4	4.4
2	*5755.00	102.9 AV			2.02 H	10	98.5	4.4
3	11510.00	66.8 PK	74.0	-7.2	1.02 H	67	53.2	13.6
4	11510.00	53.5 AV	54.0	-0.5	1.02 H	67	39.9	13.6
5	#17265.00	61.0 PK	74.0	-13.0	1.69 H	153	43.4	17.6
6	#17265.00	49.9 AV	54.0	-4.1	1.69 H	153	32.3	17.6

ANTENNA POLARITY & TEST DISTANCE: VERTICAL AT 3 M

NO.	FREQ. (MHz)	EMISSION LEVEL (dBuV/m)	LIMIT (dBuV/m)	MARGIN (dB)	ANTENNA HEIGHT (m)	TABLE ANGLE (Degree)	RAW VALUE (dBuV)	CORRECTION FACTOR (dB/m)
1	*5755.00	116.1 PK			1.31 V	118	111.7	4.4
2	*5755.00	104.3 AV			1.31 V	118	99.9	4.4
3	11510.00	66.0 PK	74.0	-8.0	1.05 V	24	52.4	13.6
4	11510.00	49.8 AV	54.0	-4.2	1.05 V	24	36.2	13.6
5	#17265.00	62.2 PK	74.0	-11.8	1.75 V	68	44.6	17.6
6	#17265.00	49.7 AV	54.0	-4.3	1.75 V	68	32.1	17.6

REMARKS:

- Emission Level(dBuV/m) = Raw Value(dBuV) + Correction Factor(dB/m)
- Correction Factor(dB/m) = Antenna Factor(dB/m) + Cable Factor(dB) – Pre-Amplifier Factor(dB)
- The other emission levels were very low against the limit.
- Margin value = Emission Level – Limit value
- " * ": Fundamental frequency.
- " # ": The radiated frequency is out of the restricted band.

CHANNEL	TX Channel 159	DETECTOR FUNCTION	Peak (PK)
FREQUENCY RANGE	1GHz ~ 40GHz		Average (AV)

ANTENNA POLARITY & TEST DISTANCE: HORIZONTAL AT 3 M

NO.	FREQ. (MHz)	EMISSION LEVEL (dBuV/m)	LIMIT (dBuV/m)	MARGIN (dB)	ANTENNA HEIGHT (m)	TABLE ANGLE (Degree)	RAW VALUE (dBuV)	CORRECTION FACTOR (dB/m)
1	*5795.00	113.5 PK			1.96 H	12	109.1	4.4
2	*5795.00	102.7 AV			1.96 H	12	98.3	4.4
3	11590.00	65.4 PK	74.0	-8.6	1.01 H	58	51.9	13.5
4	11590.00	53.5 AV	54.0	-0.5	1.01 H	58	40.0	13.5
5	#17385.00	60.9 PK	74.0	-13.1	1.59 H	168	42.6	18.3
6	#17385.00	49.5 AV	54.0	-4.5	1.59 H	168	31.2	18.3

ANTENNA POLARITY & TEST DISTANCE: VERTICAL AT 3 M

NO.	FREQ. (MHz)	EMISSION LEVEL (dBuV/m)	LIMIT (dBuV/m)	MARGIN (dB)	ANTENNA HEIGHT (m)	TABLE ANGLE (Degree)	RAW VALUE (dBuV)	CORRECTION FACTOR (dB/m)
1	*5795.00	115.8 PK			1.28 V	109	111.4	4.4
2	*5795.00	104.1 AV			1.28 V	109	99.7	4.4
3	11590.00	66.1 PK	74.0	-7.9	1.12 V	18	52.6	13.5
4	11590.00	50.1 AV	54.0	-3.9	1.12 V	18	36.6	13.5
5	#17385.00	63.0 PK	74.0	-11.0	1.84 V	75	44.7	18.3
6	#17385.00	50.3 AV	54.0	-3.7	1.84 V	75	32.0	18.3

REMARKS:

1. Emission Level(dBuV/m) = Raw Value(dBuV) + Correction Factor(dB/m)
2. Correction Factor(dB/m) = Antenna Factor(dB/m) + Cable Factor(dB) – Pre-Amplifier Factor(dB)
3. The other emission levels were very low against the limit.
4. Margin value = Emission Level – Limit value
5. " * ": Fundamental frequency.
6. " # ": The radiated frequency is out of the restricted band.

802.11ac (VHT80)

CHANNEL	TX Channel 42	DETECTOR FUNCTION	Peak (PK)
FREQUENCY RANGE	1GHz ~ 40GHz		Average (AV)

ANTENNA POLARITY & TEST DISTANCE: HORIZONTAL AT 3 M

NO.	FREQ. (MHz)	EMISSION LEVEL (dBuV/m)	LIMIT (dBuV/m)	MARGIN (dB)	ANTENNA HEIGHT (m)	TABLE ANGLE (Degree)	RAW VALUE (dBuV)	CORRECTION FACTOR (dB/m)
1	5150.00	59.7 PK	74.0	-14.3	1.48 H	10	56.0	3.7
2	5150.00	50.4 AV	54.0	-3.6	1.48 H	10	46.7	3.7
3	*5210.00	101.7 PK			1.48 H	10	98.0	3.7
4	*5210.00	94.9 AV			1.48 H	10	91.2	3.7
5	5350.00	60.8 PK	74.0	-13.2	1.48 H	10	56.7	4.1
6	5350.00	51.9 AV	54.0	-2.1	1.48 H	10	47.8	4.1
7	#10420.00	59.9 PK	74.0	-14.1	1.50 H	352	46.8	13.1
8	#10420.00	48.8 AV	54.0	-5.2	1.50 H	352	35.7	13.1
9	15630.00	56.7 PK	74.0	-17.3	2.15 H	23	43.1	13.6
10	15630.00	46.6 AV	54.0	-7.4	2.15 H	23	33.0	13.6

ANTENNA POLARITY & TEST DISTANCE: VERTICAL AT 3 M

NO.	FREQ. (MHz)	EMISSION LEVEL (dBuV/m)	LIMIT (dBuV/m)	MARGIN (dB)	ANTENNA HEIGHT (m)	TABLE ANGLE (Degree)	RAW VALUE (dBuV)	CORRECTION FACTOR (dB/m)
1	5150.00	61.2 PK	74.0	-12.8	1.15 V	120	57.5	3.7
2	5150.00	53.5 AV	54.0	-0.5	1.15 V	120	49.8	3.7
3	*5210.00	104.1 PK			1.15 V	120	100.4	3.7
4	*5210.00	96.9 AV			1.15 V	120	93.2	3.7
5	5350.00	54.5 PK	74.0	-19.5	1.15 V	120	50.4	4.1
6	5350.00	46.7 AV	54.0	-7.3	1.15 V	120	42.6	4.1
7	#10420.00	59.5 PK	74.0	-14.5	1.04 V	235	46.4	13.1
8	#10420.00	48.4 AV	54.0	-5.6	1.04 V	235	35.3	13.1
9	15630.00	56.7 PK	74.0	-17.3	2.64 V	19	43.1	13.6
10	15630.00	46.5 AV	54.0	-7.5	2.64 V	19	32.9	13.6

REMARKS:

- Emission Level(dBuV/m) = Raw Value(dBuV) + Correction Factor(dB/m)
- Correction Factor(dB/m) = Antenna Factor(dB/m) + Cable Factor(dB) – Pre-Amplifier Factor(dB)
- The other emission levels were very low against the limit.
- Margin value = Emission Level – Limit value
- " * ": Fundamental frequency.
- " # ": The radiated frequency is out of the restricted band.

CHANNEL	TX Channel 155	DETECTOR FUNCTION	Peak (PK)
FREQUENCY RANGE	1GHz ~ 40GHz		Average (AV)

ANTENNA POLARITY & TEST DISTANCE: HORIZONTAL AT 3 M

NO.	FREQ. (MHz)	EMISSION LEVEL (dBuV/m)	LIMIT (dBuV/m)	MARGIN (dB)	ANTENNA HEIGHT (m)	TABLE ANGLE (Degree)	RAW VALUE (dBuV)	CORRECTION FACTOR (dB/m)
1	*5775.00	109.3 PK			1.21 H	25	104.9	4.4
2	*5775.00	101.2 AV			1.21 H	25	96.8	4.4
3	11550.00	61.3 PK	74.0	-12.7	1.44 H	340	47.8	13.5
4	11550.00	49.7 AV	54.0	-4.3	1.44 H	340	36.2	13.5
5	#17325.00	65.1 PK	74.0	-8.9	2.11 H	24	47.3	17.8
6	#17325.00	53.5 AV	54.0	-0.5	2.11 H	24	35.7	17.8

ANTENNA POLARITY & TEST DISTANCE: VERTICAL AT 3 M

NO.	FREQ. (MHz)	EMISSION LEVEL (dBuV/m)	LIMIT (dBuV/m)	MARGIN (dB)	ANTENNA HEIGHT (m)	TABLE ANGLE (Degree)	RAW VALUE (dBuV)	CORRECTION FACTOR (dB/m)
1	*5775.00	110.5 PK			1.19 V	140	106.1	4.4
2	*5775.00	102.1 AV			1.19 V	140	97.7	4.4
3	11550.00	59.9 PK	74.0	-14.1	1.07 V	219	46.4	13.5
4	11550.00	48.6 AV	54.0	-5.4	1.07 V	219	35.1	13.5
5	#17325.00	64.5 PK	74.0	-9.5	2.67 V	18	46.7	17.8
6	#17325.00	52.2 AV	54.0	-1.8	2.67 V	18	34.4	17.8

REMARKS:

1. Emission Level(dBuV/m) = Raw Value(dBuV) + Correction Factor(dB/m)
2. Correction Factor(dB/m) = Antenna Factor(dB/m) + Cable Factor(dB) – Pre-Amplifier Factor(dB)
3. The other emission levels were very low against the limit.
4. Margin value = Emission Level – Limit value
5. " * ": Fundamental frequency.
6. " # ": The radiated frequency is out of the restricted band.

Below 1GHz Data:

802.11a

CHANNEL	TX Channel 48	DETECTOR FUNCTION	Quasi-Peak (QP)
FREQUENCY RANGE	9kHz ~ 1GHz		

ANTENNA POLARITY & TEST DISTANCE: HORIZONTAL AT 3 M								
NO.	FREQ. (MHz)	EMISSION LEVEL (dBuV/m)	LIMIT (dBuV/m)	MARGIN (dB)	ANTENNA HEIGHT (m)	TABLE ANGLE (Degree)	RAW VALUE (dBuV)	CORRECTION FACTOR (dB/m)
1	91.45	33.9 QP	43.5	-9.6	2.00 H	304	47.7	-13.8
2	114.61	32.6 QP	43.5	-10.9	2.50 H	91	43.3	-10.7
3	139.34	31.3 QP	43.5	-12.2	2.00 H	271	39.9	-8.6
4	182.73	31.9 QP	43.5	-11.6	1.50 H	194	41.9	-10.0
5	310.11	29.6 QP	46.0	-16.4	1.00 H	140	36.7	-7.1
6	874.99	41.2 QP	46.0	-4.8	1.00 H	142	38.6	2.6

REMARKS:

1. Emission Level(dBuV/m) = Raw Value(dBuV) + Correction Factor(dB/m)
2. Correction Factor(dB/m) = Antenna Factor(dB/m) + Cable Factor(dB) – Pre-Amplifier Factor(dB)
3. The other emission levels were very low against the limit.
4. Margin value = Emission Level – Limit value

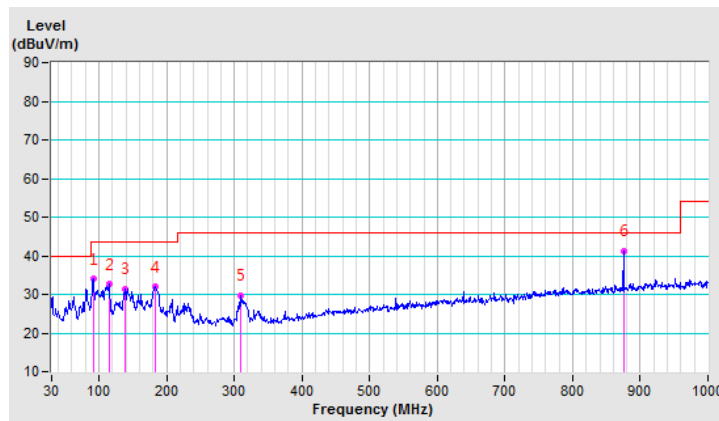

CHANNEL	TX Channel 48	DETECTOR FUNCTION	Quasi-Peak (QP)
FREQUENCY RANGE	9kHz ~ 1GHz		

ANTENNA POLARITY & TEST DISTANCE: VERTICAL AT 3 M

NO.	FREQ. (MHz)	EMISSION LEVEL (dBuV/m)	LIMIT (dBuV/m)	MARGIN (dB)	ANTENNA HEIGHT (m)	TABLE ANGLE (Degree)	RAW VALUE (dBuV)	CORRECTION FACTOR (dB/m)
1	43.12	34.2 QP	40.0	-5.8	1.00 V	360	42.6	-8.4
2	62.37	34.1 QP	40.0	-5.9	1.50 V	100	43.4	-9.3
3	92.42	33.0 QP	43.5	-10.5	1.00 V	296	46.7	-13.7
4	142.45	29.6 QP	43.5	-13.9	1.00 V	95	37.9	-8.3
5	183.14	33.0 QP	43.5	-10.5	1.00 V	281	43.1	-10.1
6	874.99	42.6 QP	46.0	-3.4	1.50 V	340	40.0	2.6

REMARKS:

1. Emission Level(dBuV/m) = Raw Value(dBuV) + Correction Factor(dB/m)
2. Correction Factor(dB/m) = Antenna Factor(dB/m) + Cable Factor(dB) – Pre-Amplifier Factor(dB)
3. The other emission levels were very low against the limit.
4. Margin value = Emission Level – Limit value

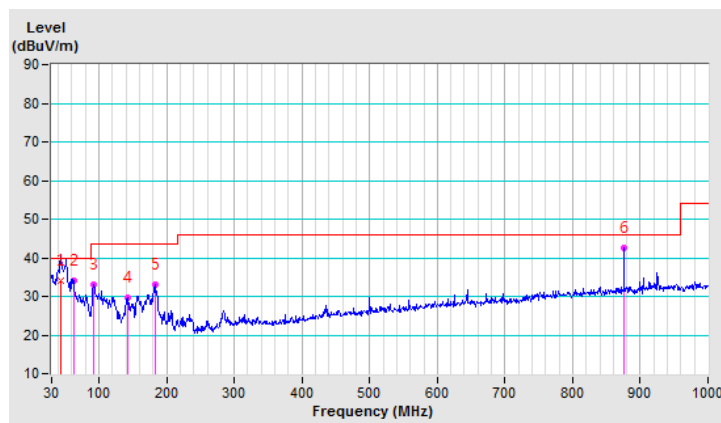

4.2 Conducted Emission Measurement

4.2.1 Limits of Conducted Emission Measurement

Frequency (MHz)	Conducted Limit (dBuV)	
	Quasi-peak	Average
0.15 - 0.5	66 - 56	56 - 46
0.50 - 5.0	56	46
5.0 - 30.0	60	50

Note: 1. The lower limit shall apply at the transition frequencies.

2. The limit decreases in line with the logarithm of the frequency in the range of 0.15 to 0.50MHz.

4.2.2 Test Instruments

DESCRIPTION & MANUFACTURER	MODEL NO.	SERIAL NO.	CALIBRATED DATE	CALIBRATED UNTIL
Test Receiver R&S	ESCS 30	847124/029	Oct. 24, 2016	Oct. 23, 2017
Line-Impedance Stabilization Network (for EUT) R&S	ESH3-Z5	848773/004	Oct. 26, 2016	Oct. 25, 2017
Line-Impedance Stabilization Network (for Peripheral) R&S	ENV216	100072	June 03, 2017	June 02, 2018
50 ohms Terminator	N/A	EMC-02	Sep. 22, 2017	Sep. 21, 2018
RF Cable	5D-FB	COCCAB-001	Sep. 29, 2017	Sep. 28, 2018
10 dB PAD Mini-Circuits	HAT-10+	CONATT-004	June 18, 2017	June 17, 2018
Software BVADT	BVADT_Cond_ V7.3.7.4	NA	NA	NA

Note:

1. The calibration interval of the above test instruments are 12 months and the calibrations are traceable to NML/ROC and NIST/USA.
2. The test was performed in Shielded Room No. 1.
3. Tested Date: Oct. 06, 2017

4.2.3 Test Procedure

- The EUT was placed 0.4 meters from the conducting wall of the shielded room with EUT being connected to the power mains through a line impedance stabilization network (LISN). Other support units were connected to the power mains through another LISN. The two LISNs provide 50 ohm/ 50uH of coupling impedance for the measuring instrument.
- Both lines of the power mains connected to the EUT were checked for maximum conducted interference.
- The frequency range from 150kHz to 30MHz was searched. Emission levels under (Limit - 20dB) was not recorded.

NOTE: All modes of operation were investigated and the worst-case emissions are reported.

4.2.4 Deviation from Test Standard

No deviation.

4.2.5 Test Setup

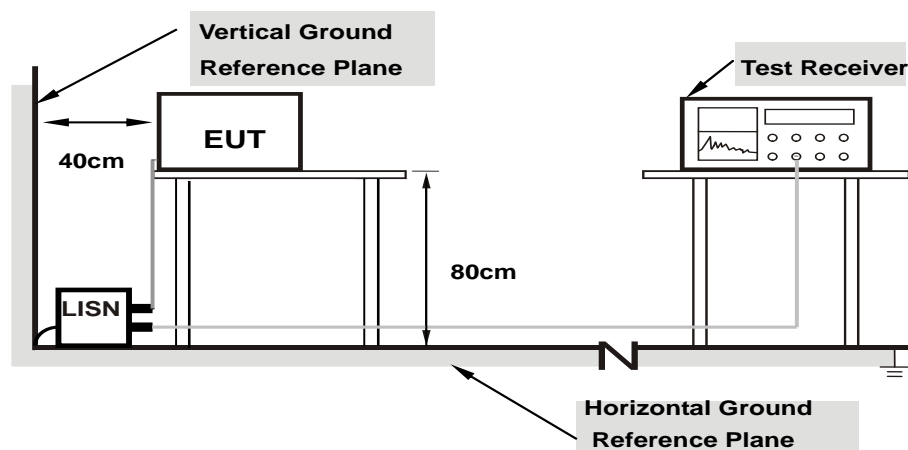

Note: 1.Support units were connected to second LISN.

For the actual test configuration, please refer to the attached file (Test Setup Photo).

4.2.6 EUT Operating Condition

Same as 4.1.6.

4.2.7 Test Results

Phase	Line (L)	Detector Function	Quasi-Peak (QP) / Average (AV)
-------	----------	-------------------	--------------------------------

No	Freq. [MHz]	Corr.	Reading Value		Emission Level		Limit		Margin	
		Factor (dB)	[dB (uV)]		[dB (uV)]		[dB (uV)]		(dB)	
			Q.P.	AV.	Q.P.	AV.	Q.P.	AV.	Q.P.	AV.
1	0.15000	10.08	31.64	21.20	41.72	31.28	66.00	56.00	-24.28	-24.72
2	0.17344	10.08	27.80	12.56	37.88	22.64	64.79	54.79	-26.91	-32.15
3	0.89219	10.15	29.40	21.66	39.55	31.81	56.00	46.00	-16.45	-14.19
4	2.57422	10.23	25.77	16.85	36.00	27.08	56.00	46.00	-20.00	-18.92
5	3.12109	10.28	16.93	9.72	27.21	20.00	56.00	46.00	-28.79	-26.00
6	6.37500	10.53	26.20	20.50	36.73	31.03	60.00	50.00	-23.27	-18.97

REMARKS:

1. Q.P. and AV. are abbreviations of quasi-peak and average individually.
2. The emission levels of other frequencies were very low against the limit.
3. Margin value = Emission level - Limit value
4. Correction factor = Insertion loss + Cable loss
5. Emission Level = Correction Factor + Reading Value.

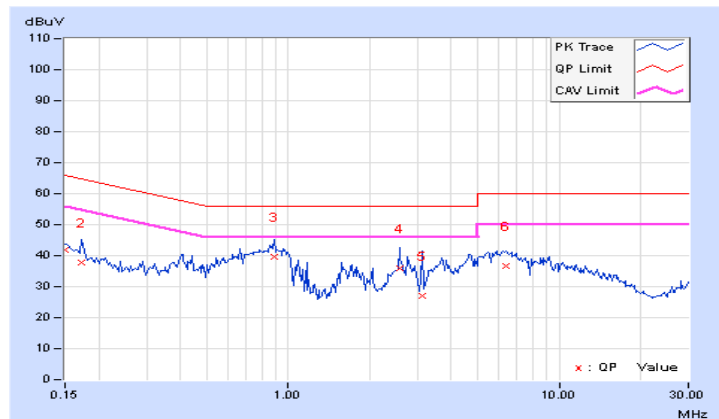

Phase	Neutral (N)	Detector Function	Quasi-Peak (QP) / Average (AV)
-------	-------------	-------------------	--------------------------------

No	Freq. [MHz]	Corr. Factor	Reading Value [dB (uV)]		Emission Level [dB (uV)]		Limit [dB (uV)]		Margin (dB)	
		(dB)	Q.P.	AV.	Q.P.	AV.	Q.P.	AV.	Q.P.	AV.
	1	0.16953	10.06	26.41	11.09	36.47	21.15	64.98	54.98	-28.51
2	0.20859	10.04	23.22	21.79	33.26	31.83	63.26	53.26	-30.00	-21.43
3	0.40781	10.12	30.11	18.62	40.23	28.74	57.69	47.69	-17.46	-18.95
4	0.73203	10.12	25.58	19.05	35.70	29.17	56.00	46.00	-20.30	-16.83
5	4.25000	10.29	26.42	21.13	36.71	31.42	56.00	46.00	-19.29	-14.58
6	5.75781	10.40	32.76	26.49	43.16	36.89	60.00	50.00	-16.84	-13.11

REMARKS:

1. Q.P. and AV. are abbreviations of quasi-peak and average individually.
2. The emission levels of other frequencies were very low against the limit.
3. Margin value = Emission level - Limit value
4. Correction factor = Insertion loss + Cable loss
5. Emission Level = Correction Factor + Reading Value.

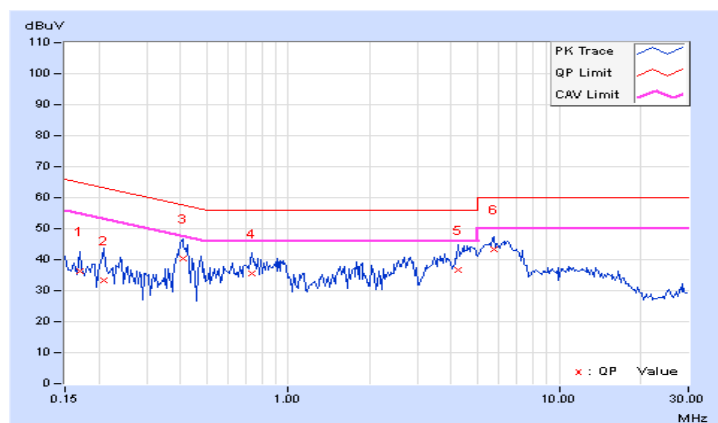

4.3 Transmit Power Measurement

4.3.1 Limits of Transmit Power Measurement

Operation Band	EUT Category		Limit
U-NII-1		Outdoor Access Point	1 Watt (30 dBm) (Max. e.i.r.p \leq 125mW(21 dBm) at any elevation angle above 30 degrees as measured from the horizon)
		Fixed point-to-point Access Point	1 Watt (30 dBm)
	√	Indoor Access Point	1 Watt (30 dBm)
		Mobile and Portable client device	250mW (24 dBm)
U-NII-2A			250mW (24 dBm) or 11 dBm+10 log B*
U-NII-2C			250mW (24 dBm) or 11 dBm+10 log B*
U-NII-3		√	1 Watt (30 dBm)

*B is the 26 dB emission bandwidth in megahertz

Per KDB 662911 Method of conducted output power measurement on IEEE 802.11 devices,

Array Gain = 0 dB (i.e., no array gain) for $N_{ANT} \leq 4$;

Array Gain = 0 dB (i.e., no array gain) for channel widths \geq 40 MHz for any N_{ANT} ;

Array Gain = $5 \log(N_{ANT}/N_{SS})$ dB or 3 dB, whichever is less for 20-MHz channel widths with $N_{ANT} \geq 5$.

For power measurements on all other devices: Array Gain = $10 \log(N_{ANT}/N_{SS})$ dB.

4.3.2 Test Setup

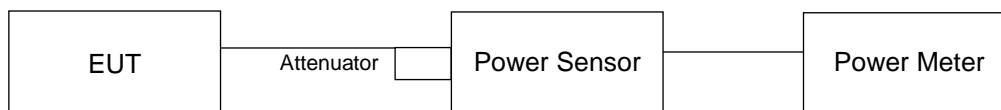

4.3.3 Test Instruments

Refer to section 4.1.2 to get information of above instrument.

4.3.4 Test Procedure

Method PM is used to perform output power measurement, trigger and gating function of wide band power meter is enabled to measure max output power of TX on burst. Duty factor is not added to measured value.

4.3.5 Deviation from Test Standard

No deviation.

4.3.6 EUT Operating Condition

The software provided by client to enable the EUT under transmission condition continuously at lowest, middle and highest channel frequencies individually.

4.3.7 Test Result

CDD Mode

802.11a

Chan.	Chan. Freq. (MHz)	Maximum Conducted Power (dBm)		Total Power (mW)	Total Power (dBm)	Limit (dBm)	Pass / Fail
		Chain 0	Chain 1				
36	5180	23.41	23.37	436.55	26.40	30.00	Pass
40	5200	24.59	24.42	564.434	27.52	30.00	Pass
48	5240	26.46	26.41	880.11	29.45	30.00	Pass
149	5745	21.10	21.24	261.87	24.18	30.00	Pass
157	5785	21.48	21.57	284.154	24.54	30.00	Pass
165	5825	21.57	21.63	289.095	24.61	30.00	Pass

802.11ac (VHT20)

Chan.	Chan. Freq. (MHz)	Maximum Conducted Power (dBm)		Total Power (mW)	Total Power (dBm)	Limit (dBm)	Pass / Fail
		Chain 0	Chain 1				
36	5180	23.62	23.77	468.376	26.71	30.00	Pass
40	5200	24.49	24.51	563.678	27.51	30.00	Pass
48	5240	24.45	24.53	562.404	27.50	30.00	Pass
149	5745	22.07	23.46	382.885	25.83	30.00	Pass
157	5785	22.20	23.51	390.347	25.91	30.00	Pass
165	5825	21.81	21.83	304.11	24.83	30.00	Pass

802.11ac (VHT40)

Chan.	Chan. Freq. (MHz)	Maximum Conducted Power (dBm)		Total Power (mW)	Total Power (dBm)	Limit (dBm)	Pass / Fail
		Chain 0	Chain 1				
38	5190	20.35	19.93	206.794	23.16	30.00	Pass
46	5230	25.92	25.83	773.666	28.89	30.00	Pass
151	5755	24.69	24.54	578.888	27.63	30.00	Pass
159	5795	24.41	24.32	546.454	27.38	30.00	Pass

802.11ac (VHT80)

Chan.	Chan. Freq. (MHz)	Maximum Conducted Power (dBm)		Total Power (mW)	Total Power (dBm)	Limit (dBm)	Pass / Fail
		Chain 0	Chain 1				
42	5210	17.17	17.21	104.721	20.20	30.00	Pass
155	5775	24.89	25.75	684.156	28.35	30.00	Pass

Beamforming Mode

802.11ac (VHT20)

Chan.	Chan. Freq. (MHz)	Maximum Conducted Power (dBm)		Total Power (mW)	Total Power (dBm)	Limit (dBm)	Pass / Fail
		Chain 0	Chain 1				
36	5180	23.62	23.77	468.376	26.71	30.00	Pass
40	5200	24.49	24.51	563.678	27.51	30.00	Pass
48	5240	24.45	24.53	562.404	27.50	30.00	Pass
149	5745	22.07	23.46	382.885	25.83	30.00	Pass
157	5785	22.20	23.51	390.347	25.91	30.00	Pass
165	5825	21.81	21.83	304.11	24.83	30.00	Pass

Note: 1. Directional gain = $10 \log[(10^{G0/20} + 10^{G1/20})^2 / 2] = 5.99\text{dBi} < 6\text{dBi}$, so the power limit shall not be reduced.

802.11ac (VHT40)

Chan.	Chan. Freq. (MHz)	Maximum Conducted Power (dBm)		Total Power (mW)	Total Power (dBm)	Limit (dBm)	Pass / Fail
		Chain 0	Chain 1				
38	5190	20.35	19.93	206.794	23.16	30.00	Pass
46	5230	25.92	25.83	773.666	28.89	30.00	Pass
151	5755	24.69	24.54	578.888	27.63	30.00	Pass
159	5795	24.41	24.32	546.454	27.38	30.00	Pass

Note: 1. Directional gain = $10 \log[(10^{G0/20} + 10^{G1/20})^2 / 2] = 5.99\text{dBi} < 6\text{dBi}$, so the power limit shall not be reduced.

802.11ac (VHT80)

Chan.	Chan. Freq. (MHz)	Maximum Conducted Power (dBm)		Total Power (mW)	Total Power (dBm)	Limit (dBm)	Pass / Fail
		Chain 0	Chain 1				
42	5210	17.17	17.21	104.721	20.20	30.00	Pass
155	5775	24.89	25.75	684.156	28.35	30.00	Pass

Note: 1. Directional gain = $10 \log[(10^{G0/20} + 10^{G1/20})^2 / 2] = 5.99\text{dBi} < 6\text{dBi}$, so the power limit shall not be reduced.

4.4 Occupied Bandwidth Measurement

4.4.1 Test Setup

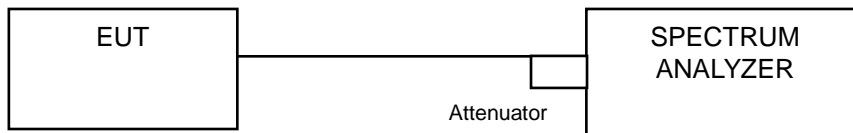

4.4.2 Test Instruments

Refer to section 4.1.2 to get information of above instrument.

4.4.3 Test Procedure

The transmitter output was connected to the spectrum analyzer through an attenuator. The bandwidth of the fundamental frequency was measured by spectrum analyzer with resolution bandwidth in the range of 1% to 5% of the anticipated emission bandwidth, and a video bandwidth at least 3x the resolution bandwidth and set the detector to SAMPLE. The width of a frequency band such that, below the lower and above the upper frequency limits, the mean powers emitted are each equal to a specified percentage 0.5 %of the total mean power of a given emission.

4.4.4 Test Results

CDD Mode

802.11a

Channel	Channel Frequency (MHz)	Occupied Bandwidth (MHz)	
		CHAIN 0	CHAIN 1
36	5180	17.04	16.68
40	5200	18.24	17.16
48	5240	19.20	18.48
149	5745	16.68	16.68
157	5785	16.68	16.80
165	5825	17.52	16.92

802.11ac (VHT20)

Channel	Channel Frequency (MHz)	Occupied Bandwidth (MHz)	
		CHAIN 0	CHAIN 1
36	5180	18.12	17.88
40	5200	18.36	18.48
48	5240	18.60	18.72
149	5745	18.12	18.24
157	5785	18.24	18.48
165	5825	20.40	18.36

802.11ac (VHT40)

Channel	Channel Frequency (MHz)	Occupied Bandwidth (MHz)	
		CHAIN 0	CHAIN 1
38	5190	36.24	36.24
46	5230	39.12	37.20
151	5755	50.88	47.76
159	5795	56.40	48.72

802.11ac (VHT80)

Channel	Channel Frequency (MHz)	Occupied Bandwidth (MHz)	
		CHAIN 0	CHAIN 1
42	5210	75.36	75.36
155	5775	105.60	102.24

Spectrum Plot of Worst Value

802.11a_Chain0 / CH48

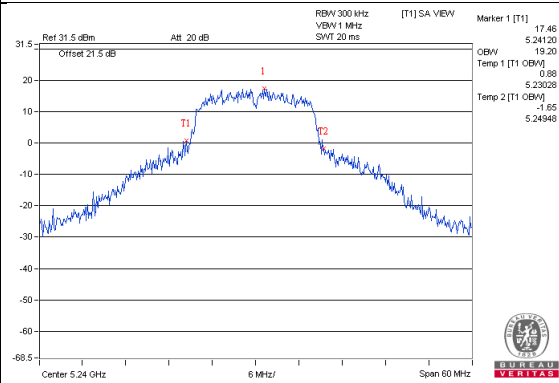

802.11ac (VHT20)_Chain0 / CH165

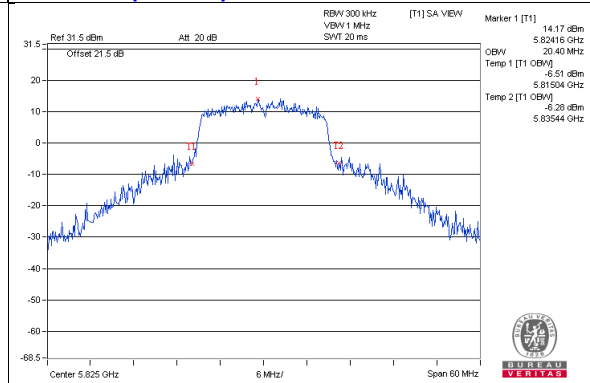

802.11ac (VHT40)_Chain0 / CH159

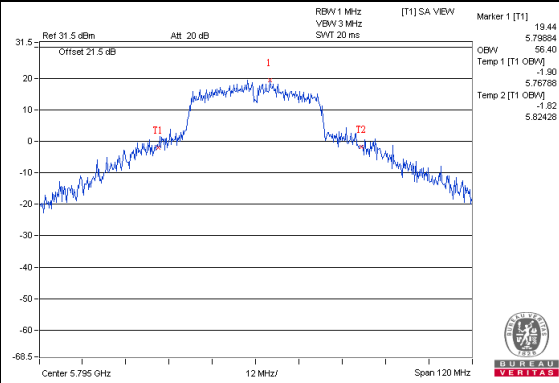

802.11ac (VHT80)_Chain0 / CH155

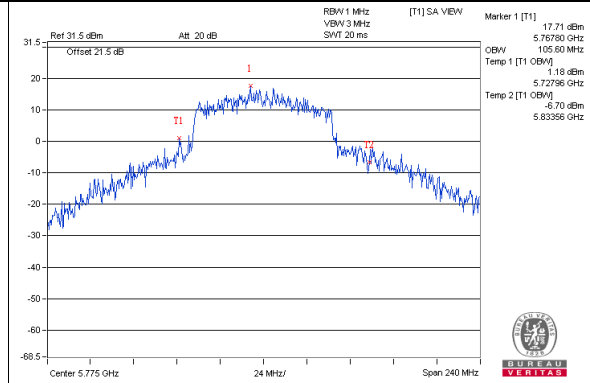

Spectrum Plot for near by DFS band (DFS is required, if 99% OCP straddle into U-NII-2A band)

802.11a_Chain0 / CH48

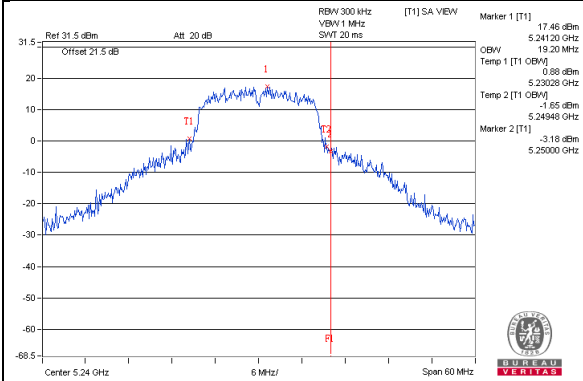

802.11a_Chain1 / CH48

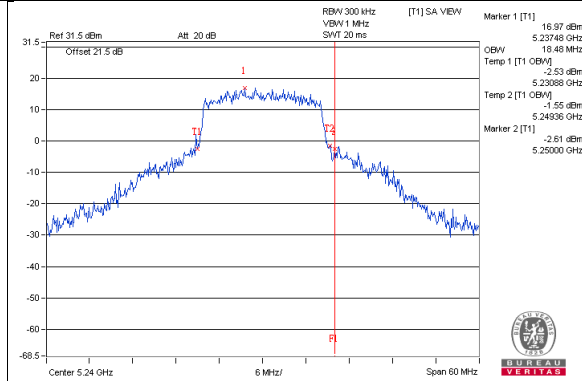

802.11ac(VHT20)_Chain0 / CH48

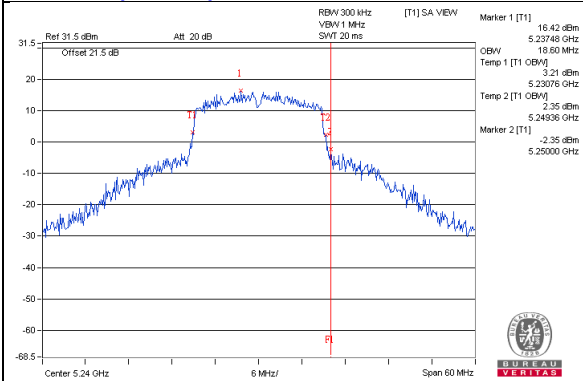

802.11ac(VHT20)_Chain1 / CH48

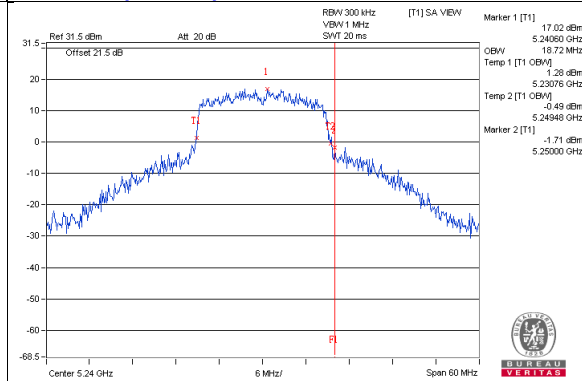

802.11ac(VHT40)_Chain0 / CH46

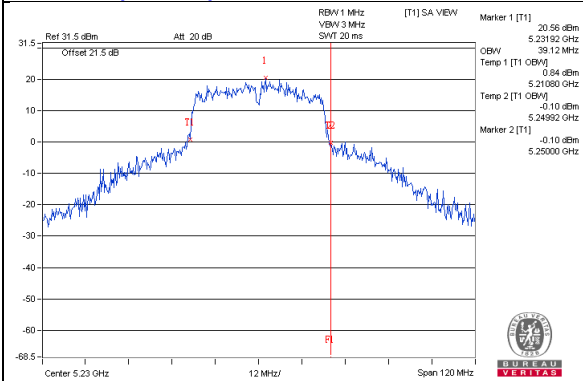

802.11ac(VHT40)_Chain1 / CH46

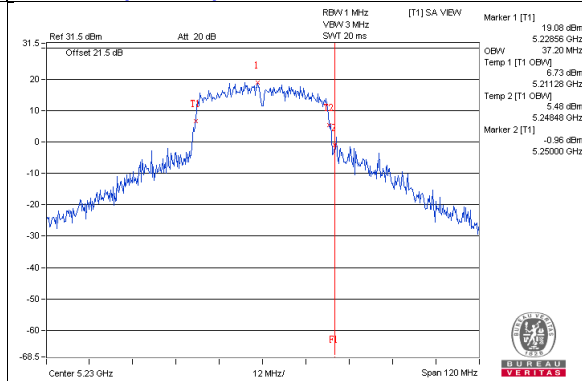

802.11ac(VHT80)_Chain0 / CH42

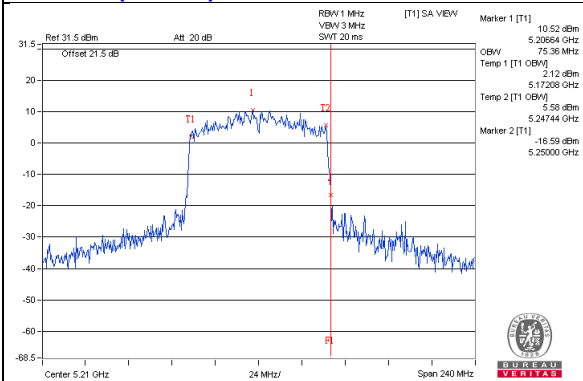

802.11ac(VHT80)_Chain1 / CH42

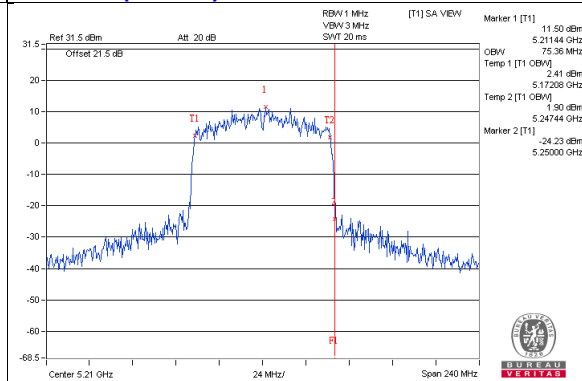

Spectrum Plot for near by DFS band (DFS is required, if 99% OCP straddle into U-NII-2C band)

802.11a_Chain0 / CH149

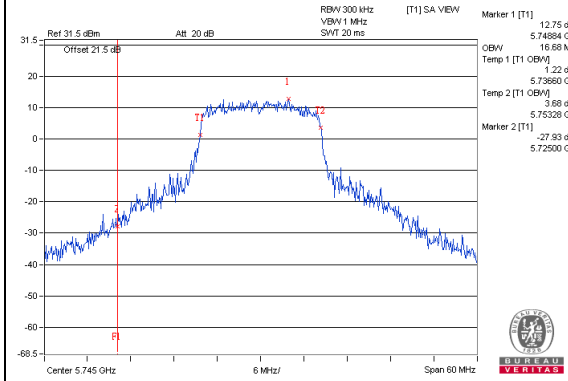

802.11a_Chain1 / CH149

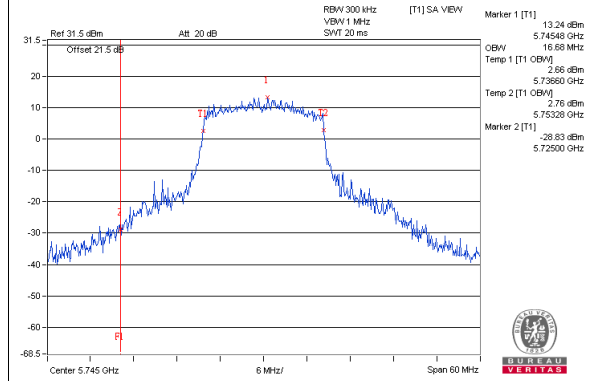

802.11ac(VHT20)_Chain0 / CH149

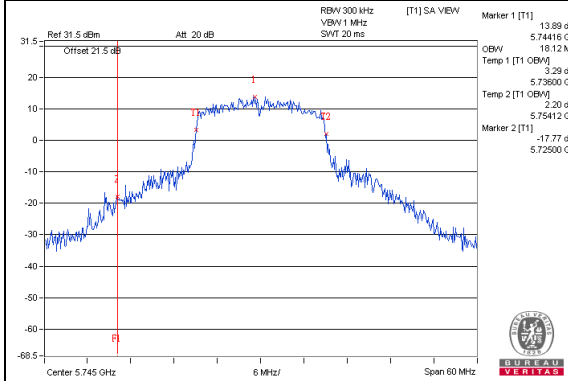

802.11ac(VHT20)_Chain1 / CH149

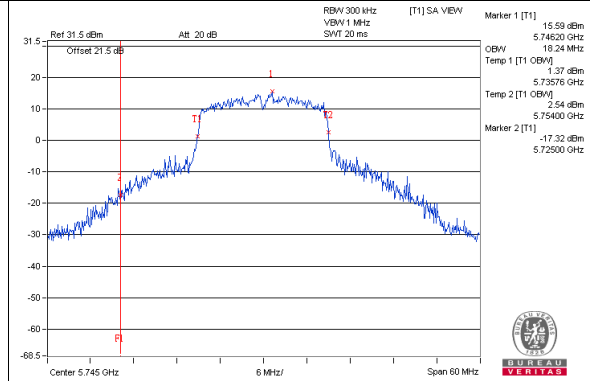

802.11ac(VHT40)_Chain0 / CH151

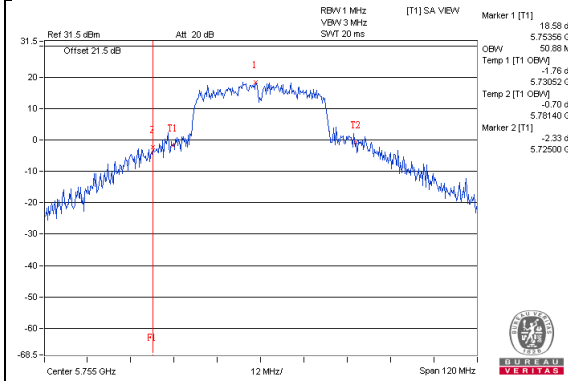

802.11ac(VHT40)_Chain1 / CH151

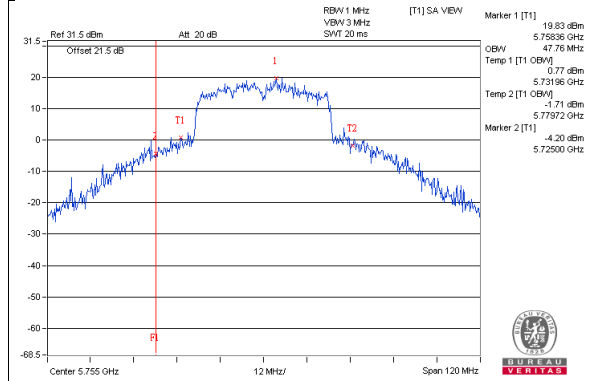

802.11ac(VHT80)_Chain0 / CH155

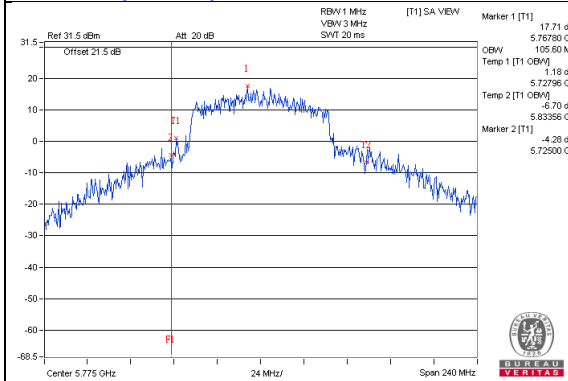

802.11ac(VHT80)_Chain1 / CH155

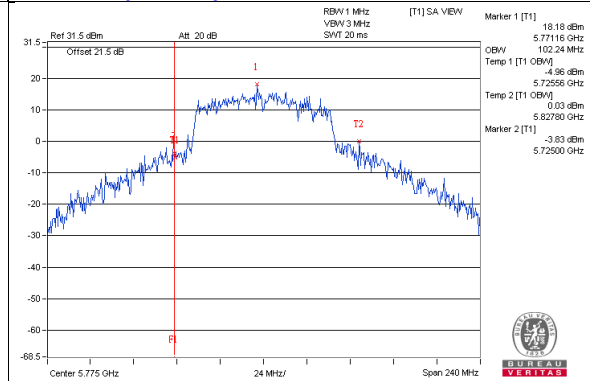

4.5 Peak Power Spectral Density Measurement

4.5.1 Limits of Peak Power Spectral Density Measurement

Operation Band	EUT Category		Limit
U-NII-1		Outdoor Access Point	17dBm/ MHz
		Fixed point-to-point Access Point	
	√	Indoor Access Point	
		Mobile and Portable client device	11dBm/ MHz
U-NII-2A			11dBm/ MHz
U-NII-2C			11dBm/ MHz
U-NII-3	√		30dBm/ 500kHz

4.5.2 Test Setup

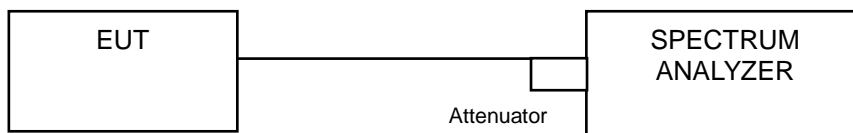

4.5.3 Test Instruments

Refer to section 4.1.2 to get information of above instrument.

4.5.4 Test Procedure

For U-NII-1:

Using method SA-2

1. Set span to encompass the entire emission bandwidth (EBW) of the signal.
2. Set RBW = 1 MHz, Set VBW \geq 3 MHz, Detector = RMS
3. Sweep time = auto, trigger set to "free run".
4. Trace average at least 100 traces in power averaging mode.
5. Record the max value and add 10 log (1/duty cycle)

For U-NII-3:

1. Set span to encompass the entire emission bandwidth (EBW) of the signal.
2. Set RBW = 300 kHz, Set VBW \geq 1 MHz, Detector = RMS
3. Use the peak marker function to determine the maximum power level in any 300 kHz band segment within the fundamental EBW.
4. Scale the observed power level to an equivalent value in 500 kHz by adjusting (reducing) the measured power by a bandwidth correction factor (BWCF) where $BWCF = 10\log(500 \text{ kHz}/300\text{kHz})$
5. Sweep time = auto, trigger set to "free run".
6. Trace average at least 100 traces in power averaging mode.
7. Record the max value and add 10 log (1/duty cycle)

4.5.5 Deviation from Test Standard

No deviation.

4.5.6 EUT Operating Condition

Same as Item 4.3.6.

4.5.7 Test Results

CDD Mode

For U-NII-1:

802.11a

Chan.	Chan. Freq. (MHz)	PSD W/O Duty Factor (dBm)		Duty Factor (dB)	Total PSD With Duty Factor (dBm)	MAX. Limit (dBm)	Pass / Fail
		Chain 0	Chain 1				
36	5180	7.65	6.81	0.93	11.19	17.00	Pass
40	5200	4.13	5.57	0.93	8.85	17.00	Pass
48	5240	11.26	10.51	0.93	14.84	17.00	Pass

- Note:**
- Method a) of power density measurement of KDB 662911 is using for calculating total power density. Total power density is summing entire spectra across corresponding frequency bins on the various outputs by computer.
 - Directional gain = $10 \log[(10^{G0/20} + 10^{G1/20})^2 / 2] = 5.99\text{dBi} < 6\text{dBi}$, so the power density limit shall not be reduced.
 - Refer to section 3.3 for duty cycle spectrum plot.

802.11ac (VHT20)

Chan.	Chan. Freq. (MHz)	PSD W/O Duty Factor (dBm)		Duty Factor (dB)	Total PSD With Duty Factor (dBm)	MAX. Limit (dBm)	Pass / Fail
		Chain 0	Chain 1				
36	5180	7.25	7.01	1.01	11.15	17.00	Pass
40	5200	4.75	2.99	1.01	7.97	17.00	Pass
48	5240	7.98	7.20	1.01	11.62	17.00	Pass

- Note:**
- Method a) of power density measurement of KDB 662911 is using for calculating total power density. Total power density is summing entire spectra across corresponding frequency bins on the various outputs by computer.
 - Directional gain = $10 \log[(10^{G0/20} + 10^{G1/20})^2 / 2] = 5.99\text{dBi} < 6\text{dBi}$, so the power density limit shall not be reduced.
 - Refer to section 3.3 for duty cycle spectrum plot.

802.11ac (VHT40)

Chan.	Chan. Freq. (MHz)	PSD W/O Duty Factor (dBm)		Duty Factor (dB)	Total PSD With Duty Factor (dBm)	MAX. Limit (dBm)	Pass / Fail
		Chain 0	Chain 1				
38	5190	-6.77	-7.33	1.81	-2.22	17.00	Pass
46	5230	-5.09	0.86	1.81	3.65	17.00	Pass

- Note:**
- Method a) of power density measurement of KDB 662911 is using for calculating total power density. Total power density is summing entire spectra across corresponding frequency bins on the various outputs by computer.
 - Directional gain = $10 \log[(10^{G0/20} + 10^{G1/20})^2 / 2] = 5.99\text{dBi} < 6\text{dBi}$, so the power density limit shall not be reduced.
 - Refer to section 3.3 for duty cycle spectrum plot.

802.11ac (VHT80)

Chan.	Chan. Freq. (MHz)	PSD W/O Duty Factor (dBm)		Duty Factor (dB)	Total PSD With Duty Factor (dBm)	MAX. Limit (dBm)	Pass / Fail
		Chain 0	Chain 1				
42	5210	-6.08	-5.95	3.18	0.17	17.00	Pass

- Note:**
- Method a) of power density measurement of KDB 662911 is using for calculating total power density. Total power density is summing entire spectra across corresponding frequency bins on the various outputs by computer.
 - Directional gain = $10 \log[(10^{G0/20} + 10^{G1/20})^2 / 2] = 5.99\text{dBi} < 6\text{dBi}$, so the power density limit shall not be reduced.
 - Refer to section 3.3 for duty cycle spectrum plot.

Spectrum Plot of Worst Value

802.11a_Chain 0 / CH48

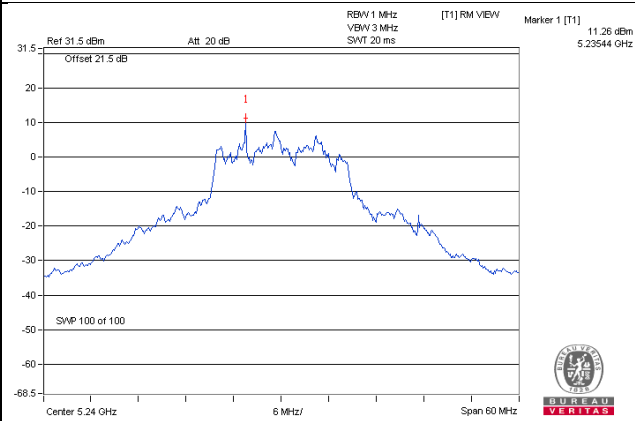

802.11ac (VHT20)_Chain 0 / CH48

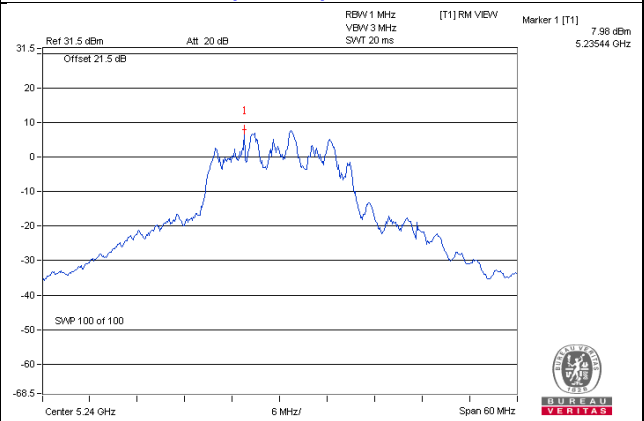

802.11ac (VHT40)_Chain 1 / CH46

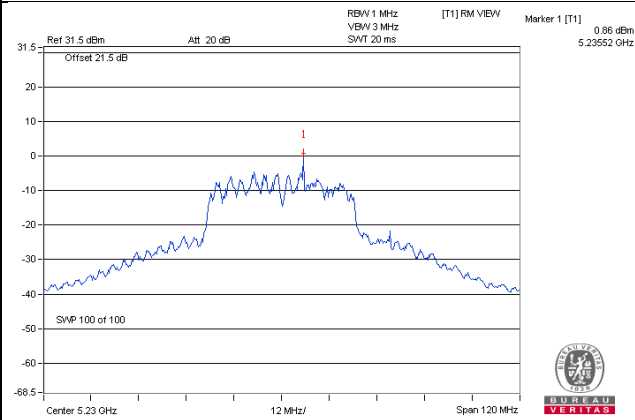

802.11ac (VHT80)_Chain 1 / CH42

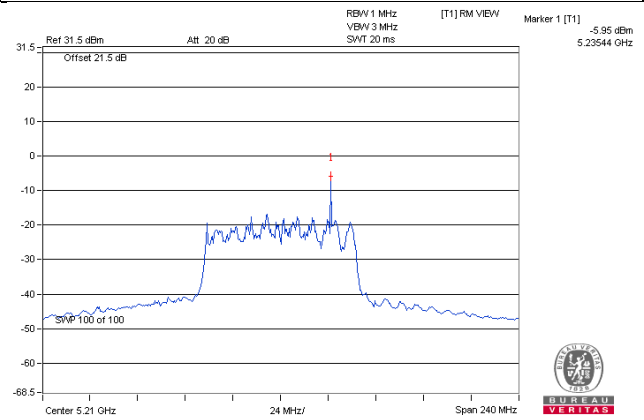

For U-NII-3:
802.11a

TX chain	Chan.	Chan. Freq. (MHz)	PSD W/O Duty Factor		10 log (N=2) dB	Duty Factor (dB)	Total PSD With Duty Factor (dBm/500kHz)	Limit (dBm/500kHz)	Pass /Fail
			(dBm/300kHz)	(dBm/500kHz)					
0	149	5745	-3.98	-1.76	3.01	0.93	2.18	30.00	Pass
	157	5785	-4.77	-2.55	3.01	0.93	1.39	30.00	Pass
	165	5825	-2.46	-0.24	3.01	0.93	3.70	30.00	Pass
1	149	5745	-4.26	-2.04	3.01	0.93	1.90	30.00	Pass
	157	5785	-5.62	-3.40	3.01	0.93	0.54	30.00	Pass
	165	5825	-5.10	-2.88	3.01	0.93	1.06	30.00	Pass

Note: 1. Directional gain = $10 \log[(10^{G0/20} + 10^{G1/20})^2 / 2] = 5.99\text{dBi} < 6\text{dBi}$, so the power density limit shall not be reduced.

2. Refer to section 3.3 for duty cycle spectrum plot.

802.11ac (VHT20)

TX chain	Chan.	Chan. Freq. (MHz)	PSD W/O Duty Factor		10 log (N=2) dB	Duty Factor (dB)	Total PSD With Duty Factor (dBm/500kHz)	Limit (dBm/500kHz)	Pass /Fail
			(dBm/300kHz)	(dBm/500kHz)					
0	149	5745	-4.13	-1.91	3.01	1.01	2.11	30.00	Pass
	157	5785	-4.56	-2.34	3.01	1.01	1.68	30.00	Pass
	165	5825	-3.70	-1.48	3.01	1.01	2.54	30.00	Pass
1	149	5745	-1.84	0.38	3.01	1.01	4.40	30.00	Pass
	157	5785	-4.45	-2.23	3.01	1.01	1.79	30.00	Pass
	165	5825	-4.40	-2.18	3.01	1.01	1.84	30.00	Pass

Note: 1. Directional gain = $10 \log[(10^{G0/20} + 10^{G1/20})^2 / 2] = 5.99\text{dBi} < 6\text{dBi}$, so the power density limit shall not be reduced.

2. Refer to section 3.3 for duty cycle spectrum plot.

802.11ac (VHT40)

TX chain	Chan.	Chan. Freq. (MHz)	PSD W/O Duty Factor		10 log (N=2) dB	Duty Factor (dB)	Total PSD With Duty Factor (dBm/500kHz)	Limit (dBm/500kHz)	Pass /Fail
			(dBm/300kHz)	(dBm/500kHz)					
0	151	5755	-4.60	-2.38	3.01	1.81	2.44	30.00	Pass
	159	5795	-7.19	-4.97	3.01	1.81	-0.15	30.00	Pass
1	151	5755	-4.74	-2.52	3.01	1.81	2.30	30.00	Pass
	159	5795	-6.95	-4.73	3.01	1.81	0.09	30.00	Pass

Note: 1. Directional gain = $10 \log[(10^{G0/20} + 10^{G1/20})^2 / 2] = 5.99\text{dBi} < 6\text{dBi}$, so the power density limit shall not be reduced.

2. Refer to section 3.3 for duty cycle spectrum plot.

802.11ac (VHT80)

TX chain	Chan.	Chan. Freq. (MHz)	PSD W/O Duty Factor		10 log (N=2) dB	Duty Factor (dB)	Total PSD With Duty Factor (dBm/500kHz)	Limit (dBm/500kHz)	Pass /Fail
			(dBm/300kHz)	(dBm/500kHz)					
0	155	5775	-15.78	-13.56	3.01	3.18	-7.37	30.00	Pass
1	155	5775	-11.67	-9.45	3.01	3.18	-3.26	30.00	Pass

Note: 1. Directional gain = $10 \log[(10^{G0/20} + 10^{G1/20})^2 / 2] = 5.99\text{dBi} < 6\text{dBi}$, so the power density limit shall not be reduced.

2. Refer to section 3.3 for duty cycle spectrum plot.

Spectrum Plot of Worst Value

802.11a – Chain 0: CH 165

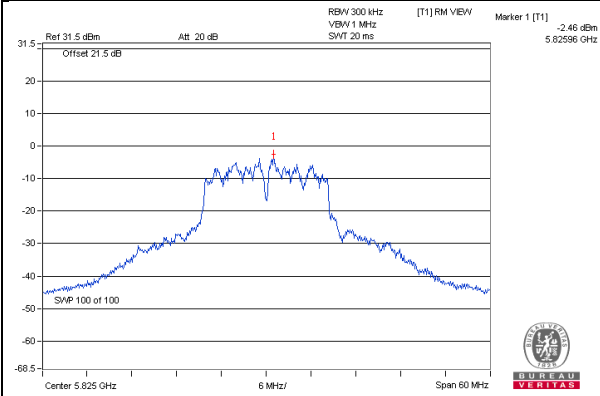

802.11ac (VHT20) – Chain 1: CH 149

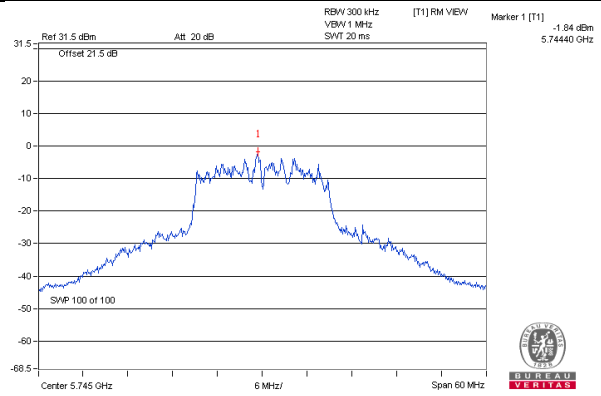

802.11ac (VHT40) – Chain 0: CH 151

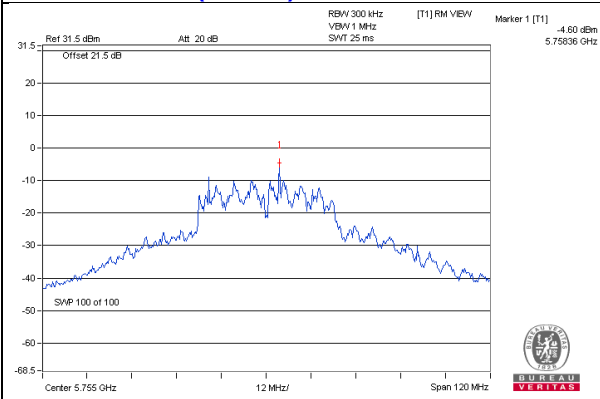

802.11ac (VHT80) – Chain 1: CH 155

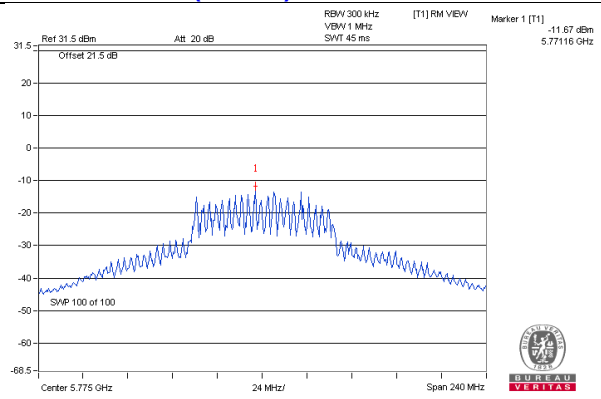

4.6 Frequency Stability Measurement

4.6.1 Limits of Frequency Stability Measurement

The frequency of the carrier signal shall be maintained within band of operation

4.6.2 Test Setup

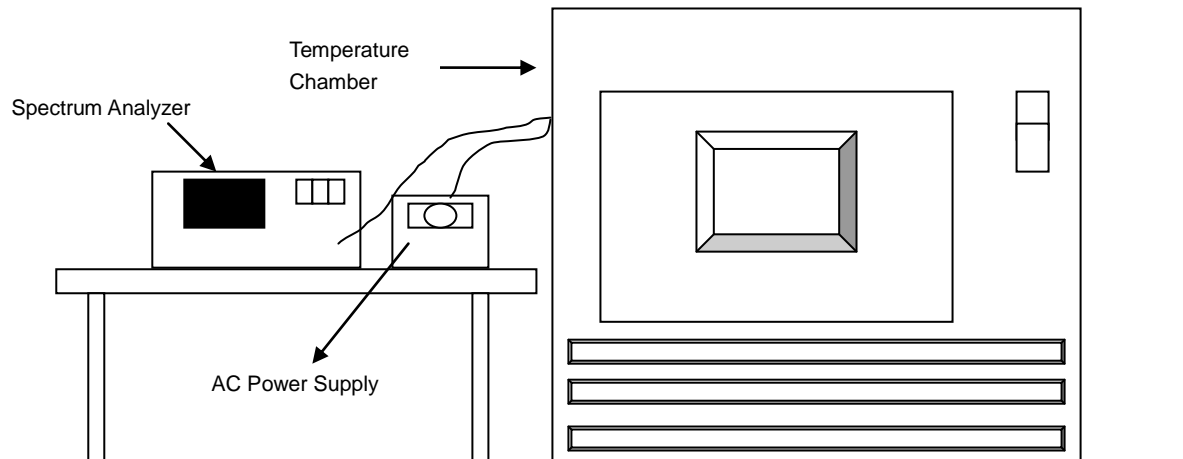

4.6.3 Test Instruments

Refer to section 4.1.2 to get information of above instrument.

4.6.4 Test Procedure

- The EUT was placed inside the environmental test chamber and powered by nominal AC voltage.
- Turn the EUT on and couple its output to a spectrum analyzer.
- Turn the EUT off and set the chamber to the highest temperature specified.
- Allow sufficient time (approximately 30 min) for the temperature of the chamber to stabilize, turn the EUT on and measure the operating frequency after 2, 5, and 10 Minutes.
- Repeat step 2 and 3 with the temperature chamber set to the lowest temperature.
- The test chamber was allowed to stabilize at +20 degree C for a minimum of 30 Minutes. The supply voltage was then adjusted on the EUT from 85% to 115% and the frequency record.

4.6.5 Deviation from Test Standard

No deviation.

4.6.6 EUT Operating Condition

Set the EUT transmit at un-modulation mode to test frequency stability.

4.6.7 Test Results

Frequency Stability Versus Temp.									
Operating Frequency: 5180 MHz									
TEMP. (°C)	Power Supply (Vac)	0 Minute		2 Minutes		5 Minutes		10 Minutes	
		Measured Frequency (MHz)	Pass/Fail	Measured Frequency (MHz)	Pass/Fail	Measured Frequency (MHz)	Pass/Fail	Measured Frequency (MHz)	Pass/Fail
50	120	5179.9998	PASS	5179.9965	PASS	5179.9983	PASS	5180.0005	PASS
40	120	5179.9867	PASS	5179.9825	PASS	5179.9825	PASS	5179.9831	PASS
30	120	5180.0055	PASS	5180.0098	PASS	5180.0091	PASS	5180.0071	PASS
20	120	5179.9905	PASS	5179.9926	PASS	5179.9928	PASS	5179.9904	PASS
10	120	5179.9895	PASS	5179.9898	PASS	5179.9888	PASS	5179.9856	PASS
0	120	5180.001	PASS	5179.9965	PASS	5179.9997	PASS	5180.0002	PASS
-10	120	5180.0221	PASS	5180.0189	PASS	5180.022	PASS	5180.0228	PASS
-20	120	5179.9792	PASS	5179.9814	PASS	5179.9797	PASS	5179.983	PASS
-30	120	5180.019	PASS	5180.0192	PASS	5180.0183	PASS	5180.0153	PASS

Frequency Stability Versus Voltage									
Operating Frequency: 5180 MHz									
TEMP. (°C)	Power Supply (Vac)	0 Minute		2 Minutes		5 Minutes		10 Minutes	
		Measured Frequency (MHz)	Pass/Fail	Measured Frequency (MHz)	Pass/Fail	Measured Frequency (MHz)	Pass/Fail	Measured Frequency (MHz)	Pass/Fail
20	120	5179.9898	PASS	5179.9932	PASS	5179.9938	PASS	5179.991	PASS
	120	5179.9905	PASS	5179.9926	PASS	5179.9928	PASS	5179.9904	PASS
	120	5179.9905	PASS	5179.9933	PASS	5179.9934	PASS	5179.9901	PASS

4.7 6dB Bandwidth Measurement

4.7.1 Limits of 6dB Bandwidth Measurement

The minimum of 6dB Bandwidth Measurement is 0.5MHz.

4.7.2 Test Setup

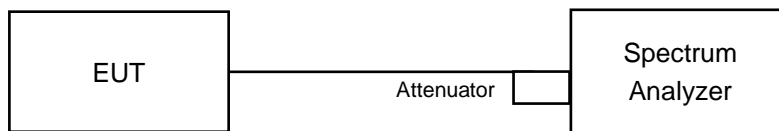

4.7.3 Test Instruments

Refer to section 4.1.2 to get information of above instrument.

4.7.4 Test Procedure

MEASUREMENT PROCEDURE REF

- a. Set resolution bandwidth (RBW) = 100kHz
- b. Set the video bandwidth (VBW) $\geq 3 \times$ RBW, Detector = Peak.
- c. Trace mode = max hold.
- d. Sweep = auto couple.
- e. Measure the maximum width of the emission that is constrained by the frequencies associated with the two amplitude points (upper and lower) that are attenuated by 6 dB relative to the maximum level measured in the fundamental emission

4.7.5 Deviation from Test Standard

No deviation.

4.7.6 EUT Operating Condition

The software provided by client to enable the EUT under transmission condition continuously at lowest, middle and highest channel frequencies individually.

4.7.7 Test Results

CDD Mode

802.11a

Channel	Frequency (MHz)	6dB Bandwidth (MHz)		Minimum Limit (MHz)	Pass / Fail
		Chain 0	Chain 1		
149	5745	15.14	15.15	0.5	PASS
157	5785	15.15	15.15	0.5	PASS
165	5825	15.16	15.19	0.5	PASS

802.11ac (VHT20)

Channel	Frequency (MHz)	6dB Bandwidth (MHz)		Minimum Limit (MHz)	Pass / Fail
		Chain 0	Chain 1		
149	5745	15.19	15.16	0.5	PASS
157	5785	15.10	15.18	0.5	PASS
165	5825	15.18	15.18	0.5	PASS

802.11ac (VHT40)

Channel	Frequency (MHz)	6dB Bandwidth (MHz)		Minimum Limit (MHz)	Pass / Fail
		Chain 0	Chain 1		
151	5755	35.12	35.11	0.5	PASS
159	5795	32.71	35.13	0.5	PASS

802.11ac (VHT80)

Channel	Frequency (MHz)	6dB Bandwidth (MHz)		Minimum Limit (MHz)	Pass / Fail
		Chain 0	Chain 1		
155	5775	61.69	61.65	0.5	PASS

Spectrum Plot of Worst Value

802.11a_Chain 0 / CH149

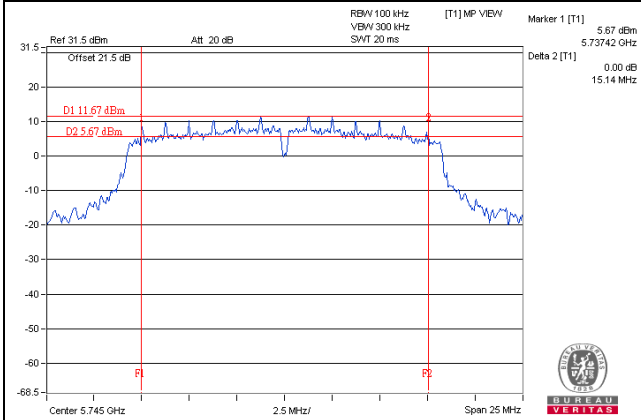

802.11ac (VHT20)_Chain 0 / CH157

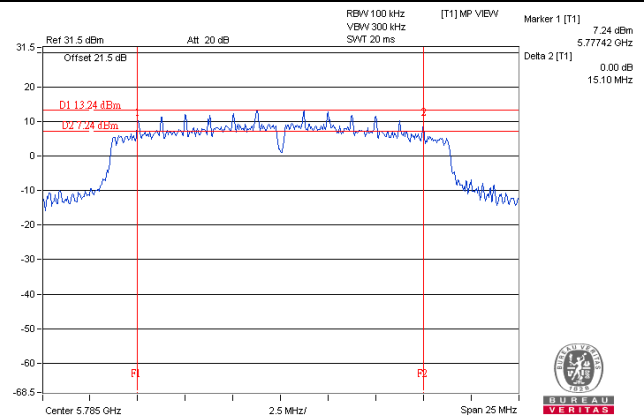

802.11ac (VHT40)_Chain 0 / CH159

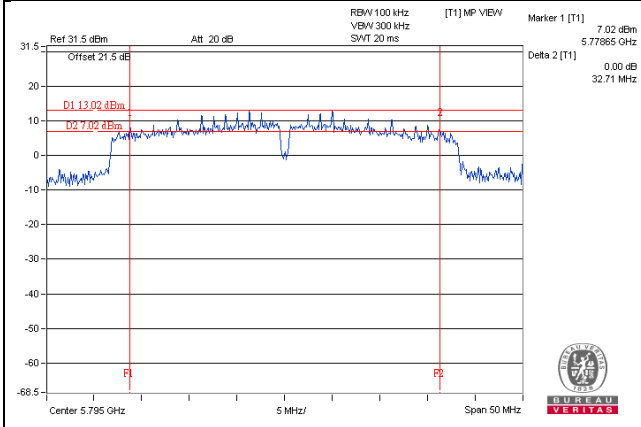

802.11ac (VHT80)_Chain 1 / CH155

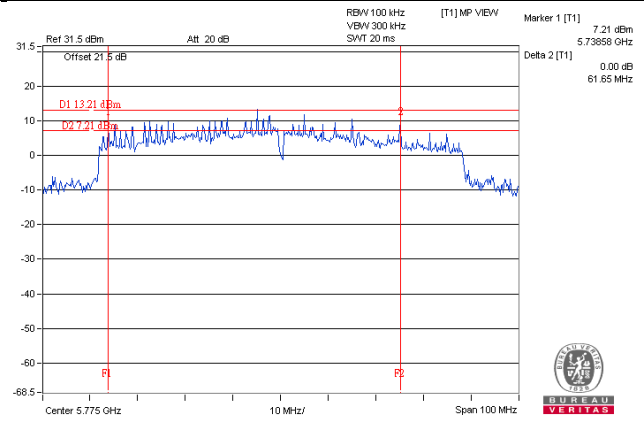

5 Pictures of Test Arrangements

Please refer to the attached file (Test Setup Photo).

Annex A- Radiated Out of Band Emission (OOBE) Measurement (For U-NII-3 band)

802.11a

CH 149 5745 MHz

Horizontal

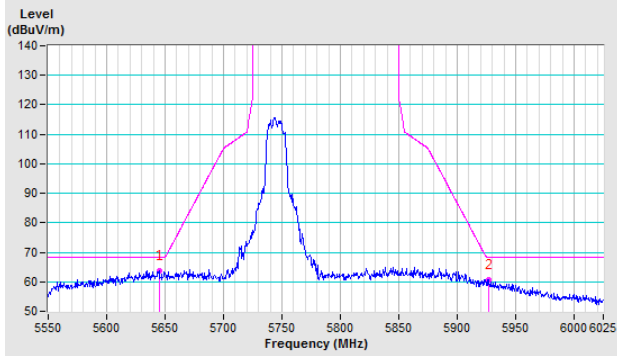

Vertical

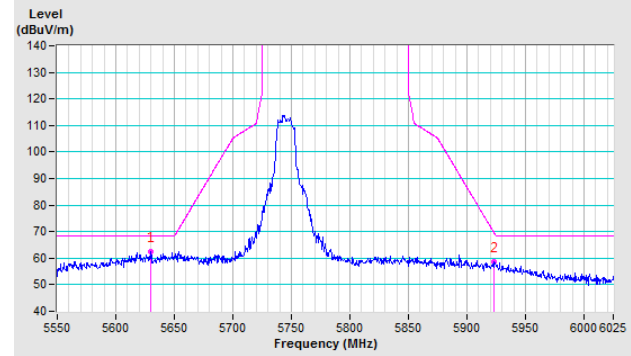

CH 157 5785 MHz

Horizontal

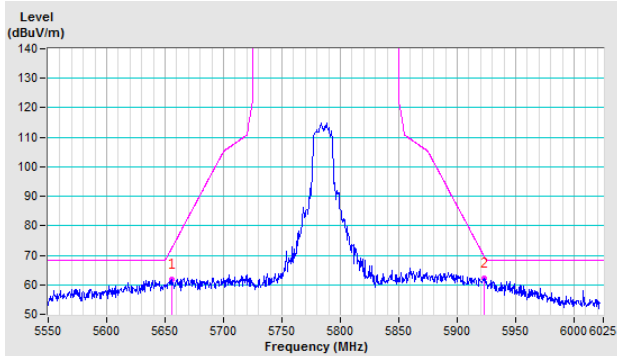

Vertical

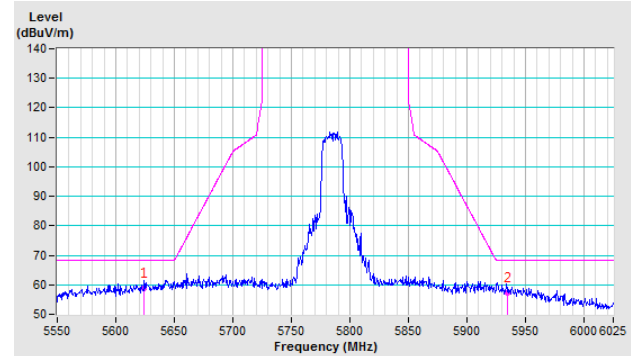

CH 165 5825 MHz

Horizontal

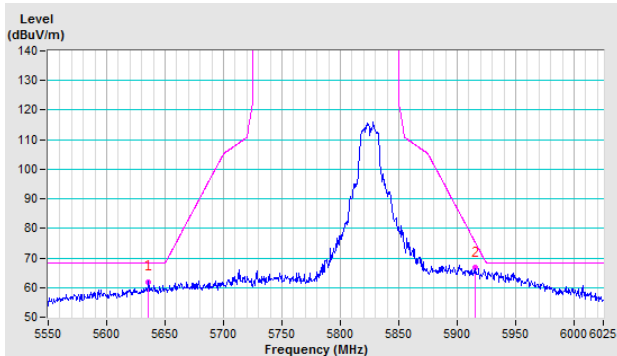

Vertical

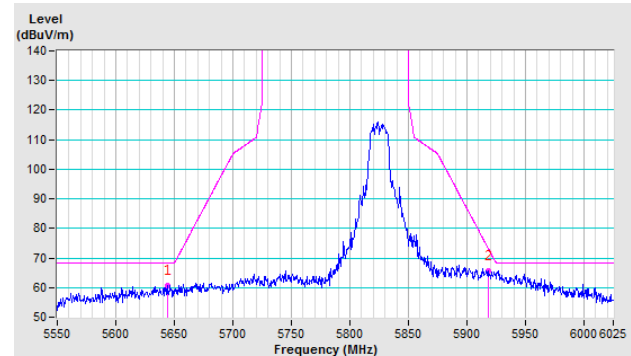

802.11ac (VHT20)

CH 149 5745 MHz

Horizontal

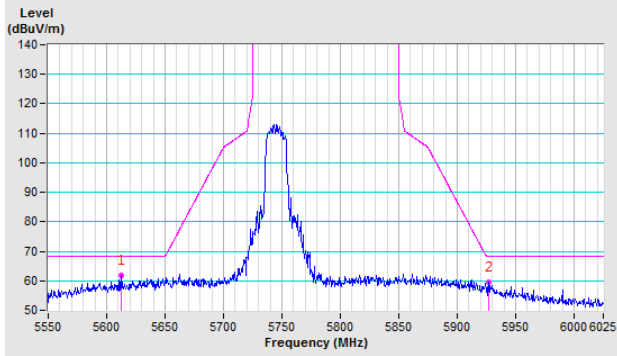

Vertical

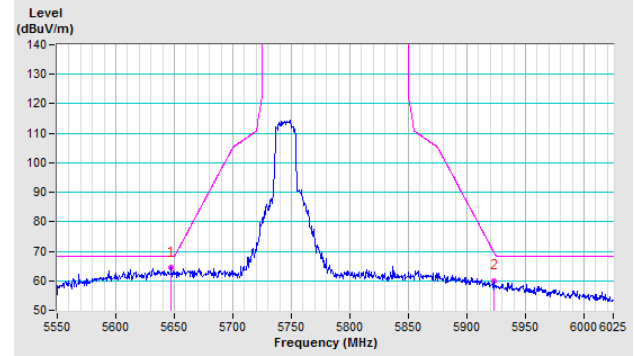

CH 157 5785 MHz

Horizontal

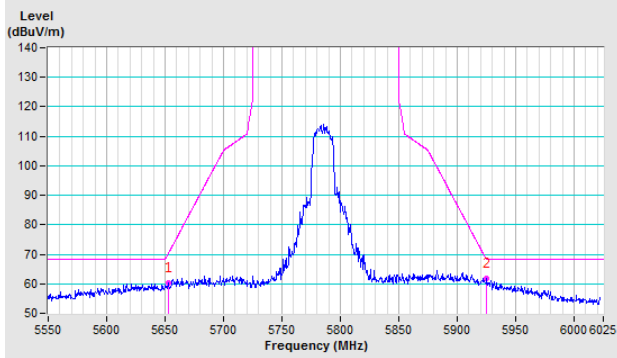

Vertical

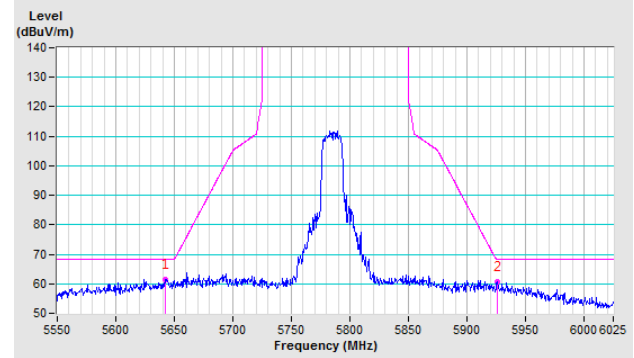

CH 165 5825 MHz

Horizontal

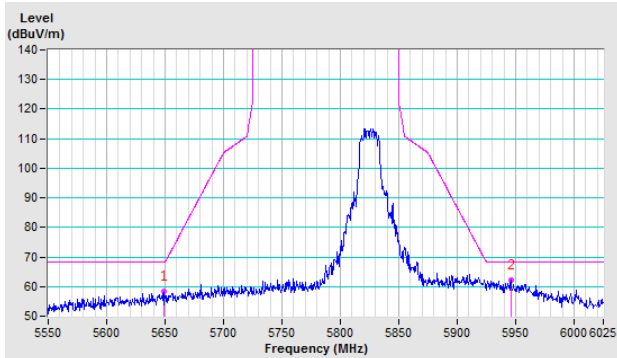

Vertical

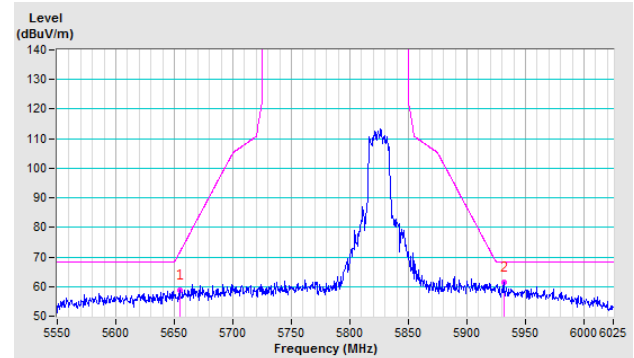

802.11ac (VHT40)

CH 151 5755 MHz

Horizontal

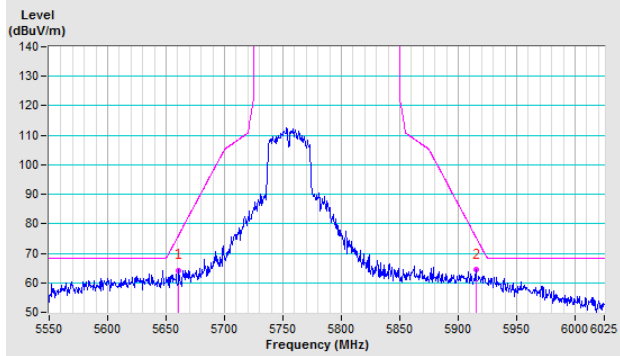

Vertical

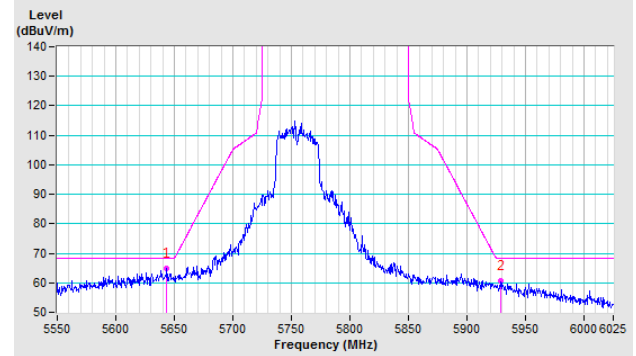

CH 159 5795 MHz

Horizontal

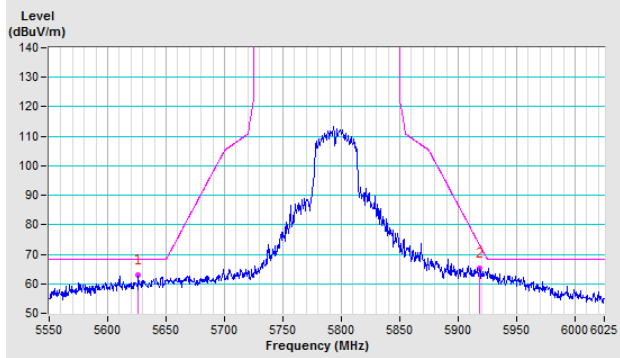

Vertical

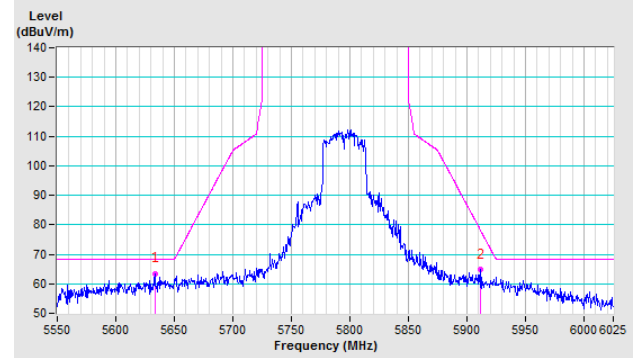

802.11ac (VHT80)

CH 155 5775 MHz

Horizontal

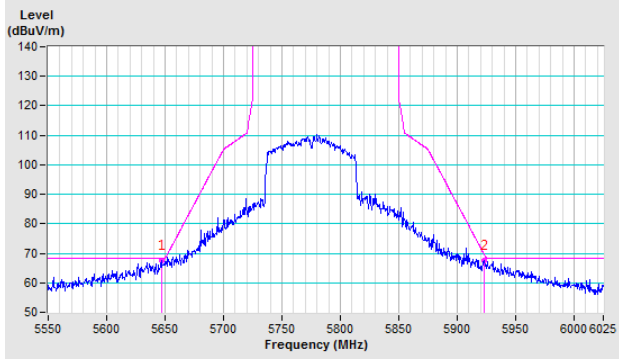

Vertical

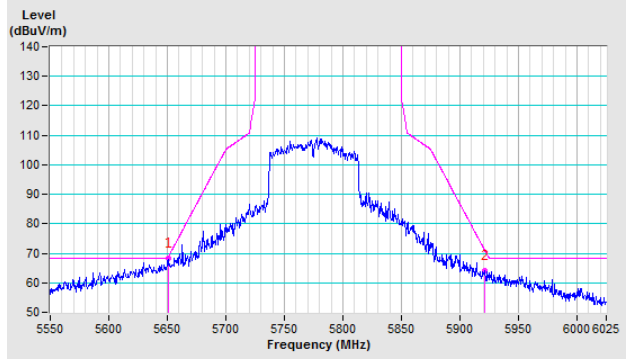

Appendix – Information on the Testing Laboratories

We, Bureau Veritas Consumer Products Services (H.K.) Ltd., Taoyuan Branch, were founded in 1988 to provide our best service in EMC, Radio, Telecom and Safety consultation. Our laboratories are FCC recognized accredited test firms and accredited according to ISO/IEC 17025.

If you have any comments, please feel free to contact us at the following:

Linko EMC/RF Lab

Tel: 886-2-26052180

Fax: 886-2-26051924

Hsin Chu EMC/RF/Telecom Lab

Tel: 886-3-6668565

Fax: 886-3-6668323

Hwa Ya EMC/RF/Safety Lab

Tel: 886-3-3183232

Fax: 886-3-3270892

Email: service.adt@tw.bureauveritas.com

Web Site: www.bureauveritas-adt.com

The address and road map of all our labs can be found in our web site also.

--- END ---