

FCC Test Report

Report No.: RF200320E01-1

FCC ID: I88C4000LZ

Test Model: C4000LZ

Received Date: Mar. 20, 2020

Test Date: Apr. 12 to 30, 2020

Issued Date: May 28, 2020

Applicant: Zyxel Communications Corporation

Address: No.2 Industry East RD. IX, Hsinchu Science Park, Hsinchu 30075, Taiwan

Issued By: Bureau Veritas Consumer Products Services (H.K.) Ltd., Taoyuan Branch
Hsin Chu Laboratory

Lab Address: E-2, No.1, Li Hsin 1st Road, Hsinchu Science Park, Hsinchu City 300,
Taiwa.

Test Location: E-2, No.1, Li Hsin 1st Road, Hsinchu Science Park, Hsinchu City 300,
Taiwan.

**FCC Registration /
Designation Number:** 723255 / TW2022



This report is for your exclusive use. Any copying or replication of this report to or for any other person or entity, or use of our name or trademark, is permitted only with our prior written permission. This report sets forth our findings solely with respect to the test samples identified herein. The results set forth in this report are not indicative or representative of the quality or characteristics of the lot from which a test sample was taken or any similar or identical product unless specifically and expressly noted. Our report includes all of the tests requested by you and the results thereof based upon the information that you provided to us. You have 60 days from date of issuance of this report to notify us of any material error or omission caused by our negligence, provided, however, that such notice shall be in writing and shall specifically address the issue you wish to raise. A failure to raise such issue within the prescribed time shall constitute your unqualified acceptance of the completeness of this report, the tests conducted and the correctness of the report contents. Unless specific mention, the uncertainty of measurement has been explicitly taken into account to declare the compliance or non-compliance to the specification. The report must not be used by the client to claim product certification, approval, or endorsement by TAF or any government agencies.

Table of Contents

Release Control Record	4
1 Certificate of Conformity	5
2 Summary of Test Results	6
2.1 Measurement Uncertainty	6
2.2 Modification Record	6
3 General Information	7
3.1 General Description of EUT	7
3.2 Description of Test Modes	11
3.2.1 Test Mode Applicability and Tested Channel Detail	12
3.3 Duty Cycle of Test Signal	15
3.4 Description of Support Units	16
3.4.1 Configuration of System under Test	16
3.5 General Description of Applied Standard and references	17
4 Test Types and Results	18
4.1 Radiated Emission and Bandedge Measurement	18
4.1.1 Limits of Radiated Emission and Bandedge Measurement	18
4.1.2 Test Instruments	19
4.1.3 Test Procedure	23
4.1.4 Deviation from Test Standard	24
4.1.5 Test Setup	24
4.1.6 EUT Operating Condition	25
4.1.7 Test Results (Mode 1)	26
4.1.8 Test Results (Mode 2)	46
4.1.9 Test Results (Mode 3)	48
4.2 Conducted Emission Measurement	50
4.2.1 Limits of Conducted Emission Measurement	50
4.2.2 Test Instruments	50
4.2.3 Test Procedure	51
4.2.4 Deviation from Test Standard	51
4.2.5 Test Setup	51
4.2.6 EUT Operating Condition	51
4.2.7 Test Results (Mode 1)	52
4.2.8 Test Results (Mode 2)	54
4.2.9 Test Results (Mode 3)	56
4.3 Transmit Power Measurement	58
4.3.1 Limits of Transmit Power Measurement	58
4.3.2 Test Setup	58
4.3.3 Test Instruments	58
4.3.4 Test Procedure	58
4.3.5 Deviation from Test Standard	58
4.3.6 EUT Operating Condition	58
4.3.7 Test Results	59
4.4 Occupied Bandwidth Measurement	63
4.4.1 Test Setup	63
4.4.2 Test Instruments	63
4.4.3 Test Procedure	63
4.4.4 Test Results	64
4.5 Peak Power Spectral Density Measurement	68
4.5.1 Limits of Peak Power Spectral Density Measurement	68
4.5.2 Test Setup	68
4.5.3 Test Instruments	68
4.5.4 Test Procedure	68
4.5.5 Deviation from Test Standard	69

4.5.6 EUT Operating Condition	69
4.5.7 Test Results	70
4.6 Frequency Stability Measurement.....	74
4.6.1 Limits of Frequency Stability Measurement	74
4.6.2 Test Setup.....	74
4.6.3 Test Instruments	74
4.6.4 Test Procedure	74
4.6.5 Deviation from Test Standard	74
4.6.6 EUT Operating Condition	74
4.6.7 Test Results	75
4.7 6dB Bandwidth Measurement	76
4.7.1 Limits of 6dB Bandwidth Measurement.....	76
4.7.2 Test Setup.....	76
4.7.3 Test Instruments	76
4.7.4 Test Procedure	76
4.7.5 Deviation from Test Standard	76
4.7.6 EUT Operating Condition	76
4.7.7 Test Results	77
5 Pictures of Test Arrangements.....	79
Annex A- Radiated Out of Band Emission (OOBE) Measurement (For U-NII-3 band)	80
Annex B- Band-edge measurement (For U-NII-1 band)	83
Appendix – Information of the Testing Laboratories	87

Release Control Record

Issue No.	Description	Date Issued
RF200320E01-1	Original release.	May 28, 2020

1 Certificate of Conformity

Product: Dual-Band Wireless AX VDSL2 Gigabit Gateway

Brand: CenturyLink, ZYXEL

Test Model: C4000LZ

Sample Status: ENGINEERING SAMPLE

Applicant: Zyxel Communications Corporation

Test Date: Apr. 12 to 30, 2020

Standard: 47 CFR FCC Part 15, Subpart E (Section 15.407)
ANSI C63.10: 2013

The above equipment has been tested by **Bureau Veritas Consumer Products Services (H.K.) Ltd., Taoyuan Branch**, and found compliance with the requirement of the above standards. The test record, data evaluation & Equipment Under Test (EUT) configurations represented herein are true and accurate accounts of the measurements of the sample's EMC characteristics under the conditions specified in this report.

Prepared by :



Joyce Kuo / Specialist

Date:

May 28, 2020

Approved by :



Clark Lin / Technical Manager

Date:

May 28, 2020

2 Summary of Test Results

47 CFR FCC Part 15, Subpart E (Section 15.407)			
FCC Clause	Test Item	Result	Remarks
15.407(b)(6)	AC Power Conducted Emissions	Pass	Meet the requirement of limit. Minimum passing margin is -14.07dB at 0.16172MHz.
15.407(b) (1/2/3/4(i/ii)/6)	Radiated Emissions & Band Edge Measurement*	Pass	Meet the requirement of limit. Minimum passing margin is -0.5dB at 5150.00MHz.
15.407(a)(1/2/3)	Max Average Transmit Power	Pass	Meet the requirement of limit.
---	Occupied Bandwidth Measurement	-	Reference only.
15.407(a)(1/2/3)	Peak Power Spectral Density	Pass	Meet the requirement of limit.
15.407(e)	6dB bandwidth	Pass	Meet the requirement of limit. (U-NII-3 Band only)
15.407(g)	Frequency Stability	Pass	Meet the requirement of limit.
15.203	Antenna Requirement	Pass	Antenna connector is i-pex(MHF) not a standard connector.

Note:

1. For U-NII-3 band compliance with rule part 15.407(b)(4)(i), the OOB test plots were recorded in Annex A.
2. For U-NII-1 band compliance with rule 15.407(b) of the band-edge items, the test plots were recorded in Annex B. Test Procedures refer to report 4.1.3.
3. Determining compliance based on the results of the compliance measurement, not taking into account measurement instrumentation uncertainty.

2.1 Measurement Uncertainty

Where relevant, the following measurement uncertainty levels have been estimated for tests performed on the EUT as specified in CISPR 16-4-2:

Measurement	Frequency	Expanded Uncertainty (k=2) (±)
Conducted Emissions at mains ports	150kHz ~ 30MHz	1.9 dB
Radiated Emissions up to 1 GHz	9kHz ~ 30MHz	3.1 dB
	30MHz ~ 1GHz	5.1 dB
Radiated Emissions above 1 GHz	1GHz ~ 18GHz	5.1 dB
	18GHz ~ 40GHz	5.3 dB

2.2 Modification Record

There were no modifications required for compliance.

3 General Information

3.1 General Description of EUT

Product	Dual-Band Wireless AX VDSL2 Gigabit Gateway
Brand	CenturyLink, ZYXEL
Test Model	C4000LZ
CPU Model No.	GRX350
RF Chip Model No.	WAV654
Status of EUT	ENGINEERING SAMPLE
Power Supply Rating	12Vdc from adapter
Modulation Type	CCK, DQPSK, DBPSK for DSSS 64QAM, 16QAM, QPSK, BPSK for OFDM 256QAM for OFDM in 11ac mode and VHT20/40 in 2.4GHz 1024QAM for OFDMA in 11ax HE mode
Modulation Technology	DSSS, OFDM, OFDMA
Transfer Rate	802.11b: up to 11 Mbps 802.11a/g: up to 54 Mbps 802.11n: up to 300 Mbps 802.11ac: up to 866.7 Mbps 802.11ax: up to 1201.0 Mbps
Operating Frequency	2.4GHz: 2.412GHz ~ 2.462GHz 5GHz: 5.18 ~ 5.24GHz, 5.745 ~ 5.825GHz
Number of Channel	2.4GHz: 802.11b, 802.11g, 802.11n (HT20), VHT20, 80211ax (HE20): 11 802.11n (HT40), VHT40, 80211ax (HE40): 7 5GHz: 802.11a, 802.11n (HT20), 802.11ac (VHT20), 80211ax (HE20): 9 802.11n (HT40), 802.11ac (VHT40), 80211ax (HE40): 4 802.11ac (VHT80), 80211ax (HE80): 2
Output Power	Non-Beamforming Mode: 2.412 ~ 2.462 GHz: 832.061 mW 5.18 ~ 5.24 GHz: 827.149 mW 5.745 ~ 5.825 GHz: 945.395 mW Beamforming Mode: 2.412 ~ 2.462 GHz: 759.637 mW 5.18 ~ 5.24 GHz: 827.149 mW 5.745 ~ 5.825 GHz: 835.929 mW
Antenna Type	Refer to Note
Antenna Connector	Refer to Note
Accessory Device	- AC Adaptor, Brand:UMEC, Model:UP0251M-12PA - AC Adaptor, Brand:DVE, Model:DSA-24PFS-12 FUS 120200 - AC Adaptor, Brand:MNC, Model:MAUS-120200 - Ethernet Cable , Non-shielded, 1.8m x1 - DSL cable , Non-shielded, 3.66m x1

Note:

- The EUT has below brand names, which are identical to each other in all aspects except for the following table:

Brand	Model	Difference
CenturyLink	C4000LZ	Different brand names are for marketing purpose.
ZYXEL		

2. The EUT has two radios as following table:

Radio 1	Radio 2
WLAN 2.4GHz	WLAN 5GHz

3. Simultaneously transmission condition.

Condition	Technology	
1	WLAN (2.4GHz)	WLAN 5GHz

Note: The emission of the simultaneous operation has been evaluated and no non-compliance was found.

4. The EUT must be supplied one power adapter and following different models could be chosen as following table:

No.	Brand	Model No.	Spec.
1	UMEC	UP0251M-12PA	Input: 100-240Vac, 0.6A, 50/60Hz Output: 12V, 2A DC Output cable: Unshielded, 1.8m
2	DVE	DSA-24PFS-12 FUS 120200	Input: 100-240Vac, 0.8A, 50/60Hz Output: 12V, 2A DC Output cable: Unshielded, 1.8m
3	MNC	MAUS-120200	Input: 100-240Vac, 0.7A, 50/60Hz Output: 12V, 2A DC Output cable: Unshielded, 1.8m

5. The antennas provided to the EUT, please refer to the following table:

Antenna NO.	Chain NO.	Brand	Antenna Net Gain(dBi)	Frequency range	Antenna Type	Connector Type	Cable Length(mm)
2G_ANT1	Chain 0	M.gear	2.48	2.4~2.4835GHz	Dipole	i-pex(MHF)	150
2G_ANT2	Chain 1	M.gear	2.77	2.4~2.4835GHz	Dipole	i-pex(MHF)	150
5G_ANT1	Chain 0	M.gear	3.36	5.15~5.25GHz	Dipole	i-pex(MHF)	150
			3.45	5.25~5.35GHz			
			3.44	5.47~5.725GHz			
			3.36	5.725~5.85GHz			
5G_ANT2	Chain 0	M.gear	3.41	5.15~5.25GHz	Dipole	i-pex(MHF)	150
			3.18	5.25~5.35GHz			
			3.47	5.47~5.725GHz			
			3.47	5.725~5.85GHz			

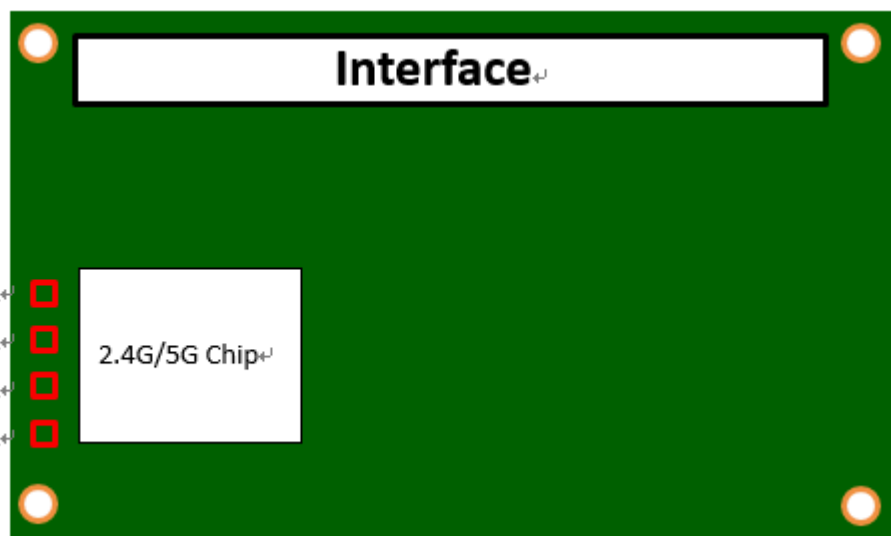

* Antenna port location

6. The EUT incorporates a MIMO function:

2.4GHz Band		
MODULATION MODE	TX & RX CONFIGURATION	
802.11b	1Tx Fixed Chain 0	2RX
802.11g	2TX	2RX
802.11n (HT20)	2TX	2RX
802.11n (HT40)	2TX	2RX
VHT20	2TX	2RX
VHT40	2TX	2RX
802.11ax (HE20)	2TX	2RX
802.11ax (HE40)	2TX	2RX
5GHz Band		
MODULATION MODE	TX & RX CONFIGURATION	
802.11a	2TX	2TX
802.11n (HT20)	2TX	2TX
802.11n (HT40)	2TX	2TX
802.11ac (VHT20)	2TX	2TX
802.11ac (VHT40)	2TX	2TX
802.11ac (VHT80)	2TX	2TX
802.11ax (HE20)	2TX	2TX
802.11ax (HE40)	2TX	2TX
802.11ax (HE80)	2TX	2TX

Note:

1. All of modulation mode support beamforming function except 802.11a/b/g modulation mode.
2. The EUT support Beamforming and non-beamforming mode, therefore both mode were investigated and the worst case scenario was identified. The worst case data were presented in test report.
3. The modulation and bandwidth are similar for 802.11n mode for 20MHz (40MHz) and 802.11ac mode for 20MHz (40MHz), the manufacturer will control the power for 802.11n mode is the same as the 802.11ac or more lower than it and investigated worst case to representative mode in test report. (Final test mode refer to section 3.2.1)

7. The power setting are list as below:

Non-Beamforming Mode													
802.11a		802.11ac (VHT20)		802.11ac (VHT40)		802.11ac (VHT80)		802.11ax (HE20)		802.11ax (HE40)		802.11ax (HE80)	
Freq. (MHz)	Power Setting	Freq. (MHz)	Power Setting	Freq. (MHz)	Power Setting	Freq. (MHz)	Power Setting	Freq. (MHz)	Power Setting	Freq. (MHz)	Power Setting	Freq. (MHz)	Power Setting
5180	25	5180	25	5190	19.5	5210	18	5180	25	5190	19.5	5210	18
5200	28	5200	28	5230	27	5775	23	5200	28	5230	27	5775	23
5240	27	5240	27	5755	27			5240	27	5755	27		
5745	27	5745	27	5795	26.5			5745	27	5795	26.5		
5785	27	5785	27					5785	27				
5825	27	5825	27					5825	27				
Beamforming Mode													
802.11ac (VHT20)		802.11ac (VHT40)		802.11ac (VHT80)		802.11ax (HE20)		802.11ax (HE40)		802.11ax (HE80)			
Freq. (MHz)	Power Setting	Freq. (MHz)	Power Setting	Freq. (MHz)	Power Setting	Freq. (MHz)	Power Setting	Freq. (MHz)	Power Setting	Freq. (MHz)	Power Setting	Freq. (MHz)	Power Setting
5180	25	5190	19.5	5210	18	5180	25	5190	19.5	5210	18		
5200	28	5230	27	5775	23	5200	28	5230	27	5775	23		
5240	27	5755	27			5240	27	5755	26.5				
5745	26.5	5795	26.5			5745	26.5	5795	26.5				
5785	26.5					5785	26.5						
5825	26.5					5825	26.5						

8. The above EUT information is declared by manufacturer and for more detailed features description, please refers to the manufacturer's specifications or user's manual.

3.2 Description of Test Modes

FOR 5180 ~ 5240MHz

4 channels are provided for 802.11a, 802.11n (HT20), 802.11ac (VHT20):

Channel	Frequency	Channel	Frequency
36	5180 MHz	44	5220 MHz
40	5200 MHz	48	5240 MHz

2 channels are provided for 802.11n (HT40), 802.11ac (VHT40):

Channel	Frequency	Channel	Frequency
38	5190 MHz	46	5230 MHz

1 channel is provided for 802.11ac (VHT80):

Channel	Frequency
42	5210 MHz

FOR 5745 ~ 5825MHz:

5 channels are provided for 802.11a, 802.11n (HT20), 802.11ac (VHT20):

Channel	Frequency	Channel	Frequency
149	5745 MHz	161	5805 MHz
153	5765 MHz	165	5825 MHz
157	5785 MHz		

2 channels are provided for 802.11n (HT40), 802.11ac (VHT40):

Channel	Frequency	Channel	Frequency
151	5755 MHz	159	5795 MHz

1 channel is provided for 802.11ac (VHT80):

Channel	Frequency
155	5775 MHz

3.2.1 Test Mode Applicability and Tested Channel Detail

EUT Configure Mode	Applicable To				Description
	RE \geq 1G	RE<1G	PLC	APCM	
1	√	√	√	√	Adapter 3
2	-	√	√	-	Adapter 2
3	-	√	√	-	Adapter 1

Where **RE \geq 1G**: Radiated Emission above 1GHz **RE<1G**: Radiated Emission below 1GHz
PLC: Power Line Conducted Emission **APCM**: Antenna Port Conducted Measurement

Radiated Emission Test (Above 1GHz):

- Pre-Scan has been conducted to determine the worst-case mode from all possible combinations between available modulations, data rates and antenna ports (if EUT with antenna diversity architecture).
- Following channel(s) was (were) selected for the final test as listed below.

Non-Beamforming Mode						
Mode	FREQ. Band (MHz)	Available Channel	Tested Channel	Modulation Technology	Modulation Type	Data Rate Parameter
802.11a	5180-5240	36 to 48	36, 40, 48	OFDM	BPSK	6Mb/s
802.11ax (HE20)		36 to 48	36, 40, 48	OFDMA	BPSK	MCS0
802.11ax (HE40)		38 to 46	38, 46	OFDMA	BPSK	MCS0
802.11ax (HE80)		42	42	OFDMA	BPSK	MCS0
802.11a	5745-5825	149 to 165	149, 157, 165	OFDM	BPSK	6Mb/s
802.11ax (HE20)		149 to 165	149, 157, 165	OFDMA	BPSK	MCS0
802.11ax (HE40)		151 to 159	151, 159	OFDMA	BPSK	MCS0
802.11ax (HE80)		155	155	OFDMA	BPSK	MCS0

Radiated Emission Test (Below 1GHz):

- Pre-Scan has been conducted to determine the worst-case mode from all possible combinations between available modulations, data rates and antenna ports (if EUT with antenna diversity architecture).
- Following channel(s) was (were) selected for the final test as listed below.

Non-Beamforming Mode						
Mode	FREQ. Band (MHz)	Available Channel	Tested Channel	Modulation Technology	Modulation Type	Data Rate Parameter
802.11ax (HE40)	5180-5240 5745-5825	38 to 46 151 to 159	151	OFDMA	BPSK	MCS0

Power Line Conducted Emission Test:

- Pre-Scan has been conducted to determine the worst-case mode from all possible combinations between available modulations, data rates and antenna ports (if EUT with antenna diversity architecture).
- Following channel(s) was (were) selected for the final test as listed below.

Non-Beamforming Mode						
Mode	FREQ. Band (MHz)	Available Channel	Tested Channel	Modulation Technology	Modulation Type	Data Rate Parameter
802.11ax (HE40)	5180-5240 5745-5825	38 to 46 151 to 159	151	OFDMA	BPSK	MCS0

Antenna Port Conducted Measurement:

- This item includes all test value of each mode, but only includes spectrum plot of worst value of each mode.
- Pre-Scan has been conducted to determine the worst-case mode from all possible combinations between available modulations, data rates and antenna ports (if EUT with antenna diversity architecture).
- Following channel(s) was (were) selected for the final test as listed below.

Non-Beamforming Mode						
Mode	FREQ. Band (MHz)	Available Channel	Tested Channel	Modulation Technology	Modulation Type	Data Rate Parameter
802.11a	5180-5240	36 to 48	36, 40, 48	OFDM	BPSK	6Mb/s
802.11ac (VHT20) (for output power)		36 to 48	36, 40, 48	OFDM	BPSK	MCS0
802.11ac (VHT40) (for output power)		38 to 46	38, 46	OFDM	BPSK	MCS0
802.11ac (VHT80) (for output power)		42	42	OFDM	BPSK	MCS0
802.11ax (HE20)		36 to 48	36, 40, 48	OFDMA	BPSK	MCS0
802.11ax (HE40)		38 to 46	38, 46	OFDMA	BPSK	MCS0
802.11ax (HE80)		42	42	OFDMA	BPSK	MCS0
802.11a		5745-5825	149 to 165	149, 157, 165	OFDM	BPSK
802.11ac (VHT20) (for output power)	149 to 165		149, 157, 165	OFDM	BPSK	MCS0
802.11ac (VHT40) (for output power)	151 to 159		151, 159	OFDM	BPSK	MCS0
802.11ac (VHT80) (for output power)	155		155	OFDM	BPSK	MCS0
802.11ax (HE20)	149 to 165		149, 157, 165	OFDMA	BPSK	MCS0
802.11ax (HE40)	151 to 159		151, 159	OFDMA	BPSK	MCS0
802.11ax (HE80)	155		155	OFDMA	BPSK	MCS0

Beamforming Mode (output power only)

Mode	FREQ. Band (MHz)	Available Channel	Tested Channel	Modulation Technology	Modulation Type	Data Rate Parameter
802.11ac (VHT20)	5180-5240	36 to 48	36, 40, 48	OFDM	BPSK	MCS0
802.11ac (VHT40)		38 to 46	38, 46	OFDM	BPSK	MCS0
802.11ac (VHT80)		42	42	OFDM	BPSK	MCS0
802.11ax (HE20)		36 to 48	36, 40, 48	OFDMA	BPSK	MCS0
802.11ax (HE40)		38 to 46	38, 46	OFDMA	BPSK	MCS0
802.11ax (HE80)		42	42	OFDMA	BPSK	MCS0
802.11ac (VHT20)	5745-5825	149 to 165	149, 157, 165	OFDM	BPSK	MCS0
802.11ac (VHT40)		151 to 159	151, 159	OFDM	BPSK	MCS0
802.11ac (VHT80)		155	155	OFDM	BPSK	MCS0
802.11ax (HE20)		149 to 165	149, 157, 165	OFDMA	BPSK	MCS0
802.11ax (HE40)		151 to 159	151, 159	OFDMA	BPSK	MCS0
802.11ax (HE80)		155	155	OFDMA	BPSK	MCS0

Test Condition:

Applicable To	Environmental Conditions	Input Power	Tested By
RE \geq 1G	23deg. C, 75%RH	120Vac, 60Hz	Kevien Ko
RE $<$ 1G	21deg. C, 65%RH	120Vac, 60Hz	Ryan Du
PLC	25deg. C, 63%RH	120Vac, 60Hz	Sampson Chen
APCM	25deg. C, 60%RH	120Vac, 60Hz	Anderson Chen

3.3 Duty Cycle of Test Signal

Duty cycle of test signal is 100 %, duty factor is not required.

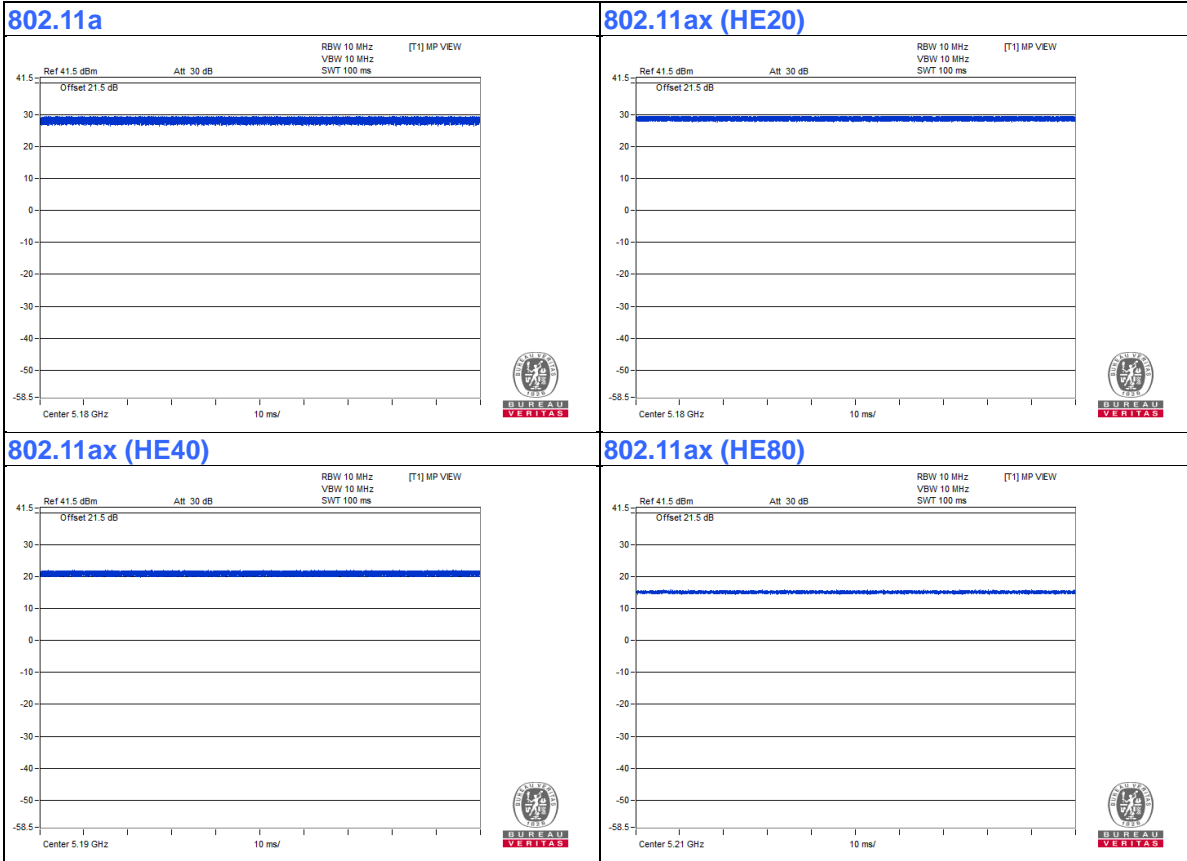

3.4 Description of Support Units

The EUT has been tested as an independent unit together with other necessary accessories or support units. The following support units or accessories were used to form a representative test configuration during the tests.

ID	Product	Brand	Model No.	Serial No.	FCC ID	Remarks
A.	Laptop	DELL	E5430	HYV4VY1	FCC DoC	Provided by Lab

Note:

- All power cords of the above support units are non-shielded (1.8m).

ID	Descriptions	Qty.	Length (m)	Shielding (Yes/No)	Cores (Qty.)	Remarks
1.	DC Cable	1	1.8	No	0	Supplied by client
2.	RJ-45 Cable	1	1.8	No	0	Supplied by client
3.	RJ-45 Cable	1	10	No	0	Provided by Lab

3.4.1 Configuration of System under Test

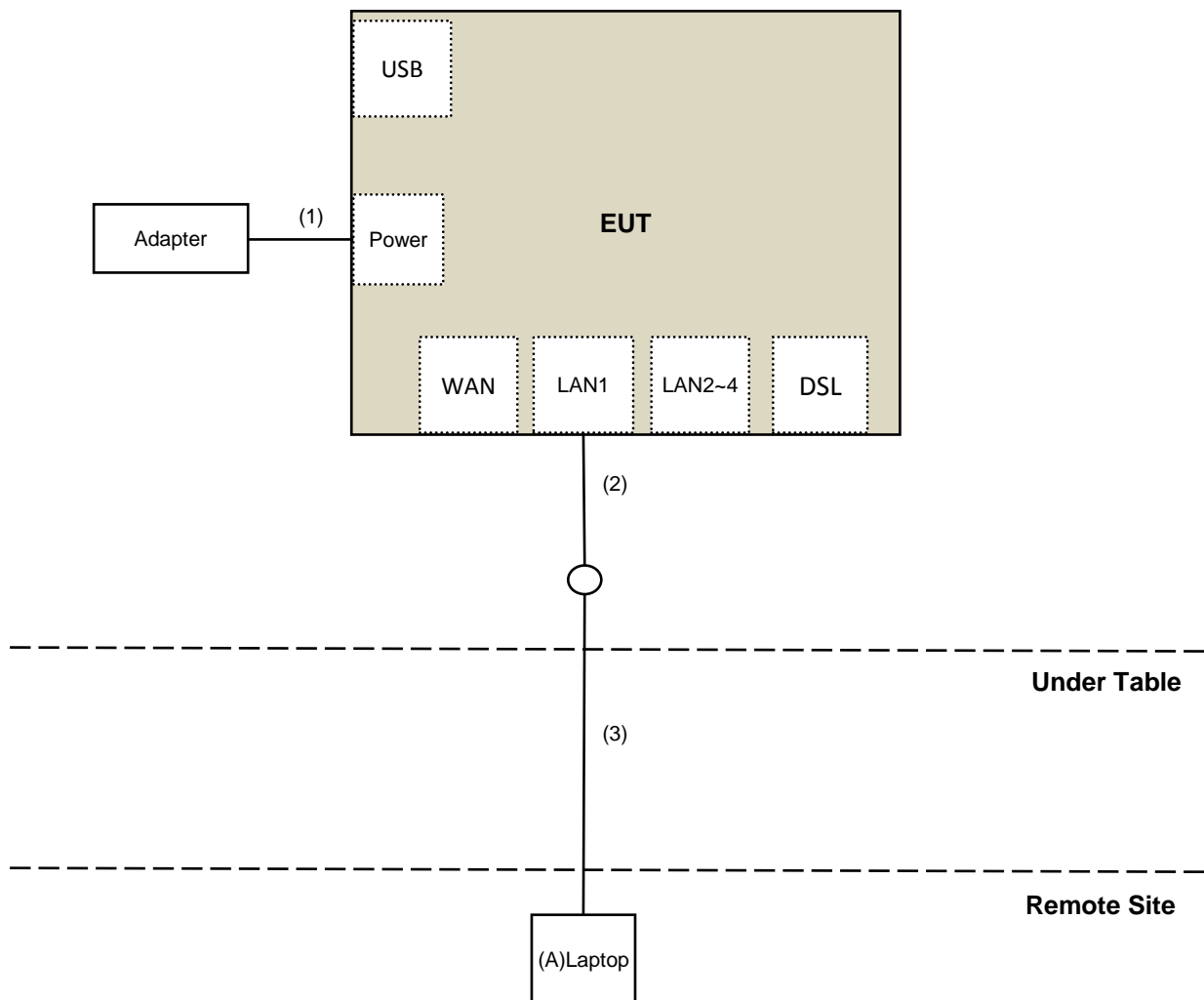

NOTE: The test configuration was defined by the applicant requirement.

3.5 General Description of Applied Standard and references

The EUT is a RF Product. According to the specifications of the manufacturer, it must comply with the requirements of the following standards and references:

Test Standard:

FCC Part 15, Subpart E (15.407)
ANSI C63.10-2013

All test items have been performed and recorded as per the above standards.

References Test Guidance:

KDB 789033 D02 General UNII Test Procedure New Rules v02r01
KDB 662911 D01 Multiple Transmitter Output v02r01

All test items have been performed as a reference to the above KDB test guidance.

4 Test Types and Results

4.1 Radiated Emission and Bandedge Measurement

4.1.1 Limits of Radiated Emission and Bandedge Measurement

Radiated emissions which fall in the restricted bands must comply with the radiated emission limits specified as below table.

Frequencies (MHz)	Field Strength (microvolts/meter)	Measurement Distance (meters)
0.009 ~ 0.490	2400/F(kHz)	300
0.490 ~ 1.705	24000/F(kHz)	30
1.705 ~ 30.0	30	30
30 ~ 88	100	3
88 ~ 216	150	3
216 ~ 960	200	3
Above 960	500	3

NOTE:

1. The lower limit shall apply at the transition frequencies.
2. Emission level (dBuV/m) = 20 log Emission level (uV/m).
3. For frequencies above 1000MHz, the field strength limits are based on average detector, however, the peak field strength of any emission shall not exceed the maximum permitted average limits, specified above by more than 20dB under any condition of modulation.

Limits of unwanted emission out of the restricted bands

Applicable To		Limit	
789033 D02 General UNII Test Procedure New Rules v02r01		Field Strength at 3m	
		PK:74 (dBuV/m)	AV:54 (dBuV/m)
Frequency Band	Applicable To	EIRP Limit	Equivalent Field Strength at 3m
5150~5250 MHz	15.407(b)(1)	PK:-27 (dBm/MHz)	PK:68.2(dBuV/m)
5250~5350 MHz	15.407(b)(2)		
5470~5725 MHz	15.407(b)(3)		
5725~5850 MHz	15.407(b)(4)(i)	PK:-27 (dBm/MHz) ^{*1} PK:10 (dBm/MHz) ^{*2} PK:15.6 (dBm/MHz) ^{*3} PK:27 (dBm/MHz) ^{*4}	PK: 68.2(dBuV/m) ^{*1} PK:105.2 (dBuV/m) ^{*2} PK: 110.8(dBuV/m) ^{*3} PK:122.2 (dBuV/m) ^{*4}
^{*1} beyond 75 MHz or more above of the band edge.		^{*2} below the band edge increasing linearly to 10 dBm/MHz at 25 MHz above.	
^{*3} below the band edge increasing linearly to a level of 15.6 dBm/MHz at 5 MHz above.		^{*4} from 5 MHz above or below the band edge increasing linearly to a level of 27 dBm/MHz at the band edge.	

Note:

The following formula is used to convert the equipment isotropic radiated power (eirp) to field strength:

$$E = \frac{1000000\sqrt{30P}}{3} \mu\text{V/m, where P is the eirp (Watts).}$$

4.1.2 Test Instruments

For Radiated emission test (Above 1GHz)

DESCRIPTION & MANUFACTURER	MODEL NO.	SERIAL NO.	CALIBRATED DATE	CALIBRATED UNTIL
Test Receiver ESR7 R&S	ESR7	102026	Apr. 22, 2020	Apr. 21, 2021
Spectrum Analyzer Keysight	N9030B	MY57141948	May 25, 2019	May 24, 2020
Horn_Antenna SCHWARZBECK	BBHA 9120D	9120D-1819	Nov. 24, 2019	Nov. 23, 2020
Pre-Amplifier EMCI	EMC12630SE	980509	Apr. 29, 2020	Apr. 28, 2021
RF Cable EMCI	EMC104-SM-SM-1500	180503	Apr. 29, 2020	Apr. 28, 2021
RF Cable EMCI	EMC104-SM-SM-2000	180501	Apr. 29, 2020	Apr. 28, 2021
RF Cable EMCI	EMC104-SM-SM-6000	180506	Apr. 29, 2020	Apr. 28, 2021
Pre-Amplifier EMCI	EMC184045SE	980387	Jan. 15, 2020	Jan. 14, 2021
Horn_Antenna SCHWARZBECK	BBHA 9170	BBHA9170519	Nov. 24, 2019	Nov. 23, 2020
RF Cable	EMC102-KM-KM-1200	160924	Jan. 15, 2020	Jan. 14, 2021
RF Cable	EMC-KM-KM-4000	200214	Mar. 11, 2020	Mar. 10, 2021
Software	ADT_Radiated_V8.7.08	NA	NA	NA
Boresight Antenna Tower & Turn Table Max-Full	MF-7802BS	MF780208530	NA	NA

Note:

1. The calibration interval of the above test instruments is 12 months and the calibrations are traceable to NML/ROC and NIST/USA.
2. The test was performed in 966 Chamber No. 5.
3. Loop antenna was used for all emissions below 30 MHz.
4. Tested Date: Apr. 29, 2020

For Radiated emission test (Below 1GHz)

DESCRIPTION & MANUFACTURER	MODEL NO.	SERIAL NO.	CALIBRATED DATE	CALIBRATED UNTIL
Test Receiver ESR7 R&S	ESR7	102026	Apr. 24, 2019	Apr. 23, 2020
Spectrum Analyzer Keysight	N9030B	MY57141948	May 25, 2019	May 24, 2020
Pre-Amplifier EMCI	EMC001340	980142	May 30, 2019	May 29, 2020
Loop Antenna Electro-Metrics	EM-6879	264	Feb. 18, 2020	Feb. 17, 2021
RF Cable	NA	LOOPCAB-001	Jan. 08, 2020	Jan. 07, 2021
RF Cable	NA	LOOPCAB-002	Jan. 08, 2020	Jan. 07, 2021
Pre-Amplifier EMCI	EMC330N	980538	Apr. 30, 2019	Apr. 29, 2020
Trilog Broadband Antenna SCHWARZBECK	VULB9168	9168-0842	Nov. 08, 2019	Nov. 07, 2020
RF Cable	8D	966-5-1	May 03, 2019	May 02, 2020
RF Cable	8D	966-5-2	May 03, 2019	May 02, 2020
RF Cable	8D	966-5-3	May 03, 2019	May 02, 2020
Fixed attenuator Mini-Circuits	UNAT-5+	PAD-ATT5-02	Jan. 14, 2020	Jan. 13, 2021
Software	ADT_Radiated_V8.7.08	NA	NA	NA
Boresight Antenna Tower & Turn Table Max-Full	MF-7802BS	MF780208530	NA	NA

Note:

1. The calibration interval of the above test instruments is 12 months and the calibrations are traceable to NML/ROC and NIST/USA.
2. The test was performed in 966 Chamber No. 5.
3. Loop antenna was used for all emissions below 30 MHz.
4. Tested Date: Apr. 13 to 15, 2020

For Bandedge test

DESCRIPTION & MANUFACTURER	MODEL NO.	SERIAL NO.	CALIBRATED DATE	CALIBRATED UNTIL
Test Receiver ESR7 R&S	ESR7	102026	Apr. 24, 2019	Apr. 23, 2020
Spectrum Analyzer Keysight	N9030B	MY57141948	May 25, 2019	May 24, 2020
Horn_Antenna SCHWARZBECK	BBHA 9120D	9120D-1819	Nov. 24, 2019	Nov. 23, 2020
Pre-Amplifier EMCI	EMC12630SE	980509	May 03, 2019	May 02, 2020
RF Cable EMCI	EMC104-SM-SM-1500	180503	May 03, 2019	May 02, 2020
RF Cable EMCI	EMC104-SM-SM-2000	180501	May 03, 2019	May 02, 2020
RF Cable EMCI	EMC104-SM-SM-6000	180506	May 03, 2019	May 02, 2020
Pre-Amplifier EMCI	EMC184045SE	980387	Jan. 15, 2020	Jan. 14, 2021
Horn_Antenna SCHWARZBECK	BBHA 9170	BBHA9170519	Nov. 24, 2019	Nov. 23, 2020
RF Cable	EMC102-KM-KM-1200	160924	Jan. 15, 2020	Jan. 14, 2021
RF Cable	EMC-KM-KM-4000	200214	Mar. 11, 2020	Mar. 10, 2021
Software	ADT_Radiated_V8.7.08	NA	NA	NA
Boresight Antenna Tower & Turn Table Max-Full	MF-7802BS	MF780208530	NA	NA

Note:

1. The calibration interval of the above test instruments is 12 months and the calibrations are traceable to NML/ROC and NIST/USA.
2. The test was performed in 966 Chamber No. 5.
3. Loop antenna was used for all emissions below 30 MHz.
4. Tested Date: Apr. 12, 2020

For other test

DESCRIPTION & MANUFACTURER	MODEL NO.	SERIAL NO.	CALIBRATED DATE	CALIBRATED UNTIL
Spectrum Analyzer R&S	FSV40	100964	June 04, 2019	June 03, 2020
Power meter Anritsu	ML2495A	1014008	May 13, 2019	May 12, 2020
Power sensor Anritsu	MA2411B	0917122	May 13, 2019	May 12, 2020
Fixed Attenuator Mini-Circuits	MDCS18N-10	MDCS18N-10-01	Apr. 14, 2020	Apr. 13, 2021
AC Power Source Extech Electronics	6205	1440452	NA	NA
Temperature & Humidity Chamber Giant Force	GTH-150-40-SP-AR	MAA0812-008	Jan. 16, 2020	Jan. 15, 2021
True RMS Clamp Meter FLUKE	325	31130711WS	May 21, 2019	May 20, 2020

Note:

1. 1. The test was performed in Oven room 2.
2. 2. The calibration interval of the above test instruments is 12 months and the calibrations are traceable to NML/ROC and NIST/USA.
3. 3. Tested Date: Apr. 29 to 30, 2020

4.1.3 Test Procedure

For Radiated emission below 30MHz

- a. The EUT was placed on the top of a rotating table 0.8 meters above the ground at a 3 meter chamber room. The table was rotated 360 degrees to determine the position of the highest radiation.
- b. The EUT was set 3 meters away from the interference-receiving antenna, which was mounted on the top of a variable-height antenna tower.
- c. Parallel, perpendicular, and ground-parallel orientations of the antenna are set to make the measurement.
- d. For each suspected emission, the EUT was arranged to its worst case and the rotatable table was turned from 0 degrees to 360 degrees to find the maximum reading.
- e. The test-receiver system was set to Quasi-Peak Detect Function and Specified Bandwidth with Maximum Hold Mode.

Note:

1. The resolution bandwidth and video bandwidth of test receiver/spectrum analyzer is 9kHz at frequency below 30MHz.

For Radiated emission above 30MHz

- a. The EUT was placed on the top of a rotating table 0.8 meters (for 30MHz ~ 1GHz) / 1.5 meters (for above 1GHz) above the ground at 3 meter chamber room for test. The table was rotated 360 degrees to determine the position of the highest radiation.
- b. The EUT was set 3 meters away from the interference-receiving antenna, which was mounted on the top of a variable-height antenna tower.
- c. The height of antenna is varied from one meter to four meters above the ground to determine the maximum value of the field strength. Both horizontal and vertical polarizations of the antenna are set to make the measurement.
- d. For each suspected emission, the EUT was arranged to its worst case and then the antenna was tuned to heights from 1 meter to 4 meters and the rotatable table was turned from 0 degrees to 360 degrees to find the maximum reading.
- e. The test-receiver system was set to quasi-peak detect function and specified bandwidth with maximum hold mode when the test frequency is below 1 GHz.
- f. The test-receiver system was set to peak and average detects function and specified bandwidth with maximum hold mode when the test frequency is above 1 GHz. If the peak reading value also meets average limit, measurement with the average detector is unnecessary.

Note:

1. The resolution bandwidth and video bandwidth of test receiver/spectrum analyzer is 120kHz for Quasi-peak detection (QP) at frequency below 1GHz.
2. The resolution bandwidth of test receiver/spectrum analyzer is 1 MHz and the video bandwidth is 3 MHz for Peak detection (PK) at frequency above 1GHz.
3. The resolution bandwidth of test receiver/spectrum analyzer is 1MHz and the video bandwidth is $\geq 1/T$ (Duty cycle $< 98\%$) or 10Hz (Duty cycle $\geq 98\%$) for Average detection (AV) at frequency above 1GHz.
4. All modes of operation were investigated and the worst-case emissions are reported.

4.1.4 Deviation from Test Standard

No deviation.

4.1.5 Test Setup

For Radiated emission below 30MHz

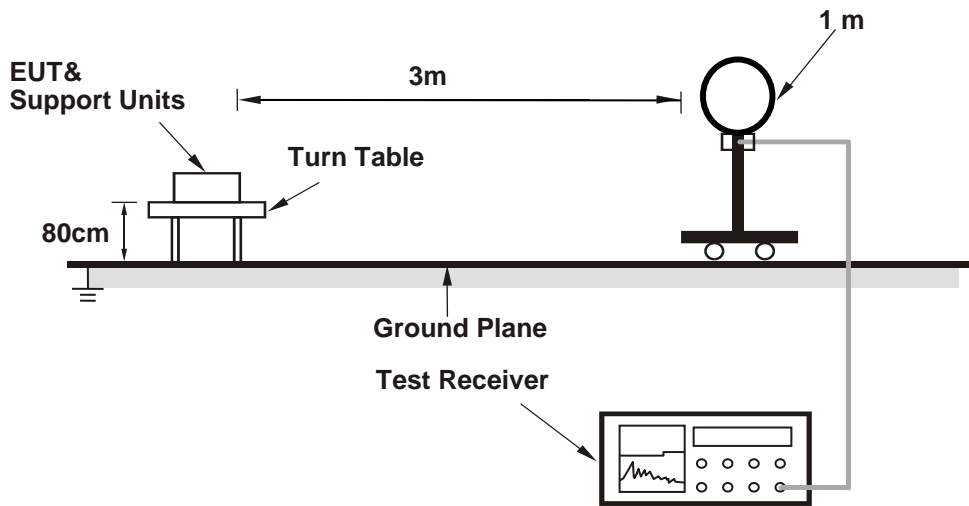

For Radiated emission 30MHz to 1GHz

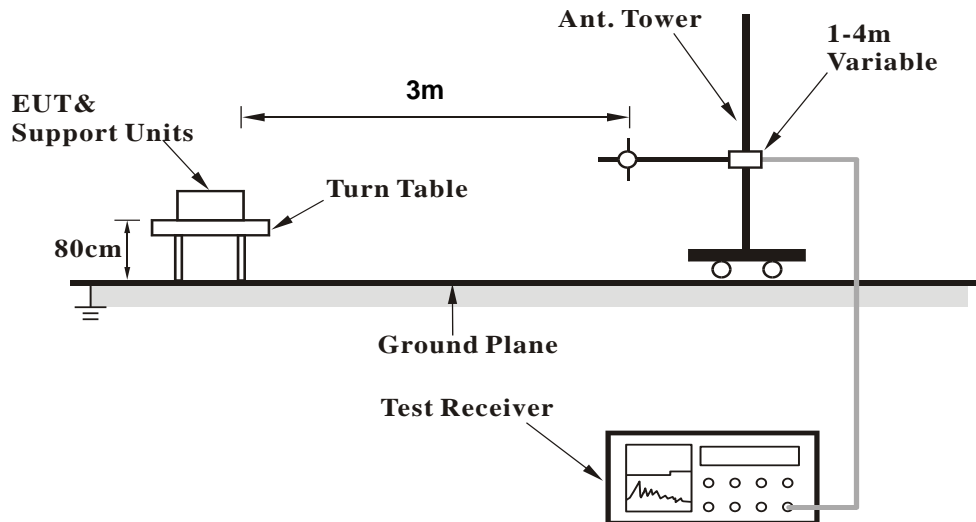

For Radiated emission above 1GHz

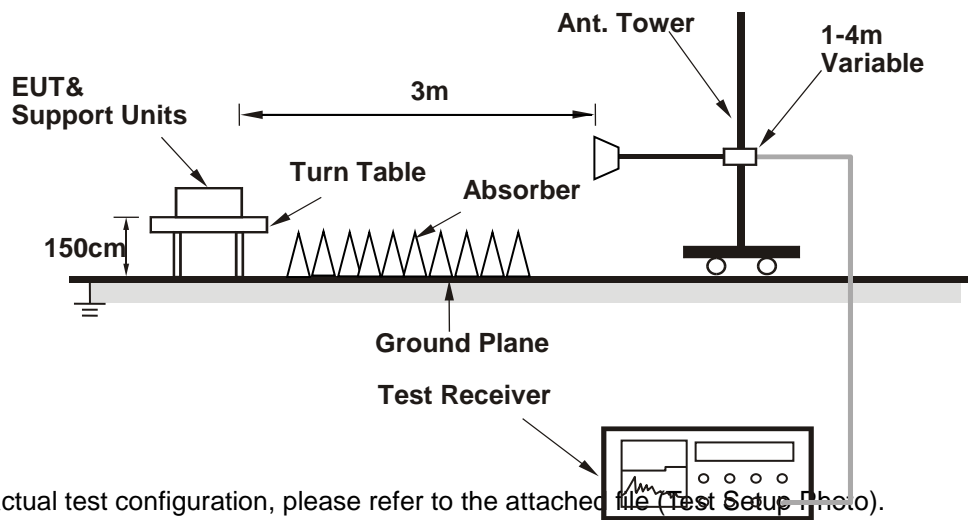

For the actual test configuration, please refer to the attached file (Test Setup Photo).

4.1.6 EUT Operating Condition

- Connected the EUT with the Laptop Computer which is placed on remote site.
- Controlling software (DUT_setup.610.26) has been activated to set the EUT under transmission condition continuously at specific channel frequency.

4.1.7 Test Results (Mode 1)

Above 1GHz Data:

802.11a

CHANNEL	TX Channel 36	DETECTOR FUNCTION	Peak (PK)
FREQUENCY RANGE	1GHz ~ 40GHz		Average (AV)

ANTENNA POLARITY & TEST DISTANCE: HORIZONTAL AT 3 M

NO.	FREQ. (MHz)	EMISSION LEVEL (dBuV/m)	LIMIT (dBuV/m)	MARGIN (dB)	ANTENNA HEIGHT (m)	TABLE ANGLE (Degree)	RAW VALUE (dBuV)	CORRECTION FACTOR (dB/m)
1	5150.00	66.4 PK	74.0	-7.6	2.70 H	33	64.5	1.9
2	5150.00	50.0 AV	54.0	-4.0	2.70 H	33	48.1	1.9
3	*5180.00	119.9 PK			2.70 H	33	118.2	1.7
4	*5180.00	108.4 AV			2.70 H	33	106.7	1.7
5	#10360.00	59.0 PK	68.2	-9.2	2.22 H	299	46.9	12.1
6	15540.00	48.2 PK	74.0	-25.8	1.58 H	64	36.1	12.1
7	15540.00	36.1 AV	54.0	-17.9	1.58 H	64	24.0	12.1

ANTENNA POLARITY & TEST DISTANCE: VERTICAL AT 3 M

NO.	FREQ. (MHz)	EMISSION LEVEL (dBuV/m)	LIMIT (dBuV/m)	MARGIN (dB)	ANTENNA HEIGHT (m)	TABLE ANGLE (Degree)	RAW VALUE (dBuV)	CORRECTION FACTOR (dB/m)
1	5150.00	69.9 PK	74.0	-4.1	1.73 V	236	68.0	1.9
2	5150.00	53.1 AV	54.0	-0.9	1.73 V	236	51.2	1.9
3	*5180.00	120.1 PK			1.73 V	236	118.4	1.7
4	*5180.00	110.3 AV			1.73 V	236	108.6	1.7
5	#10360.00	58.3 PK	68.2	-9.9	2.11 V	304	46.2	12.1
6	15540.00	47.5 PK	74.0	-26.5	1.51 V	85	35.4	12.1
7	15540.00	35.7 AV	54.0	-18.3	1.51 V	85	23.6	12.1

REMARKS:

1. Emission Level(dBuV/m) = Raw Value(dBuV) + Correction Factor(dB/m)
2. Correction Factor(dB/m) = Antenna Factor(dB/m) + Cable Factor(dB) – Pre-Amplifier Factor(dB)
3. Margin value = Emission Level – Limit value
4. The other emission levels were very low against the limit.
5. " * ": Fundamental frequency.
6. " # ": The radiated frequency is out of the restricted band.

CHANNEL	TX Channel 40	DETECTOR FUNCTION	Peak (PK)
FREQUENCY RANGE	1GHz ~ 40GHz		Average (AV)

ANTENNA POLARITY & TEST DISTANCE: HORIZONTAL AT 3 M

NO.	FREQ. (MHz)	EMISSION LEVEL (dBuV/m)	LIMIT (dBuV/m)	MARGIN (dB)	ANTENNA HEIGHT (m)	TABLE ANGLE (Degree)	RAW VALUE (dBuV)	CORRECTION FACTOR (dB/m)
1	5150.00	66.8 PK	74.0	-7.2	2.67 H	40	64.9	1.9
2	5150.00	51.1 AV	54.0	-2.9	2.67 H	40	49.2	1.9
3	*5200.00	120.2 PK			2.67 H	40	118.7	1.5
4	*5200.00	110.5 AV			2.67 H	40	109.0	1.5
5	5350.00	53.4 PK	74.0	-20.6	2.67 H	40	52.0	1.4
6	5350.00	43.1 AV	54.0	-10.9	2.67 H	40	41.7	1.4
7	#10400.00	58.4 PK	68.2	-9.8	2.55 H	233	46.0	12.4
8	15600.00	47.8 PK	74.0	-26.2	1.61 H	172	36.0	11.8
9	15600.00	35.7 AV	54.0	-18.3	1.61 H	172	23.9	11.8

ANTENNA POLARITY & TEST DISTANCE: VERTICAL AT 3 M

NO.	FREQ. (MHz)	EMISSION LEVEL (dBuV/m)	LIMIT (dBuV/m)	MARGIN (dB)	ANTENNA HEIGHT (m)	TABLE ANGLE (Degree)	RAW VALUE (dBuV)	CORRECTION FACTOR (dB/m)
1	5150.00	69.7 PK	74.0	-4.3	1.83 V	234	67.8	1.9
2	5150.00	53.2 AV	54.0	-0.8	1.83 V	234	51.3	1.9
3	*5200.00	122.5 PK			1.83 V	234	121.0	1.5
4	*5200.00	113.1 AV			1.83 V	234	111.6	1.5
5	5350.00	56.0 PK	74.0	-18.0	1.83 V	234	54.6	1.4
6	5350.00	45.5 AV	54.0	-8.5	1.83 V	234	44.1	1.4
7	#10400.00	58.9 PK	68.2	-9.3	2.16 V	290	46.5	12.4
8	15600.00	47.9 PK	74.0	-26.1	1.52 V	73	36.1	11.8
9	15600.00	36.0 AV	54.0	-18.0	1.52 V	73	24.2	11.8

REMARKS:

1. Emission Level(dBuV/m) = Raw Value(dBuV) + Correction Factor(dB/m)
2. Correction Factor(dB/m) = Antenna Factor(dB/m) + Cable Factor(dB) – Pre-Amplifier Factor(dB)
3. Margin value = Emission Level – Limit value
4. The other emission levels were very low against the limit.
5. " * ": Fundamental frequency.
6. " # ": The radiated frequency is out of the restricted band.

CHANNEL	TX Channel 48	DETECTOR FUNCTION	Peak (PK)
FREQUENCY RANGE	1GHz ~ 40GHz		Average (AV)

ANTENNA POLARITY & TEST DISTANCE: HORIZONTAL AT 3 M

NO.	FREQ. (MHz)	EMISSION LEVEL (dBuV/m)	LIMIT (dBuV/m)	MARGIN (dB)	ANTENNA HEIGHT (m)	TABLE ANGLE (Degree)	RAW VALUE (dBuV)	CORRECTION FACTOR (dB/m)
1	*5240.00	119.0 PK			1.56 H	42	117.6	1.4
2	*5240.00	109.9 AV			1.56 H	42	108.5	1.4
3	5350.00	54.0 PK	74.0	-20.0	1.56 H	42	52.6	1.4
4	5350.00	43.3 AV	54.0	-10.7	1.56 H	42	41.9	1.4
5	#10480.00	59.2 PK	68.2	-9.0	2.19 H	305	46.5	12.7
6	15720.00	47.9 PK	74.0	-26.1	1.48 H	75	36.3	11.6
7	15720.00	35.8 AV	54.0	-18.2	1.48 H	75	24.2	11.6

ANTENNA POLARITY & TEST DISTANCE: VERTICAL AT 3 M

NO.	FREQ. (MHz)	EMISSION LEVEL (dBuV/m)	LIMIT (dBuV/m)	MARGIN (dB)	ANTENNA HEIGHT (m)	TABLE ANGLE (Degree)	RAW VALUE (dBuV)	CORRECTION FACTOR (dB/m)
1	*5240.00	121.6 PK			1.82 V	239	120.2	1.4
2	*5240.00	112.0 AV			1.82 V	239	110.6	1.4
3	5350.00	58.8 PK	74.0	-15.2	1.82 V	239	57.4	1.4
4	5350.00	46.9 AV	54.0	-7.1	1.82 V	239	45.5	1.4
5	#10480.00	58.5 PK	68.2	-9.7	2.19 V	286	45.8	12.7
6	15720.00	47.7 PK	74.0	-26.3	1.48 V	84	36.1	11.6
7	15720.00	35.6 AV	54.0	-18.4	1.48 V	84	24.0	11.6

REMARKS:

1. Emission Level(dBuV/m) = Raw Value(dBuV) + Correction Factor(dB/m)
2. Correction Factor(dB/m) = Antenna Factor(dB/m) + Cable Factor(dB) – Pre-Amplifier Factor(dB)
3. Margin value = Emission Level – Limit value
4. The other emission levels were very low against the limit.
5. " * ": Fundamental frequency.
6. " # ": The radiated frequency is out of the restricted band.

CHANNEL	TX Channel 149	DETECTOR FUNCTION	Peak (PK)
FREQUENCY RANGE	1GHz ~ 40GHz		Average (AV)

ANTENNA POLARITY & TEST DISTANCE: HORIZONTAL AT 3 M

NO.	FREQ. (MHz)	EMISSION LEVEL (dBuV/m)	LIMIT (dBuV/m)	MARGIN (dB)	ANTENNA HEIGHT (m)	TABLE ANGLE (Degree)	RAW VALUE (dBuV)	CORRECTION FACTOR (dB/m)
1	#5639.28	62.4 PK	68.2	-5.8	1.80 H	59	60.6	1.8
2	*5745.00	122.7 PK			1.80 H	59	120.5	2.2
3	*5745.00	111.5 AV			1.80 H	59	109.3	2.2
4	#5952.02	53.3 PK	68.2	-14.9	1.80 H	59	50.7	2.6
5	11490.00	59.1 PK	74.0	-14.9	2.15 H	277	45.2	13.9
6	11490.00	45.7 AV	54.0	-8.3	2.15 H	277	31.8	13.9
7	#17235.00	47.8 PK	68.2	-20.4	1.54 H	80	30.5	17.3

ANTENNA POLARITY & TEST DISTANCE: VERTICAL AT 3 M

NO.	FREQ. (MHz)	EMISSION LEVEL (dBuV/m)	LIMIT (dBuV/m)	MARGIN (dB)	ANTENNA HEIGHT (m)	TABLE ANGLE (Degree)	RAW VALUE (dBuV)	CORRECTION FACTOR (dB/m)
1	#5647.33	61.6 PK	68.2	-6.6	1.89 V	239	59.8	1.8
2	*5745.00	124.3 PK			1.89 V	239	122.1	2.2
3	*5745.00	113.7 AV			1.89 V	239	111.5	2.2
4	#5939.27	56.2 PK	68.2	-12.0	1.89 V	239	53.7	2.5
5	11490.00	58.8 PK	74.0	-15.2	2.19 V	297	44.9	13.9
6	11490.00	45.7 AV	54.0	-8.3	2.19 V	297	31.8	13.9
7	#17235.00	48.2 PK	68.2	-20.0	1.51 V	71	30.9	17.3

REMARKS:

1. Emission Level(dBuV/m) = Raw Value(dBuV) + Correction Factor(dB/m)
2. Correction Factor(dB/m) = Antenna Factor(dB/m) + Cable Factor(dB) – Pre-Amplifier Factor(dB)
3. Margin value = Emission Level – Limit value
4. The other emission levels were very low against the limit.
5. " * ": Fundamental frequency.
6. " # ": The radiated frequency is out of the restricted band.

CHANNEL	TX Channel 157	DETECTOR FUNCTION	Peak (PK)
FREQUENCY RANGE	1GHz ~ 40GHz		Average (AV)

ANTENNA POLARITY & TEST DISTANCE: HORIZONTAL AT 3 M

NO.	FREQ. (MHz)	EMISSION LEVEL (dBuV/m)	LIMIT (dBuV/m)	MARGIN (dB)	ANTENNA HEIGHT (m)	TABLE ANGLE (Degree)	RAW VALUE (dBuV)	CORRECTION FACTOR (dB/m)
1	#5649.54	54.3 PK	68.2	-13.9	1.78 H	65	52.5	1.8
2	*5785.00	122.4 PK			1.78 H	65	120.1	2.3
3	*5785.00	112.1 AV			1.78 H	65	109.8	2.3
4	#5925.26	56.7 PK	68.2	-11.5	1.78 H	65	54.2	2.5
5	11570.00	50.7 PK	74.0	-23.3	1.47 H	318	36.7	14.0
6	11570.00	42.6 AV	54.0	-11.4	1.47 H	318	28.6	14.0
7	#17355.00	53.2 PK	68.2	-15.0	1.77 H	145	35.3	17.9

ANTENNA POLARITY & TEST DISTANCE: VERTICAL AT 3 M

NO.	FREQ. (MHz)	EMISSION LEVEL (dBuV/m)	LIMIT (dBuV/m)	MARGIN (dB)	ANTENNA HEIGHT (m)	TABLE ANGLE (Degree)	RAW VALUE (dBuV)	CORRECTION FACTOR (dB/m)
1	#5636.76	57.9 PK	68.2	-10.3	1.87 V	236	56.1	1.8
2	*5785.00	124.6 PK			1.87 V	236	122.3	2.3
3	*5785.00	114.3 AV			1.87 V	236	112.0	2.3
4	#5926.76	60.2 PK	68.2	-8.0	1.87 V	236	57.7	2.5
5	11570.00	49.9 PK	74.0	-24.1	2.18 V	244	35.9	14.0
6	11570.00	40.8 AV	54.0	-13.2	2.18 V	244	26.8	14.0
7	#17355.00	52.8 PK	68.2	-15.4	1.60 V	97	34.9	17.9

REMARKS:

1. Emission Level(dBuV/m) = Raw Value(dBuV) + Correction Factor(dB/m)
2. Correction Factor(dB/m) = Antenna Factor(dB/m) + Cable Factor(dB) – Pre-Amplifier Factor(dB)
3. Margin value = Emission Level – Limit value
4. The other emission levels were very low against the limit.
5. " * ": Fundamental frequency.
6. " # ": The radiated frequency is out of the restricted band.

CHANNEL	TX Channel 165	DETECTOR FUNCTION	Peak (PK)
FREQUENCY RANGE	1GHz ~ 40GHz		Average (AV)

ANTENNA POLARITY & TEST DISTANCE: HORIZONTAL AT 3 M

NO.	FREQ. (MHz)	EMISSION LEVEL (dBuV/m)	LIMIT (dBuV/m)	MARGIN (dB)	ANTENNA HEIGHT (m)	TABLE ANGLE (Degree)	RAW VALUE (dBuV)	CORRECTION FACTOR (dB/m)
1	#5588.93	52.7 PK	68.2	-15.5	1.76 H	74	50.9	1.8
2	*5825.00	122.3 PK			1.76 H	74	119.8	2.5
3	*5825.00	111.9 AV			1.76 H	74	109.4	2.5
4	#5931.26	61.9 PK	68.2	-6.3	1.76 H	74	59.4	2.5
5	11650.00	59.2 PK	74.0	-14.8	2.17 H	278	45.3	13.9
6	11650.00	46.0 AV	54.0	-8.0	2.17 H	278	32.1	13.9
7	#17475.00	47.8 PK	68.2	-20.4	1.54 H	59	28.8	19.0

ANTENNA POLARITY & TEST DISTANCE: VERTICAL AT 3 M

NO.	FREQ. (MHz)	EMISSION LEVEL (dBuV/m)	LIMIT (dBuV/m)	MARGIN (dB)	ANTENNA HEIGHT (m)	TABLE ANGLE (Degree)	RAW VALUE (dBuV)	CORRECTION FACTOR (dB/m)
1	#5648.95	55.6 PK	68.2	-12.6	1.84 V	236	53.8	1.8
2	*5825.00	124.1 PK			1.84 V	236	121.6	2.5
3	*5825.00	114.0 AV			1.84 V	236	111.5	2.5
4	#5930.45	60.1 PK	68.2	-8.1	1.84 V	236	57.6	2.5
5	11650.00	58.3 PK	74.0	-15.7	2.11 V	306	44.4	13.9
6	11650.00	45.4 AV	54.0	-8.6	2.11 V	306	31.5	13.9
7	#17475.00	48.0 PK	68.2	-20.2	1.50 V	89	29.0	19.0

REMARKS:

1. Emission Level(dBuV/m) = Raw Value(dBuV) + Correction Factor(dB/m)
2. Correction Factor(dB/m) = Antenna Factor(dB/m) + Cable Factor(dB) – Pre-Amplifier Factor(dB)
3. Margin value = Emission Level – Limit value
4. The other emission levels were very low against the limit.
5. " * ": Fundamental frequency.
6. " # ": The radiated frequency is out of the restricted band.

802.11ax (HE20)

CHANNEL	TX Channel 36	DETECTOR FUNCTION	Peak (PK)
FREQUENCY RANGE	1GHz ~ 40GHz		Average (AV)

ANTENNA POLARITY & TEST DISTANCE: HORIZONTAL AT 3 M

NO.	FREQ. (MHz)	EMISSION LEVEL (dBuV/m)	LIMIT (dBuV/m)	MARGIN (dB)	ANTENNA HEIGHT (m)	TABLE ANGLE (Degree)	RAW VALUE (dBuV)	CORRECTION FACTOR (dB/m)
1	5150.00	67.4 PK	74.0	-6.6	1.63 H	39	65.5	1.9
2	5150.00	52.3 AV	54.0	-1.7	1.63 H	39	50.4	1.9
3	*5180.00	117.7 PK			1.63 H	39	116.0	1.7
4	*5180.00	108.5 AV			1.63 H	39	106.8	1.7
5	#10360.00	58.2 PK	68.2	-10.0	2.19 H	304	46.1	12.1
6	15540.00	48.4 PK	74.0	-25.6	1.47 H	75	36.3	12.1
7	15540.00	36.4 AV	54.0	-17.6	1.47 H	75	24.3	12.1

ANTENNA POLARITY & TEST DISTANCE: VERTICAL AT 3 M

NO.	FREQ. (MHz)	EMISSION LEVEL (dBuV/m)	LIMIT (dBuV/m)	MARGIN (dB)	ANTENNA HEIGHT (m)	TABLE ANGLE (Degree)	RAW VALUE (dBuV)	CORRECTION FACTOR (dB/m)
1	5150.00	66.1 PK	74.0	-7.9	1.75 V	238	64.2	1.9
2	5150.00	53.4 AV	54.0	-0.6	1.75 V	238	51.5	1.9
3	*5180.00	121.8 PK			1.75 V	238	120.1	1.7
4	*5180.00	109.7 AV			1.75 V	238	108.0	1.7
5	#10360.00	59.2 PK	68.2	-9.0	2.20 V	279	47.1	12.1
6	15540.00	48.4 PK	74.0	-25.6	1.55 V	75	36.3	12.1
7	15540.00	36.3 AV	54.0	-17.7	1.55 V	75	24.2	12.1

REMARKS:

1. Emission Level(dBuV/m) = Raw Value(dBuV) + Correction Factor(dB/m)
2. Correction Factor(dB/m) = Antenna Factor(dB/m) + Cable Factor(dB) – Pre-Amplifier Factor(dB)
3. Margin value = Emission Level – Limit value
4. The other emission levels were very low against the limit.
5. " * ": Fundamental frequency.
6. " # ": The radiated frequency is out of the restricted band.

CHANNEL	TX Channel 40	DETECTOR FUNCTION	Peak (PK)
FREQUENCY RANGE	1GHz ~ 40GHz		Average (AV)

ANTENNA POLARITY & TEST DISTANCE: HORIZONTAL AT 3 M

NO.	FREQ. (MHz)	EMISSION LEVEL (dBuV/m)	LIMIT (dBuV/m)	MARGIN (dB)	ANTENNA HEIGHT (m)	TABLE ANGLE (Degree)	RAW VALUE (dBuV)	CORRECTION FACTOR (dB/m)
1	5150.00	62.3 PK	74.0	-11.7	2.76 H	23	60.4	1.9
2	5150.00	51.2 AV	54.0	-2.8	2.76 H	23	49.3	1.9
3	*5200.00	121.0 PK			2.76 H	23	119.5	1.5
4	*5200.00	110.0 AV			2.76 H	23	108.5	1.5
5	5350.00	55.2 PK	74.0	-18.8	2.76 H	23	53.8	1.4
6	5350.00	43.3 AV	54.0	-10.7	2.76 H	23	41.9	1.4
7	#10400.00	58.6 PK	68.2	-9.6	2.19 H	305	46.2	12.4
8	15600.00	47.6 PK	74.0	-26.4	1.56 H	61	35.8	11.8
9	15600.00	35.5 AV	54.0	-18.5	1.56 H	61	23.7	11.8

ANTENNA POLARITY & TEST DISTANCE: VERTICAL AT 3 M

NO.	FREQ. (MHz)	EMISSION LEVEL (dBuV/m)	LIMIT (dBuV/m)	MARGIN (dB)	ANTENNA HEIGHT (m)	TABLE ANGLE (Degree)	RAW VALUE (dBuV)	CORRECTION FACTOR (dB/m)
1	5150.00	65.1 PK	74.0	-8.9	1.74 V	236	63.2	1.9
2	5150.00	53.5 AV	54.0	-0.5	1.74 V	236	51.6	1.9
3	*5200.00	123.2 PK			1.74 V	236	121.7	1.5
4	*5200.00	113.0 AV			1.74 V	236	111.5	1.5
5	5350.00	57.5 PK	74.0	-16.5	1.74 V	236	56.1	1.4
6	5350.00	45.5 AV	54.0	-8.5	1.74 V	236	44.1	1.4
7	#10400.00	59.6 PK	68.2	-8.6	2.14 V	289	47.2	12.4
8	15600.00	47.9 PK	74.0	-26.1	1.52 V	69	36.1	11.8
9	15600.00	36.2 AV	54.0	-17.8	1.52 V	69	24.4	11.8

REMARKS:

1. Emission Level(dBuV/m) = Raw Value(dBuV) + Correction Factor(dB/m)
2. Correction Factor(dB/m) = Antenna Factor(dB/m) + Cable Factor(dB) – Pre-Amplifier Factor(dB)
3. Margin value = Emission Level – Limit value
4. The other emission levels were very low against the limit.
5. " * ": Fundamental frequency.
6. " # ": The radiated frequency is out of the restricted band.

CHANNEL	TX Channel 48	DETECTOR FUNCTION	Peak (PK)
FREQUENCY RANGE	1GHz ~ 40GHz		Average (AV)

ANTENNA POLARITY & TEST DISTANCE: HORIZONTAL AT 3 M

NO.	FREQ. (MHz)	EMISSION LEVEL (dBuV/m)	LIMIT (dBuV/m)	MARGIN (dB)	ANTENNA HEIGHT (m)	TABLE ANGLE (Degree)	RAW VALUE (dBuV)	CORRECTION FACTOR (dB/m)
1	*5240.00	119.5 PK			1.58 H	42	118.1	1.4
2	*5240.00	106.7 AV			1.58 H	42	105.3	1.4
3	5350.00	53.3 PK	74.0	-20.7	1.58 H	42	51.9	1.4
4	5350.00	42.2 AV	54.0	-11.8	1.58 H	42	40.8	1.4
5	#10480.00	59.5 PK	68.2	-8.7	2.19 H	275	46.8	12.7
6	15720.00	47.6 PK	74.0	-26.4	1.57 H	75	36.0	11.6
7	15720.00	35.9 AV	54.0	-18.1	1.57 H	75	24.3	11.6

ANTENNA POLARITY & TEST DISTANCE: VERTICAL AT 3 M

NO.	FREQ. (MHz)	EMISSION LEVEL (dBuV/m)	LIMIT (dBuV/m)	MARGIN (dB)	ANTENNA HEIGHT (m)	TABLE ANGLE (Degree)	RAW VALUE (dBuV)	CORRECTION FACTOR (dB/m)
1	*5240.00	121.9 PK			1.84 V	245	120.5	1.4
2	*5240.00	109.1 AV			1.84 V	245	107.7	1.4
3	5350.00	57.3 PK	74.0	-16.7	1.84 V	245	55.9	1.4
4	5350.00	45.2 AV	54.0	-8.8	1.84 V	245	43.8	1.4
5	#10480.00	59.6 PK	68.2	-8.6	2.10 V	296	46.9	12.7
6	15720.00	47.8 PK	74.0	-26.2	1.53 V	59	36.2	11.6
7	15720.00	36.1 AV	54.0	-17.9	1.53 V	59	24.5	11.6

REMARKS:

1. Emission Level(dBuV/m) = Raw Value(dBuV) + Correction Factor(dB/m)
2. Correction Factor(dB/m) = Antenna Factor(dB/m) + Cable Factor(dB) – Pre-Amplifier Factor(dB)
3. Margin value = Emission Level – Limit value
4. The other emission levels were very low against the limit.
5. " * ": Fundamental frequency.
6. " # ": The radiated frequency is out of the restricted band.

CHANNEL	TX Channel 149	DETECTOR FUNCTION	Peak (PK)
FREQUENCY RANGE	1GHz ~ 40GHz		Average (AV)

ANTENNA POLARITY & TEST DISTANCE: HORIZONTAL AT 3 M

NO.	FREQ. (MHz)	EMISSION LEVEL (dBuV/m)	LIMIT (dBuV/m)	MARGIN (dB)	ANTENNA HEIGHT (m)	TABLE ANGLE (Degree)	RAW VALUE (dBuV)	CORRECTION FACTOR (dB/m)
1	#5649.29	64.3 PK	68.2	-3.9	1.80 H	65	62.5	1.8
2	*5745.00	122.0 PK			1.80 H	65	119.8	2.2
3	*5745.00	111.5 AV			1.80 H	65	109.3	2.2
4	#5933.46	56.1 PK	68.2	-12.1	1.80 H	65	53.6	2.5
5	11490.00	59.8 PK	74.0	-14.2	2.09 H	280	45.9	13.9
6	11490.00	46.4 AV	54.0	-7.6	2.09 H	280	32.5	13.9
7	#17235.00	48.3 PK	68.2	-19.9	1.52 H	61	31.0	17.3

ANTENNA POLARITY & TEST DISTANCE: VERTICAL AT 3 M

NO.	FREQ. (MHz)	EMISSION LEVEL (dBuV/m)	LIMIT (dBuV/m)	MARGIN (dB)	ANTENNA HEIGHT (m)	TABLE ANGLE (Degree)	RAW VALUE (dBuV)	CORRECTION FACTOR (dB/m)
1	#5638.50	64.1 PK	68.2	-4.1	1.89 V	241	62.3	1.8
2	*5745.00	122.8 PK			1.89 V	241	120.6	2.2
3	*5745.00	113.9 AV			1.89 V	241	111.7	2.2
4	#5925.31	56.6 PK	68.2	-11.6	1.89 V	241	54.1	2.5
5	11490.00	59.9 PK	74.0	-14.1	2.20 V	296	46.0	13.9
6	11490.00	46.1 AV	54.0	-7.9	2.20 V	296	32.2	13.9
7	#17235.00	48.1 PK	68.2	-20.1	1.49 V	77	30.8	17.3

REMARKS:

1. Emission Level(dBuV/m) = Raw Value(dBuV) + Correction Factor(dB/m)
2. Correction Factor(dB/m) = Antenna Factor(dB/m) + Cable Factor(dB) – Pre-Amplifier Factor(dB)
3. Margin value = Emission Level – Limit value
4. The other emission levels were very low against the limit.
5. " * ": Fundamental frequency.
6. " # ": The radiated frequency is out of the restricted band.

CHANNEL	TX Channel 157	DETECTOR FUNCTION	Peak (PK)
FREQUENCY RANGE	1GHz ~ 40GHz		Average (AV)

ANTENNA POLARITY & TEST DISTANCE: HORIZONTAL AT 3 M

NO.	FREQ. (MHz)	EMISSION LEVEL (dBuV/m)	LIMIT (dBuV/m)	MARGIN (dB)	ANTENNA HEIGHT (m)	TABLE ANGLE (Degree)	RAW VALUE (dBuV)	CORRECTION FACTOR (dB/m)
1	#5640.75	54.8 PK	68.2	-13.4	1.84 H	69	53.0	1.8
2	*5785.00	122.8 PK			1.84 H	69	120.5	2.3
3	*5785.00	112.4 AV			1.84 H	69	110.1	2.3
4	#5926.88	56.0 PK	68.2	-12.2	1.84 H	69	53.5	2.5
5	11570.00	59.8 PK	74.0	-14.2	2.15 H	277	45.8	14.0
6	11570.00	46.4 AV	54.0	-7.6	2.15 H	277	32.4	14.0
7	#17355.00	47.6 PK	68.2	-20.6	1.48 H	77	29.7	17.9

ANTENNA POLARITY & TEST DISTANCE: VERTICAL AT 3 M

NO.	FREQ. (MHz)	EMISSION LEVEL (dBuV/m)	LIMIT (dBuV/m)	MARGIN (dB)	ANTENNA HEIGHT (m)	TABLE ANGLE (Degree)	RAW VALUE (dBuV)	CORRECTION FACTOR (dB/m)
1	#5644.56	57.1 PK	68.2	-11.1	1.97 V	237	55.3	1.8
2	*5785.00	123.5 PK			1.97 V	237	121.2	2.3
3	*5785.00	114.8 AV			1.97 V	237	112.5	2.3
4	#5928.78	58.8 PK	68.2	-9.4	1.97 V	237	56.3	2.5
5	11570.00	59.7 PK	74.0	-14.3	2.14 V	298	45.7	14.0
6	11570.00	46.0 AV	54.0	-8.0	2.14 V	298	32.0	14.0
7	#17355.00	47.9 PK	68.2	-20.3	1.47 V	79	30.0	17.9

REMARKS:

1. Emission Level(dBuV/m) = Raw Value(dBuV) + Correction Factor(dB/m)
2. Correction Factor(dB/m) = Antenna Factor(dB/m) + Cable Factor(dB) – Pre-Amplifier Factor(dB)
3. Margin value = Emission Level – Limit value
4. The other emission levels were very low against the limit.
5. " * ": Fundamental frequency.
6. " # ": The radiated frequency is out of the restricted band.

CHANNEL	TX Channel 165	DETECTOR FUNCTION	Peak (PK)
FREQUENCY RANGE	1GHz ~ 40GHz		Average (AV)

ANTENNA POLARITY & TEST DISTANCE: HORIZONTAL AT 3 M

NO.	FREQ. (MHz)	EMISSION LEVEL (dBuV/m)	LIMIT (dBuV/m)	MARGIN (dB)	ANTENNA HEIGHT (m)	TABLE ANGLE (Degree)	RAW VALUE (dBuV)	CORRECTION FACTOR (dB/m)
1	#5550.89	52.7 PK	68.2	-15.5	1.74 H	69	50.9	1.8
2	*5825.00	122.7 PK			1.74 H	69	120.2	2.5
3	*5825.00	111.0 AV			1.74 H	69	108.5	2.5
4	#5929.62	60.5 PK	68.2	-7.7	1.74 H	69	58.0	2.5
5	11650.00	59.8 PK	74.0	-14.2	2.18 H	278	45.9	13.9
6	11650.00	46.5 AV	54.0	-7.5	2.18 H	278	32.6	13.9
7	#17475.00	47.9 PK	68.2	-20.3	1.56 H	59	28.9	19.0

ANTENNA POLARITY & TEST DISTANCE: VERTICAL AT 3 M

NO.	FREQ. (MHz)	EMISSION LEVEL (dBuV/m)	LIMIT (dBuV/m)	MARGIN (dB)	ANTENNA HEIGHT (m)	TABLE ANGLE (Degree)	RAW VALUE (dBuV)	CORRECTION FACTOR (dB/m)
1	#5576.23	55.2 PK	68.2	-13.0	1.93 V	236	53.4	1.8
2	*5825.00	122.6 PK			1.93 V	236	120.1	2.5
3	*5825.00	113.5 AV			1.93 V	236	111.0	2.5
4	#5926.59	64.5 PK	68.2	-3.7	1.93 V	236	62.0	2.5
5	11650.00	59.0 PK	74.0	-15.0	2.14 V	291	45.1	13.9
6	11650.00	45.8 AV	54.0	-8.2	2.14 V	291	31.9	13.9
7	#17475.00	47.8 PK	68.2	-20.4	1.50 V	77	28.8	19.0

REMARKS:

1. Emission Level(dBuV/m) = Raw Value(dBuV) + Correction Factor(dB/m)
2. Correction Factor(dB/m) = Antenna Factor(dB/m) + Cable Factor(dB) – Pre-Amplifier Factor(dB)
3. Margin value = Emission Level – Limit value
4. The other emission levels were very low against the limit.
5. " * ": Fundamental frequency.
6. " # ": The radiated frequency is out of the restricted band.

802.11ax (HE40)

CHANNEL	TX Channel 38	DETECTOR FUNCTION	Peak (PK)
FREQUENCY RANGE	1GHz ~ 40GHz		Average (AV)

ANTENNA POLARITY & TEST DISTANCE: HORIZONTAL AT 3 M

NO.	FREQ. (MHz)	EMISSION LEVEL (dBuV/m)	LIMIT (dBuV/m)	MARGIN (dB)	ANTENNA HEIGHT (m)	TABLE ANGLE (Degree)	RAW VALUE (dBuV)	CORRECTION FACTOR (dB/m)
1	5150.00	62.4 PK	74.0	-11.6	1.58 H	38	60.5	1.9
2	5150.00	51.0 AV	54.0	-3.0	1.58 H	38	49.1	1.9
3	*5190.00	110.1 PK			1.58 H	38	108.4	1.7
4	*5190.00	100.0 AV			1.58 H	38	98.3	1.7
5	#10380.00	59.2 PK	68.2	-9.0	2.16 H	302	46.9	12.3
6	15570.00	47.3 PK	74.0	-26.7	1.47 H	70	35.3	12.0
7	15570.00	35.7 AV	54.0	-18.3	1.47 H	70	23.7	12.0

ANTENNA POLARITY & TEST DISTANCE: VERTICAL AT 3 M

NO.	FREQ. (MHz)	EMISSION LEVEL (dBuV/m)	LIMIT (dBuV/m)	MARGIN (dB)	ANTENNA HEIGHT (m)	TABLE ANGLE (Degree)	RAW VALUE (dBuV)	CORRECTION FACTOR (dB/m)
1	5150.00	64.4 PK	74.0	-9.6	1.84 V	240	62.5	1.9
2	5150.00	53.3 AV	54.0	-0.7	1.84 V	240	51.4	1.9
3	*5190.00	110.7 PK			1.84 V	240	109.0	1.7
4	*5190.00	101.5 AV			1.84 V	240	99.8	1.7
5	#10380.00	59.5 PK	68.2	-8.7	2.13 V	305	47.2	12.3
6	15570.00	48.1 PK	74.0	-25.9	1.51 V	81	36.1	12.0
7	15570.00	36.4 AV	54.0	-17.6	1.51 V	81	24.4	12.0

REMARKS:

1. Emission Level(dBuV/m) = Raw Value(dBuV) + Correction Factor(dB/m)
2. Correction Factor(dB/m) = Antenna Factor(dB/m) + Cable Factor(dB) – Pre-Amplifier Factor(dB)
3. Margin value = Emission Level – Limit value
4. The other emission levels were very low against the limit.
5. " * ": Fundamental frequency.
6. " # ": The radiated frequency is out of the restricted band.

CHANNEL	TX Channel 46	DETECTOR FUNCTION	Peak (PK)
FREQUENCY RANGE	1GHz ~ 40GHz		Average (AV)

ANTENNA POLARITY & TEST DISTANCE: HORIZONTAL AT 3 M

NO.	FREQ. (MHz)	EMISSION LEVEL (dBuV/m)	LIMIT (dBuV/m)	MARGIN (dB)	ANTENNA HEIGHT (m)	TABLE ANGLE (Degree)	RAW VALUE (dBuV)	CORRECTION FACTOR (dB/m)
1	5150.00	64.7 PK	74.0	-9.3	1.61 H	43	62.8	1.9
2	5150.00	52.6 AV	54.0	-1.4	1.61 H	43	50.7	1.9
3	*5230.00	116.9 PK			1.61 H	43	115.4	1.5
4	*5230.00	106.2 AV			1.61 H	43	104.7	1.5
5	5350.00	56.0 PK	74.0	-18.0	1.61 H	43	54.6	1.4
6	5350.00	44.6 AV	54.0	-9.4	1.61 H	43	43.2	1.4
7	#10460.00	59.8 PK	68.2	-8.4	2.12 H	285	47.2	12.6
8	15690.00	48.0 PK	74.0	-26.0	1.47 H	83	36.5	11.5
9	15690.00	36.3 AV	54.0	-17.7	1.47 H	83	24.8	11.5

ANTENNA POLARITY & TEST DISTANCE: VERTICAL AT 3 M

NO.	FREQ. (MHz)	EMISSION LEVEL (dBuV/m)	LIMIT (dBuV/m)	MARGIN (dB)	ANTENNA HEIGHT (m)	TABLE ANGLE (Degree)	RAW VALUE (dBuV)	CORRECTION FACTOR (dB/m)
1	5150.00	70.8 PK	74.0	-3.2	1.96 V	242	68.9	1.9
2	5150.00	53.2 AV	54.0	-0.8	1.96 V	242	51.3	1.9
3	*5230.00	118.4 PK			1.96 V	242	116.9	1.5
4	*5230.00	108.7 AV			1.96 V	242	107.2	1.5
5	5350.00	63.2 PK	74.0	-10.8	1.96 V	242	61.8	1.4
6	5350.00	51.5 AV	54.0	-2.5	1.96 V	242	50.1	1.4
7	#10460.00	60.1 PK	68.2	-8.1	2.13 V	284	47.5	12.6
8	15690.00	47.4 PK	74.0	-26.6	1.57 V	72	35.9	11.5
9	15690.00	35.8 AV	54.0	-18.2	1.57 V	72	24.3	11.5

REMARKS:

1. Emission Level(dBuV/m) = Raw Value(dBuV) + Correction Factor(dB/m)
2. Correction Factor(dB/m) = Antenna Factor(dB/m) + Cable Factor(dB) – Pre-Amplifier Factor(dB)
3. Margin value = Emission Level – Limit value
4. The other emission levels were very low against the limit.
5. " * ": Fundamental frequency.
6. " # ": The radiated frequency is out of the restricted band.

CHANNEL	TX Channel 151	DETECTOR FUNCTION	Peak (PK)
FREQUENCY RANGE	1GHz ~ 40GHz		Average (AV)

ANTENNA POLARITY & TEST DISTANCE: HORIZONTAL AT 3 M

NO.	FREQ. (MHz)	EMISSION LEVEL (dBuV/m)	LIMIT (dBuV/m)	MARGIN (dB)	ANTENNA HEIGHT (m)	TABLE ANGLE (Degree)	RAW VALUE (dBuV)	CORRECTION FACTOR (dB/m)
1	#5647.64	60.6 PK	68.2	-7.6	1.86 H	63	58.8	1.8
2	*5755.00	115.3 PK			1.86 H	64	113.1	2.2
3	*5755.00	106.4 AV			1.86 H	64	104.2	2.2
4	#5927.62	55.2 PK	68.2	-13.0	1.86 H	63	52.7	2.5
5	11510.00	60.1 PK	74.0	-13.9	2.19 H	303	46.2	13.9
6	11510.00	46.4 AV	54.0	-7.6	2.19 H	303	32.5	13.9
7	#17265.00	47.3 PK	68.2	-20.9	1.54 H	65	29.9	17.4

ANTENNA POLARITY & TEST DISTANCE: VERTICAL AT 3 M

NO.	FREQ. (MHz)	EMISSION LEVEL (dBuV/m)	LIMIT (dBuV/m)	MARGIN (dB)	ANTENNA HEIGHT (m)	TABLE ANGLE (Degree)	RAW VALUE (dBuV)	CORRECTION FACTOR (dB/m)
1	#5643.55	66.4 PK	68.2	-1.8	1.88 V	241	64.6	1.8
2	*5755.00	119.4 PK			1.88 V	241	117.2	2.2
3	*5755.00	108.8 AV			1.88 V	241	106.6	2.2
4	#5934.61	59.2 PK	68.2	-9.0	1.88 V	241	56.7	2.5
5	11510.00	59.7 PK	74.0	-14.3	2.14 V	300	45.8	13.9
6	11510.00	46.4 AV	54.0	-7.6	2.14 V	300	32.5	13.9
7	#17265.00	48.7 PK	68.2	-19.5	1.55 V	70	31.3	17.4

REMARKS:

1. Emission Level(dBuV/m) = Raw Value(dBuV) + Correction Factor(dB/m)
2. Correction Factor(dB/m) = Antenna Factor(dB/m) + Cable Factor(dB) – Pre-Amplifier Factor(dB)
3. Margin value = Emission Level – Limit value
4. The other emission levels were very low against the limit.
5. " * ": Fundamental frequency.
6. " # ": The radiated frequency is out of the restricted band.

CHANNEL	TX Channel 159	DETECTOR FUNCTION	Peak (PK)
FREQUENCY RANGE	1GHz ~ 40GHz		Average (AV)

ANTENNA POLARITY & TEST DISTANCE: HORIZONTAL AT 3 M

NO.	FREQ. (MHz)	EMISSION LEVEL (dBuV/m)	LIMIT (dBuV/m)	MARGIN (dB)	ANTENNA HEIGHT (m)	TABLE ANGLE (Degree)	RAW VALUE (dBuV)	CORRECTION FACTOR (dB/m)
1	#5649.79	59.1 PK	68.2	-9.1	1.76 H	66	57.3	1.8
2	*5795.00	117.9 PK			1.76 H	66	115.5	2.4
3	*5795.00	107.0 AV			1.76 H	66	104.6	2.4
4	#5925.90	64.7 PK	68.2	-3.5	1.76 H	66	62.2	2.5
5	11590.00	59.1 PK	74.0	-14.9	2.12 H	274	45.1	14.0
6	11590.00	45.6 AV	54.0	-8.4	2.12 H	274	31.6	14.0
7	#17385.00	47.8 PK	68.2	-20.4	1.46 H	71	29.6	18.2

ANTENNA POLARITY & TEST DISTANCE: VERTICAL AT 3 M

NO.	FREQ. (MHz)	EMISSION LEVEL (dBuV/m)	LIMIT (dBuV/m)	MARGIN (dB)	ANTENNA HEIGHT (m)	TABLE ANGLE (Degree)	RAW VALUE (dBuV)	CORRECTION FACTOR (dB/m)
1	#5649.85	60.4 PK	68.2	-7.8	1.86 V	237	58.6	1.8
2	*5795.00	118.0 PK			1.86 V	237	115.6	2.4
3	*5795.00	109.4 AV			1.86 V	237	107.0	2.4
4	#5934.49	66.6 PK	68.2	-1.6	1.86 V	237	64.1	2.5
5	11590.00	59.7 PK	74.0	-14.3	2.15 V	304	45.7	14.0
6	11590.00	46.3 AV	54.0	-7.7	2.15 V	304	32.3	14.0
7	#17385.00	48.1 PK	68.2	-20.1	1.53 V	76	29.9	18.2

REMARKS:

1. Emission Level(dBuV/m) = Raw Value(dBuV) + Correction Factor(dB/m)
2. Correction Factor(dB/m) = Antenna Factor(dB/m) + Cable Factor(dB) – Pre-Amplifier Factor(dB)
3. Margin value = Emission Level – Limit value
4. The other emission levels were very low against the limit.
5. " * ": Fundamental frequency.
6. " # ": The radiated frequency is out of the restricted band.

802.11ax (HE80)

CHANNEL	TX Channel 42	DETECTOR FUNCTION	Peak (PK)
FREQUENCY RANGE	1GHz ~ 40GHz		Average (AV)

ANTENNA POLARITY & TEST DISTANCE: HORIZONTAL AT 3 M

NO.	FREQ. (MHz)	EMISSION LEVEL (dBuV/m)	LIMIT (dBuV/m)	MARGIN (dB)	ANTENNA HEIGHT (m)	TABLE ANGLE (Degree)	RAW VALUE (dBuV)	CORRECTION FACTOR (dB/m)
1	5150.00	57.4 PK	74.0	-16.6	1.50 H	38	55.5	1.9
2	5150.00	48.4 AV	54.0	-5.6	1.50 H	38	46.5	1.9
3	*5210.00	105.8 PK			1.50 H	38	104.3	1.5
4	*5210.00	95.4 AV			1.50 H	38	93.9	1.5
5	5350.00	52.1 PK	74.0	-21.9	1.50 H	38	50.7	1.4
6	5350.00	40.9 AV	54.0	-13.1	1.50 H	38	39.5	1.4
7	#10420.00	59.2 PK	68.2	-9.0	2.11 H	278	46.8	12.4
8	15630.00	47.7 PK	74.0	-26.3	1.47 H	73	36.0	11.7
9	15630.00	35.9 AV	54.0	-18.1	1.47 H	73	24.2	11.7

ANTENNA POLARITY & TEST DISTANCE: VERTICAL AT 3 M

NO.	FREQ. (MHz)	EMISSION LEVEL (dBuV/m)	LIMIT (dBuV/m)	MARGIN (dB)	ANTENNA HEIGHT (m)	TABLE ANGLE (Degree)	RAW VALUE (dBuV)	CORRECTION FACTOR (dB/m)
1	5150.00	63.9 PK	74.0	-10.1	1.90 V	252	62.0	1.9
2	5150.00	53.2 AV	54.0	-0.8	1.90 V	252	51.3	1.9
3	*5210.00	108.5 PK			1.90 V	252	107.0	1.5
4	*5210.00	98.1 AV			1.90 V	252	96.6	1.5
5	5350.00	55.7 PK	74.0	-18.3	1.90 V	252	54.3	1.4
6	5350.00	43.9 AV	54.0	-10.1	1.90 V	252	42.5	1.4
7	#10420.00	59.1 PK	68.2	-9.1	2.12 V	283	46.7	12.4
8	15630.00	48.6 PK	74.0	-25.4	1.54 V	59	36.9	11.7
9	15630.00	36.7 AV	54.0	-17.3	1.54 V	59	25.0	11.7

REMARKS:

1. Emission Level(dBuV/m) = Raw Value(dBuV) + Correction Factor(dB/m)
2. Correction Factor(dB/m) = Antenna Factor(dB/m) + Cable Factor(dB) – Pre-Amplifier Factor(dB)
3. Margin value = Emission Level – Limit value
4. The other emission levels were very low against the limit.
5. " * ": Fundamental frequency.
6. " # ": The radiated frequency is out of the restricted band.

CHANNEL	TX Channel 155	DETECTOR FUNCTION	Peak (PK)
FREQUENCY RANGE	1GHz ~ 40GHz		Average (AV)

ANTENNA POLARITY & TEST DISTANCE: HORIZONTAL AT 3 M

NO.	FREQ. (MHz)	EMISSION LEVEL (dBuV/m)	LIMIT (dBuV/m)	MARGIN (dB)	ANTENNA HEIGHT (m)	TABLE ANGLE (Degree)	RAW VALUE (dBuV)	CORRECTION FACTOR (dB/m)
1	#5644.55	63.1 PK	68.2	-5.1	1.72 H	65	61.3	1.8
2	*5775.00	111.4 PK			1.72 H	65	109.1	2.3
3	*5775.00	100.8 AV			1.72 H	65	98.5	2.3
4	#5928.15	61.6 PK	68.2	-6.6	1.72 H	65	59.1	2.5
5	11550.00	59.2 PK	74.0	-14.8	2.13 H	280	45.2	14.0
6	11550.00	45.7 AV	54.0	-8.3	2.13 H	280	31.7	14.0
7	#17325.00	48.4 PK	68.2	-19.8	1.53 H	61	30.7	17.7

ANTENNA POLARITY & TEST DISTANCE: VERTICAL AT 3 M

NO.	FREQ. (MHz)	EMISSION LEVEL (dBuV/m)	LIMIT (dBuV/m)	MARGIN (dB)	ANTENNA HEIGHT (m)	TABLE ANGLE (Degree)	RAW VALUE (dBuV)	CORRECTION FACTOR (dB/m)
1	#5650.20	66.8 PK	68.3	-1.5	1.87 V	246	65.0	1.8
2	*5775.00	113.7 PK			1.87 V	246	111.4	2.3
3	*5775.00	103.1 AV			1.87 V	246	100.8	2.3
4	#5926.35	63.2 PK	68.2	-5.0	1.87 V	246	60.7	2.5
5	11550.00	59.8 PK	74.0	-14.2	2.15 V	301	45.8	14.0
6	11550.00	46.2 AV	54.0	-7.8	2.15 V	301	32.2	14.0
7	#17325.00	47.9 PK	68.2	-20.3	1.51 V	76	30.2	17.7

REMARKS:

1. Emission Level(dBuV/m) = Raw Value(dBuV) + Correction Factor(dB/m)
2. Correction Factor(dB/m) = Antenna Factor(dB/m) + Cable Factor(dB) – Pre-Amplifier Factor(dB)
3. Margin value = Emission Level – Limit value
4. The other emission levels were very low against the limit.
5. " * ": Fundamental frequency.
6. " # ": The radiated frequency is out of the restricted band.

Below 1GHz Data:

Adapter: MAUS-120200

802.11ax (HE40)

CHANNEL	TX Channel 151	DETECTOR FUNCTION	Quasi-Peak (QP)
FREQUENCY RANGE	9kHz ~ 1GHz		

ANTENNA POLARITY & TEST DISTANCE: HORIZONTAL AT 3 M								
NO.	FREQ. (MHz)	EMISSION LEVEL (dBuV/m)	LIMIT (dBuV/m)	MARGIN (dB)	ANTENNA HEIGHT (m)	TABLE ANGLE (Degree)	RAW VALUE (dBuV)	CORRECTION FACTOR (dB/m)
1	30.58	29.1 QP	40.0	-10.9	1.00 H	66	43.3	-14.2
2	66.62	30.1 QP	40.0	-9.9	1.00 H	230	44.2	-14.1
3	124.97	31.9 QP	43.5	-11.6	3.00 H	108	46.3	-14.4
4	250.01	32.4 QP	46.0	-13.6	1.00 H	112	46.3	-13.9
5	635.02	33.3 QP	46.0	-12.7	1.00 H	205	38.0	-4.7
6	800.02	31.8 QP	46.0	-14.2	2.00 H	360	34.2	-2.4

REMARKS:

1. Emission Level(dBuV/m) = Raw Value(dBuV) + Correction Factor(dB/m)
2. Correction Factor(dB/m) = Antenna Factor(dB/m) + Cable Factor(dB) – Pre-Amplifier Factor(dB)
3. Margin value = Emission Level – Limit value
4. The other emission levels were very low against the limit of frequency range 30MHz~1000MHz.
5. The emission levels were very low against the limit of frequency range 9kHz~30MHz: the amplitude of spurious emissions attenuated more than 20 dB below the permissible value to be report.

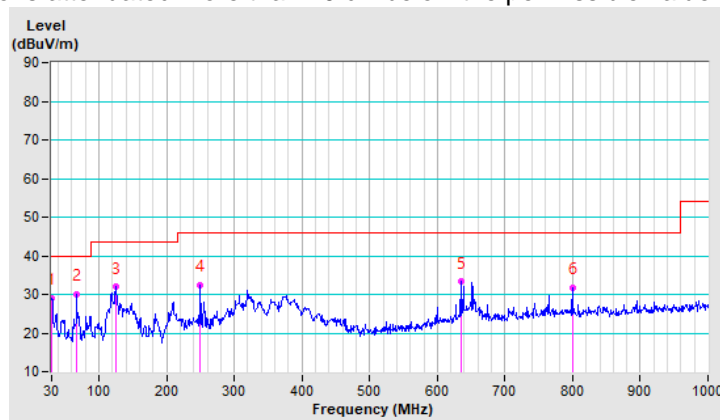

CHANNEL	TX Channel 151	DETECTOR FUNCTION	Quasi-Peak (QP)
FREQUENCY RANGE	9kHz ~ 1GHz		

ANTENNA POLARITY & TEST DISTANCE: VERTICAL AT 3 M

NO.	FREQ. (MHz)	EMISSION LEVEL (dBuV/m)	LIMIT (dBuV/m)	MARGIN (dB)	ANTENNA HEIGHT (m)	TABLE ANGLE (Degree)	RAW VALUE (dBuV)	CORRECTION FACTOR (dB/m)
1	30.02	36.9 QP	40.0	-3.1	1.00 V	265	50.9	-14.0
2	46.64	36.7 QP	40.0	-3.3	1.00 V	145	49.4	-12.7
3	62.51	36.7 QP	40.0	-3.3	1.00 V	12	50.5	-13.8
4	124.97	33.8 QP	43.5	-9.7	1.00 V	127	48.2	-14.4
5	397.45	30.1 QP	46.0	-15.9	2.00 V	276	39.9	-9.8
6	800.02	28.9 QP	46.0	-17.1	1.50 V	212	31.3	-2.4

REMARKS:

1. Emission Level(dBuV/m) = Raw Value(dBuV) + Correction Factor(dB/m)
2. Correction Factor(dB/m) = Antenna Factor(dB/m) + Cable Factor(dB) – Pre-Amplifier Factor(dB)
3. Margin value = Emission Level – Limit value
4. The other emission levels were very low against the limit of frequency range 30MHz~1000MHz.
5. The emission levels were very low against the limit of frequency range 9kHz~30MHz: the amplitude of spurious emissions attenuated more than 20 dB below the permissible value to be report.

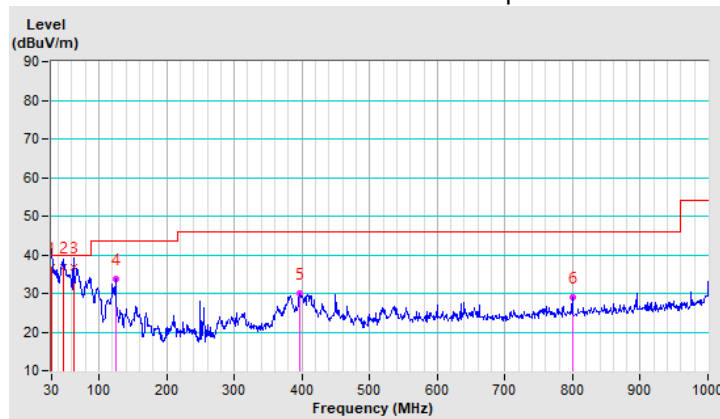

4.1.8 Test Results (Mode 2)

Below 1GHz Data:

Adapter: DSA-24PFS-12 FUS 120200

802.11ax (HE40)

CHANNEL	TX Channel 151	DETECTOR FUNCTION	Quasi-Peak (QP)
FREQUENCY RANGE	9kHz ~ 1GHz		

ANTENNA POLARITY & TEST DISTANCE: HORIZONTAL AT 3 M								
NO.	FREQ. (MHz)	EMISSION LEVEL (dBuV/m)	LIMIT (dBuV/m)	MARGIN (dB)	ANTENNA HEIGHT (m)	TABLE ANGLE (Degree)	RAW VALUE (dBuV)	CORRECTION FACTOR (dB/m)
1	30.49	30.2 QP	40.0	-9.8	1.50 H	360	44.4	-14.2
2	66.62	29.9 QP	40.0	-10.1	1.00 H	220	44.0	-14.1
3	124.97	28.7 QP	43.5	-14.8	3.00 H	106	43.1	-14.4
4	250.01	33.4 QP	46.0	-12.6	1.00 H	102	47.3	-13.9
5	638.12	34.9 QP	46.0	-11.1	1.00 H	192	39.5	-4.6
6	800.02	31.4 QP	46.0	-14.6	2.00 H	173	33.8	-2.4

REMARKS:

1. Emission Level(dBuV/m) = Raw Value(dBuV) + Correction Factor(dB/m)
2. Correction Factor(dB/m) = Antenna Factor(dB/m) + Cable Factor(dB) – Pre-Amplifier Factor(dB)
3. Margin value = Emission Level – Limit value
4. The other emission levels were very low against the limit of frequency range 30MHz~1000MHz.
5. The emission levels were very low against the limit of frequency range 9kHz~30MHz: the amplitude of spurious emissions attenuated more than 20 dB below the permissible value to be report.

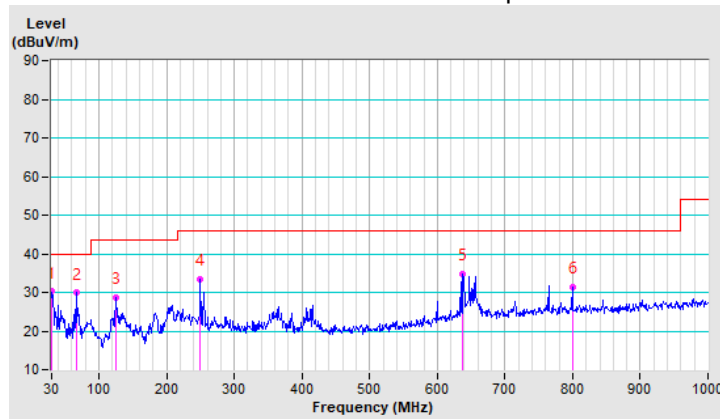

CHANNEL	TX Channel 151	DETECTOR FUNCTION	Quasi-Peak (QP)
FREQUENCY RANGE	9kHz ~ 1GHz		

ANTENNA POLARITY & TEST DISTANCE: VERTICAL AT 3 M

NO.	FREQ. (MHz)	EMISSION LEVEL (dBuV/m)	LIMIT (dBuV/m)	MARGIN (dB)	ANTENNA HEIGHT (m)	TABLE ANGLE (Degree)	RAW VALUE (dBuV)	CORRECTION FACTOR (dB/m)
1	46.01	36.6 QP	40.0	-3.4	1.00 V	60	49.3	-12.7
2	62.45	36.8 QP	40.0	-3.2	1.00 V	19	50.5	-13.7
3	88.54	33.3 QP	43.5	-10.2	1.00 V	278	51.8	-18.5
4	407.74	28.1 QP	46.0	-17.9	1.50 V	266	37.7	-9.6
5	656.55	37.9 QP	46.0	-8.1	2.00 V	147	42.3	-4.4
6	800.02	31.3 QP	46.0	-14.7	1.50 V	194	33.7	-2.4

REMARKS:

1. Emission Level(dBuV/m) = Raw Value(dBuV) + Correction Factor(dB/m)
2. Correction Factor(dB/m) = Antenna Factor(dB/m) + Cable Factor(dB) – Pre-Amplifier Factor(dB)
3. Margin value = Emission Level – Limit value
4. The other emission levels were very low against the limit of frequency range 30MHz~1000MHz.
5. The emission levels were very low against the limit of frequency range 9kHz~30MHz: the amplitude of spurious emissions attenuated more than 20 dB below the permissible value to be report.

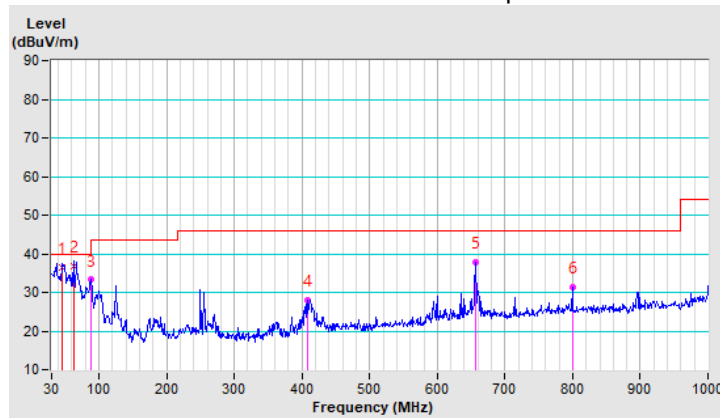

4.1.9 Test Results (Mode 3)

Below 1GHz Data:

Adapter: UP0251M-12PA

802.11ax (HE40)

CHANNEL	TX Channel 151	DETECTOR FUNCTION	Quasi-Peak (QP)
FREQUENCY RANGE	9kHz ~ 1GHz		

ANTENNA POLARITY & TEST DISTANCE: HORIZONTAL AT 3 M

NO.	FREQ. (MHz)	EMISSION LEVEL (dBuV/m)	LIMIT (dBuV/m)	MARGIN (dB)	ANTENNA HEIGHT (m)	TABLE ANGLE (Degree)	RAW VALUE (dBuV)	CORRECTION FACTOR (dB/m)
1	31.21	34.0 QP	40.0	-6.0	1.00 H	219	48.3	-14.3
2	66.52	29.0 QP	40.0	-11.0	1.50 H	360	43.2	-14.2
3	184.43	28.0 QP	43.5	-15.5	1.50 H	254	42.9	-14.9
4	255.00	33.8 QP	46.0	-12.2	3.00 H	114	47.7	-13.9
5	365.20	28.2 QP	46.0	-17.8	1.00 H	208	38.7	-10.5
6	656.17	34.8 QP	46.0	-11.2	3.00 H	222	39.2	-4.4

REMARKS:

1. Emission Level(dBuV/m) = Raw Value(dBuV) + Correction Factor(dB/m)
2. Correction Factor(dB/m) = Antenna Factor(dB/m) + Cable Factor(dB) – Pre-Amplifier Factor(dB)
3. Margin value = Emission Level – Limit value
4. The other emission levels were very low against the limit of frequency range 30MHz~1000MHz.
5. The emission levels were very low against the limit of frequency range 9kHz~30MHz: the amplitude of spurious emissions attenuated more than 20 dB below the permissible value to be report.

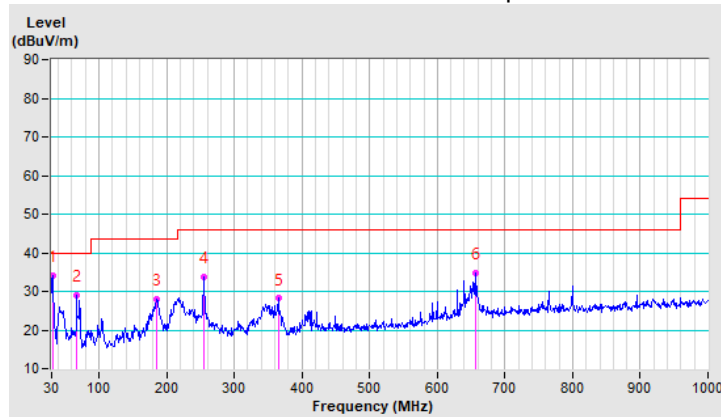

CHANNEL	TX Channel 151	DETECTOR FUNCTION	Quasi-Peak (QP)
FREQUENCY RANGE	9kHz ~ 1GHz		

ANTENNA POLARITY & TEST DISTANCE: VERTICAL AT 3 M

NO.	FREQ. (MHz)	EMISSION LEVEL (dBuV/m)	LIMIT (dBuV/m)	MARGIN (dB)	ANTENNA HEIGHT (m)	TABLE ANGLE (Degree)	RAW VALUE (dBuV)	CORRECTION FACTOR (dB/m)
1	44.89	36.6 QP	40.0	-3.4	1.00 V	270	49.4	-12.8
2	62.45	36.8 QP	40.0	-3.2	1.00 V	312	50.5	-13.7
3	124.97	35.6 QP	43.5	-7.9	1.00 V	142	50.0	-14.4
4	411.28	28.7 QP	46.0	-17.3	1.50 V	274	38.2	-9.5
5	656.26	35.8 QP	46.0	-10.2	2.00 V	329	40.2	-4.4
6	800.02	30.4 QP	46.0	-15.6	1.50 V	180	32.8	-2.4

REMARKS:

1. Emission Level(dBuV/m) = Raw Value(dBuV) + Correction Factor(dB/m)
2. Correction Factor(dB/m) = Antenna Factor(dB/m) + Cable Factor(dB) – Pre-Amplifier Factor(dB)
3. Margin value = Emission Level – Limit value
4. The other emission levels were very low against the limit of frequency range 30MHz~1000MHz.
5. The emission levels were very low against the limit of frequency range 9kHz~30MHz: the amplitude of spurious emissions attenuated more than 20 dB below the permissible value to be report.

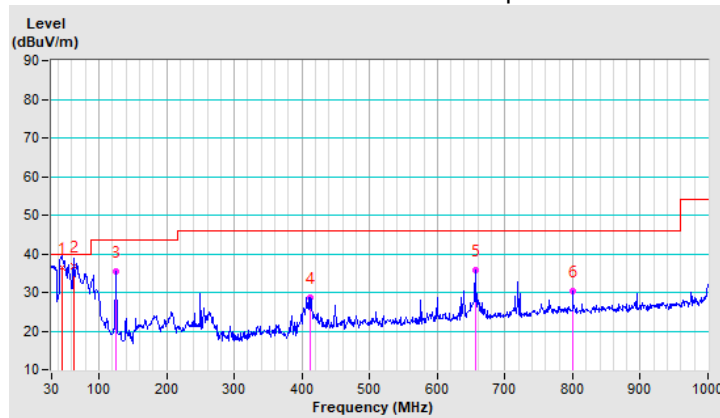

4.2 Conducted Emission Measurement

4.2.1 Limits of Conducted Emission Measurement

Frequency (MHz)	Conducted Limit (dBuV)	
	Quasi-peak	Average
0.15 - 0.5	66 - 56	56 - 46
0.50 - 5.0	56	46
5.0 - 30.0	60	50

Note: 1. The lower limit shall apply at the transition frequencies.

2. The limit decreases in line with the logarithm of the frequency in the range of 0.15 to 0.50MHz.

4.2.2 Test Instruments

DESCRIPTION & MANUFACTURER	MODEL NO.	SERIAL NO.	CALIBRATED DATE	CALIBRATED UNTIL
Test Receiver R&S	ESCS 30	847124/029	Oct. 23, 2019	Oct. 22, 2020
Line-Impedance Stabilization Network (for EUT) R&S	ESH3-Z5	848773/004	Oct. 23, 2019	Oct. 22, 2020
Line-Impedance Stabilization Network (for Peripheral) R&S	ESH3-Z5	835239/001	Mar. 19, 2020	Mar. 18, 2021
50 ohms Terminator	50	3	Oct. 23, 2019	Oct. 22, 2020
RF Cable	5D-FB	COCCAB-001	Sep. 27, 2019	Sep. 26, 2020
Fixed attenuator EMCI	STI02-2200-10	005	Aug. 30, 2019	Aug. 29, 2020
Software BVADT	BVADT_Cond_ V7.3.7.4	NA	NA	NA

Note:

1. The calibration interval of the above test instruments are 12 months and the calibrations are traceable to NML/ROC and NIST/USA.
2. The test was performed in Conduction 1.
- 3 Tested Date: Apr. 13, 2020

4.2.3 Test Procedure

- The EUT was placed 0.4 meters from the conducting wall of the shielded room with EUT being connected to the power mains through a line impedance stabilization network (LISN). Other support units were connected to the power mains through another LISN. The two LISNs provide 50 ohm/ 50uH of coupling impedance for the measuring instrument.
- Both lines of the power mains connected to the EUT were checked for maximum conducted interference.
- The frequency range from 150kHz to 30MHz was searched. Emission levels under (Limit - 20dB) was not recorded.

NOTE: All modes of operation were investigated and the worst-case emissions are reported.

4.2.4 Deviation from Test Standard

No deviation.

4.2.5 Test Setup

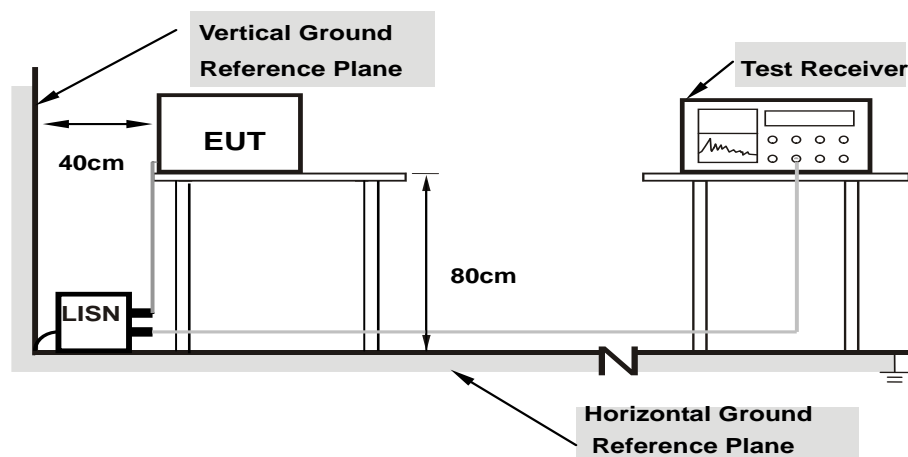

Note: 1.Support units were connected to second LISN.

For the actual test configuration, please refer to the attached file (Test Setup Photo).

4.2.6 EUT Operating Condition

Same as 4.1.6.

4.2.7 Test Results (Mode 1)

Adapter: MAUS-120200

Phase	Line (L)	Detector Function	Quasi-Peak (QP) / Average (AV)
-------	----------	-------------------	--------------------------------

No	Freq. [MHz]	Corr.	Reading Value		Emission Level		Limit		Margin	
		Factor	[dB (uV)]		[dB (uV)]		[dB (uV)]		(dB)	
	(dB)	Q.P.	AV.	Q.P.	AV.	Q.P.	AV.	Q.P.	AV.	
1	0.15000	9.99	39.60	26.22	49.59	36.21	66.00	56.00	-16.41	-19.79
2	0.16562	9.99	37.10	27.66	47.09	37.65	65.18	55.18	-18.09	-17.53
3	0.21641	9.99	30.42	21.77	40.41	31.76	62.96	52.96	-22.55	-21.20
4	0.38438	10.00	26.61	18.83	36.61	28.83	58.18	48.18	-21.57	-19.35
5	2.69531	10.17	19.69	10.68	29.86	20.85	56.00	46.00	-26.14	-25.15
6	9.19531	10.60	19.67	12.42	30.27	23.02	60.00	50.00	-29.73	-26.98

Remarks:

1. Q.P. and AV. are abbreviations of quasi-peak and average individually.
2. The emission levels of other frequencies were very low against the limit.
3. Margin value = Emission level – Limit value
4. Correction factor = Insertion loss + Cable loss
5. Emission Level = Correction Factor + Reading Value

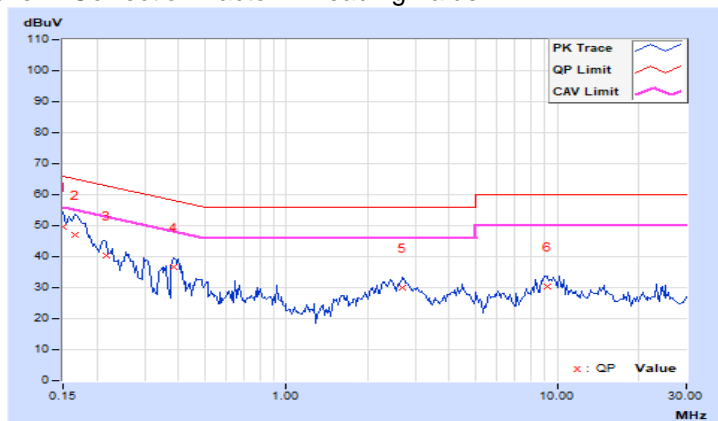

Phase	Neutral (N)	Detector Function	Quasi-Peak (QP) / Average (AV)
-------	-------------	-------------------	--------------------------------

No	Freq. [MHz]	Corr. Factor	Reading Value [dB (uV)]		Emission Level [dB (uV)]		Limit [dB (uV)]		Margin (dB)	
		(dB)	Q.P.	AV.	Q.P.	AV.	Q.P.	AV.	Q.P.	AV.
	1	0.15000	9.99	39.94	26.34	49.93	36.33	66.00	56.00	-16.07
2	0.17734	9.99	38.18	25.37	48.17	35.36	64.61	54.61	-16.44	-19.25
3	0.24766	9.99	27.07	14.63	37.06	24.62	61.84	51.84	-24.78	-27.22
4	0.38438	10.01	26.92	18.83	36.93	28.84	58.18	48.18	-21.25	-19.34
5	1.63281	10.09	17.15	7.65	27.24	17.74	56.00	46.00	-28.76	-28.26
6	24.53516	11.22	16.81	13.23	28.03	24.45	60.00	50.00	-31.97	-25.55

Remarks:

1. Q.P. and AV. are abbreviations of quasi-peak and average individually.
2. The emission levels of other frequencies were very low against the limit.
3. Margin value = Emission level – Limit value
4. Correction factor = Insertion loss + Cable loss
5. Emission Level = Correction Factor + Reading Value

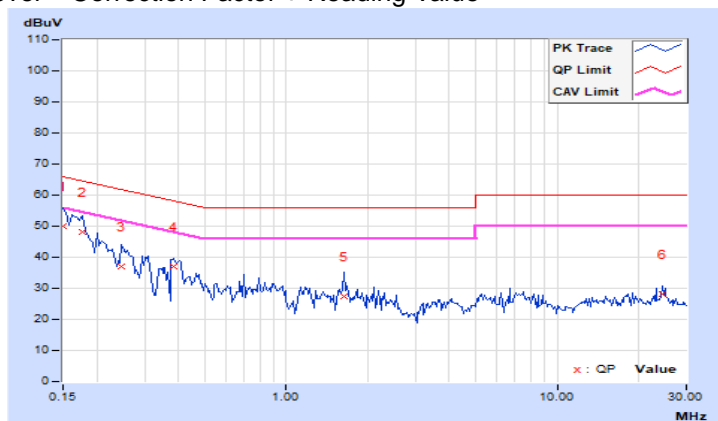

4.2.8 Test Results (Mode 2)

Adapter: DSA-24PFS-12 FUS 120200

Phase	Line (L)	Detector Function	Quasi-Peak (QP) / Average (AV)
-------	----------	-------------------	--------------------------------

No	Freq. [MHz]	Corr.	Reading Value		Emission Level		Limit		Margin	
		Factor (dB)	[dB (uV)]		[dB (uV)]		[dB (uV)]		(dB)	
			Q.P.	AV.	Q.P.	AV.	Q.P.	AV.	Q.P.	AV.
1	0.16562	9.99	40.57	28.30	50.56	38.29	65.18	55.18	-14.62	-16.89
2	0.25938	9.99	33.39	21.32	43.38	31.31	61.45	51.45	-18.07	-20.14
3	0.34922	10.00	29.00	13.09	39.00	23.09	58.98	48.98	-19.98	-25.89
4	2.07422	10.13	27.12	15.41	37.25	25.54	56.00	46.00	-18.75	-20.46
5	9.04688	10.59	26.35	18.28	36.94	28.87	60.00	50.00	-23.06	-21.13
6	11.69531	10.77	29.06	21.75	39.83	32.52	60.00	50.00	-20.17	-17.48

Remarks:

1. Q.P. and AV. are abbreviations of quasi-peak and average individually.
2. The emission levels of other frequencies were very low against the limit.
3. Margin value = Emission level – Limit value
4. Correction factor = Insertion loss + Cable loss
5. Emission Level = Correction Factor + Reading Value

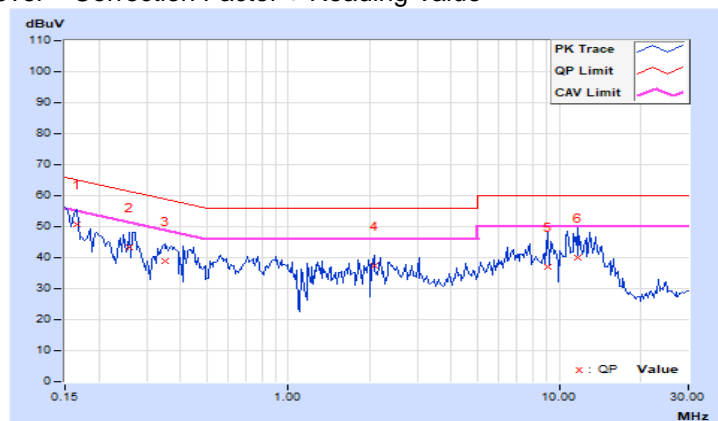

Phase	Neutral (N)	Detector Function	Quasi-Peak (QP) / Average (AV)
-------	-------------	-------------------	--------------------------------

No	Freq. [MHz]	Corr. Factor	Reading Value [dB (uV)]		Emission Level [dB (uV)]		Limit [dB (uV)]		Margin (dB)	
		(dB)	Q.P.	AV.	Q.P.	AV.	Q.P.	AV.	Q.P.	AV.
	1	0.16172	9.99	41.32	26.77	51.31	36.76	65.38	55.38	-14.07
2	0.18125	9.99	34.76	19.92	44.75	29.91	64.43	54.43	-19.68	-24.52
3	4.00000	10.22	27.34	17.86	37.56	28.08	56.00	46.00	-18.44	-17.92
4	6.77734	10.39	28.84	20.32	39.23	30.71	60.00	50.00	-20.77	-19.29
5	11.03125	10.64	27.84	21.31	38.48	31.95	60.00	50.00	-21.52	-18.05
6	13.09375	10.75	28.47	21.01	39.22	31.76	60.00	50.00	-20.78	-18.24

Remarks:

1. Q.P. and AV. are abbreviations of quasi-peak and average individually.
2. The emission levels of other frequencies were very low against the limit.
3. Margin value = Emission level – Limit value
4. Correction factor = Insertion loss + Cable loss
5. Emission Level = Correction Factor + Reading Value

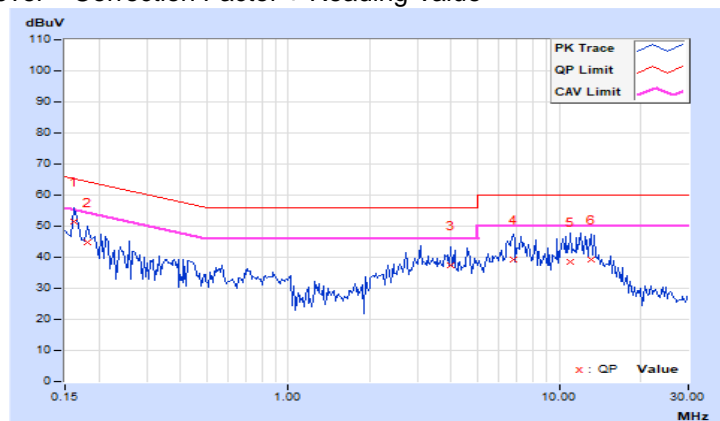

4.2.9 Test Results (Mode 3)

Adapter: UP0251M-12PA

Phase	Line (L)	Detector Function	Quasi-Peak (QP) / Average (AV)
-------	----------	-------------------	--------------------------------

No	Freq. [MHz]	Corr. Factor	Reading Value [dB (uV)]		Emission Level [dB (uV)]		Limit [dB (uV)]		Margin (dB)	
		(dB)	Q.P.	AV.	Q.P.	AV.	Q.P.	AV.	Q.P.	AV.
	1	0.16562	9.99	33.76	22.66	43.75	32.65	65.18	55.18	-21.43
2	0.34922	10.00	33.91	24.66	43.91	34.66	58.98	48.98	-15.07	-14.32
3	0.40781	10.00	30.88	20.50	40.88	30.50	57.69	47.69	-16.81	-17.19
4	2.98438	10.19	29.76	16.06	39.95	26.25	56.00	46.00	-16.05	-19.75
5	13.47656	10.90	22.59	16.46	33.49	27.36	60.00	50.00	-26.51	-22.64
6	19.97266	11.37	27.25	19.96	38.62	31.33	60.00	50.00	-21.38	-18.67

Remarks:

1. Q.P. and AV. are abbreviations of quasi-peak and average individually.
2. The emission levels of other frequencies were very low against the limit.
3. Margin value = Emission level – Limit value
4. Correction factor = Insertion loss + Cable loss
5. Emission Level = Correction Factor + Reading Value



Phase	Neutral (N)	Detector Function	Quasi-Peak (QP) / Average (AV)
-------	-------------	-------------------	--------------------------------

No	Freq. [MHz]	Corr. Factor	Reading Value [dB (uV)]		Emission Level [dB (uV)]		Limit [dB (uV)]		Margin (dB)	
		(dB)	Q.P.	AV.	Q.P.	AV.	Q.P.	AV.	Q.P.	AV.
	1	0.16562	9.99	32.80	22.88	42.79	32.87	65.18	55.18	-22.39
2	0.36484	10.01	32.35	21.28	42.36	31.29	58.62	48.62	-16.26	-17.33
3	1.88672	10.11	26.16	16.03	36.27	26.14	56.00	46.00	-19.73	-19.86
4	3.03125	10.17	29.24	17.86	39.41	28.03	56.00	46.00	-16.59	-17.97
5	20.17969	11.11	27.91	20.93	39.02	32.04	60.00	50.00	-20.98	-17.96
6	23.81641	11.20	25.27	17.58	36.47	28.78	60.00	50.00	-23.53	-21.22

Remarks:

1. Q.P. and AV. are abbreviations of quasi-peak and average individually.
2. The emission levels of other frequencies were very low against the limit.
3. Margin value = Emission level – Limit value
4. Correction factor = Insertion loss + Cable loss
5. Emission Level = Correction Factor + Reading Value



4.3 Transmit Power Measurement

4.3.1 Limits of Transmit Power Measurement

Operation Band	EUT Category		Limit
U-NII-1		Outdoor Access Point	1 Watt (30 dBm) (Max. e.i.r.p \leq 125mW(21 dBm) at any elevation angle above 30 degrees as measured from the horizon)
		Fixed point-to-point Access Point	1 Watt (30 dBm)
	√	Indoor Access Point	1 Watt (30 dBm)
		Client device	250mW (24 dBm)
U-NII-2A			250mW (24 dBm) or 11 dBm+10 log B*
U-NII-2C			250mW (24 dBm) or 11 dBm+10 log B*
U-NII-3		√	1 Watt (30 dBm)

*B is the 26 dB emission bandwidth in megahertz

Per KDB 662911 Method of conducted output power measurement on IEEE 802.11 devices,

Array Gain = 0 dB (i.e., no array gain) for $N_{ANT} \leq 4$;

Array Gain = 0 dB (i.e., no array gain) for channel widths ≥ 40 MHz for any N_{ANT} ;

Array Gain = $5 \log(N_{ANT}/N_{SS})$ dB or 3 dB, whichever is less for 20-MHz channel widths with $N_{ANT} \geq 5$.

For power measurements on all other devices: Array Gain = $10 \log(N_{ANT}/N_{SS})$ dB.

4.3.2 Test Setup

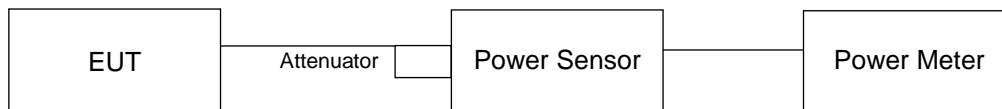

4.3.3 Test Instruments

Refer to section 4.1.2 to get information of above instrument.

4.3.4 Test Procedure

Method PM is used to perform output power measurement, trigger and gating function of wide band power meter is enabled to measure max output power of TX on burst. Duty factor is not added to measured value.

4.3.5 Deviation from Test Standard

No deviation.

4.3.6 EUT Operating Condition

The software provided by client to enable the EUT under transmission condition continuously at lowest, middle and highest channel frequencies individually.

4.3.7 Test Results

Non-Beamforming Mode

802.11a

Chan.	Chan. Freq. (MHz)	Maximum Conducted Power (dBm)		Total Power (mW)	Total Power (dBm)	Limit (dBm)	Pass / Fail
		Chain 0	Chain 1				
36	5180	23.82	22.88	435.079	26.39	30	Pass
40	5200	26.62	25.40	805.935	29.06	30	Pass
48	5240	25.89	24.30	657.304	28.18	30	Pass
149	5745	26.25	25.79	801.011	29.04	30	Pass
157	5785	26.54	26.31	878.38	29.44	30	Pass
165	5825	25.55	25.40	705.659	28.49	30	Pass

802.11ac (VHT20)

Chan.	Chan. Freq. (MHz)	Maximum Conducted Power (dBm)		Total Power (mW)	Total Power (dBm)	Limit (dBm)	Pass / Fail
		Chain 0	Chain 1				
36	5180	23.77	22.66	422.733	26.26	30	Pass
40	5200	26.53	25.39	795.719	29.01	30	Pass
48	5240	25.01	24.73	614.123	27.88	30	Pass
149	5745	25.77	26.86	862.861	29.36	30	Pass
157	5785	25.91	26.77	865.277	29.37	30	Pass
165	5825	25.83	26.59	838.862	29.24	30	Pass

802.11ac (VHT40)

Chan.	Chan. Freq. (MHz)	Maximum Conducted Power (dBm)		Total Power (mW)	Total Power (dBm)	Limit (dBm)	Pass / Fail
		Chain 0	Chain 1				
38	5190	18.99	18.19	145.168	21.62	30	Pass
46	5230	25.30	24.85	644.336	28.09	30	Pass
151	5755	26.75	26.54	923.968	29.66	30	Pass
159	5795	25.65	25.14	693.87	28.41	30	Pass

802.11ac (VHT80)

Chan.	Chan. Freq. (MHz)	Maximum Conducted Power (dBm)		Total Power (mW)	Total Power (dBm)	Limit (dBm)	Pass / Fail
		Chain 0	Chain 1				
42	5210	17.49	16.89	104.97	20.21	30	Pass
155	5775	22.34	22.27	340.051	25.32	30	Pass

802.11ax (HE20)

Chan.	Chan. Freq. (MHz)	Maximum Conducted Power (dBm)		Total Power (mW)	Total Power (dBm)	Limit (dBm)	Pass / Fail
		Chain 0	Chain 1				
36	5180	23.99	22.77	439.845	26.43	30	Pass
40	5200	26.75	25.49	827.149	29.18	30	Pass
48	5240	25.26	24.98	650.512	28.13	30	Pass
149	5745	25.96	26.94	888.768	29.49	30	Pass
157	5785	25.99	26.84	880.25	29.45	30	Pass
165	5825	25.98	26.91	887.186	29.48	30	Pass

802.11ax (HE40)

Chan.	Chan. Freq. (MHz)	Maximum Conducted Power (dBm)		Total Power (mW)	Total Power (dBm)	Limit (dBm)	Pass / Fail
		Chain 0	Chain 1				
38	5190	19.22	18.32	151.481	21.80	30	Pass
46	5230	25.43	25.05	669.03	28.25	30	Pass
151	5755	26.83	26.66	945.395	29.76	30	Pass
159	5795	25.81	25.41	728.602	28.62	30	Pass

802.11ax (HE80)

Chan.	Chan. Freq. (MHz)	Maximum Conducted Power (dBm)		Total Power (mW)	Total Power (dBm)	Limit (dBm)	Pass / Fail
		Chain 0	Chain 1				
42	5210	17.61	16.96	107.336	20.31	30	Pass
155	5775	22.64	22.53	362.714	25.60	30	Pass

Beamforming Mode

802.11ac (VHT20)

Chan.	Chan. Freq. (MHz)	Maximum Conducted Power (dBm)		Total Power (mW)	Total Power (dBm)	Limit (dBm)	Pass / Fail
		Chain 0	Chain 1				
36	5180	23.77	22.66	422.733	26.26	29.60	Pass
40	5200	26.53	25.39	795.719	29.01	29.60	Pass
48	5240	25.01	24.73	614.123	27.88	29.60	Pass
149	5745	25.76	25.36	720.262	28.57	29.57	Pass
157	5785	25.77	25.72	750.822	28.76	29.57	Pass
165	5825	25.45	25.57	711.331	28.52	29.57	Pass

- Note: 1. For U-NII-1: The directional gain = $10 \log[(10^{G_{0/20}} + 10^{G_{1/20}})^2 / 2] = 6.40 \text{ dBi} > 6 \text{ dBi}$, so the power limit shall be reduced to $30 - (6.40 - 6) = 29.60 \text{ dBm}$.
2. For U-NII-3: The directional gain = $10 \log[(10^{G_{0/20}} + 10^{G_{1/20}})^2 / 2] = 6.43 \text{ dB} > 6 \text{ dBi}$, so the power limit shall be reduced to $30 - (6.43 - 6) = 29.57 \text{ dBm}$.

802.11ac (VHT40)

Chan.	Chan. Freq. (MHz)	Maximum Conducted Power (dBm)		Total Power (mW)	Total Power (dBm)	Limit (dBm)	Pass / Fail
		Chain 0	Chain 1				
38	5190	18.99	18.19	145.168	21.62	29.60	Pass
46	5230	25.30	24.85	644.336	28.09	29.60	Pass
151	5755	26.14	25.99	808.341	29.08	29.57	Pass
159	5795	25.65	25.14	693.87	28.41	29.57	Pass

- Note: 1. For U-NII-1: The directional gain = $10 \log[(10^{G_{0/20}} + 10^{G_{1/20}})^2 / 2] = 6.40 \text{ dBi} > 6 \text{ dBi}$, so the power limit shall be reduced to $30 - (6.40 - 6) = 29.60 \text{ dBm}$.
2. For U-NII-3: The directional gain = $10 \log[(10^{G_{0/20}} + 10^{G_{1/20}})^2 / 2] = 6.43 \text{ dB} > 6 \text{ dBi}$, so the power limit shall be reduced to $30 - (6.43 - 6) = 29.57 \text{ dBm}$.

802.11ac (VHT80)

Chan.	Chan. Freq. (MHz)	Maximum Conducted Power (dBm)		Total Power (mW)	Total Power (dBm)	Limit (dBm)	Pass / Fail
		Chain 0	Chain 1				
42	5210	17.49	16.89	104.97	20.21	29.60	Pass
155	5775	22.34	22.27	340.051	25.32	29.57	Pass

- Note: 1. For U-NII-1: The directional gain = $10 \log[(10^{G_{0/20}} + 10^{G_{1/20}})^2 / 2] = 6.40 \text{ dBi} > 6 \text{ dBi}$, so the power limit shall be reduced to $30 - (6.40 - 6) = 29.60 \text{ dBm}$.
2. For U-NII-3: The directional gain = $10 \log[(10^{G_{0/20}} + 10^{G_{1/20}})^2 / 2] = 6.43 \text{ dB} > 6 \text{ dBi}$, so the power limit shall be reduced to $30 - (6.43 - 6) = 29.57 \text{ dBm}$.

802.11ax (HE20)

Chan.	Chan. Freq. (MHz)	Maximum Conducted Power (dBm)		Total Power (mW)	Total Power (dBm)	Limit (dBm)	Pass / Fail
		Chain 0	Chain 1				
36	5180	23.99	22.77	439.845	26.43	29.60	Pass
40	5200	26.75	25.49	827.149	29.18	29.60	Pass
48	5240	25.26	24.98	650.512	28.13	29.60	Pass
149	5745	26.03	25.60	763.945	28.83	29.57	Pass
157	5785	25.95	25.85	778.142	28.91	29.57	Pass
165	5825	25.74	25.73	749.084	28.75	29.57	Pass

- Note: 1. For U-NII-1: The directional gain = $10 \log[(10^{G0/20} + 10^{G1/20})^2 / 2] = 6.40 \text{ dBi} > 6 \text{ dBi}$, so the power limit shall be reduced to $30 - (6.40 - 6) = 29.60 \text{ dBm}$.
2. For U-NII-3: The directional gain = $10 \log[(10^{G0/20} + 10^{G1/20})^2 / 2] = 6.43 \text{ dB} > 6 \text{ dBi}$, so the power limit shall be reduced to $30 - (6.43 - 6) = 29.57 \text{ dBm}$.

802.11ax (HE40)

Chan.	Chan. Freq. (MHz)	Maximum Conducted Power (dBm)		Total Power (mW)	Total Power (dBm)	Limit (dBm)	Pass / Fail
		Chain 0	Chain 1				
38	5190	19.22	18.32	151.481	21.80	29.60	Pass
46	5230	25.43	25.05	669.03	28.25	29.60	Pass
151	5755	26.32	26.10	835.929	29.22	29.57	Pass
159	5795	25.81	25.41	728.602	28.62	29.57	Pass

- Note: 1. For U-NII-1: The directional gain = $10 \log[(10^{G0/20} + 10^{G1/20})^2 / 2] = 6.40 \text{ dBi} > 6 \text{ dBi}$, so the power limit shall be reduced to $30 - (6.40 - 6) = 29.60 \text{ dBm}$.
2. For U-NII-3: The directional gain = $10 \log[(10^{G0/20} + 10^{G1/20})^2 / 2] = 6.43 \text{ dB} > 6 \text{ dBi}$, so the power limit shall be reduced to $30 - (6.43 - 6) = 29.57 \text{ dBm}$.

802.11ax (HE80)

Chan.	Chan. Freq. (MHz)	Maximum Conducted Power (dBm)		Total Power (mW)	Total Power (dBm)	Limit (dBm)	Pass / Fail
		Chain 0	Chain 1				
42	5210	17.61	16.96	107.336	20.31	29.60	Pass
155	5775	22.64	22.53	362.714	25.60	29.57	Pass

- Note: 1. For U-NII-1: The directional gain = $10 \log[(10^{G0/20} + 10^{G1/20})^2 / 2] = 6.40 \text{ dBi} > 6 \text{ dBi}$, so the power limit shall be reduced to $30 - (6.40 - 6) = 29.60 \text{ dBm}$.
2. For U-NII-3: The directional gain = $10 \log[(10^{G0/20} + 10^{G1/20})^2 / 2] = 6.43 \text{ dB} > 6 \text{ dBi}$, so the power limit shall be reduced to $30 - (6.43 - 6) = 29.57 \text{ dBm}$.

4.4 Occupied Bandwidth Measurement

4.4.1 Test Setup

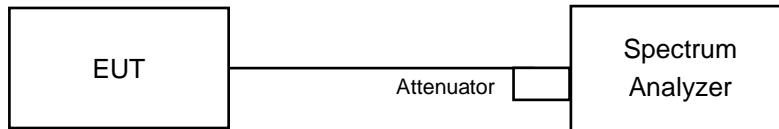

4.4.2 Test Instruments

Refer to section 4.1.2 to get information of above instrument.

4.4.3 Test Procedure

The transmitter output was connected to the spectrum analyzer through an attenuator. The bandwidth of the fundamental frequency was measured by spectrum analyzer with resolution bandwidth in the range of 1% to 5% of the anticipated emission bandwidth, and a video bandwidth at least 3x the resolution bandwidth and set the detector to SAMPLE. The width of a frequency band such that, below the lower and above the upper frequency limits, the mean powers emitted are each equal to a specified percentage 0.5% of the total mean power of a given emission.

4.4.4 Test Results

802.11a

Channel	Channel Frequency (MHz)	Occupied Bandwidth (MHz)	
		Chain 0	Chain 1
36	5180	17.16	16.92
40	5200	23.65	18
48	5240	17.52	17.4
149	5745	18	17.28
157	5785	21.48	19.56
165	5825	19.56	17.64

802.11ax (HE20)

Channel	Channel Frequency (MHz)	Occupied Bandwidth (MHz)	
		Chain 0	Chain 1
36	5180	19.08	19.08
40	5200	20.64	19.2
48	5240	19.44	19.08
149	5745	19.2	19.2
157	5785	19.2	19.32
165	5825	19.8	26.52

802.11ax (HE40)

Channel	Channel Frequency (MHz)	Occupied Bandwidth (MHz)	
		Chain 0	Chain 1
38	5190	39.12	38.64
46	5230	39.83	39.36
151	5755	42.48	41.52
159	5795	40.08	39.12

802.11ax (HE80)

Channel	Channel Frequency (MHz)	Occupied Bandwidth (MHz)	
		Chain 0	Chain 1
42	5210	77.76	77.28
155	5775	78.24	77.28

Spectrum Plot of Max. Value

802.11a_Chain 0 / CH40

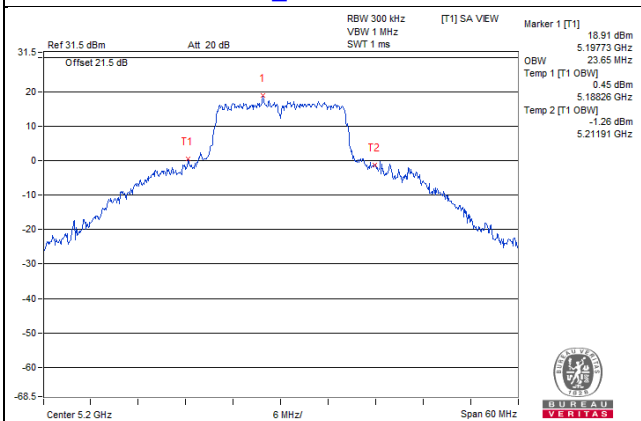

802.11ax (HE20)_Chain 1 / CH165

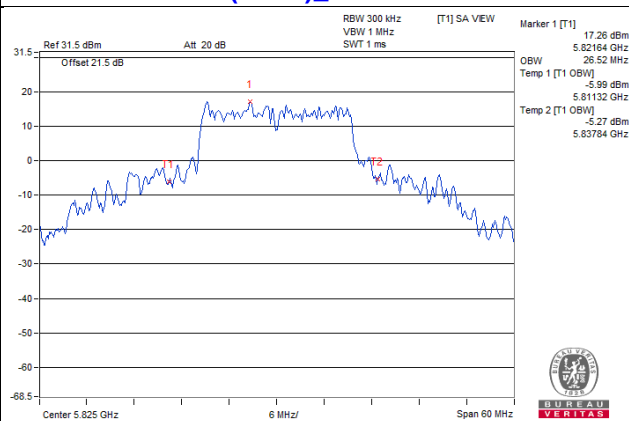

802.11ax (HE40)_Chain 0 / CH151

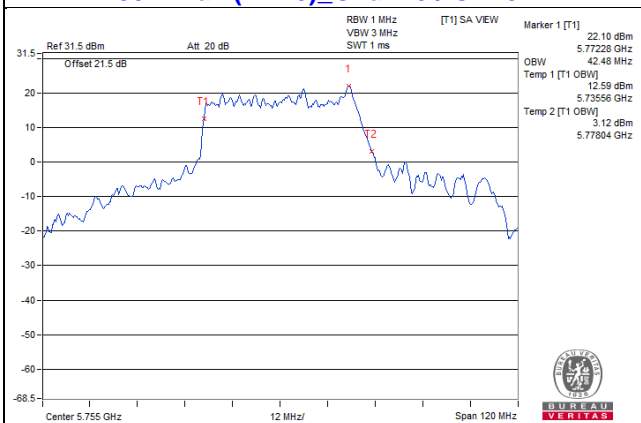

802.11ax (HE80)_Chain 0 / CH155

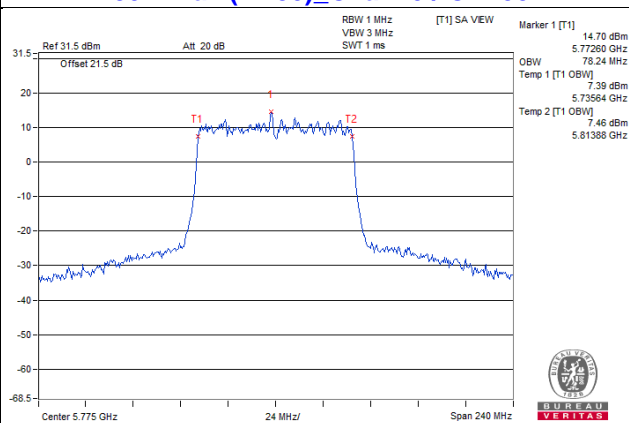

Spectrum Plot for near by DFS band
(DFS is required, if 99% OCP straddle into U-NII-2A band)

802.11a_Chain 0 / CH48

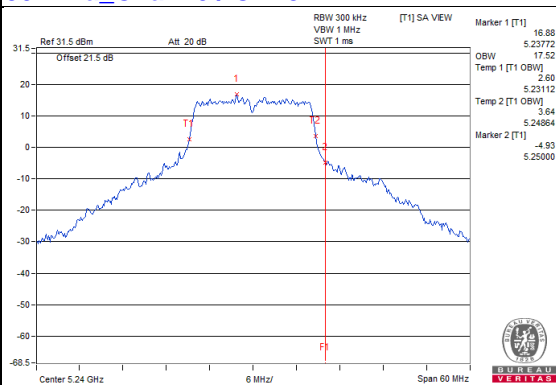

802.11a_Chain 1 / CH48

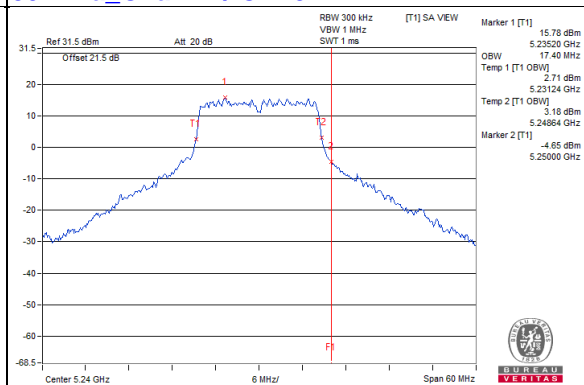

802.11ax (HE20)_Chain 0 / CH48

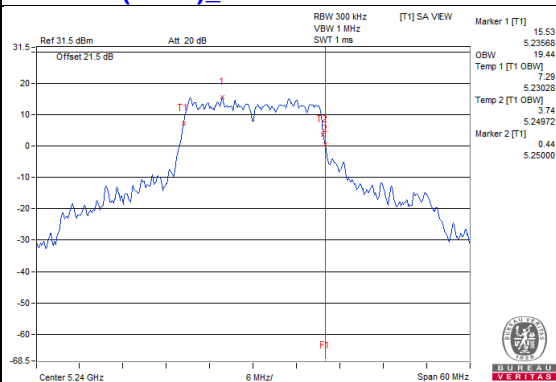

802.11ax (HE20)_Chain 1 / CH48

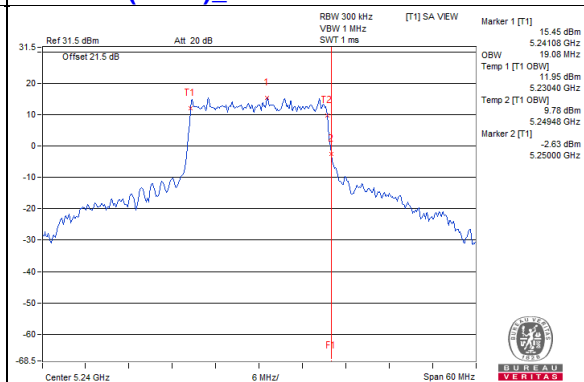

802.11ax (HE40)_Chain 0 / CH46

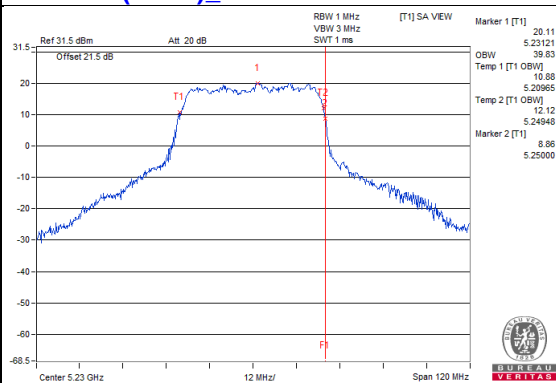

802.11ax (HE40)_Chain 1 / CH46

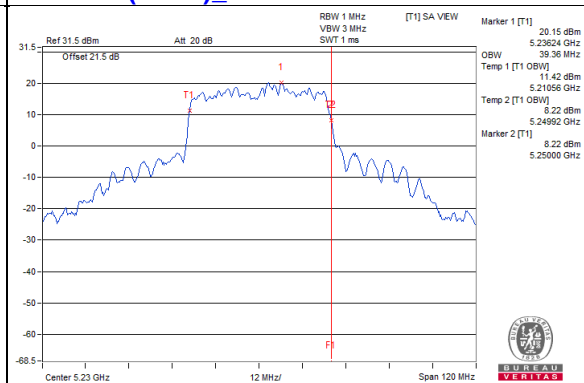

802.11ax (HE80)_Chain 0 / CH42

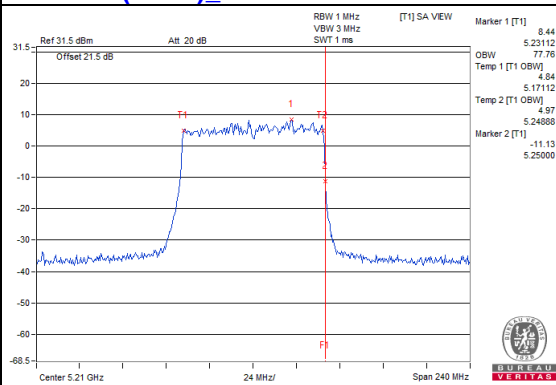

802.11ax (HE80)_Chain 1 / CH42

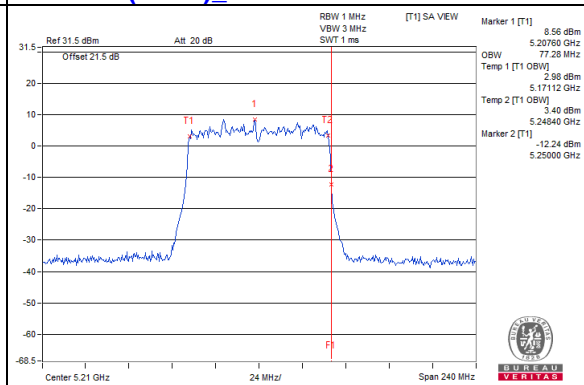

Spectrum Plot for near by DFS band
(DFS is required, if 99% OCP straddle into U-NII-2C band)

802.11a Chain 0 / CH149

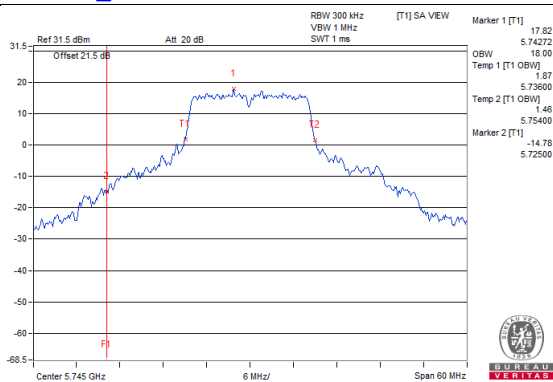

802.11a Chain 1 / CH149

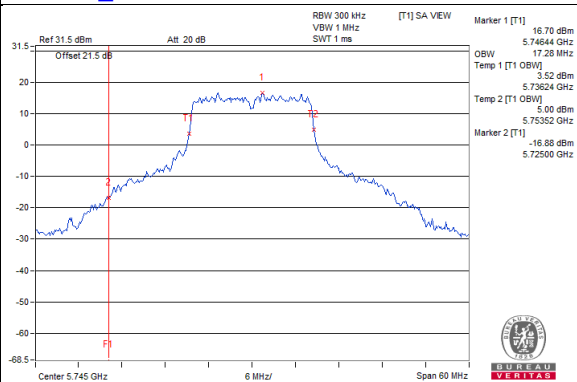

802.11ax (HE20) Chain 0 / CH149

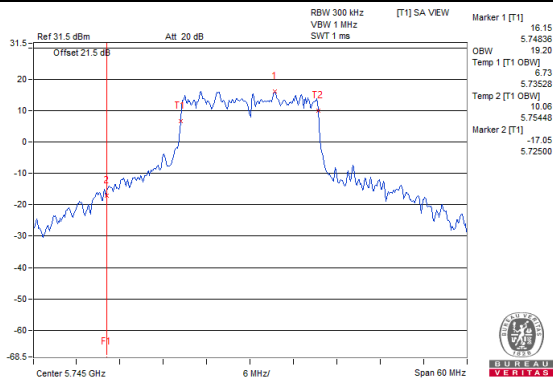

802.11ax (HE20) Chain 1 / CH149

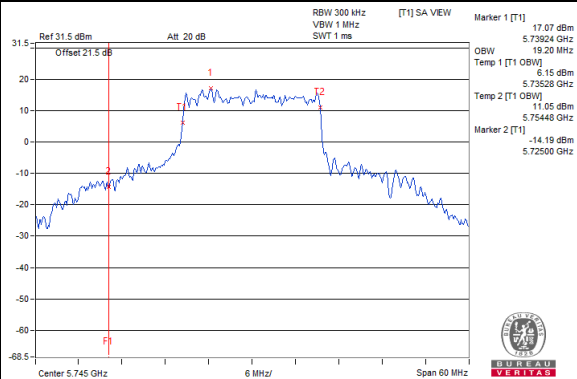

802.11ax (HE40) Chain 0 / CH151

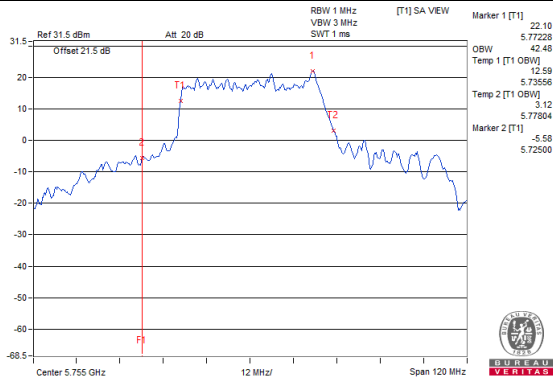

802.11ax (HE40) Chain 1 / CH151

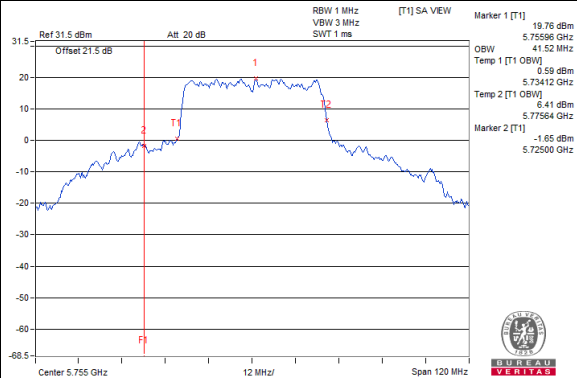

802.11ax (HE80) Chain 0 / CH155

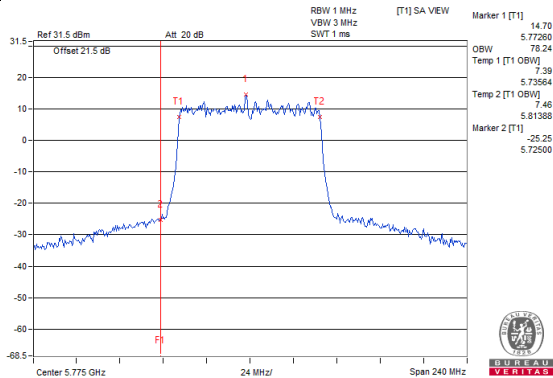

802.11ax (HE80) Chain 1 / CH155

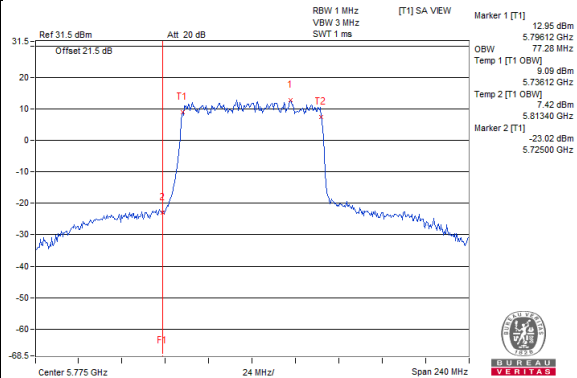

4.5 Peak Power Spectral Density Measurement

4.5.1 Limits of Peak Power Spectral Density Measurement

Operation Band	EUT Category		Limit
U-NII-1		Outdoor Access Point	17dBm/ MHz
		Fixed point-to-point Access Point	
	√	Indoor Access Point	
		Client device	
U-NII-2A			11dBm/ MHz
U-NII-2C			11dBm/ MHz
U-NII-3		√	30dBm/ 500kHz

4.5.2 Test Setup

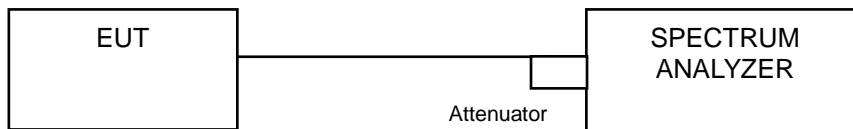

4.5.3 Test Instruments

Refer to section 4.1.2 to get information of above instrument.

4.5.4 Test Procedure

For U-NII-1:

Using method SA-1

1. Set span to encompass the entire emission bandwidth (EBW) of the signal.
2. Set RBW = 1 MHz, Set VBW \geq 3 MHz, Detector = RMS
3. Sweep time = auto, trigger set to "free run".
4. Trace average at least 100 traces in power averaging mode.
5. Record the max value

For U-NII-3:

1. Set span to encompass the entire emission bandwidth (EBW) of the signal.
2. Set RBW = 300 kHz, Set VBW \geq 1 MHz, Detector = RMS
3. Use the peak marker function to determine the maximum power level in any 300 kHz band segment within the fundamental EBW.
4. Scale the observed power level to an equivalent value in 500 kHz by adjusting (reducing) the measured power by a bandwidth correction factor (BWCF) where $BWCF = 10\log(500\text{ kHz}/300\text{ kHz})$
5. Sweep time = auto, trigger set to "free run".
6. Trace average at least 100 traces in power averaging mode.
7. Record the max value

4.5.5 Deviation from Test Standard

No deviation.

4.5.6 EUT Operating Condition

Same as Item 4.3.6.

4.5.7 Test Results

Non-Beamforming Mode

For U-NII-1:

802.11a

Chan.	Chan. Freq. (MHz)	PSD (dBm/MHz)		Total PSD (dBm/MHz)	Max. PSD Limit (dBm/MHz)	Pass / Fail
		Chain 0	Chain 1			
36	5180	10.61	9.78	13.23	16.60	PASS
40	5200	13.57	12.72	16.18	16.60	PASS
48	5240	11.80	11.57	14.70	16.60	PASS

- Note: 1. Method a) of power density measurement of KDB 662911 is using for calculating total power density. Total power density is summing entire spectra across corresponding frequency bins on the various outputs by computer.
2. The directional gain = $10 \log[(10^{G0/20} + 10^{G1/20})^2 / 2]$ = 6.4 dBi > 6dBi, so the power density limit shall be reduced to $17-(6.4-6) = 16.60$ dBm.

802.11ax (HE20)

Chan.	Chan. Freq. (MHz)	PSD (dBm/MHz)		Total PSD (dBm/MHz)	Max. PSD Limit (dBm/MHz)	Pass / Fail
		Chain 0	Chain 1			
36	5180	11.00	9.39	13.28	16.60	PASS
40	5200	12.95	12.47	15.73	16.60	PASS
48	5240	11.50	11.61	14.57	16.60	PASS

- Note: 1. Method a) of power density measurement of KDB 662911 is using for calculating total power density. Total power density is summing entire spectra across corresponding frequency bins on the various outputs by computer.
2. The directional gain = $10 \log[(10^{G0/20} + 10^{G1/20})^2 / 2]$ = 6.4 dBi > 6dBi, so the power density limit shall be reduced to $17-(6.4-6) = 16.60$ dBm.

802.11ax (HE40)

Chan.	Chan. Freq. (MHz)	PSD (dBm/MHz)		Total PSD (dBm/MHz)	Max. PSD Limit (dBm/MHz)	Pass / Fail
		Chain 0	Chain 1			
38	5190	2.19	1.89	5.05	16.60	PASS
46	5230	7.41	10.17	12.02	16.60	PASS

- Note: 1. Method a) of power density measurement of KDB 662911 is using for calculating total power density. Total power density is summing entire spectra across corresponding frequency bins on the various outputs by computer.
2. The directional gain = $10 \log[(10^{G0/20} + 10^{G1/20})^2 / 2]$ = 6.4 dBi > 6dBi, so the power density limit shall be reduced to $17-(6.4-6) = 16.60$ dBm.

802.11ax (HE80)

Chan.	Chan. Freq. (MHz)	PSD (dBm/MHz)		Total PSD (dBm/MHz)	Max. PSD Limit (dBm/MHz)	Pass / Fail
		Chain 0	Chain 1			
42	5210	-2.17	-2.84	0.52	16.60	PASS

- Note: 1. Method a) of power density measurement of KDB 662911 is using for calculating total power density. Total power density is summing entire spectra across corresponding frequency bins on the various outputs by computer.
2. The directional gain = $10 \log[(10^{G0/20} + 10^{G1/20})^2 / 2] = 6.4 \text{ dBi} > 6 \text{ dBi}$, so the power density limit shall be reduced to $17 - (6.4 - 6) = 16.60 \text{ dBm}$.

Spectrum Plot of Worst Value

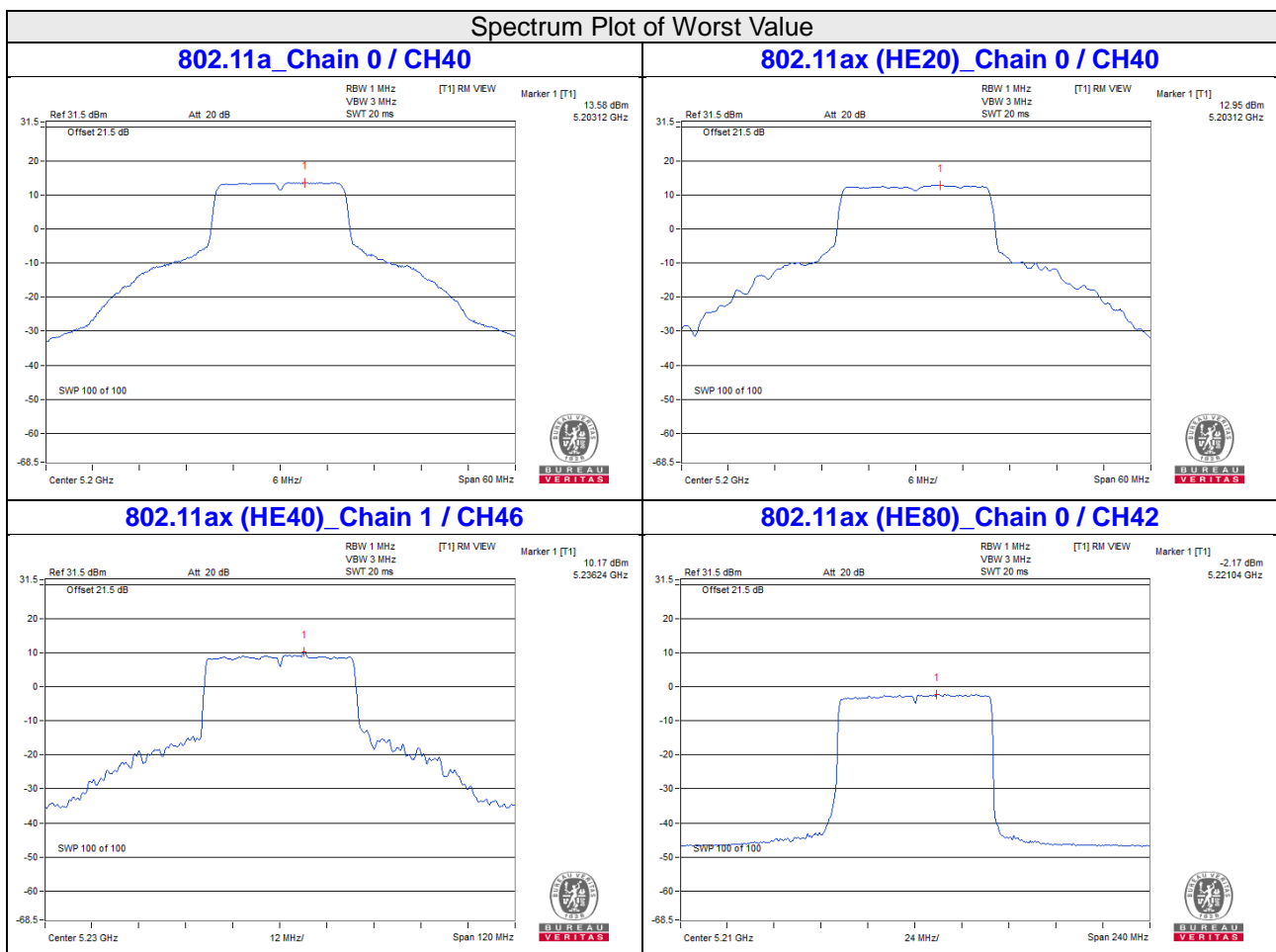

For U-NII-3:
802.11a

Chan.	Chan. Freq. (MHz)	PSD (dBm/300kHz)		Total PSD (mW/300kHz)	Total PSD (dBm/300kHz)	Total PSD (dBm/500kHz)	PSD Limit (dBm/500kHz)	Pass / Fail
		Chain 0	Chain 1					
149	5745	4.43	3.69	5.117	7.09	9.31	29.57	PASS
157	5785	5.26	4.25	6.012	7.79	10.01	29.57	PASS
165	5825	4.38	3.31	4.887	6.89	9.11	29.57	PASS

- Note: 1. Method b) Measure and sum spectral maxima across the outputs of KDB 662911 is using for calculating total power density.
 2. The directional gain = $10 \log[(10^{G0/20} + 10^{G1/20})^2 / 2] = 6.43 \text{ dBi} > 6\text{dBi}$, so the power density limit shall be reduced to $30-(6.43-6) = 29.57 \text{ dBm}$.

802.11ax (HE20)

Chan.	Chan. Freq. (MHz)	PSD (dBm/300kHz)		Total PSD (mW/300kHz)	Total PSD (dBm/300kHz)	Total PSD (dBm/500kHz)	PSD Limit (dBm/500kHz)	Pass / Fail
		Chain 0	Chain 1					
149	5745	4.79	5.76	6.776	8.31	10.53	29.57	PASS
157	5785	4.57	5.48	6.397	8.06	10.28	29.57	PASS
165	5825	5.06	5.03	6.397	8.06	10.28	29.57	PASS

- Note: 1. Method b) Measure and sum spectral maxima across the outputs of KDB 662911 is using for calculating total power density.
 2. The directional gain = $10 \log[(10^{G0/20} + 10^{G1/20})^2 / 2] = 6.43 \text{ dBi} > 6\text{dBi}$, so the power density limit shall be reduced to $30-(6.43-6) = 29.57 \text{ dBm}$.

802.11ax (HE40)

Chan.	Chan. Freq. (MHz)	PSD (dBm/300kHz)		Total PSD (mW/300kHz)	Total PSD (dBm/300kHz)	Total PSD (dBm/500kHz)	PSD Limit (dBm/500kHz)	Pass / Fail
		Chain 0	Chain 1					
151	5755	1.57	2.55	3.236	5.10	7.32	29.57	PASS
159	5795	0.89	1.37	2.6	4.15	6.37	29.57	PASS

- Note: 1. Method b) Measure and sum spectral maxima across the outputs of KDB 662911 is using for calculating total power density.
 2. The directional gain = $10 \log[(10^{G0/20} + 10^{G1/20})^2 / 2] = 6.43 \text{ dBi} > 6\text{dBi}$, so the power density limit shall be reduced to $30-(6.43-6) = 29.57 \text{ dBm}$.

802.11ax (HE80)

Chan.	Chan. Freq. (MHz)	PSD (dBm/300kHz)		Total PSD (mW/300kHz)	Total PSD (dBm/300kHz)	Total PSD (dBm/500kHz)	PSD Limit (dBm/500kHz)	Pass / Fail
		Chain 0	Chain 1					
155	5775	-6.14	-5.25	0.542	-2.66	-0.44	29.57	PASS

- Note: 1. Method b) Measure and sum spectral maxima across the outputs of KDB 662911 is using for calculating total power density.
 2. The directional gain = $10 \log[(10^{G0/20} + 10^{G1/20})^2 / 2] = 6.43 \text{ dBi} > 6 \text{ dBi}$, so the power density limit shall be reduced to $30 - (6.43 - 6) = 29.57 \text{ dBm}$.

Spectrum Plot of Worst Value

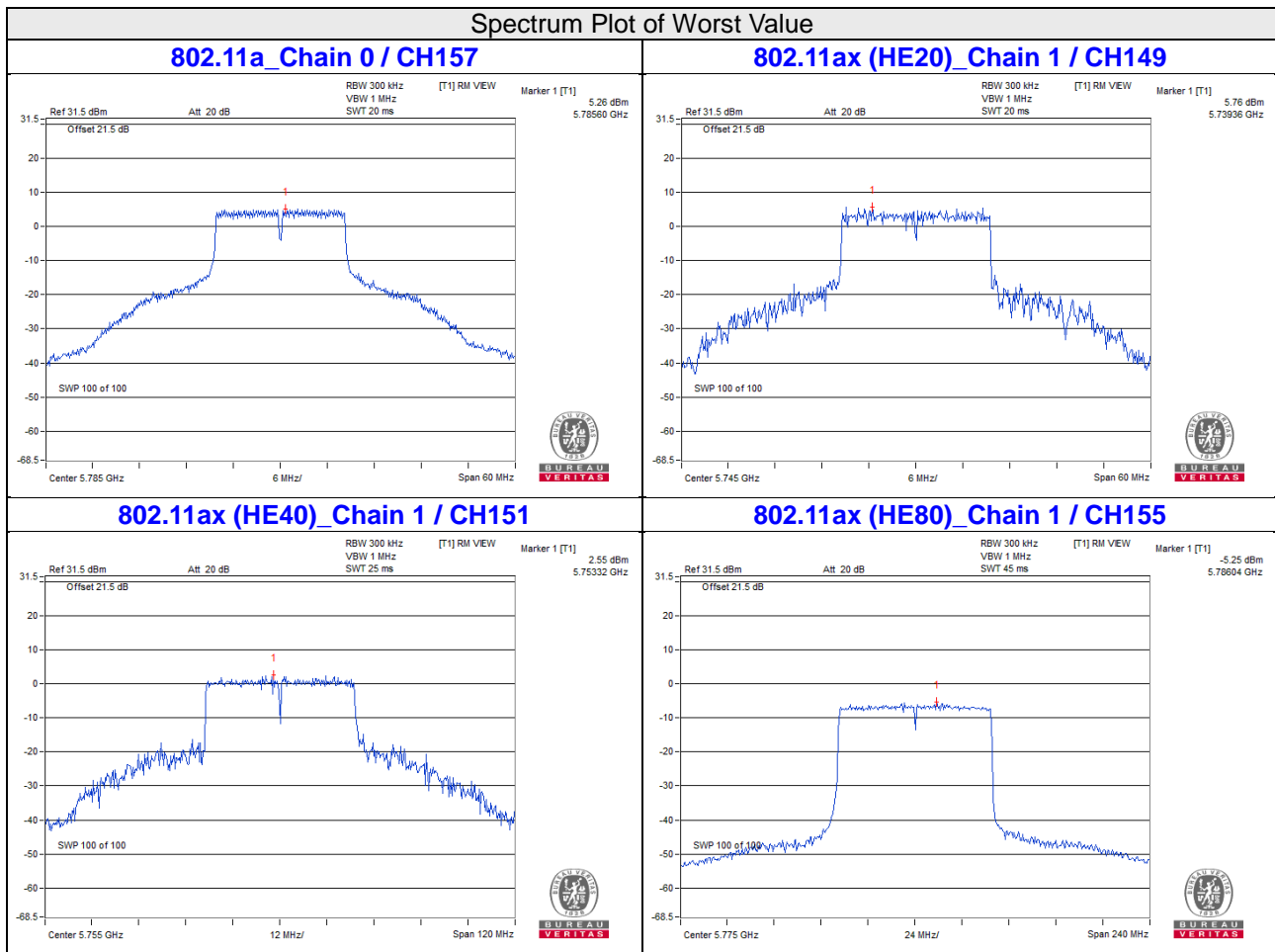

4.6 Frequency Stability Measurement

4.6.1 Limits of Frequency Stability Measurement

The frequency of the carrier signal shall be maintained within band of operation

4.6.2 Test Setup

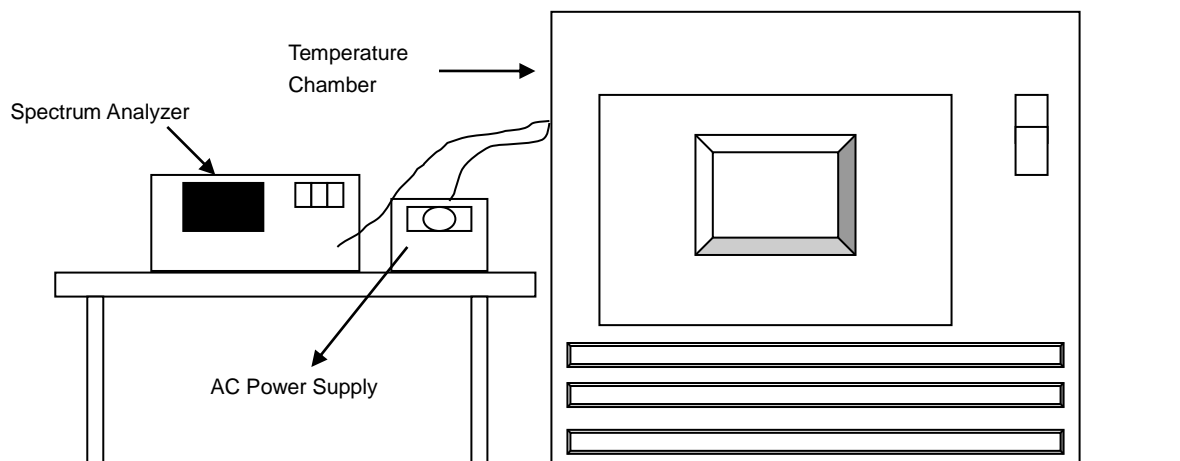

4.6.3 Test Instruments

Refer to section 4.1.2 to get information of above instrument.

4.6.4 Test Procedure

- The EUT was placed inside the environmental test chamber and powered by nominal AC voltage.
- Turn the EUT on and couple its output to a spectrum analyzer.
- Turn the EUT off and set the chamber to the highest temperature specified.
- Allow sufficient time (approximately 30 min) for the temperature of the chamber to stabilize, turn the EUT on and measure the operating frequency after 2, 5, and 10 Minutes.
- Repeat step (d) with the temperature chamber set to the next desired temperature until measurements down to the lowest specified temperature have been completed.
- The test chamber was allowed to stabilize at +20 degree C for a minimum of 30 Minutes. The supply voltage was then adjusted on the EUT from 85% to 115% and the frequency record.

4.6.5 Deviation from Test Standard

No deviation.

4.6.6 EUT Operating Condition

Set the EUT transmit at un-modulation mode to test frequency stability.

4.6.7 Test Results

Frequency Stability Versus Temp.									
Operating Frequency: 5180 MHz									
TEMP. (°C)	Power Supply (Vac)	0 Minute		2 Minutes		5 Minutes		10 Minutes	
		Measured Frequency (MHz)	Pass/Fail	Measured Frequency (MHz)	Pass/Fail	Measured Frequency (MHz)	Pass/Fail	Measured Frequency (MHz)	Pass/Fail
40	120	5180.0207	PASS	5180.0172	PASS	5180.0188	PASS	5180.0198	PASS
30	120	5180.0164	PASS	5180.0151	PASS	5180.0185	PASS	5180.0156	PASS
20	120	5179.9784	PASS	5179.9777	PASS	5179.9788	PASS	5179.9753	PASS
10	120	5179.9731	PASS	5179.9753	PASS	5179.9755	PASS	5179.9734	PASS
0	120	5179.9859	PASS	5179.9838	PASS	5179.9835	PASS	5179.9829	PASS

Frequency Stability Versus Voltage									
Operating Frequency: 5180 MHz									
TEMP. (°C)	Power Supply (Vac)	0 Minute		2 Minutes		5 Minutes		10 Minutes	
		Measured Frequency (MHz)	Pass/Fail	Measured Frequency (MHz)	Pass/Fail	Measured Frequency (MHz)	Pass/Fail	Measured Frequency (MHz)	Pass/Fail
20	138	5179.9787	PASS	5179.9775	PASS	5179.9789	PASS	5179.9755	PASS
	120	5179.9784	PASS	5179.9777	PASS	5179.9788	PASS	5179.9753	PASS
	102	5179.9786	PASS	5179.977	PASS	5179.979	PASS	5179.9749	PASS

4.7 6dB Bandwidth Measurement

4.7.1 Limits of 6dB Bandwidth Measurement

The minimum of 6dB Bandwidth Measurement is 0.5MHz.

4.7.2 Test Setup

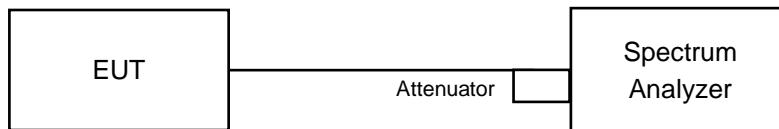

4.7.3 Test Instruments

Refer to section 4.1.2 to get information of above instrument.

4.7.4 Test Procedure

MEASUREMENT PROCEDURE REF

- Set resolution bandwidth (RBW) = 100kHz
- Set the video bandwidth (VBW) $\geq 3 \times$ RBW, Detector = Peak.
- Trace mode = max hold.
- Sweep = auto couple.
- Measure the maximum width of the emission that is constrained by the frequencies associated with the two amplitude points (upper and lower) that are attenuated by 6 dB relative to the maximum level measured in the fundamental emission.

4.7.5 Deviation from Test Standard

No deviation.

4.7.6 EUT Operating Condition

The software provided by client to enable the EUT under transmission condition continuously at lowest, middle and highest channel frequencies individually.

4.7.7 Test Results

802.11a

Channel	Frequency (MHz)	6dB Bandwidth (MHz)		Minimum Limit (MHz)	Pass / Fail
		Chain 0	Chain 1		
149	5745	16.63	16.58	0.5	Pass
157	5785	16.63	16.57	0.5	Pass
165	5825	16.63	16.57	0.5	Pass

802.11ac (VHT20)

Channel	Frequency (MHz)	6dB Bandwidth (MHz)		Minimum Limit (MHz)	Pass / Fail
		Chain 0	Chain 1		
149	5745	19.13	19.13	0.5	Pass
157	5785	19.15	19.04	0.5	Pass
165	5825	19.17	19.21	0.5	Pass

802.11ac (VHT40)

Channel	Frequency (MHz)	6dB Bandwidth (MHz)		Minimum Limit (MHz)	Pass / Fail
		Chain 0	Chain 1		
151	5755	38.32	38.37	0.5	Pass
159	5795	38.3	38.21	0.5	Pass

802.11ac (VHT80)

Channel	Frequency (MHz)	6dB Bandwidth (MHz)		Minimum Limit (MHz)	Pass / Fail
		Chain 0	Chain 1		
155	5775	78.47	78.39	0.5	Pass

Spectrum Plot of Worst Value

802.11a_Chain 1 / CH157

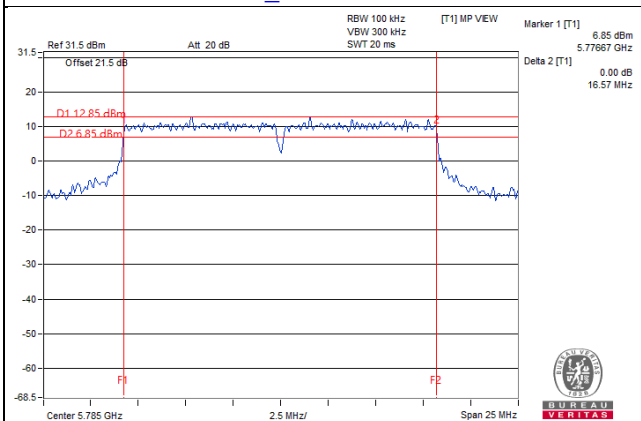

802.11ac (VHT20)_Chain 1 / CH157

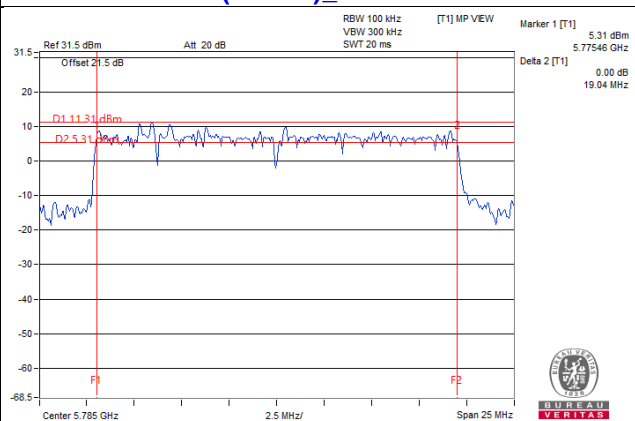

802.11ac (VHT40)_Chain 1 / CH159

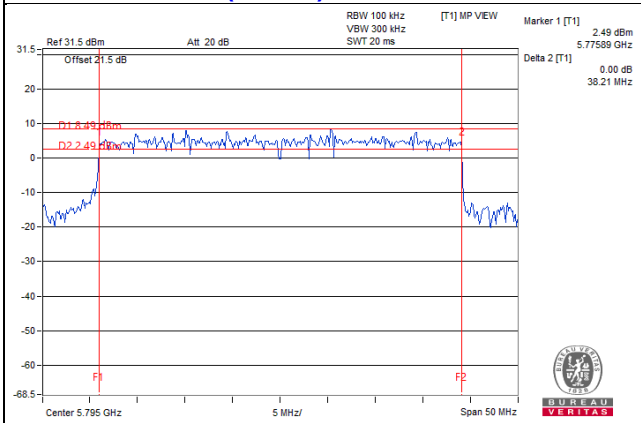

802.11ac (VHT80)_Chain 1 / CH155

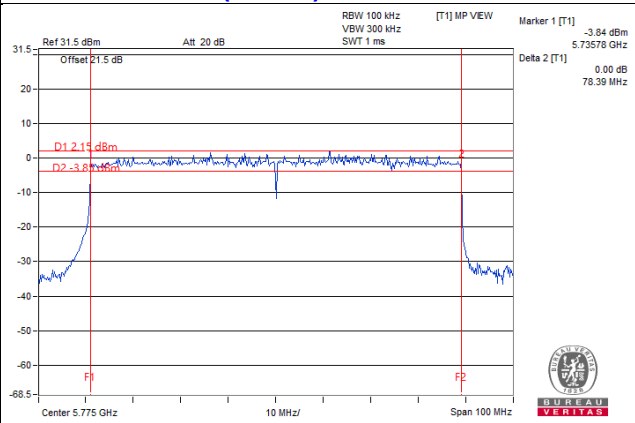

5 Pictures of Test Arrangements

Please refer to the attached file (Test Setup Photo).

Annex A- Radiated Out of Band Emission (OOBE) Measurement (For U-NII-3 band)

802.11a

CH 149 5745 MHz

Horizontal

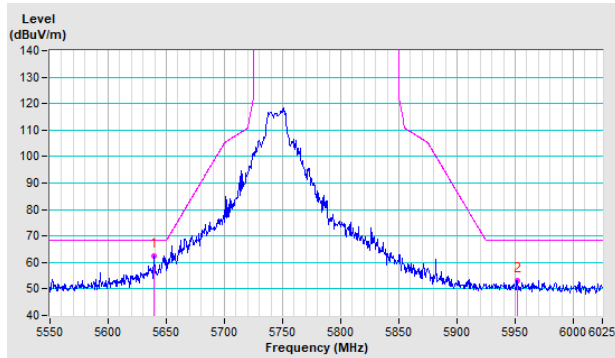

Vertical

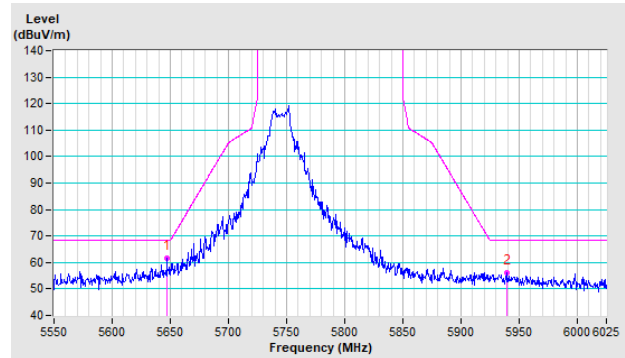

CH 157 5785 MHz

Horizontal

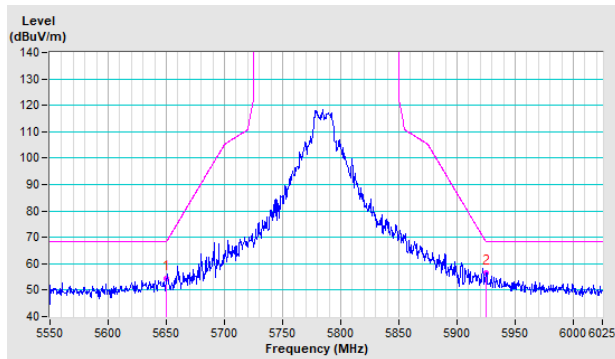

Vertical

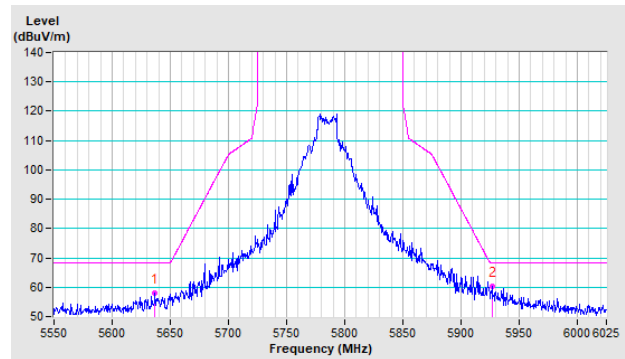

CH 165 5825 MHz

Horizontal

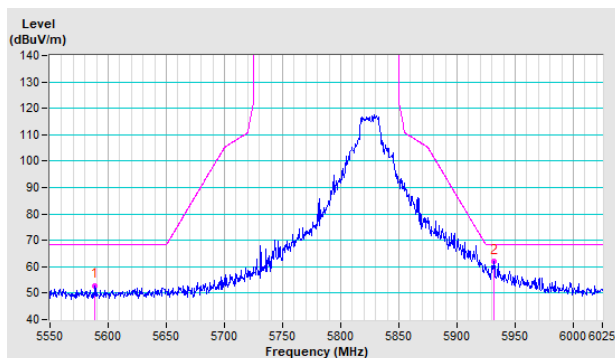

Vertical

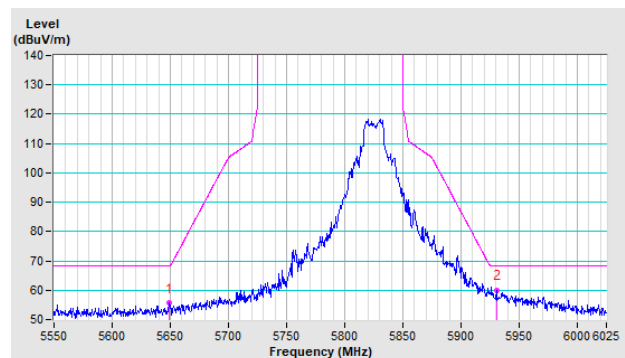

802.11ax (HE20)

CH 149 5745 MHz

Horizontal

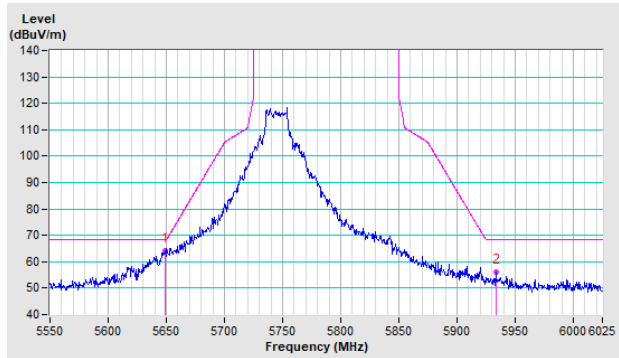

Vertical

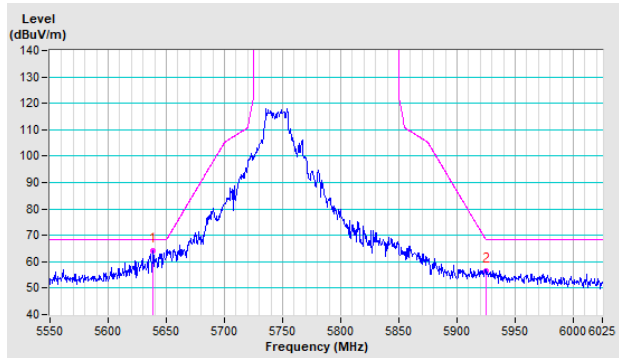

CH 157 5785 MHz

Horizontal

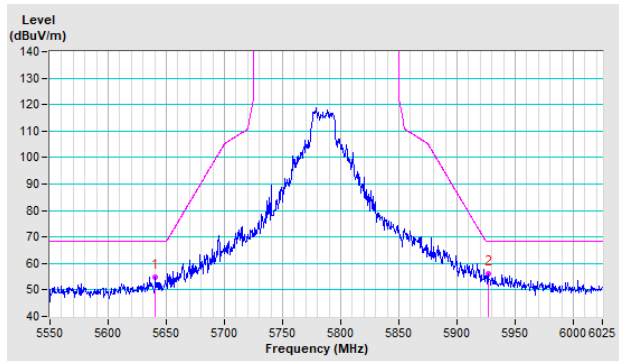

Vertical

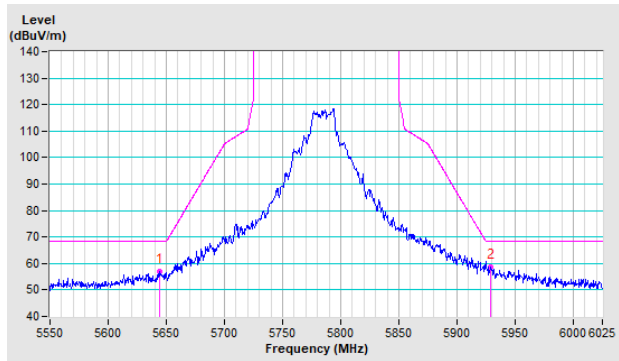

CH 165 5825 MHz

Horizontal

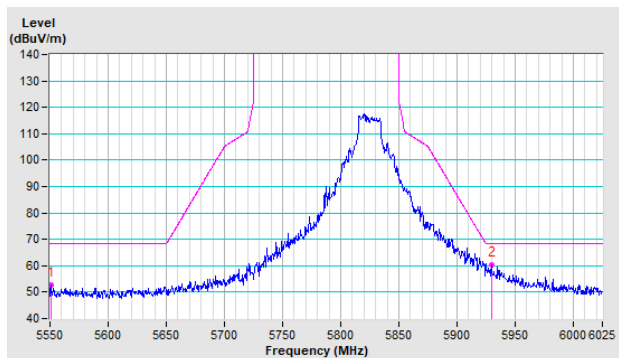

Vertical

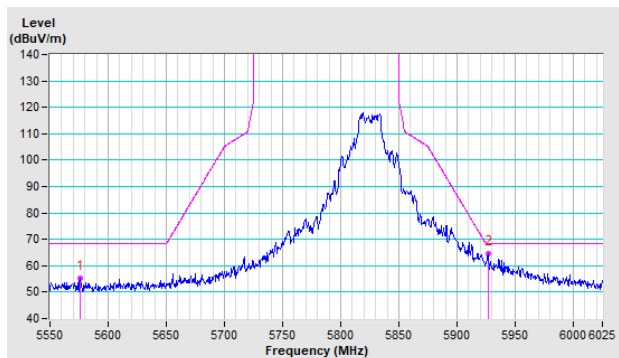

802.11ax (HE40)

CH 151 5755 MHz

Horizontal

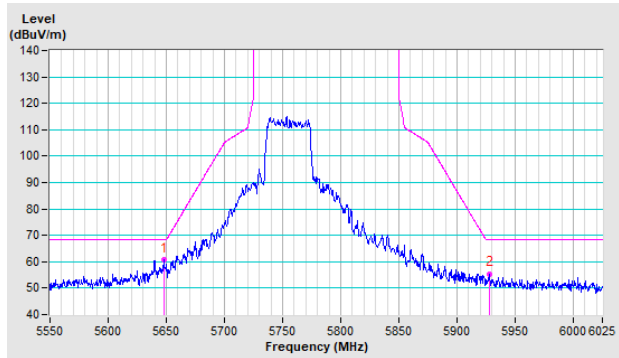

Vertical

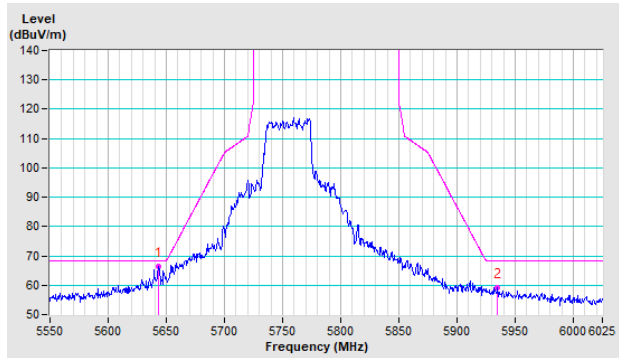

CH 159 5795 MHz

Horizontal

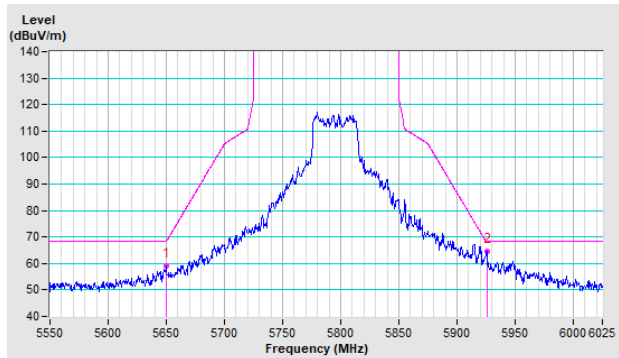

Vertical

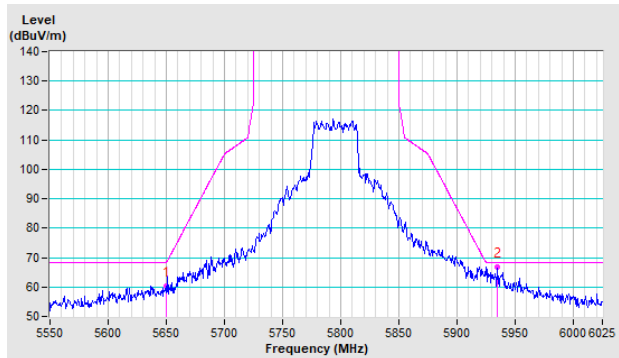

802.11ax (HE80)

CH 155 5775 MHz

Horizontal

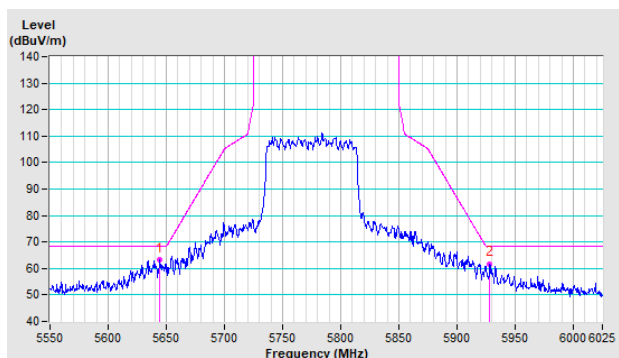

Vertical

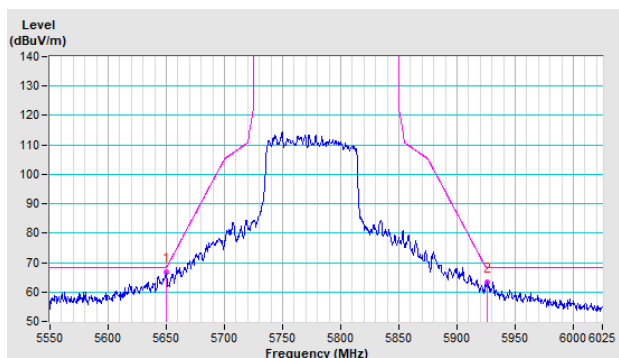

Annex B- Band-edge measurement (For U-NII-1 band)

802.11a

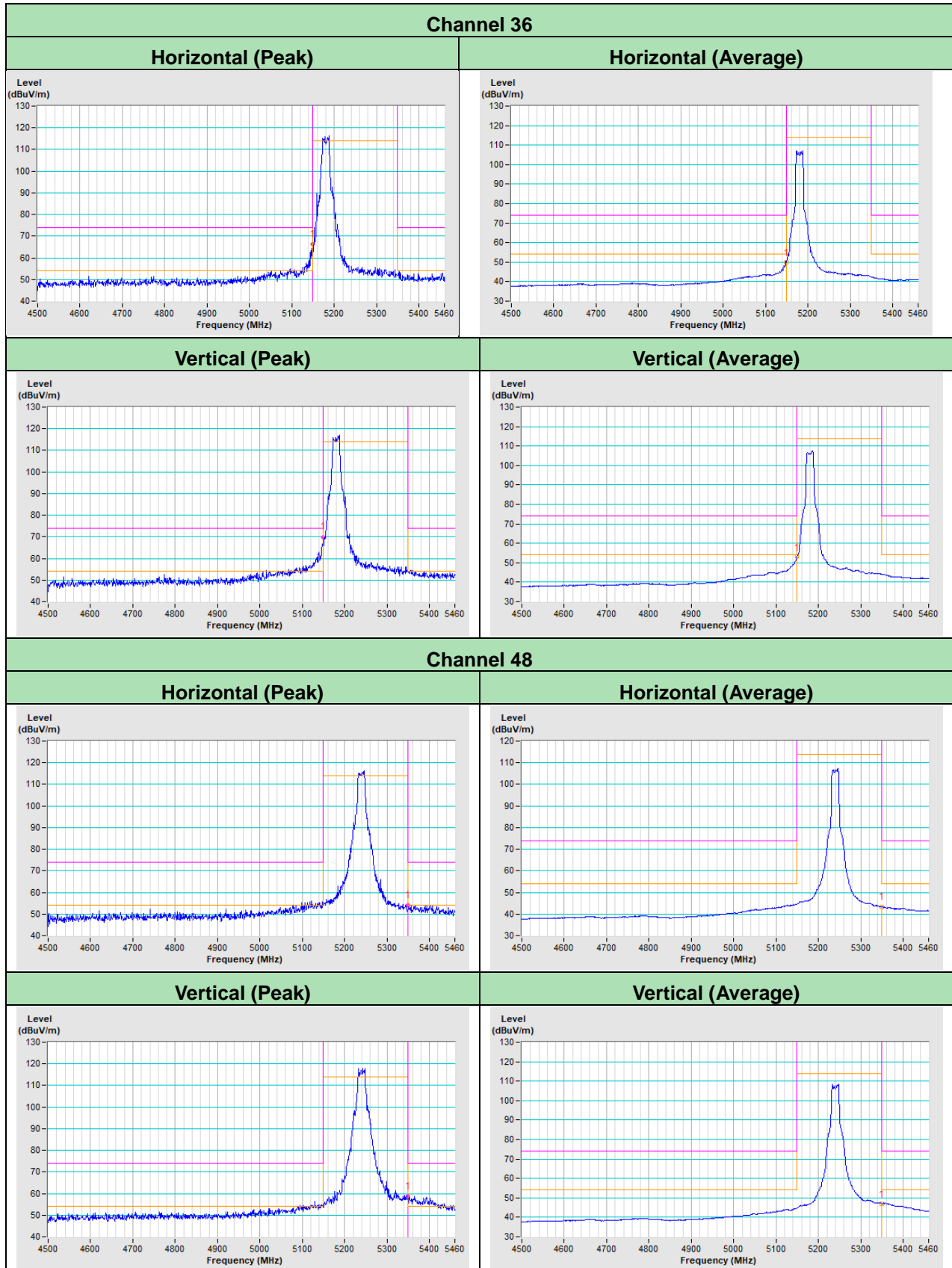

802.11ax (HE20)

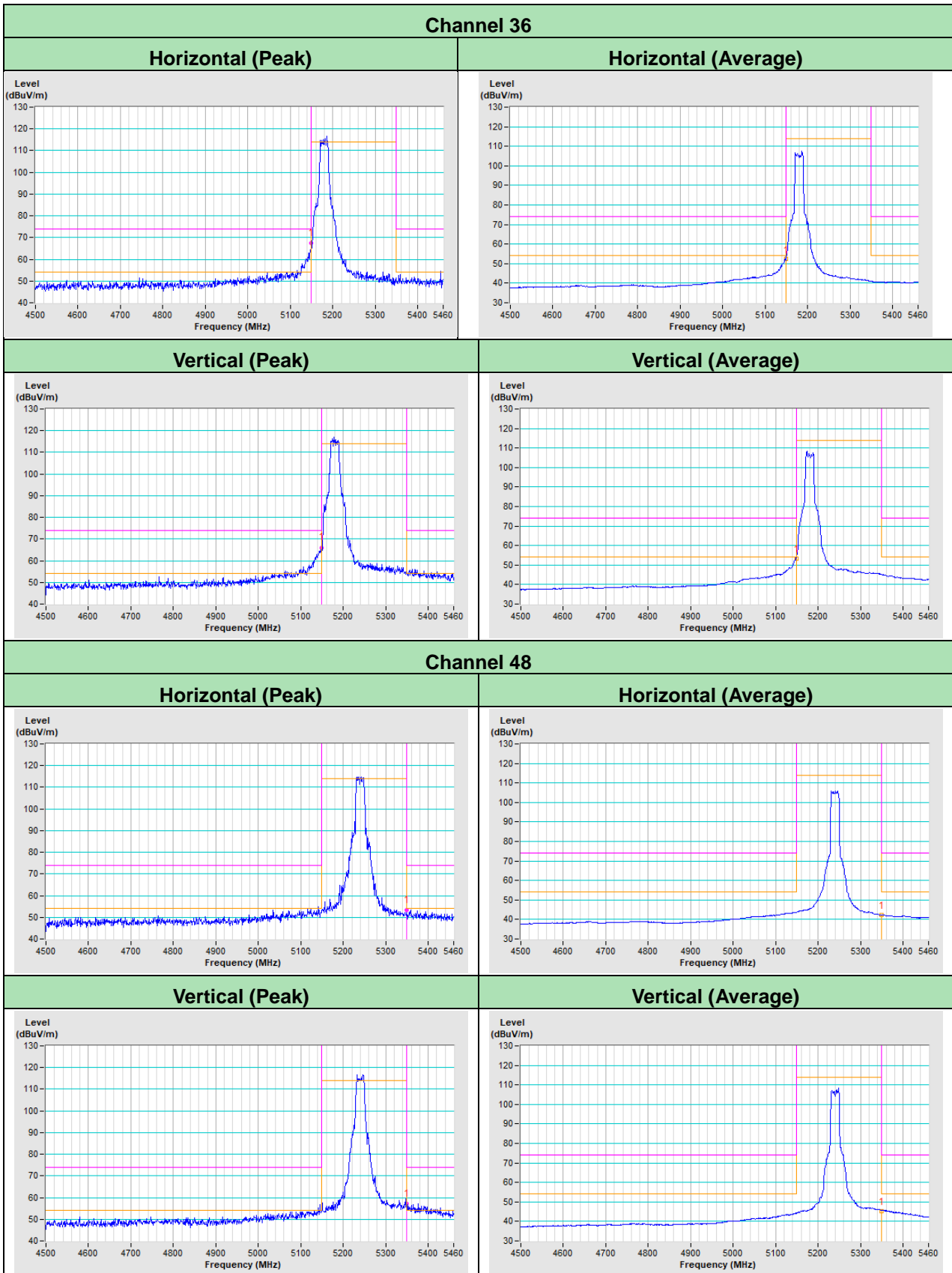

802.11ax (HE40)

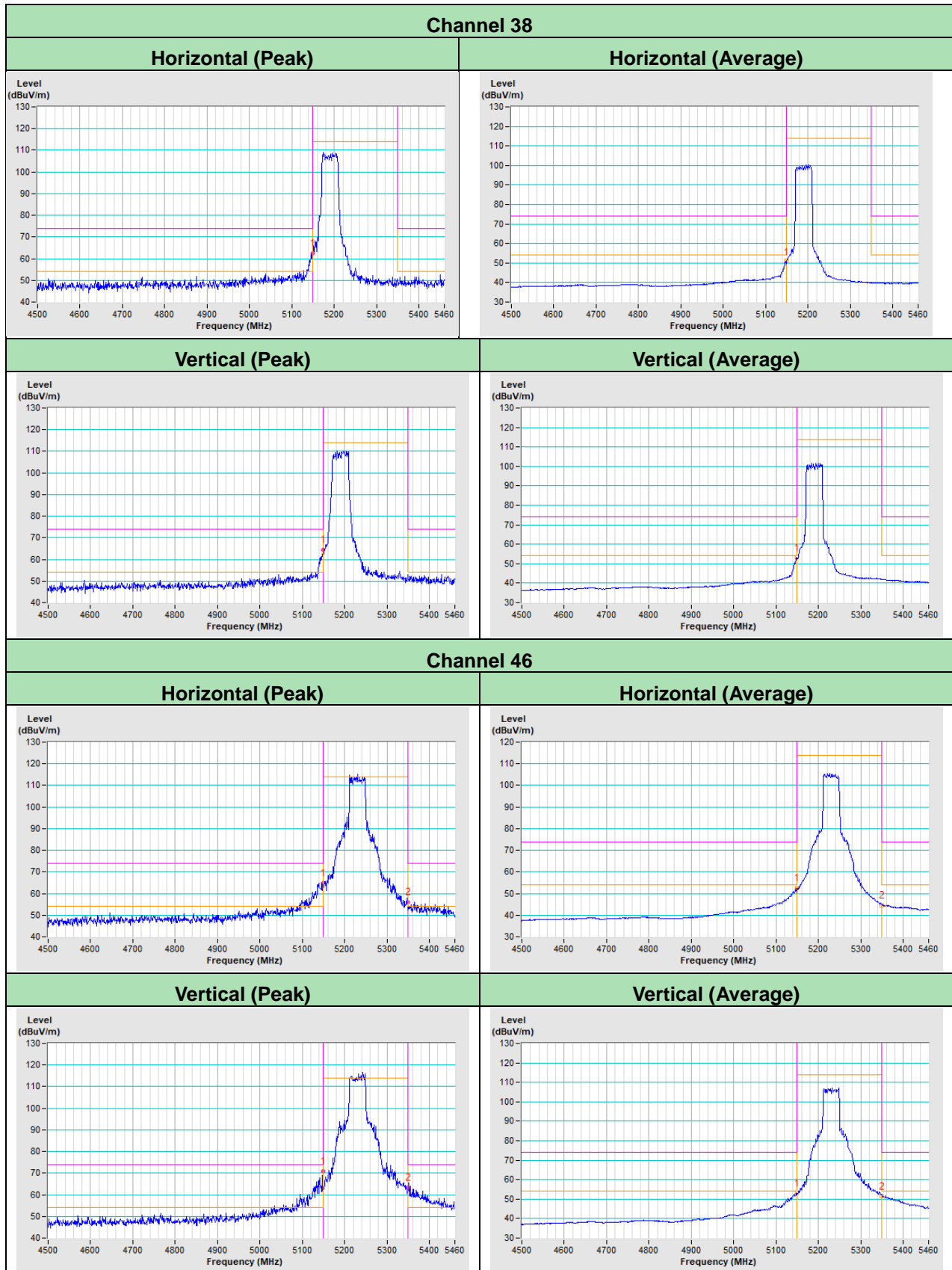

802.11ax (HE80)

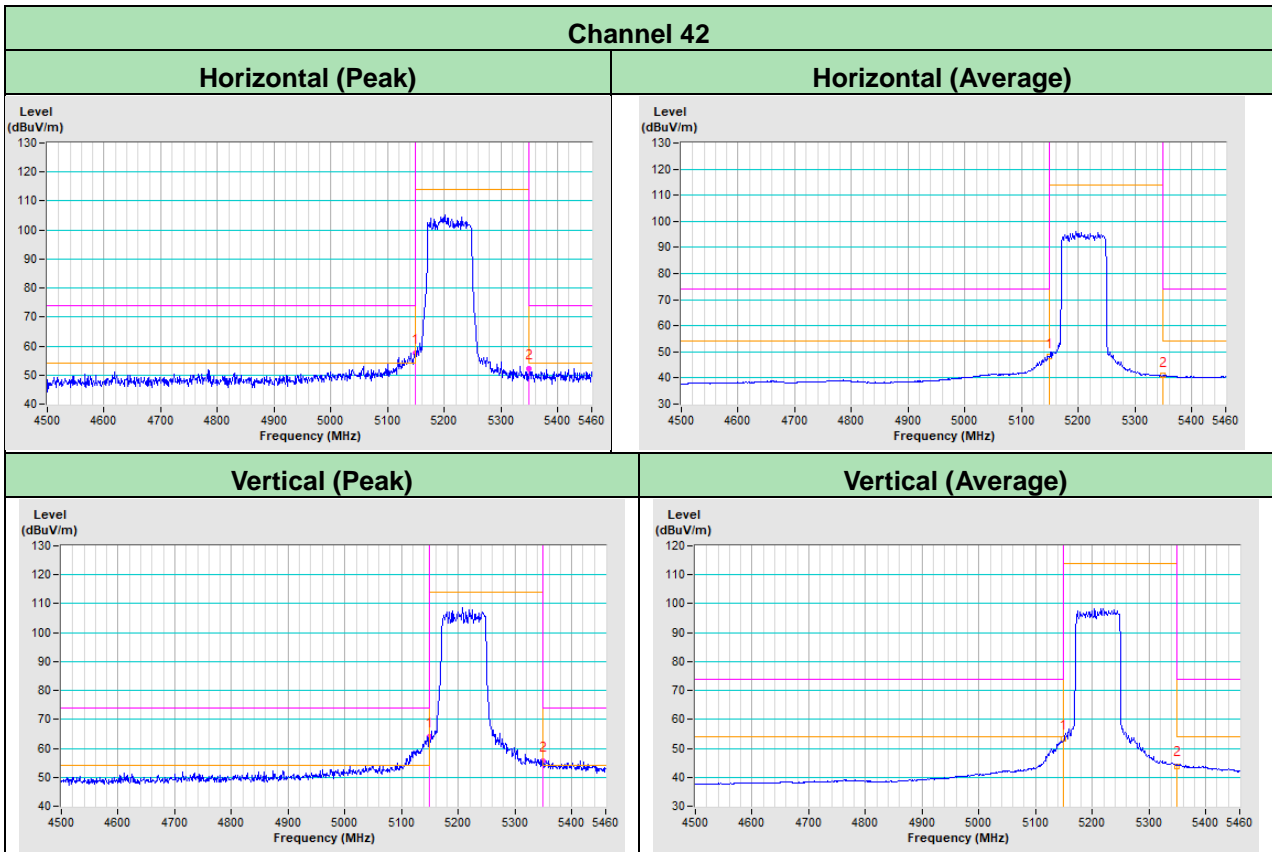

Appendix – Information of the Testing Laboratories

We, Bureau Veritas Consumer Products Services (H.K.) Ltd., Taoyuan Branch, were founded in 1988 to provide our best service in EMC, Radio, Telecom and Safety consultation. Our laboratories are FCC recognized accredited test firms and accredited according to ISO/IEC 17025.

If you have any comments, please feel free to contact us at the following:

Lin Kou EMC/RF Lab

Tel: 886-2-26052180

Fax: 886-2-26051924

Hsin Chu EMC/RF/Telecom Lab

Tel: 886-3-6668565

Fax: 886-3-6668323

Hwa Ya EMC/RF/Safety Lab

Tel: 886-3-3183232

Fax: 886-3-3270892

Email: service.adt@tw.bureauveritas.com

Web Site: www.bureauveritas-adt.com

The address and road map of all our labs can be found in our web site also.

--- END ---