

EMC TEST REPORT

Report No. : EME-031072

Model No. : B-120

Issued Date : Sep. 25, 2003

Applicant : ZyXEL Communications Corporation
No. 6, Innovation Rd II, Science-Based Industrial Park,
Hsin-Chu, Taiwan

Test By : Intertek Testing Services Taiwan Ltd.
No. 11, Lane 275, Ko-Nan 1 Street, Chia-Tung Li,
Shiang-Shan District, Hsinchu City, Taiwan

This test report consists of 42 pages in total. It may be duplicated completely for legal use with the allowance of the applicant. It shall not be reproduced except in full, without the written approval of Intertek Laboratory. The test result in this report only applies to the tested sample.

Project Engineer



Jerry Liu

Reviewed By



Elton Chen

Table of Contents

| | |
|---|----|
| Summary of Tests..... | 3 |
| 1. General information | 4 |
| 1.1 Identification of the EUT | 4 |
| 1.2 Additional information about the EUT | 4 |
| 1.3 Antenna description | 5 |
| 1.4 Peripherals equipment..... | 5 |
| 2. Test specifications | 6 |
| 2.1 Test standard | 6 |
| 2.2 Operation mode | 6 |
| 2.3 Test equipment..... | 7 |
| 3. Minimum 6dB Bandwidth test..... | 8 |
| 3.1 Operating environment | 8 |
| 3.2 Test setup & procedure..... | 8 |
| 3.3 Measured data of Minimum 6dB Bandwidth test results..... | 8 |
| 4. Maximum Output Power test..... | 12 |
| 4.1 Operating environment | 12 |
| 4.2 Test setup & procedure..... | 12 |
| 4.3 Measured data of Maximum Output Power test results..... | 12 |
| 5. Radiated Emission test | 13 |
| 5.1 Operating environment | 13 |
| 5.2 Test setup & procedure..... | 13 |
| 5.3 Emission limits | 14 |
| 5.4 Radiated spurious emission test data | 15 |
| 5.4.1 Measurement results: frequencies equal to or less than 1 GHz..... | 15 |
| 5.4.2 Measurement results: frequency above 1GHz..... | 18 |
| 6. Power Spectrum Density test..... | 21 |
| 6.1 Operating environment | 21 |
| 6.2 Test setup & procedure..... | 21 |
| 6.3 Measured data of Power Spectrum Density test results..... | 21 |
| 7. Emission on the band edge §FCC 15.247(C) | 25 |
| 7.1 Band-edge (Conducted method)..... | 26 |
| 7.2 Band-edge (Radiated method)..... | 28 |
| 8. Power Line Conducted Emission test §FCC 15.207 | 32 |
| 8.1 Operating environment | 32 |
| 8.2 Test setup & procedure..... | 32 |
| 8.3 Power Line Conducted Emission test data..... | 34 |

Summary of Tests**Wireless Lan PC Card -Model: B-120
FCC ID: I88B-120**

| Test | Reference | Results |
|------------------------------------|----------------|----------|
| Minimum 6dB Bandwidth test | 15.247(a)(2) | Complies |
| Maximum Output Power test | 15.247(b) | Complies |
| Radiated Spurious Emission test | 15.205, 15.209 | Complies |
| Power Spectrum Density test | 15.247(d) | Complies |
| Power Line Conducted Emission test | 15.207 | Complies |

1. General information

1.1 Identification of the EUT

| | |
|---------------------------|---|
| Applicant | : ZyXEL Communications Corp. |
| Product | : Wireless Lan PC Card |
| Model No. | : B-120 |
| FCC ID. | : I88B-120 |
| Frequency Range | : 2412MHz to 2462MHz |
| Channel Number | : 11 |
| Frequency of Each Channel | : 2412MHz, 2417MHz, 2422MHz, 2427MHz, 2432MHz, 2437MHz, 2442MHz, 2447MHz, 2452MHz, 2457MHz, 2462MHz |
| Type of Modulation | : CCK (11Mps, 5.5Mbps), DQPSK (2Mbps), DBPSK (1Mbps) |
| Power Supply | : 5Vdc from Notebook |
| Power Cord | : N/A |
| Sample Received | : Sep. 18, 2003 |
| Test Date(s) | : Sep. 18, 2003 ~ Sep. 22, 2003 |

A FCC DoC report has been generated for the client.

1.2 Additional information about the EUT

The ZyAIR is an IEEE 802.11b compliant wireless PCMCIA card that fits into any type II PCMCIA slot. Its maximum 11 Mbps data rate, which gives Ethernet equivalent speed, is ideal in the corporate or home environment. Users enjoy the wireless mobility within the coverage area.

The EUT meets special requirements for full modular approval on FCC Public Notice DA 00-1407 and the device is only for OEM integrator, please refer the test result in this report.

The model ZyAIR B-120 and Telefonica B-120 are identical to model B-120 (EUT), the different model number serves as marketing strategy.

For more detail features, please refer to User's manual as file name "Installation guide.pdf"

1.3 Antenna description

The EUT uses a permanently connected antenna.

Antenna Gain : 2.5dBi

Antenna Type : Ceramic antenna

Connector Type : N/A

1.4 Peripherals equipment

| Peripherals | Manufacturer | Product No. | Serial No. | FCC ID |
|-------------|--------------|-------------|-----------------|---------------------|
| Notebook | IBM | 2662-K1T | FX-BP820 | FCC DoC Approved |
| Printer | HP | C2642A | TH86K1N2ZB | FCC DoC Approved |
| Modem | Dynalink | V1456VQE | 00V230A00051494 | FCC DoC Approved |

2. Test specifications

2.1 Test standard

The EUT was performed according to the procedures in FCC Part 15 Subpart C Section § 15.205 、 §15.207 、 §15.209 、 §15.247 and ANSI C63.4/1992.

The test of radiated measurements according to FCC Part15 Section 15.33(a) had been conducted and the field strength of this frequency band were all meet limit requirement, thus we evaluate the EUT pass the specified test.

2.2 Operation mode

Plug the EUT into Notebook via extend card, and turn on the power, then run the test program “ZDConfig” under Window OS.

The EUT was transmitted continuously during the test.

After verifying the maximum output power, we found the maximum output power was occurred at 11Mbps data rate. The final test was executed under this condition and recorded in this report individually.

2.3 Test equipment

| Equipment | Brand | Frequency range | Model No. | Series No. | Last Cal.Date |
|--|-----------------|-----------------|-----------|------------|---------------|
| EMI Test Receiver | Rohde & Schwarz | 9kHz~2.75GHz | ESCS 30 | 825788/014 | Feb. 18, 2003 |
| EMI Test Receiver | Rohde & Schwarz | 20Hz~26.5GHz | ESMI | 825428/005 | June 10, 2003 |
| Spectrum Analyzer | Rohde & Schwarz | 9kHz~30GHz | FSP 30 | 100137 | July 10, 2003 |
| Spectrum Analyzer | Rohde & Schwarz | 20Hz~40GHz | FSEK 30 | 100186 | Oct. 9, 2002 |
| Horn Antenna | EMCO | 1GHz~18GHz | 3115 | 9906-5890 | Sep. 19, 2002 |
| Horn Antenna | SCHWARZBECK | 14GHz~40GHz | BBHA 9170 | 159 | June 21, 2003 |
| Bilog Antenna | SCHWARZBECK | 25MHz~1.7GHz | VULB 9160 | 3133 | Feb. 21, 2003 |
| Turn Table | HDGmbH | N/A | DS 420S | 420/669/01 | N/A |
| Antenna Tower | HDGmbH | N/A | MA 240 | 240/573 | N/A |
| Microwave Amplifier | Agilent | 2GHz~26.5GHz | 8348A | 3111A00567 | Dec. 20, 2002 |
| Crystal Detector | Agilent | 10MHz~18GHz | 8472B | MY42240243 | N/A |
| Signal Generator | Rohde & Schwarz | 20MHz~27GHz | SMR27 | 100036 | Aug. 15, 2003 |
| Two Channel Digital Storage Oscilloscope | Tektronix | N/A | TDS1012 | C031679 | Aug. 16, 2003 |

Note:

1. The calibration interval of the above instruments is 12 months.

3. Minimum 6dB Bandwidth test

3.1 Operating environment

Temperature: 22 °C
Relative Humidity: 60 %
Atmospheric Pressure 1023 hPa

3.2 Test setup & procedure

The minimum 6dB bandwidth per FCC §15.247(a)(2) was measured using a 50 ohm spectrum analyzer with the resolutions bandwidth set at 100kHz, the video bandwidth set at 100kHz, and the SPAN>>RBW. The test was performed at 3 channels (lowest, middle and highest channel). The minimum 6-dB modulation bandwidth is in the following Table.

3.3 Measured data of Minimum 6dB Bandwidth test results

| Channel | Frequency (MHz) | Bandwidth (MHz) | Limit |
|---------|-----------------|-----------------|----------|
| Low | 2412 | 10.12 | > 500kHz |
| Middle | 2437 | 10.12 | > 500kHz |
| High | 2462 | 10.12 | > 500kHz |

Please see the plot below.

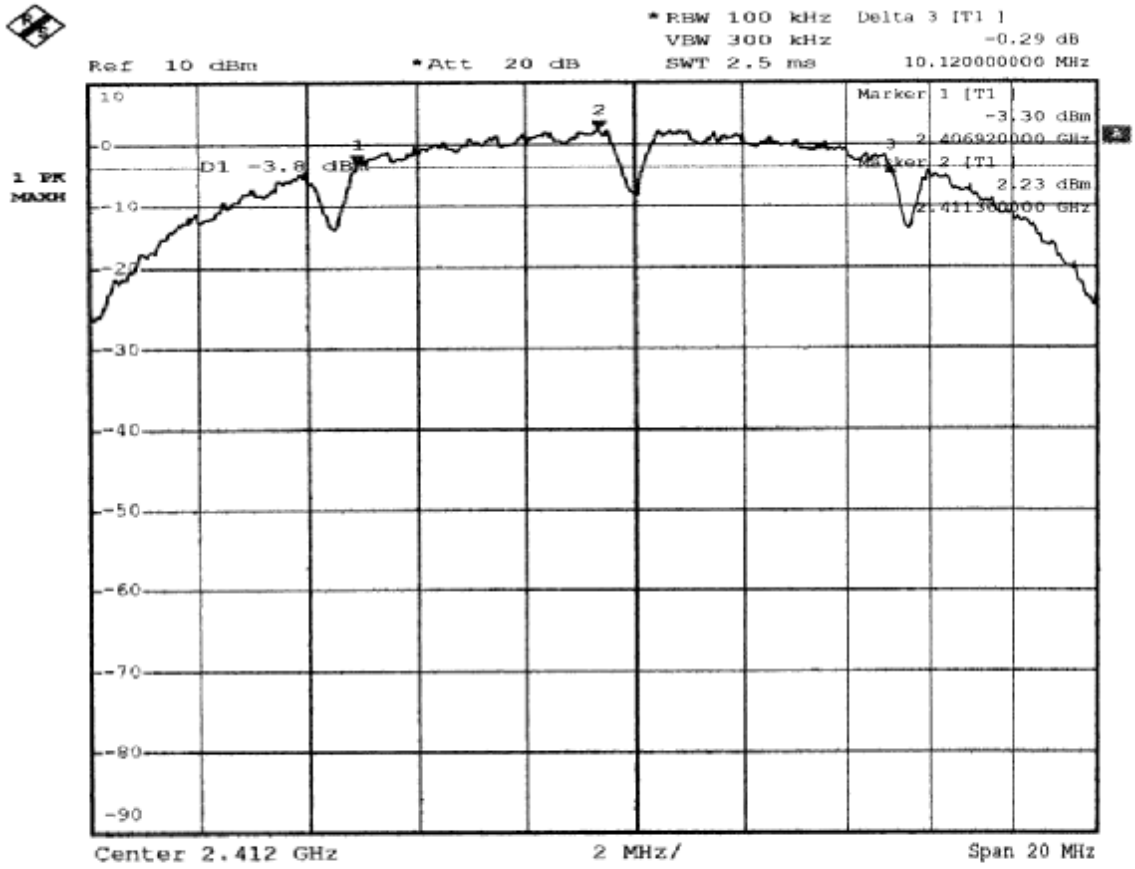

Comment A: 6dB bandwidth at low channel

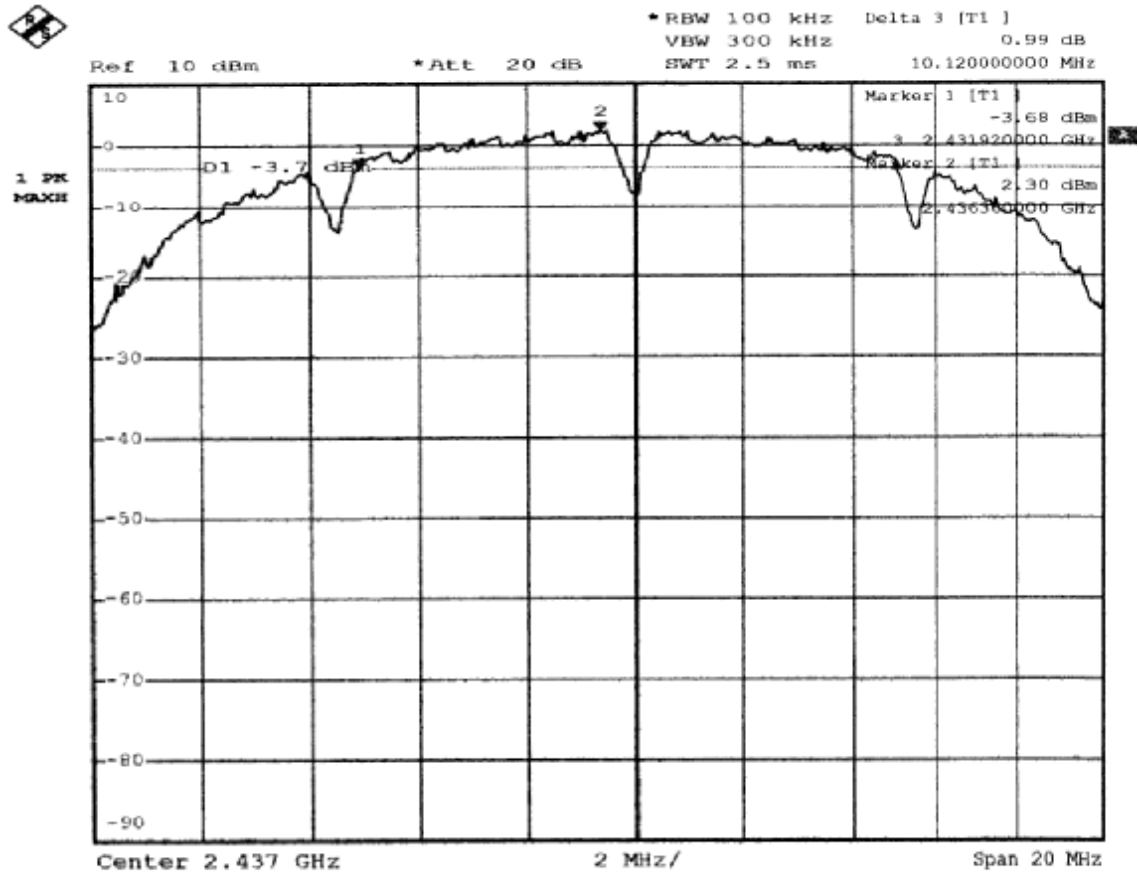

Comment A: 6dB bandwidth at middle channel

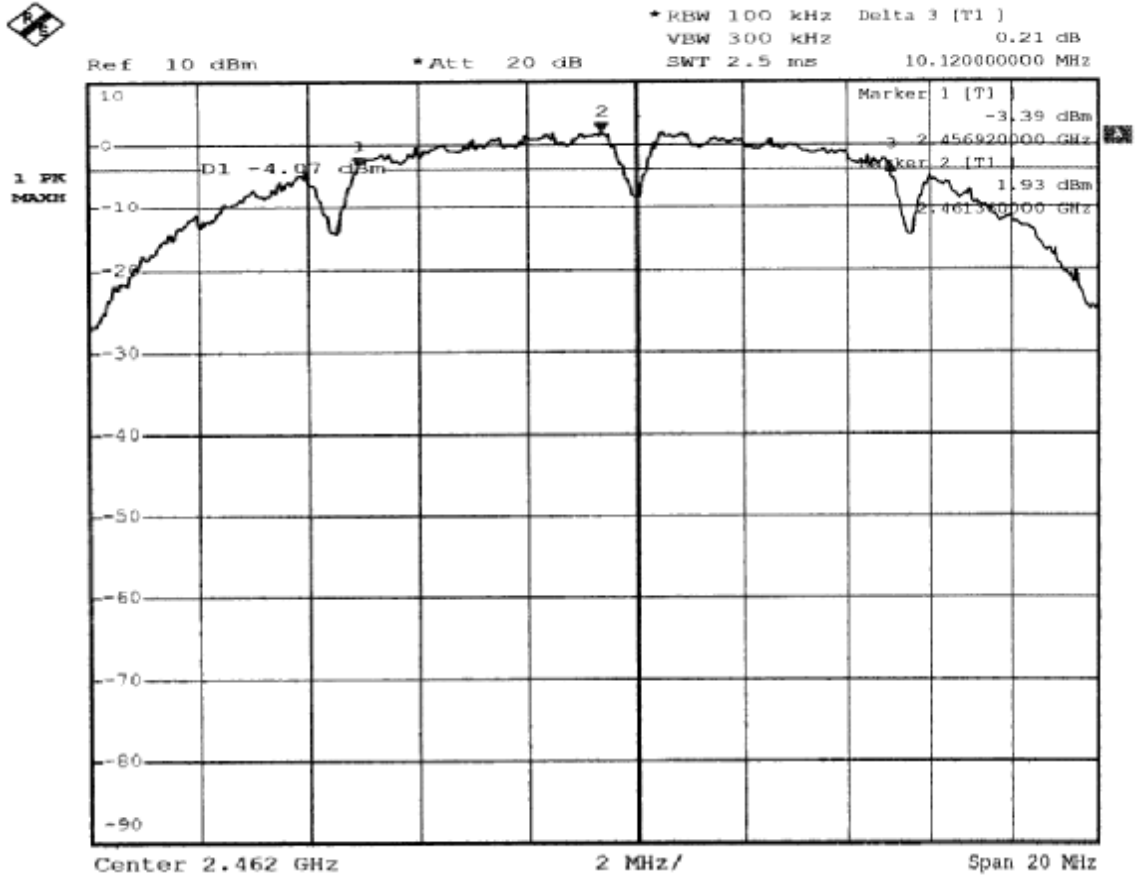

Comment A: 6dB bandwidth at high channel

4. Maximum Output Power test

4.1 Operating environment

Temperature: 22 °C
 Relative Humidity: 60 %
 Atmospheric Pressure 1023 hPa

4.2 Test setup & procedure

A:

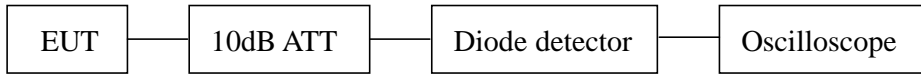

B:

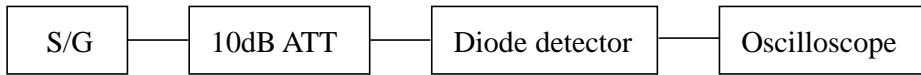

1. The output of the transmitter via a 10 dB attenuator and coupled to a diode detector.
2. The output of the diode detector connected to the vertical channel of an oscilloscope. The observed trace of the oscilloscope shall be recorded as “A”.
3. The transmitter replaced by a signal generator. The output frequency of the signal made equal to the center of the frequency range occupied by the transmitter and unmodulated.
4. The output of the signal generator raised to reach the peak of trace “A” named X.
5. The signal generator output level X (dBm) is the transmitter peak output power.

4.3 Measured data of Maximum Output Power test results

| Channel | Frequency (MHz) | Reading (dBm) | Output Power | | Limit (W) |
|---------|-----------------|---------------|--------------|--------|-----------|
| | | | (dBm) | (mW) | |
| Lowest | 2412 | 17.12 | 17.12 | 51.523 | 1 |
| Middle | 2437 | 17.38 | 17.38 | 54.702 | 1 |
| Highest | 2462 | 16.99 | 16.99 | 50.003 | 1 |

5. Radiated Emission test

5.1 Operating environment

| | | | |
|----------------------|------|-----|---------------|
| Temperature: | 22 | °C | (10-40°C) |
| Relative Humidity: | 60 | % | (10-90%) |
| Atmospheric Pressure | 1023 | hPa | (860-1060hPa) |

5.2 Test setup & procedure

The Diagram below shows the test setup, which is utilized to make these measurements.

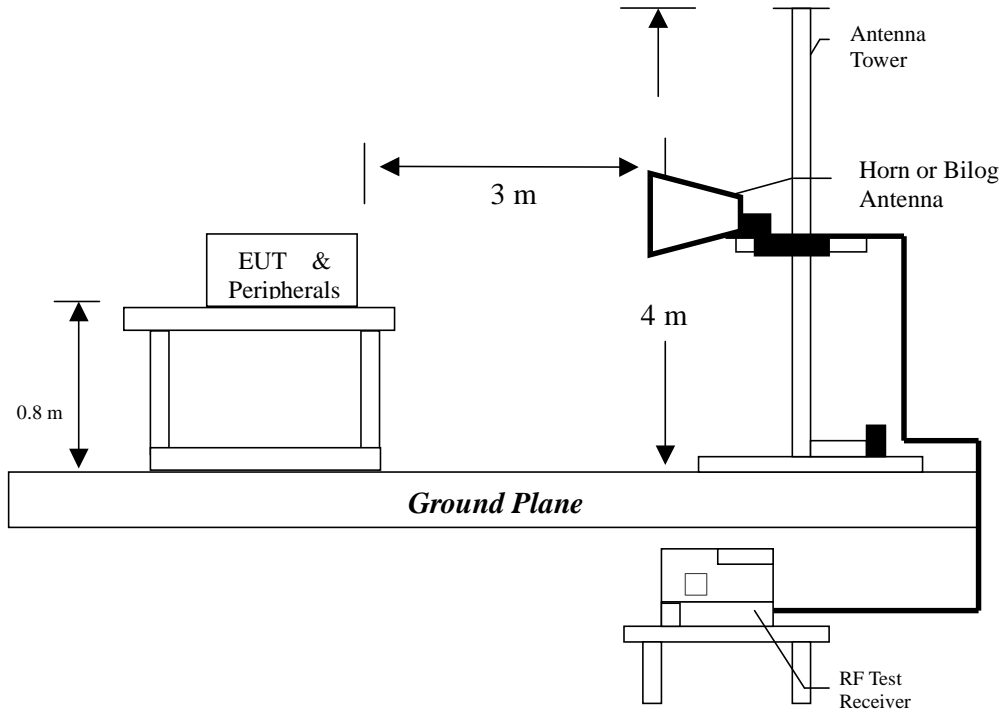

Radiated emissions were investigated cover the frequency range from 30MHz to 1000MHz using a receiver RBW of 120kHz record QP reading, and the frequency over 1GHz using a spectrum analyzer RBW of 1MHz and 10Hz VBW record Average reading. (15.209 paragraph), the Peak reading (1MHz RBW/VBW) recorded also on the report.

The EUT for testing is arranged on a wooden turntable. If some peripherals apply to the EUT, the peripherals will be connected to EUT and the whole system. During the test, all cables were arranged to produce worst-case emissions. The signal is maximized through rotation. The height of antenna and polarization is changing constantly for exploring for maximum signal level. The height of antenna can be up to 4 meters and down to 1 meter.

The measurement for radiated emission will be done at the distance of three meters unless the signal level is too low to measure at that distance. In the case of the reading under noise floor, a pre-amplifier is used and/or the test is conducted at a closer distance. And then all readings are extrapolated back to the equivalent three meter reading using inverse scaling with distance.

5.3 Emission limits

The spurious Emission shall test through the 10th harmonic. In addition, radiated emissions which fall in the restricted bands, as defined in §15.205(a), must also comply with the radiated emission limits specified in §15.209(a).

| Frequency (MHz) | Limits (dB μ V/m@3m) |
|--------------------|-----------------------------|
| 30-88 | 40 |
| 88-216 | 43.5 |
| 216-960 | 46 |
| Above 960 | 54 |

Remark:

1. In the above table, the tighter limit applies at the band edges.
2. Distance refers to the distance in meters between the measuring instrument antenna and the closed point of any part of the device or system

Uncertainty was calculated in accordance with NAMAS NIS 81.

Expanded uncertainty (k=2) of radiated emission measurement is ± 4.98 dB.

Expanded uncertainty (k=2) of conducted emission measurement is ± 2.02 dB.

5.4 Radiated spurious emission test data

5.4.1 Measurement results: frequencies equal to or less than 1 GHz

EUT : B-120
Test Condition : Tx at low channel

| Frequency (MHz) | Spectrum Analyzer Detector | Antenna Polariz. (H/V) | Correction Factor (dB/m) | Reading (dBuV) | Corrected Level (dBuV) | Limit @ 3 m (dBuV) | Margin (dB) |
|-----------------|----------------------------|------------------------|--------------------------|----------------|------------------------|--------------------|-------------|
| 133.10000 | QP | V | 13.36 | 16.94 | 30.30 | 43.50 | -13.20 |
| 265.40000 | QP | V | 13.32 | 18.58 | 31.90 | 46.00 | -14.10 |
| 299.50000 | QP | V | 14.39 | 19.61 | 34.00 | 46.00 | -12.00 |
| 332.20000 | QP | V | 15.30 | 15.10 | 30.40 | 46.00 | -15.60 |
| 498.80000 | QP | V | 18.90 | 11.20 | 30.10 | 46.00 | -15.90 |
| 720.00000 | QP | V | 22.56 | 7.44 | 30.00 | 46.00 | -16.00 |
| 199.60000 | QP | H | 12.03 | 25.17 | 37.20 | 43.50 | -6.30 |
| 233.00000 | QP | H | 12.35 | 24.65 | 37.00 | 46.00 | -9.00 |
| 263.80000 | QP | H | 13.32 | 23.08 | 36.40 | 46.00 | -9.60 |
| 332.20000 | QP | H | 15.30 | 17.10 | 32.40 | 46.00 | -13.60 |
| 398.00000 | QP | H | 16.67 | 15.53 | 32.20 | 46.00 | -13.80 |
| 528.20000 | QP | H | 19.17 | 11.63 | 30.80 | 46.00 | -15.20 |

Remark:

1. Corrected Level = Reading Level + Correction Factor
2. Correction Factor = Antenna Factor + Cable Loss

EUT : B-120
Test Condition : Tx at middle channel

| Frequency (MHz) | Spectrum Analyzer Detector | Antenna Polariz. (H/V) | Correction Factor (dB/m) | Reading (dBuV) | Corrected Level (dBuV) | Limit @ 3 m (dBuV) | Margin (dB) |
|-----------------|----------------------------|------------------------|--------------------------|----------------|------------------------|--------------------|-------------|
| 108.80000 | QP | V | 10.95 | 17.05 | 28.00 | 43.50 | -15.50 |
| 240.10000 | QP | V | 12.86 | 16.74 | 29.60 | 46.00 | -16.40 |
| 300.00000 | QP | V | 14.47 | 19.23 | 33.70 | 46.00 | -12.30 |
| 399.40000 | QP | V | 16.67 | 14.43 | 31.10 | 46.00 | -14.90 |
| 497.40000 | QP | V | 18.90 | 9.80 | 28.70 | 46.00 | -17.30 |
| 720.00000 | QP | V | 22.56 | 8.44 | 31.00 | 46.00 | -15.00 |
| 133.10000 | QP | H | 13.36 | 15.54 | 28.90 | 43.50 | -14.60 |
| 199.60000 | QP | H | 12.03 | 23.07 | 35.10 | 43.50 | -8.40 |
| 233.00000 | QP | H | 12.35 | 24.65 | 37.00 | 46.00 | -9.00 |
| 263.80000 | QP | H | 13.32 | 23.48 | 36.80 | 46.00 | -9.20 |
| 332.20000 | QP | H | 15.30 | 16.60 | 31.90 | 46.00 | -14.10 |
| 665.40000 | QP | H | 21.70 | 10.80 | 32.50 | 46.00 | -13.50 |

Remark:

1. Corrected Level = Reading Level + Correction Factor
2. Correction Factor = Antenna Factor + Cable Loss

EUT : B-120
Test Condition : Tx at high channel

| Frequency (MHz) | Spectrum Analyzer Detector | Antenna Polariz. (H/V) | Correction Factor (dB/m) | Reading (dBuV) | Corrected Level (dBuV) | Limit @ 3 m (dBuV) | Margin (dB) |
|-----------------|----------------------------|------------------------|--------------------------|----------------|------------------------|--------------------|-------------|
| 132.60000 | QP | V | 13.36 | 16.64 | 30.00 | 43.50 | -13.50 |
| 199.60000 | QP | V | 12.03 | 15.07 | 27.10 | 43.50 | -16.40 |
| 220.10000 | QP | V | 11.82 | 16.48 | 28.30 | 46.00 | -17.70 |
| 264.90000 | QP | V | 13.32 | 17.98 | 31.30 | 46.00 | -14.70 |
| 300.00000 | QP | V | 14.47 | 16.73 | 31.20 | 46.00 | -14.80 |
| 720.00000 | QP | V | 22.56 | 9.04 | 31.60 | 46.00 | -14.40 |
| 133.10000 | QP | H | 13.36 | 16.34 | 29.70 | 43.50 | -13.80 |
| 198.50000 | QP | H | 12.03 | 24.37 | 36.40 | 43.50 | -7.10 |
| 220.10000 | QP | H | 11.82 | 22.48 | 34.30 | 46.00 | -11.70 |
| 263.80000 | QP | H | 13.32 | 24.28 | 37.60 | 46.00 | -8.40 |
| 332.20000 | QP | H | 15.30 | 18.70 | 34.00 | 46.00 | -12.00 |
| 399.40000 | QP | H | 16.67 | 16.43 | 33.10 | 46.00 | -12.90 |

Remark:

1. Corrected Level = Reading Level + Correction Factor
2. Correction Factor = Antenna Factor + Cable Loss

5.4.2 Measurement results: frequency above 1GHz

The radiated spurious emissions at

| Frequency(MHz) | Margin |
|----------------|--------|
| 9648 | -2.688 |
| 9748 | -2.678 |
| 9848 | -0.119 |

are less than uncertainty. This is within the stated measurement uncertainty, this may affect compliance determined in other test arrangements.

EUT : B-120
Test Condition : Tx at low channel

| Frequency (MHz) | Spectrum Analyzer Detector | Antenna Polariz. (H/V) | Preamp (dB) | Correction Factor (dB/m) | Reading (dBuV) | Corrected Level (dBuV) | Limit @ 3 m (dBuV) | Margin (dB) |
|-----------------|----------------------------|------------------------|-------------|--------------------------|----------------|------------------------|--------------------|-------------|
| 7236 | PK | V | 34.32 | 38.42 | 51.41 | 55.51 | 74 | -18.49 |
| 7236 | AV | V | 34.32 | 38.42 | 39.58 | 43.68 | 54 | -10.32 |
| 9648 | PK | V | 35.808 | 41.35 | 52.76 | 58.302 | 74 | -15.698 |
| 9648 | AV | V | 35.808 | 41.35 | 45.77 | 51.312 | 54 | -2.688 |
| 7236 | PK | H | 34.32 | 38.42 | 50.27 | 54.37 | 74 | -19.63 |
| 7236 | AV | H | 34.32 | 38.42 | 37.65 | 41.75 | 54 | -12.25 |
| 9648 | PK | H | 35.808 | 41.35 | 51.02 | 56.562 | 74 | -17.438 |
| 9648 | AV | H | 35.808 | 41.35 | 42.88 | 48.422 | 54 | -5.578 |

Remark:

1. Corrected Level = Reading Level + Correction Factor – Preamp
2. Correction Factor = Antenna Factor + Cable Loss
3. The frequency measured ranges from 1GHz to 25GHz. The data value listed above which is higher than the noise floor, the others please refer to noise floor level.

For PK:
1GHz-3GHz: 50dBuV
3GHz-14GHz: 54dBuV
14GHz-26.5GHz: 60dBuV

For AV:
1GHz-3GHz: 41.5dBuV
3GHz-14GHz: 46dBuV
14GHz-26.5GHz: 46.5dBuV

EUT : B-120
Test Condition : Tx at middle channel

| Frequency (MHz) | Spectrum Analyzer Detector | Antenna Polariz. (H/V) | Preamp (dB) | Correction Factor (dB/m) | Reading (dBuV) | Corrected Level (dBuV) | Limit @ 3 m (dBuV) | Margin (dB) |
|-----------------|----------------------------|------------------------|-------------|--------------------------|----------------|------------------------|--------------------|-------------|
| 7311 | PK | V | 34.32 | 38.42 | 51.12 | 55.22 | 74 | -18.78 |
| 7311 | AV | V | 34.32 | 38.42 | 39.25 | 43.35 | 54 | -10.65 |
| 9748 | PK | V | 35.808 | 41.35 | 52.37 | 57.912 | 74 | -16.088 |
| 9748 | AV | V | 35.808 | 41.35 | 45.78 | 51.322 | 54 | -2.678 |
| 7311 | PK | H | 34.32 | 38.42 | 50.16 | 54.26 | 74 | -19.74 |
| 7311 | AV | H | 34.32 | 38.42 | 38.27 | 42.37 | 54 | -11.63 |
| 9748 | PK | H | 35.808 | 41.35 | 50.83 | 56.372 | 74 | -17.628 |
| 9748 | AV | H | 35.808 | 41.35 | 41.02 | 46.562 | 54 | -7.438 |

Remark:

1. Corrected Level = Reading Level + Correction Factor – Preamp
2. Correction Factor = Antenna Factor + Cable Loss
3. The frequency measured ranges from 1GHz to 25GHz. The data value listed above which is higher than the noise floor, the others please refer to noise floor level.

For PK:

1GHz-3GHz: 50dBuV
3GHz-14GHz: 54dBuV
14GHz-26.5GHz: 60dBuV

For AV:

1GHz-3GHz: 41.5dBuV
3GHz-14GHz: 46dBuV
14GHz-26.5GHz: 46.5dBuV

EUT : B-120
Test Condition : Tx at high channel

| Frequency (MHz) | Spectrum Analyzer Detector | Antenna Polariz. (H/V) | Preamp (dB) | Correction Factor (dB/m) | Reading (dBuV) | Corrected Level (dBuV) | Limit @ 3 m (dBuV) | Margin (dB) |
|-----------------|----------------------------|------------------------|-------------|--------------------------|----------------|------------------------|--------------------|-------------|
| 7386 | PK | V | 34.32 | 38.42 | 53.29 | 57.39 | 74 | -16.61 |
| 7386 | AV | V | 34.32 | 38.42 | 40.99 | 45.09 | 54 | -8.91 |
| 9848 | PK | V | 35.919 | 41.55 | 54.35 | 59.981 | 74 | -14.019 |
| 9848 | AV | V | 35.919 | 41.55 | 48.25 | 53.881 | 54 | -0.119 |
| 7386 | PK | H | 34.32 | 38.42 | 52.25 | 56.35 | 74 | -17.65 |
| 7386 | AV | H | 34.32 | 38.42 | 40.22 | 44.32 | 54 | -9.68 |
| 9848 | PK | H | 35.919 | 41.55 | 51 | 56.631 | 74 | -17.369 |
| 9848 | AV | H | 35.919 | 41.55 | 44.3 | 49.931 | 54 | -4.069 |

Remark:

1. Corrected Level = Reading Level + Correction Factor – Preamp
2. Correction Factor = Antenna Factor + Cable Loss
3. “-“ means the emission is below the noise floor. The frequency measured ranges from 1GHz to 25GHz. The data value listed above which is higher than the noise floor, the others please refer to noise floor level.

For PK:

1GHz-3GHz: 50dBuV
3GHz-14GHz: 54dBuV
14GHz-26.5GHz: 60dBuV

For AV:

1GHz-3GHz: 41.5dBuV
3GHz-14GHz: 46dBuV
14GHz-26.5GHz: 46.5dBuV

6. Power Spectrum Density test

6.1 Operating environment

Temperature: 22 °C
Relative Humidity: 60 %
Atmospheric Pressure 1023 hPa

6.2 Test setup & procedure

The power spectrum density per FCC §15.247(d) was measured from the antenna port of the EUT using a 50ohm spectrum analyzer with the resolution bandwidth set at 3kHz, the video bandwidth set at 10kHz, a span of 1.5 MHz, and the sweep time set at 500 seconds. Power Density was read directly and cable loss (2dB)/external attenuator (3dB) correction was added to the reading to obtain power at the EUT antenna terminals. The test was performed at 3 channels (lowest, middle and highest channel). The Power Spectral Density measured result is in the following table.

6.3 Measured data of Power Spectrum Density test results

| Channel | Frequency (MHz) | Measured level (dBm) | Limit (dBm) |
|---------|-----------------|----------------------|-------------|
| Low | 2412.498 | -6.21 | 8 |
| Middle | 2437.495 | -6.53 | 8 |
| High | 2462.495 | -7.00 | 8 |

Please see the plot below.

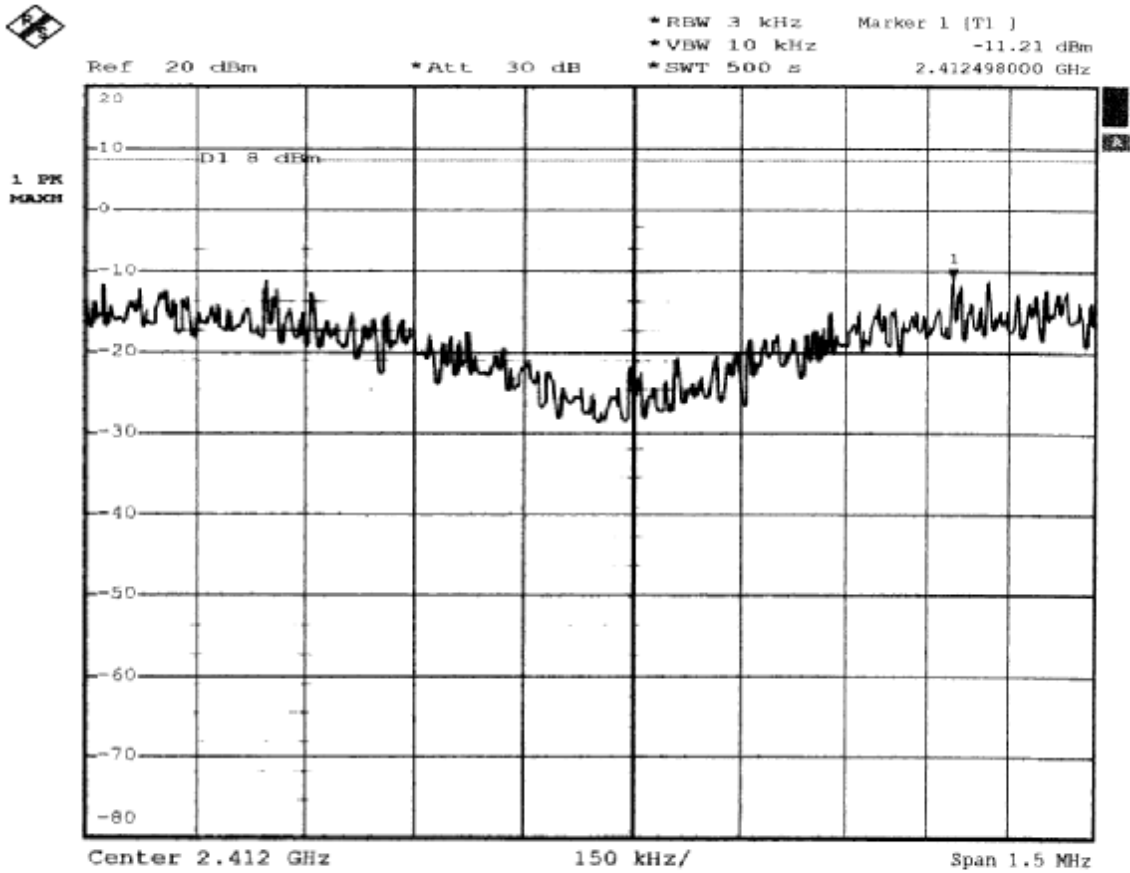

Comment A: Power spectrum density at low channel J(
ATT=3dB CL=2dB

7. Emission on the band edge §FCC 15.247(C)

In any 100kHz bandwidth outside the frequency band in which the spread spectrum intentional radiator is operating, the radio frequency power that is produced by the intentional radiator shall be at least 20 dB below that in the 100 kHz bandwidth within the band that contains the highest level of the desired power, based on either an RF conducted or a radiated measurement.

Please see the plot below.

7.1 Band-edge (Conducted method)

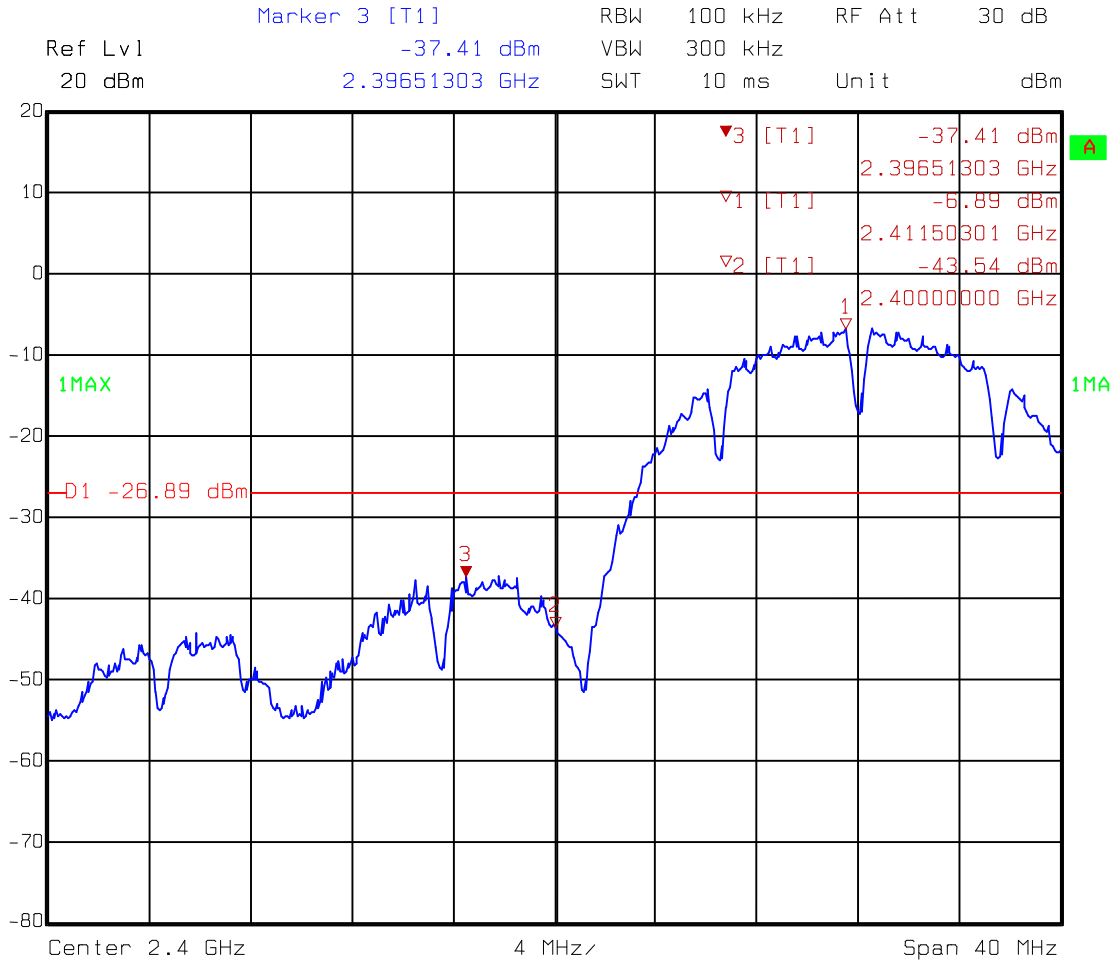

Comment A: Band-edge at low channel

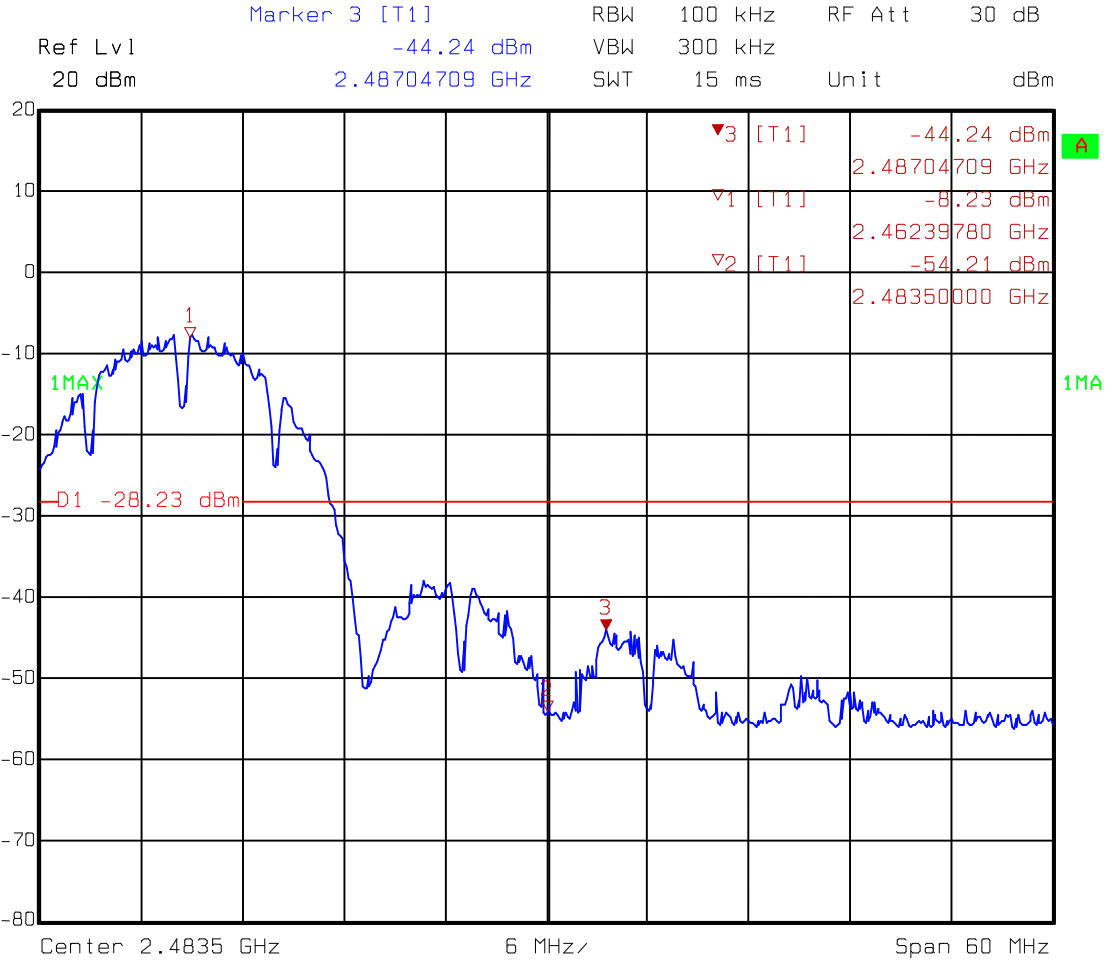

Comment A: Band-edge at high channel

7.2 Band-edge (Radiated method)

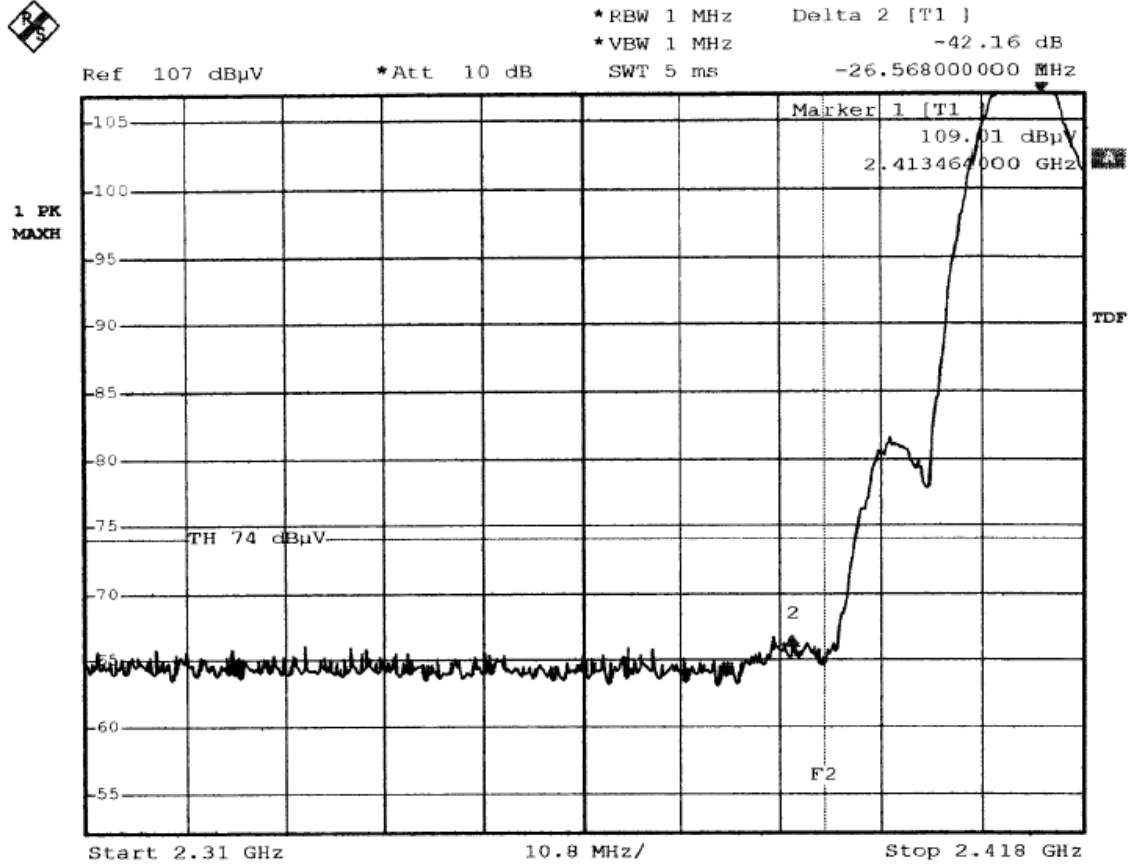

Comment A: Band-edge test at low channel0
 Peak detector F2=2390MHz

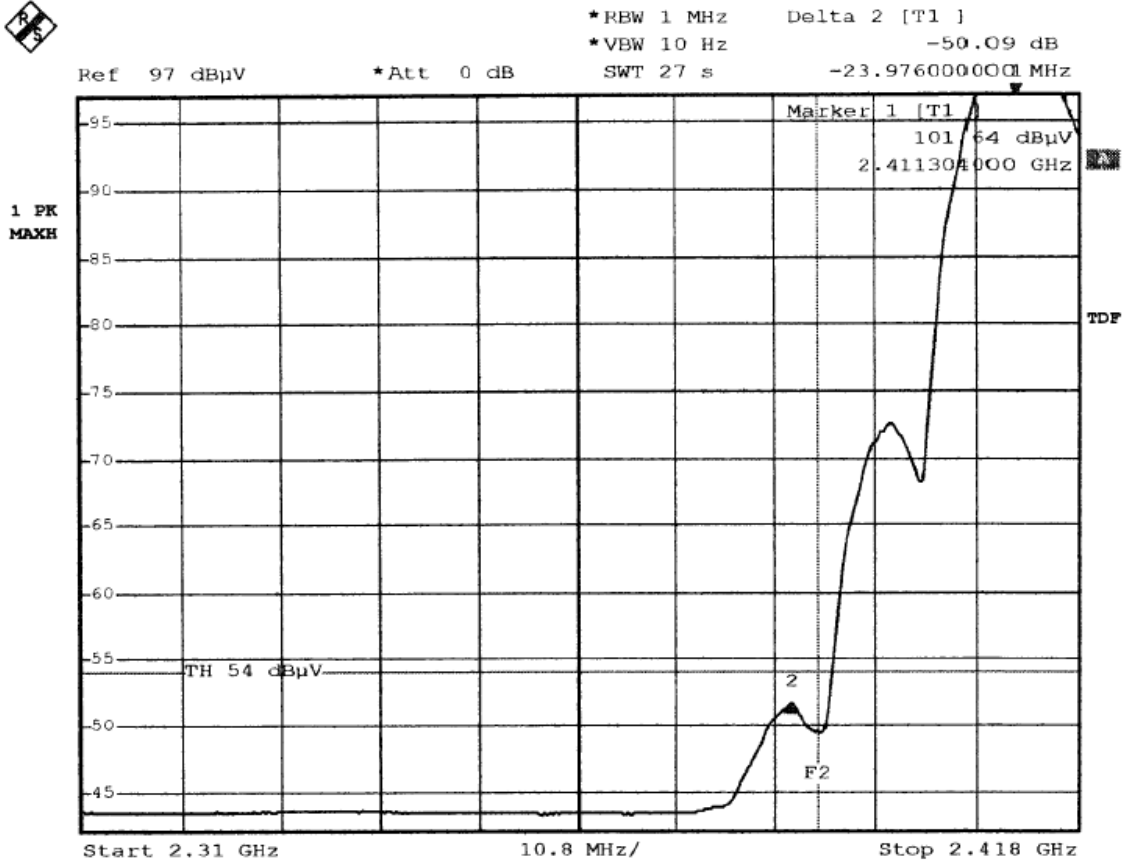

Comment A: Band-edge test at low channel EN B
 Average detector F2=2390MHz

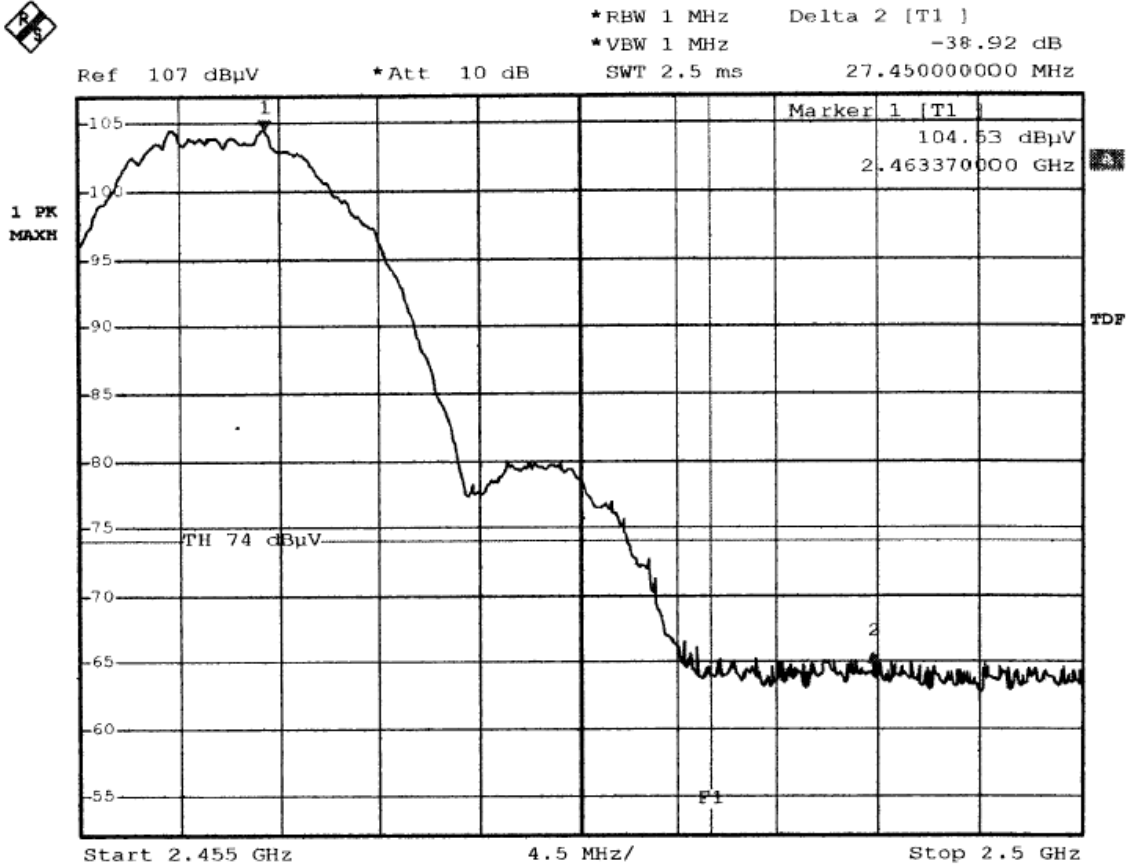

Comment A: Band-edge test at high channel
Peak detector F1=2483.5MHz

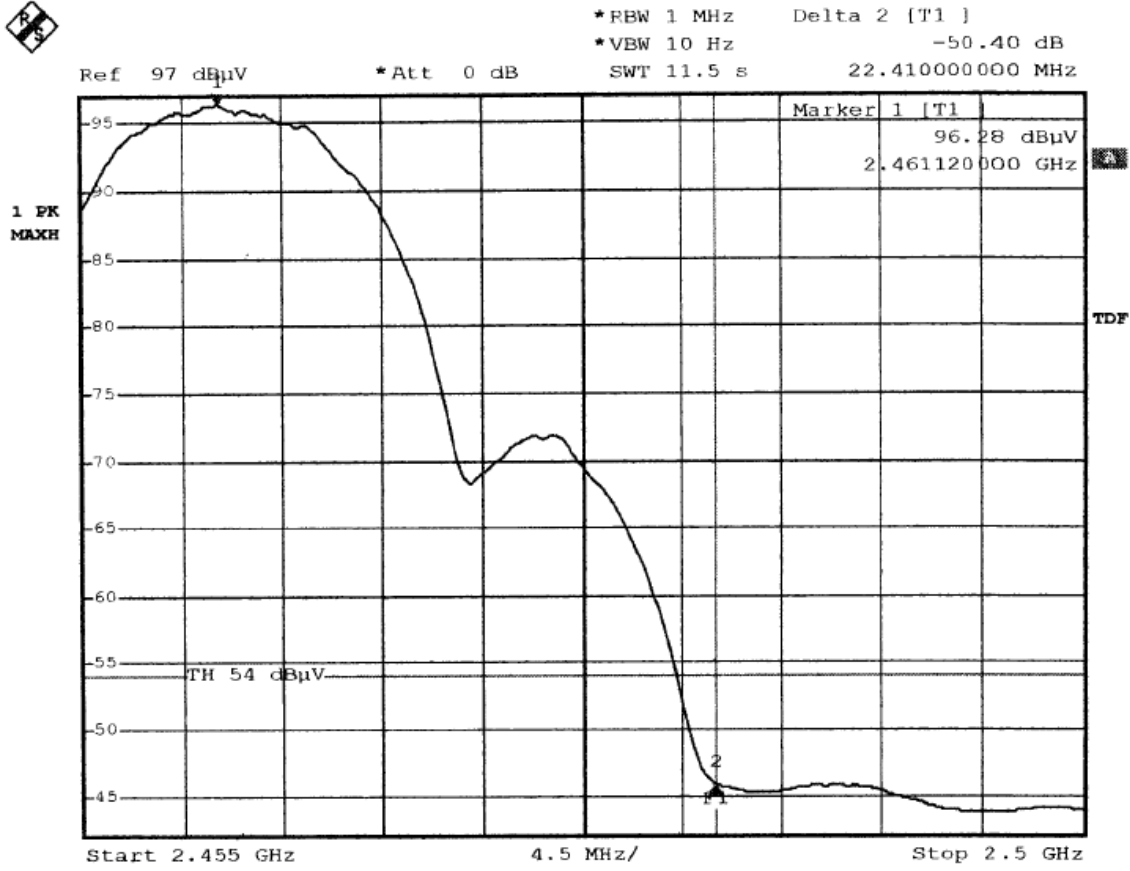

Comment A: Band-edge test at high channel F1=2483.5MHz
 Average detector F1=2483.5MHz

8. Power Line Conducted Emission test §FCC 15.207

8.1 Operating environment

| | | | |
|----------------------|------|-----|---------------|
| Temperature: | 22 | °C | (10-40°C) |
| Relative Humidity: | 60 | % | (10-90%) |
| Atmospheric Pressure | 1023 | hPa | (860-1061hPa) |

8.2 Test setup & procedure

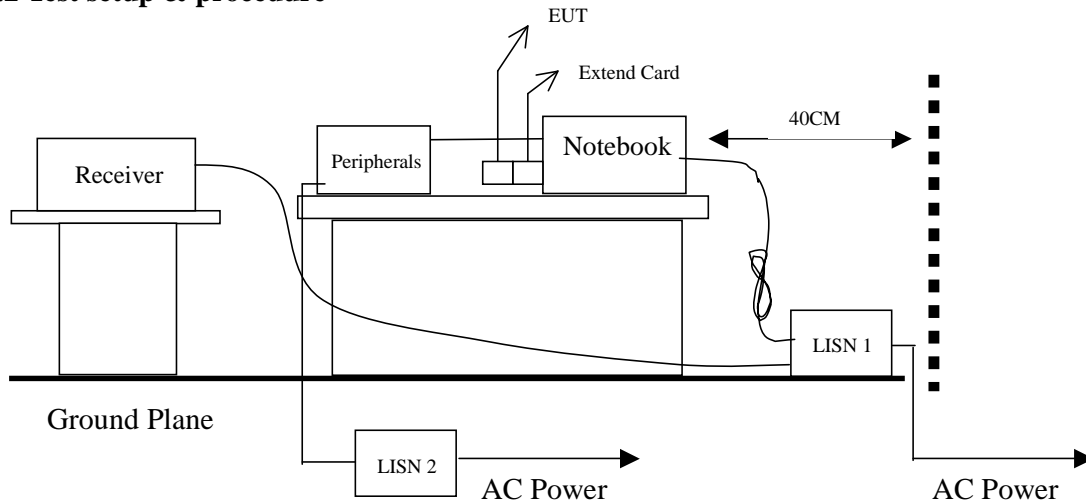

The EUT are connected to the main power through a line impedance stabilization network (LISN). This provides a 50 ohm/50uH coupling impedance for the measuring equipment. The peripheral devices are also connected to the main power through a LISN that provides a 50ohm/50uH coupling impedance with 50ohm termination.

Both sides (Line and Neutral) of AC line are checked for maximum conducted interference. In order to find the maximum emission, the relative positions of equipment and all of the interface cables must be changed according to ANSI C63.4/1992 on conducted measurement. The AC power conducted emissions was investigated over the frequency range from 0.15MHz to 30MHz using a receiver bandwidth of 9kHz. (15.207 paragraph)

The EUT configuration please refer to the “Conducted set-up photo.pdf”.

Emission Limit

| Freq. (MHz) | Conducted Limit (dBuV) | |
|----------------|------------------------|----------|
| | Q.P. | Ave. |
| 0.15~0.50 | 66 – 56* | 56 – 46* |
| 0.50~5.00 | 56 | 46 |
| 5.00~30.0 | 60 | 50 |

*Decreases with the logarithm of the frequency.

8.3 Power Line Conducted Emission test data

(1) Line

EUT : B-120
Test Condition : Tx at low channel

| Freq. (MHz) | Reading (dB μ V) QP | Limit (dB μ V) QP | Reading (dB μ V) AV | Limit (dB μ V) AV | Margin (dB) | |
|-------------|-------------------------|-----------------------|-------------------------|-----------------------|-------------|--------|
| | | | | | QP | AV |
| 0.15800 | 38.7 | 65.57 | 22.9 | 55.57 | -26.87 | -32.67 |
| 0.21400 | 41.6 | 63.05 | 30.0 | 53.05 | -21.45 | -23.05 |
| 0.35000 | 33.7 | 58.96 | 26.8 | 48.96 | -25.26 | -22.16 |
| 0.45400 | 27.3 | 56.81 | 24.6 | 46.81 | -29.51 | -22.21 |
| 1.27000 | 27.1 | 56.00 | 25.4 | 46.00 | -28.90 | -20.60 |
| 21.50200 | 34.8 | 60.00 | 34.8 | 50.00 | -25.20 | -15.20 |

(2) Neutral

EUT : B-120
Test Condition : Tx at low channel

| Freq. (MHz) | Reading (dB μ V) QP | Limit (dB μ V) QP | Reading (dB μ V) AV | Limit (dB μ V) AV | Margin (dB) | |
|-------------|-------------------------|-----------------------|-------------------------|-----------------------|-------------|--------|
| | | | | | QP | AV |
| 0.15800 | 38.7 | 65.57 | 22.9 | 55.57 | -26.87 | -32.67 |
| 0.21400 | 41.6 | 63.05 | 30.0 | 53.05 | -21.45 | -23.05 |
| 0.35000 | 33.7 | 58.96 | 26.8 | 48.96 | -25.26 | -22.16 |
| 0.45400 | 27.3 | 56.81 | 24.6 | 46.81 | -29.51 | -22.21 |
| 1.27000 | 27.1 | 56.00 | 25.4 | 46.00 | -28.90 | -20.60 |
| 21.50200 | 34.8 | 60.00 | 34.8 | 50.00 | -25.20 | -15.20 |

Remark:

1. The reading value included cable loss and LISN factor.
2. Uncertainty was calculated in accordance with NAMAS NIS 81.
Expanded uncertainty (k=2) of conducted emission measurement is ± 2.6 dB.

(1) Line

EUT : B-120
Test Condition : Tx at middle channel

| Freq. (MHz) | Reading (dB μ V) QP | Limit (dB μ V) QP | Reading (dB μ V) AV | Limit (dB μ V) AV | Margin (dB) | |
|-------------|-------------------------|-----------------------|-------------------------|-----------------------|-------------|--------|
| | | | | | QP | AV |
| 0.15000 | 41.9 | 66.00 | 27.0 | 56.00 | -24.10 | -29.00 |
| 0.20600 | 42.8 | 63.37 | 30.4 | 53.37 | -20.57 | -22.97 |
| 0.45400 | 27.2 | 56.81 | 24.9 | 46.81 | -29.61 | -21.91 |
| 0.81400 | 25.6 | 56.00 | 20.4 | 46.00 | -30.40 | -25.60 |
| 1.37400 | 26.5 | 56.00 | 24.9 | 46.00 | -29.50 | -21.10 |
| 21.50200 | 37.3 | 60.00 | 37.3 | 50.00 | -22.70 | -12.70 |

(2) Neutral

EUT : B-120
Test Condition : Tx at middle channel

| Freq. (MHz) | Reading (dB μ V) QP | Limit (dB μ V) QP | Reading (dB μ V) AV | Limit (dB μ V) AV | Margin (dB) | |
|-------------|-------------------------|-----------------------|-------------------------|-----------------------|-------------|--------|
| | | | | | QP | AV |
| 0.21400 | 39.9 | 63.05 | 28.0 | 53.05 | -23.15 | -25.05 |
| 0.35000 | 34.4 | 58.96 | 26.9 | 48.96 | -24.56 | -22.06 |
| 0.45400 | 25.9 | 56.81 | 23.7 | 46.81 | -30.91 | -23.11 |
| 0.70200 | 23.7 | 56.00 | 20.7 | 46.00 | -32.30 | -25.30 |
| 1.26200 | 24.4 | 56.00 | 20.0 | 46.00 | -31.60 | -26.00 |
| 21.50200 | 38.6 | 60.00 | 38.5 | 50.00 | -21.40 | -11.50 |

Remark:

1. The reading value included cable loss and LISN factor.
2. Uncertainty was calculated in accordance with NAMAS NIS 81.
Expanded uncertainty (k=2) of conducted emission measurement is ± 2.6 dB.

(1) Line

EUT : B-120
Test Condition : Tx at high channel

| Freq. (MHz) | Reading (dB μ V) QP | Limit (dB μ V) QP | Reading (dB μ V) AV | Limit (dB μ V) AV | Margin (dB) | |
|-------------|-------------------------|-----------------------|-------------------------|-----------------------|-------------|--------|
| | | | | | QP | AV |
| 0.23000 | 35.2 | 62.45 | 21.0 | 52.45 | -27.25 | -31.45 |
| 0.35000 | 33.5 | 58.96 | 28.1 | 48.96 | -25.46 | -20.86 |
| 0.45400 | 27.8 | 56.81 | 24.8 | 46.81 | -29.01 | -22.01 |
| 0.79800 | 19.6 | 56.00 | 10.1 | 46.00 | -36.40 | -35.90 |
| 1.26200 | 26.7 | 56.00 | 20.8 | 46.00 | -29.30 | -25.20 |
| 21.50200 | 39.0 | 60.00 | 38.8 | 50.00 | -21.00 | -11.20 |

(2) Neutral

EUT : B-120
Test Condition : Tx at high channel

| Freq. (MHz) | Reading (dB μ V) QP | Limit (dB μ V) QP | Reading (dB μ V) AV | Limit (dB μ V) AV | Margin (dB) | |
|-------------|-------------------------|-----------------------|-------------------------|-----------------------|-------------|--------|
| | | | | | QP | AV |
| 0.23000 | 37.3 | 62.45 | 29.7 | 52.45 | -25.15 | -22.75 |
| 0.31000 | 28.1 | 59.97 | 10.0 | 49.97 | -31.87 | -39.97 |
| 0.35000 | 34.0 | 58.96 | 24.4 | 48.96 | -24.96 | -24.56 |
| 0.45400 | 28.1 | 56.81 | 25.1 | 46.81 | -28.71 | -21.71 |
| 1.26200 | 25.8 | 56.00 | 22.8 | 46.00 | -30.20 | -23.20 |
| 21.50200 | 38.7 | 60.00 | 38.6 | 50.00 | -21.30 | -11.40 |

Remark:

1. The reading value included cable loss and LISN factor.
2. Uncertainty was calculated in accordance with NAMAS NIS 81.
Expanded uncertainty (k=2) of conducted emission measurement is ± 2.6 dB.

Please see the plot below.

Intertek Testing Services
RF VOLTAGE

EUT: B-120
 Manuf: ZyXEL Communications Corp.
 Op Cond: AMN-L
 Operator: kaysi
 Test Spec: FCC Class B
 Comment: EMI RCV:825788/015
 120V 60Hz 22'c 60%RH tx at low channel
 Date: 11. Feb 03 10:06

Scan Settings (1 Range)

| Frequencies | | | Receiver Settings | | | |
|-------------|------|------|-------------------|----------|-----------|--------------|
| Start | Stop | Step | IF BW | Detector | M-Time | Atten Preamp |
| 150k | 30M | 8k | 9k | PK | 20ms AUTO | LN OFF |

Final Measurement: x QP / + AV
 Meas Time: 1 s

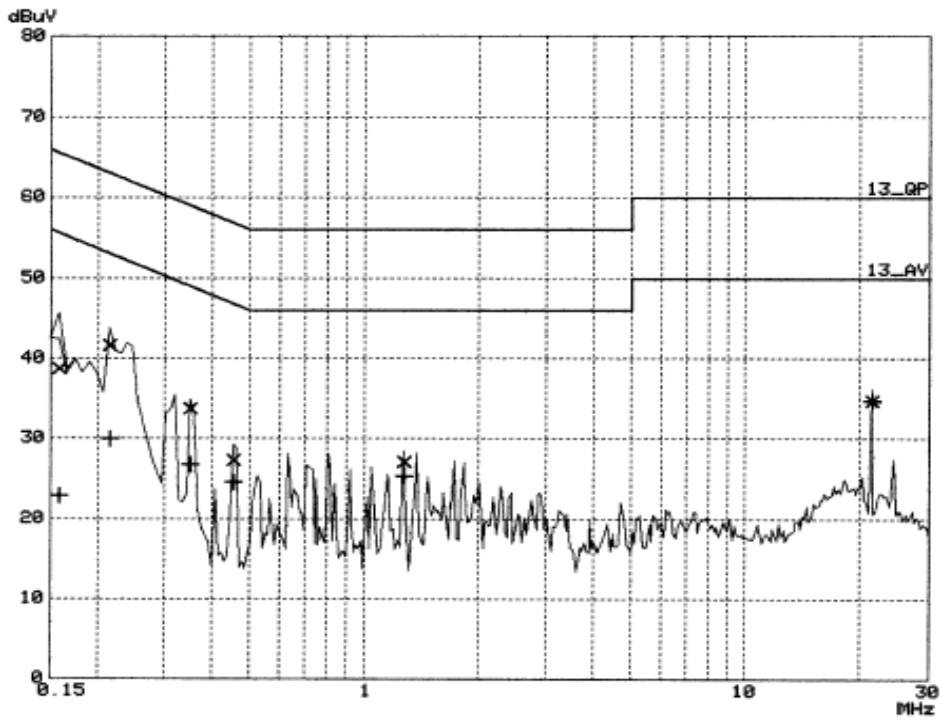

Intertek Testing Services
RF VOLTAGE

EUT: B-120
 Manuf: ZyXEL Communications Corp.
 Op Cond: AMN-N
 Operator: kaysi
 Test Spec: FCC Class B
 Comment: EMI RCV:825788/015
 120V 60Hz 22'c 60%RH tx at low channel
 Date: 11. Feb 03 09:51

| | | | | | | |
|-------------------------|------|------|-------------------|----------|-----------|--------------|
| Scan Settings (1 Range) | | | Receiver Settings | | | |
| Start | Stop | Step | IF BW | Detector | M-Time | Atten Preamp |
| 150k | 30M | 8k | 9k | PK | 20ms AUTO | LN OFF |

Final Measurement: x QP / + AV
 Meas Time: 1 s

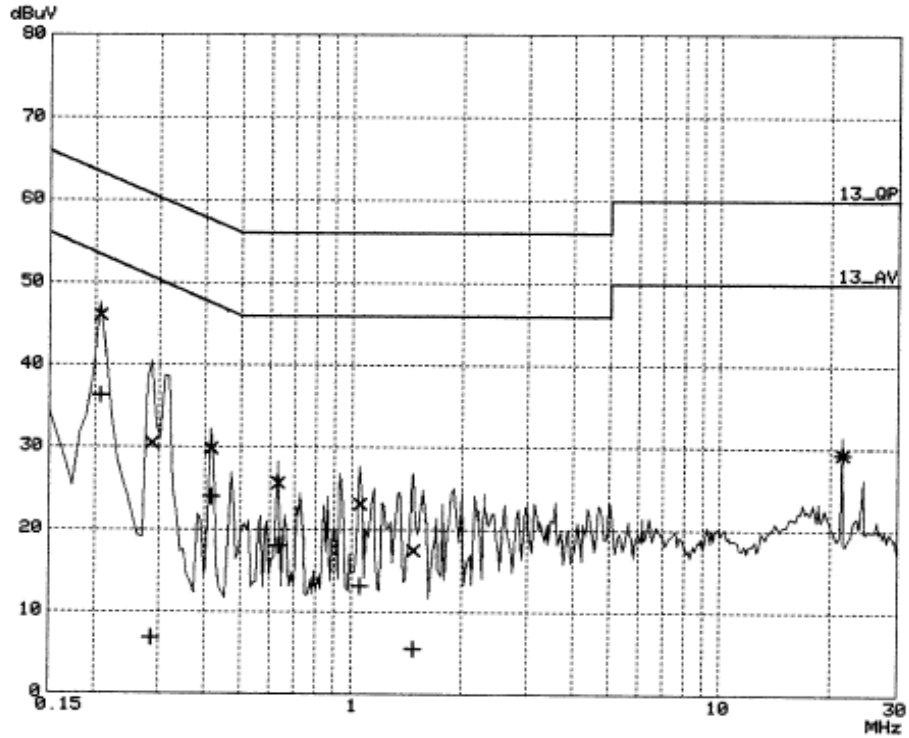

Intertek Testing Services
RF VOLTAGE

EUT: B-120
 Manuf: ZyXEL Communications Corp.
 Op Cond: AMN-L
 Operator: kaysi
 Test Spec: FCC Class B
 Comment: EMI RCV:825788/015
 120V 60Hz 22'c 60%RH tx at middle channel
 Date: 11. Feb 03 10:37

Scan Settings (1 Range)

| Frequencies | | | Receiver Settings | | | | |
|-------------|------|------|-------------------|----------|--------|---------|--------|
| Start | Stop | Step | IF BW | Detector | M-Time | Atten | Preamp |
| 150k | 30M | 8k | 9k | PK | 20ms | AUTO LN | OFF |

Final Measurement: x QP / + AV
 Meas Time: 1 s

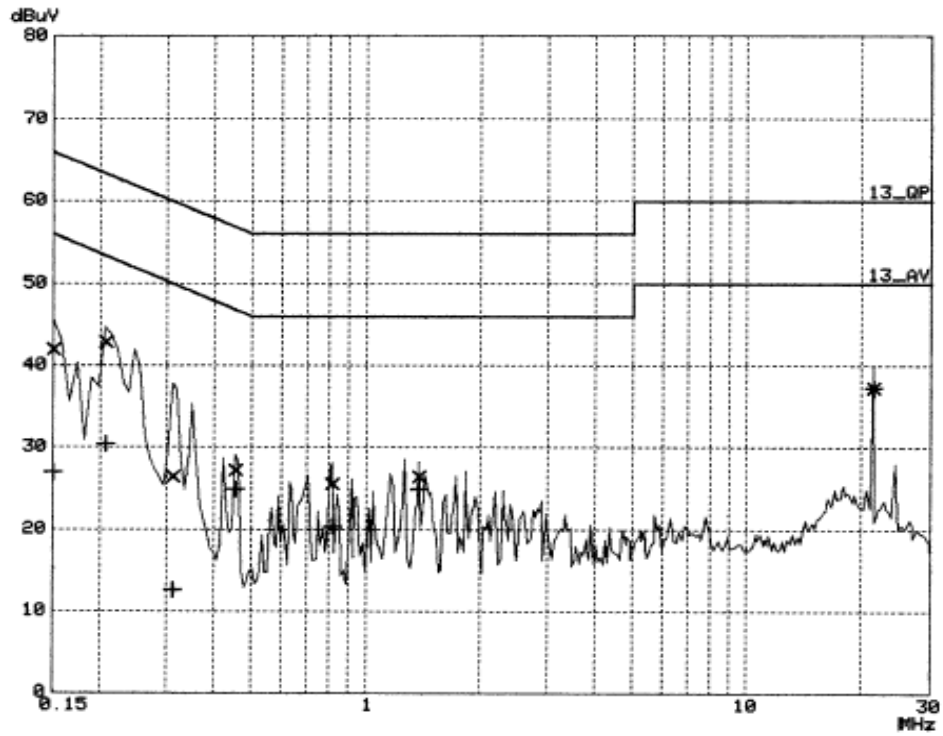

Intertek Testing Services
RF VOLTAGE

EUT: B-120
 Manuf: ZYXEL Communications Corp.
 Op Cond: AMN-N
 Operator: kaysi
 Test Spec: FCC Class B
 Comment: EMI RCV:825788/015
 120V 60Hz 22'c 60%RH tx at middle channel
 Date: 11. Feb 03 10:57

Scan Settings (1 Range)

| Frequencies | | | Receiver Settings | | | |
|-------------|------|------|-------------------|----------|--------|--------------|
| Start | Stop | Step | IF BW | Detector | M-Time | Atten Preamp |
| 150k | 30M | 8k | 9k | PK | 20ms | AUTO LN OFF |

Final Measurement: x QP / + AV
 Meas Time: 1 s

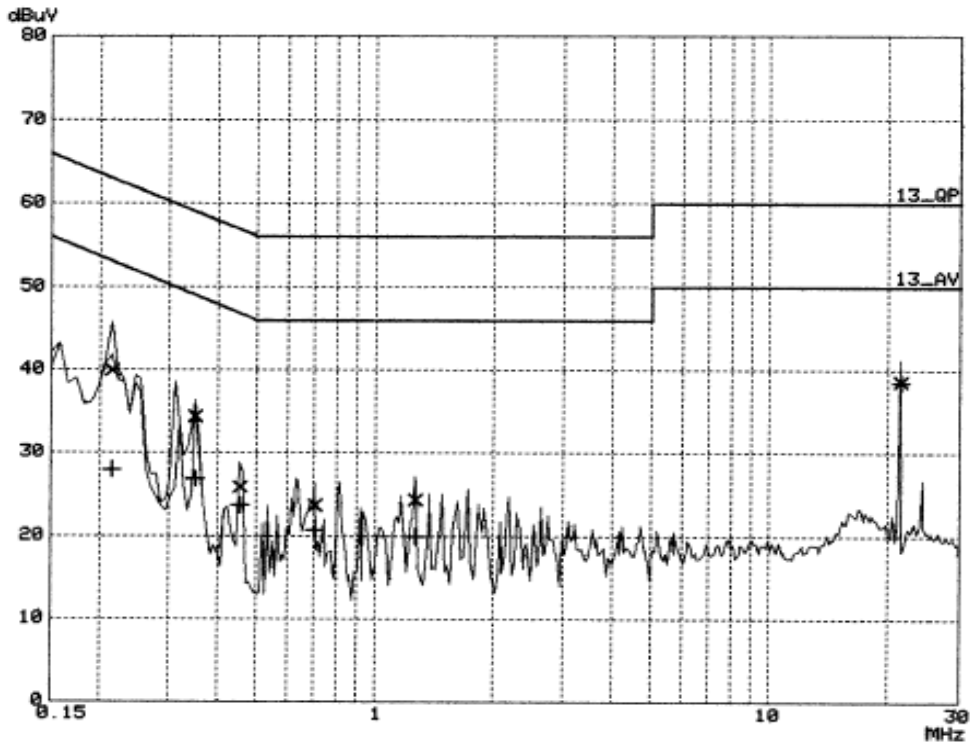

Intertek Testing Services
RF VOLTAGE

EUT: B-120
 Manuf: ZyXEL Communications Corp.
 Op Cond: AMN-L
 Operator: kaysi
 Test Spec: FCC Class B
 Comment: EMI RCV:825788/015
 120V 60Hz 22'c 60%RH tx at high channel
 Date: 11. Feb 03 11:17

Scan Settings (1 Range)

| Frequencies | | | Receiver Settings | | | | |
|-------------|------|------|-------------------|----------|--------|-------|--------|
| Start | Stop | Step | IF BW | Detector | M-Time | Atten | Preamp |
| 150k | 30M | 8k | 9k | PK | 20ms | AUTO | LN OFF |

Final Measurement: x QP / + AV
 Meas Time: 1 s

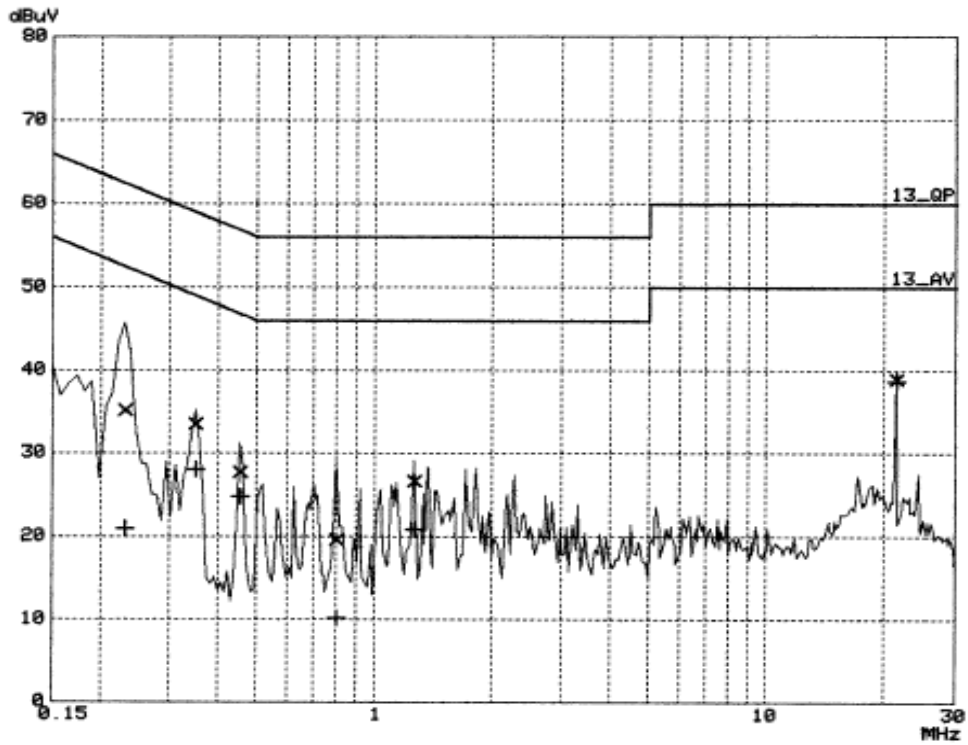

Intertek Testing Services
RF VOLTAGE

EUT: B-120
 Manuf: ZyXEL Communications Corp.
 Op Cond: AMN-N
 Operator: kaysi
 Test Spec: FCC Class B
 Comment: EMI RCY:825788/015
 120V 60Hz 22'c 60%RH tx at high channel
 Date: 11. Feb 03 11:09

Scan Settings (1 Range)
 |----- Frequencies -----||----- Receiver Settings -----|
 Start Stop Step IF BW Detector M-Time Atten Preamp
 150k 30M 8k 9k PK 20ms AUTO LN OFF

Final Measurement: x QP / + AV
 Meas Time: 1 s

