

FCC Test Report

Report No.: RF190822C14-1 R1

FCC ID: I88ATP100W

Test Model: ATP100W

Received Date: Aug. 22, 2019

Test Date: Sep. 17, 2019 ~ Sep. 24, 2019

Issued Date: Oct. 30, 2019

Applicant: Zyxel Communications Corporation

Address: No.2 Industry East RD. IX, Hsinchu Science Park, Hsinchu 30075, Taiwan

Issued By: Bureau Veritas Consumer Products Services (H.K.) Ltd., Taoyuan Branch
Lin Kou Laboratories

Lab Address: No. 47-2, 14th Ling, Chia Pau Vil., Lin Kou Dist., New Taipei City, Taiwan

Test Location: No.19, Hwa Ya 2nd Rd., Wen Hwa Vil., Kwei Shan Dist., Taoyuan City
33383, Taiwan

**FCC Registration /
Designation Number:** 788550 / TW0003



This report is for your exclusive use. Any copying or replication of this report to or for any other person or entity, or use of our name or trademark, is permitted only with our prior written permission. This report sets forth our findings solely with respect to the test samples identified herein. The results set forth in this report are not indicative or representative of the quality or characteristics of the lot from which a test sample was taken or any similar or identical product unless specifically and expressly noted. Our report includes all of the tests requested by you and the results thereof based upon the information that you provided to us. You have 60 days from date of issuance of this report to notify us of any material error or omission caused by our negligence, provided, however, that such notice shall be in writing and shall specifically address the issue you wish to raise. A failure to raise such issue within the prescribed time shall constitute your unqualified acceptance of the completeness of this report, the tests conducted and the correctness of the report contents. Unless specific mention, the uncertainty of measurement has been explicitly taken into account to declare the compliance or non-compliance to the specification. The report must not be used by the client to claim product certification, approval, or endorsement by TAF or any government agencies.

Table of Contents

Release Control Record	4
1 Certificate of Conformity	5
2 Summary of Test Results	6
2.1 Measurement Uncertainty	6
2.2 Modification Record	6
3 General Information	7
3.1 General Description of EUT	7
3.2 Description of Test Modes	9
3.2.1 Test Mode Applicability and Tested Channel Detail	10
3.3 Duty Cycle of Test Signal	12
3.4 Description of Support Units	13
3.4.1 Configuration of System under Test	13
3.5 General Description of Applied Standards	13
4 Test Types and Results	14
4.1 Radiated Emission and Bandedge Measurement	14
4.1.1 Limits of Radiated Emission and Bandedge Measurement	14
4.1.2 Limits of Unwanted Emission Out of the Restricted Bands	15
4.1.3 Test Instruments	16
4.1.4 Test Procedures	18
4.1.5 Deviation from Test Standard	19
4.1.6 Test Setup	19
4.1.7 EUT Operating Conditions	20
4.1.8 Test Results	21
4.2 Conducted Emission Measurement	41
4.2.1 Limits of Conducted Emission Measurement	41
4.2.2 Test Instruments	41
4.2.3 Test Procedures	42
4.2.4 Deviation from Test Standard	42
4.2.5 Test Setup	42
4.2.6 EUT Operating Conditions	42
4.2.7 Test Results	43
4.3 Transmit Power Measurement	45
4.3.1 Limits of Transmit Power Measurement	45
4.3.2 Test Setup	45
4.3.3 Test Instruments	46
4.3.4 Test Procedure	46
4.3.5 Deviation from Test Standard	46
4.3.6 EUT Operating Conditions	46
4.3.7 Test Results	47
4.4 Occupied Bandwidth Measurement	50
4.4.1 Test Setup	50
4.4.2 Test Instruments	50
4.4.3 Test Procedure	50
4.4.4 Test Results	51
4.5 Peak Power Spectral Density Measurement	55
4.5.1 Limits of Peak Power Spectral Density Measurement	55
4.5.2 Test Setup	55
4.5.3 Test Instruments	55
4.5.4 Test Procedures	55
4.5.5 Deviation from Test Standard	56
4.5.6 EUT Operating Conditions	56
4.5.7 Test Results	57
4.6 Frequency Stability	63

4.6.1	Limit of Frequency Stability Measurement	63
4.6.2	Test Setup	63
4.6.3	Test Instruments	63
4.6.4	Test Procedure	63
4.6.5	Deviation from Test Standard	63
4.6.6	EUT Operating Condition	63
4.6.7	Test Results	64
4.7	6 dB Bandwidth Measurement.....	65
4.7.1	Limits of 6 dB Bandwidth Measurement.....	65
4.7.2	Test Setup.....	65
4.7.3	Test Instruments	65
4.7.4	Test Procedure	65
4.7.5	Deviation from Test Standard	65
4.7.6	EUT Operating Condition	65
4.7.7	Test Results	66
5	Pictures of Test Arrangements.....	68
	Annex A- Radiated Out of Band Emission (OOBE) Measurement (For U-NII-3 band)	69
	Appendix – Information of the Testing Laboratories	72

Release Control Record

Issue No.	Description	Date Issued
RF190822C14-1	Original Release	Oct. 16, 2019
RF190822C14-1 R1	Revise antenna connector type	Oct. 30, 2019

1 Certificate of Conformity

Product: ZyWALL ATP Firewall

Brand: ZYXEL

Test Model: ATP100W

Sample Status: Engineering Sample

Applicant: Zyxel Communications Corporation

Test Date: Sep. 17, 2019 ~ Sep. 24, 2019

Standards: 47 CFR FCC Part 15, Subpart E (Section 15.407)
ANSI C63.10:2013

The above equipment has been tested by **Bureau Veritas Consumer Products Services (H.K.) Ltd., Taoyuan Branch**, and found compliance with the requirement of the above standards. The test record, data evaluation & Equipment Under Test (EUT) configurations represented herein are true and accurate accounts of the measurements of the sample's RF characteristics under the conditions specified in this report.

Prepared by : , **Date:** Oct. 30, 2019
Rona Chen / Specialist

Approved by : , **Date:** Oct. 30, 2019
Dylan Chiou / Project Engineer

2 Summary of Test Results

47 CFR FCC Part 15, Subpart E (Section 15.407)			
FCC Clause	Test Item	Result	Remarks
15.407(b)(6)	AC Power Conducted Emissions	Pass	Meet the requirement of limit. Minimum passing margin is -17.93 dB at 0.39635 MHz.
15.407(b) (1/2/3/4(i/ii)/6)	Radiated Emissions & Band Edge Measurement	Pass	Meet the requirement of limit. Minimum passing margin is -0.51 dB at 15720 MHz.
15.407(a)(1/2/3)	Max Average Transmit Power	Pass	Meet the requirement of limit.
---	Occupied Bandwidth Measurement	-	Reference only
15.407(a)(1/2/3)	Peak Power Spectral Density	Pass	Meet the requirement of limit.
15.407(e)	6 dB Bandwidth	Pass	Meet the requirement of limit. (U-NII-3 Band only)
15.407(g)	Frequency Stability	Pass	Meet the requirement of limit.
15.203	Antenna Requirement	Pass	Antenna connector is Reverse SMA.

Note:

- For U-NII-3 band compliance with rule part 15.407(b)(4)(i), the OOB test plots were recorded in Annex A.
- Determining compliance based on the results of the compliance measurement, not taking into account measurement instrumentation uncertainty.

2.1 Measurement Uncertainty

Where relevant, the following measurement uncertainty levels have been estimated for tests performed on the EUT as specified in CISPR 16-4-2:

Measurement	Frequency	Expanded Uncertainty (k=2) (±)
Conducted Emissions at mains ports	150 kHz ~ 30 MHz	2.94 dB
Radiated Emissions up to 1 GHz	9 kHz ~ 30 MHz	3.04 dB
	30 MHz ~ 200 MHz	2.93 dB
	200 MHz ~ 1000 MHz	2.95 dB
Radiated Emissions above 1 GHz	1 GHz ~ 18 GHz	2.26 dB
	18 GHz ~ 40 GHz	1.94 dB

2.2 Modification Record

There were no modifications required for compliance.

3 General Information

3.1 General Description of EUT

Product	ZyWALL ATP Firewall
Brand	ZYXEL
Test Model	ATP100W
Status of EUT	Engineering Sample
Power Supply Rating	12.0 Vdc (Adapter)
Modulation Type	256QAM, 64QAM, 16QAM, QPSK, BPSK
Modulation Technology	OFDM
Transfer Rate	802.11a: 54.0/ 48.0/ 36.0/ 24.0/ 18.0/ 12.0/ 9.0/ 6.0 Mbps 802.11n: up to 300.0 Mbps 802.11ac: up to 866.7 Mbps
Operating Frequency	5180 ~ 5240 MHz, 5745 ~ 5825 MHz
Number of Channel	5180 ~ 5240 MHz: 4 for 802.11a, 802.11n (HT20), 802.11ac (VHT20) 2 for , 802.11n (HT40), 802.11ac (VHT40) 1 for 802.11ac (VHT80) 5745 ~ 5825 MHz: 5 for 802.11a, 802.11n (HT20), 802.11ac (VHT20) 2 for , 802.11n (HT40), 802.11ac (VHT40) 1 for 802.11ac (VHT80)
Output Power	543.814 mW for 5180 ~ 5240 MHz 748.38 mW for 5745 ~ 5825 MHz
Antenna Type	Dipole antenna with 3.86 dBi gain (5180 ~ 5240 MHz) Dipole antenna with 4.17 dBi gain (5745 ~ 5825 MHz)
Antenna Connector	Reverse SMA
Accessory Device	Refer to Note as below
Data Cable Supplied	Refer to Note as below

Note:

- The EUT incorporates a MIMO function. Physically, the EUT provides two completed transmitters and two receivers.



Modulation Mode	Tx Function
802.11a	2TX
802.11n (HT20)	2TX
802.11n (HT40)	2TX
802.11ac (VHT20)	2TX
802.11ac (VHT40)	2TX
802.11ac (VHT80)	2TX

* The modulation and bandwidth are similar for 802.11n mode for HT20 / HT40 and 802.11ac mode for VHT20 / VHT40, therefore investigated worst case to representative mode in test report. (Final test mode refer section 3.2.1)

- The EUT contains following accessory devices.

Product	Brand	Model	Description
Adapter	APD	WA-24Q12R	I/P: 100-240 Vac, 50-60 Hz, 0.7 A O/P: 12 Vdc, 2 A 1.5m cable w/o core
Console Cable	N/A	N/A	0.9m non-shielding cable

3. The EUT uses the following DDRs.

Item	Photo	Specification
1 st DDR (Worst Case)		Brand: NANYA (For DNI code)
2 nd DDR		Brand: WINBOND (For ZYXEL code)

4. The power setting of EUT is listed as below.

802.11a		802.11n (HT20)		802.11n (HT40)		802.11ac (VHT80)	
Channel	Power Setting	Channel	Power Setting	Channel	Power Setting	Channel	Power Setting
36	19.0	36	19.0	38	14.5	42	11.0
40	24.0	40	23.5	46	23.5	155	23.0
48	25.0	48	25.0	151	27.0		
149	27.0	149	27.0	159	27.0		
157	27.0	157	27.0				
165	27.0	165	27.0				

5. The above EUT information is declared by manufacturer and for more detailed features description, please refers to the manufacturer's specifications or user's manual.

3.2 Description of Test Modes

For 5180 ~ 5240 MHz

4 channels are provided for 802.11a, 802.11n (HT20), 802.11ac (VHT20):

Channel	Frequency (MHz)	Channel	Frequency (MHz)
36	5180	44	5220
40	5200	48	5240

2 channels are provided for , 802.11n (HT40), 802.11ac (VHT40):

Channel	Frequency (MHz)	Channel	Frequency (MHz)
38	5190	46	5230

1 channel is provided for 802.11ac (VHT80):

Channel	Frequency (MHz)
42	5210

For 5745 ~ 5825 MHz:

5 channels are provided for 802.11a, 802.11n (HT20), 802.11ac (VHT20):

Channel	Frequency (MHz)	Channel	Frequency (MHz)
149	5745	161	5805
153	5765	165	5825
157	5785		

2 channels are provided for , 802.11n (HT40), 802.11ac (VHT40):

Channel	Frequency (MHz)	Channel	Frequency (MHz)
151	5755	159	5795

1 channel is provided for 802.11ac (VHT80):

Channel	Frequency (MHz)
155	5775

3.2.1 Test Mode Applicability and Tested Channel Detail

EUT Configure Mode	Applicable To				Description
	RE \geq 1G	RE $<$ 1G	PLC	APCM	
-	√	√	√	√	2TX

Where **RE \geq 1G**: Radiated Emission above 1 GHz **RE $<$ 1G**: Radiated Emission below 1 GHz
PLC: Power Line Conducted Emission **APCM**: Antenna Port Conducted Measurement

NOTE: The EUT had been pre-tested on the positioned of X and Z axis. The worst case was found when positioned EUT on **X-plane** and Antenna on **Z-plane**.

Radiated Emission Test (Above 1 GHz):

- Pre-Scan has been conducted to determine the worst-case mode from all possible combinations between available modulations, data rates and antenna ports (if EUT with antenna diversity architecture).
- Following channel(s) was (were) selected for the final test as listed below.

EUT Configure Mode	Frequency Band (MHz)	Mode	Available Channel	Tested Channel	Modulation Technology	Modulation Type	Data Rate (Mbps)
-	5180-5240	802.11a	36 to 48	36, 40, 48	OFDM	BPSK	6.0
-		802.11n (HT20)	36 to 48	36, 40, 48	OFDM	BPSK	6.5
-		802.11n (HT40)	38 to 46	38, 46	OFDM	BPSK	13.5
-		802.11ac (VHT80)	42	42	OFDM	BPSK	29.3
-	5745-5825	802.11a	149 to 165	149, 157, 165	OFDM	BPSK	6.0
-		802.11n (HT20)	149 to 165	149, 157, 165	OFDM	BPSK	6.5
-		802.11n (HT40)	151 to 159	151, 159	OFDM	BPSK	13.5
-		802.11ac (VHT80)	155	155	OFDM	BPSK	29.3

Radiated Emission Test (Below 1 GHz):

- Pre-Scan has been conducted to determine the worst-case mode from all possible combinations between available modulations, data rates and antenna ports (if EUT with antenna diversity architecture).
- Following channel(s) was (were) selected for the final test as listed below.

EUT Configure Mode	Frequency Band (MHz)	Mode	Available Channel	Tested Channel	Modulation Technology	Modulation Type	Data Rate (Mbps)
-	5180-5240	802.11a	36 to 48	48	OFDM	BPSK	6.0

Power Line Conducted Emission Test:

- Pre-Scan has been conducted to determine the worst-case mode from all possible combinations between available modulations, data rates and antenna ports (if EUT with antenna diversity architecture).
- Following channel(s) was (were) selected for the final test as listed below.

EUT Configure Mode	Frequency Band (MHz)	Mode	Available Channel	Tested Channel	Modulation Technology	Modulation Type	Data Rate (Mbps)
-	5180-5240	802.11a	36 to 48	48	OFDM	BPSK	6.0

Antenna Port Conducted Measurement:

- This item includes all test value of each mode, but only includes spectrum plot of worst value of each mode.
- Pre-Scan has been conducted to determine the worst-case mode from all possible combinations between available modulations, data rates and antenna ports (if EUT with antenna diversity architecture).
- Following channel(s) was (were) selected for the final test as listed below.

EUT Configure Mode	Frequency Band (MHz)	Mode	Available Channel	Tested Channel	Modulation Technology	Modulation Type	Data Rate (Mbps)
-	5180-5240	802.11a	36 to 48	36, 40, 48	OFDM	BPSK	6.0
-		802.11n (HT20)	36 to 48	36, 40, 48	OFDM	BPSK	6.5
-		802.11n (HT40)	38 to 46	38, 46	OFDM	BPSK	13.5
-		802.11ac (VHT80)	42	42	OFDM	BPSK	29.3
-	5745-5825	802.11a	149 to 165	149, 157, 165	OFDM	BPSK	6.0
-		802.11n (HT20)	149 to 165	149, 157, 165	OFDM	BPSK	6.5
-		802.11n (HT40)	151 to 159	151, 159	OFDM	BPSK	13.5
-		802.11ac (VHT80)	155	155	OFDM	BPSK	29.3

Test Condition:

Applicable To	Environmental Conditions	Input Power	Tested by
RE \geq 1G	25 deg. C, 65 % RH	120 Vac, 60 Hz	Thomas Wei
RE $<$ 1G	25 deg. C, 65 % RH	120 Vac, 60 Hz	Thomas Wei
PLC	25 deg. C, 65 % RH	120 Vac, 60 Hz	Thomas Wei
APCM	25 deg. C, 65 % RH	12 Vdc	Jisyong Wang

3.3 Duty Cycle of Test Signal

MODULATION TYPE: BPSK

802.11a: Duty cycle = $2.023/2.100 = 0.963$, Duty factor = $10 * \log(1/0.963) = 0.16$

802.11n (HT20): Duty cycle = $1.880/1.957 = 0.961$, Duty factor = $10 * \log(1/0.961) = 0.17$

802.11n (HT40): Duty cycle = $0.924/0.993 = 0.931$, Duty factor = $10 * \log(1/0.931) = 0.31$

802.11ac (VHT80): Duty cycle = $0.455/0.532 = 0.855$, Duty factor = $10 * \log(1/0.855) = 0.68$

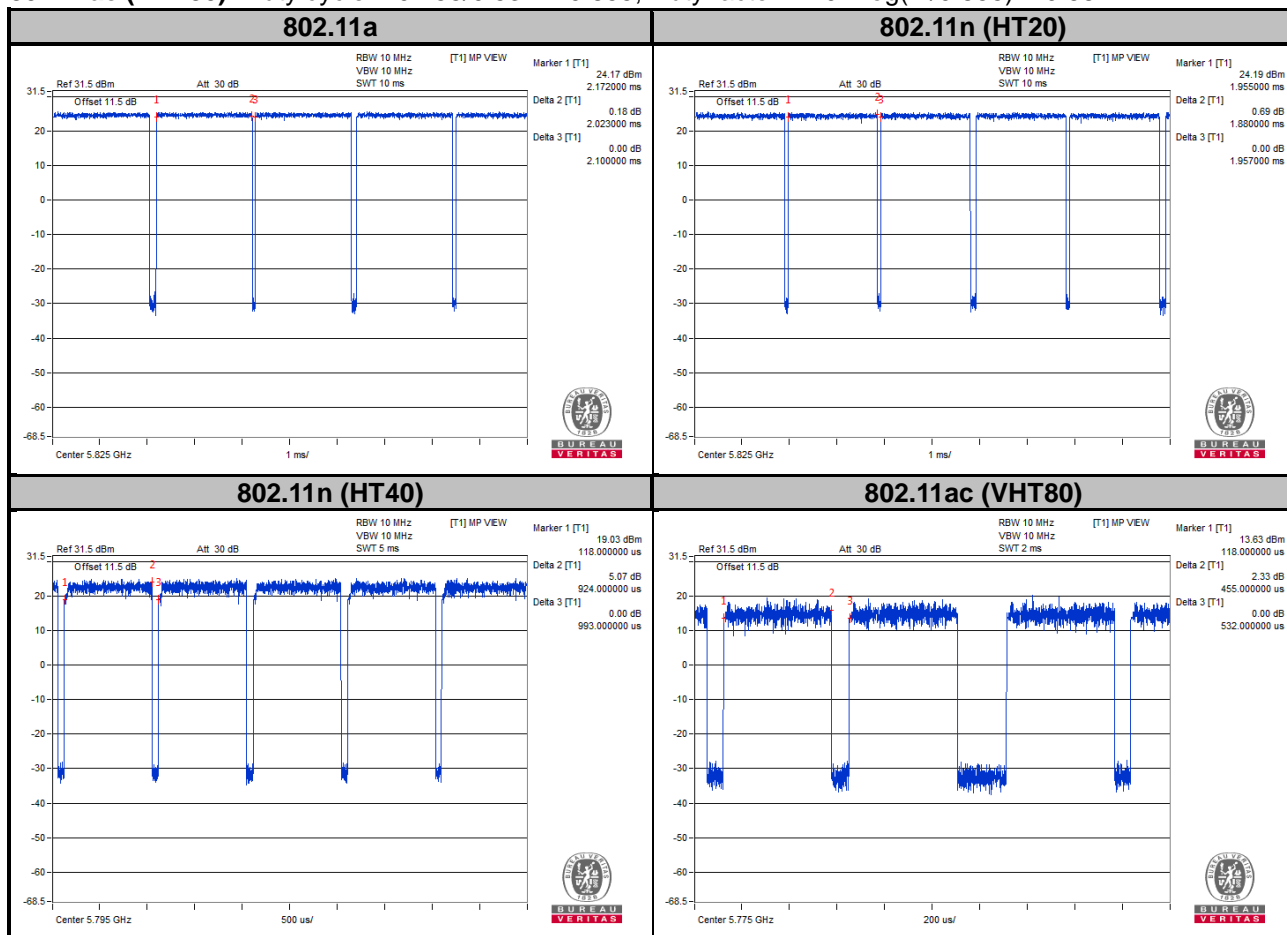

3.4 Description of Support Units

The EUT has been tested as an independent unit together with other necessary accessories or support units.

3.4.1 Configuration of System under Test

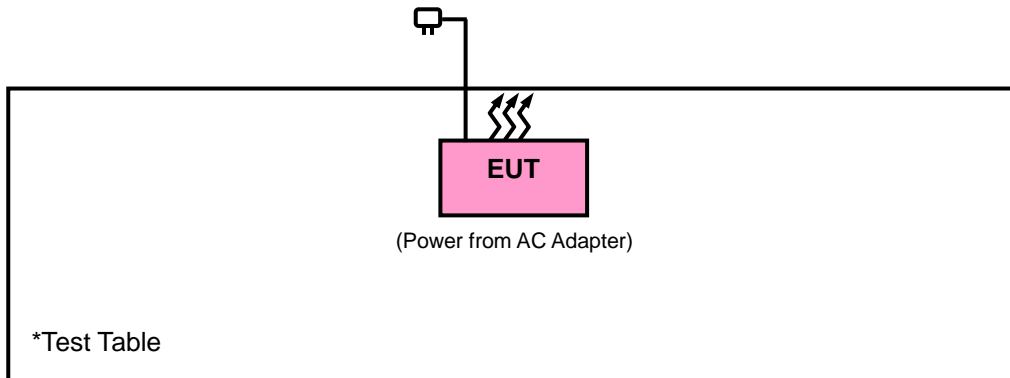

3.5 General Description of Applied Standards

The EUT is a RF Product. According to the specifications of the manufacturer, it must comply with the requirements of the following standards:

FCC Part 15, Subpart E (15.407)

KDB 789033 D02 General UNII Test Procedures New Rules v02r01

KDB 662911 D01 Multiple Transmitter Output v02r01

ANSI C63.10-2013

All test items have been performed and recorded as per the above standards.

4 Test Types and Results

4.1 Radiated Emission and Bandedge Measurement

4.1.1 Limits of Radiated Emission and Bandedge Measurement

Radiated emissions which fall in the restricted bands must comply with the radiated emission limits specified as below table.

Frequencies (MHz)	Field Strength (microvolts/meter)	Measurement Distance (meters)
0.009 ~ 0.490	2400/F (kHz)	300
0.490 ~ 1.705	24000/F (kHz)	30
1.705 ~ 30.0	30	30
30 ~ 88	100	3
88 ~ 216	150	3
216 ~ 960	200	3
Above 960	500	3

Note:

1. The lower limit shall apply at the transition frequencies.
2. Emission level (dBuV/m) = 20 log Emission level (uV/m).
3. For frequencies above 1000 MHz, the field strength limits are based on average detector, however, the peak field strength of any emission shall not exceed the maximum permitted average limits, specified above by more than 20 dB under any condition of modulation.

4.1.2 Limits of Unwanted Emission Out of the Restricted Bands

Applicable To		Limit	
789033 D02 General UNII Test Procedures New Rules v02r01		Field Strength at 3 m	
		PK: 74 (dBµV/m)	AV: 54 (dBµV/m)
Frequency Band	Applicable To	EIRP Limit	Equivalent Field Strength at 3 m
5150~5250 MHz	15.407(b)(1)	PK: -27 (dBm/MHz)	PK: 68.2 (dBµV/m)
5250~5350 MHz	15.407(b)(2)		
5470~5725 MHz	15.407(b)(3)		
5725~5850 MHz	<input checked="" type="checkbox"/> 15.407(b)(4)(i)	PK:-27 (dBm/MHz) ^{*1} PK:10 (dBm/MHz) ^{*2} PK:15.6 (dBm/MHz) ^{*3} PK:27 (dBm/MHz) ^{*4}	PK: 68.2 (dBµV/m) ^{*1} PK:105.2 (dBµV/m) ^{*2} PK: 110.8 (dBµV/m) ^{*3} PK:122.2 (dBµV/m) ^{*4}
	<input type="checkbox"/> 15.407(b)(4)(ii)	Emission limits in section 15.247(d)	

^{*1} beyond 75 MHz or more above of the band edge.
^{*2} below the band edge increasing linearly to 10 dBm/MHz at 25 MHz above.
^{*3} below the band edge increasing linearly to a level of 15.6 dBm/MHz at 5 MHz above.
^{*4} from 5 MHz above or below the band edge increasing linearly to a level of 27 dBm/MHz at the band edge.

Note:

The following formula is used to convert the equipment isotropic radiated power (eirp) to field strength:

$$E = \frac{1000000\sqrt{30P}}{3} \mu\text{V/m, where } P \text{ is the eirp (Watts).}$$

4.1.3 Test Instruments

Description & Manufacturer	Model No.	Serial No.	Date of Calibration	Due Date of Calibration
Test Receiver Agilent	N9038A	MY51210203	Mar. 18, 2019	Mar. 17, 2020
Spectrum Analyzer Agilent	N9010A	MY52220314	Dec. 13, 2018	Dec. 12, 2019
Spectrum Analyzer ROHDE & SCHWARZ	FSU43	101261	Apr. 15, 2019	Apr. 14, 2020
Broadband Horn Antenna SCHWARZBECK	BBHA 9170	148	Nov. 25, 2018	Nov. 24, 2019
HORN Antenna SCHWARZBECK	BBHA 9120D	9120D-969	Nov. 25, 2018	Nov. 24, 2019
BILOG Antenna SCHWARZBECK	VULB 9168	9168-472	Nov. 23, 2018	Nov. 22, 2019
Fixed Attenuator WORKEN	MDCS18N-10	MDCS18N-10-01	Apr. 15, 2019	Apr. 14, 2020
Loop Antenna	HLA 6121	45745	Jul. 01, 2019	Jun. 30, 2020
Preamplifier EMCI	EMC001340	980201	Oct. 12, 2018	Oct. 11, 2019
Preamplifier EMCI	EMC 012645	980115	Oct. 12, 2018	Oct. 11, 2019
Preamplifier EMCI	EMC 184045	980116	Oct. 12, 2018	Oct. 11, 2019
Preamplifier EMCI	EMC 330H	980112	Oct. 12, 2018	Oct. 11, 2019
Power Meter Anritsu	ML2495A	1012010	Sep. 04, 2019	Sep. 03, 2020
Power Sensor Anritsu	MA2411B	1315050	Sep. 04, 2019	Sep. 03, 2020
RF Coaxial Cable HUBER+SUHNNER	EMC104-SM-SM-8 000&3000	140811+170717	Oct. 12, 2018	Oct. 11, 2019
RF Coaxial Cable HUBER+SUHNNER	SUCOFLEX 104	EMC104-SM-SM-1 000(140807)	Oct. 12, 2018	Oct. 11, 2019
RF Coaxial Cable WOKEN	8D-FB	Cable-Ch10-01	Oct. 12, 2018	Oct. 11, 2019
Software BV ADT	E3 6.120103	NA	NA	NA
Antenna Tower MF	MFA-440H	NA	NA	NA
Turn Table MF	MFT-201SS	NA	NA	NA
Antenna Tower & Turn Table Controller MF	MF-7802	NA	NA	NA
Temperature & Humidity Chamber	GTH-120-40-CP-A R	MAA1306-019	Sep. 06, 2019	Sep. 05, 2020
DC Power Supply Topward	33010D	807748	Oct. 24, 2018	Oct. 23, 2019
Digital Multimeter Fluke	87-III	70360742	Jun. 27, 2019	Jun. 26, 2020

- Note: 1. The calibration interval of the above test instruments is 12 months and the calibrations are traceable to NML/ROC and NIST/USA.
2. The test was performed in HwaYa Chamber 10.

4.1.4 Test Procedures

For Radiated Emission below 30 MHz

- a. The EUT was placed on the top of a rotating table 0.8 meters above the ground at a 3 meter chamber room. The table was rotated 360 degrees to determine the position of the highest radiation.
- b. The EUT was set 3 meters away from the interference-receiving antenna, which was mounted on the top of a variable-height antenna tower.
- c. Both Parallel, perpendicular, and ground-parallel orientations of the antenna are set to make the measurement.
- d. For each suspected emission, the EUT was arranged to its worst case and the rotatable table was turned from 0 degrees to 360 degrees to find the maximum reading.
- e. The test-receiver system was set to Quasi-Peak Detect Function and Specified Bandwidth with Maximum Hold Mode.

Note:

1. The resolution bandwidth and video bandwidth of test receiver/spectrum analyzer is 9 kHz at frequency below 30 MHz.

For Radiated Emission above 30 MHz

- a. The EUT was placed on the top of a rotating table 0.8 meters (for 30 MHz ~ 1 GHz) / 1.5 meters (for above 1 GHz) above the ground at 3 meter chamber room for test. The table was rotated 360 degrees to determine the position of the highest radiation.
- b. The EUT was set 3 meters away from the interference-receiving antenna, which was mounted on the top of a variable-height antenna tower.
- c. The height of antenna is varied from one meter to four meters above the ground to determine the maximum value of the field strength. Both horizontal and vertical polarizations of the antenna are set to make the measurement.
- d. For each suspected emission, the EUT was arranged to its worst case and then the antenna was tuned to heights from 1 meter to 4 meters and the rotatable table was turned from 0 degrees to 360 degrees to find the maximum reading.
- e. The test-receiver system was set to quasi-peak detect function and specified bandwidth with maximum hold mode when the test frequency is below 1 GHz.
- f. The test-receiver system was set to peak and average detected function and specified bandwidth with maximum hold mode when the test frequency is above 1 GHz. If the peak reading value also meets average limit, measurement with the average detector is unnecessary.

Note:

1. The resolution bandwidth and video bandwidth of test receiver/spectrum analyzer is 120 kHz for Quasi-peak detection (QP) or Peak detection (PK) at frequency below 1 GHz.
2. The resolution bandwidth of test receiver/spectrum analyzer is 1 MHz and the video bandwidth is 3 MHz for Peak detection (PK) at frequency above 1 GHz.
3. The resolution bandwidth of test receiver/spectrum analyzer is 1 MHz and the video bandwidth is $\geq 1/T$ (Duty cycle < 98 %) or 10 Hz (Duty cycle ≥ 98 %) for Average detection (AV) at frequency above 1 GHz.
(11a: RBW = 1 MHz, VBW = 1 kHz ; 11n (HT20): RBW = 1 MHz, VBW = 1 kHz ;
11n (HT40): RBW = 1 MHz, VBW = 3 kHz ; 11ac (VHT80): RBW = 1 MHz, VBW = 3 kHz)
4. All modes of operation were investigated and the worst-case emissions are reported.

4.1.5 Deviation from Test Standard

No deviation.

4.1.6 Test Setup

<Radiated Emission below 30 MHz>

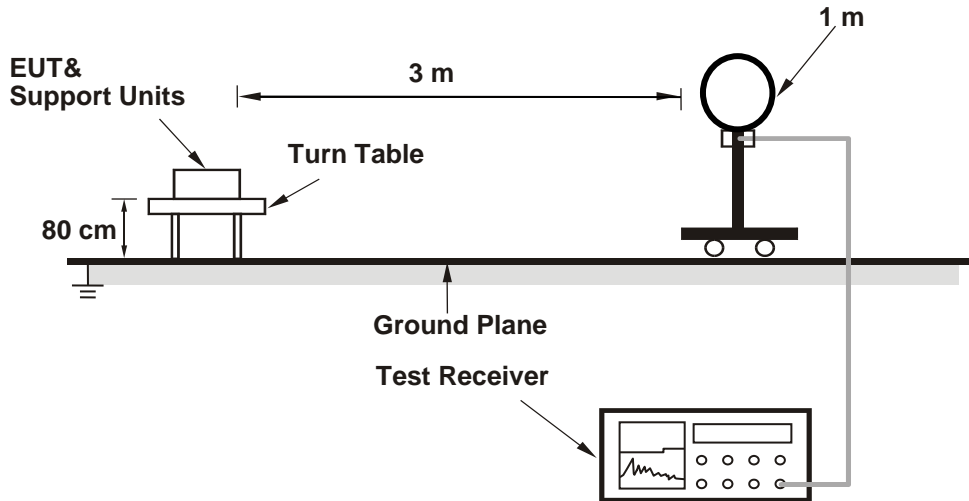

<Radiated Emission 30 MHz to 1 GHz>

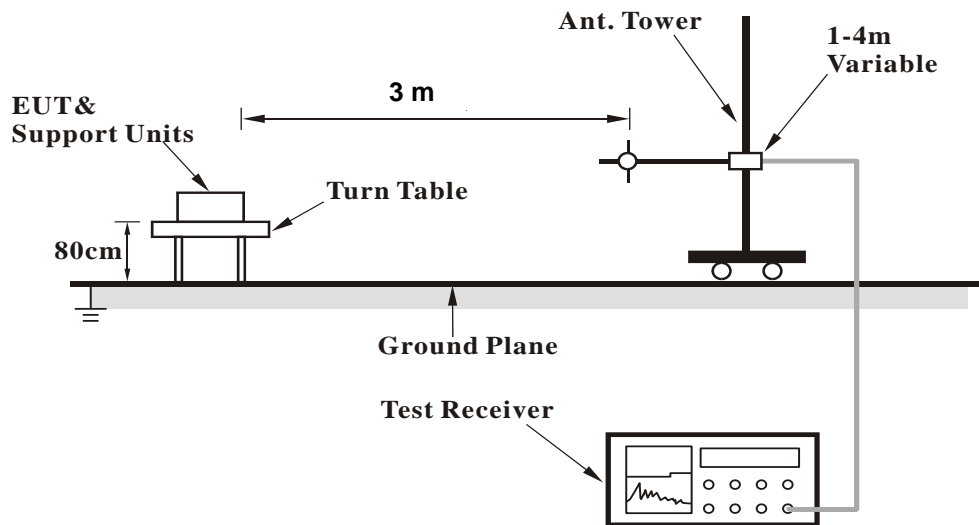

<Radiated Emission above 1 GHz>

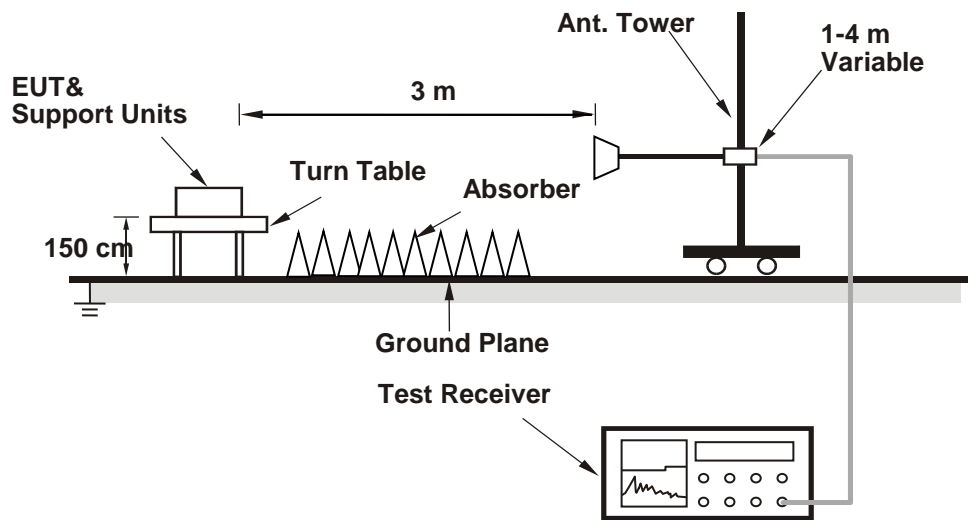

For the actual test configuration, please refer to the attached file (Test Setup Photo).

4.1.7 EUT Operating Conditions

- Placed the EUT on a testing table.
- Use the software to control the EUT under transmission condition continuously at specific channel frequency.

4.1.8 Test Results
Above 1 GHz Data :
802.11a

EUT Test Condition		Measurement Detail	
Channel	Channel 36	Frequency Range	1 GHz ~ 40 GHz
Input Power	120 Vac, 60 Hz	Detector Function	Peak (PK) Average (AV)
Environmental Conditions	25 deg. C, 65 % RH	Tested By	Thomas Wei

Antenna Polarity & Test Distance: Horizontal at 3 m								
Frequency (MHz)	Emission Level (dBuV/m)	Read Level (dBuV)	Factor (dB/m)	Limit (dBuV/m)	Margin (dB)	Antenna Height (cm)	Table Angle (Degree)	Remark
5149.94	46.21	44.68	1.53	54	-7.79	120	153	Average
5149.94	54.16	52.63	1.53	74	-19.84	120	153	Peak
5180	99.57	98.04	1.53			120	153	Average
5180	104.85	103.32	1.53			120	153	Peak
*10360	54.34	57.18	-2.84	68.2	-13.86	147	228	Peak
Antenna Polarity & Test Distance: Vertical at 3 m								
Frequency (MHz)	Emission Level (dBuV/m)	Read Level (dBuV)	Factor (dB/m)	Limit (dBuV/m)	Margin (dB)	Antenna Height (cm)	Table Angle (Degree)	Remark
5149.58	53.16	51.63	1.53	54	-0.84	176	355	Average
5149.58	60.8	59.27	1.53	74	-13.2	176	355	Peak
5180	109.6	108.07	1.53			176	355	Average
5180	113	111.47	1.53			176	355	Peak
*10360	54.69	57.53	-2.84	68.2	-13.51	166	213	Peak

Remarks:

- Emission Level = Read Level + Factor
Margin value = Emission level – Limit value
- 5180 MHz: Fundamental Frequency
- *: Out of Restricted Band
- The emission levels of other frequencies were very low against the limit

EUT Test Condition		Measurement Detail	
Channel	Channel 40	Frequency Range	1 GHz ~ 40 GHz
Input Power	120 Vac, 60 Hz	Detector Function	Peak (PK) Average (AV)
Environmental Conditions	25 deg. C, 65 % RH	Tested By	Thomas Wei

Antenna Polarity & Test Distance: Horizontal at 3 m								
Frequency (MHz)	Emission Level (dBuV/m)	Read Level (dBuV)	Factor (dB/m)	Limit (dBuV/m)	Margin (dB)	Antenna Height (cm)	Table Angle (Degree)	Remark
5149.94	46.33	44.8	1.53	54	-7.67	146	152	Average
5149.94	56.35	54.82	1.53	74	-17.65	146	152	Peak
5200	102.91	101.38	1.53			146	152	Average
5200	108.34	106.81	1.53			146	152	Peak
*10400	55.32	58.21	-2.89	68.2	-12.88	117	100	Peak
15600	51.38	51.85	-0.47	54	-2.62	115	106	Average
15600	60.63	61.1	-0.47	74	-13.37	115	106	Peak

Antenna Polarity & Test Distance: Vertical at 3 m								
Frequency (MHz)	Emission Level (dBuV/m)	Read Level (dBuV)	Factor (dB/m)	Limit (dBuV/m)	Margin (dB)	Antenna Height (cm)	Table Angle (Degree)	Remark
5149.4	53.11	51.58	1.53	54	-0.89	176	355	Average
5149.4	63.33	61.8	1.53	74	-10.67	176	355	Peak
5200	114.47	112.94	1.53			176	355	Average
5200	115.28	113.75	1.53			176	355	Peak
*10400	57.11	60	-2.89	68.2	-11.09	202	119	Peak

Remarks:

- Emission Level = Read Level + Factor
Margin value = Emission level – Limit value
- 5200 MHz: Fundamental Frequency
- *: Out of Restricted Band
- The emission levels of other frequencies were very low against the limit

EUT Test Condition		Measurement Detail	
Channel	Channel 48	Frequency Range	1 GHz ~ 40 GHz
Input Power	120 Vac, 60 Hz	Detector Function	Peak (PK) Average (AV)
Environmental Conditions	25 deg. C, 65 % RH	Tested By	Thomas Wei

Antenna Polarity & Test Distance: Horizontal at 3 m								
Frequency (MHz)	Emission Level (dBuV/m)	Read Level (dBuV)	Factor (dB/m)	Limit (dBuV/m)	Margin (dB)	Antenna Height (cm)	Table Angle (Degree)	Remark
5148.32	42.15	40.62	1.53	54	-11.85	130	153	Average
5148.32	50.74	49.21	1.53	74	-23.26	130	153	Peak
5240	105.55	104.17	1.38			130	153	Average
5240	112.23	110.85	1.38			130	153	Peak
5354.95	43.43	41.97	1.46	54	-10.57	130	153	Average
5354.95	52.62	51.16	1.46	74	-21.38	130	153	Peak
*10480	54.82	57.55	-2.73	68.2	-13.38	132	166	Peak
15720	53.49	54.92	-1.43	54	-0.51	100	107	Average
15720	61.92	63.35	-1.43	74	-12.08	100	107	Peak
Antenna Polarity & Test Distance: Vertical at 3 m								
Frequency (MHz)	Emission Level (dBuV/m)	Read Level (dBuV)	Factor (dB/m)	Limit (dBuV/m)	Margin (dB)	Antenna Height (cm)	Table Angle (Degree)	Remark
5148.14	49.02	47.49	1.53	54	-4.98	176	355	Average
5148.14	57.47	55.94	1.53	74	-16.53	176	355	Peak
5240	114.79	113.41	1.38			176	355	Average
5240	116.52	115.14	1.38			176	355	Peak
5351.32	46.5	45.04	1.46	54	-7.5	176	355	Average
5351.32	55	53.54	1.46	74	-19	176	355	Peak
*10480	58.38	61.11	-2.73	68.2	-9.82	201	115	Peak
15720	52.99	54.42	-1.43	54	-1.01	168	38	Average
15720	61.42	62.85	-1.43	74	-12.58	168	38	Peak

Remarks:

- Emission Level = Read Level + Factor
Margin value = Emission level – Limit value
- 5240 MHz: Fundamental Frequency
- *: Out of Restricted Band
- The emission levels of other frequencies were very low against the limit

EUT Test Condition		Measurement Detail	
Channel	Channel 149	Frequency Range	1 GHz ~ 40 GHz
Input Power	120 Vac, 60 Hz	Detector Function	Peak (PK) Average (AV)
Environmental Conditions	25 deg. C, 65 % RH	Tested By	Thomas Wei

<Spurious Emission>

Antenna Polarity & Test Distance: Horizontal at 3 m								
Frequency (MHz)	Emission Level (dBuV/m)	Read Level (dBuV)	Factor (dB/m)	Limit (dBuV/m)	Margin (dB)	Antenna Height (cm)	Table Angle (Degree)	Remark
5745	105.14	103.32	1.82			102	219	Average
5745	111.84	110.02	1.82			102	219	Peak
11490	47.5	49.7	-2.2	54	-6.5	116	240	Average
11490	56.19	58.39	-2.2	74	-17.81	116	240	Peak
Antenna Polarity & Test Distance: Vertical at 3 m								
Frequency (MHz)	Emission Level (dBuV/m)	Read Level (dBuV)	Factor (dB/m)	Limit (dBuV/m)	Margin (dB)	Antenna Height (cm)	Table Angle (Degree)	Remark
5745	112.09	110.27	1.82			147	2	Average
5745	116.13	114.31	1.82			147	2	Peak
11490	51	53.2	-2.2	54	-3	210	128	Average
11490	59.03	61.23	-2.2	74	-14.97	210	128	Peak

<Out of Band Emission (OOBE)>

Antenna Polarity & Test Distance: Horizontal at 3 m								
Frequency (MHz)	Emission Level (dBuV/m)	Read Level (dBuV)	Factor (dB/m)	Limit (dBuV/m)	Margin (dB)	Antenna Height (cm)	Table Angle (Degree)	Remark
5647.375	51.9	50.02	1.88	68.2	-16.3	102	219	Peak
5653.55	50.33	48.42	1.91	70.84	-20.51	102	219	Peak
5920.025	50.03	47.72	2.31	71.87	-21.84	102	219	Peak
5942.35	52.05	49.76	2.29	68.2	-16.15	102	219	Peak
Antenna Polarity & Test Distance: Vertical at 3 m								
Frequency (MHz)	Emission Level (dBuV/m)	Read Level (dBuV)	Factor (dB/m)	Limit (dBuV/m)	Margin (dB)	Antenna Height (cm)	Table Angle (Degree)	Remark
5623.15	57.32	55.42	1.9	68.2	-10.88	147	2	Peak
5655.925	57.14	55.29	1.85	72.6	-15.46	147	2	Peak
5923.825	53.9	51.6	2.3	69.07	-15.17	147	2	Peak
6012.65	54.52	52.12	2.4	68.2	-13.68	147	2	Peak

Remarks:

- Emission Level = Read Level + Factor
Margin value = Emission level – Limit value
- 5745 MHz: Fundamental Frequency
- *: Out of Restricted Band
- The emission levels of other frequencies were very low against the limit

EUT Test Condition		Measurement Detail	
Channel	Channel 157	Frequency Range	1 GHz ~ 40 GHz
Input Power	120 Vac, 60 Hz	Detector Function	Peak (PK) Average (AV)
Environmental Conditions	25 deg. C, 65 % RH	Tested By	Thomas Wei

<Spurious Emission>

Antenna Polarity & Test Distance: Horizontal at 3 m								
Frequency (MHz)	Emission Level (dBuV/m)	Read Level (dBuV)	Factor (dB/m)	Limit (dBuV/m)	Margin (dB)	Antenna Height (cm)	Table Angle (Degree)	Remark
5785	104.37	102.45	1.92			104	219	Average
5785	110.32	108.4	1.92			104	219	Peak
11570	47.03	49.23	-2.2	54	-6.97	117	238	Average
11570	55.36	57.56	-2.2	74	-18.64	117	238	Peak
Antenna Polarity & Test Distance: Vertical at 3 m								
Frequency (MHz)	Emission Level (dBuV/m)	Read Level (dBuV)	Factor (dB/m)	Limit (dBuV/m)	Margin (dB)	Antenna Height (cm)	Table Angle (Degree)	Remark
5785	110.25	108.33	1.92			145	350	Average
5785	116.27	114.35	1.92			145	350	Peak
11570	49.81	52.01	-2.2	54	-4.19	205	143	Average
11570	55.4	57.6	-2.2	74	-18.6	205	143	Peak

<Out of Band Emission (OOBE)>

Antenna Polarity & Test Distance: Horizontal at 3 m								
Frequency (MHz)	Emission Level (dBuV/m)	Read Level (dBuV)	Factor (dB/m)	Limit (dBuV/m)	Margin (dB)	Antenna Height (cm)	Table Angle (Degree)	Remark
5611.75	52.28	50.41	1.87	68.2	-15.92	104	219	Peak
5651.65	51.17	49.26	1.91	69.43	-18.26	104	219	Peak
5917.175	50.18	47.87	2.31	73.97	-23.79	104	219	Peak
5975.6	50.91	48.58	2.33	68.2	-17.29	104	219	Peak
Antenna Polarity & Test Distance: Vertical at 3 m								
Frequency (MHz)	Emission Level (dBuV/m)	Read Level (dBuV)	Factor (dB/m)	Limit (dBuV/m)	Margin (dB)	Antenna Height (cm)	Table Angle (Degree)	Remark
5609.85	55.88	54.01	1.87	68.2	-12.32	145	350	Peak
5654.025	55	53.15	1.85	71.19	-16.19	145	350	Peak
5922.4	52.87	50.57	2.3	70.12	-17.25	145	350	Peak
5978.45	53.37	51.04	2.33	68.2	-14.83	145	350	Peak

Remarks:

- Emission Level = Read Level + Factor
Margin value = Emission level – Limit value
- 5785 MHz: Fundamental Frequency
- *: Out of Restricted Band
- The emission levels of other frequencies were very low against the limit

EUT Test Condition		Measurement Detail	
Channel	Channel 165	Frequency Range	1 GHz ~ 40 GHz
Input Power	120 Vac, 60 Hz	Detector Function	Peak (PK) Average (AV)
Environmental Conditions	25 deg. C, 65 % RH	Tested By	Thomas Wei

<Spurious Emission>

Antenna Polarity & Test Distance: Horizontal at 3 m								
Frequency (MHz)	Emission Level (dBuV/m)	Read Level (dBuV)	Factor (dB/m)	Limit (dBuV/m)	Margin (dB)	Antenna Height (cm)	Table Angle (Degree)	Remark
5825	103.47	101.39	2.08			140	158	Average
5825	109.33	107.25	2.08			140	158	Peak
11650	48.61	51	-2.39	54	-5.39	222	202	Average
11650	57.81	60.2	-2.39	74	-16.19	222	202	Peak
Antenna Polarity & Test Distance: Vertical at 3 m								
Frequency (MHz)	Emission Level (dBuV/m)	Read Level (dBuV)	Factor (dB/m)	Limit (dBuV/m)	Margin (dB)	Antenna Height (cm)	Table Angle (Degree)	Remark
5825	109.65	107.57	2.08			129	350	Average
5825	115.23	113.15	2.08			129	350	Peak
11650	52.13	54.52	-2.39	54	-1.87	200	124	Average
11650	61.51	63.9	-2.39	74	-12.49	200	124	Peak

<Out of Band Emission (OOBE)>

Antenna Polarity & Test Distance: Horizontal at 3 m								
Frequency (MHz)	Emission Level (dBuV/m)	Read Level (dBuV)	Factor (dB/m)	Limit (dBuV/m)	Margin (dB)	Antenna Height (cm)	Table Angle (Degree)	Remark
5620.775	52.02	50.12	1.9	68.2	-16.18	140	158	Peak
5650.7	52.52	50.61	1.91	68.72	-16.2	140	158	Peak
5918.125	52.27	49.96	2.31	73.27	-21	140	158	Peak
5991.75	51.74	49.38	2.36	68.2	-16.46	140	158	Peak
Antenna Polarity & Test Distance: Vertical at 3 m								
Frequency (MHz)	Emission Level (dBuV/m)	Read Level (dBuV)	Factor (dB/m)	Limit (dBuV/m)	Margin (dB)	Antenna Height (cm)	Table Angle (Degree)	Remark
5577.55	57.63	55.81	1.82	68.2	-10.57	129	350	Peak
5658.775	56.85	55	1.85	74.72	-17.87	129	350	Peak
5923.825	56.91	54.61	2.3	69.07	-12.16	129	350	Peak
5953.275	55.9	53.61	2.29	68.2	-12.3	129	350	Peak

Remarks:

- Emission Level = Read Level + Factor
Margin value = Emission level – Limit value
- 5825 MHz: Fundamental Frequency
- *: Out of Restricted Band
- The emission levels of other frequencies were very low against the limit

802.11n (HT20)

EUT Test Condition		Measurement Detail	
Channel	Channel 36	Frequency Range	1 GHz ~ 40 GHz
Input Power	120 Vac, 60 Hz	Detector Function	Peak (PK) Average (AV)
Environmental Conditions	25 deg. C, 65 % RH	Tested By	Thomas Wei

Antenna Polarity & Test Distance: Horizontal at 3 m								
Frequency (MHz)	Emission Level (dBuV/m)	Read Level (dBuV)	Factor (dB/m)	Limit (dBuV/m)	Margin (dB)	Antenna Height (cm)	Table Angle (Degree)	Remark
5149.55	44.14	42.61	1.53	54	-9.86	130	224	Average
5149.55	51.77	50.24	1.53	74	-22.23	130	224	Peak
5180	97.25	95.72	1.53			130	224	Average
5180	103.54	102.01	1.53			130	224	Peak
*10360	54.12	56.96	-2.84	68.2	-14.08	137	114	Peak
Antenna Polarity & Test Distance: Vertical at 3 m								
Frequency (MHz)	Emission Level (dBuV/m)	Read Level (dBuV)	Factor (dB/m)	Limit (dBuV/m)	Margin (dB)	Antenna Height (cm)	Table Angle (Degree)	Remark
5150	52.81	51.28	1.53	54	-1.19	180	357	Average
5150	61.26	59.73	1.53	74	-12.74	180	357	Peak
5180	107.08	105.55	1.53			180	357	Average
5180	111.59	110.06	1.53			180	357	Peak
*10360	54.59	57.43	-2.84	68.2	-13.61	167	255	Peak

Remarks:

- Emission Level = Read Level + Factor
Margin value = Emission level – Limit value
- 5180 MHz: Fundamental Frequency
- *: Out of Restricted Band
- The emission levels of other frequencies were very low against the limit

EUT Test Condition		Measurement Detail	
Channel	Channel 40	Frequency Range	1 GHz ~ 40 GHz
Input Power	120 Vac, 60 Hz	Detector Function	Peak (PK) Average (AV)
Environmental Conditions	25 deg. C, 65 % RH	Tested By	Thomas Wei

Antenna Polarity & Test Distance: Horizontal at 3 m								
Frequency (MHz)	Emission Level (dBuV/m)	Read Level (dBuV)	Factor (dB/m)	Limit (dBuV/m)	Margin (dB)	Antenna Height (cm)	Table Angle (Degree)	Remark
5148.8	44.17	42.64	1.53	54	-9.83	141	152	Average
5148.8	52.49	50.96	1.53	74	-21.51	141	152	Peak
5200	100.29	98.76	1.53			141	152	Average
5200	106.12	104.59	1.53			141	152	Peak
*10400	55.03	57.92	-2.89	68.2	-13.17	162	103	Peak

Antenna Polarity & Test Distance: Vertical at 3 m								
Frequency (MHz)	Emission Level (dBuV/m)	Read Level (dBuV)	Factor (dB/m)	Limit (dBuV/m)	Margin (dB)	Antenna Height (cm)	Table Angle (Degree)	Remark
5150	52.61	51.08	1.53	54	-1.39	180	356	Average
5150	61.19	59.66	1.53	74	-12.81	180	356	Peak
5200	111.88	110.35	1.53			180	356	Average
5200	114.76	113.23	1.53			180	356	Peak
*10400	56.52	59.41	-2.89	68.2	-11.68	205	117	Peak

Remarks:

- Emission Level = Read Level + Factor
Margin value = Emission level – Limit value
- 5200 MHz: Fundamental Frequency
- *: Out of Restricted Band
- The emission levels of other frequencies were very low against the limit

EUT Test Condition		Measurement Detail	
Channel	Channel 48	Frequency Range	1 GHz ~ 40 GHz
Input Power	120 Vac, 60 Hz	Detector Function	Peak (PK) Average (AV)
Environmental Conditions	25 deg. C, 65 % RH	Tested By	Thomas Wei

Antenna Polarity & Test Distance: Horizontal at 3 m								
Frequency (MHz)	Emission Level (dBuV/m)	Read Level (dBuV)	Factor (dB/m)	Limit (dBuV/m)	Margin (dB)	Antenna Height (cm)	Table Angle (Degree)	Remark
5146.88	42.77	41.24	1.53	54	-11.23	134	226	Average
5146.88	51.21	49.68	1.53	74	-22.79	134	226	Peak
5240	103.28	101.9	1.38			134	226	Average
5240	110.64	109.26	1.38			134	226	Peak
5395.1	42.56	40.89	1.67	54	-11.44	134	226	Average
5395.1	53.01	51.34	1.67	74	-20.99	134	226	Peak
*10480	53.39	56.12	-2.73	68.2	-14.81	108	108	Peak
15720	53.2	54.63	-1.43	54	-0.8	108	108	Average
15720	62.48	63.91	-1.43	74	-11.52	108	108	Peak

Antenna Polarity & Test Distance: Vertical at 3 m								
Frequency (MHz)	Emission Level (dBuV/m)	Read Level (dBuV)	Factor (dB/m)	Limit (dBuV/m)	Margin (dB)	Antenna Height (cm)	Table Angle (Degree)	Remark
5149.94	49.91	48.38	1.53	54	-4.09	179	358	Average
5149.94	58.34	56.81	1.53	74	-15.66	179	358	Peak
5240	112.88	111.5	1.38			178	358	Average
5240	115.82	114.44	1.38			178	358	Peak
5351.1	47.34	45.88	1.46	54	-6.66	179	358	Average
5351.1	55.93	54.47	1.46	74	-18.07	179	358	Peak
*10480	57.45	60.18	-2.73	68.2	-10.75	204	114	Peak
15720	51.72	53.15	-1.43	54	-2.28	170	39	Average
15720	60.39	61.82	-1.43	74	-13.61	170	39	Peak

Remarks:

- Emission Level = Read Level + Factor
Margin value = Emission level – Limit value
- 5240 MHz: Fundamental Frequency
- *: Out of Restricted Band
- The emission levels of other frequencies were very low against the limit

EUT Test Condition		Measurement Detail	
Channel	Channel 149	Frequency Range	1 GHz ~ 40 GHz
Input Power	120 Vac, 60 Hz	Detector Function	Peak (PK) Average (AV)
Environmental Conditions	25 deg. C, 65 % RH	Tested By	Thomas Wei

<Spurious Emission>

Antenna Polarity & Test Distance: Horizontal at 3 m								
Frequency (MHz)	Emission Level (dBuV/m)	Read Level (dBuV)	Factor (dB/m)	Limit (dBuV/m)	Margin (dB)	Antenna Height (cm)	Table Angle (Degree)	Remark
5745	102.58	100.76	1.82			100	219	Average
5745	109.26	107.44	1.82			100	219	Peak
11490	48.2	50.4	-2.2	54	-5.8	100	238	Average
11490	55.89	58.09	-2.2	74	-18.11	100	238	Peak
Antenna Polarity & Test Distance: Vertical at 3 m								
Frequency (MHz)	Emission Level (dBuV/m)	Read Level (dBuV)	Factor (dB/m)	Limit (dBuV/m)	Margin (dB)	Antenna Height (cm)	Table Angle (Degree)	Remark
5745	110.27	108.45	1.82			136	3	Average
5745	115.01	113.19	1.82			136	3	Peak
11490	50.29	52.49	-2.2	54	-3.71	202	127	Average
11490	59.09	61.29	-2.2	74	-14.91	202	127	Peak

<Out of Band Emission (OOBE)>

Antenna Polarity & Test Distance: Horizontal at 3 m								
Frequency (MHz)	Emission Level (dBuV/m)	Read Level (dBuV)	Factor (dB/m)	Limit (dBuV/m)	Margin (dB)	Antenna Height (cm)	Table Angle (Degree)	Remark
5614.125	52.2	50.33	1.87	68.2	-16	100	219	Peak
5658.775	51.08	49.23	1.85	74.72	-23.64	100	219	Peak
5922.4	50.9	48.6	2.3	70.12	-19.22	100	219	Peak
5938.55	51.44	49.15	2.29	68.2	-16.76	100	219	Peak
Antenna Polarity & Test Distance: Vertical at 3 m								
Frequency (MHz)	Emission Level (dBuV/m)	Read Level (dBuV)	Factor (dB/m)	Limit (dBuV/m)	Margin (dB)	Antenna Height (cm)	Table Angle (Degree)	Remark
5621.25	57.7	55.8	1.9	68.2	-10.5	136	3	Peak
5652.6	56.77	54.86	1.91	70.13	-13.36	136	3	Peak
5919.075	54.09	51.78	2.31	72.57	-18.48	136	3	Peak
5934.275	54.95	52.65	2.3	68.2	-13.25	136	3	Peak

Remarks:

- Emission Level = Read Level + Factor
Margin value = Emission level – Limit value
- 5745 MHz: Fundamental Frequency
- *: Out of Restricted Band
- The emission levels of other frequencies were very low against the limit

EUT Test Condition		Measurement Detail	
Channel	Channel 157	Frequency Range	1 GHz ~ 40 GHz
Input Power	120 Vac, 60 Hz	Detector Function	Peak (PK) Average (AV)
Environmental Conditions	25 deg. C, 65 % RH	Tested By	Thomas Wei

<Spurious Emission>

Antenna Polarity & Test Distance: Horizontal at 3 m								
Frequency (MHz)	Emission Level (dBuV/m)	Read Level (dBuV)	Factor (dB/m)	Limit (dBuV/m)	Margin (dB)	Antenna Height (cm)	Table Angle (Degree)	Remark
5785	102.3	100.38	1.92			144	212	Average
5785	108.58	106.66	1.92			144	212	Peak
11570	47.36	49.56	-2.2	54	-6.64	100	238	Average
11570	55.81	58.01	-2.2	74	-18.19	100	238	Peak
Antenna Polarity & Test Distance: Vertical at 3 m								
Frequency (MHz)	Emission Level (dBuV/m)	Read Level (dBuV)	Factor (dB/m)	Limit (dBuV/m)	Margin (dB)	Antenna Height (cm)	Table Angle (Degree)	Remark
5785	108.79	106.87	1.92			146	335	Average
5785	115.88	113.96	1.92			146	335	Peak
11570	49.21	51.41	-2.2	54	-4.79	202	126	Average
11570	59.31	61.51	-2.2	74	-14.69	202	126	Peak

<Out of Band Emission (OOBE)>

Antenna Polarity & Test Distance: Horizontal at 3 m								
Frequency (MHz)	Emission Level (dBuV/m)	Read Level (dBuV)	Factor (dB/m)	Limit (dBuV/m)	Margin (dB)	Antenna Height (cm)	Table Angle (Degree)	Remark
5589.9	51.72	49.85	1.87	68.2	-16.48	144	212	Peak
5655.45	51.14	49.29	1.85	72.25	-21.11	144	212	Peak
5923.825	51.45	49.15	2.3	69.07	-17.62	144	212	Peak
6006.475	52.33	49.97	2.36	68.2	-15.87	144	212	Peak
Antenna Polarity & Test Distance: Vertical at 3 m								
Frequency (MHz)	Emission Level (dBuV/m)	Read Level (dBuV)	Factor (dB/m)	Limit (dBuV/m)	Margin (dB)	Antenna Height (cm)	Table Angle (Degree)	Remark
5576.6	57.65	55.79	1.86	68.2	-10.55	146	335	Peak
5654.025	55.71	53.86	1.85	71.19	-15.48	146	335	Peak
5921.925	52.76	50.46	2.3	70.47	-17.71	146	335	Peak
5938.075	54.67	52.37	2.3	68.2	-13.53	146	335	Peak

Remarks:

- Emission Level = Read Level + Factor
Margin value = Emission level – Limit value
- 5785 MHz: Fundamental Frequency
- *: Out of Restricted Band
- The emission levels of other frequencies were very low against the limit

EUT Test Condition		Measurement Detail	
Channel	Channel 165	Frequency Range	1 GHz ~ 40 GHz
Input Power	120 Vac, 60 Hz	Detector Function	Peak (PK) Average (AV)
Environmental Conditions	25 deg. C, 65 % RH	Tested By	Thomas Wei

<Spurious Emission>

Antenna Polarity & Test Distance: Horizontal at 3 m								
Frequency (MHz)	Emission Level (dBuV/m)	Read Level (dBuV)	Factor (dB/m)	Limit (dBuV/m)	Margin (dB)	Antenna Height (cm)	Table Angle (Degree)	Remark
5825	101.15	99.07	2.08			100	218	Average
5825	107.69	105.61	2.08			100	218	Peak
11650	48.44	50.83	-2.39	54	-5.56	216	205	Average
11650	57.92	60.31	-2.39	74	-16.08	216	205	Peak
Antenna Polarity & Test Distance: Vertical at 3 m								
Frequency (MHz)	Emission Level (dBuV/m)	Read Level (dBuV)	Factor (dB/m)	Limit (dBuV/m)	Margin (dB)	Antenna Height (cm)	Table Angle (Degree)	Remark
5825	108.08	106	2.08			126	350	Average
5825	114.62	112.54	2.08			126	350	Peak
11650	51.31	53.7	-2.39	54	-2.69	206	125	Average
11650	59.91	62.3	-2.39	74	-14.09	206	125	Peak

<Out of Band Emission (OOBE)>

Antenna Polarity & Test Distance: Horizontal at 3 m								
Frequency (MHz)	Emission Level (dBuV/m)	Read Level (dBuV)	Factor (dB/m)	Limit (dBuV/m)	Margin (dB)	Antenna Height (cm)	Table Angle (Degree)	Remark
5625.525	52.5	50.6	1.9	68.2	-15.7	100	218	Peak
5651.175	52.08	50.17	1.91	69.07	-16.99	100	218	Peak
5915.75	53.28	50.97	2.31	75.02	-21.74	100	218	Peak
5927.15	52.52	50.22	2.3	68.2	-15.68	100	218	Peak
Antenna Polarity & Test Distance: Vertical at 3 m								
Frequency (MHz)	Emission Level (dBuV/m)	Read Level (dBuV)	Factor (dB/m)	Limit (dBuV/m)	Margin (dB)	Antenna Height (cm)	Table Angle (Degree)	Remark
5637.4	57.12	55.24	1.88	68.2	-11.08	126	350	Peak
5651.65	57.69	55.78	1.91	69.43	-11.74	126	350	Peak
5923.35	58.97	56.67	2.3	69.42	-10.45	126	350	Peak
5935.7	57.18	54.88	2.3	68.2	-11.02	126	350	Peak

Remarks:

- Emission Level = Read Level + Factor
Margin value = Emission level – Limit value
- 5825 MHz: Fundamental Frequency
- *: Out of Restricted Band
- The emission levels of other frequencies were very low against the limit

802.11n (HT40)

EUT Test Condition		Measurement Detail	
Channel	Channel 38	Frequency Range	1 GHz ~ 40 GHz
Input Power	120 Vac, 60 Hz	Detector Function	Peak (PK) Average (AV)
Environmental Conditions	25 deg. C, 65 % RH	Tested By	Thomas Wei

Antenna Polarity & Test Distance: Horizontal at 3 m								
Frequency (MHz)	Emission Level (dBuV/m)	Read Level (dBuV)	Factor (dB/m)	Limit (dBuV/m)	Margin (dB)	Antenna Height (cm)	Table Angle (Degree)	Remark
5149.94	44.29	42.76	1.53	54	-9.71	138	225	Average
5149.94	52.97	51.44	1.53	74	-21.03	138	225	Peak
5190	88.57	87.04	1.53			138	225	Average
5190	95.27	93.74	1.53			138	225	Peak
5459.89	41.09	39.22	1.87	54	-12.91	138	225	Average
5459.89	50.08	48.21	1.87	74	-23.92	138	225	Peak
*10380	54.56	57.43	-2.87	68.2	-13.64	161	223	Peak
Antenna Polarity & Test Distance: Vertical at 3 m								
Frequency (MHz)	Emission Level (dBuV/m)	Read Level (dBuV)	Factor (dB/m)	Limit (dBuV/m)	Margin (dB)	Antenna Height (cm)	Table Angle (Degree)	Remark
5149.94	53.34	51.81	1.53	54	-0.66	180	357	Average
5149.94	62.36	60.83	1.53	74	-11.64	180	357	Peak
5190	98.96	97.43	1.53			180	357	Average
5190	106.74	105.21	1.53			180	357	Peak
5351.87	42.52	41.06	1.46	54	-11.48	180	357	Average
5351.87	51.68	50.22	1.46	74	-22.32	180	357	Peak
*10380	55.4	58.27	-2.87	68.2	-12.8	172	134	Peak

Remarks:

- Emission Level = Read Level + Factor
Margin value = Emission level – Limit value
- 5190 MHz: Fundamental Frequency
- *: Out of Restricted Band
- The emission levels of other frequencies were very low against the limit

EUT Test Condition		Measurement Detail	
Channel	Channel 46	Frequency Range	1 GHz ~ 40 GHz
Input Power	120 Vac, 60 Hz	Detector Function	Peak (PK) Average (AV)
Environmental Conditions	25 deg. C, 65 % RH	Tested By	Thomas Wei

Antenna Polarity & Test Distance: Horizontal at 3 m								
Frequency (MHz)	Emission Level (dBuV/m)	Read Level (dBuV)	Factor (dB/m)	Limit (dBuV/m)	Margin (dB)	Antenna Height (cm)	Table Angle (Degree)	Remark
5149.76	46.11	44.58	1.53	54	-7.89	131	154	Average
5149.76	54.08	52.55	1.53	74	-19.92	131	154	Peak
5230	98.55	97.17	1.38			131	154	Average
5230	104.52	103.14	1.38			131	154	Peak
5350	42.61	41.15	1.46	54	-11.39	131	154	Average
5350	51.58	50.12	1.46	74	-22.42	131	154	Peak
*10460	54.57	57.36	-2.79	68.2	-13.63	157	266	Peak
Antenna Polarity & Test Distance: Vertical at 3 m								
Frequency (MHz)	Emission Level (dBuV/m)	Read Level (dBuV)	Factor (dB/m)	Limit (dBuV/m)	Margin (dB)	Antenna Height (cm)	Table Angle (Degree)	Remark
5149.4	53.01	51.48	1.53	54	-0.99	180	358	Average
5149.4	61.29	59.76	1.53	74	-12.71	180	358	Peak
5230	107.39	106.01	1.38			180	358	Average
5230	113.08	111.7	1.38			180	358	Peak
5350.55	46.23	44.77	1.46	54	-7.77	180	358	Average
5350.55	54.52	53.06	1.46	74	-19.48	180	358	Peak
*10460	55	57.79	-2.79	68.2	-13.2	136	221	Peak

Remarks:

- Emission Level = Read Level + Factor
Margin value = Emission level – Limit value
- 5230 MHz: Fundamental Frequency
- *: Out of Restricted Band
- The emission levels of other frequencies were very low against the limit

EUT Test Condition		Measurement Detail	
Channel	Channel 151	Frequency Range	1 GHz ~ 40 GHz
Input Power	120 Vac, 60 Hz	Detector Function	Peak (PK) Average (AV)
Environmental Conditions	25 deg. C, 65 % RH	Tested By	Thomas Wei

<Spurious Emission>

Antenna Polarity & Test Distance: Horizontal at 3 m								
Frequency (MHz)	Emission Level (dBuV/m)	Read Level (dBuV)	Factor (dB/m)	Limit (dBuV/m)	Margin (dB)	Antenna Height (cm)	Table Angle (Degree)	Remark
5755	100.12	98.22	1.9			101	219	Average
5755	106.04	104.14	1.9			101	219	Peak
11510	47.34	49.55	-2.21	54	-6.66	203	199	Average
11510	57.5	59.71	-2.21	74	-16.5	203	199	Peak
Antenna Polarity & Test Distance: Vertical at 3 m								
Frequency (MHz)	Emission Level (dBuV/m)	Read Level (dBuV)	Factor (dB/m)	Limit (dBuV/m)	Margin (dB)	Antenna Height (cm)	Table Angle (Degree)	Remark
5755	107.51	105.61	1.9			143	2	Average
5755	113.18	111.28	1.9			143	2	Peak
11510	49.29	51.5	-2.21	54	-4.71	207	127	Average
11510	58.39	60.6	-2.21	74	-15.61	207	127	Peak

<Out of Band Emission (OOBE)>

Antenna Polarity & Test Distance: Horizontal at 3 m								
Frequency (MHz)	Emission Level (dBuV/m)	Read Level (dBuV)	Factor (dB/m)	Limit (dBuV/m)	Margin (dB)	Antenna Height (cm)	Table Angle (Degree)	Remark
5646.425	56.23	54.35	1.88	68.2	-11.97	101	219	Peak
5658.775	61.94	60.09	1.85	74.72	-12.78	101	219	Peak
5916.225	50.95	48.64	2.31	74.67	-23.72	101	219	Peak
5933.325	52.25	49.95	2.3	68.2	-15.95	101	219	Peak
Antenna Polarity & Test Distance: Vertical at 3 m								
Frequency (MHz)	Emission Level (dBuV/m)	Read Level (dBuV)	Factor (dB/m)	Limit (dBuV/m)	Margin (dB)	Antenna Height (cm)	Table Angle (Degree)	Remark
5646.425	64.7	62.82	1.88	68.2	-3.5	143	2	Peak
5659.725	69.78	67.93	1.85	75.42	-5.64	143	2	Peak
5922.4	57.96	55.66	2.3	70.12	-12.16	143	2	Peak
5935.225	57.48	55.18	2.3	68.2	-10.72	143	2	Peak

Remarks:

- Emission Level = Read Level + Factor
Margin value = Emission level – Limit value
- 5755 MHz: Fundamental Frequency
- *: Out of Restricted Band
- The emission levels of other frequencies were very low against the limit

EUT Test Condition		Measurement Detail	
Channel	Channel 159	Frequency Range	1 GHz ~ 40 GHz
Input Power	120 Vac, 60 Hz	Detector Function	Peak (PK) Average (AV)
Environmental Conditions	25 deg. C, 65 % RH	Tested By	Thomas Wei

<Spurious Emission>

Antenna Polarity & Test Distance: Horizontal at 3 m								
Frequency (MHz)	Emission Level (dBuV/m)	Read Level (dBuV)	Factor (dB/m)	Limit (dBuV/m)	Margin (dB)	Antenna Height (cm)	Table Angle (Degree)	Remark
5795	99.19	97.19	2			100	219	Average
5795	107.02	105.02	2			100	219	Peak
11590	47.13	49.32	-2.19	54	-6.87	196	210	Average
11590	57.38	59.57	-2.19	74	-16.62	196	210	Peak
Antenna Polarity & Test Distance: Vertical at 3 m								
Frequency (MHz)	Emission Level (dBuV/m)	Read Level (dBuV)	Factor (dB/m)	Limit (dBuV/m)	Margin (dB)	Antenna Height (cm)	Table Angle (Degree)	Remark
5795	106.98	104.98	2			139	2	Average
5795	112.54	110.54	2			139	2	Peak
11590	48.7	50.89	-2.19	54	-5.3	205	124	Average
11590	58.57	60.76	-2.19	74	-15.43	205	124	Peak

<Out of Band Emission (OOBE)>

Antenna Polarity & Test Distance: Horizontal at 3 m								
Frequency (MHz)	Emission Level (dBuV/m)	Read Level (dBuV)	Factor (dB/m)	Limit (dBuV/m)	Margin (dB)	Antenna Height (cm)	Table Angle (Degree)	Remark
5555.225	51.92	50.12	1.8	68.2	-16.28	100	219	Peak
5659.725	52.1	50.25	1.85	75.42	-23.32	100	219	Peak
5915.75	52.05	49.74	2.31	75.02	-22.97	100	219	Peak
5939.975	51.32	49.03	2.29	68.2	-16.88	100	219	Peak
Antenna Polarity & Test Distance: Vertical at 3 m								
Frequency (MHz)	Emission Level (dBuV/m)	Read Level (dBuV)	Factor (dB/m)	Limit (dBuV/m)	Margin (dB)	Antenna Height (cm)	Table Angle (Degree)	Remark
5632.65	58.3	56.42	1.88	68.2	-9.9	139	2	Peak
5659.725	58.75	56.9	1.85	75.42	-16.67	139	2	Peak
5919.55	62.91	60.6	2.31	72.22	-9.31	139	2	Peak
5927.625	61.17	58.87	2.3	68.2	-7.03	139	2	Peak

Remarks:

- Emission Level = Read Level + Factor
Margin value = Emission level – Limit value
- 5795 MHz: Fundamental Frequency
- *: Out of Restricted Band
- The emission levels of other frequencies were very low against the limit

802.11ac (VHT80)

EUT Test Condition		Measurement Detail	
Channel	Channel 42	Frequency Range	1 GHz ~ 40 GHz
Input Power	120 Vac, 60 Hz	Detector Function	Peak (PK) Average (AV)
Environmental Conditions	25 deg. C, 65 % RH	Tested By	Thomas Wei

Antenna Polarity & Test Distance: Horizontal at 3 m

Frequency (MHz)	Emission Level (dBuV/m)	Read Level (dBuV)	Factor (dB/m)	Limit (dBuV/m)	Margin (dB)	Antenna Height (cm)	Table Angle (Degree)	Remark
5149.58	44.32	42.79	1.53	54	-9.68	100	214	Average
5149.58	52.26	50.73	1.53	74	-21.74	100	214	Peak
5210	83.12	81.68	1.44			100	214	Average
5210	90.32	88.88	1.44			100	214	Peak
5452.19	41.43	39.56	1.87	54	-12.57	100	214	Average
5452.19	50.31	48.44	1.87	74	-23.69	100	214	Peak
*10420	54.66	57.51	-2.85	68.2	-13.54	162	188	Peak

Antenna Polarity & Test Distance: Vertical at 3 m

Frequency (MHz)	Emission Level (dBuV/m)	Read Level (dBuV)	Factor (dB/m)	Limit (dBuV/m)	Margin (dB)	Antenna Height (cm)	Table Angle (Degree)	Remark
5149.76	52.66	51.13	1.53	54	-1.34	171	1	Average
5149.76	62.35	60.82	1.53	74	-11.65	171	1	Peak
5210	93.34	91.9	1.44			171	1	Average
5210	99.77	98.33	1.44			171	1	Peak
5370.68	42.71	41.18	1.53	54	-11.29	171	1	Average
5370.68	51.61	50.08	1.53	74	-22.39	171	1	Peak
*10420	55.29	58.14	-2.85	68.2	-12.91	152	194	Peak

Remarks:

- Emission Level = Read Level + Factor
Margin value = Emission level – Limit value
- 5210 MHz: Fundamental Frequency
- *: Out of Restricted Band
- The emission levels of other frequencies were very low against the limit

EUT Test Condition		Measurement Detail	
Channel	Channel 155	Frequency Range	1 GHz ~ 40 GHz
Input Power	120 Vac, 60 Hz	Detector Function	Peak (PK) Average (AV)
Environmental Conditions	25 deg. C, 65 % RH	Tested By	Thomas Wei

<Spurious Emission>

Antenna Polarity & Test Distance: Horizontal at 3 m								
Frequency (MHz)	Emission Level (dBuV/m)	Read Level (dBuV)	Factor (dB/m)	Limit (dBuV/m)	Margin (dB)	Antenna Height (cm)	Table Angle (Degree)	Remark
5775	97.89	95.93	1.96			100	219	Average
5775	104.24	102.28	1.96			100	219	Peak
11550	47.01	49.21	-2.2	54	-6.99	190	211	Average
11550	57.51	59.71	-2.2	74	-16.49	190	211	Peak
Antenna Polarity & Test Distance: Vertical at 3 m								
Frequency (MHz)	Emission Level (dBuV/m)	Read Level (dBuV)	Factor (dB/m)	Limit (dBuV/m)	Margin (dB)	Antenna Height (cm)	Table Angle (Degree)	Remark
5775	105.16	103.2	1.96			140	2	Average
5775	110.42	108.46	1.96			140	2	Peak
11550	47.64	49.84	-2.2	54	-6.36	209	126	Average
11550	58.24	60.44	-2.2	74	-15.76	209	126	Peak

<Out of Band Emission (OOBE)>

Antenna Polarity & Test Distance: Horizontal at 3 m								
Frequency (MHz)	Emission Level (dBuV/m)	Read Level (dBuV)	Factor (dB/m)	Limit (dBuV/m)	Margin (dB)	Antenna Height (cm)	Table Angle (Degree)	Remark
5646.425	57.64	55.76	1.88	68.2	-10.56	100	219	Peak
5650.7	60.66	58.75	1.91	68.72	-8.06	100	219	Peak
5916.225	52.44	50.13	2.31	74.67	-22.23	100	219	Peak
5933.8	53.04	50.74	2.3	68.2	-15.16	100	219	Peak
Antenna Polarity & Test Distance: Vertical at 3 m								
Frequency (MHz)	Emission Level (dBuV/m)	Read Level (dBuV)	Factor (dB/m)	Limit (dBuV/m)	Margin (dB)	Antenna Height (cm)	Table Angle (Degree)	Remark
5646.425	67.63	65.75	1.88	68.2	-0.57	140	2	Peak
5654.025	67.34	65.49	1.85	71.19	-3.85	140	2	Peak
5915.75	61.53	59.22	2.31	75.02	-13.49	140	2	Peak
5928.1	59.37	57.07	2.3	68.2	-8.83	140	2	Peak

Remarks:

- Emission Level = Read Level + Factor
Margin value = Emission level – Limit value
- 5775 MHz: Fundamental Frequency
- *: Out of Restricted Band
- The emission levels of other frequencies were very low against the limit

9 kHz ~ 30 MHz Data:

The amplitude of spurious emissions attenuated more than 20 dB below the permissible value is not required to be report.

30 MHz ~ 1 GHz Worst-Case Data:

802.11a

EUT Test Condition		Measurement Detail	
Channel	Channel 48	Frequency Range	30 MHz ~ 1 GHz
Input Power	120 Vac, 60 Hz	Detector Function	Peak (PK) Quasi-peak (QP)
Environmental Conditions	25 deg. C, 65 % RH	Tested By	Thomas Wei

Horizontal

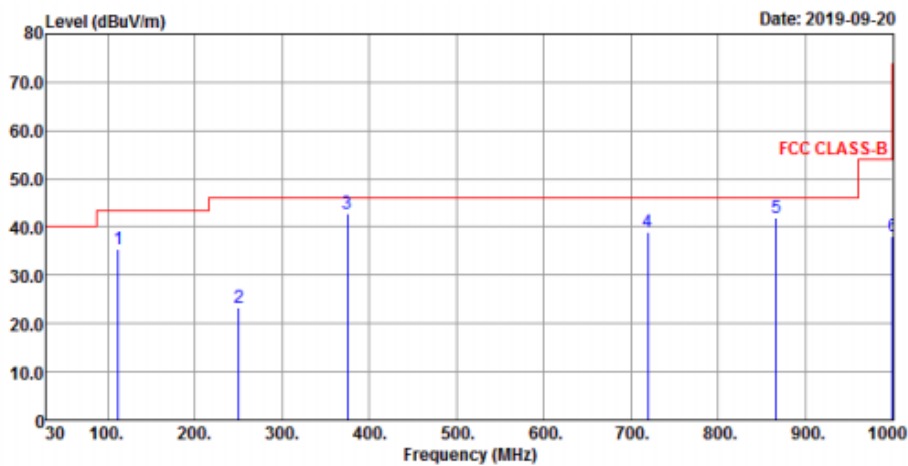

Vertical

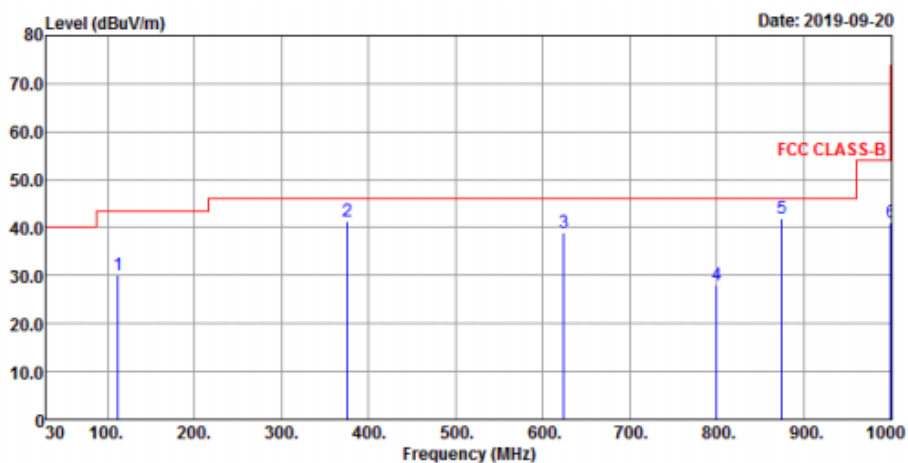

Antenna Polarity & Test Distance: Horizontal at 3 m								
Frequency (MHz)	Emission Level (dBuV/m)	Read Level (dBuV)	Factor (dB/m)	Limit (dBuV/m)	Margin (dB)	Antenna Height (cm)	Table Angle (Degree)	Remark
112.45	35.55	55.58	-20.03	43.5	-7.95	158	23	Peak
250.19	23.43	41.03	-17.6	46	-22.57	177	145	Peak
375	42.67	57.63	-14.96	46	-3.33	106	291	QP
719.67	38.94	45.94	-7	46	-7.06	186	231	Peak
866.14	41.92	46.18	-4.26	46	-4.08	149	222	Peak
1000	38.14	40.78	-2.64	54	-15.86	144	188	Peak
Antenna Polarity & Test Distance: Vertical at 3 m								
Frequency (MHz)	Emission Level (dBuV/m)	Read Level (dBuV)	Factor (dB/m)	Limit (dBuV/m)	Margin (dB)	Antenna Height (cm)	Table Angle (Degree)	Remark
112.45	30.01	50.04	-20.03	43.5	-13.49	123	154	Peak
375.32	41.44	56.4	-14.96	46	-4.56	109	188	QP
624.61	38.82	47.3	-8.48	46	-7.18	145	211	Peak
800.18	28.04	33.31	-5.27	46	-17.96	107	267	Peak
874.87	41.84	46.24	-4.4	46	-4.16	105	225	Peak
1000	41.07	43.71	-2.64	54	-12.93	101	76	Peak

Remarks:

- Emission Level = Read Level + Factor
Margin value = Emission level – Limit value
- The emission levels of other frequencies were very low against the limit

4.2 Conducted Emission Measurement

4.2.1 Limits of Conducted Emission Measurement

Frequency (MHz)	Conducted Limit (dBuV)	
	Quasi-Peak	Average
0.15 - 0.5	66 - 56	56 - 46
0.50 - 5.0	56	46
5.0 - 30.0	60	50

- Note: 1. The lower limit shall apply at the transition frequencies.
 2. The limit decreases in line with the logarithm of the frequency in the range of 0.15 to 0.50 MHz.

4.2.2 Test Instruments

Description & Manufacturer	Model No.	Serial No.	Date of Calibration	Due Date of Calibration
Test Receiver ROHDE & SCHWARZ	ESCI	100613	Dec. 10, 2018	Dec. 09, 2019
RF signal cable Woken	5D-FB	Cable-cond1-01	Sep. 05, 2019	Sep. 04, 2020
LISN ROHDE & SCHWARZ (EUT)	ENV216	101826	Feb. 21, 2019	Feb. 20, 2020
LISN ROHDE & SCHWARZ (Peripheral)	ESH3-Z5	100311	Aug. 22, 2019	Aug. 21, 2020
Software ADT	BV ADT_Cond_ V7.3.7.4	NA	NA	NA

- Note: 1. The calibration interval of the above test instruments is 12 months and the calibrations are traceable to NML/ROC and NIST/USA.
 2. The test was performed in HwaYa Shielded Room 1.
 3. The VCCI Site Registration No. is C-12040.

4.2.3 Test Procedures

- a. The EUT was placed 0.4 meters from the conducting wall of the shielded room with EUT being connected to the power mains through a line impedance stabilization network (LISN). Other support units were connected to the power mains through another LISN. The two LISNs provide 50 ohm/ 50uH of coupling impedance for the measuring instrument.
- b. Both lines of the power mains connected to the EUT were checked for maximum conducted interference.
- c. The frequency range from 150 kHz to 30 MHz was searched. Emission levels under (Limit -20 dB) was not recorded.

Note: All modes of operation were investigated and the worst-case emissions are reported.

4.2.4 Deviation from Test Standard

No deviation.

4.2.5 Test Setup

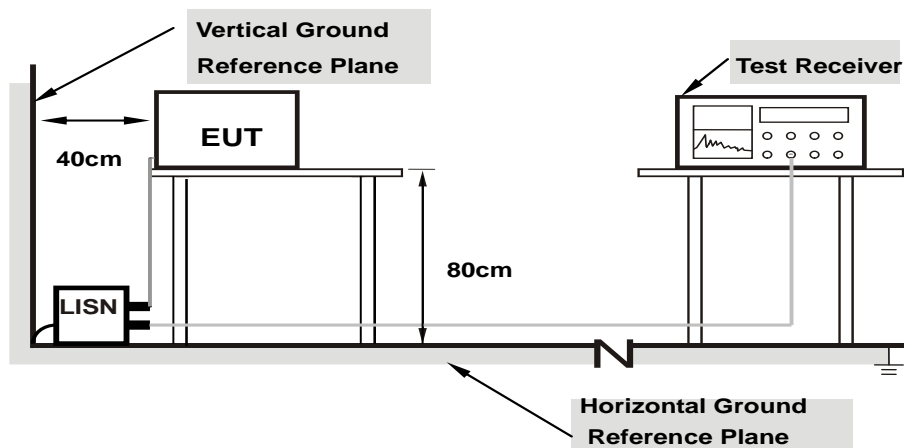

- Note:**
1. Support units were connected to second LISN.
 2. Both of LISNs (AMN) are 80 cm from EUT and at least 80 from other units and other metal planes

For the actual test configuration, please refer to the attached file (Test Setup Photo).

4.2.6 EUT Operating Conditions

- a. Placed the EUT on a testing table.
- b. Use the software to control the EUT under transmission condition continuously at specific channel frequency.

4.2.7 Test Results

Frequency Range	150kHz ~ 30MHz	Detector Function & Resolution Bandwidth	Quasi-Peak (QP) / Average (AV), 9kHz
Input Power	120Vac, 60Hz	Environmental Conditions	25°C, 65%RH
Tested by	Thomas Wei	Test Date	2019/9/20

Phase Of Power : Line (L)										
No	Frequency (MHz)	Correction Factor (dB)	Reading Value (dBuV)		Emission Level (dBuV)		Limit (dBuV)		Margin (dB)	
			Q.P.	AV.	Q.P.	AV.	Q.P.	AV.	Q.P.	AV.
1	0.15391	9.71	33.06	19.10	42.77	28.81	65.79	55.79	-23.02	-26.98
2	0.18519	9.76	28.11	15.90	37.87	25.66	64.25	54.25	-26.38	-28.59
3	0.24384	9.81	27.51	18.35	37.32	28.16	61.96	51.96	-24.64	-23.80
4	0.39635	9.90	28.08	20.10	37.98	30.00	57.93	47.93	-19.95	-17.93
5	3.84886	10.18	17.82	9.31	28.00	19.49	56.00	46.00	-28.00	-26.51
6	10.21434	10.32	15.35	6.35	25.67	16.67	60.00	50.00	-34.33	-33.33

Remarks:

1. Q.P. and AV. are abbreviations of quasi-peak and average individually.
2. The emission levels of other frequencies were very low against the limit.
3. Margin value = Emission level – Limit value
4. Correction factor = Insertion loss + Cable loss
5. Emission Level = Correction Factor + Reading Value

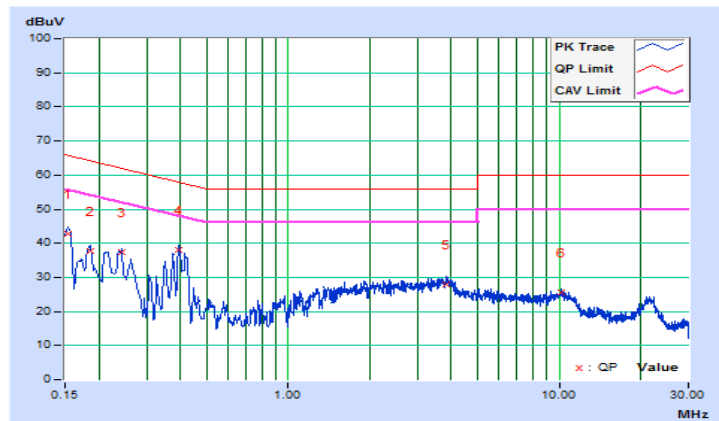

Frequency Range	150kHz ~ 30MHz	Detector Function & Resolution Bandwidth	Quasi-Peak (QP) / Average (AV), 9kHz
Input Power	120Vac, 60Hz	Environmental Conditions	25°C, 65%RH
Tested by	Thomas Wei	Test Date	2019/9/20

Phase Of Power : Neutral (N)										
No	Frequency (MHz)	Correction Factor (dB)	Reading Value (dBuV)		Emission Level (dBuV)		Limit (dBuV)		Margin (dB)	
			Q.P.	AV.	Q.P.	AV.	Q.P.	AV.	Q.P.	AV.
1	0.15802	9.70	30.67	20.02	40.37	29.72	65.57	55.57	-25.20	-25.85
2	0.17737	9.75	28.65	16.45	38.40	26.20	64.61	54.61	-26.21	-28.41
3	0.24384	9.81	22.66	15.60	32.47	25.41	61.96	51.96	-29.49	-26.55
4	0.39242	9.86	25.02	14.81	34.88	24.67	58.01	48.01	-23.13	-23.34
5	3.54779	10.11	17.79	8.86	27.90	18.97	56.00	46.00	-28.10	-27.03
6	9.06871	10.23	15.56	7.51	25.79	17.74	60.00	50.00	-34.21	-32.26

Remarks:

1. Q.P. and AV. are abbreviations of quasi-peak and average individually.
2. The emission levels of other frequencies were very low against the limit.
3. Margin value = Emission level – Limit value
4. Correction factor = Insertion loss + Cable loss
5. Emission Level = Correction Factor + Reading Value

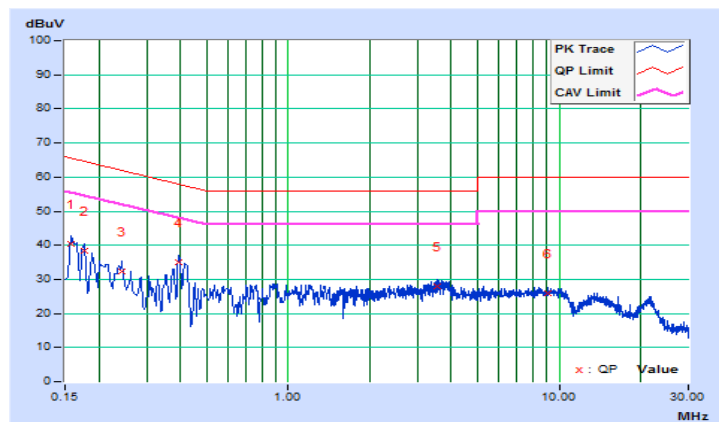

4.3 Transmit Power Measurement

4.3.1 Limits of Transmit Power Measurement

Operation Band	EUT Category		Limit
U-NII-1		Outdoor Access Point	1 Watt (30 dBm) (Max. e.i.r.p \leq 125 mW (21 dBm) at any elevation angle above 30 degrees as measured from the horizon)
		Fixed point-to-point Access Point	1 Watt (30 dBm)
	√	Indoor Access Point	1 Watt (30 dBm)
		Mobile and Portable client device	250 mW (24 dBm)
U-NII-2A			250 mW (24 dBm) or 11 dBm + 10 log B*
U-NII-2C			250 mW (24 dBm) or 11 dBm + 10 log B*
U-NII-3	√		1 Watt (30 dBm)

*B is the 26 dB emission bandwidth in megahertz

Per KDB 662911 Method of conducted output power measurement on IEEE 802.11 devices,

Array Gain = 0 dB (i.e., no array gain) for $N_{ANT} \leq 4$;

Array Gain = 0 dB (i.e., no array gain) for channel widths ≥ 40 MHz for any N_{ANT} ;

Array Gain = $5 \log(N_{ANT}/N_{SS})$ dB or 3 dB, whichever is less for 20 MHz channel widths with $N_{ANT} \geq 5$.

For power measurements on all other devices: Array Gain = $10 \log(N_{ANT}/N_{SS})$ dB.

4.3.2 Test Setup

<Power Output Measurement>

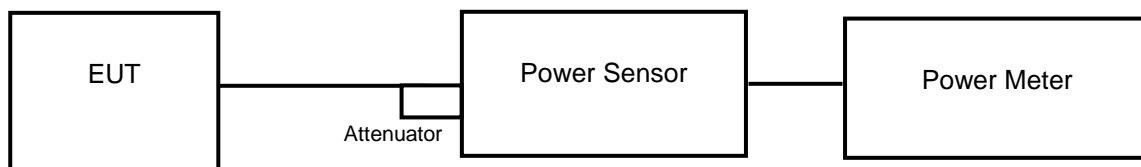

or

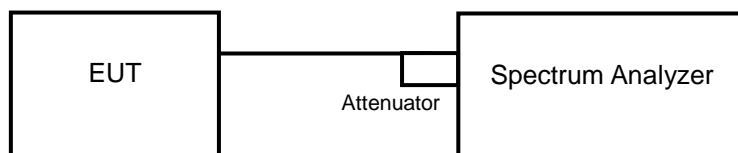

<26 dB Bandwidth>

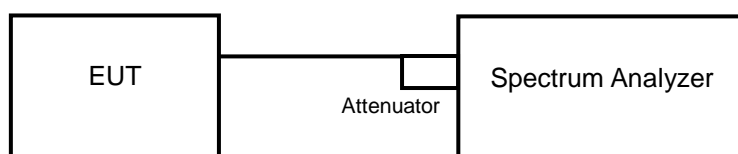

4.3.3 Test Instruments

Refer to section 4.1.2 to get information of above instrument.

4.3.4 Test Procedure

Average Power Measurement

<802.11a, 802.11n (HT20), 802.11n (HT40)>

Method PM is used to perform output power measurement, trigger and gating function of wide band power meter is enabled to measure max output power of TX on burst. Duty factor is not added to measured value.

<802.11ac (VHT80)>

- a. Set span to encompass the entire 26 dB EBW (or, alternatively, the entire 99 % occupied bandwidth) of the signal.
- b. Set sweep trigger to "free run".
- c. Set RBW = 1 MHz.
- d. Set VBW \geq 3 MHz
- e. Number of points in sweep \geq 2 Span / RBW.
- f. Sweep time \leq (number of points in sweep) * T
- g. Using emission bandwidth to determine the frequency span for integration the channel bandwidth.
- h. Detector = RMS.
- i. Trace mode = max hold.
- j. Allow max hold to run for at least 60 seconds, or longer as needed to allow the trace to stabilize.

26 dB Bandwidth

- a. Set RBW = approximately 1 % of the emission bandwidth.
- b. Set the VBW > RBW.
- c. Detector = Peak.
- d. Trace mode = max hold.
- e. Measure the maximum width of the emission that is 26 dB down from the peak of the emission. Compare this with the RBW setting of the analyzer. Readjust RBW and repeat measurement as needed until the RBW/EBW ratio is approximately 1 %.

4.3.5 Deviation from Test Standard

No deviation.

4.3.6 EUT Operating Conditions

The software provided by client to enable the EUT under transmission condition continuously at lowest, middle and highest channel frequencies individually.

4.3.7 Test Results

Power Output:

802.11a

Channel	Frequency (MHz)	Maximum Conducted Power (dBm)		Total Power (mW)	Total Power (dBm)	Power Limit (dBm)	Pass / Fail
		Chain 0	Chain 1				
36	5180	17.89	19.74	155.707	21.92	30	Pass
40	5200	22.45	24.45	454.404	26.57	30	Pass
48	5240	23.64	24.95	543.814	27.35	30	Pass
149	5745	25.15	26.22	746.135	28.73	30	Pass
157	5785	24.93	25.67	680.15	28.33	30	Pass
165	5825	24.80	25.37	646.345	28.10	30	Pass

802.11n (HT20)

Channel	Frequency (MHz)	Maximum Conducted Power (dBm)		Total Power (mW)	Total Power (dBm)	Power Limit (dBm)	Pass / Fail
		Chain 0	Chain 1				
36	5180	17.89	19.74	155.707	21.92	30	Pass
40	5200	22.45	24.45	454.404	26.57	30	Pass
48	5240	22.96	24.95	510.305	27.08	30	Pass
149	5745	25.23	26.18	748.38	28.74	30	Pass
157	5785	25.11	25.77	701.912	28.46	30	Pass
165	5825	24.27	25.56	627.05	27.97	30	Pass

802.11n (HT40)

Channel	Frequency (MHz)	Maximum Conducted Power (dBm)		Total Power (mW)	Total Power (dBm)	Power Limit (dBm)	Pass / Fail
		Chain 0	Chain 1				
38	5190	12.59	14.56	46.731	16.70	30	Pass
46	5230	21.19	23.23	341.9	25.34	30	Pass
151	5755	24.90	25.75	684.867	28.36	30	Pass
159	5795	24.52	25.09	605.988	27.82	30	Pass

802.11ac (VHT80)

Channel	Frequency (MHz)	Maximum Conducted Power (dBm)		Total Power (mW)	Total Power (dBm)	Power Limit (dBm)	Pass / Fail
		Chain 0	Chain 1				
42	5210	8.73	10.74	19.322	12.86	30	Pass
155	5775	21.42	22.82	330.102	25.19	30	Pass

26 dB Bandwidth:
802.11a

Channel	Frequency (MHz)	26 dBc Bandwidth (MHz)	
		Chain 0	Chain 1
36	5180	23.08	21.70
40	5200	28.47	28.47
48	5240	35.21	36.75

802.11n (HT20)

Channel	Frequency (MHz)	26 dBc Bandwidth (MHz)	
		Chain 0	Chain 1
36	5180	22.97	23.78
40	5200	26.19	28.18
48	5240	37.71	37.48

802.11n (HT40)

Channel	Frequency (MHz)	26 dBc Bandwidth (MHz)	
		Chain 0	Chain 1
38	5190	46.59	45.81
46	5230	50.54	50.73

802.11ac (VHT80)

Channel	Frequency (MHz)	26 dBc Bandwidth (MHz)	
		Chain 0	Chain 1
42	5210	87.18	88.00

Spectrum Plot of Worst Value

802.11a

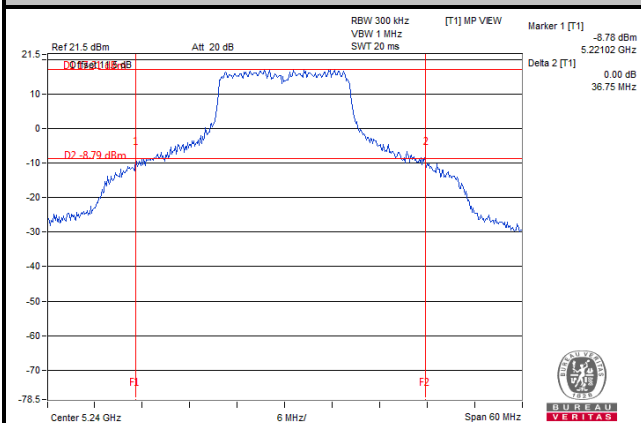

802.11n (HT20)

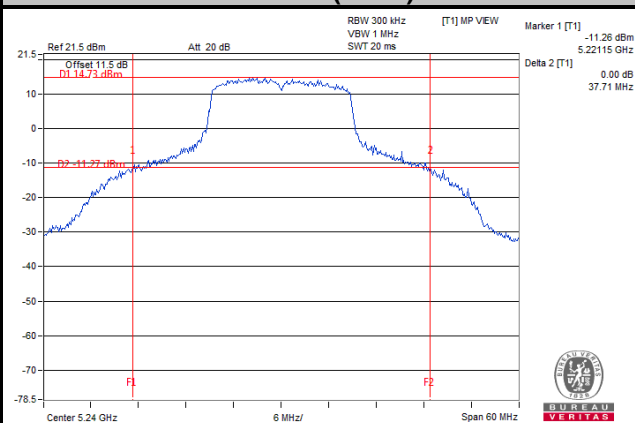

802.11n (HT40)

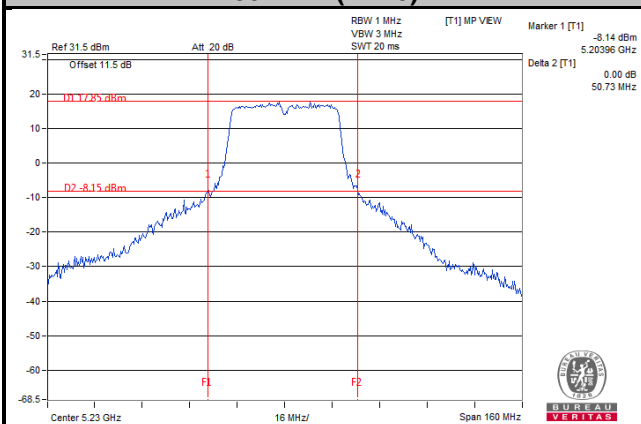

802.11ac (VHT80)

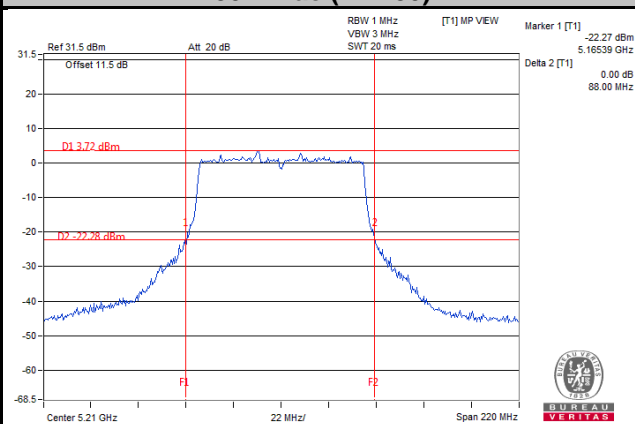

4.4 Occupied Bandwidth Measurement

4.4.1 Test Setup



4.4.2 Test Instruments

Refer to section 4.1.2 to get information of above instrument.

4.4.3 Test Procedure

The transmitter output was connected to the spectrum analyzer through an attenuator. The bandwidth of the fundamental frequency was measured by spectrum analyzer with resolution bandwidth in the range of 1 % to 5 % of the anticipated emission bandwidth, and a video bandwidth at least 3x the resolution bandwidth and set the detector to SAMPLE. The width of a frequency band such that, below the lower and above the upper frequency limits, the mean powers emitted are each equal to a specified percentage 0.5 % of the total mean power of a given emission.

4.4.4 Test Results

802.11a

Channel	Channel Frequency (MHz)	Occupied Bandwidth (MHz)	
		Chain 0	Chain 1
36	5180	16.68	16.68
40	5200	17.16	16.92
48	5240	19.08	18.00
149	5745	26.04	28.56
157	5785	27.84	24.12
165	5825	26.16	22.44

802.11n (HT20)

Channel	Channel Frequency (MHz)	Occupied Bandwidth (MHz)	
		Chain 0	Chain 1
36	5180	18.00	17.88
40	5200	18.00	18.12
48	5240	19.44	18.72
149	5745	27.96	29.04
157	5785	28.08	24.84
165	5825	27.12	23.16

802.11n (HT40)

Channel	Channel Frequency (MHz)	Occupied Bandwidth (MHz)	
		Chain 0	Chain 1
38	5190	36.84	36.84
46	5230	37.20	37.32
151	5755	40.32	40.56
159	5795	39.84	38.40

802.11ac (VHT80)

Channel	Channel Frequency (MHz)	Occupied Bandwidth (MHz)	
		Chain 0	Chain 1
42	5210	76.08	76.08
155	5775	76.08	76.32

Spectrum Plot of Worst Value

802.11a

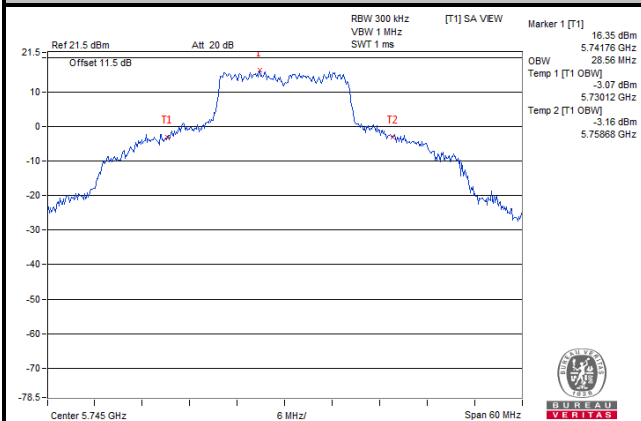

802.11n (HT20)

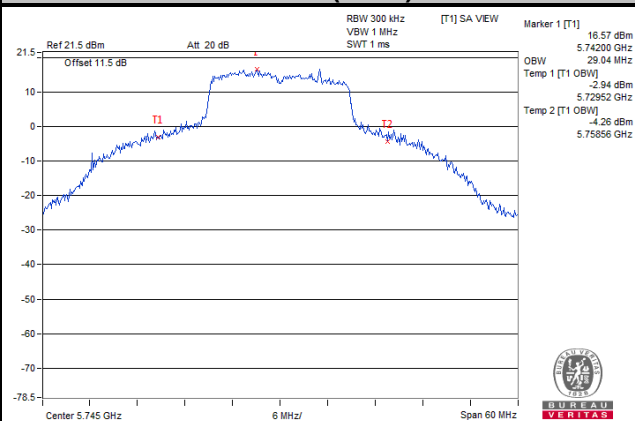

802.11n (HT40)

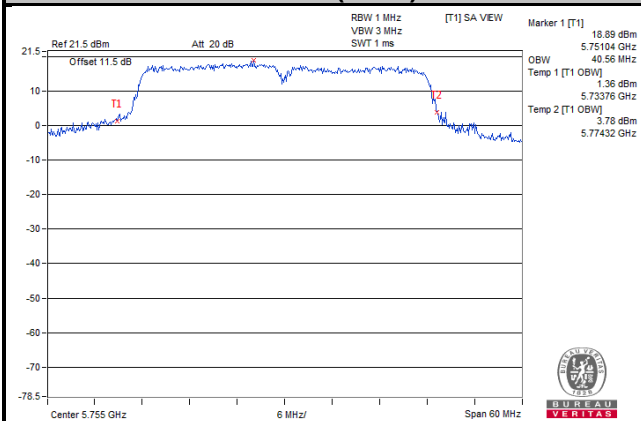

802.11ac (VHT80)

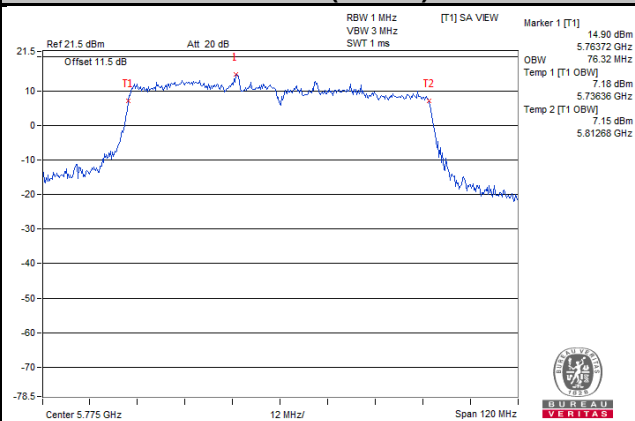

802.11a_Ch 48 (5240 MHz)

Chain 0

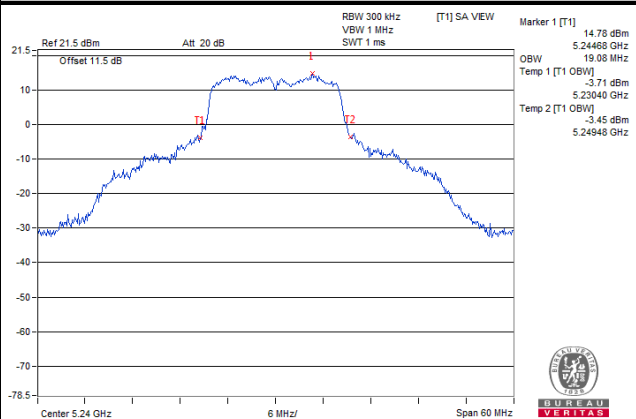

Chain 1

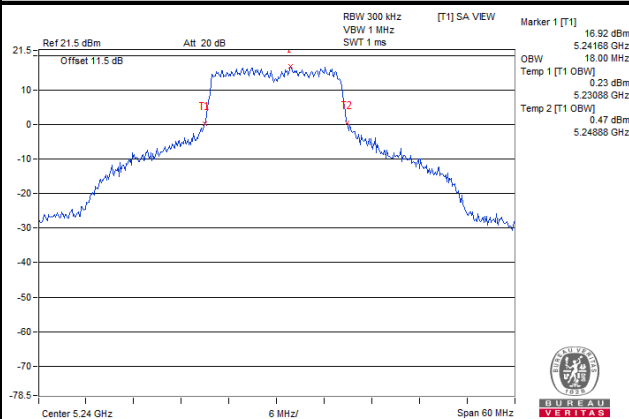

802.11n (HT20)_Ch 48 (5240 MHz)

Chain 0

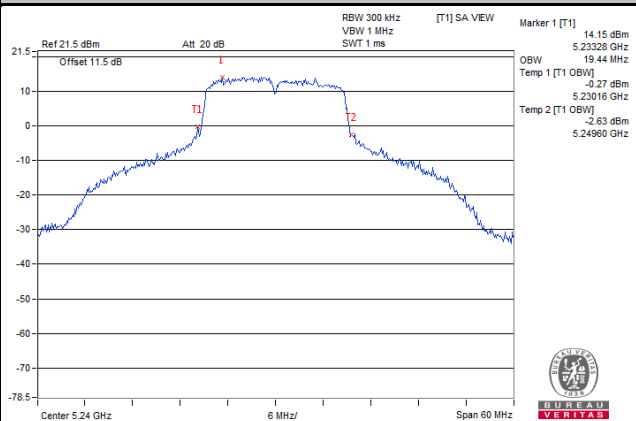

Chain 1

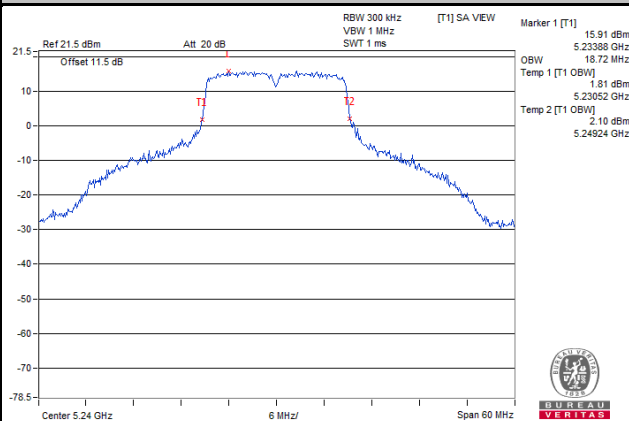

802.11n (HT40)_Ch 46 (5230 MHz)

Chain 0

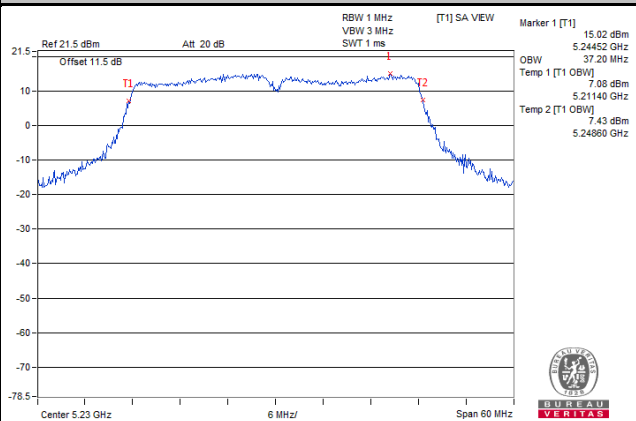

Chain 1

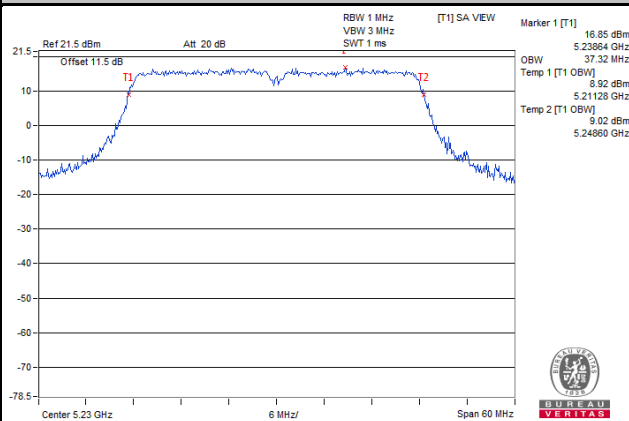

802.11ac (VHT80) Ch 42 (5210 MHz)

Chain 0

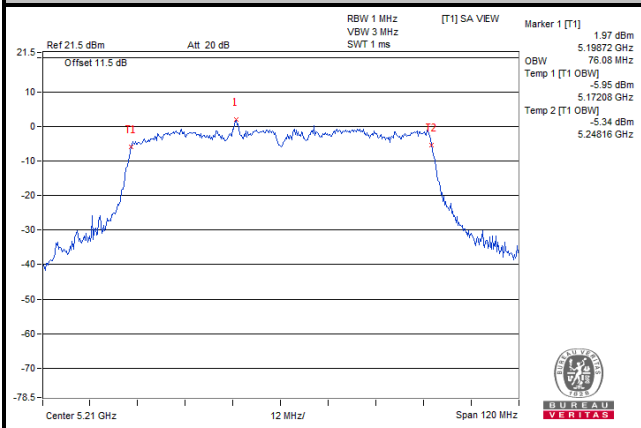

Chain 1

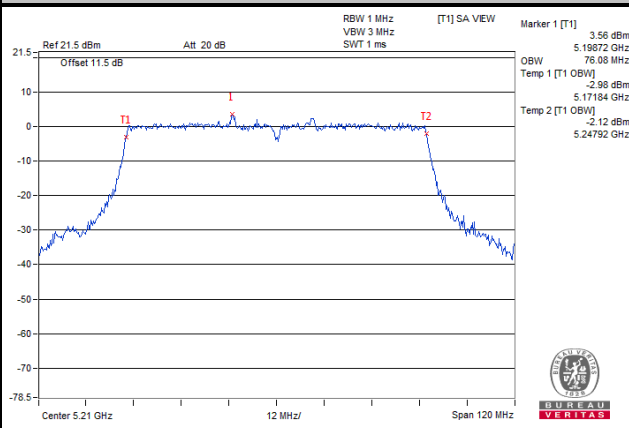

4.5 Peak Power Spectral Density Measurement

4.5.1 Limits of Peak Power Spectral Density Measurement

Operation Band	EUT Category		Limit
U-NII-1		Outdoor Access Point	17 dBm/MHz
		Fixed point-to-point Access Point	
	√	Indoor Access Point	
		Mobile and Portable client device	11 dBm/MHz
U-NII-2A			11 dBm/MHz
U-NII-2C			11 dBm/MHz
U-NII-3		√	30 dBm/500 kHz

4.5.2 Test Setup

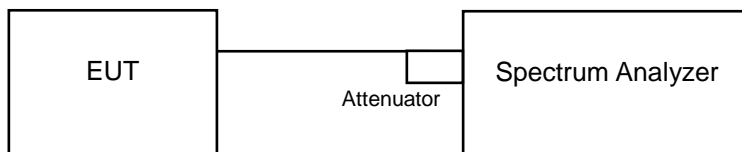

4.5.3 Test Instruments

Refer to section 4.1.3 to get information of above instrument.

4.5.4 Test Procedures

For U-NII-1 band:

Using method SA-2

1. Set span to encompass the entire emission bandwidth (EBW) of the signal.
2. Set RBW = 1 MHz, Set VBW \geq 3 RBW, Detector = RMS
3. Sweep time = auto, trigger set to "free run".
4. Trace average at least 100 traces in power averaging mode.
5. Record the max value and add 10 log (1/duty cycle)

※ For U-NII-3:

1. Set span to encompass the entire emission bandwidth (EBW) of the signal.
2. Set RBW = 300 kHz, Set VBW \geq 1 RBW, Detector = RMS
3. Use the peak marker function to determine the maximum power level in any 300 kHz band segment within the fundamental EBW.
4. Scale the observed power level to an equivalent value in 500 kHz by adjusting (reducing) the measured power by a bandwidth correction factor (BWCF) where $BWCF = 10\log(500 \text{ kHz} / 300 \text{ kHz})$.
5. Sweep time = auto, trigger set to "free run".
6. Trace average at least 100 traces in power averaging mode.
7. Record the max value and add 10 log (1/duty cycle)

4.5.5 Deviation from Test Standard

No deviation.

4.5.6 EUT Operating Conditions

The software provided by client to enable the EUT under transmission condition continuously at lowest, middle and highest channel frequencies individually.

4.5.7 Test Results

For U-NII-1 Band

802.11a

Channel	Frequency (MHz)	PSD (dBm/MHz)		Duty Factor (dB)	Total PSD with Duty Factor (dBm/MHz)	Max. Limit (dBm/MHz)	Pass / Fail
		Chain 0	Chain 1				
36	5180	5.12	6.20	0.16	8.86	16.13	Pass
40	5200	10.14	10.77	0.16	13.64	16.13	Pass
48	5240	10.37	11.48	0.16	14.13	16.13	Pass

Note:

- Method E) 2) a) of power density measurement of KDB 662911 is using for calculating total power density. Total power density is summing entire spectra across corresponding frequency bins on the various outputs by computer.
- Directional gain = $3.86 \text{ dBi} + 10\log(2) = 6.87 \text{ dBi} > 6 \text{ dBi}$, so the power density limit shall be reduced to $17 - (6.87 - 6) = 16.13 \text{ dBm}$.
- Refer to section 3.3 for duty cycle spectrum plot.

802.11n (HT20)

Channel	Frequency (MHz)	PSD (dBm/MHz)		Duty Factor (dB)	Total PSD with Duty Factor (dBm/MHz)	Max. Limit (dBm/MHz)	Pass / Fail
		Chain 0	Chain 1				
36	5180	5.05	6.24	0.17	8.87	16.13	Pass
40	5200	9.24	10.33	0.17	13.00	16.13	Pass
48	5240	9.90	11.77	0.17	14.12	16.13	Pass

Note:

- Method E) 2) a) of power density measurement of KDB 662911 is using for calculating total power density. Total power density is summing entire spectra across corresponding frequency bins on the various outputs by computer.
- Directional gain = $3.86 \text{ dBi} + 10\log(2) = 6.87 \text{ dBi} > 6 \text{ dBi}$, so the power density limit shall be reduced to $17 - (6.87 - 6) = 16.13 \text{ dBm}$.
- Refer to section 3.3 for duty cycle spectrum plot.

802.11n (HT40)

Channel	Frequency (MHz)	PSD (dBm/MHz)		Duty Factor (dB)	Total PSD with Duty Factor (dBm/MHz)	Max. Limit (dBm/MHz)	Pass / Fail
		Chain 0	Chain 1				
38	5190	-3.45	-2.38	0.31	0.44	16.13	Pass
46	5230	4.77	6.32	0.31	8.93	16.13	Pass

Note:

- Method E) 2) a) of power density measurement of KDB 662911 is using for calculating total power density. Total power density is summing entire spectra across corresponding frequency bins on the various outputs by computer.
- Directional gain = $3.86 \text{ dBi} + 10\log(2) = 6.87 \text{ dBi} > 6 \text{ dBi}$, so the power density limit shall be reduced to $17-(6.87-6) = 16.13 \text{ dBm}$.
- Refer to section 3.3 for duty cycle spectrum plot.

802.11ac (VHT80)

Channel	Frequency (MHz)	PSD (dBm/MHz)		Duty Factor (dB)	Total PSD with Duty Factor (dBm/MHz)	Max. Limit (dBm/MHz)	Pass / Fail
		Chain 0	Chain 1				
42	5210	-11.16	-9.56	0.68	-6.60	16.13	Pass

Note:

- Method E) 2) a) of power density measurement of KDB 662911 is using for calculating total power density. Total power density is summing entire spectra across corresponding frequency bins on the various outputs by computer.
- Directional gain = $3.86 \text{ dBi} + 10\log(2) = 6.87 \text{ dBi} > 6 \text{ dBi}$, so the power density limit shall be reduced to $17-(6.87-6) = 16.13 \text{ dBm}$.
- Refer to section 3.3 for duty cycle spectrum plot.

Spectrum Plot of Worst Value

802.11a

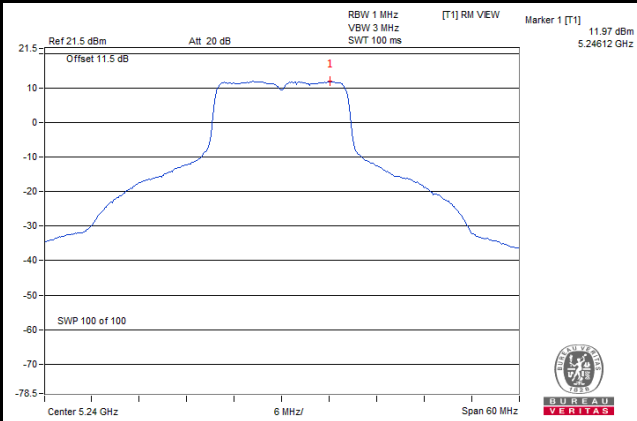

802.11n (HT20)

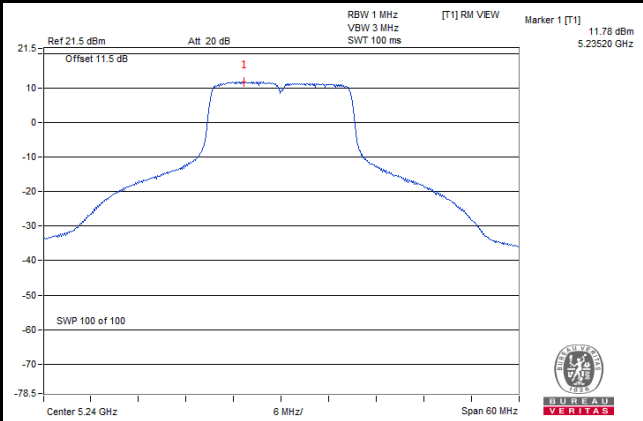

802.11n (HT40)

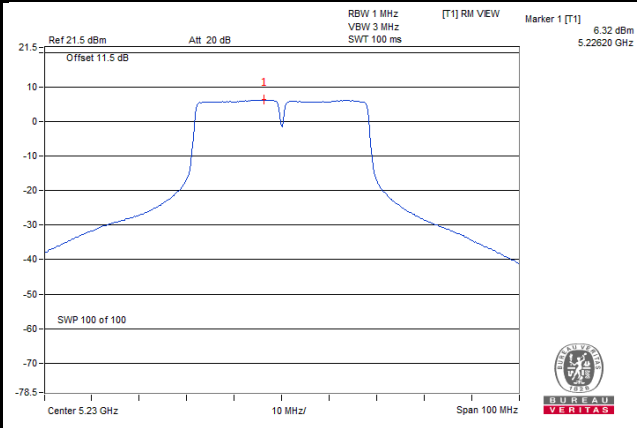

802.11ac (VHT80)

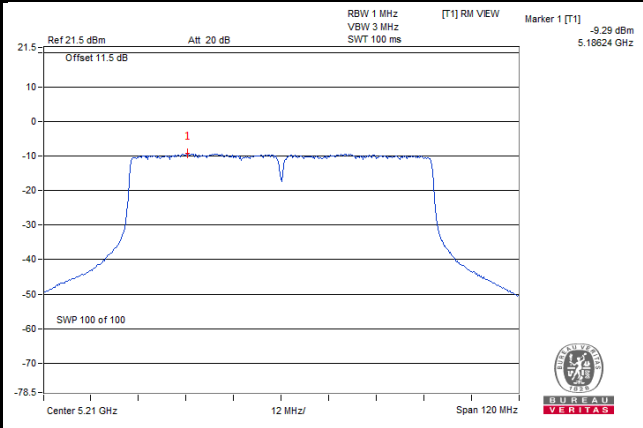

For U-NII-3 Band

802.11a

TX Chain	Channel	Frequency (MHz)	PSD w/o Duty Factor		10 log (N=2) dB	Duty Factor (dB)	Total PSD with Duty Factor (dBm/500 kHz)	Limit (dBm/500 kHz)	Pass / Fail
			(dBm/300 kHz)	(dBm/500 kHz)					
0	149	5745	3.00	5.22	3.01	0.16	8.39	28.82	Pass
	157	5785	2.75	4.97	3.01	0.16	8.14	28.82	Pass
	165	5825	2.12	4.34	3.01	0.16	7.51	28.82	Pass
1	149	5745	3.26	5.48	3.01	0.16	8.65	28.82	Pass
	157	5785	2.18	4.40	3.01	0.16	7.57	28.82	Pass
	165	5825	2.06	4.28	3.01	0.16	7.45	28.82	Pass

Note:

1. Method E) 2) c) of power density measurement of KDB 662911 is using for calculating total power density.
2. Directional gain = 4.17 dBi + 10log(2) = 7.18 dBi > 6 dBi , so the power density limit shall be reduced to 30-(7.18-6) = 28.82 dBm.
3. Refer to section 3.3 for duty cycle spectrum plot.

802.11n (HT20)

TX Chain	Channel	Frequency (MHz)	PSD		10 log (N=2) dB	Duty Factor (dB)	Total PSD with Duty Factor (dBm/500 kHz)	Limit (dBm/500 kHz)	Pass / Fail
			(dBm/300 kHz)	(dBm/500 kHz)					
0	149	5745	2.52	4.74	3.01	0.17	7.92	28.82	Pass
	157	5785	2.26	4.48	3.01	0.17	7.66	28.82	Pass
	165	5825	2.03	4.25	3.01	0.17	7.43	28.82	Pass
1	149	5745	3.26	5.48	3.01	0.17	8.66	28.82	Pass
	157	5785	0.85	3.07	3.01	0.17	6.25	28.82	Pass
	165	5825	1.75	3.97	3.01	0.17	7.15	28.82	Pass

Note:

1. Method E) 2) c) of power density measurement of KDB 662911 is using for calculating total power density.
2. Directional gain = 4.17 dBi + 10log(2) = 7.18 dBi > 6 dBi , so the power density limit shall be reduced to 30-(7.18-6) = 28.82 dBm.
3. Refer to section 3.3 for duty cycle spectrum plot.

802.11n (HT40)

TX Chain	Channel	Frequency (MHz)	PSD		10 log (N=2) dB	Duty Factor (dB)	Total PSD with Duty Factor (dBm/500 kHz)	Limit (dBm/500 kHz)	Pass / Fail
			(dBm/300 kHz)	(dBm/500 kHz)					
0	151	5755	-1.13	1.09	3.01	0.31	4.41	28.82	Pass
	159	5795	-1.54	0.68	3.01	0.31	4.00	28.82	Pass
1	151	5755	-0.65	1.57	3.01	0.31	4.89	28.82	Pass
	159	5795	-1.57	0.65	3.01	0.31	3.97	28.82	Pass

Note:

1. Method E) 2) c) of power density measurement of KDB 662911 is using for calculating total power density.
2. Directional gain = 4.17 dBi + 10log(2) = 7.18 dBi > 6 dBi , so the power density limit shall be reduced to 30-(7.18-6) = 28.82 dBm.
3. Refer to section 3.3 for duty cycle spectrum plot.

802.11ac (VHT80)

TX Chain	Channel	Frequency (MHz)	PSD		10 log (N=2) dB	Duty Factor (dB)	Total PSD with Duty Factor (dBm/500 kHz)	Limit (dBm/500 kHz)	Pass / Fail
			(dBm/300 kHz)	(dBm/500 kHz)					
0	155	5775	-7.52	-5.30	3.01	0.68	-1.61	28.82	Pass
1	155	5775	-6.33	-4.11	3.01	0.68	-0.42	28.82	Pass

Note:

1. Method E) 2) c) of power density measurement of KDB 662911 is using for calculating total power density.
2. Directional gain = 4.17 dBi + 10log(2) = 7.18 dBi > 6 dBi , so the power density limit shall be reduced to 30-(7.18-6) = 28.82 dBm.
3. Refer to section 3.3 for duty cycle spectrum plot.

Spectrum Plot of Worst Value

802.11a

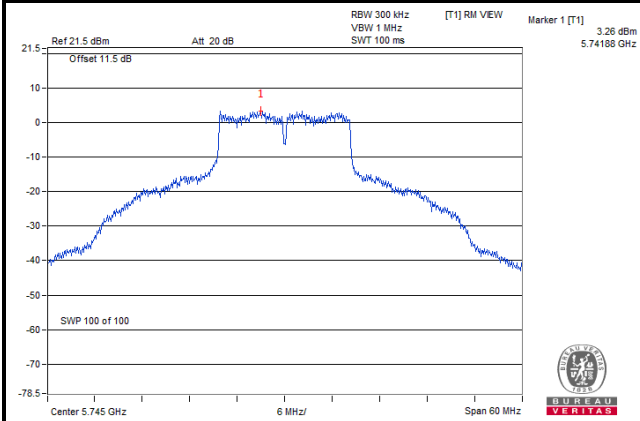

802.11n (HT20)

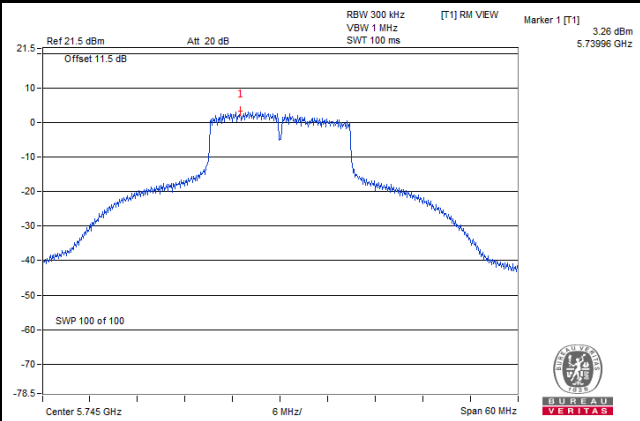

802.11n (HT40)

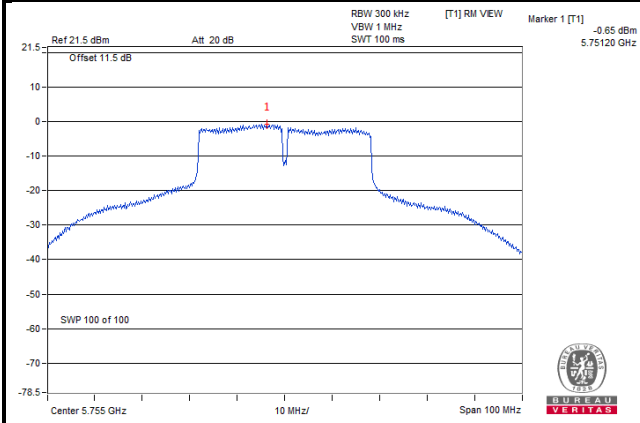

802.11ac (VHT80)

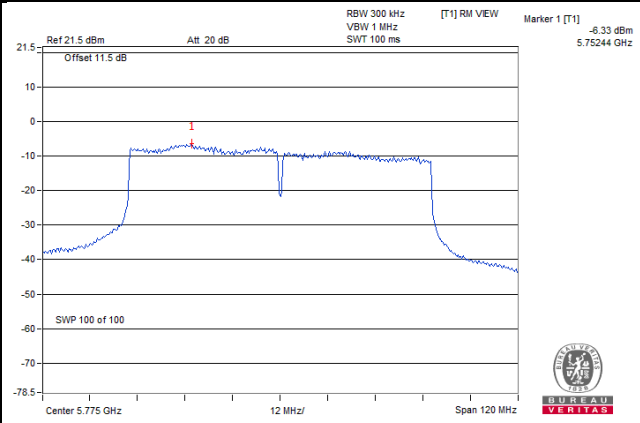

4.6 Frequency Stability

4.6.1 Limit of Frequency Stability Measurement

The frequency of the carrier signal shall be maintained within band of operation.

4.6.2 Test Setup

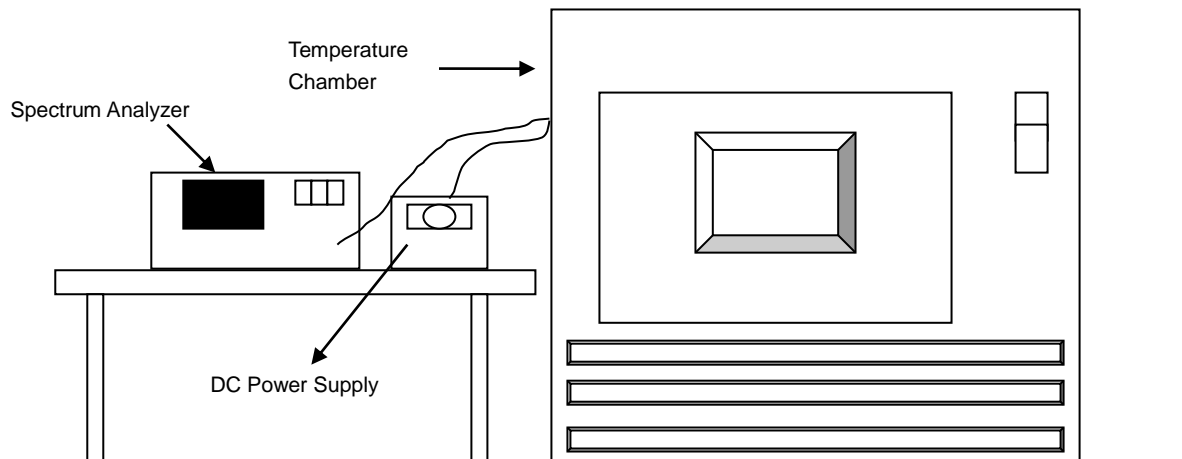

4.6.3 Test Instruments

Refer to section 4.1.3 to get information of above instrument.

4.6.4 Test Procedure

- The EUT was placed inside the environmental test chamber and powered by nominal DC voltage.
- Turn the EUT on and couple its output to a spectrum analyzer.
- Turn the EUT off and set the chamber to the highest temperature specified.
- Allow sufficient time (approximately 30 min) for the temperature of the chamber to stabilize, turn the EUT on and measure the operating frequency after 2, 5, and 10 Minutes.
- Repeat step (d) with the temperature chamber set to the next desired temperature until measurements down to the lowest specified temperature have been completed.
- The test chamber was allowed to stabilize at +20 degree C for a minimum of 30 Minutes. The supply voltage was then adjusted on the EUT from 85% to 115% and the frequency record.

4.6.5 Deviation from Test Standard

No deviation.

4.6.6 EUT Operating Condition

Set the EUT transmit at un-modulation mode to test frequency stability.

4.6.7 Test Results

Frequency Stability Versus Temp.									
Operating Frequency: 5180 MHz									
Temp. (°C)	Power Supply (Vac)	0 Minute		2 Minute		5 Minute		10 Minute	
		Measured Frequency (MHz)	Result	Measured Frequency (MHz)	Result	Measured Frequency (MHz)	Result	Measured Frequency (MHz)	Result
50	120	5180.019	PASS	5180.0149	PASS	5180.0161	PASS	5180.0186	PASS
40	120	5180.0191	PASS	5180.0172	PASS	5180.0191	PASS	5180.0189	PASS
30	120	5180.0051	PASS	5180.0043	PASS	5180.003	PASS	5180.0036	PASS
20	120	5179.9873	PASS	5179.9874	PASS	5179.9842	PASS	5179.9841	PASS
10	120	5180.0072	PASS	5180.007	PASS	5180.0096	PASS	5180.0096	PASS
0	120	5180.0229	PASS	5180.021	PASS	5180.0252	PASS	5180.0221	PASS
-10	120	5180.0056	PASS	5180.0071	PASS	5180.0061	PASS	5180.0098	PASS
-20	120	5180.0198	PASS	5180.0196	PASS	5180.0209	PASS	5180.0225	PASS

Frequency Stability Versus Voltage									
Operating Frequency: 5180 MHz									
Temp. (°C)	Power Supply (Vac)	0 Minute		2 Minute		5 Minute		10 Minute	
		Measured Frequency (MHz)	Result	Measured Frequency (MHz)	Result	Measured Frequency (MHz)	Result	Measured Frequency (MHz)	Result
20	138	5179.9873	PASS	5179.9878	PASS	5179.9837	PASS	5179.9849	PASS
	120	5179.9873	PASS	5179.9874	PASS	5179.9842	PASS	5179.9841	PASS
	102	5179.9875	PASS	5179.9878	PASS	5179.9847	PASS	5179.9834	PASS

4.7 6 dB Bandwidth Measurement

4.7.1 Limits of 6 dB Bandwidth Measurement

The minimum of 6 dB Bandwidth Measurement is 0.5 MHz.

4.7.2 Test Setup

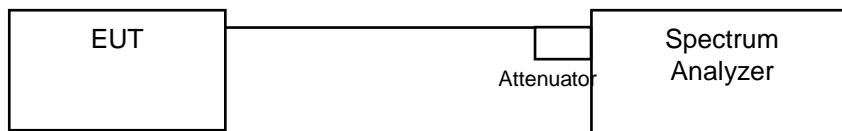

4.7.3 Test Instruments

Refer to section 4.1.3 to get information of above instrument.

4.7.4 Test Procedure

MEASUREMENT PROCEDURE REF

- Set resolution bandwidth (RBW) = 100 kHz
- Set the video bandwidth (VBW) $\geq 3 \times$ RBW, Detector = Peak.
- Trace mode = max hold.
- Sweep = auto couple.
- Measure the maximum width of the emission that is constrained by the frequencies associated with the two amplitude points (upper and lower) that are attenuated by 6 dB relative to the maximum level measured in the fundamental emission

4.7.5 Deviation from Test Standard

No deviation.

4.7.6 EUT Operating Condition

The software provided by client to enable the EUT under transmission condition continuously at lowest, middle and highest channel frequencies individually.

4.7.7 Test Results

802.11a

Channel	Frequency (MHz)	6 dB Bandwidth (MHz)		Minimum Limit (MHz)	Pass / Fail
		Chain 0	Chain 1		
149	5745	16.12	16.45	0.5	Pass
157	5785	16.42	16.43	0.5	Pass
165	5825	16.37	16.39	0.5	Pass

802.11n (HT20)

Channel	Frequency (MHz)	6 dB Bandwidth (MHz)		Minimum Limit (MHz)	Pass / Fail
		Chain 0	Chain 1		
149	5745	17.64	16.36	0.5	Pass
157	5785	15.42	16.98	0.5	Pass
165	5825	16.43	17.63	0.5	Pass

802.11n (HT40)

Channel	Frequency (MHz)	6 dB Bandwidth (MHz)		Minimum Limit (MHz)	Pass / Fail
		Chain 0	Chain 1		
151	5755	36.08	35.78	0.5	Pass
159	5795	35.83	36.41	0.5	Pass

802.11ac (VHT80)

Channel	Frequency (MHz)	6 dB Bandwidth (MHz)		Minimum Limit (MHz)	Pass / Fail
		Chain 0	Chain 1		
155	5775	75.55	73.29	0.5	Pass

Spectrum Plot of Worst Value

802.11a

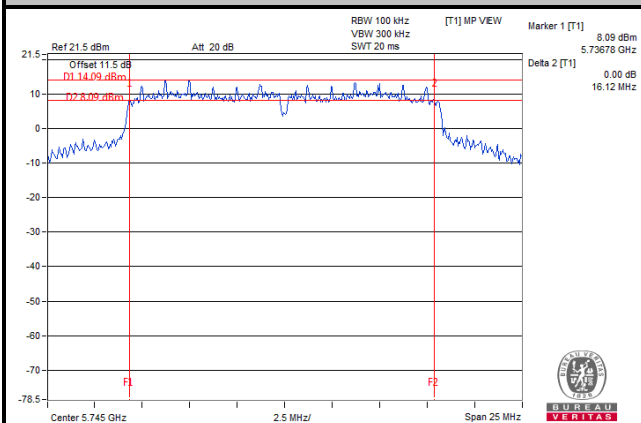

802.11n (HT20)

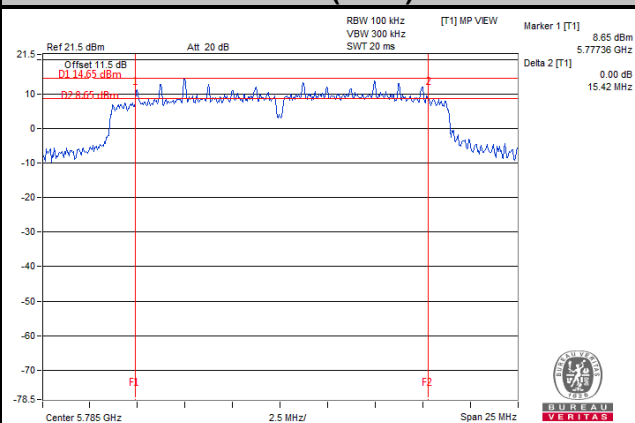

802.11n (HT40)

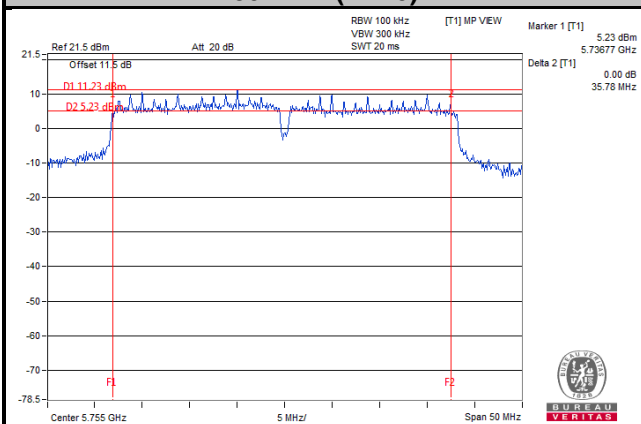

802.11ac (VHT80)

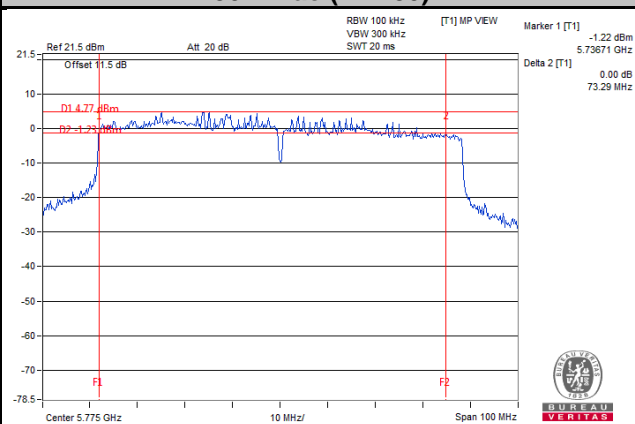

5 Pictures of Test Arrangements

Please refer to the attached file (Test Setup Photo).

Annex A- Radiated Out of Band Emission (OOBE) Measurement (For U-NII-3 band)

802.11a

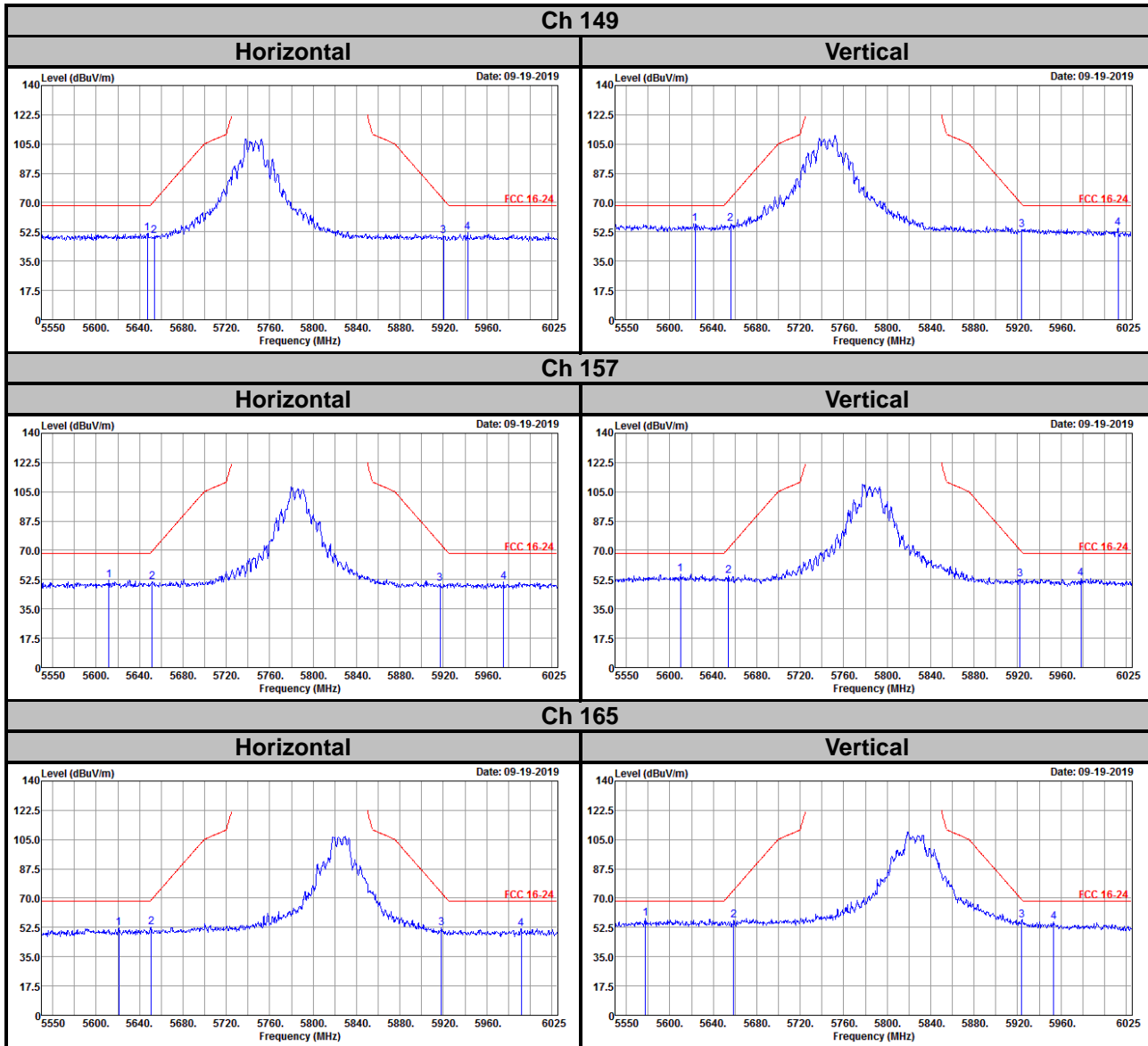

802.11n (HT20)

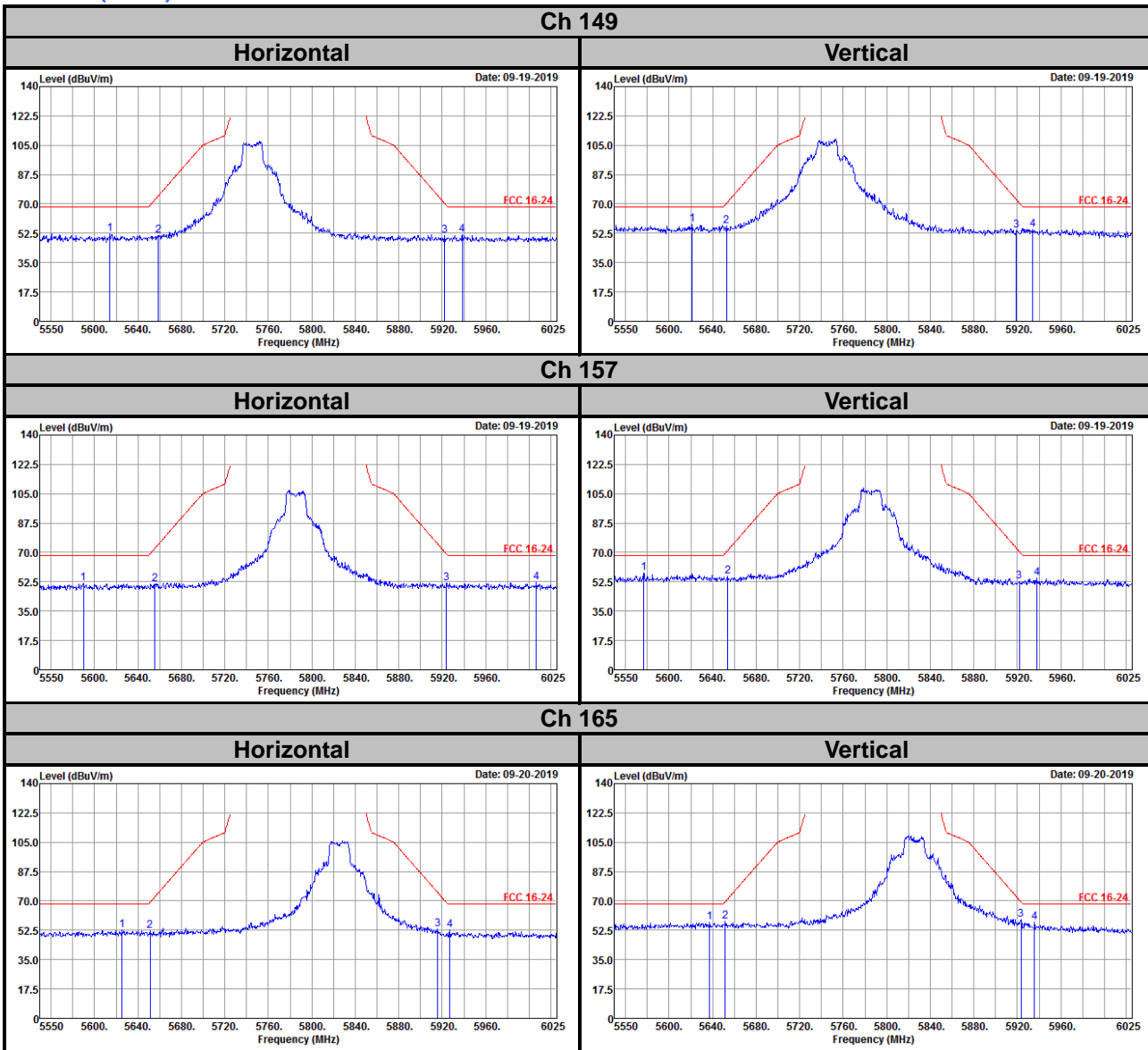

802.11n (HT40)

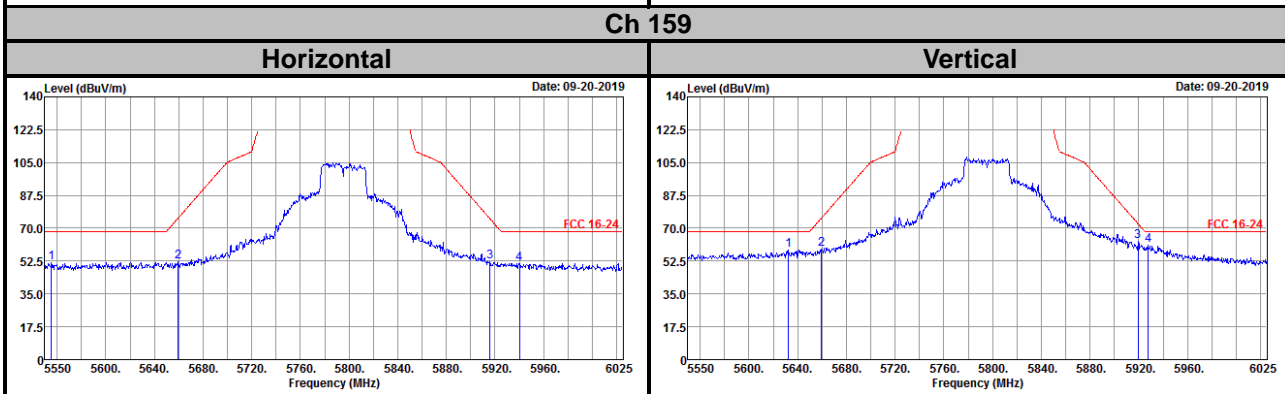
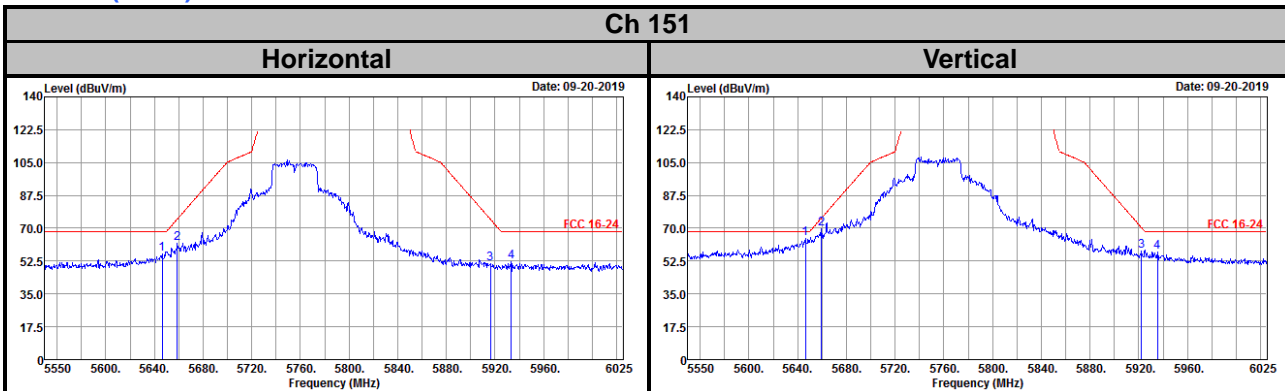

802.11ac (VHT80)

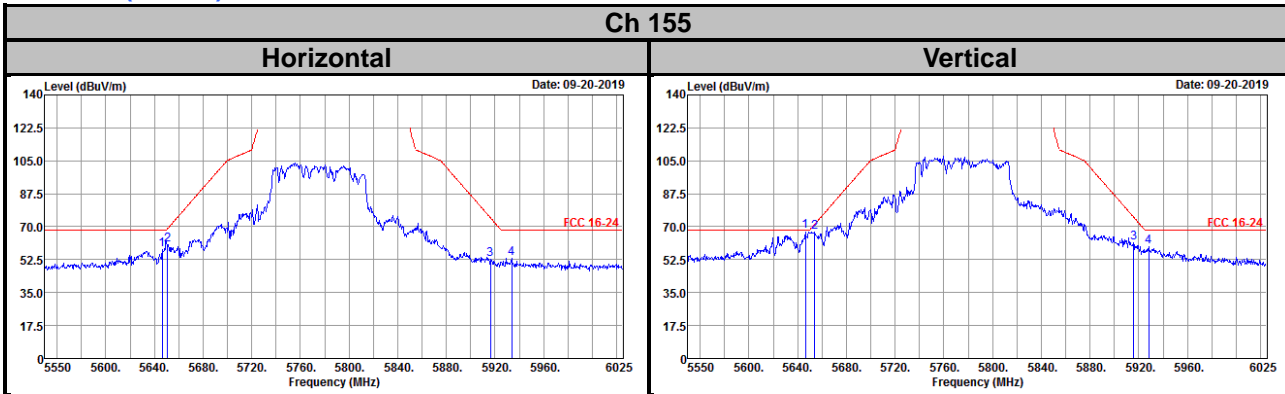

Appendix – Information of the Testing Laboratories

We, Bureau Veritas Consumer Products Services (H.K.) Ltd., Taoyuan Branch, were founded in 1988 to provide our best service in EMC, Radio, Telecom and Safety consultation. Our laboratories are FCC recognized accredited test firms and accredited according to ISO/IEC 17025.

If you have any comments, please feel free to contact us at the following:

Lin Kou EMC/RF Lab

Tel: 886-2-26052180

Fax: 886-2-26051924

Hsin Chu EMC/RF/Telecom Lab

Tel: 886-3-6668565

Fax: 886-3-6668323

Hwa Ya EMC/RF/Safety Lab

Tel: 886-3-3183232

Fax: 886-3-3270892

Email: service.adt@tw.bureauveritas.com

Web Site: www.bureauveritas-adt.com

The address and road map of all our labs can be found in our web site also.

--- END ---