

FCC Test Report

Report No.: RF190822C14 R1

FCC ID: I88ATP100W

Test Model: ATP100W

Received Date: Aug. 22, 2019

Test Date: Sep. 17, 2019 ~ Sep. 24, 2019

Issued Date: Oct. 30, 2019

Applicant: Zyxel Communications Corporation

Address: No.2 Industry East RD. IX, Hsinchu Science Park, Hsinchu 30075, Taiwan

Issued By: Bureau Veritas Consumer Products Services (H.K.) Ltd., Taoyuan Branch
Lin Kou Laboratories

Lab Address: No. 47-2, 14th Ling, Chia Pau Vil., Lin Kou Dist., New Taipei City, Taiwan

Test Location: No.19, Hwa Ya 2nd Rd., Wen Hwa Vil., Kwei Shan Dist., Taoyuan City
33383, Taiwan

**FCC Registration /
Designation Number:** 788550 / TW0003



This report is for your exclusive use. Any copying or replication of this report to or for any other person or entity, or use of our name or trademark, is permitted only with our prior written permission. This report sets forth our findings solely with respect to the test samples identified herein. The results set forth in this report are not indicative or representative of the quality or characteristics of the lot from which a test sample was taken or any similar or identical product unless specifically and expressly noted. Our report includes all of the tests requested by you and the results thereof based upon the information that you provided to us. You have 60 days from date of issuance of this report to notify us of any material error or omission caused by our negligence, provided, however, that such notice shall be in writing and shall specifically address the issue you wish to raise. A failure to raise such issue within the prescribed time shall constitute your unqualified acceptance of the completeness of this report, the tests conducted and the correctness of the report contents. Unless specific mention, the uncertainty of measurement has been explicitly taken into account to declare the compliance or non-compliance to the specification. The report must not be used by the client to claim product certification, approval, or endorsement by TAF or any government agencies.

Table of Contents

Release Control Record	4
1 Certificate of Conformity	5
2 Summary of Test Results	6
2.1 Measurement Uncertainty	6
2.2 Modification Record	6
3 General Information	7
3.1 General Description of EUT	7
3.2 Description of Test Modes	9
3.2.1 Test Mode Applicability and Tested Channel Detail	10
3.3 Duty Cycle of Test Signal	12
3.4 Description of Support Units	13
3.4.1 Configuration of System under Test	13
3.5 General Description of Applied Standards	13
4 Test Types and Results	14
4.1 Radiated Emission and Bandedge Measurement	14
4.1.1 Limits of Radiated Emission and Bandedge Measurement	14
4.1.2 Test Instruments	15
4.1.3 Test Procedures	16
4.1.4 Deviation from Test Standard	17
4.1.5 Test Set Up	17
4.1.6 EUT Operating Conditions	18
4.1.7 Test Results	19
4.2 Conducted Emission Measurement	33
4.2.1 Limits of Conducted Emission Measurement	33
4.2.2 Test Instruments	33
4.2.3 Test Procedures	34
4.2.4 Deviation from Test Standard	34
4.2.5 Test Setup	34
4.2.6 EUT Operating Conditions	34
4.2.7 Test Results	35
4.3 6 dB Bandwidth Measurement	37
4.3.1 Limits of 6 dB Bandwidth Measurement	37
4.3.2 Test Setup	37
4.3.3 Test Instruments	37
4.3.4 Test Procedure	37
4.3.5 Deviation from Test Standard	37
4.3.6 EUT Operating Conditions	37
4.3.7 Test Results	38
4.4 Occupied Bandwidth Measurement	40
4.4.1 Test Setup	40
4.4.2 Test Instruments	40
4.4.3 Test Procedure	40
4.4.4 Deviation from Test Standard	40
4.4.5 EUT Operating Conditions	40
4.4.6 Test Results	41
4.5 Conducted Output Power Measurement	43
4.5.1 Limits of Conducted Output Power Measurement	43
4.5.2 Test Setup	43
4.5.3 Test Instruments	43
4.5.4 Test Procedures	43
4.5.5 Deviation from Test Standard	43
4.5.6 EUT Operating Conditions	43
4.5.7 Test Results	44

4.6	Power Spectral Density Measurement	45
4.6.1	Limits of Power Spectral Density Measurement.....	45
4.6.2	Test Setup.....	45
4.6.3	Test Instruments	45
4.6.4	Test Procedure	45
4.6.5	Deviation from Test Standard	45
4.6.6	EUT Operating Condition	45
4.6.7	Test Results	46
4.7	Conducted Out of Band Emission Measurement	49
4.7.1	Limits of Conducted Out of Band Emission Measurement.....	49
4.7.2	Test Setup.....	49
4.7.3	Test Instruments	49
4.7.4	Test Procedure	49
4.7.5	Deviation from Test Standard	49
4.7.6	EUT Operating Condition	49
4.7.7	Test Results	50
5	Pictures of Test Arrangements.....	66
	Appendix – Information of the Testing Laboratories	67

Release Control Record

Issue No.	Description	Date Issued
RF190822C14	Original Release	Oct. 16, 2019
RF190822C14 R1	Revise antenna connector type	Oct. 30, 2019

1 Certificate of Conformity

Product: ZyWALL ATP Firewall

Brand: ZYXEL

Test Model: ATP100W

Sample Status: Engineering Sample

Applicant: Zyxel Communications Corporation

Test Date: Sep. 17, 2019 ~ Sep. 24, 2019

Standards: 47 CFR FCC Part 15, Subpart C (Section 15.247)
ANSI C63.10:2013

The above equipment has been tested by **Bureau Veritas Consumer Products Services (H.K.) Ltd., Taoyuan Branch**, and found compliance with the requirement of the above standards. The test record, data evaluation & Equipment Under Test (EUT) configurations represented herein are true and accurate accounts of the measurements of the sample's RF characteristics under the conditions specified in this report.

Prepared by : , **Date:** Oct. 30, 2019
Rona Chen / Specialist

Approved by : , **Date:** Oct. 30, 2019
Dylan Chiou / Project Engineer

2 Summary of Test Results

47 CFR FCC Part 15, Subpart C (Section 15.247)			
FCC Clause	Test Item	Result	Remarks
15.207	AC Power Conducted Emission	Pass	Meet the requirement of limit. Minimum passing margin is -11.55 dB at 0.16569 MHz.
15.205 / 15.209 / 15.247(d)	Radiated Emissions and Band Edge Measurement	Pass	Meet the requirement of limit. Minimum passing margin is -0.54 dB at 2483.6 MHz.
15.247(d)	Antenna Port Emission	Pass	Meet the requirement of limit.
15.247(a)(2)	6 dB Bandwidth	Pass	Meet the requirement of limit.
---	Occupied Bandwidth Measurement	Pass	Reference only
15.247(b)	Conducted power	Pass	Meet the requirement of limit.
15.247(e)	Power Spectral Density	Pass	Meet the requirement of limit.
15.203	Antenna Requirement	Pass	Antenna connector is Reverse SMA.

Note: Determining compliance based on the results of the compliance measurement, not taking into account measurement instrumentation uncertainty.

2.1 Measurement Uncertainty

Where relevant, the following measurement uncertainty levels have been estimated for tests performed on the EUT as specified in CISPR 16-4-2:

Measurement	Frequency	Expanded Uncertainty (k=2) (±)
Conducted Emissions at mains ports	150 kHz ~ 30 MHz	2.94 dB
Radiated Emissions up to 1 GHz	9 kHz ~ 30 MHz	3.04 dB
	30 MHz ~ 200 MHz	2.93 dB
	200 MHz ~ 1000 MHz	2.95 dB
Radiated Emissions above 1 GHz	1 GHz ~ 18 GHz	2.26 dB
	18 GHz ~ 40 GHz	1.94 dB

2.2 Modification Record

There were no modifications required for compliance.

3 General Information

3.1 General Description of EUT

Product	ZyWALL ATP Firewall
Brand	ZYXEL
Test Model	ATP100W
Status of EUT	Engineering Sample
Power Supply Rating	12.0 Vdc (Adapter)
Modulation Type	CCK, DQPSK, DBPSK for DSSS 64QAM, 16QAM, QPSK, BPSK for OFDM
Modulation Technology	DSSS, OFDM
Transfer Rate	802.11b: 11.0 / 5.5 / 2.0 / 1.0 Mbps 802.11g: 54.0 / 48.0 / 36.0 / 24.0 / 18.0 / 12.0 / 9.0 / 6.0 Mbps 802.11n: up to 300.0 Mbps
Operating Frequency	2412 ~ 2462 MHz
Number of Channel	11 for 802.11b, 802.11g, 802.11n (HT20) 7 for 802.11n (HT40)
Output Power	485.974 mW
Antenna Type	Dipole antenna with 2.7 dBi gain
Antenna Connector	Reverse SMA
Accessory Device	Refer to Note as below
Data Cable Supplied	Refer to Note as below

Note:



- The EUT incorporates a MIMO function. Physically, the EUT provides two completed transmitters and two receivers.

Modulation Mode	Tx Function
802.11b	2TX
802.11g	2TX
802.11n (HT20)	2TX
802.11n (HT40)	2TX

- The EUT contains following accessory devices.

Product	Brand	Model	Description
Adapter	APD	WA-24Q12R	I/P: 100-240 Vac, 50-60 Hz, 0.7 A O/P: 12 Vdc, 2 A 1.5m cable w/o core
Console Cable	N/A	N/A	0.9m non-shielding cable

3. The EUT uses the following DDRs.

Item	Photo	Specification
1 st DDR (Worst Case)		Brand: NANYA (For DNI code)
2 nd DDR		Brand: WINBOND (For ZYXEL code)

4. The power setting of EUT is listed as below.

802.11b		802.11g		802.11n (HT20)		802.11n (HT40)	
Channel	Power Setting	Channel	Power Setting	Channel	Power Setting	Channel	Power Setting
1	24.5	1	17.0	1	17.5	3	14.5
6	25.0	6	22.5	6	23.0	6	17.5
11	21.0	11	15.5	11	15.5	9	11.5

5. The above EUT information is declared by manufacturer and for more detailed features description, please refers to the manufacturer's specifications or user's manual.

3.2 Description of Test Modes

11 channels are provided for 802.11b, 802.11g and 802.11n (HT20):

Channel	Frequency (MHz)	Channel	Frequency (MHz)
1	2412	7	2442
2	2417	8	2447
3	2422	9	2452
4	2427	10	2457
5	2432	11	2462
6	2437		

7 channels are provided for 802.11n (HT40):

Channel	Frequency (MHz)	Channel	Frequency (MHz)
3	2422	7	2442
4	2427	8	2447
5	2432	9	2452
6	2437		

3.2.1 Test Mode Applicability and Tested Channel Detail

EUT Configure Mode	Applicable To				Description
	RE \geq 1G	RE<1G	PLC	APCM	
-	√	√	√	√	2TX

Where **RE \geq 1G**: Radiated Emission above 1 GHz **RE<1G**: Radiated Emission below 1 GHz
PLC: Power Line Conducted Emission **APCM**: Antenna Port Conducted Measurement

NOTE: The EUT had been pre-tested on the positioned of X and Z axis. The worst case was found when positioned EUT on **Z-plane** and Antenna on **Z-plane**.

Radiated Emission Test (Above 1 GHz):

- Pre-Scan has been conducted to determine the worst-case mode from all possible combinations between available modulations, data rates and antenna ports (if EUT with antenna diversity architecture).
- Following channel(s) was (were) selected for the final test as listed below.

EUT Configure Mode	Mode	Available Channel	Tested Channel	Modulation Technology	Modulation Type	Data Rate (Mbps)
-	802.11b	1 to 11	1, 6, 11	DSSS	DBPSK	1.0
-	802.11g	1 to 11	1, 6, 11	OFDM	BPSK	6.0
-	802.11n (HT20)	1 to 11	1, 6, 11	OFDM	BPSK	6.5
-	802.11n (HT40)	3 to 9	3, 6, 9	OFDM	BPSK	13.5

Radiated Emission Test (Below 1 GHz):

- Pre-Scan has been conducted to determine the worst-case mode from all possible combinations between available modulations, data rates and antenna ports (if EUT with antenna diversity architecture).
- Following channel(s) was (were) selected for the final test as listed below.

EUT Configure Mode	Mode	Available Channel	Tested Channel	Modulation Technology	Modulation Type	Data Rate (Mbps)
-	802.11n (HT40)	3 to 9	9	OFDM	BPSK	13.5

Power Line Conducted Emission Test:

- Pre-Scan has been conducted to determine the worst-case mode from all possible combinations between available modulations, data rates and antenna ports (if EUT with antenna diversity architecture).
- Following channel(s) was (were) selected for the final test as listed below.

EUT Configure Mode	Mode	Available Channel	Tested Channel	Modulation Technology	Modulation Type	Data Rate (Mbps)
-	802.11n (HT40)	3 to 9	9	OFDM	BPSK	13.5

Bandedge Measurement:

- Pre-Scan has been conducted to determine the worst-case mode from all possible combinations between available modulations, data rates and antenna ports (if EUT with antenna diversity architecture).
- Following channel(s) was (were) selected for the final test as listed below.

EUT Configure Mode	Mode	Available Channel	Tested Channel	Modulation Technology	Modulation Type	Data Rate (Mbps)
-	802.11b	1 to 11	1, 11	DSSS	DBPSK	1.0
-	802.11g	1 to 11	1, 11	OFDM	BPSK	6.0
-	802.11n (HT20)	1 to 11	1, 11	OFDM	BPSK	6.5
-	802.11n (HT40)	3 to 9	3, 9	OFDM	BPSK	13.5

Antenna Port Conducted Measurement:

- This item includes all test value of each mode, but only includes spectrum plot of worst value of each mode.
- Pre-Scan has been conducted to determine the worst-case mode from all possible combinations between available modulations, data rates and antenna ports (if EUT with antenna diversity architecture).
- Following channel(s) was (were) selected for the final test as listed below.

EUT Configure Mode	Mode	Available Channel	Tested Channel	Modulation Technology	Modulation Type	Data Rate (Mbps)
-	802.11b	1 to 11	1, 6, 11	DSSS	DBPSK	1.0
-	802.11g	1 to 11	1, 6, 11	OFDM	BPSK	6.0
-	802.11n (HT20)	1 to 11	1, 6, 11	OFDM	BPSK	6.5
-	802.11n (HT40)	3 to 9	3, 6, 9	OFDM	BPSK	13.5

Test Condition:

Applicable To	Environmental Conditions	Input Power	Tested by
RE≥1G	25 deg. C, 65 % RH	120 Vac, 60 Hz	Thomas Wei
RE<1G	25 deg. C, 65 % RH	120 Vac, 60 Hz	Thomas Wei
PLC	25 deg. C, 65 % RH	120 Vac, 60 Hz	Thomas Wei
APCM	25 deg. C, 65 % RH	12 Vdc	Jisyong Wang

3.3 Duty Cycle of Test Signal

802.11b: Duty cycle of test signal is $\geq 98\%$, duty factor is not required.

802.11g: Duty cycle = $2.02/2.185 = 0.924$, Duty factor = $10 * \log(1/0.924) = 0.34$

802.11n (HT20): Duty cycle = $1.869/1.987 = 0.941$, Duty factor = $10 * \log(1/0.941) = 0.27$

802.11n (HT40): Duty cycle = $0.917/1.014 = 0.904$, Duty factor = $10 * \log(1/0.904) = 0.44$

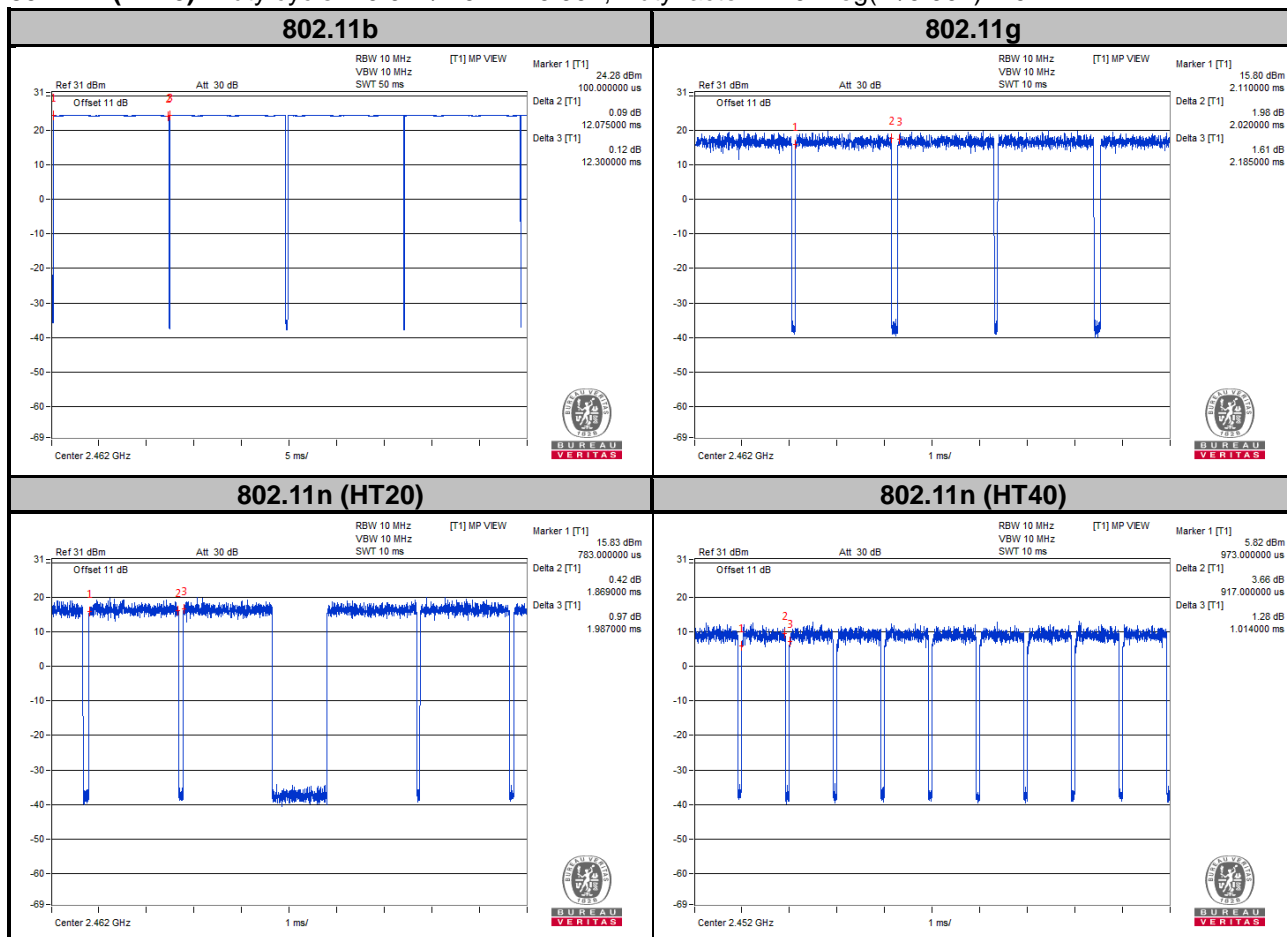

3.4 Description of Support Units

The EUT has been tested as an independent unit together with other necessary accessories or support units.

3.4.1 Configuration of System under Test

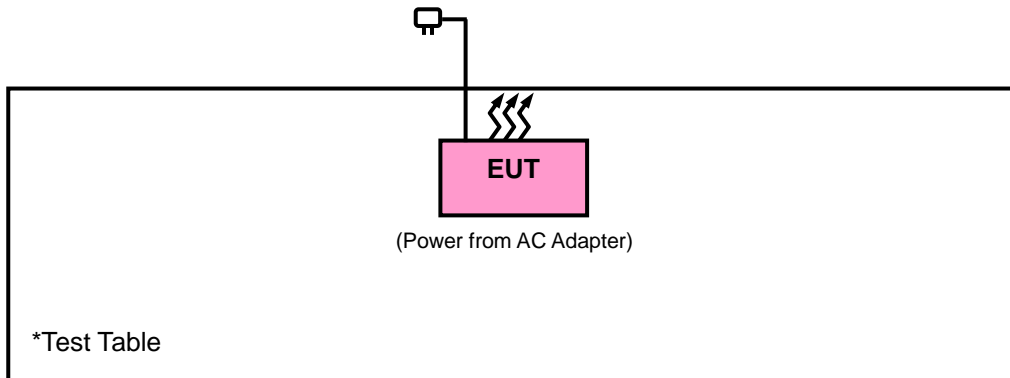

3.5 General Description of Applied Standards

The EUT is a RF Product. According to the specifications of the manufacturer, it must comply with the requirements of the following standards:

FCC Part 15, Subpart C (15.247)

KDB 558074 D01 15.247 Meas Guidance v05r02

KDB 662911 D01 Multiple Transmitter Output v02r01

ANSI C63.10-2013

All test items have been performed and recorded as per the above standards.

4 Test Types and Results

4.1 Radiated Emission and Bandedge Measurement

4.1.1 Limits of Radiated Emission and Bandedge Measurement

Radiated emissions which fall in the restricted bands must comply with the radiated emission limits specified as below table. Other emissions shall be at least 20 dB below the highest level of the desired power:

Frequencies (MHz)	Field Strength (microvolts/meter)	Measurement Distance (meters)
0.009 ~ 0.490	2400/F (kHz)	300
0.490 ~ 1.705	24000/F (kHz)	30
1.705 ~ 30.0	30	30
30 ~ 88	100	3
88 ~ 216	150	3
216 ~ 960	200	3
Above 960	500	3

NOTE:

1. The lower limit shall apply at the transition frequencies.
2. Emission level (dBuV/m) = 20 log Emission level (uV/m).
3. For frequencies above 1000 MHz, the field strength limits are based on average detector, however, the peak field strength of any emission shall not exceed the maximum permitted average limits, specified above by more than 20 dB under any condition of modulation.

4.1.2 Test Instruments

Description & Manufacturer	Model No.	Serial No.	Date of Calibration	Due Date of Calibration
Test Receiver Agilent	N9038A	MY51210203	Mar. 18, 2019	Mar. 17, 2020
Spectrum Analyzer Agilent	N9010A	MY52220314	Dec. 13, 2018	Dec. 12, 2019
Spectrum Analyzer ROHDE & SCHWARZ	FSU43	101261	Apr. 15, 2019	Apr. 14, 2020
Broadband Horn Antenna SCHWARZBECK	BBHA 9170	148	Nov. 25, 2018	Nov. 24, 2019
HORN Antenna SCHWARZBECK	BBHA 9120D	9120D-969	Nov. 25, 2018	Nov. 24, 2019
BILOG Antenna SCHWARZBECK	VULB 9168	9168-472	Nov. 23, 2018	Nov. 22, 2019
Fixed Attenuator WORKEN	MDCS18N-10	MDCS18N-10-01	Apr. 15, 2019	Apr. 14, 2020
Loop Antenna	HLA 6121	45745	Jul. 01, 2019	Jun. 30, 2020
Preamplifier EMCI	EMC001340	980201	Oct. 12, 2018	Oct. 11, 2019
Preamplifier EMCI	EMC 012645	980115	Oct. 12, 2018	Oct. 11, 2019
Preamplifier EMCI	EMC 184045	980116	Oct. 12, 2018	Oct. 11, 2019
Preamplifier EMCI	EMC 330H	980112	Oct. 12, 2018	Oct. 11, 2019
Power Meter Anritsu	ML2495A	1012010	Sep. 04, 2019	Sep. 03, 2020
Power Sensor Anritsu	MA2411B	1315050	Sep. 04, 2019	Sep. 03, 2020
RF Coaxial Cable HUBER+SUHNNER	EMC104-SM-SM-8 000&3000	140811+170717	Oct. 12, 2018	Oct. 11, 2019
RF Coaxial Cable HUBER+SUHNNER	SUCOFLEX 104	EMC104-SM-SM-1 000(140807)	Oct. 12, 2018	Oct. 11, 2019
RF Coaxial Cable WOKEN	8D-FB	Cable-Ch10-01	Oct. 12, 2018	Oct. 11, 2019
Software BV ADT	E3 6.120103	NA	NA	NA
Antenna Tower MF	MFA-440H	NA	NA	NA
Turn Table MF	MFT-201SS	NA	NA	NA
Antenna Tower & Turn Table Controller MF	MF-7802	NA	NA	NA

- Note: 1. The calibration interval of the above test instruments is 12 months and the calibrations are traceable to NML/ROC and NIST/USA.
2. The test was performed in HwaYa Chamber 10.

4.1.3 Test Procedures

For Radiated Emission below 30 MHz

- a. The EUT was placed on the top of a rotating table 0.8 meters above the ground at a 3 meter chamber room. The table was rotated 360 degrees to determine the position of the highest radiation.
- b. The EUT was set 3 meters away from the interference-receiving antenna, which was mounted on the top of a variable-height antenna tower.
- c. Parallel, perpendicular, and ground-parallel orientations of the antenna are set to make the measurement.
- d. For each suspected emission, the EUT was arranged to its worst case and the rotatable table was turned from 0 degrees to 360 degrees to find the maximum reading.
- e. The test-receiver system was set to Quasi-Peak Detect Function and Specified Bandwidth with Maximum Hold Mode.

Note:

1. The resolution bandwidth and video bandwidth of test receiver/spectrum analyzer is 9 kHz at frequency below 30 MHz.

For Radiated Emission above 30 MHz

- a. The EUT was placed on the top of a rotating table 0.8 meters (for 30 MHz ~ 1 GHz) / 1.5 meters (for above 1 GHz) above the ground at 3 meter chamber room for test. The table was rotated 360 degrees to determine the position of the highest radiation.
- b. The EUT was set 3 meters away from the interference-receiving antenna, which was mounted on the top of a variable-height antenna tower.
- c. The height of antenna is varied from one meter to four meters above the ground to determine the maximum value of the field strength. Both horizontal and vertical polarizations of the antenna are set to make the measurement.
- d. For each suspected emission, the EUT was arranged to its worst case and then the antenna was tuned to heights from 1 meter to 4 meters and the rotatable table was turned from 0 degrees to 360 degrees to find the maximum reading.
- e. The test-receiver system was set to quasi-peak detect function and specified bandwidth with maximum hold mode when the test frequency is below 1 GHz.
- f. The test-receiver system was set to peak and average detected function and specified bandwidth with maximum hold mode when the test frequency is above 1 GHz. If the peak reading value also meets average limit, measurement with the average detector is unnecessary.

Note:

1. The resolution bandwidth and video bandwidth of test receiver/spectrum analyzer is 120 kHz for Quasi-peak detection (QP) or Peak detection (PK) at frequency below 1 GHz.
2. The resolution bandwidth of test receiver/spectrum analyzer is 1 MHz and the video bandwidth is 3 MHz for Peak detection (PK) at frequency above 1 GHz.
3. The resolution bandwidth of test receiver/spectrum analyzer is 1 MHz and the video bandwidth is $\geq 1/T$ (Duty cycle < 98 %) or 10 Hz (Duty cycle ≥ 98 %) for Average detection (AV) at frequency above 1 GHz.
(11b: RBW = 1 MHz, VBW = 10 Hz ; 11g: RBW = 1 MHz, VBW = 1 kHz ;
11n (HT20): RBW = 1 MHz, VBW = 1 kHz ; 11n (HT40): RBW = 1 MHz, VBW = 3 kHz)
4. All modes of operation were investigated and the worst-case emissions are reported.

4.1.4 Deviation from Test Standard

No deviation.

4.1.5 Test Set Up

<Radiated Emission below 30 MHz>

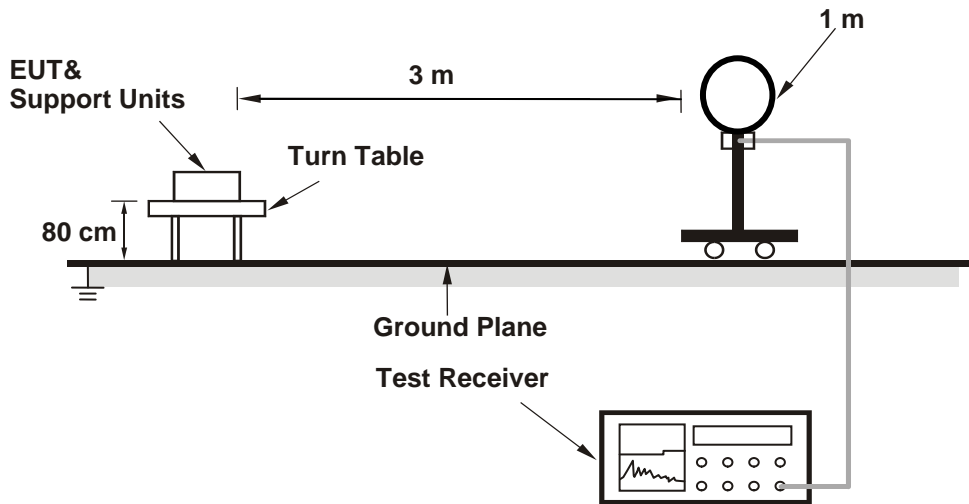

<Radiated Emission 30 MHz to 1 GHz>

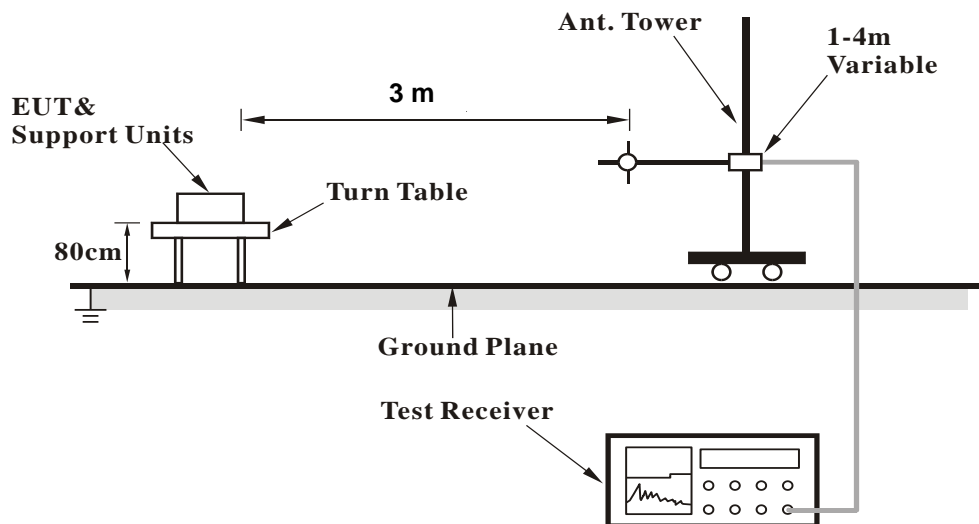

<Radiated Emission above 1 GHz>

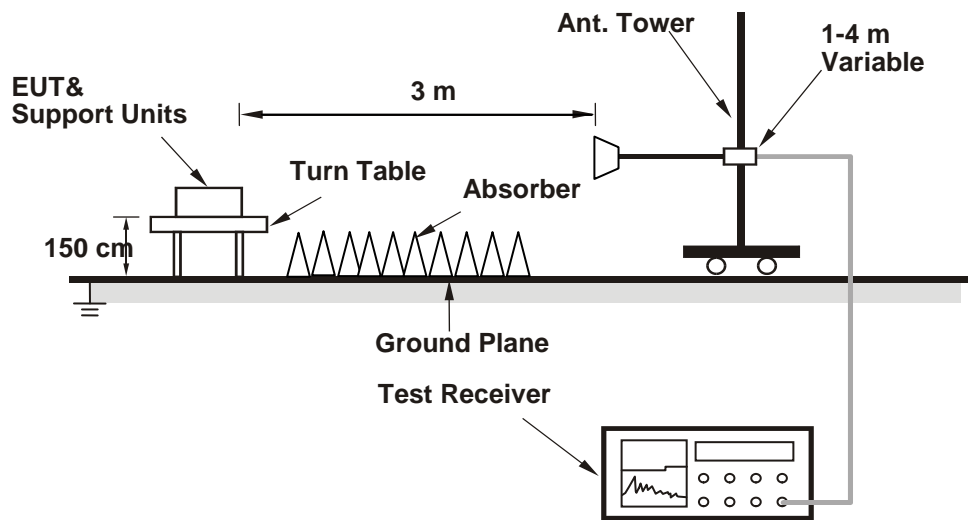

For the actual test configuration, please refer to the attached file (Test Setup Photo).

4.1.6 EUT Operating Conditions

- a. Placed the EUT on a testing table.
- b. Use the software to control the EUT under transmission condition continuously at specific channel frequency.

4.1.7 Test Results

Above 1 GHz Data :
802.11b

EUT Test Condition		Measurement Detail	
Channel	Channel 1	Frequency Range	1 GHz ~ 25 GHz
Input Power	120 Vac, 60 Hz	Detector Function	Peak (PK) Average (AV)
Environmental Conditions	25 deg. C, 65 % RH	Tested By	Thomas Wei

Antenna Polarity & Test Distance: Horizontal at 3 m								
Frequency (MHz)	Emission Level (dBuV/m)	Read Level (dBuV)	Factor (dB/m)	Limit (dBuV/m)	Margin (dB)	Antenna Height (cm)	Table Angle (Degree)	Remark
2389.66	40.71	45.69	-4.98	54	-13.29	100	308	Average
2389.66	49.83	54.81	-4.98	74	-24.17	100	308	Peak
2412	103.91	108.92	-5.01			100	308	Average
2412	108.77	113.78	-5.01			100	308	Peak
4824	35.86	50.24	-14.38	54	-18.14	122	104	Average
4824	43.58	57.96	-14.38	74	-30.42	122	104	Peak

Antenna Polarity & Test Distance: Vertical at 3 m								
Frequency (MHz)	Emission Level (dBuV/m)	Read Level (dBuV)	Factor (dB/m)	Limit (dBuV/m)	Margin (dB)	Antenna Height (cm)	Table Angle (Degree)	Remark
2389.94	50.85	55.85	-5	54	-3.15	189	211	Average
2389.94	58.53	63.53	-5	74	-15.47	189	211	Peak
2412	117.54	122.55	-5.01			189	211	Average
2412	122.01	127.02	-5.01			189	211	Peak
4824	39.98	54.36	-14.38	54	-14.02	201	50	Average
4824	46.03	60.41	-14.38	74	-27.97	201	50	Peak

Remarks:

- Emission Level = Read Level + Factor
Margin value = Emission level – Limit value
- 2412 MHz: Fundamental frequency.
- The emission levels of other frequencies were very low against the limit.

EUT Test Condition		Measurement Detail	
Channel	Channel 6	Frequency Range	1 GHz ~ 25 GHz
Input Power	120 Vac, 60 Hz	Detector Function	Peak (PK) Average (AV)
Environmental Conditions	25 deg. C, 65 % RH	Tested By	Thomas Wei

Antenna Polarity & Test Distance: Horizontal at 3 m								
Frequency (MHz)	Emission Level (dBuV/m)	Read Level (dBuV)	Factor (dB/m)	Limit (dBuV/m)	Margin (dB)	Antenna Height (cm)	Table Angle (Degree)	Remark
2389.24	38.81	43.79	-4.98	54	-15.19	100	10	Average
2389.24	48.97	53.95	-4.98	74	-25.03	100	10	Peak
2437	107.07	112.05	-4.98			100	10	Average
2437	112.24	117.22	-4.98			100	10	Peak
2484.52	39.77	44.62	-4.85	54	-14.23	100	10	Average
2484.52	51.15	56	-4.85	74	-22.85	100	10	Peak
4874	43.12	57.2	-14.08	54	-10.88	230	242	Average
4874	49.91	63.99	-14.08	74	-24.09	230	242	Peak

Antenna Polarity & Test Distance: Vertical at 3 m								
Frequency (MHz)	Emission Level (dBuV/m)	Read Level (dBuV)	Factor (dB/m)	Limit (dBuV/m)	Margin (dB)	Antenna Height (cm)	Table Angle (Degree)	Remark
2388.96	44.91	49.89	-4.98	54	-9.09	180	177	Average
2388.96	55.87	60.85	-4.98	74	-18.13	180	177	Peak
2437	119.13	124.11	-4.98			180	177	Average
2437	124.22	129.2	-4.98			180	177	Peak
2484	50.91	55.76	-4.85	54	-3.09	180	177	Average
2484	61.86	66.71	-4.85	74	-12.14	180	177	Peak
4874	44.91	58.99	-14.08	54	-9.09	108	50	Average
4874	51.17	65.25	-14.08	74	-22.83	108	50	Peak

Remarks:

- Emission Level = Read Level + Factor
Margin value = Emission level – Limit value
- 2437 MHz: Fundamental frequency.
- The emission levels of other frequencies were very low against the limit.

EUT Test Condition		Measurement Detail	
Channel	Channel 11	Frequency Range	1 GHz ~ 25 GHz
Input Power	120 Vac, 60 Hz	Detector Function	Peak (PK) Average (AV)
Environmental Conditions	25 deg. C, 65 % RH	Tested By	Thomas Wei

Antenna Polarity & Test Distance: Horizontal at 3 m								
Frequency (MHz)	Emission Level (dBuV/m)	Read Level (dBuV)	Factor (dB/m)	Limit (dBuV/m)	Margin (dB)	Antenna Height (cm)	Table Angle (Degree)	Remark
2462	102.64	107.55	-4.91			254	170	Average
2462	107.22	112.13	-4.91			254	170	Peak
2483.56	42.55	47.4	-4.85	54	-11.45	254	170	Average
2483.56	51.55	56.4	-4.85	74	-22.45	254	170	Peak
4924	36.12	50.08	-13.96	54	-17.88	158	203	Average
4924	44.48	58.44	-13.96	74	-29.52	158	203	Peak
Antenna Polarity & Test Distance: Vertical at 3 m								
Frequency (MHz)	Emission Level (dBuV/m)	Read Level (dBuV)	Factor (dB/m)	Limit (dBuV/m)	Margin (dB)	Antenna Height (cm)	Table Angle (Degree)	Remark
2462	114.78	119.69	-4.91			178	179	Average
2462	120.4	125.31	-4.91			178	179	Peak
2487.64	51.89	56.74	-4.85	54	-2.11	178	179	Average
2487.64	62.41	67.26	-4.85	74	-11.59	178	179	Peak
4924	38.41	52.37	-13.96	54	-15.59	185	43	Average
4924	45.24	59.2	-13.96	74	-28.76	185	43	Peak

Remarks:

- Emission Level = Read Level + Factor
Margin value = Emission level – Limit value
- 2462 MHz: Fundamental frequency.
- The emission levels of other frequencies were very low against the limit.

802.11g

EUT Test Condition		Measurement Detail	
Channel	Channel 1	Frequency Range	1 GHz ~ 25 GHz
Input Power	120 Vac, 60 Hz	Detector Function	Peak (PK) Average (AV)
Environmental Conditions	25 deg. C, 65 % RH	Tested By	Thomas Wei

Antenna Polarity & Test Distance: Horizontal at 3 m								
Frequency (MHz)	Emission Level (dBuV/m)	Read Level (dBuV)	Factor (dB/m)	Limit (dBuV/m)	Margin (dB)	Antenna Height (cm)	Table Angle (Degree)	Remark
2389.94	41.76	46.76	-5	54	-12.24	100	356	Average
2389.94	49.44	54.44	-5	74	-24.56	100	356	Peak
2412	96.46	101.47	-5.01			100	356	Average
2412	103.62	108.63	-5.01			100	356	Peak
4824	32.88	47.26	-14.38	54	-21.12	163	254	Average
4824	43.6	57.98	-14.38	74	-30.4	163	254	Peak
Antenna Polarity & Test Distance: Vertical at 3 m								
Frequency (MHz)	Emission Level (dBuV/m)	Read Level (dBuV)	Factor (dB/m)	Limit (dBuV/m)	Margin (dB)	Antenna Height (cm)	Table Angle (Degree)	Remark
2389.94	51.19	56.19	-5	54	-2.81	189	207	Average
2389.94	61.5	66.5	-5	74	-12.5	189	207	Peak
2412	107.78	112.79	-5.01			189	207	Average
2412	114.55	119.56	-5.01			189	207	Peak
4824	33.5	47.88	-14.38	54	-20.5	102	311	Average
4824	44.19	58.57	-14.38	74	-29.81	102	311	Peak

Remarks:

- Emission Level = Read Level + Factor
Margin value = Emission level – Limit value
- 2412 MHz: Fundamental frequency.
- The emission levels of other frequencies were very low against the limit.

EUT Test Condition		Measurement Detail	
Channel	Channel 6	Frequency Range	1 GHz ~ 25 GHz
Input Power	120 Vac, 60 Hz	Detector Function	Peak (PK) Average (AV)
Environmental Conditions	25 deg. C, 65 % RH	Tested By	Thomas Wei

Antenna Polarity & Test Distance: Horizontal at 3 m								
Frequency (MHz)	Emission Level (dBuV/m)	Read Level (dBuV)	Factor (dB/m)	Limit (dBuV/m)	Margin (dB)	Antenna Height (cm)	Table Angle (Degree)	Remark
2342.76	38.31	43.04	-4.73	54	-15.69	126	168	Average
2342.76	48.18	52.91	-4.73	74	-25.82	126	168	Peak
2437	98.33	103.31	-4.98			126	168	Average
2437	104.55	109.53	-4.98			126	168	Peak
2483.52	41.93	46.78	-4.85	54	-12.07	126	168	Average
2483.52	54.14	58.99	-4.85	74	-19.86	126	168	Peak
4874	32.03	46.11	-14.08	54	-21.97	223	256	Average
4874	42.51	56.59	-14.08	74	-31.49	223	256	Peak

Antenna Polarity & Test Distance: Vertical at 3 m								
Frequency (MHz)	Emission Level (dBuV/m)	Read Level (dBuV)	Factor (dB/m)	Limit (dBuV/m)	Margin (dB)	Antenna Height (cm)	Table Angle (Degree)	Remark
2389.94	46.2	51.2	-5	54	-7.8	180	181	Average
2389.94	59.84	64.84	-5	74	-14.16	180	181	Peak
2437	113.21	118.19	-4.98			180	181	Average
2437	120.09	125.07	-4.98			180	181	Peak
2483.52	53.32	58.17	-4.85	54	-0.68	180	181	Average
2483.52	66.57	71.42	-4.85	74	-7.43	180	181	Peak
4874	31.97	46.05	-14.08	54	-22.03	142	173	Average
4874	42.04	56.12	-14.08	74	-31.96	142	173	Peak

Remarks:

- Emission Level = Read Level + Factor
Margin value = Emission level – Limit value
- 2437 MHz: Fundamental frequency.
- The emission levels of other frequencies were very low against the limit.

EUT Test Condition		Measurement Detail	
Channel	Channel 11	Frequency Range	1 GHz ~ 25 GHz
Input Power	120 Vac, 60 Hz	Detector Function	Peak (PK) Average (AV)
Environmental Conditions	25 deg. C, 65 % RH	Tested By	Thomas Wei

Antenna Polarity & Test Distance: Horizontal at 3 m								
Frequency (MHz)	Emission Level (dBuV/m)	Read Level (dBuV)	Factor (dB/m)	Limit (dBuV/m)	Margin (dB)	Antenna Height (cm)	Table Angle (Degree)	Remark
2462	94.41	99.32	-4.91			107	171	Average
2462	100.88	105.79	-4.91			107	171	Peak
2483.6	42.07	46.92	-4.85	54	-11.93	107	171	Average
2483.6	53.01	57.86	-4.85	74	-20.99	107	171	Peak
4924	33.07	47.03	-13.96	54	-20.93	156	202	Average
4924	43.27	57.23	-13.96	74	-30.73	156	202	Peak

Antenna Polarity & Test Distance: Vertical at 3 m								
Frequency (MHz)	Emission Level (dBuV/m)	Read Level (dBuV)	Factor (dB/m)	Limit (dBuV/m)	Margin (dB)	Antenna Height (cm)	Table Angle (Degree)	Remark
2462	107.01	111.92	-4.91			190	182	Average
2462	113.61	118.52	-4.91			190	182	Peak
2483.52	52.59	57.44	-4.85	54	-1.41	190	182	Average
2483.52	64.14	68.99	-4.85	74	-9.86	190	182	Peak
4924	32.92	46.88	-13.96	54	-21.08	128	107	Average
4924	42.58	56.54	-13.96	74	-31.42	128	107	Peak

Remarks:

- Emission Level = Read Level + Factor
Margin value = Emission level – Limit value
- 2462 MHz: Fundamental frequency.
- The emission levels of other frequencies were very low against the limit.

802.11n (HT20)

EUT Test Condition		Measurement Detail	
Channel	Channel 1	Frequency Range	1 GHz ~ 25 GHz
Input Power	120 Vac, 60 Hz	Detector Function	Peak (PK) Average (AV)
Environmental Conditions	25 deg. C, 65 % RH	Tested By	Thomas Wei

Antenna Polarity & Test Distance: Horizontal at 3 m								
Frequency (MHz)	Emission Level (dBuV/m)	Read Level (dBuV)	Factor (dB/m)	Limit (dBuV/m)	Margin (dB)	Antenna Height (cm)	Table Angle (Degree)	Remark
2389.94	42.89	47.89	-5	54	-11.11	100	360	Average
2389.94	51.82	56.82	-5	74	-22.18	100	360	Peak
2412	95.38	100.39	-5.01			100	360	Average
2412	102.8	107.81	-5.01			100	360	Peak
4824	35.14	49.52	-14.38	54	-18.86	147	103	Average
4824	44.75	59.13	-14.38	74	-29.25	147	103	Peak
Antenna Polarity & Test Distance: Vertical at 3 m								
Frequency (MHz)	Emission Level (dBuV/m)	Read Level (dBuV)	Factor (dB/m)	Limit (dBuV/m)	Margin (dB)	Antenna Height (cm)	Table Angle (Degree)	Remark
2389.94	52.78	57.78	-5	54	-1.22	166	8	Average
2389.94	62.66	67.66	-5	74	-11.34	166	8	Peak
2412	105.25	110.26	-5.01			166	8	Average
2412	112.91	117.92	-5.01			166	8	Peak
4824	34.95	49.33	-14.38	54	-19.05	156	203	Average
4824	44.09	58.47	-14.38	74	-29.91	156	203	Peak

Remarks:

- Emission Level = Read Level + Factor
Margin value = Emission level – Limit value
- 2412 MHz: Fundamental frequency.
- The emission levels of other frequencies were very low against the limit.

EUT Test Condition		Measurement Detail	
Channel	Channel 6	Frequency Range	1 GHz ~ 25 GHz
Input Power	120 Vac, 60 Hz	Detector Function	Peak (PK) Average (AV)
Environmental Conditions	25 deg. C, 65 % RH	Tested By	Thomas Wei

Antenna Polarity & Test Distance: Horizontal at 3 m								
Frequency (MHz)	Emission Level (dBuV/m)	Read Level (dBuV)	Factor (dB/m)	Limit (dBuV/m)	Margin (dB)	Antenna Height (cm)	Table Angle (Degree)	Remark
2389.8	39.4	44.4	-5	54	-14.6	100	4	Average
2389.8	48.82	53.82	-5	74	-25.18	100	4	Peak
2437	99.68	104.66	-4.98			100	4	Average
2437	107.03	112.01	-4.98			100	4	Peak
2483.76	42.63	47.48	-4.85	54	-11.37	100	4	Average
2483.76	54.89	59.74	-4.85	74	-19.11	100	4	Peak
4874	34.76	48.84	-14.08	54	-19.24	149	76	Average
4874	44.85	58.93	-14.08	74	-29.15	149	76	Peak

Antenna Polarity & Test Distance: Vertical at 3 m								
Frequency (MHz)	Emission Level (dBuV/m)	Read Level (dBuV)	Factor (dB/m)	Limit (dBuV/m)	Margin (dB)	Antenna Height (cm)	Table Angle (Degree)	Remark
2389.94	46.69	51.69	-5	54	-7.31	192	181	Average
2389.94	55.97	60.97	-5	74	-18.03	192	181	Peak
2437	110.84	115.82	-4.98			192	181	Average
2437	119.07	124.05	-4.98			192	181	Peak
2483.6	53.07	57.92	-4.85	54	-0.93	192	181	Average
2483.6	64.99	69.84	-4.85	74	-9.01	192	181	Peak
4874	35.32	49.4	-14.08	54	-18.68	166	255	Average
4874	44.59	58.67	-14.08	74	-29.41	166	255	Peak

Remarks:

- Emission Level = Read Level + Factor
Margin value = Emission level – Limit value
- 2437 MHz: Fundamental frequency.
- The emission levels of other frequencies were very low against the limit.

EUT Test Condition		Measurement Detail	
Channel	Channel 11	Frequency Range	1 GHz ~ 25 GHz
Input Power	120 Vac, 60 Hz	Detector Function	Peak (PK) Average (AV)
Environmental Conditions	25 deg. C, 65 % RH	Tested By	Thomas Wei

Antenna Polarity & Test Distance: Horizontal at 3 m								
Frequency (MHz)	Emission Level (dBuV/m)	Read Level (dBuV)	Factor (dB/m)	Limit (dBuV/m)	Margin (dB)	Antenna Height (cm)	Table Angle (Degree)	Remark
2462	93.29	98.2	-4.91			100	4	Average
2462	100.25	105.16	-4.91			100	4	Peak
2483.68	42.19	47.04	-4.85	54	-11.81	100	4	Average
2483.68	53.04	57.89	-4.85	74	-20.96	100	4	Peak
4924	35.26	49.22	-13.96	54	-18.74	149	261	Average
4924	45.07	59.03	-13.96	74	-28.93	149	261	Peak
Antenna Polarity & Test Distance: Vertical at 3 m								
Frequency (MHz)	Emission Level (dBuV/m)	Read Level (dBuV)	Factor (dB/m)	Limit (dBuV/m)	Margin (dB)	Antenna Height (cm)	Table Angle (Degree)	Remark
2462	105.08	109.99	-4.91			192	183	Average
2462	113.4	118.31	-4.91			192	183	Peak
2483.56	52.35	57.2	-4.85	54	-1.65	192	183	Average
2483.56	62.82	67.67	-4.85	74	-11.18	192	183	Peak
4924	35.41	49.37	-13.96	54	-18.59	143	188	Average
4924	45.25	59.21	-13.96	74	-28.75	143	188	Peak

Remarks:

- Emission Level = Read Level + Factor
Margin value = Emission level – Limit value
- 2462 MHz: Fundamental frequency.
- The emission levels of other frequencies were very low against the limit.

802.11n (HT40)

EUT Test Condition		Measurement Detail	
Channel	Channel 3	Frequency Range	1 GHz ~ 25 GHz
Input Power	120 Vac, 60 Hz	Detector Function	Peak (PK) Average (AV)
Environmental Conditions	25 deg. C, 65 % RH	Tested By	Thomas Wei

Antenna Polarity & Test Distance: Horizontal at 3 m

Frequency (MHz)	Emission Level (dBuV/m)	Read Level (dBuV)	Factor (dB/m)	Limit (dBuV/m)	Margin (dB)	Antenna Height (cm)	Table Angle (Degree)	Remark
2389.94	43.09	48.09	-5	54	-10.91	100	356	Average
2389.94	51.74	56.74	-5	74	-22.26	100	356	Peak
2422	88.72	93.69	-4.97			100	356	Average
2422	96.78	101.75	-4.97			100	356	Peak
2489.8	38.45	43.3	-4.85	54	-15.55	100	356	Average
2489.8	47.65	52.5	-4.85	74	-26.35	100	356	Peak
4844	35.12	49.39	-14.27	54	-18.88	167	100	Average
4844	45.1	59.37	-14.27	74	-28.9	167	100	Peak

Antenna Polarity & Test Distance: Vertical at 3 m

Frequency (MHz)	Emission Level (dBuV/m)	Read Level (dBuV)	Factor (dB/m)	Limit (dBuV/m)	Margin (dB)	Antenna Height (cm)	Table Angle (Degree)	Remark
2389.94	53.03	58.03	-5	54	-0.97	182	7	Average
2389.94	61.86	66.86	-5	74	-12.14	182	7	Peak
2422	100.77	105.74	-4.97			182	7	Average
2422	108.63	113.6	-4.97			182	7	Peak
2483.76	41.52	46.37	-4.85	54	-12.48	182	7	Average
2483.76	51.37	56.22	-4.85	74	-22.63	182	7	Peak
4844	35.19	49.46	-14.27	54	-18.81	154	273	Average
4844	44.46	58.73	-14.27	74	-29.54	154	273	Peak

Remarks:

- Emission Level = Read Level + Factor
Margin value = Emission level – Limit value
- 2422 MHz: Fundamental frequency.
- The emission levels of other frequencies were very low against the limit.

EUT Test Condition		Measurement Detail	
Channel	Channel 6	Frequency Range	1 GHz ~ 25 GHz
Input Power	120 Vac, 60 Hz	Detector Function	Peak (PK) Average (AV)
Environmental Conditions	25 deg. C, 65 % RH	Tested By	Thomas Wei

Antenna Polarity & Test Distance: Horizontal at 3 m								
Frequency (MHz)	Emission Level (dBuV/m)	Read Level (dBuV)	Factor (dB/m)	Limit (dBuV/m)	Margin (dB)	Antenna Height (cm)	Table Angle (Degree)	Remark
2389.66	39.28	44.26	-4.98	54	-14.72	100	5	Average
2389.66	48.49	53.47	-4.98	74	-25.51	100	5	Peak
2437	92.25	97.23	-4.98			100	5	Average
2437	100.06	105.04	-4.98			100	5	Peak
2483.88	40.67	45.52	-4.85	54	-13.33	100	5	Average
2483.88	49.73	54.58	-4.85	74	-24.27	100	5	Peak
4874	35.33	49.41	-14.08	54	-18.67	156	308	Average
4874	44.62	58.7	-14.08	74	-29.38	156	308	Peak

Antenna Polarity & Test Distance: Vertical at 3 m								
Frequency (MHz)	Emission Level (dBuV/m)	Read Level (dBuV)	Factor (dB/m)	Limit (dBuV/m)	Margin (dB)	Antenna Height (cm)	Table Angle (Degree)	Remark
2389.94	48.42	53.42	-5	54	-5.58	177	177	Average
2389.94	58.99	63.99	-5	74	-15.01	177	177	Peak
2437	103.98	108.96	-4.98			177	177	Average
2437	111.19	116.17	-4.98			177	177	Peak
2483.68	51.88	56.73	-4.85	54	-2.12	177	177	Average
2483.68	60.41	65.26	-4.85	74	-13.59	177	177	Peak
4874	35.46	49.54	-14.08	54	-18.54	146	208	Average
4874	45.08	59.16	-14.08	74	-28.92	146	208	Peak

Remarks:

- Emission Level = Read Level + Factor
Margin value = Emission level – Limit value
- 2437 MHz: Fundamental frequency.
- The emission levels of other frequencies were very low against the limit.

EUT Test Condition		Measurement Detail	
Channel	Channel 9	Frequency Range	1 GHz ~ 25 GHz
Input Power	120 Vac, 60 Hz	Detector Function	Peak (PK) Average (AV)
Environmental Conditions	25 deg. C, 65 % RH	Tested By	Thomas Wei

Antenna Polarity & Test Distance: Horizontal at 3 m								
Frequency (MHz)	Emission Level (dBuV/m)	Read Level (dBuV)	Factor (dB/m)	Limit (dBuV/m)	Margin (dB)	Antenna Height (cm)	Table Angle (Degree)	Remark
2312.52	38.74	43.2	-4.46	54	-15.26	100	5	Average
2312.52	49.04	53.5	-4.46	74	-24.96	100	5	Peak
2452	86.04	90.95	-4.91			100	5	Average
2452	93.48	98.39	-4.91			100	5	Peak
2483.52	43.1	47.95	-4.85	54	-10.9	100	5	Average
2483.52	53.82	58.67	-4.85	74	-20.18	100	5	Peak
4904	35.4	49.38	-13.98	54	-18.6	130	258	Average
4904	44.89	58.87	-13.98	74	-29.11	130	258	Peak

Antenna Polarity & Test Distance: Vertical at 3 m								
Frequency (MHz)	Emission Level (dBuV/m)	Read Level (dBuV)	Factor (dB/m)	Limit (dBuV/m)	Margin (dB)	Antenna Height (cm)	Table Angle (Degree)	Remark
2377.76	38.8	43.69	-4.89	54	-15.2	176	177	Average
2377.76	48.27	53.16	-4.89	74	-25.73	176	177	Peak
2452	98.07	102.98	-4.91			176	177	Average
2452	105.94	110.85	-4.91			176	177	Peak
2483.6	53.46	58.31	-4.85	54	-0.54	176	177	Average
2483.6	65.24	70.09	-4.85	74	-8.76	176	177	Peak
4904	35.51	49.49	-13.98	54	-18.49	172	151	Average
4904	45.42	59.4	-13.98	74	-28.58	172	151	Peak

Remarks:

- Emission Level = Read Level + Factor
Margin value = Emission level – Limit value
- 2452 MHz: Fundamental frequency.
- The emission levels of other frequencies were very low against the limit.

9 kHz ~ 30 MHz Data:

The amplitude of spurious emissions attenuated more than 20 dB below the permissible value is not required to be report.

30 MHz ~ 1 GHz Worst-Case Data:

802.11n (HT40)

EUT Test Condition		Measurement Detail	
Channel	Channel 9	Frequency Range	30 MHz ~ 1 GHz
Input Power	120 Vac, 60 Hz	Detector Function	Peak (PK) Quasi-peak (QP)
Environmental Conditions	25 deg. C, 65 % RH	Tested By	Thomas Wei

Horizontal

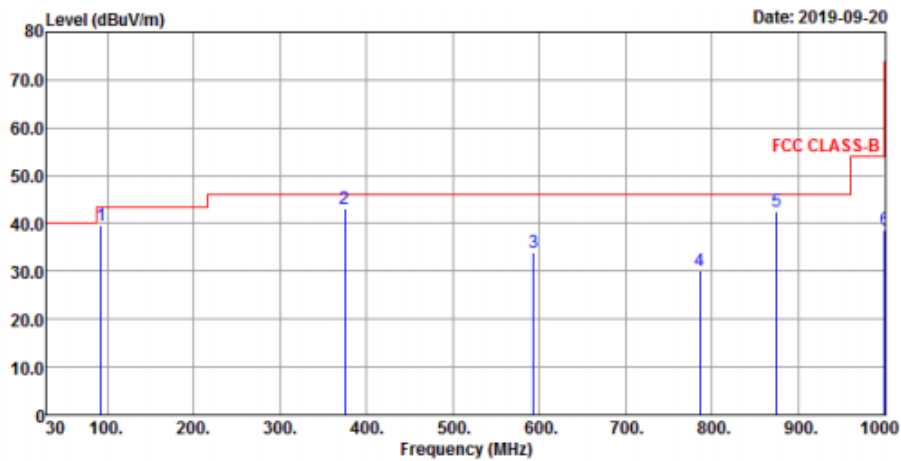

Vertical

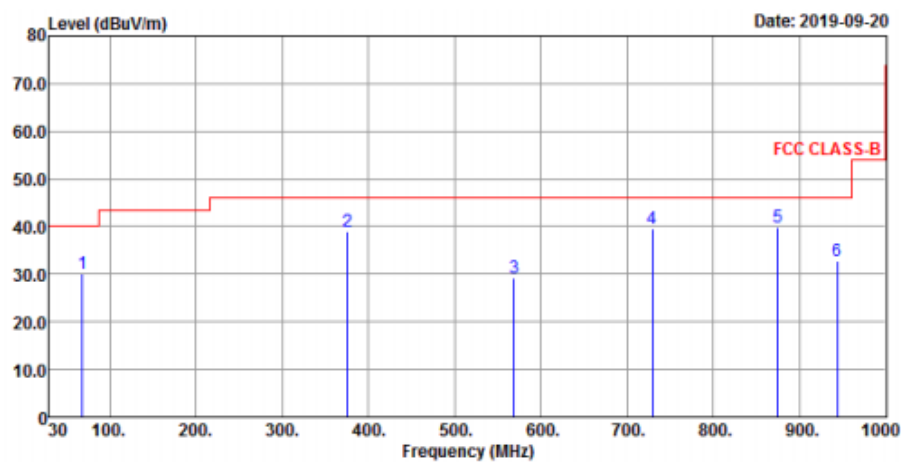

Antenna Polarity & Test Distance: Horizontal at 3 m

Frequency (MHz)	Emission Level (dBuV/m)	Read Level (dBuV)	Factor (dB/m)	Limit (dBuV/m)	Margin (dB)	Antenna Height (cm)	Table Angle (Degree)	Remark
93.05	39.66	61.8	-22.14	43.5	-3.84	168	241	Peak
375	42.96	57.92	-14.96	46	-3.04	100	33	QP
593.57	34.08	42.52	-8.44	46	-11.92	103	21	Peak
785.63	30.03	34.69	-4.66	46	-15.97	104	188	Peak
874.87	42.65	47.05	-4.4	46	-3.35	167	299	Peak
1000	38.58	41.22	-2.64	54	-15.42	133	261	Peak

Antenna Polarity & Test Distance: Vertical at 3 m

Frequency (MHz)	Emission Level (dBuV/m)	Read Level (dBuV)	Factor (dB/m)	Limit (dBuV/m)	Margin (dB)	Antenna Height (cm)	Table Angle (Degree)	Remark
68.8	30.05	49.68	-19.63	40	-9.95	103	136	Peak
375.32	39.11	54.07	-14.96	46	-6.89	111	148	Peak
569.32	29.19	39.33	-10.14	46	-16.81	221	309	Peak
729.37	39.68	46.24	-6.56	46	-6.32	152	187	Peak
874.87	39.95	44.35	-4.4	46	-6.05	100	175	Peak
943.74	32.65	35.38	-2.73	46	-13.35	171	205	Peak

Remarks:

- Emission Level = Read Level + Factor
Margin value = Emission level – Limit value.
- The emission levels of other frequencies were very low against the limit.

4.2 Conducted Emission Measurement

4.2.1 Limits of Conducted Emission Measurement

Frequency (MHz)	Conducted Limit (dBuV)	
	Quasi-Peak	Average
0.15 - 0.5	66 - 56	56 - 46
0.50 - 5.0	56	46
5.0 - 30.0	60	50

- Note: 1. The lower limit shall apply at the transition frequencies.
 2. The limit decreases in line with the logarithm of the frequency in the range of 0.15 to 0.50 MHz.

4.2.2 Test Instruments

Description & Manufacturer	Model No.	Serial No.	Date of Calibration	Due Date of Calibration
Test Receiver ROHDE & SCHWARZ	ESCI	100613	Dec. 10, 2018	Dec. 09, 2019
RF signal cable Woken	5D-FB	Cable-cond1-01	Sep. 05, 2019	Sep. 04, 2020
LISN ROHDE & SCHWARZ (EUT)	ENV216	101826	Feb. 21, 2019	Feb. 20, 2020
LISN ROHDE & SCHWARZ (Peripheral)	ESH3-Z5	100311	Aug. 22, 2019	Aug. 21, 2020
Software ADT	BV ADT_Cond_ V7.3.7.4	NA	NA	NA

- Note: 1. The calibration interval of the above test instruments is 12 months and the calibrations are traceable to NML/ROC and NIST/USA.
 2. The test was performed in HwaYa Shielded Room 1.
 3. The VCCI Site Registration No. is C-12040.

4.2.3 Test Procedures

- a. The EUT was placed 0.4 meters from the conducting wall of the shielded room with EUT being connected to the power mains through a line impedance stabilization network (LISN). Other support units were connected to the power mains through another LISN. The two LISNs provide 50 ohm/50 uH of coupling impedance for the measuring instrument.
- b. Both lines of the power mains connected to the EUT were checked for maximum conducted interference.
- c. The frequency range from 150 kHz to 30 MHz was searched. Emission levels under (Limit – 20 dB) was not recorded.

Note: The resolution bandwidth and video bandwidth of test receiver is 9 kHz for quasi-peak detection (QP) and average detection (AV) at frequency 0.15 MHz – 30 MHz.

4.2.4 Deviation from Test Standard

No deviation.

4.2.5 Test Setup

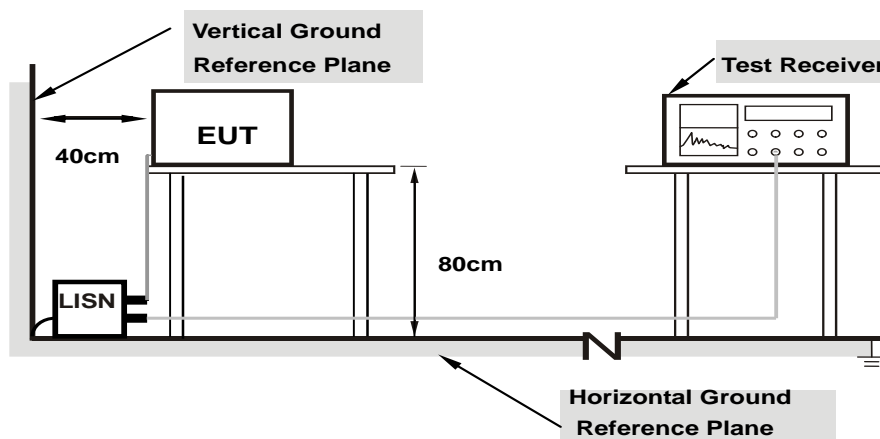

Note: 1.Support units were connected to second LISN.

For the actual test configuration, please refer to the attached file (Test Setup Photo).

4.2.6 EUT Operating Conditions

- a. Placed the EUT on a testing table.
- b. Use the software to control the EUT under transmission condition continuously at specific channel frequency.

4.2.7 Test Results

Frequency Range	150kHz ~ 30MHz	Detector Function & Resolution Bandwidth	Quasi-Peak (QP) / Average (AV), 9kHz
Input Power	120Vac, 60Hz	Environmental Conditions	25°C, 65%RH
Tested by	Thomas Wei	Test Date	2019/9/20

Phase Of Power : Line (L)										
No	Frequency (MHz)	Correction Factor (dB)	Reading Value (dBuV)		Emission Level (dBuV)		Limit (dBuV)		Margin (dB)	
			Q.P.	AV.	Q.P.	AV.	Q.P.	AV.	Q.P.	AV.
1	0.16569	9.73	32.78	33.89	42.51	43.62	65.17	55.17	-22.66	-11.55
2	0.18910	9.76	29.22	19.65	38.98	29.41	64.08	54.08	-25.10	-24.67
3	0.25948	9.82	26.69	18.45	36.51	28.27	61.45	51.45	-24.94	-23.18
4	0.40024	9.90	27.96	20.20	37.86	30.10	57.85	47.85	-19.99	-17.75
5	3.80194	10.18	17.94	9.71	28.12	19.89	56.00	46.00	-27.88	-26.11
6	10.55842	10.33	14.25	6.46	24.58	16.79	60.00	50.00	-35.42	-33.21

Remarks:

1. Q.P. and AV. are abbreviations of quasi-peak and average individually.
2. The emission levels of other frequencies were very low against the limit.
3. Margin value = Emission level – Limit value
4. Correction factor = Insertion loss + Cable loss
5. Emission Level = Correction Factor + Reading Value

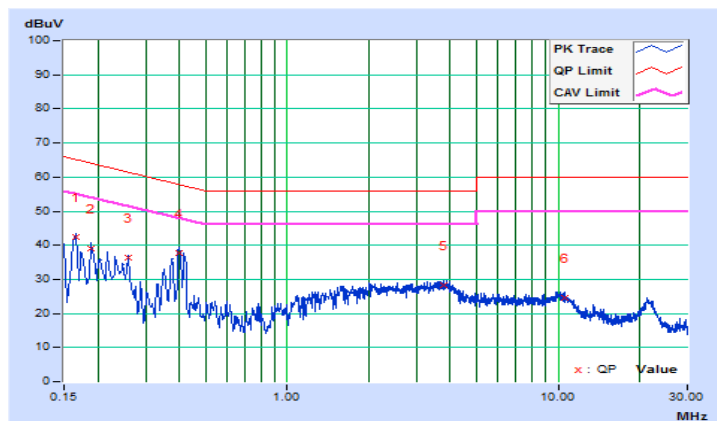

Frequency Range	150kHz ~ 30MHz	Detector Function & Resolution Bandwidth	Quasi-Peak (QP) / Average (AV), 9kHz
Input Power	120Vac, 60Hz	Environmental Conditions	25°C, 65%RH
Tested by	Thomas Wei	Test Date	2019/9/20

Phase Of Power : Neutral (N)										
No	Frequency (MHz)	Correction Factor (dB)	Reading Value (dBuV)		Emission Level (dBuV)		Limit (dBuV)		Margin (dB)	
			Q.P.	AV.	Q.P.	AV.	Q.P.	AV.	Q.P.	AV.
1	0.15391	9.69	33.17	20.43	42.86	30.12	65.79	55.79	-22.93	-25.67
2	0.16967	9.73	30.86	17.54	40.59	27.27	64.98	54.98	-24.39	-27.71
3	0.25796	9.82	21.26	13.14	31.08	22.96	61.50	51.50	-30.42	-28.54
4	0.39844	9.86	25.60	19.73	35.46	29.59	57.89	47.89	-22.43	-18.30
5	1.61625	10.01	15.93	5.88	25.94	15.89	56.00	46.00	-30.06	-30.11
6	3.84886	10.12	17.66	9.55	27.78	19.67	56.00	46.00	-28.22	-26.33

Remarks:

1. Q.P. and AV. are abbreviations of quasi-peak and average individually.
2. The emission levels of other frequencies were very low against the limit.
3. Margin value = Emission level – Limit value
4. Correction factor = Insertion loss + Cable loss
5. Emission Level = Correction Factor + Reading Value

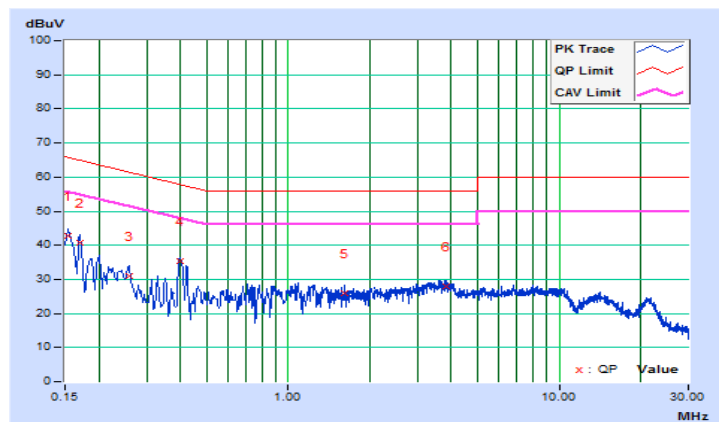

4.3 6 dB Bandwidth Measurement

4.3.1 Limits of 6 dB Bandwidth Measurement

The minimum of 6 dB Bandwidth Measurement is 0.5 MHz.

4.3.2 Test Setup

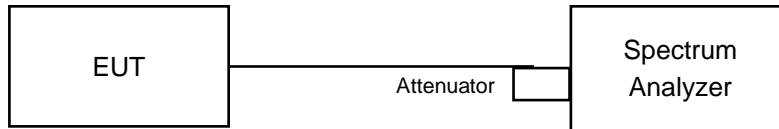

4.3.3 Test Instruments

Refer to section 4.1.2 to get information of above instrument.

4.3.4 Test Procedure

- Set resolution bandwidth (RBW) = 100 kHz
- Set the video bandwidth (VBW) $\geq 3 \times$ RBW, Detector = Peak.
- Trace mode = max hold.
- Sweep = auto couple.
- Measure the maximum width of the emission that is constrained by the frequencies associated with the two amplitude points (upper and lower) that are attenuated by 6 dB relative to the maximum level measured in the fundamental emission

4.3.5 Deviation from Test Standard

No deviation.

4.3.6 EUT Operating Conditions

The software provided by client to enable the EUT under transmission condition continuously at lowest, middle and highest channel frequencies individually.

4.3.7 Test Results

802.11b

Channel	Frequency (MHz)	6 dB Bandwidth (MHz)		Minimum Limit (MHz)	Pass / Fail
		Chain 0	Chain 1		
1	2412	10.14	10.13	0.5	Pass
6	2437	10.12	10.14	0.5	Pass
11	2462	10.12	10.10	0.5	Pass

802.11g

Channel	Frequency (MHz)	6 dB Bandwidth (MHz)		Minimum Limit (MHz)	Pass / Fail
		Chain 0	Chain 1		
1	2412	16.40	16.37	0.5	Pass
6	2437	16.39	16.34	0.5	Pass
11	2462	16.38	16.41	0.5	Pass

802.11n (HT20)

Channel	Frequency (MHz)	6 dB Bandwidth (MHz)		Minimum Limit (MHz)	Pass / Fail
		Chain 0	Chain 1		
1	2412	16.96	17.60	0.5	Pass
6	2437	16.81	17.58	0.5	Pass
11	2462	17.31	16.97	0.5	Pass

802.11n (HT40)

Channel	Frequency (MHz)	6 dB Bandwidth (MHz)		Minimum Limit (MHz)	Pass / Fail
		Chain 0	Chain 1		
3	2422	35.45	35.87	0.5	Pass
6	2437	36.09	35.34	0.5	Pass
9	2452	35.87	36.11	0.5	Pass

Spectrum Plot of Worst Value

802.11b

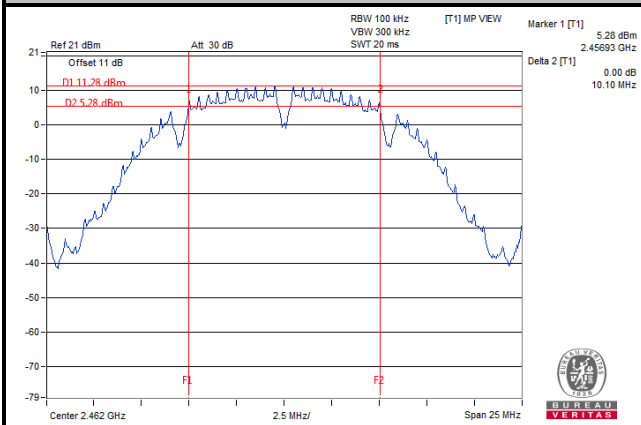

802.11g

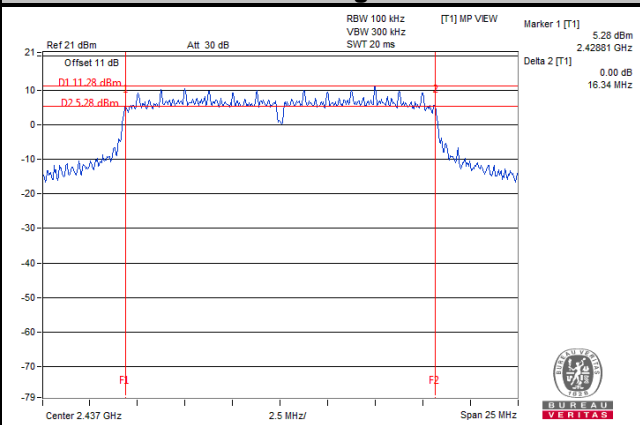

802.11n (HT20)

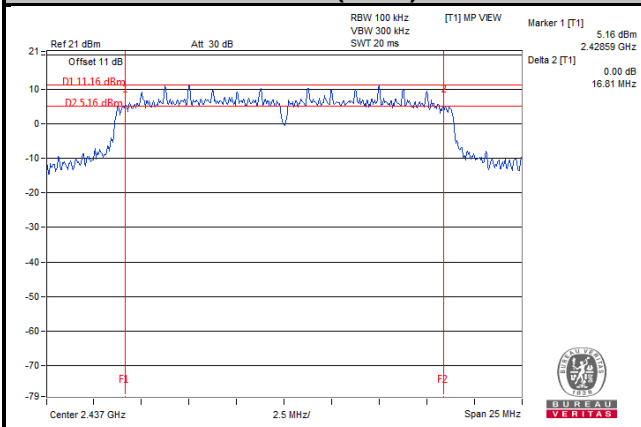

802.11n (HT40)

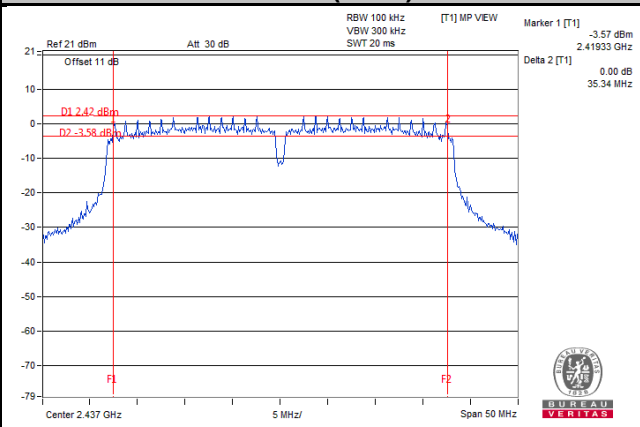

4.4 Occupied Bandwidth Measurement

4.4.1 Test Setup

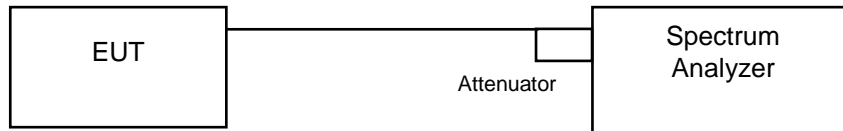

4.4.2 Test Instruments

Refer to section 4.1.2 to get information of above instrument.

4.4.3 Test Procedure

The transmitter output was connected to the spectrum analyzer through an attenuator. The bandwidth of the fundamental frequency was measured by spectrum analyzer with resolution bandwidth in the range of 1 % to 5 % of the anticipated emission bandwidth, and a video bandwidth at least 3x the resolution bandwidth and set the detector to PEAK. The width of a frequency band such that, below the lower and above the upper frequency limits, the mean powers emitted are each equal to a specified percentage 0.5 % of the total mean power of a given emission.

4.4.4 Deviation from Test Standard

No deviation.

4.4.5 EUT Operating Conditions

The software provided by client to enable the EUT under transmission condition continuously at lowest, middle and highest channel frequencies individually.

4.4.6 Test Results

802.11b

Channel	Frequency (MHz)	Occupied Bandwidth (MHz)		Pass / Fail
		Chain 0	Chain 1	
1	2412	14.88	14.76	Pass
6	2437	15.24	15.00	Pass
11	2462	14.16	14.04	Pass

802.11g

Channel	Frequency (MHz)	Occupied Bandwidth (MHz)		Pass / Fail
		Chain 0	Chain 1	
1	2412	16.68	16.56	Pass
6	2437	18.12	17.40	Pass
11	2462	16.68	16.68	Pass

802.11n (HT20)

Channel	Frequency (MHz)	Occupied Bandwidth (MHz)		Pass / Fail
		Chain 0	Chain 1	
1	2412	17.76	17.76	Pass
6	2437	20.16	18.60	Pass
11	2462	17.88	17.88	Pass

802.11n (HT40)

Channel	Frequency (MHz)	Occupied Bandwidth (MHz)		Pass / Fail
		Chain 0	Chain 1	
3	2422	36.72	36.72	Pass
6	2437	36.72	36.60	Pass
9	2452	36.72	36.72	Pass

Spectrum Plot of Worst Value

802.11b

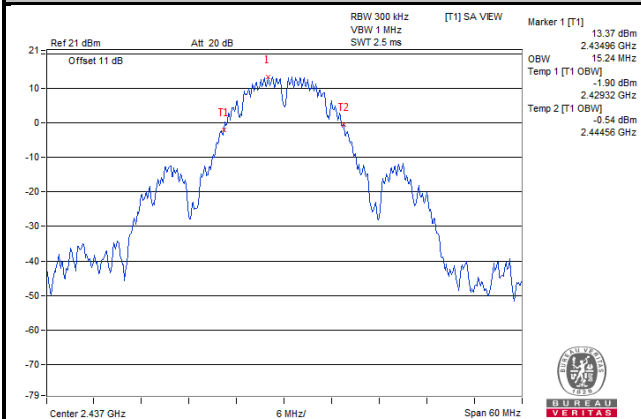

802.11g

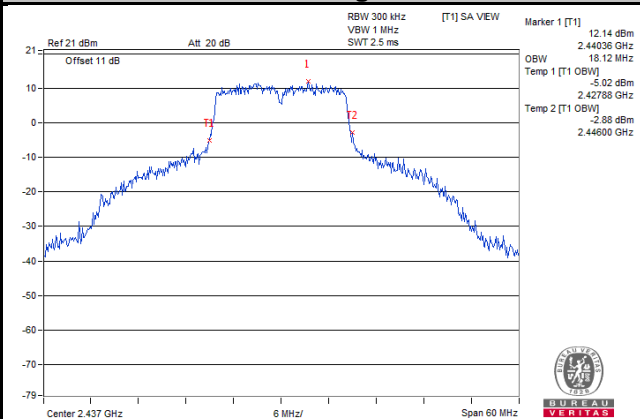

802.11n (HT20)

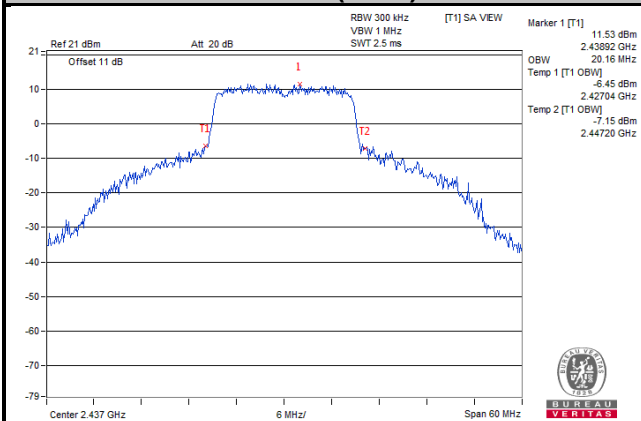

802.11n (HT40)

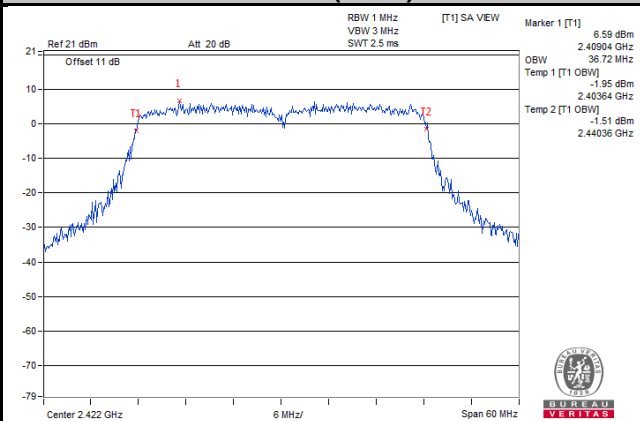

4.5 Conducted Output Power Measurement

4.5.1 Limits of Conducted Output Power Measurement

For systems using digital modulation in the 2400–2483.5 MHz bands: 1 Watt (30 dBm)

Per KDB 662911 D01 Multiple Transmitter Output Method of conducted output power measurement on IEEE 802.11 devices,

Array Gain = 0 dB (i.e., no array gain) for NANT \leq 4;

Array Gain = 0 dB (i.e., no array gain) for channel widths \geq 40 MHz for any NANT;

Array Gain = $5 \log(\text{NANT}/\text{NSS})$ dB or 3 dB, whichever is less for 20 MHz channel widths with NANT \geq 5.

For power measurements on all other devices: Array Gain = $10 \log(\text{NANT}/\text{NSS})$ dB.

4.5.2 Test Setup

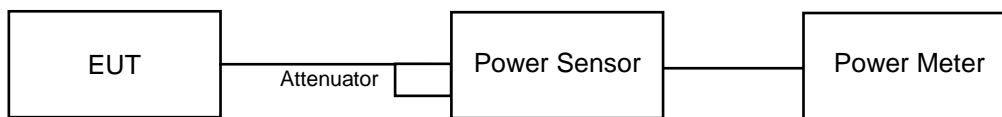

4.5.3 Test Instruments

Refer to section 4.1.2 to get information of above instrument.

4.5.4 Test Procedures

Average power sensor was used to perform output power measurement, trigger and gating function of wide band power meter is enabled to measure max output power of TX on burst. Duty factor is not added to measured value.

4.5.5 Deviation from Test Standard

No deviation.

4.5.6 EUT Operating Conditions

The software provided by client to enable the EUT under transmission condition continuously at lowest, middle and highest channel frequencies individually.

4.5.7 Test Results

802.11b

Channel	Frequency (MHz)	Average Power (dBm)		Total Power (mW)	Total Power (dBm)	Limit (dBm)	Pass / Fail
		Chain 0	Chain 1				
1	2412	23.63	23.52	455.58	26.59	30	Pass
6	2437	23.94	23.77	485.974	26.87	30	Pass
11	2462	21.04	20.96	251.795	24.01	30	Pass

802.11g

Channel	Frequency (MHz)	Average Power (dBm)		Total Power (mW)	Total Power (dBm)	Limit (dBm)	Pass / Fail
		Chain 0	Chain 1				
1	2412	17.21	17.00	102.721	20.12	30	Pass
6	2437	21.85	21.79	304.117	24.83	30	Pass
11	2462	15.59	15.57	72.282	18.59	30	Pass

802.11n (HT20)

Channel	Frequency (MHz)	Average Power (dBm)		Total Power (mW)	Total Power (dBm)	Limit (dBm)	Pass / Fail
		Chain 0	Chain 1				
1	2412	17.56	17.50	113.25	20.54	30	Pass
6	2437	22.12	22.06	323.624	25.10	30	Pass
11	2462	15.39	15.37	69.029	18.39	30	Pass

802.11n (HT40)

Channel	Frequency (MHz)	Peak Power (dBm)		Total Power (mW)	Total Power (dBm)	Limit (dBm)	Pass / Fail
		Chain 0	Chain 1				
3	2422	14.27	14.12	52.553	17.21	30	Pass
6	2437	17.17	16.96	101.778	20.08	30	Pass
9	2452	10.94	10.84	24.551	13.90	30	Pass

4.6 Power Spectral Density Measurement

4.6.1 Limits of Power Spectral Density Measurement

The Maximum of Power Spectral Density Measurement is 8 dBm in any 3 kHz band during any time interval of continuous transmission.

4.6.2 Test Setup

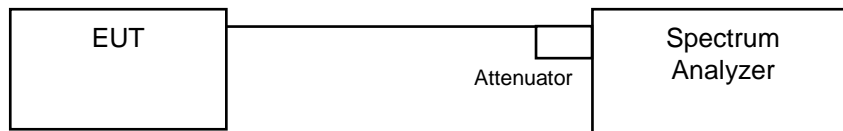

4.6.3 Test Instruments

Refer to section 4.1.2 to get information of above instrument.

4.6.4 Test Procedure

- a. Set analyzer center frequency to DTS channel center frequency.
- b. Set the span to 1.5 times the DTS bandwidth.
- c. Set the RBW to: $3 \text{ kHz} \leq \text{RBW} \leq 100 \text{ kHz}$.
- d. Set the VBW $\geq 3 \times \text{RBW}$.
- e. Detector = peak.
- f. Sweep time = auto couple.
- g. Trace mode = max hold.
- h. Allow trace to fully stabilize.
- i. Use the peak marker function to determine the maximum amplitude level within the RBW.

4.6.5 Deviation from Test Standard

No deviation.

4.6.6 EUT Operating Condition

The software provided by client to enable the EUT under transmission condition continuously at lowest, middle and highest channel frequencies individually.

4.6.7 Test Results

802.11b

TX Chain	Channel	Freq. (MHz)	PSD (dBm/3 kHz)	10 log (N=2) dB	Total PSD (dBm/3 kHz)	Limit (dBm/3 kHz)	Pass / Fail
0	1	2412	-6.91	3.01	-3.90	8	Pass
	6	2437	-6.33	3.01	-3.32	8	Pass
	11	2462	-8.92	3.01	-5.91	8	Pass
1	1	2412	-6.37	3.01	-3.36	8	Pass
	6	2437	-6.30	3.01	-3.29	8	Pass
	11	2462	-9.87	3.01	-6.86	8	Pass

NOTE:

1. Directional gain = $2.7 \text{ dBi} + 10\log(2) = 5.71 \text{ dBi} < 6 \text{ dBi}$, so the limit no need to be reduced.
2. Method 2) a) of power density measurement of KDB 662911 is using for calculating total power density. Total power density is summing entire spectra across corresponding frequency bins on the various outputs by computer.

802.11g

TX Chain	Channel	Freq. (MHz)	PSD (dBm/3 kHz)	10 log (N=2) dB	Total PSD (dBm/3 kHz)	Limit (dBm/3 kHz)	Pass / Fail
0	1	2412	-15.15	3.01	-11.80	8	Pass
	6	2437	-10.77	3.01	-7.42	8	Pass
	11	2462	-16.89	3.01	-13.54	8	Pass
1	1	2412	-15.28	3.01	-11.93	8	Pass
	6	2437	-10.14	3.01	-6.79	8	Pass
	11	2462	-16.79	3.01	-13.44	8	Pass

NOTE:

1. Directional gain = $2.7 \text{ dBi} + 10\log(2) = 5.71 \text{ dBi} < 6 \text{ dBi}$, so the limit no need to be reduced.
2. Method 2) a) of power density measurement of KDB 662911 is using for calculating total power density. Total power density is summing entire spectra across corresponding frequency bins on the various outputs by computer.

802.11n (HT20)

TX Chain	Channel	Freq. (MHz)	PSD (dBm/3 kHz)	10 log (N=2) dB	Total PSD (dBm/3 kHz)	Limit (dBm/3 kHz)	Pass / Fail
0	1	2412	-14.98	3.01	-11.70	8	Pass
	6	2437	-10.46	3.01	-7.18	8	Pass
	11	2462	-17.25	3.01	-13.97	8	Pass
1	1	2412	-14.62	3.01	-11.34	8	Pass
	6	2437	-11.42	3.01	-8.14	8	Pass
	11	2462	-16.49	3.01	-13.21	8	Pass

NOTE:

1. Directional gain = 2.7 dBi + 10log(2) = 5.71 dBi < 6 dBi, so the limit no need to be reduced.
2. Method 2) a) of power density measurement of KDB 662911 is using for calculating total power density. Total power density is summing entire spectra across corresponding frequency bins on the various outputs by computer.

802.11n (HT40)

TX Chain	Channel	Freq. (MHz)	PSD (dBm/3 kHz)	10 log (N=2) dB	Total PSD (dBm/3 kHz)	Limit (dBm/3 kHz)	Pass / Fail
0	3	2422	-21.67	3.01	-18.22	8	Pass
	6	2437	-18.26	3.01	-14.81	8	Pass
	9	2452	-24.54	3.01	-21.09	8	Pass
1	3	2422	-21.00	3.01	-17.55	8	Pass
	6	2437	-18.52	3.01	-15.07	8	Pass
	9	2452	-24.31	3.01	-20.86	8	Pass

NOTE:

1. Directional gain = 2.7 dBi + 10log(2) = 5.71 dBi < 6 dBi, so the limit no need to be reduced.
2. Method 2) a) of power density measurement of KDB 662911 is using for calculating total power density. Total power density is summing entire spectra across corresponding frequency bins on the various outputs by computer.

Spectrum Plot of Worst Value

802.11b

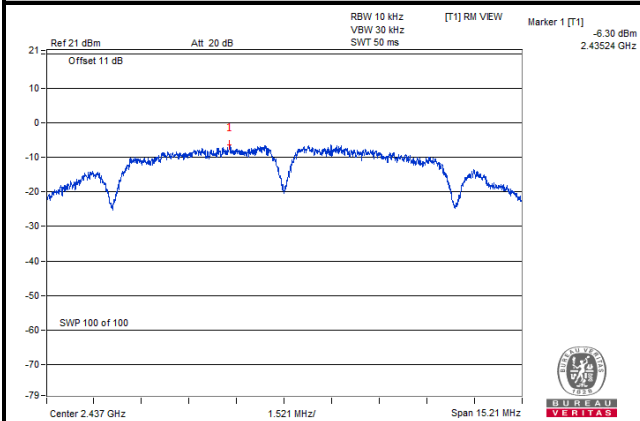

802.11g

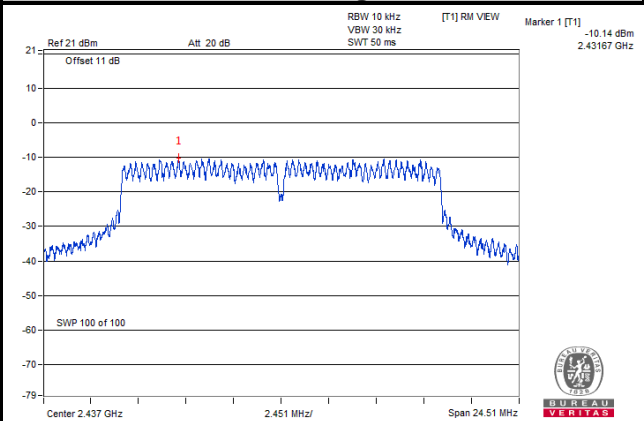

802.11n (HT20)

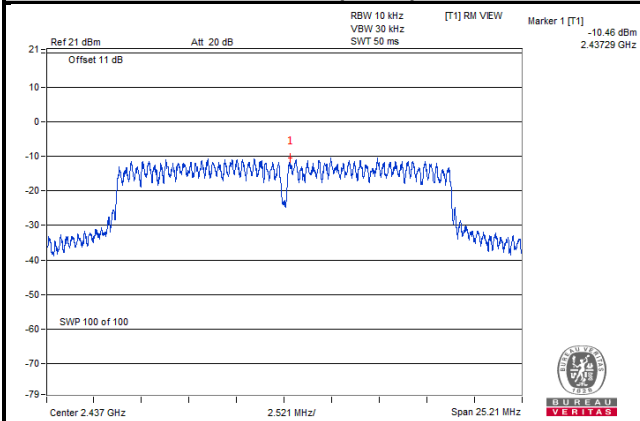

802.11n (HT40)

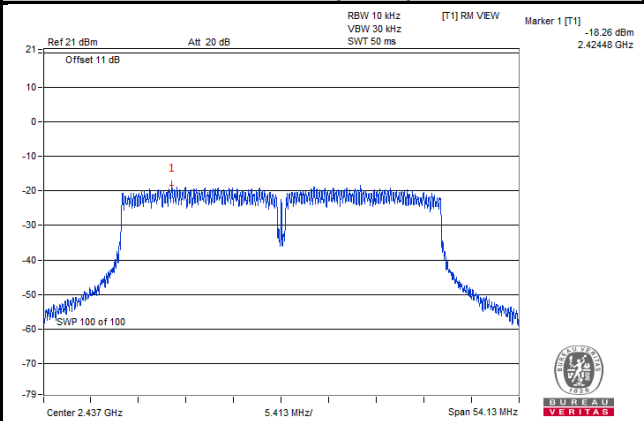

4.7 Conducted Out of Band Emission Measurement

4.7.1 Limits of Conducted Out of Band Emission Measurement

Below -30 dB of the highest emission level of operating band (in 100 kHz Resolution Bandwidth).

4.7.2 Test Setup

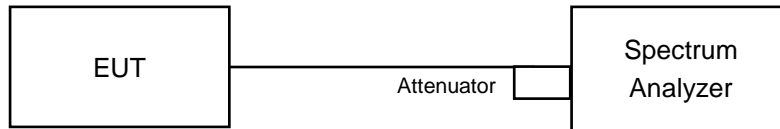

4.7.3 Test Instruments

Refer to section 4.1.2 to get information of above instrument.

4.7.4 Test Procedure

MEASUREMENT PROCEDURE REF

1. Set the RBW = 100 kHz.
2. Set the VBW \geq 300 kHz.
3. Detector = peak.
4. Sweep time = auto couple.
5. Trace mode = max hold.
6. Allow trace to fully stabilize.
7. Use the peak marker function to determine the maximum power level in any 100 kHz band segment within the fundamental EBW.

MEASUREMENT PROCEDURE OOB

1. Set RBW = 100 kHz.
2. Set VBW \geq 300 kHz.
3. Detector = peak.
4. Sweep = auto couple.
5. Trace Mode = max hold.
6. Allow trace to fully stabilize.
7. Use the peak marker function to determine the maximum amplitude level.

4.7.5 Deviation from Test Standard

No deviation.

4.7.6 EUT Operating Condition

The software provided by client to enable the EUT under transmission condition continuously at lowest, middle and highest channel frequencies individually.

4.7.7 Test Results

The spectrum plots are attached on the following images. D1 line indicates the highest level, and D2 line indicates the 30 dB offset below D1. It shows compliance with the requirement.

802.11b CHAIN 0

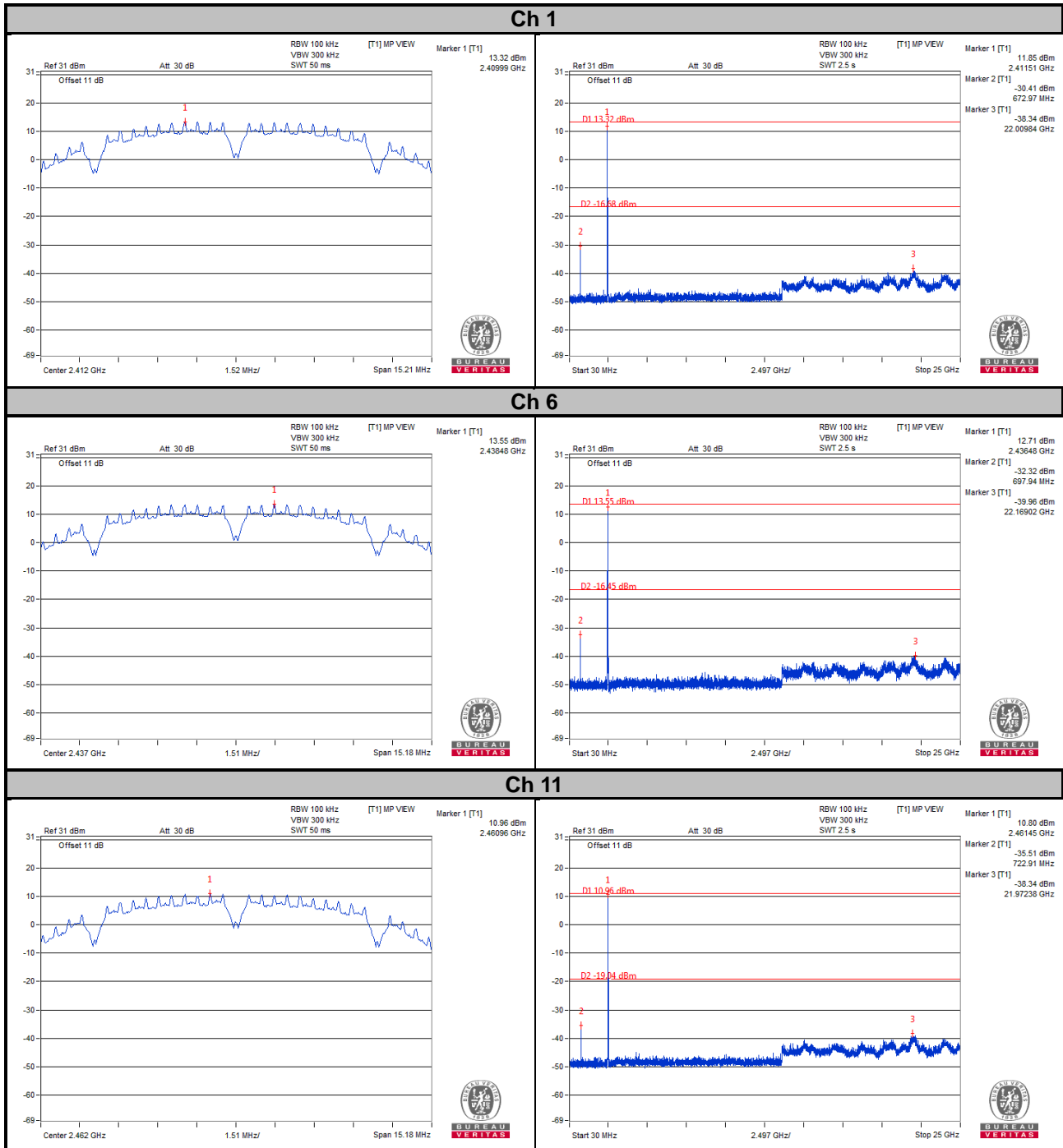

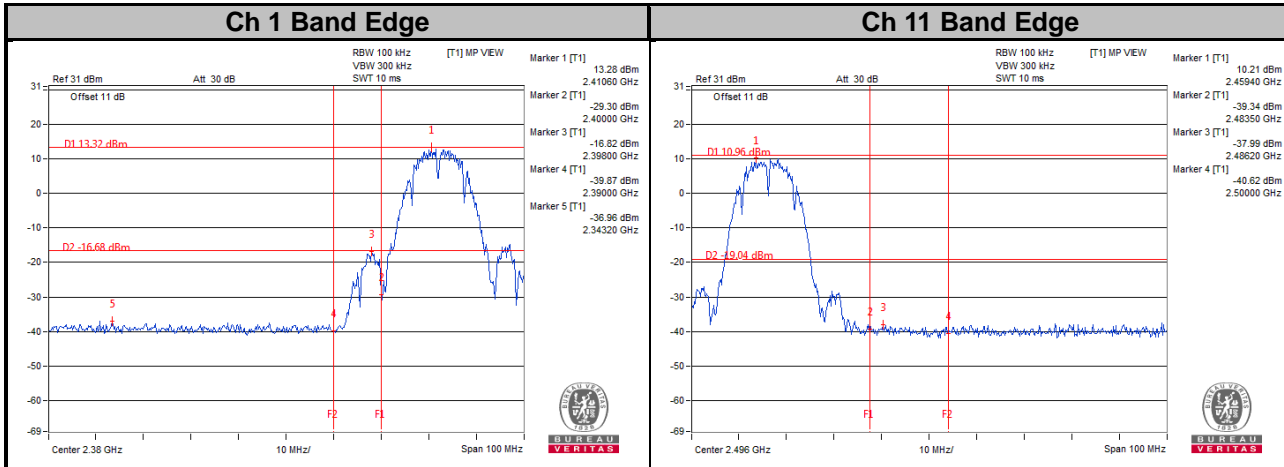

CHAIN 1

Ch 1

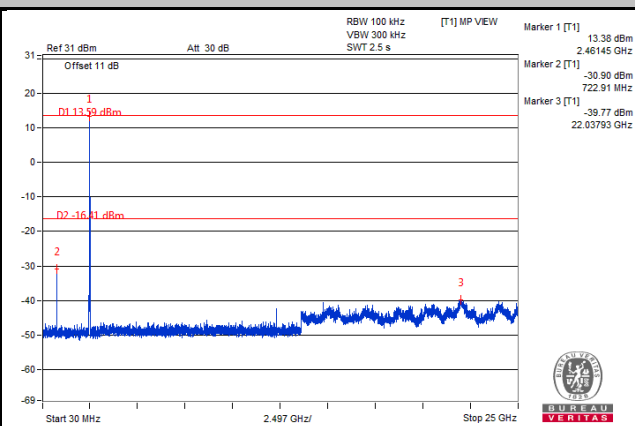
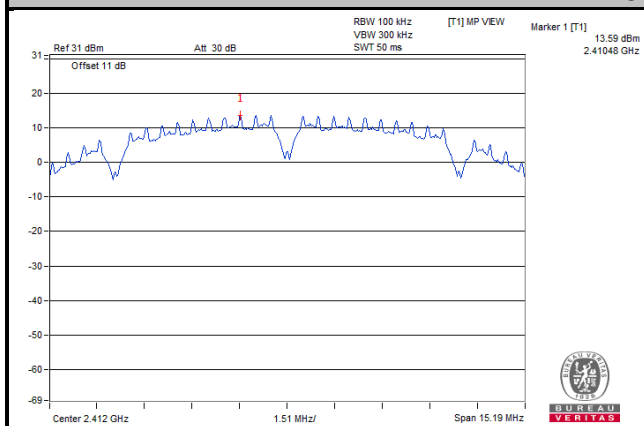

Ch 6

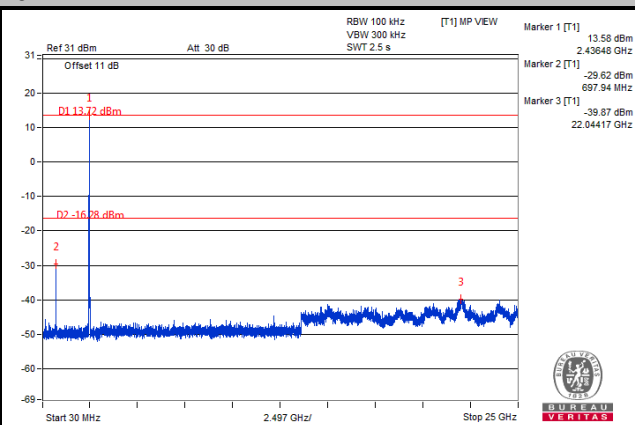
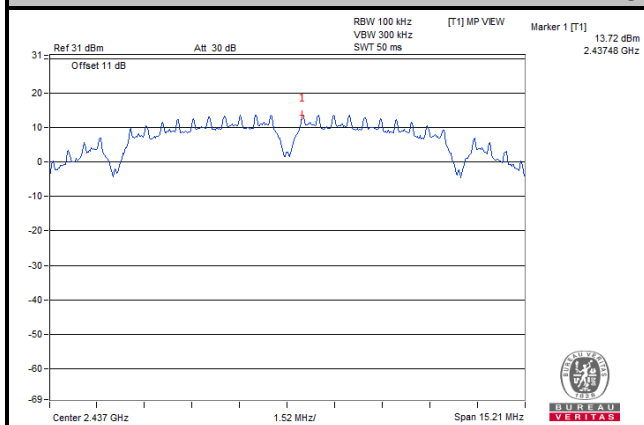

Ch 11

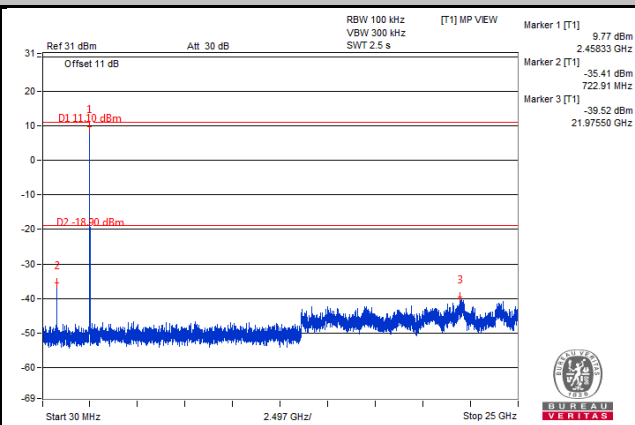
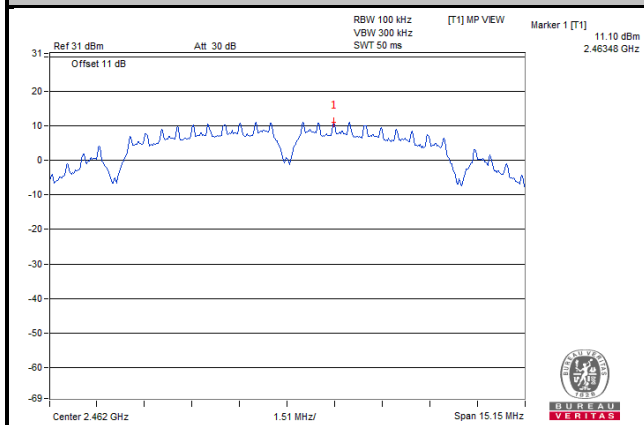

Ch 1 Band Edge

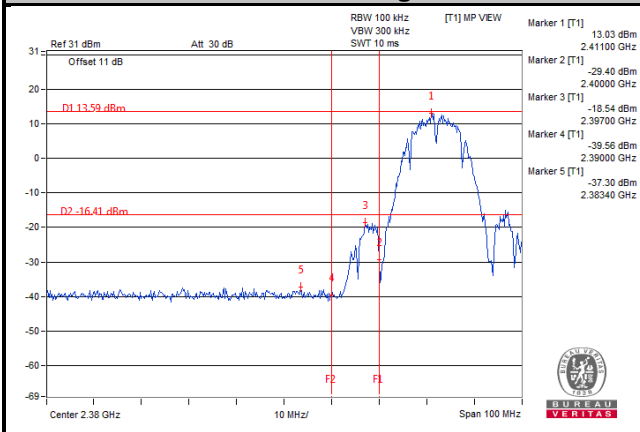

Ch 11 Band Edge

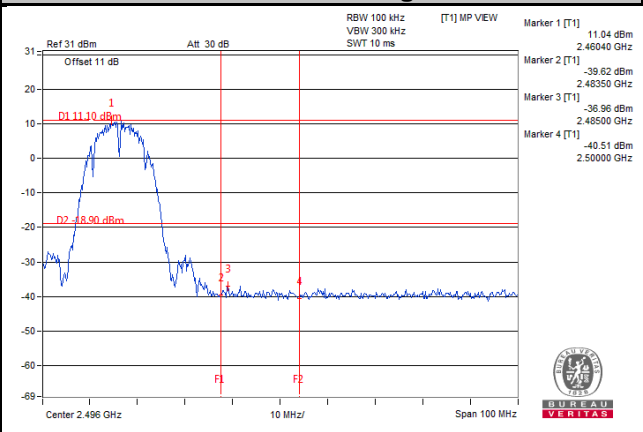

802.11g
CHAIN 0

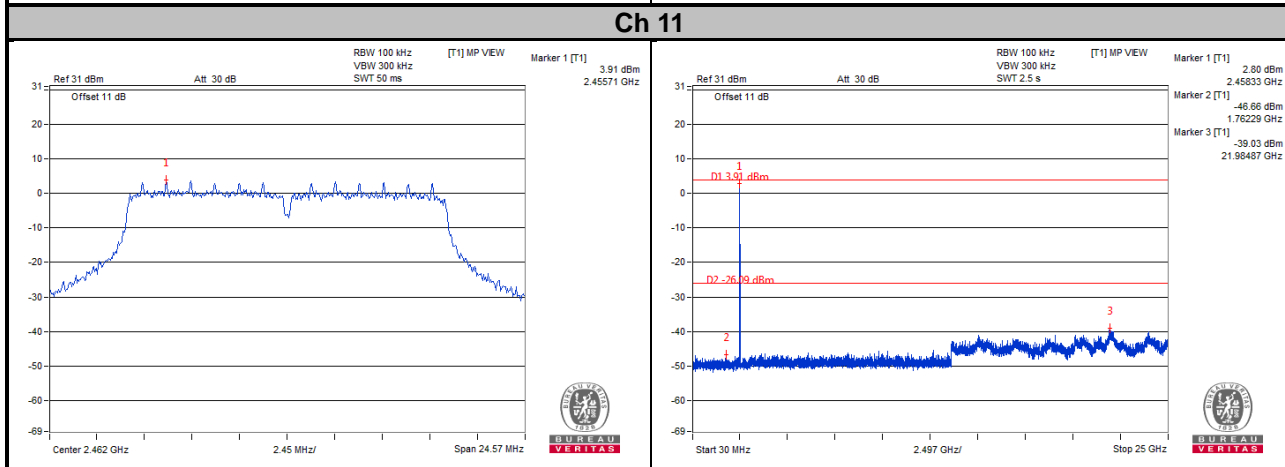
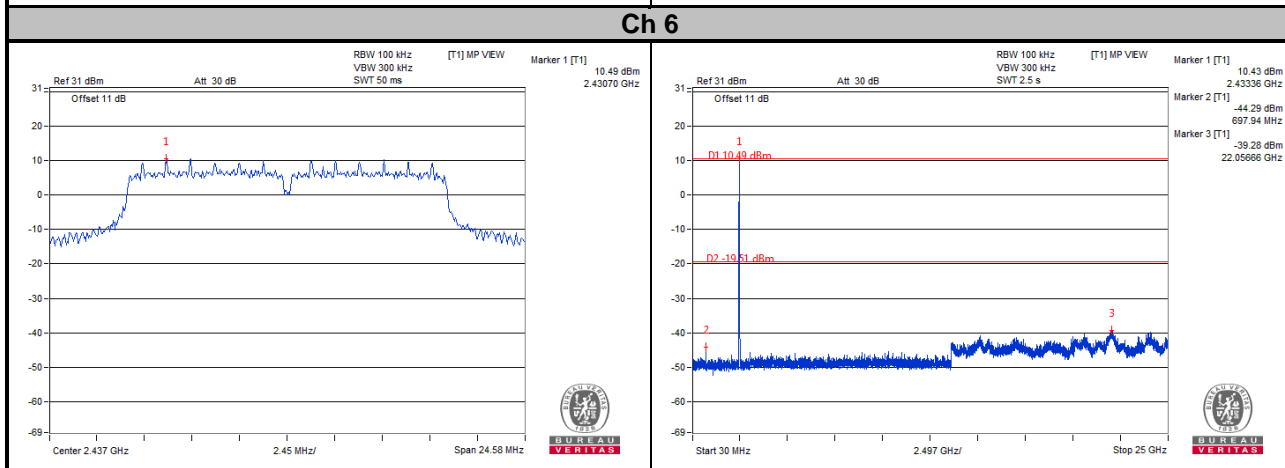
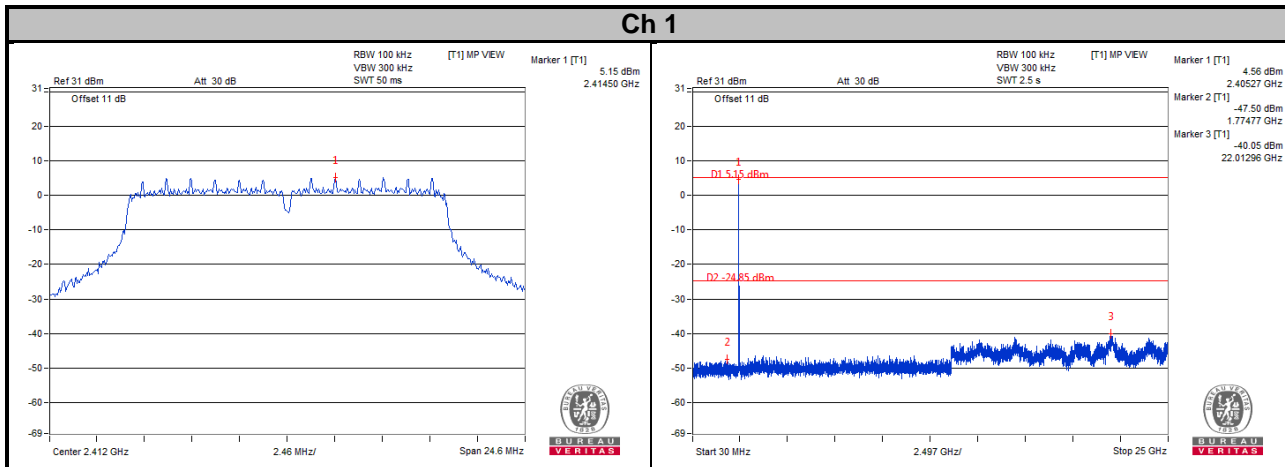

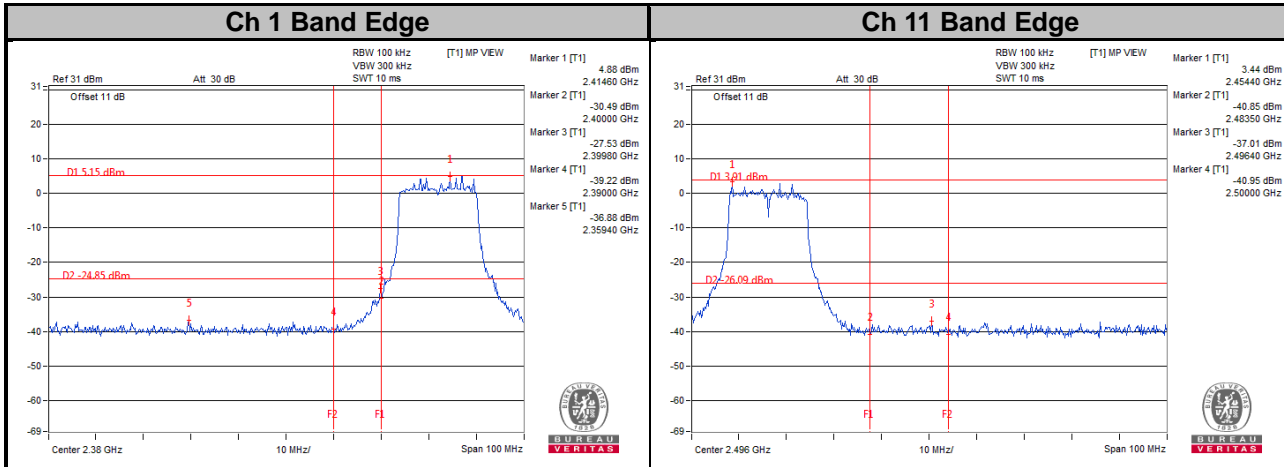

CHAIN 1

Ch 1

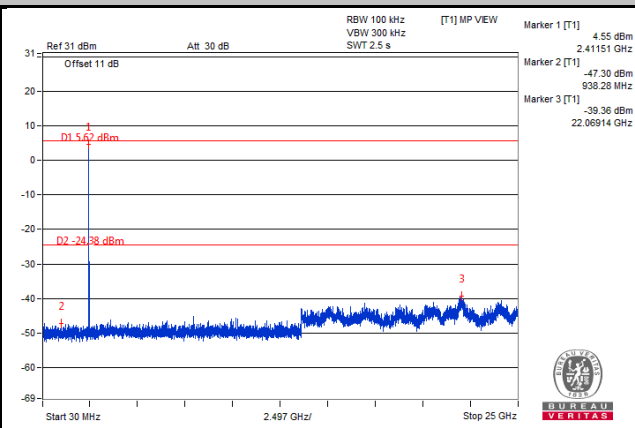
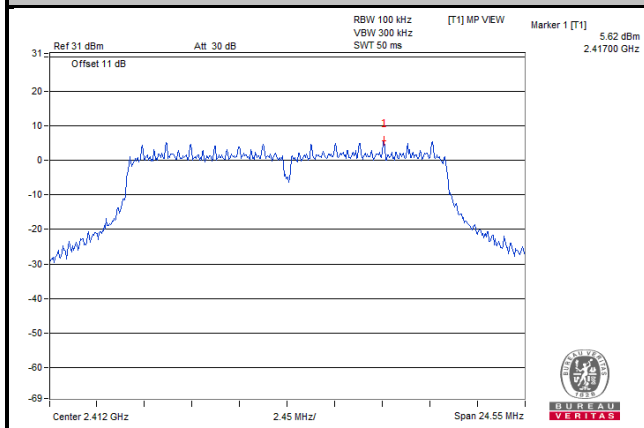

Ch 6

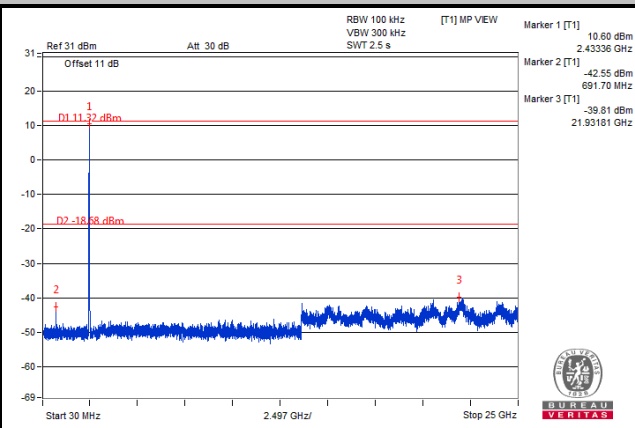
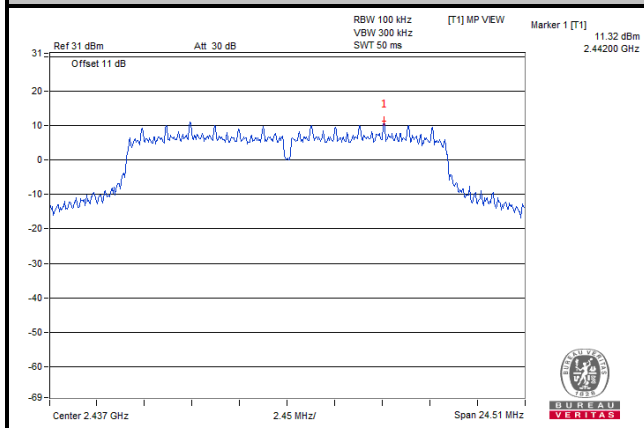

Ch 11

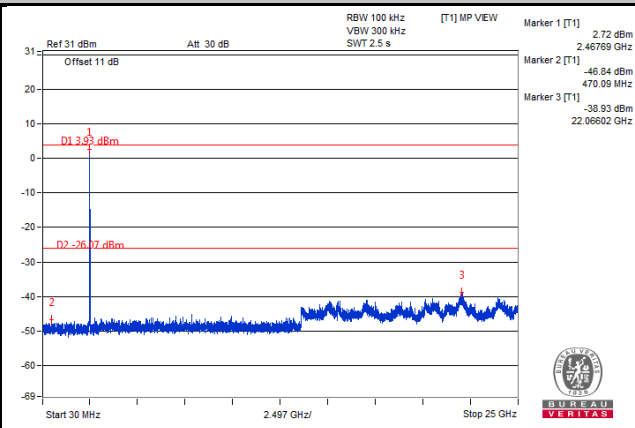
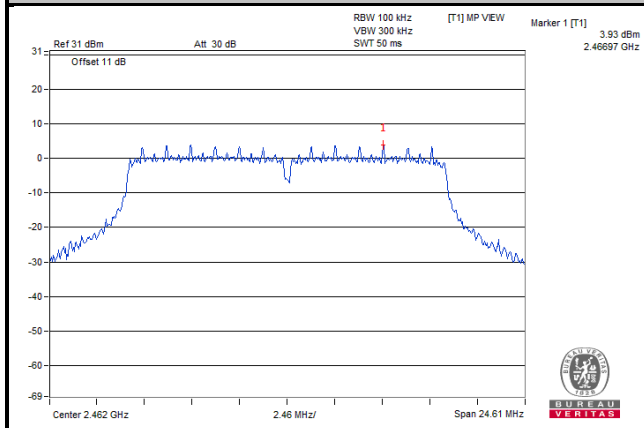

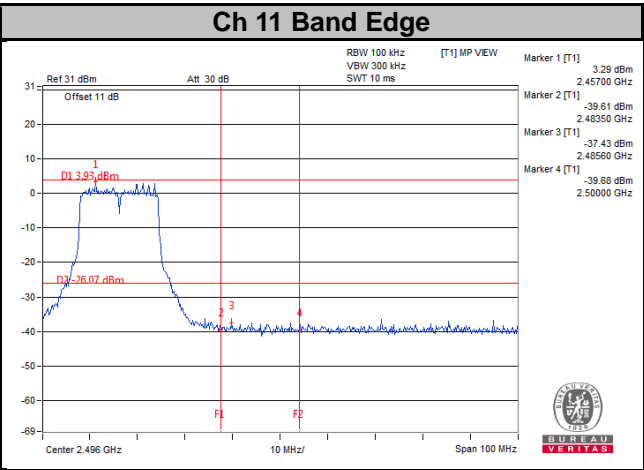
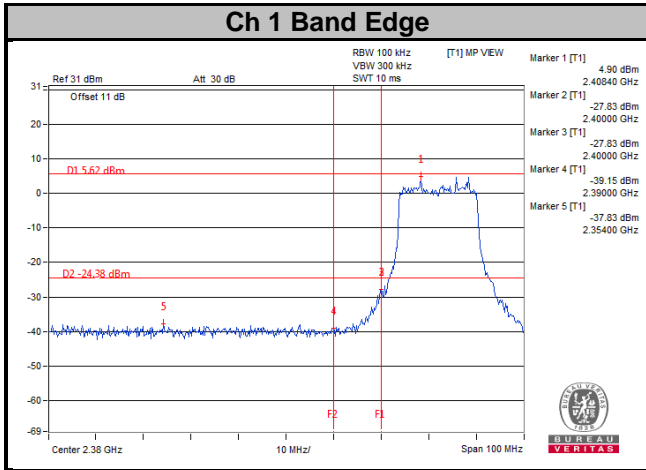

802.11n (HT20)
CHAIN 0

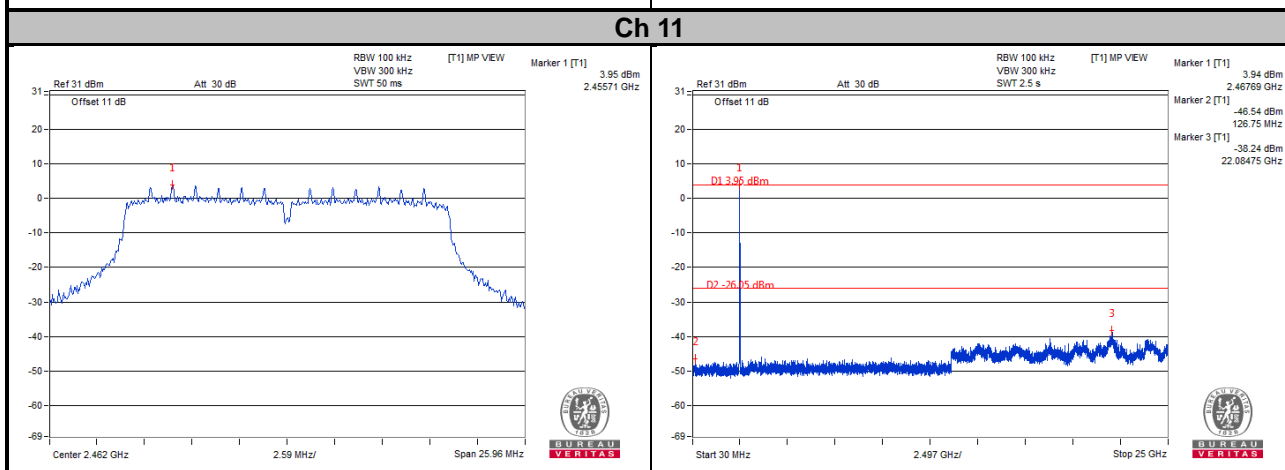
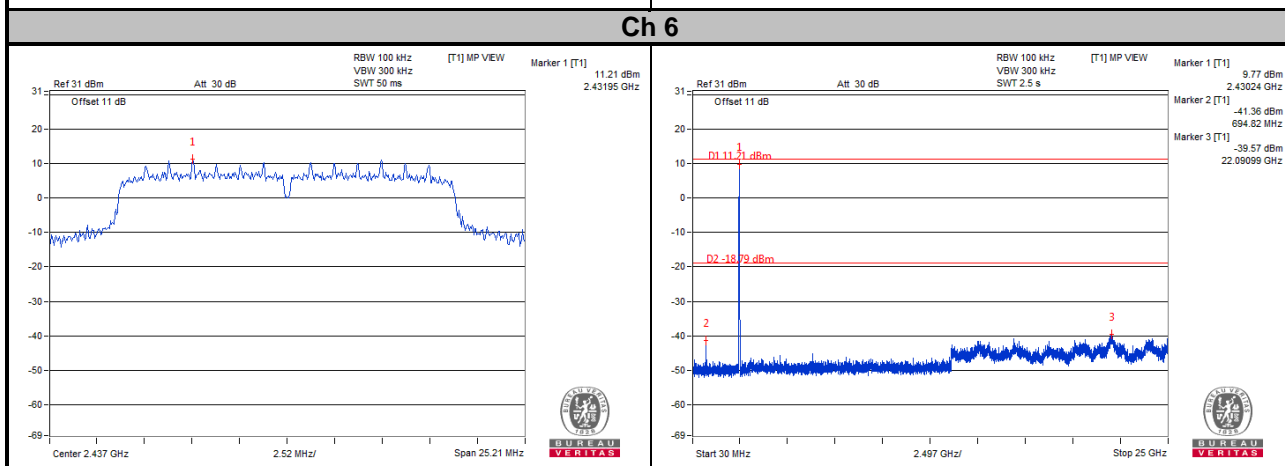
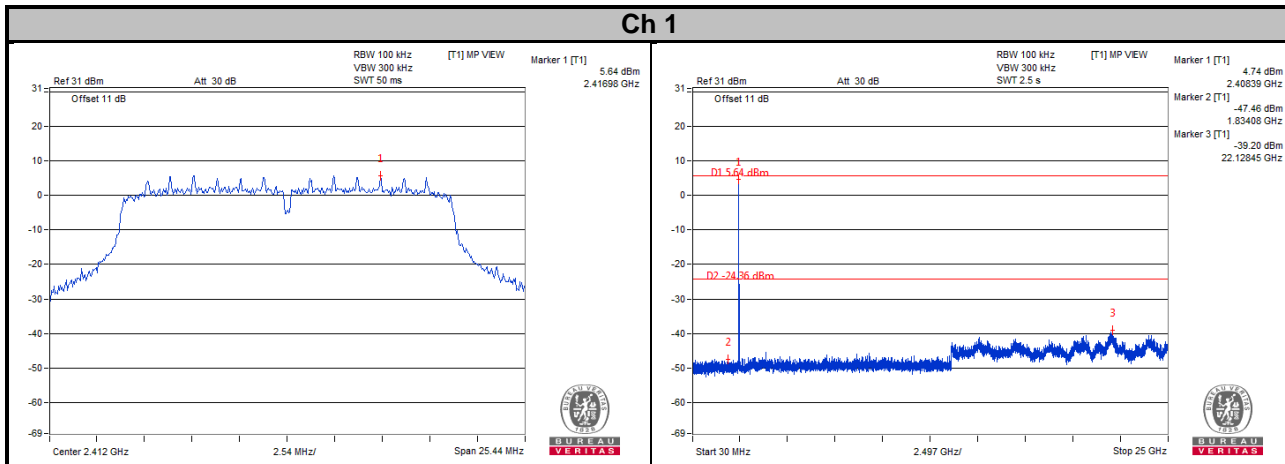

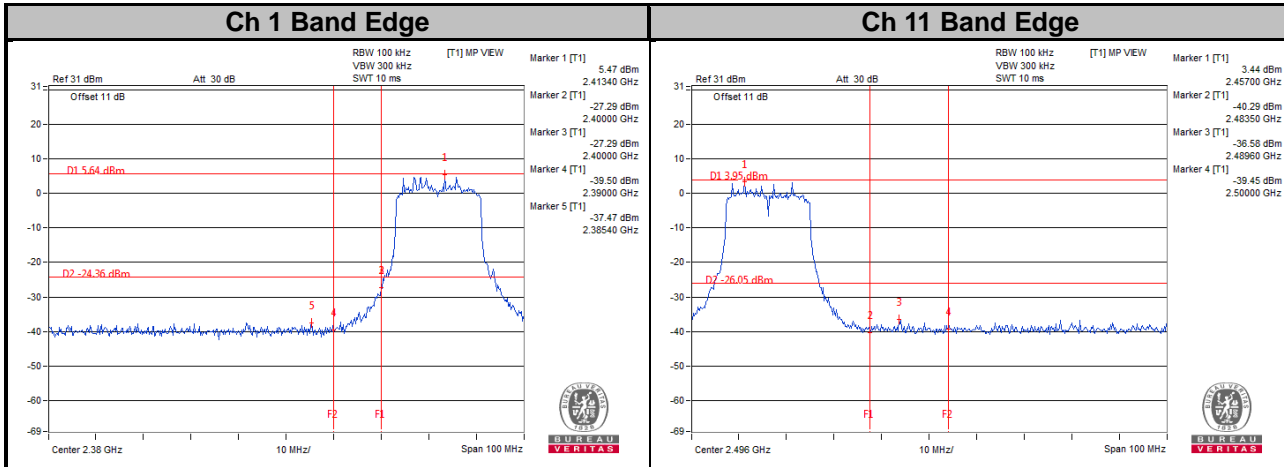

CHAIN 1

Ch 1

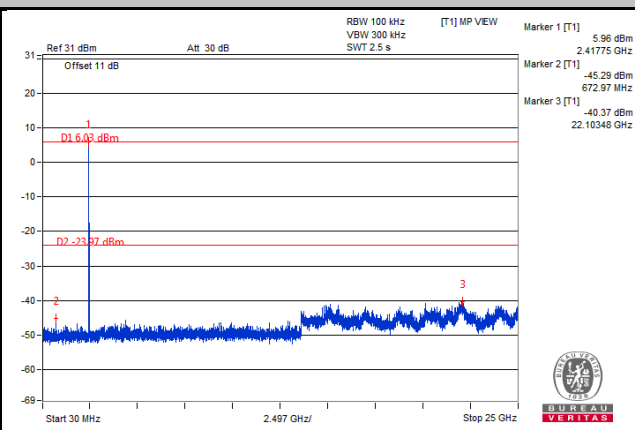
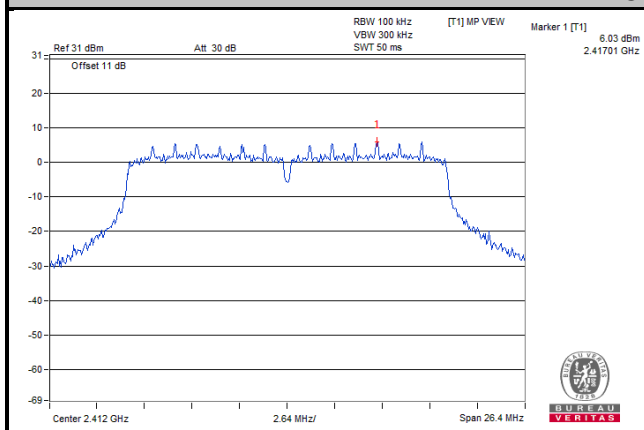

Ch 6

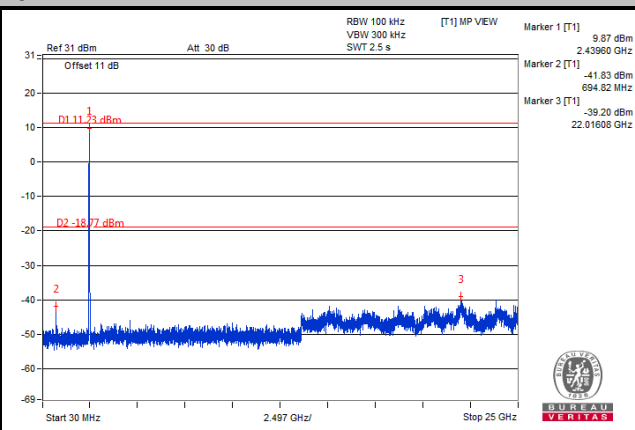
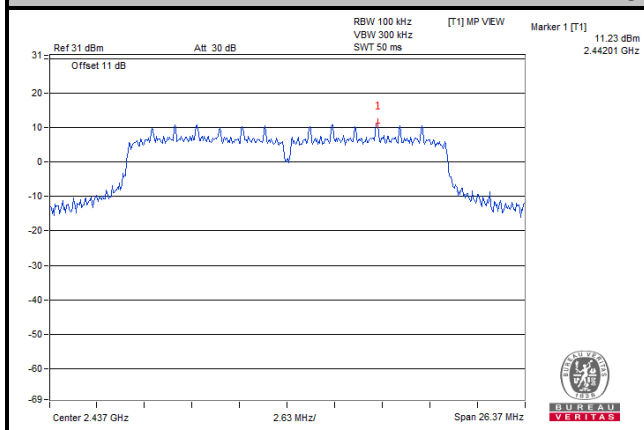

Ch 11

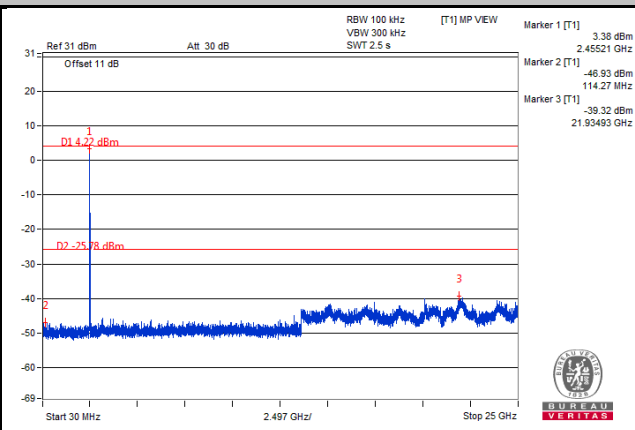
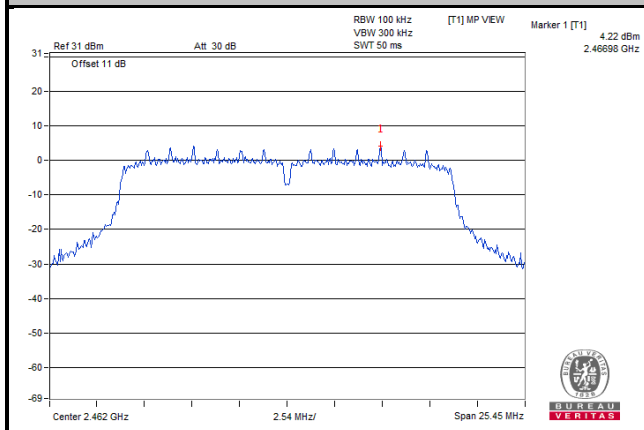

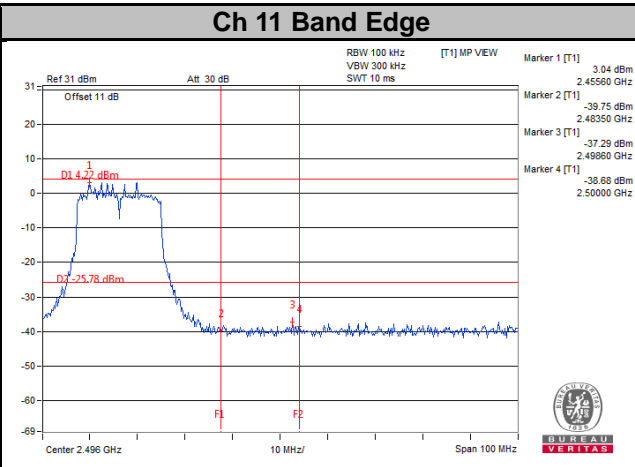
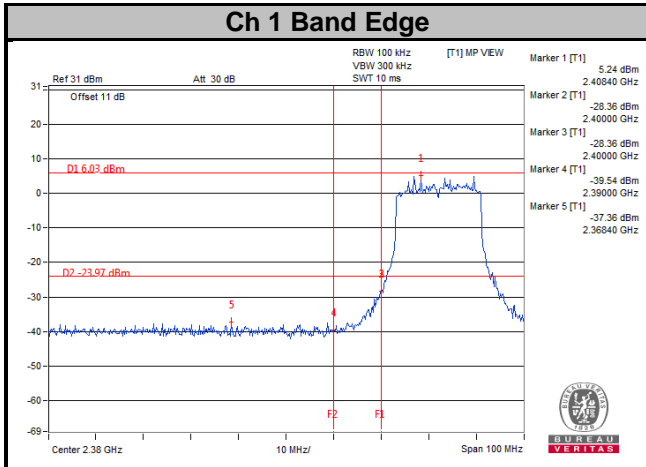

802.11n (HT40)
CHAIN 0

Ch 3

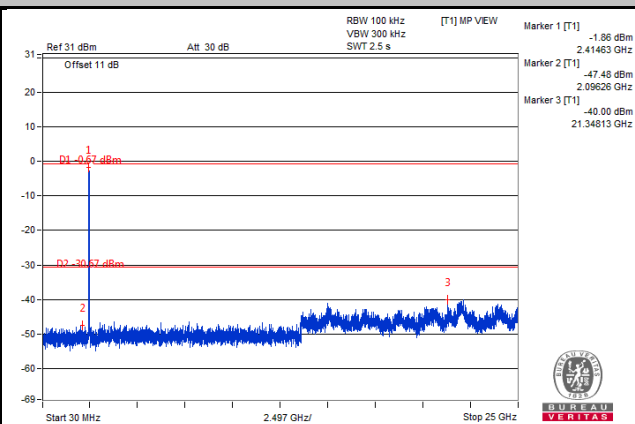
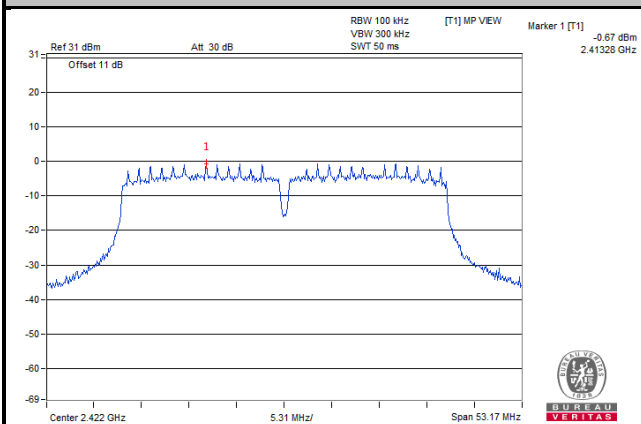

Ch 6

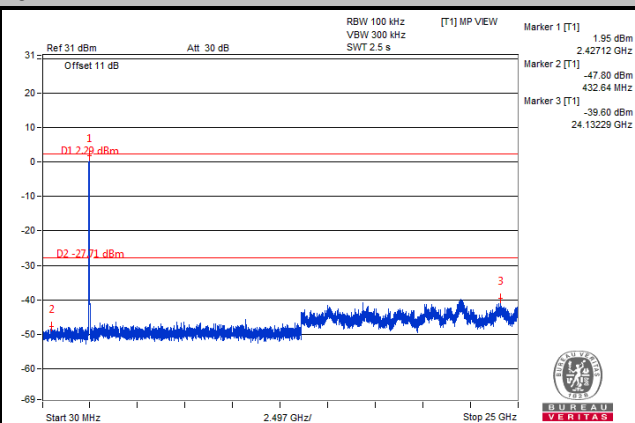
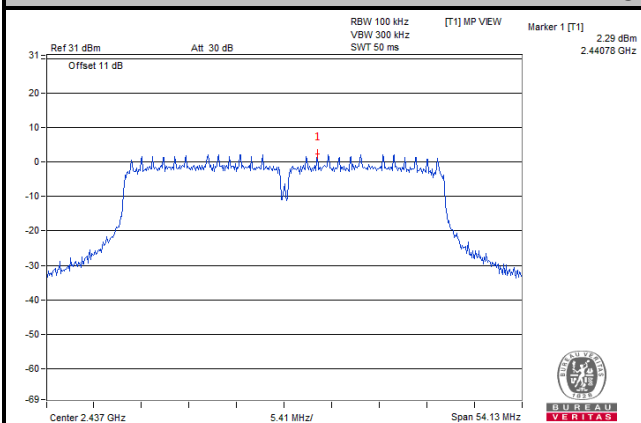

Ch 9

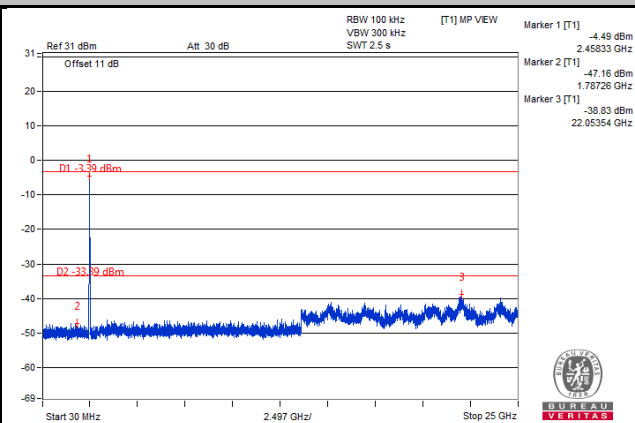
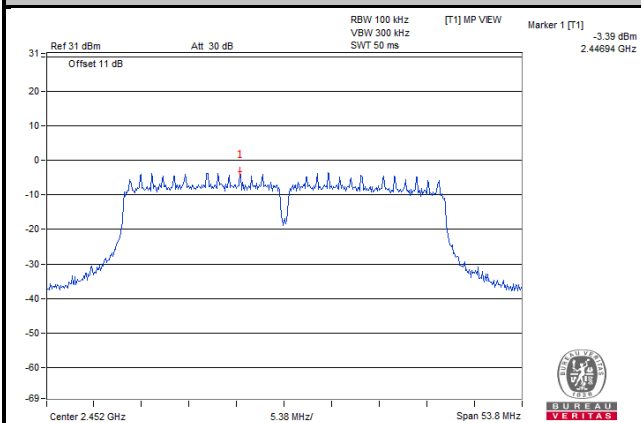

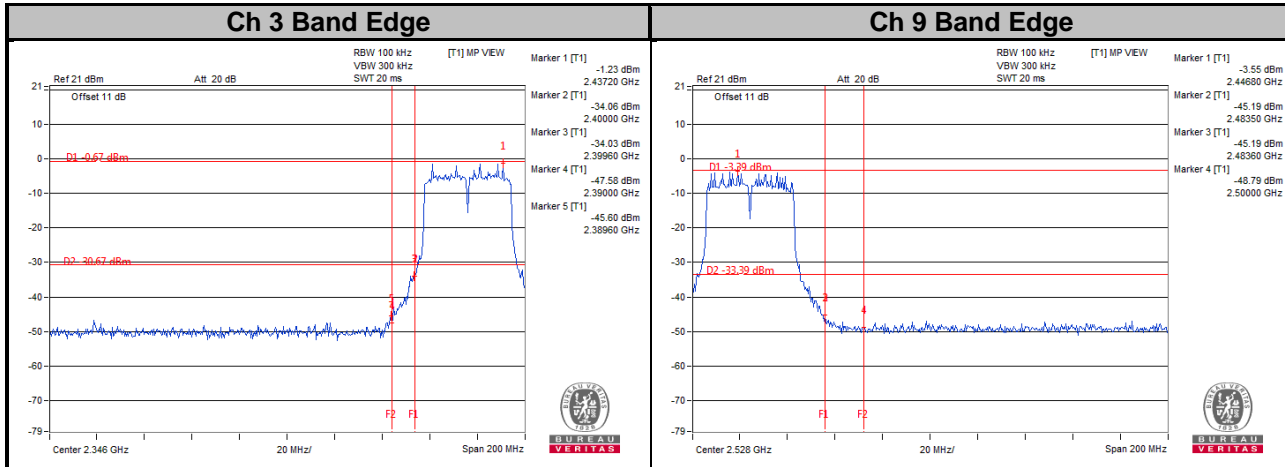

CHAIN 1

Ch 3

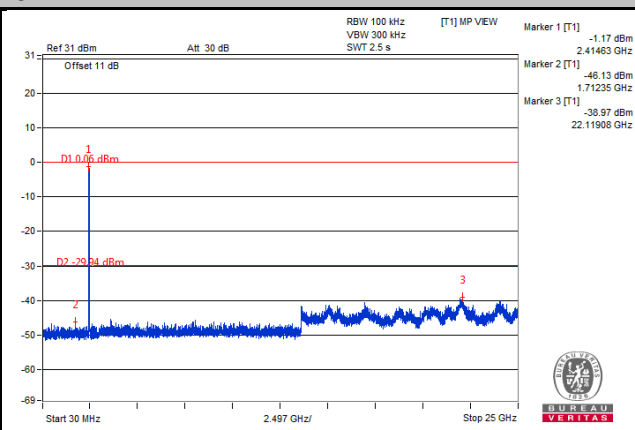
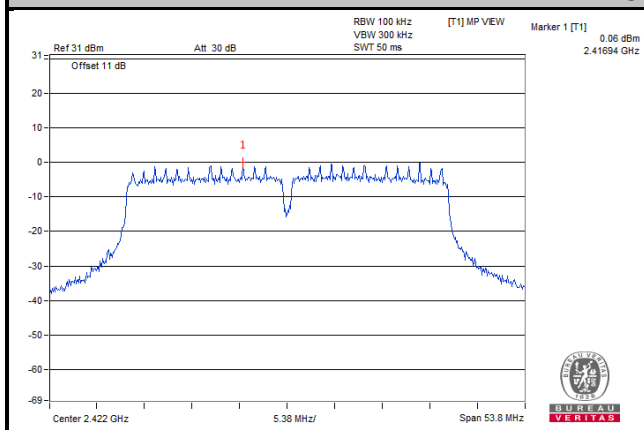

Ch 6

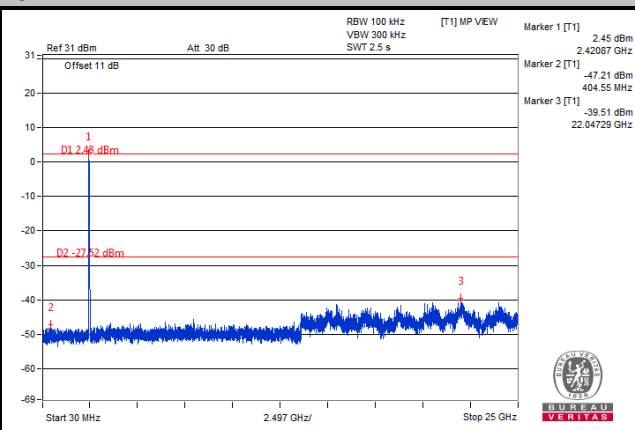
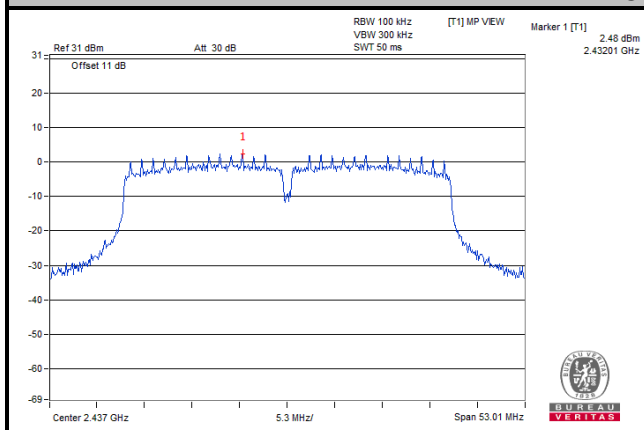

Ch 9

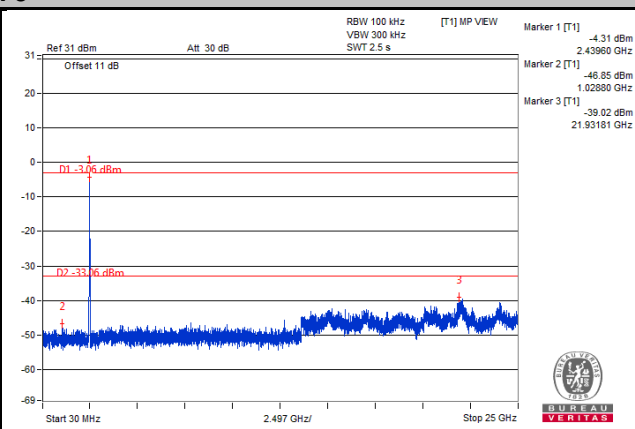
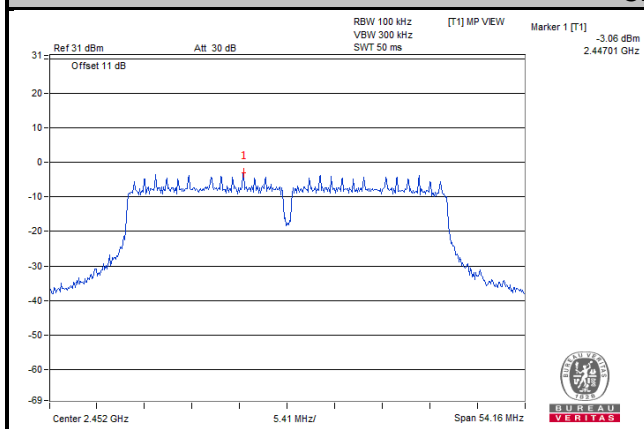

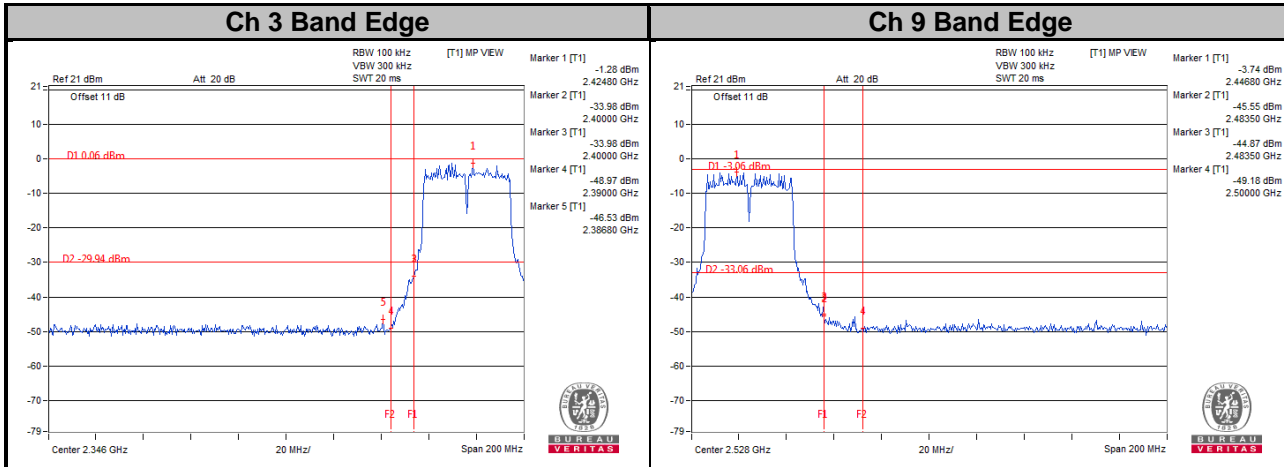

5 Pictures of Test Arrangements

Please refer to the attached file (Test Setup Photo).

Appendix – Information of the Testing Laboratories

We, Bureau Veritas Consumer Products Services (H.K.) Ltd., Taoyuan Branch, were founded in 1988 to provide our best service in EMC, Radio, Telecom and Safety consultation. Our laboratories are FCC recognized accredited test firms and accredited according to ISO/IEC 17025.

If you have any comments, please feel free to contact us at the following:

Lin Kou EMC/RF Lab

Tel: 886-2-26052180

Fax: 886-2-26051924

Hsin Chu EMC/RF/Telecom Lab

Tel: 886-3-6668565

Fax: 886-3-6668323

Hwa Ya EMC/RF/Safety Lab

Tel: 886-3-3183232

Fax: 886-3-3270892

Email: service.adt@tw.bureauveritas.com

Web Site: www.bureauveritas-adt.com

The address and road map of all our labs can be found in our web site also.

--- END ---