



FCC 47 CFR PART 15 SUBPART E AND ANSI C63.4 : 2003

TEST REPORT

For

802.11a/g Wireless CardBus Card

Model : AG-120

Trade Name : ZyXEL

Issued for

ZyXEL Communications Corporation

No.6 innovation Road II Science Park Hsin-chu Taiwan

Issued by

**Compliance Certification Services Inc.
Hsinchu Lab.**

Rm. 258, Bldg. 17, NO.195, Sec.4 Chung HsingRd.,
ChuTung Chen, Hsinchu, Taiwan 310, R.O.C

TEL: (03) 591-0068

FAX: (03) 582-5720



***Note:** This report shall not be reproduced except in full, without the written approval of Compliance Certification Services Inc. Ltd. This document may be altered or revised by Compliance Certification Services Inc. personnel only, and shall be noted in the revision section of the document.*



TABLE OF CONTENTS

TITLE	PAGE NO.
1. TEST REPORT CERTIFICATION.....	3
2. EUT DESCRIPTION.....	4
2.1 DESCRIPTION OF EUT & POWER.....	4
3. DESCRIPTION OF TEST MODES	5
4. TEST METHODOLOGY.....	5
5. FACILITIES AND ACCREDITATIONS.....	6
5.1 FACILITIES.....	6
5.2 EQUIPMENT.....	6
5.3 LABORATORY ACCREDITATIONS LISTINGS.....	6
5.4 TABLE OF ACCREDITATIONS AND LISTINGS	7
6. CALIBRATION AND UNCERTAINTY.....	8
6.1 MEASURING INSTRUMENT CALIBRATION.....	8
6.2 MEASUREMENT UNCERTAINTY.....	8
7. SETUP OF EQUIPMENT UNDER TEST.....	9-10
8. APPLICABLE LIMITS AND TEST RESULTS	11
8.1 26dB BANDWIDTH.....	11-14
8.2 PEAK CONDUCTED TRANSMIT POWER	15-19
8.3 MAXIMUM PERMISSIBLE EXPOSURE	20-21
8.4 PEAK POWER SPECTRAL DENSITY.....	22-25
8.5 PEAK EXCURSION.....	26-29
8.6 CONDUCTED SPURIOUS EMISSION.....	30-32
8.7 RADIATED EMISSIONS.....	33
8.7.1 TRANSMITTER RADIATED SUPURIOUS EMSSIONS	33-37
8.7.2 WORST-CASE RADIATED EMISSION BELOW 1 GHz.....	38
8.7.3 TRANSMITTER RADIATED EMISSION ABOVE 1 GHz.....	39-41
8.7.4 RESTRICTED BAND EDGES	42-45
8.8 POWERLINE CONDUCTED EMISSIONS	46-49
9. TRANSMISSION IN ABSENCE OF DATA.....	50
10. FREQUENCY STABILITY.....	51-52
11. ANTENNA REQUIREMENT.....	53
11.1 STANDARD APPLICABLE.....	53
11.2 ANTENNA CONNECTED CONSTRUCTION	53
APPENDIX SETUP PHOTOS.....	54-59



1. TEST REPORT CERTIFICATION

Applicant : ZyXEL Communications Corporation
Address : No.6 innovation Road II Science Park Hsin-chu Taiwan
Equipment Under Test : 802.11a/g Wireless CardBus Card
Model : AG-120
Trade Name : ZyXEL
Tested Date : June 06 23 ~ July 06, 2006

APPLICABLE STANDARD	
STANDARD	TEST RESULT
FCC Part 15 Subpart E : 2004 AND ANSI C63.4 : 2003	No non-compliance noted

Approved by:

C. F. Wu
Manager of Hsinchu Laboratory
Compliance Certification Services Inc.



Reviewed by:

Alan Fan
Test Engineer of Hsinchu Laboratory
Compliance Certification Services Inc.

WE HEREBY CERTIFY THAT: The measurements shown in the attachment were made in accordance with the procedures indicated, and the energy emitted by the equipment was found to be within the limits applicable. We assume full responsibility for the accuracy and completeness of these measurements and vouch for the qualifications of all persons taking them.



2. EUT DESCRIPTION

2.1 DESCRIPTION OF EUT & POWER

Product Name	802.11a/g Wireless CardBus Card
Model Number	AG-120
Frequency Range	IEEE 802.11a (UNII Band):5180MHz~5320MHz
Transmit Power (ERP)	IEEE 802.11a: 14.84dBm (UNII Band)
Channel Spacing	IEEE 802.11a:20MHz
Channel Number	IEEE 802.11a: 8 Channels
Transmit Data Rate	IEEE 802.11a: 54, 48, 36, 24, 18, 12, 9, 6Mbps
Type of Modulation	IEEE 802.11a : OFDM (64QAM, 16QAM, QPSK, BPSK)
Frequency Selection	by software / firmware
Antenna Type	PCB Antenna ,Antenna Gain 2 dBi at 2.4GHz, 2 dBi at 5GHz.
Power Source	3.3VDC (From Notebook PC ,Powered From Host Device)

Operation Frequency:

UNLICENSED NATIONAL INFORMATION INFRASTRUCTURE (U-NII)	
CHANNEL	MHz
1	5180
2	5200
3	5220
4	5240
5	5260
6	5280
7	5300
8	5320

Remark:

1. This submittal(s) (test report) is intended for FCC ID: I88AG120 filing to comply with Section 15.407 of the FCC Part 15, Subpart E Rules.
2. The 5 GHz U-NII band is applicable to this report; another bands of operation (2.4 GHz) is documented in a separate report.



3. DESCRIPTION OF TEST MODES

IEEE 802.11a mode (UNII Band)

The EUT had been tested under operating condition.

There are three channels have been tested as following :

Channel	Frequency (MHz)
Low	5180
Middle	5260
High	5320

IEEE 802.11a mode (UNII Band): 6Mbps data rate (worst case) were chosen for full testing.

4. TEST METHODOLOGY

The tests documented in this report were performed in accordance with ANSI C63.4 and FCC CFR 47 2.1046, 2046, 2.1047, 2.1049, 2.1051, 2.1053, 2.1055, 2.1057, 15.207, 15.209 and 15.407.



5. FACILITIES AND ACCREDITATIONS

5.1 FACILITIES

All measurement facilities used to collect the measurement data are located at Rm.258, Bldg.17, NO.195 , Sec. 4, Chung Hsing Rd., Chu-Tung Chen. Hsin-Chu, Taiwan 310 R.O.C.

The sites are constructed in conformance with the requirements of ANSI C63.7, ANSI C63.4 and CISPR Publication 22.

5.2 EQUIPMENT

Radiated emissions are measured with one or more of the following types of linearly polarized antennas: tuned dipole, biconical, log periodic, bi-log, and/or ridged waveguide, horn. Spectrum analyzers with preselectors and quasi-peak detectors are used to perform radiated measurements.

Conducted emissions are measured with Line Impedance Stabilization Networks and EMI Test Receivers.





Calibrated wideband preamplifiers, coaxial cables, and coaxial attenuators are also used for making measurements.

All receiving equipment conforms to CISPR Publication 16-1, "Radio Interference Measuring Apparatus and Measurement Methods."

5.3 LABORATORY ACCREDITATIONS LISTINGS

The test facilities used to perform radiated and conducted emissions tests are accredited by National Voluntary Laboratory Accreditation Program for the specific scope of accreditation under Lab Code: 200118-0 to perform Electromagnetic Interference tests according to FCC PART 15 AND CISPR 22 requirements. No part of this report may be used to claim or imply product endorsement by NVLAP or any agency of the US Government. In addition, the test facilities are listed with Federal Communications Commission (registration no: 90585 and 90584).

5.4 TABLE OF ACCREDITATIONS AND LISTINGS

Country	Agency	Scope of Accreditation	Logo
USA	NVLAP	EN 55014-1, AS/NZS 1044, CNS 13783-1, IEC/CISPR 14-1, IEC/CISPR 22, EN 55022, EN 61000-3-2, EN 61000-3-3, ANSI C63.4, AS/NZS CISPR 22, AS/NZS 3548, IEC 61000-4-2/3/4/5/6/8/11	 200118-0
USA	FCC	3/10 meter Open Area Test Sites to perform FCC Part 15/18 measurements	 90585, 90584
Japan	VCCI	3/10 meter Open Area Test Sites to perform conducted/radiated measurements	VCCI R-1229/1189 C-1250/1294
Taiwan	TAF	FCC Method-47 CFR Part 15 Subpart C,D,E CISPR 11, FCC METHOD-47 CFR Part 18, EN 55011, CNS 13803, CISPR 13, CNS 13439, FCC Method-47 CFR Part 15 Subpart B, CISPR 14-1, EN 55014-1, CNS 13783-1, EN 55015, CNS 14115, CISPR 22, EN 55022, VCCI CNS 13438, EN 61000-4-2/3/4/5/6/8/11	 Testing Laboratory 0240
Taiwan	BSMI	CNS 13803, CNS 13438, CNS 13439, CNS 13783-1, CNS 14115	 SL2-IS-E-0002 SL2-IN-E-0002 SL2-A1-E-0002 SL2-R1-E-0002 SL2-R2-E-0002 SL2-L1-E-0002
Canada	Industry Canada	RSS212, Issue 1	 IC 4417-1

* No part of this report may be used to claim or imply product endorsement by NVLAP or any agency of the US Government.



6. CALIBRATION AND UNCERTAINTY

6.1 MEASURING INSTRUMENT CALIBRATION

The measuring equipment utilized to perform the tests documented in this report has been calibrated in accordance with the manufacturer's recommendations, and is traceable to recognized national standards.

6.2 MEASUREMENT UNCERTAINTY

Where relevant, the following measurement uncertainty levels have been estimated for tests performed on the apparatus:

PARAMETER	UNCERTAINTY
Radiated Emission, 30 to 1000 MHz	+/- 3.2 dB
Radiated Emission, 1 to 26.5 GHz	+/- 3.2 dB
Power Line Conducted Emission	+/- 2.9 dB

Uncertainty figures are valid to a confidence level of 95%



7. SETUP OF EQUIPMENT UNDER TEST

SUPPORT EQUIPMENT

No.	Product	Manufacturer	Model No.	Serial No.	FCC ID
1	Notebook PC	HP	nx6130	CNU543274R	DoC
2	Notebook PC	DELL	Latitude D610	CN-0C4708 -48643-625-5565	DoC
3	Wireless USB Adapter	NETGEAR	WG111U	-----	PY3WG111U
4	Wireless Access Point	D-Link	DWL-7100AP	DQ6114B00002	KA22003040018-1
5	Modem	ZyXEL	Omni 56K	S1Z4107727	1880MN156K
6	Printer	HP	hp desk jet 948c	CN19S6S1XS	DoC

SETUP DIAGRAM FOR TESTS

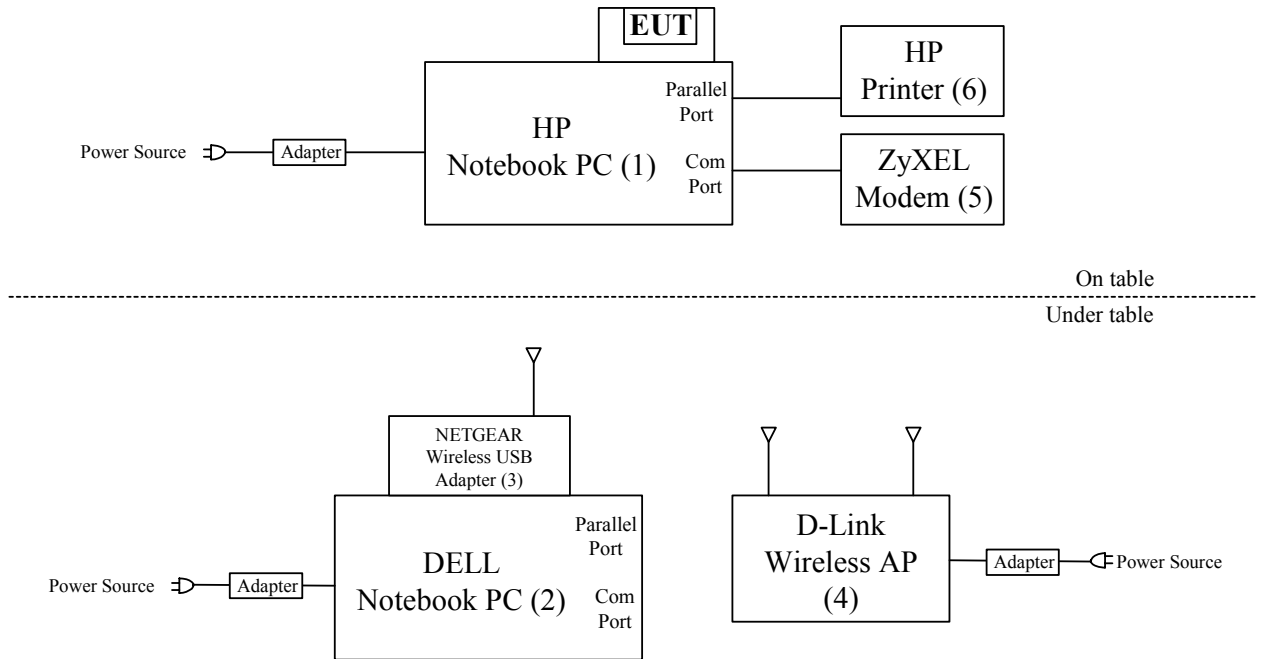



EUT OPERATING CONDITION

1. Set up all computers like the setup diagram.
2. The “**ZyXEL WLAN Hardwae Test**” software was used for testing.
D1212B EVL Tool Driver Version:5.5.4.0 ZyDAS Localtest3 2006.4.26
Adapter List (Driver Version:1.5.0.0):[0034...(ZD1212B) IEEE 802.11 a+b+g
PCI Adapter]

(1) TX Mode:

- ⇒ **Tx Antenna:ANT1**
- ⇒ **Tx Data Rate:6Mbps** (IEEE 802.11a mode)
- ⇒ **PA Gain Control**
 - IEEE 802.11a (UNII) Channel Low (5180MHz) = **0x40**
 - IEEE 802.11a (UNII) Channel Middle (5260MHz) = **0x44**
 - IEEE 802.11a (UNII) Channel High (5320MHz) = **0x40**

(2) RX Mode :

- ⇒ **Rx Antenna:ANT2**
- ⇒ **Debug Cmd** (I/O Access for ZD1211)
- ⇒ **PHY: CR:11 Data:14**
- ⇒ **RD** (Read data) , **WR** (Write data)

3. All of the function are under run.
4. Start test.



8. APPLICABLE LIMITS AND TEST RESULTS

8.1 26dB BANDWIDTH

LIMIT

For purposes of this subpart, the emission bandwidth shall be determined by measuring the width of the signal between two points, one below the carrier center frequency and one above the carrier center frequency, that are 26 dB down relative to the maximum level of the modulated carrier. Determination of the emissions bandwidth is based on the use of measurement instrumentation employing a peak detector function with an instrument resolutions bandwidth approximately equal to 1.0 percent of the emission bandwidth of the device under measurement.

TEST EQUIPMENTS

Description & Manufacturer	Model No.	Serial No.	Date of Calibration
ROHDE & SCHWARZ SPECTRUM ANALYZER	FSEK30	835253/002	September 24, 2005
AGILENT SPECTRUM ANALYZER	E4446A	MY433601.32	March 22, 2006

TEST SETUP



TEST PROCEDURE

1. Place the EUT on the table and set it in the transmitting mode.
2. Remove the antenna from the EUT and then connect a low-loss RF cable from the antenna port to the spectrum analyzer.
3. Set the spectrum analyzer as RBW = 1%EBW, VBW = RBW, Span = 50MHz and Sweep = auto.

Or Set the spectrum analyzer as RBW > 1%EBW, VBW > RBW, Span >26dB bandwidth (Base Mode) and Sweep = auto.

4. Mark the peak frequency and -26dB (upper and lower) frequency.
5. Repeat until all the rest channels were investigated.



TEST RESULTS

No non-compliance noted

IEEE 802.11a MODE

Channel	Channel Frequency (MHz)	26dB Bandwidth (B) (MHz)
Low	5180	30.15
Middle	5260	34.38
High	5320	28.96



26dB BANDWIDTH (802.11a MODE)

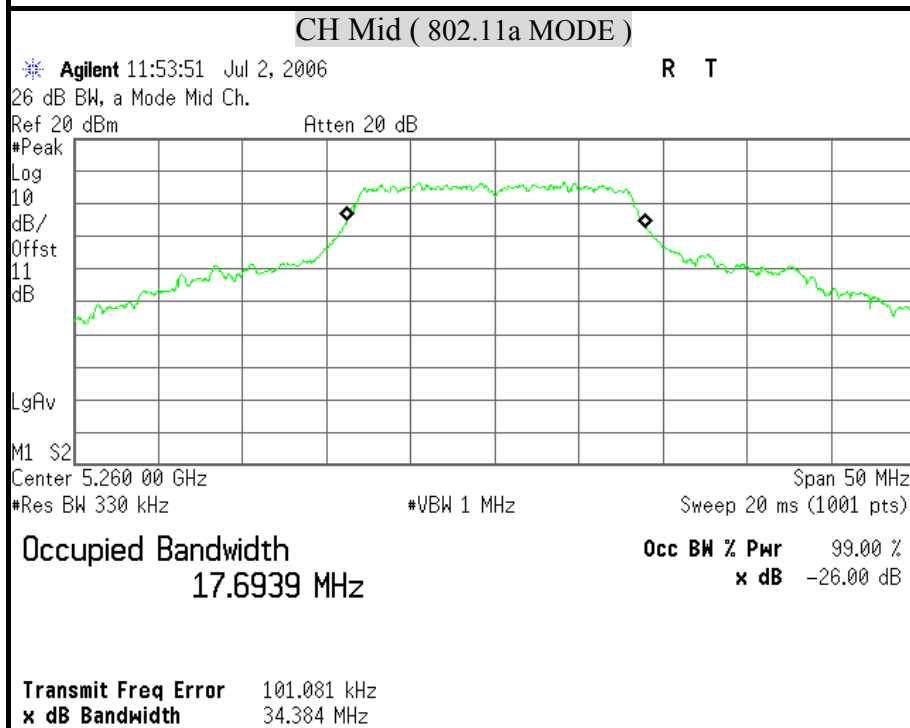
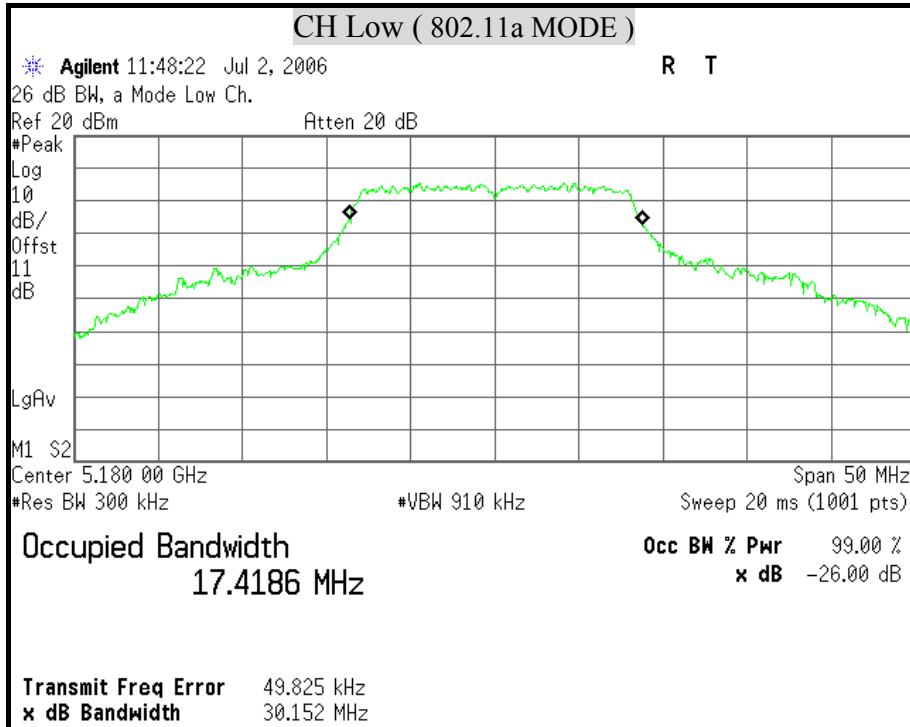

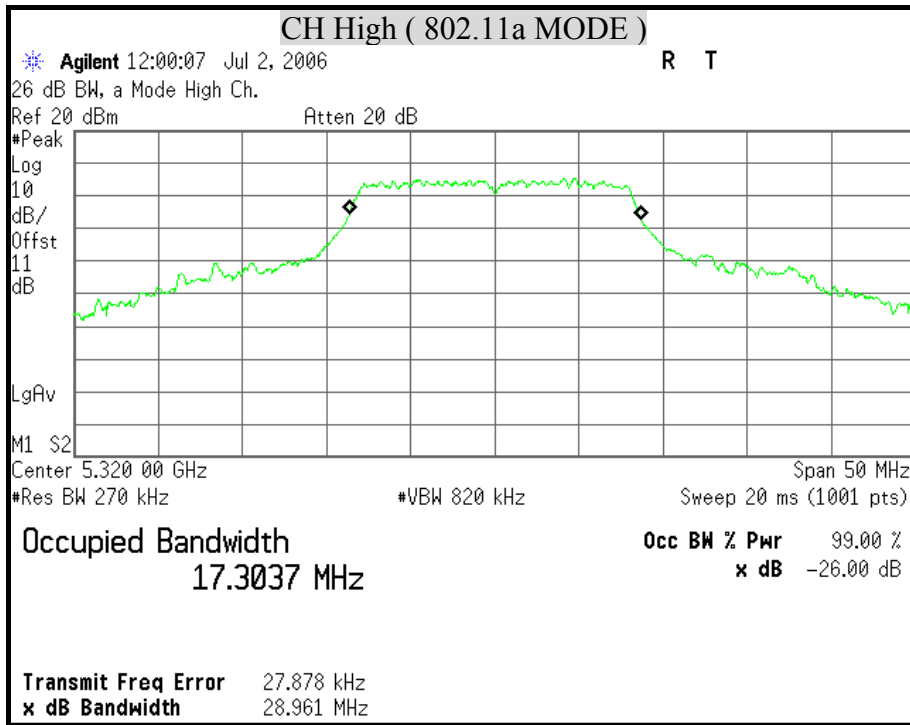



8.2 PEAK CONDUCTED TRANSMIT POWER

LIMIT

- For the band 5.15-5.25 GHz, the peak transmit power over the frequency band of operation shall not exceed the lesser of 50mW (17dBm) or $4\text{dBm} + 10\log B$, where B is the 26dB emission bandwidth in MHz. In addition, the peak power spectral density shall not exceed 4dBm in any 1 MHz band.
- For the band 5.25-5.35 GHz, the peak transmit power over the frequency band of operation shall not exceed the lesser of 250mW (24dBm) or $11\text{dBm} + 10\log B$, where B is the 26dB emission bandwidth in MHz. In addition, the peak power spectral density shall not exceed 11dBm in any 1 MHz band.

If transmitting antennas of directional gain greater than 6dBi are used, both the peak transmit power and the peak power spectral density shall be reduced by the amount in dB that the directional gain of the antenna exceeds 6dBi. The peak power shall not exceeded the limit as follows:

Specified Limit of the Peak Power

Channel	Channel Frequency (MHz)	10 Log B (dB)	4 + 10 Log B or 11 + 10 Log B (dBm)	Power Limit (dBm)
Low	5180	14.79	18.79	17
Middle	5260	15.36	26.36	24
High	5320	14.62	25.62	24

Remark: Maximum antenna gain = 2dBi, therefore there is no reduction due to antenna gain.

**TEST EQUIPMENTS**

Description & Manufacturer	Model No.	Serial No.	Date of Calibration
ROHDE & SCHWARZ SPECTRUM ANALYZER	FSEK30	835253/002	September 24, 2005
AGILENT SPECTRUM ANALYZER	E4446A	MY433601.32	March 22, 2006

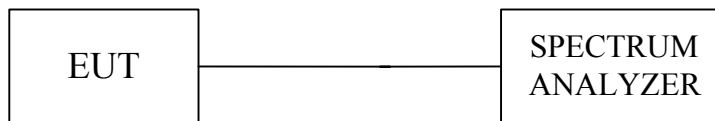
TEST SETUP**TEST PROCEDURE**

Set span to encompass the entire emission bandwidth (EBW) of the signal.

Set RBW = 1 MHz / Set VBW = 3 MHz.

Use sample detector mode if bin width (i.e., span/number of points in spectrum display) < 0.5 RBW. Otherwise use peak detector mode. Use a video trigger with the trigger level set to enable triggering only on full power pulses. Transmitter must operate at full control power for entire sweep of every sweep. If the device transmits continuously, with no off intervals or reduced power intervals, the trigger may be set to "free run". Trace average 100 traces in power averaging mode. Compute power by integrating the spectrum across the 26 dB EBW of the signal. The integration can be performed using the spectrum analyzer's band power measurement function with band limits set equal to the EBW band edges or by summing power levels in each 1 MHz band in linear power terms. The 1 MHz band power levels to be summed can be obtained by averaging, in linear power terms, power levels in each frequency bin across the 1 MHz.

**TEST RESULTS**

No non-compliance noted

IEEE 802.11a MODE

Channel	Channel Frequency (MHz)	Output Power (dBm)	Margin (dB)	Power Limit (dBm)
Low	5180	14.36	-2.64	17
Middle	5260	14.76	-9.24	24
High	5320	14.53	-9.47	24

Remark:

1. At final test to get the worst-case emission at 6Mbps.
2. The cable assembly insertion loss of 11dB (including 10 dB pad and 1 dB cable) was Entered as an offset in the [spectrum analyzer](#) to allow for direct reading of power.



PEAK CONDUCTED TRANSMIT POWER (802.11a MODE)

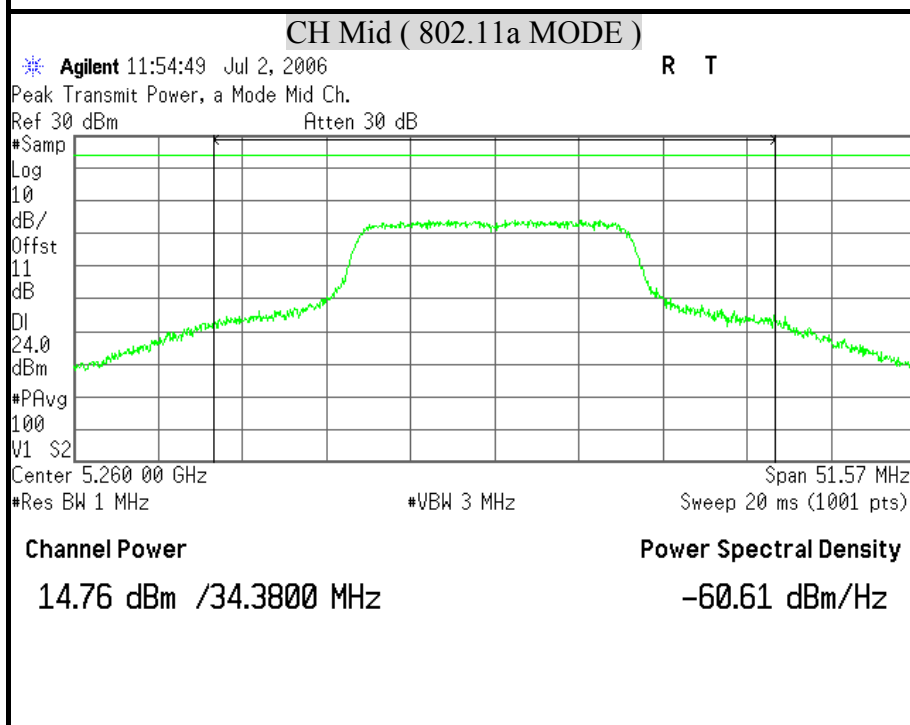
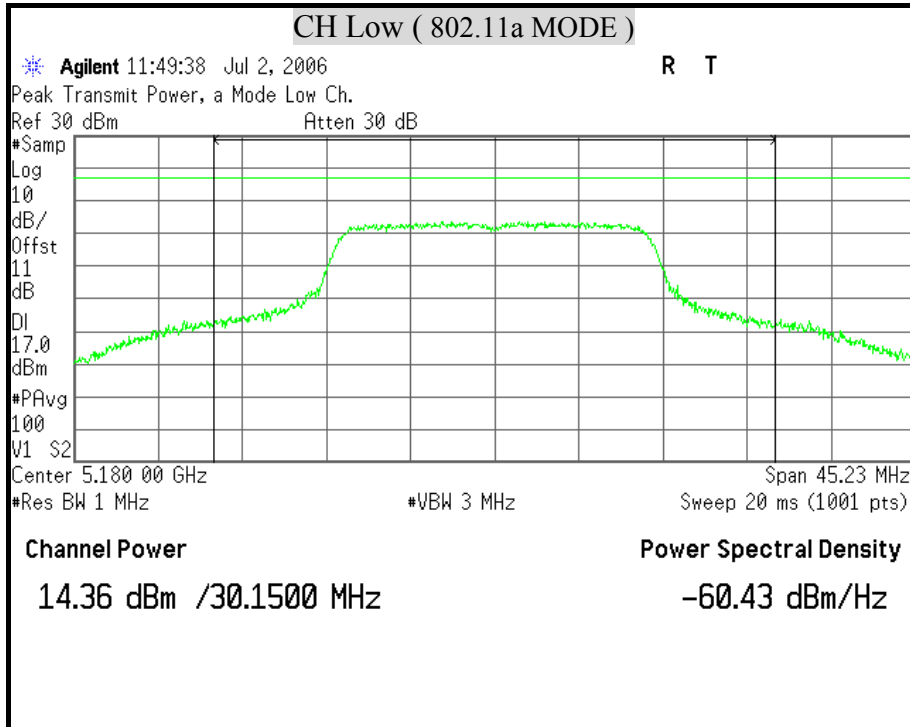

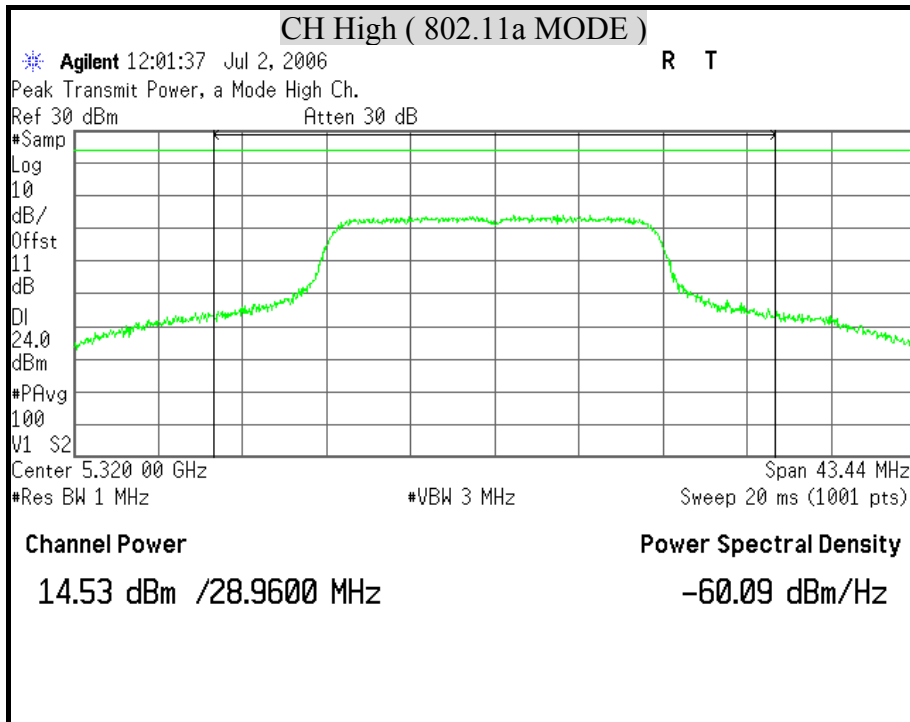



8.3 MAXIMUM PERMISSIBLE EXPOSURE

According to FCC 1.1310 : The criteria listed in the following table shall be used to evaluate the environment impact of human exposure to radio frequency (RF) radiation as specified in 1.1307(b) LIMITS FOR MAXIMUM PERMISSIBLE EXPOSURE (MPE)

Frequency Range (MHz)	Electric Field Strength (V/m)	Magnetic Field Strength (A/m)	Power Density (mW/cm ²)	Average Time
(A) Limits for Occupational / Control Exposures				
300-1,500	--	--	F/300	6
1,500-100,000	--	--	5	6
(B) Limits for General Population / Uncontrol Exposures				
300-1,500	--	--	F/1500	6
1,500-100,000	--	--	1	30

CALCULATIONS

$$\text{Given } E = \frac{\sqrt{30 \times P \times G}}{d} \quad \& \quad S = \frac{E^2}{3770}$$

Where E = Field strength in Volts / meter

P = Power in Watts

G = Numeric antenna gain

d = Distance in meters

S = Power density in milliwatts / square centimeter

Combining equations and re-arranging the terms to express the distance as a function of the remaining variables yields:

$$S = \frac{30 \times P \times G}{3770 d^2}$$

Changing to units of mW and cm, using:

$$P \text{ (mW)} = P \text{ (W)} / 1000 \text{ and}$$

$$d \text{ (cm)} = d \text{ (m)} / 100$$

Yields

$$S = \frac{30 \times (P/1000) \times G}{3770 \times (d/100)^2} = 0.0796 \times \frac{P \times G}{d^2}$$

Where d = Distance in cm

P = Power in mW

G = Numeric antenna gain

S = Power density in mW / cm²

**LIMIT**

Power Density Limit, $S=1.0\text{mW}/\text{cm}^2$

TEST RESULTS

No non-compliance noted

Mode	Minimum separation distance (cm)	Output Power (dBm)	Antenna Gain (dBi)	Power Density Limit (mW/cm^2)	Power Density at 20cm (mW/cm^2)
IEEE 802.11a	20.0	14.76	2	1.00	0.009435

Remark: For mobile or fixed location transmitters, the maximum power density is $1.0\text{ mW}/\text{cm}^2$ even if the calculation indicates that the power density would be larger.



8.4 PEAK POWER SPECTRAL DENSITY

LIMIT

- For the band 5.15-5.25 GHz, the peak power spectral density shall not exceed 4dBm in any 1MHz band.
- For the band 5.25-5.35 GHz, the peak power spectral density shall not exceed 11dBm in any 1MHz band.

If transmitting antennas of directional gain greater than 6dBi are used, both the peak transmit power and the peak power spectral density shall be reduced by the amount in dB that the directional gain of the antenna exceeds 6dBi.

TEST EQUIPMENTS

Description & Manufacturer	Model No.	Serial No.	Date of Calibration
ROHDE & SCHWARZ SPECTRUM ANALYZER	FSEK30	835253/002	September 24, 2005
AGILENT SPECTRUM ANALYZER	E4446A	MY433601.32	March 22, 2006

TEST SETUP

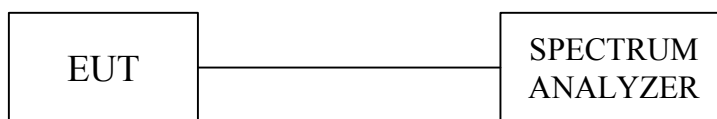

TEST PROCEDURE

1. Place the EUT on the table and set it in transmitting mode.
Remove the antenna from the EUT and then connect a low loss RF cable from the antenna port to the spectrum analyzer.
2. Set the spectrum analyzer as RBW = 1MHz, VBW = 3MHz
Set span encompass the entire emission bandwidth (EBW) of the signal.
3. Record the max. reading.
4. Repeat the above procedure until the measurements for all frequencies are completed.

**TEST RESULTS**

No non-compliance noted

IEEE 802.11a MODE

Channel	Channel Frequency (MHz)	PPSD (dBm)	Limit (dBm/MHz)	Margin (dB)	Pass / Fail
Low	5180	3.55	4	-0.45	PASS
Middle	5260	4.06	11	-6.94	PASS
High	5320	3.93	11	-7.08	PASS

Remark:

1. At final test to get the worst-case emission at 6Mbps.
2. The cable assembly insertion loss of 11dB (including 10 dB pad and 1 dB cable) was Entered as an offset in the spectrum analyzer to allow for direct reading of power



PEAK POWER SPECTRAL DENSITY (IEEE 802.11a MODE)

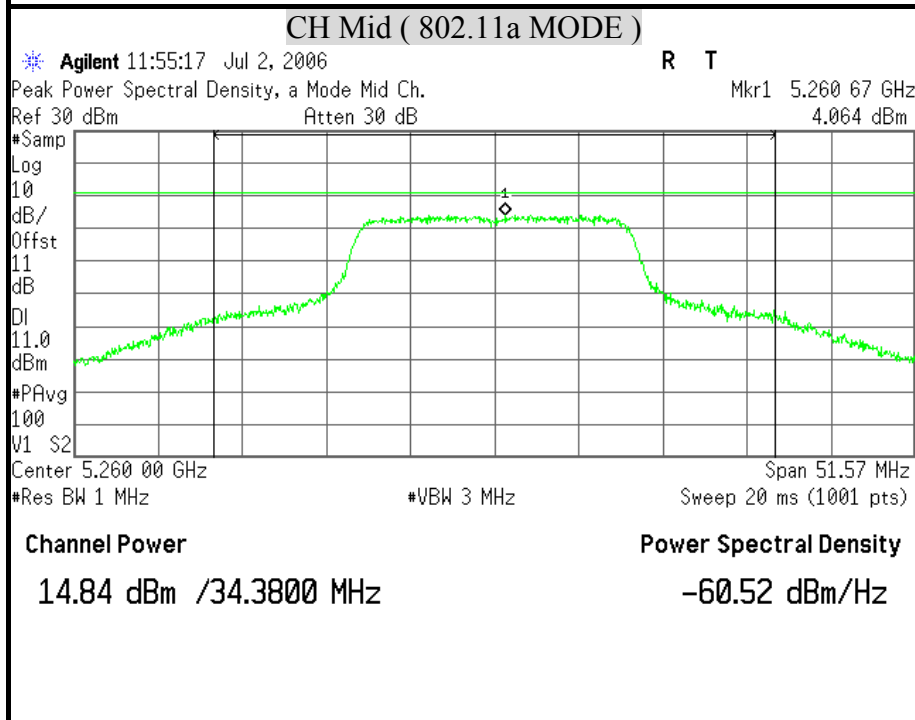
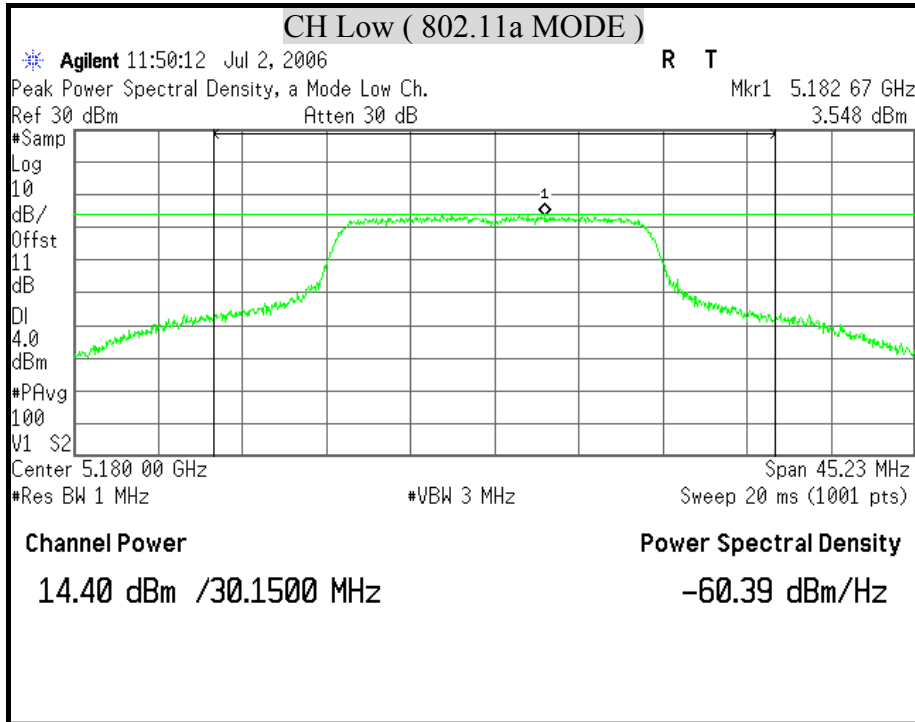

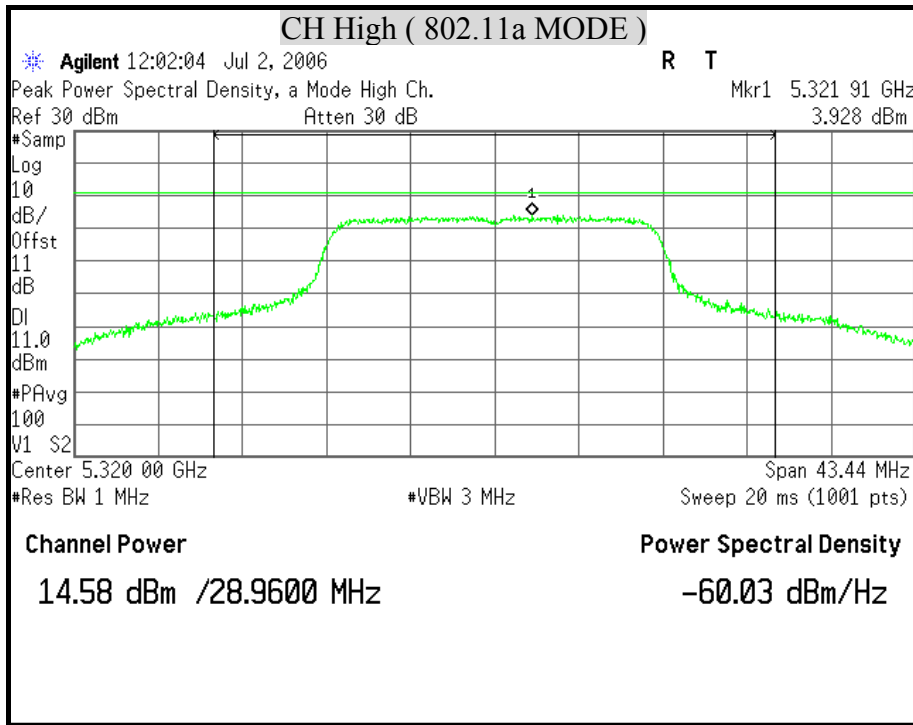



8.5 PEAK EXCURSION

LIMIT

The ratio of the peak excursion of the modulation envelope (measured using a peak hold function) to the peak transmit power (measured as specified above) shall not exceed 13 dB across any 1 MHz bandwidth or the emission bandwidth whichever is less.

TEST EQUIPMENTS

Description & Manufacturer	Model No.	Serial No.	Date of Calibration
ROHDE & SCHWARZ SPECTRUM ANALYZER	FSEK30	835253/002	September 24, 2005
AGILENT SPECTRUM ANALYZER	E4446A	MY433601.32	March 22, 2006

TEST SETUP

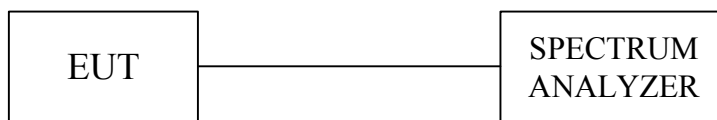

TEST PROCEDURE

The test is performed in accordance with <FCC Public Notice: APPENDIX A Guidelines for Assessing Unlicensed National Information Infrastructure (U-NII) Devices> – Part 15, Subpart E, August 2002.

1. Place the EUT on the table and set it in transmitting mode.
2. Remove the antenna from the EUT and then connect a low loss RF cable from the antenna port to spectrum.
3. Trace A, Set RBW =1MHz, VBW \geq 3MHz, with peak detector and Max. hold, Span > 26dB Bandwidth (Base Mode).
4. Trace B, If Method #1 was used for the peak conducted transmit output power test, then create the 2nd trace using the settings described in Method #1.
5. Delta Mark trace A Maximum frequency and trace B same frequency.
6. Repeat the above procedure until measurements for all frequencies were complete.

**TEST RESULTS**

No non-compliance noted

IEEE 802.11a MODE

Channel	Channel Frequency (MHz)	Peak Excursion (dBm)	Limit (dB)	Margin (dB)	Pass / Fail
Low	5180	7.61	13	-5.39	PASS
Middle	5260	8.95	13	-4.05	PASS
High	5320	8.66	13	-4.34	PASS

Note :
1. At final test to get the worst-case emission at 6Mbps.
2. The cable assembly insertion loss of 11dB (including 10 dB pad and 1 dB cable) was Entered as an offset in the *spectrum analyzer* to allow for direct reading of power.



PEAK EXCURSION (IEEE 802.11a MODE)

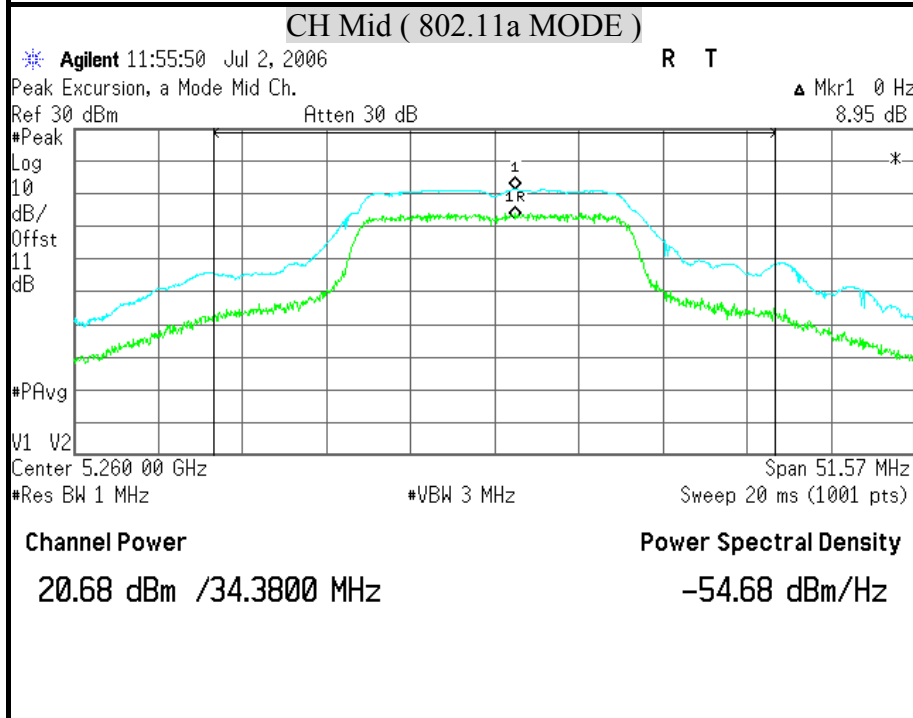
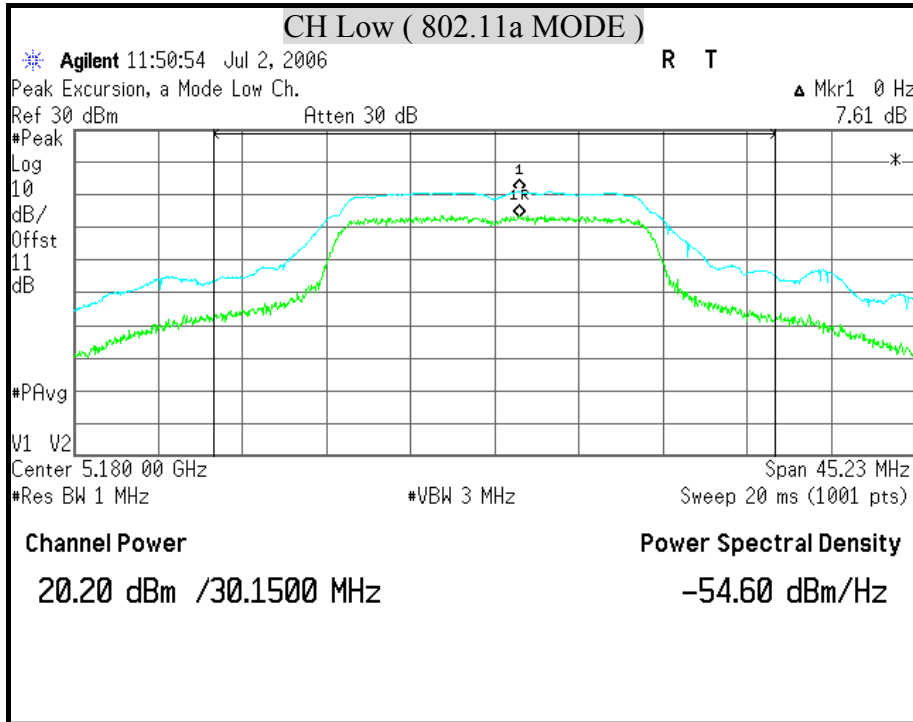

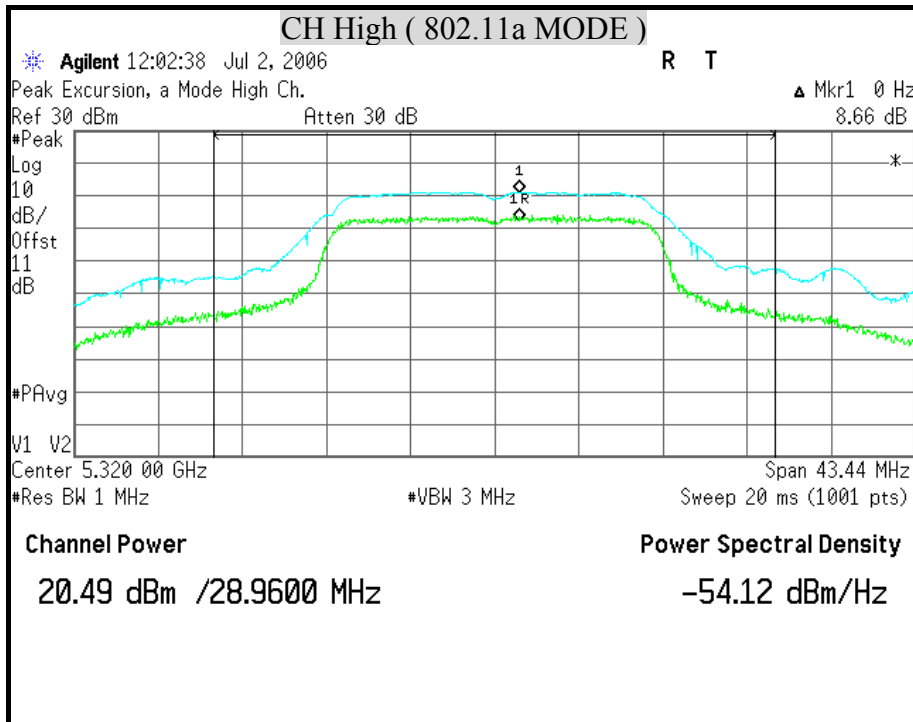



8.6 CONDUCTED SPURIOUS EMISSION

LIMITS

Transmitters operating in the 5.15-5.35 GHz band: all emissions outside of the 5.15-5.35 GHz band shall not exceed an EIRP of -27dBm / MHz. Unwanted emissions below 1 GHz must comply with the general field strength limits set forth in § 15.209. Further, any U-NII devices using an AC power line are required to comply also with the conducted limits set forth in § 15.207.

The provisions of § 15.205 apply to intentional radiators operating under this section.

TEST EQUIPMENTS

Description & Manufacturer	Model No.	Serial No.	Date of Calibration
ROHDE & SCHWARZ SPECTRUM ANALYZER	FSEK30	835253/002	September 24, 2005
AGILENT SPECTRUM ANALYZER	E4446A	MY433601.32	March 22, 2006

TEST SETUP

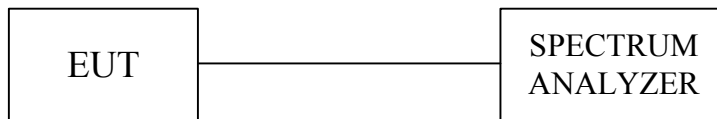

TEST PROCEDURE

Conducted RF measurements of the transmitter output were made to confirm that the EUT antenna port conducted emissions meet the specified limit and to identify any spurious signals that require further investigation of measurements on the radiated emissions site.

The transmitter output is connected to the spectrum analyzer. The resolution bandwidth is set to 1MHz. The video bandwidth is set to 1 MHz. Peak detection measurements are compared to the average EIRP limit, adjusted for the maximum antenna gain. If necessary, additional average detection measurements are made.

Measurements are made over the 30 MHz to 40 GHz range with the transmitter set to the lowest, middle, and highest channels.

TEST RESULTS

No non-compliance noted



OUT-OF-BAND SPURIOUS EMISSIONS-CONDUCTED MEASUREMENT (IEEE 802.11a MODE)

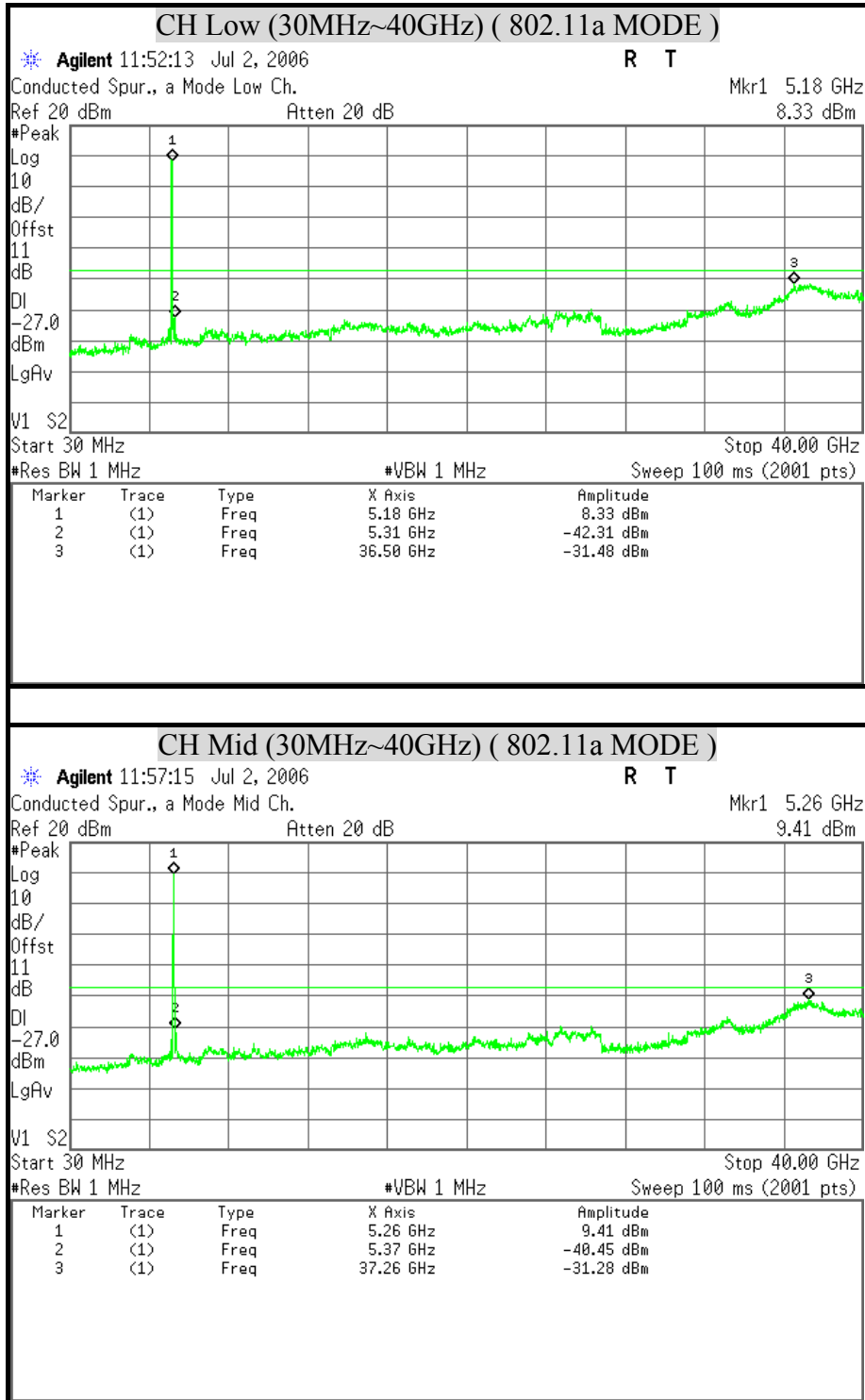

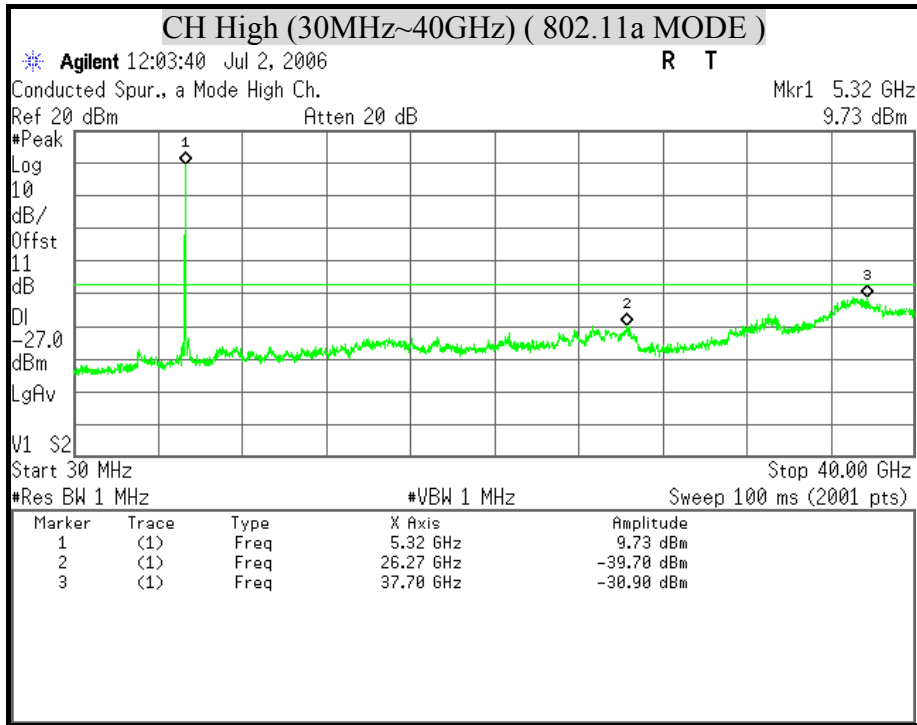



8.7 RADIATED EMISSIONS

8.7.1 TRANSMITTER RADIATED SUPURIOUS EMISSIONS

LIMITS

§ 15.205 (a) Except as shown in paragraph (d) of this section, only spurious emissions are permitted in any of the frequency bands listed below:

MHz	MHz	MHz	GHz
0.090 - 0.110	16.42 - 16.423	399.9 - 410	4.5 - 5.15
¹ 0.495 - 0.505	16.69475 - 16.69525	608 - 614	5.35 - 5.46
2.1735 - 2.1905	16.80425 - 16.80475	960 - 1240	7.25 - 7.75
4.125 - 4.128	25.5 - 25.67	1300 - 1427	8.025 - 8.5
4.17725 - 4.17775	37.5 - 38.25	1435 - 1626.5	9.0 - 9.2
4.20725 - 4.20775	73 - 74.6	1645.5 - 1646.5	9.3 - 9.5
6.215 - 6.218	74.8 - 75.2	1660 - 1710	10.6 - 12.7
6.26775 - 6.26825	108 - 121.94	1718.8 - 1722.2	13.25 - 13.4
6.31175 - 6.31225	123 - 138	2200 - 2300	14.47 - 14.5
8.291 - 8.294	149.9 - 150.05	2310 - 2390	15.35 - 16.2
8.362 - 8.366	156.52475 - 156.52525	2483.5 - 2500	17.7 - 21.4
8.37625 - 8.38675	156.7 - 156.9	2655 - 2900	22.01 - 23.12
8.41425 - 8.41475	162.0125 - 167.17	3260 - 3267	23.6 - 24.0
12.29 - 12.293	167.72 - 173.2	3332 - 3339	31.2 - 31.8
12.51975 - 12.52025	240 - 285	3345.8 - 3338	36.43 - 36.5
12.57675 - 12.57725	322 - 335.4	3600 - 4400	(²)
13.36 - 13.41			

¹ Until February 1, 1999, this restricted band shall be 0.490-0.510 MHz.

² Above 38.6

§ 15.205 (b) Except as provided in paragraphs (d) and (e), the field strength of emissions appearing within these frequency bands shall not exceed the limits shown in Section 15.209. At frequencies equal to or less than 1000 MHz, compliance with the limits in Section 15.209 shall be demonstrated using measurement instrumentation employing a CISPR quasi-peak detector. Above 1000 MHz, compliance with the emission limits in Section 15.209 shall be demonstrated based on the average value of the measured emissions. The provisions in Section 15.35 apply to these measurements.



According to FCC Section 15.407(b) (6) (7), the unwanted emission below 1 GHz and in restricted bands should comply with the general field strength limits set forth in Section 15.209.

§ 15.209 (a) Except as provided elsewhere in this Subpart, the emissions from an intentional radiator shall not exceed the field strength levels specified in the following table :

Frequency (MHz)	Field Strength (microvolts/meter)	Measurement Distance (meters)
30 - 88	100 **	3
88 - 216	150 **	3
216 - 960	200 **	3
Above 960	500	3

** Except as provided in paragraph (g), fundamental emissions from intentional radiators operating under this Section shall not be located in the frequency bands 54-72 MHz, 76-88 MHz, 174-216 MHz or 470-806 MHz, However, operation within these frequency bands is permitted under other sections of this Part, e-g, Sections 15.231 and 15.241.

§ 15.209 (b) In the emission table above, the tighter limit applies at the band edges.

According to FCC Section 15.407(b)(1) (2) (3) (4), the unwanted emission above 1 GHz, outside of the operating frequency band below, should exceed an EIRP of the values listed in table below.

Operating Frequency Band (MHz)	EIRP Limit (dBm/MHz)	Equivalent Field Strength at 3m (dBμV/M)
5150-5250	-27	68.3
5250-5350	-27	68.3
5470-5725	-27	68.3
5725-5825	-27*	68.3
	-17**	78.3

The remark “*” means: outside the frequency range 5715~5835MHz.

The remark “**” means: within the frequency range from the band edge to 10MHz below or above the band edge, 5715~5725MHz and 5825~5835MHz.

**TEST EQUIPMENTS**

The following test equipments are utilized in making the measurements contained in this report.

Manufacturer or Type	Model No.	Serial No.	Date of Calibration	Calibration Period	Remark
CHASE BI-LOG ANTENNA	CBL6112B	2817	March 22, 2006	1 Year	FINAL
R/S SPECTRUM ANALYZER	FSEK30	835253/002	September 24, 2005	1 Year	FINAL
AGILENT SPECTRUM ANALYZER	E4446A	MY433601.32	January 27, 2006	1 Year	FINAL
R/S EMI TEST RECEIVER	ESCS30	835418/008	August 24, 2005	1 Year	FINAL
OPEN SITE	-----	No.2	May 07, 2006	1 Year	FINAL
N TYPE COAXIAL CABLE	9913-30M	-----	July 28, 2005	1 Year	FINAL
Horn Antenna	AH-118	10089	August 10, 2005	1 Year	FINAL
Horn Antenna	AH-840	03077	February 25, 2006	1 Year	FINAL
Agilent Pre-amplifier	8449B	3008A01471	December 07, 2005	1 Year	FINAL
HP Amplifier	8447D	1937A02748	December 07, 2005	1 Year	FINAL
HP High pass filter	84300/80038	002	CAL. ON USE	1 Year	FINAL
HP High pass filter	84300/80039	003	CAL. ON USE	1 Year	FINAL
Micro-Tronics Notch Filter	BRC50703-01	003	CAL. ON USE	1 Year	FINAL

TEST SETUP

The diagram below shows the test setup that is utilized to make the measurements for emission from 30 to 1GHz.

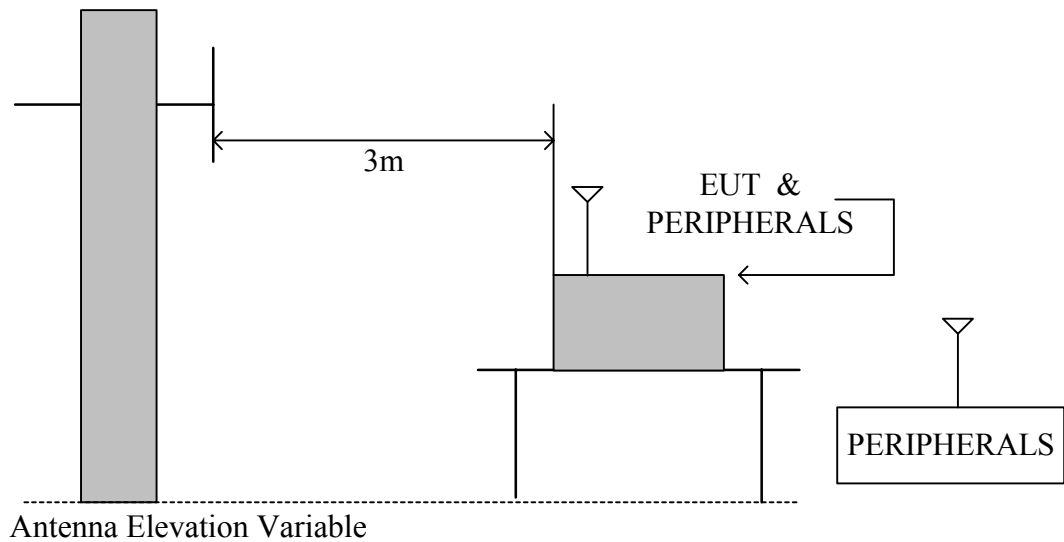

The diagram below shows the test setup that is utilized to make the measurements for emission above 1GHz.

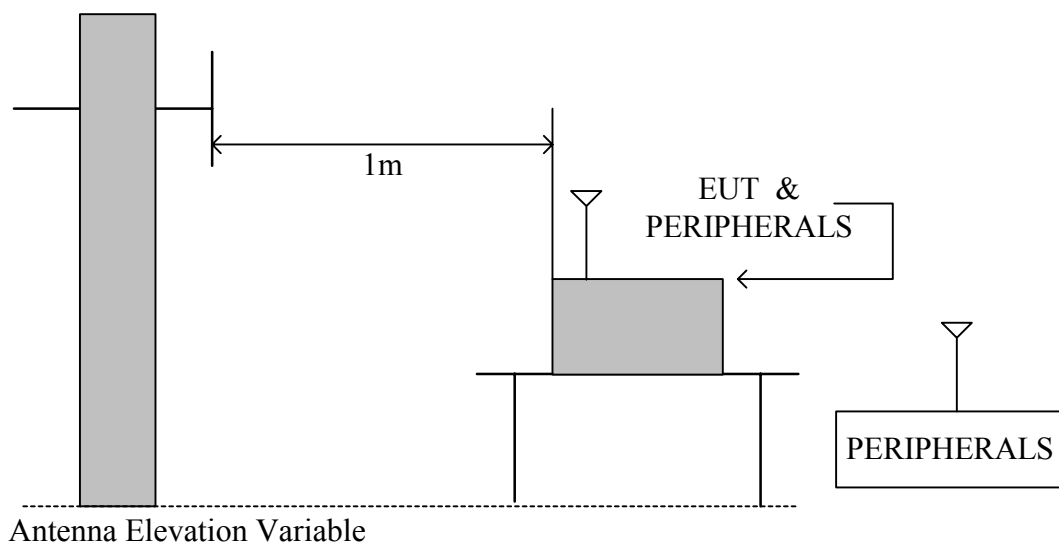



TEST PROCEDURE

- a. The EUT was placed on the top of a rotating table 0.8 meters above the ground at a 10 meter open area test site. The table was rotated 360 degrees to determine the position of the highest radiation.
- b. While measuring the radiated emission below 1GHz, the EUT was set 3 meters away from the interference-receiving antenna, which was mounted on the top of a variable-height antenna tower. While measuring the radiated emission above 1GHz, the EUT was set 1 meters away from the interference-receiving antenna
- c. The antenna is a broadband antenna, and its height is varied from one meter to four meters above the ground to determine the maximum value of the field strength. Both horizontal and vertical polarization of the antenna are set to make the measurement.
- d. For each suspected emission, the EUT was arranged to its worst case and then the antenna was tuned to heights from 1 meter to 4 meters and the table was turned from 0 degrees to 360 degrees to find the maximum reading.
- e. The test-receiver system was set to Peak Detect Function and Specified Bandwidth with Maximum Hold Mode.
- f. If the emission level of the EUT in peak mode was 10 dB lower than the limit specified, then testing could be stopped and the peak values of the EUT would be reported. Otherwise the emissions that did not have 10 dB margin would be re-tested one by one using peak, quasi-peak or average method as specified and then reported in a data sheet.

Note :

1. The resolution bandwidth and video bandwidth of test receiver/spectrum analyzer is 120 KHz for Peak detection (PK) and Quasi-peak detection (QP) at frequency below 1GHz.
2. The resolution bandwidth and video bandwidth of test receiver/spectrum analyzer is 1 MHz for Peak detection and frequency above 1GHz.
3. The resolution bandwidth of test receiver/spectrum analyzer is 1 MHz and the video bandwidth is 10 Hz for Average detection (AV) at frequency above 1GHz.

TEST RESULTS

No non-compliance noted

**8.7.2 WORST-CASE RADIATED EMISSION BELOW 1 GHz**

Product Name	802.11a/g Wireless CardBus Card	Test Date	2006/07/02
Model	AG-120	Test By	Angus Wu
Test Mode	Normal operating (worse case)	TEMP & Humidity	35°C, 48%

Frequency (MHz)	Antenna Factor (dB/m)	Cable Loss (dB)	Meter Reading at 3m(dBμV)		Limits (dBμV/m)	Emission Level at 3m(dBμV/m)	
			Horizontal	Vertical		Horizontal	Vertical
166.37	10.98	1.69	22.30	16.50	43.50	34.97	29.17
232.68	12.44	1.96	23.60	11.10	46.00	38.00	25.50
300.54	14.22	2.19	20.50	9.50	46.00	36.91	25.91
365.84	16.04	2.44	18.60	8.00	46.00	37.08	26.48
399.98	17.00	2.57	12.20	8.20	46.00	31.77	27.77
431.99	17.58	2.67	13.50	12.30	46.00	33.74	32.54
801.48	21.61	3.89	9.00	7.50	46.00	34.51	33.01

Remark: Emission level (dBμV/m) = Antenna Factor (dB/m) + Cable loss (dB) + Meter Reading (dBμV).

**8.7.3 TRANSMITTER RADIATED EMISSION ABOVE 1 GHz**

Product Name	802.11a/g Wireless CardBus Card	Test Date	2006/06/23
Model	AG-120	Test By	Angus Wu
Test Mode	IEEE 802.11a TX (CH Low)	TEMP & Humidity	35°C, 46%

Measurement Distance at 1m Horizontal polarity											
Freq. (MHz)	Reading (dBμV)	AF (dBμV)	Cable (dB)	Pre-amp (dB)	Dist (dB)	Filter (dB)	Level (dBμV/m)	Limit (dBμV/m)	Margin (dB)	Mark (P/Q/A)	Height (Meter)
3453.40	46.98	30.51	5.76	35.19	9.50	0.00	38.56	74.00	-35.44	P	1.00
3453.40	37.03	30.51	5.76	35.19	9.50	0.00	28.61	54.00	-25.39	A	1.00
10362.50	52.15	39.50	9.82	35.49	9.50	0.43	56.91	74.00	-17.09	P	1.00
10362.50	36.81	39.50	9.82	35.49	9.50	0.43	41.57	54.00	-12.43	A	1.00
Measurement Distance at 1m Vertical polarity											
Freq. (MHz)	Reading (dBμV)	AF (dBμV)	Cable (dB)	Pre-amp (dB)	Dist (dB)	Filter (dB)	Level (dBμV/m)	Limit (dBμV/m)	Margin (dB)	Mark (P/Q/A)	Height (Meter)
3453.40	52.40	30.51	5.76	35.19	9.50	0.00	43.98	74.00	-30.02	P	1.00
3453.40	48.64	30.51	5.76	35.19	9.50	0.00	40.22	54.00	-13.78	A	1.00
10362.50	56.30	39.50	9.82	35.49	9.50	0.43	61.06	74.00	-12.94	P	1.00
10362.50	40.49	39.50	9.82	35.49	9.50	0.43	45.25	54.00	-8.75	A	1.00

Remark:

1. AF: Antenna Factor, Cable: Cable Loss, Pre-Amp: Preamplifier gain, Filter: High Pass Filter Insertion Loss (8.2GHz)
2. Spectrum analyzer setting P(Peak): RBW=1MHz, VBW=1MHz, A(Average): RBW=1MHz, VBW=10Hz
3. Dist : correction to extra plate reading to 3m specification distance 1m measurement distance = -9.5dB
4. The result basic equation calculation is as follow:

$$\text{Level} = \text{Reading} + \text{AF} + \text{Cable} - \text{Preamp} + \text{Filter} - \text{Dist}, \text{Margin} = \text{Level} - \text{Limit}$$
5. The other emission levels were 20dB below the limit
6. The test limit distance is 3M limit.



Product Name	802.11a/g Wireless CardBus Card	Test Date	2006/06/23
Model	AG-120	Test By	Angus Wu
Test Mode	IEEE 802.11a TX (CH Middle)	TEMP & Humidity	35°C, 46%

Measurement Distance at 1m Horizontal polarity											
Freq. (MHz)	Reading (dBμV)	AF (dBμV)	Cable (dB)	Pre-amp (dB)	Dist (dB)	Filter (dB)	Level (dBμV/m)	Limit (dBμV/m)	Margin (dB)	Mark (P/Q/A)	Height (Meter)
3506.49	50.30	30.51	5.79	35.20	9.50	0.00	41.91	74.00	-32.09	P	1.00
3506.49	45.20	30.51	5.79	35.20	9.50	0.00	36.81	54.00	-17.19	A	1.00
10520.92	55.92	39.50	9.75	35.29	9.50	0.35	60.73	74.00	-13.27	P	1.00
10520.92	42.44	39.50	9.75	35.29	9.50	0.35	47.25	54.00	-6.75	A	1.00
Measurement Distance at 1m Vertical polarity											
Freq. (MHz)	Reading (dBμV)	AF (dBμV)	Cable (dB)	Pre-amp (dB)	Dist (dB)	Filter (dB)	Level (dBμV/m)	Limit (dBμV/m)	Margin (dB)	Mark (P/Q/A)	Height (Meter)
3506.49	53.23	30.51	5.79	35.20	9.50	0.00	44.84	74.00	-29.16	P	1.00
3506.49	50.22	30.51	5.79	35.20	9.50	0.00	41.83	54.00	-12.17	A	1.00
10520.92	53.09	39.50	9.75	35.29	9.50	0.35	57.90	74.00	-16.10	P	1.00
10520.92	39.07	39.50	9.75	35.29	9.50	0.35	43.88	54.00	-10.12	A	1.00

Remark:

1. AF: Antenna Factor, Cable: Cable Loss, Pre-Amp: Preamplifier gain, Filter: High Pass Filter Insertion Loss (8.2GHz)
2. Spectrum analyzer setting P(Peak): RBW=1MHz, VBW=1MHz, A(Average): RBW=1MHz, VBW=10Hz
3. Dist : correction to extra plate reading to 3m specification distance 1m measurement distance = -9.5dB
4. The result basic equation calculation is as follow:

$$\text{Level} = \text{Reading} + \text{AF} + \text{Cable} - \text{Preamp} + \text{Filter} - \text{Dist}, \text{Margin} = \text{Level} - \text{Limit}$$
5. The other emission levels were 20dB below the limit
6. The test limit distance is 3M limit.



Product Name	802.11a/g Wireless CardBus Card	Test Date	2006/06/23
Model	AG-120	Test By	Angus Wu
Test Mode	IEEE 802.11a TX (CH High)	TEMP & Humidity	35°C, 46%

Measurement Distance at 1m Horizontal polarity											
Freq. (MHz)	Reading (dBμV)	AF (dBμV)	Cable (dB)	Pre-amp (dB)	Dist (dB)	Filter (dB)	Level (dBμV/m)	Limit (dBμV/m)	Margin (dB)	Mark (P/Q/A)	Height (Meter)
3546.63	48.68	30.58	5.80	35.18	9.50	0.00	40.38	74.00	-33.62	P	1.00
3546.63	42.02	30.58	5.80	35.18	9.50	0.00	33.72	54.00	-20.28	A	1.00
10642.60	55.23	39.53	9.76	35.24	9.50	0.38	60.16	74.00	-13.84	P	1.00
10642.60	41.70	39.53	9.76	35.24	9.50	0.38	46.63	54.00	-7.37	A	1.00
Measurement Distance at 1m Vertical polarity											
Freq. (MHz)	Reading (dBμV)	AF (dBμV)	Cable (dB)	Pre-amp (dB)	Dist (dB)	Filter (dB)	Level (dBμV/m)	Limit (dBμV/m)	Margin (dB)	Mark (P/Q/A)	Height (Meter)
3546.63	50.02	30.58	5.80	35.18	9.50	0.00	41.72	74.00	-32.28	P	1.00
3546.63	44.39	30.58	5.80	35.18	9.50	0.00	36.09	54.00	-17.91	A	1.00
10642.60	53.44	39.53	9.76	35.24	9.50	0.38	58.37	74.00	-15.63	P	1.00
10642.60	38.45	39.53	9.76	35.24	9.50	0.38	43.38	54.00	-10.62	A	1.00

Remark:

1. AF: Antenna Factor, Cable: Cable Loss, Pre-Amp: Preamplifier gain, Filter: High Pass Filter Insertion Loss (8.2GHz)
2. Spectrum analyzer setting P(Peak): RBW=1MHz, VBW=1MHz, A(Average): RBW=1MHz, VBW=10Hz
3. Dist : correction to extra plate reading to 3m specification distance 1m measurement distance = -9.5dB
4. The result basic equation calculation is as follow:

$$\text{Level} = \text{Reading} + \text{AF} + \text{Cable} - \text{Preamp} + \text{Filter} - \text{Dist}, \text{Margin} = \text{Level} - \text{Limit}$$
5. The other emission levels were 20dB below the limit
6. The test limit distance is 3M limit.



8.7.4 RESTRICTED BAND EDGES

Detector mode : Peak

Polarity : Horizontal

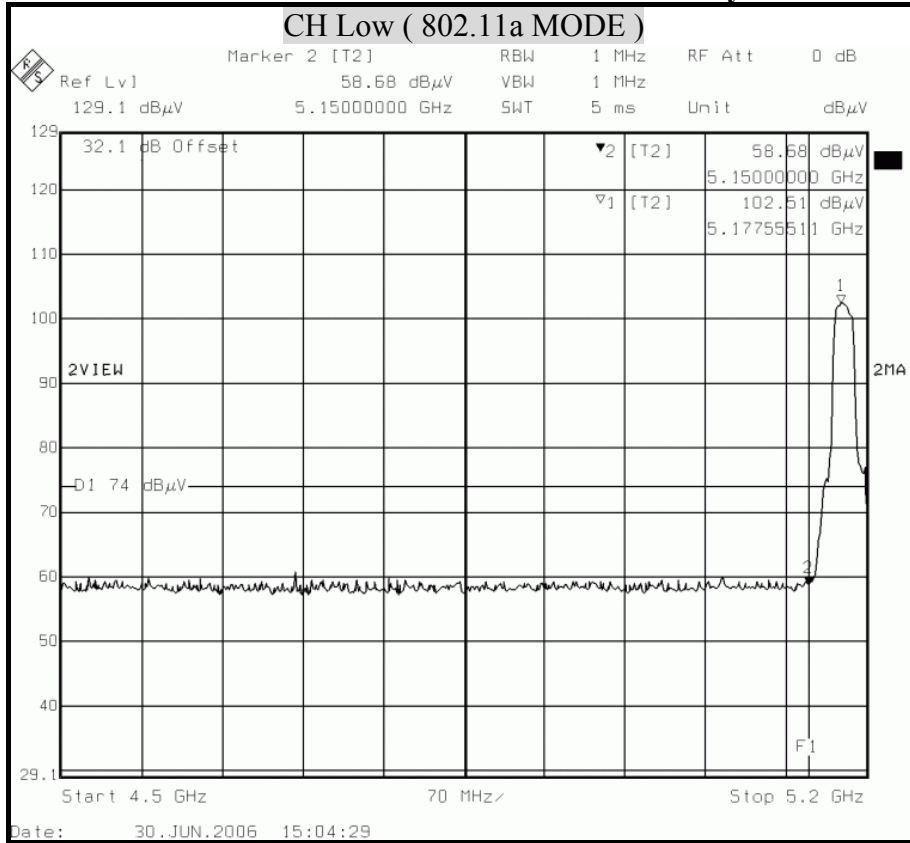

Detector mode : Average

Polarity : Horizontal

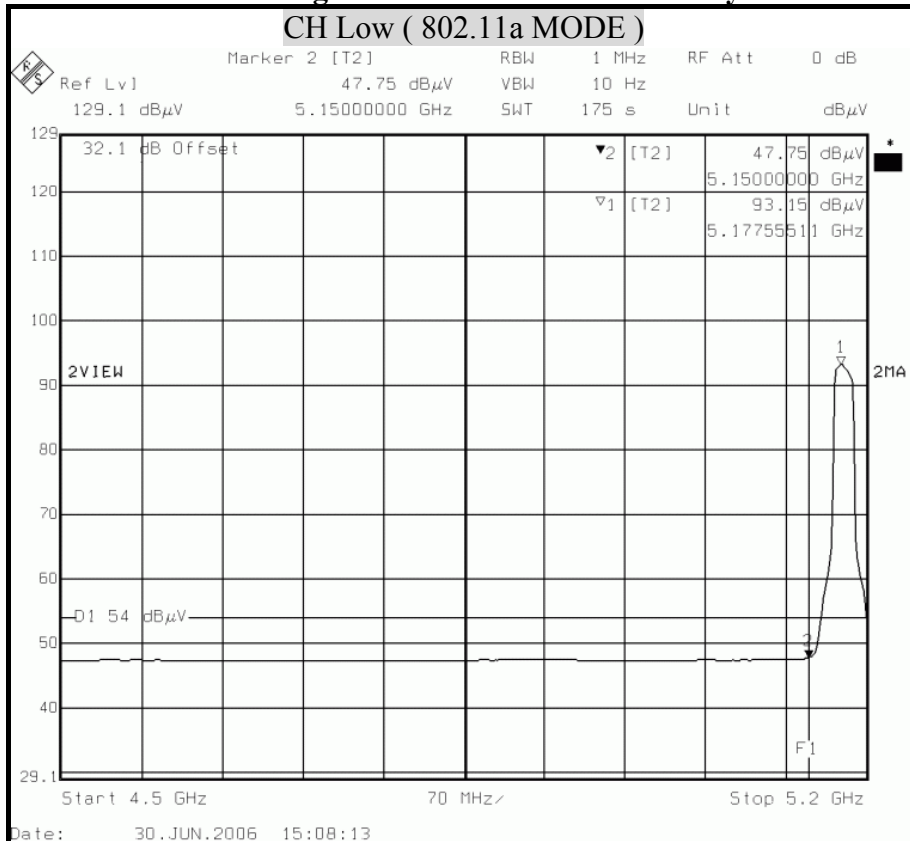



Detector mode : Peak

Polarity : Vertical

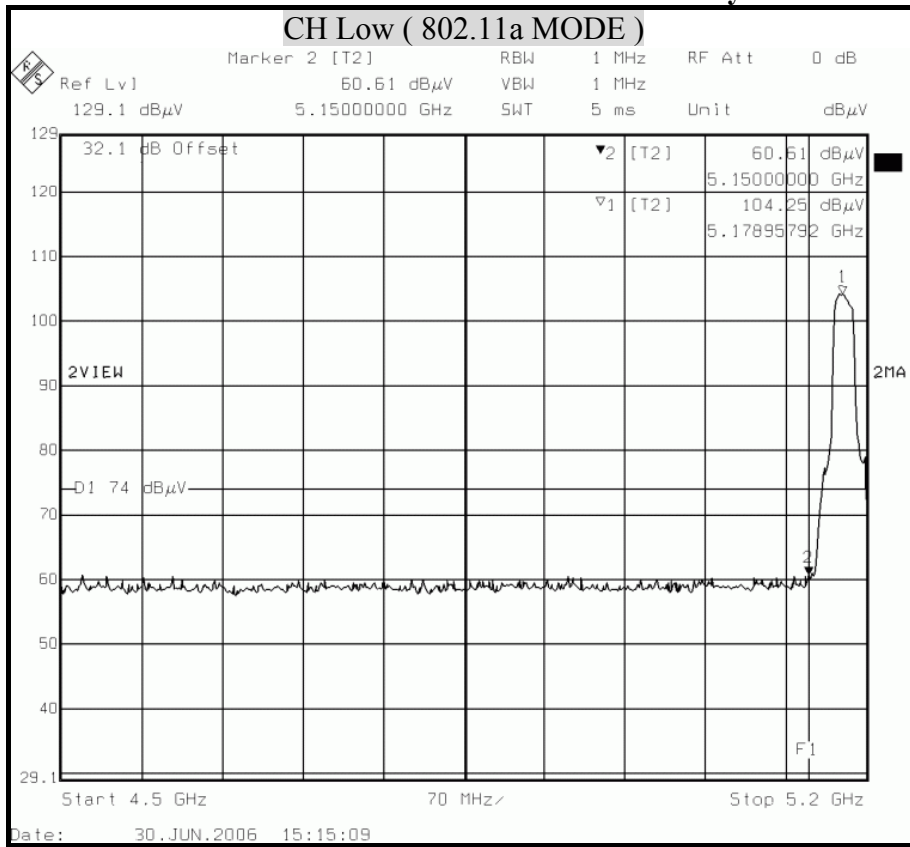

Detector mode : Average

Polarity : Vertical

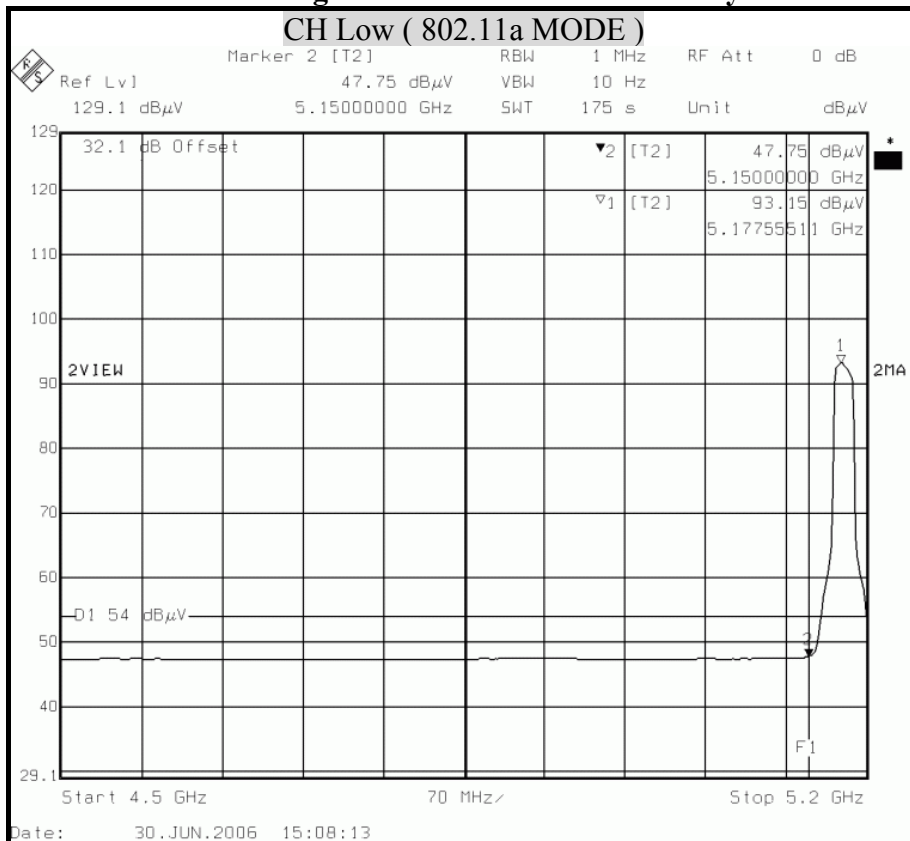



Detector mode : Peak

Polarity : Horizontal

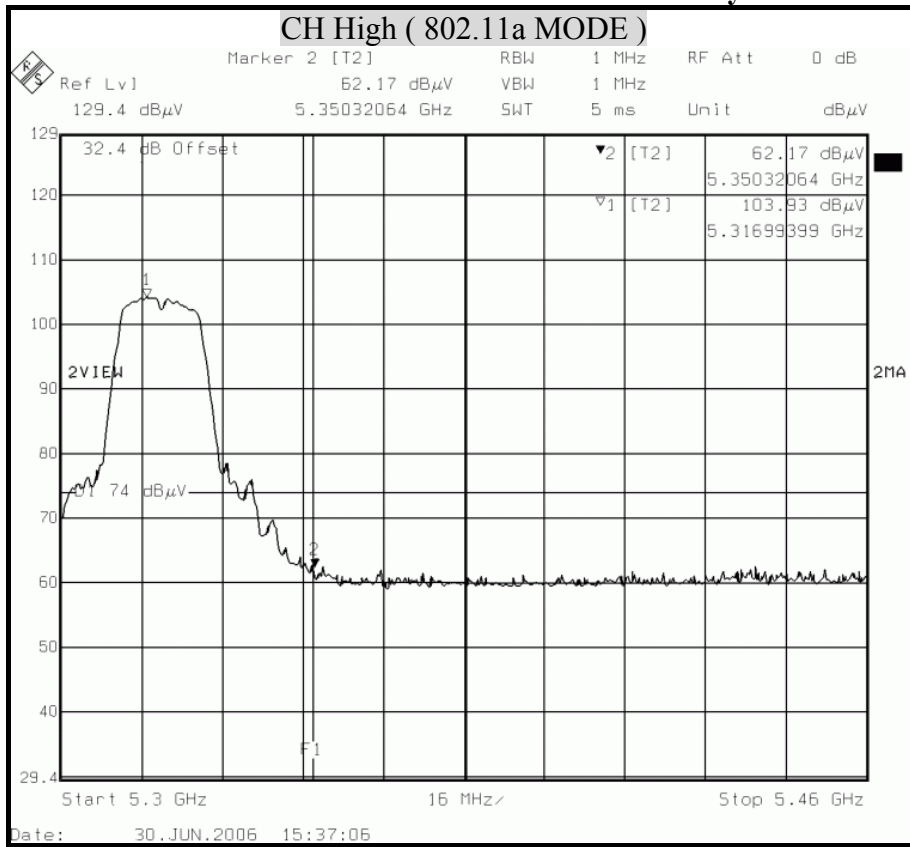

Detector mode : Average

Polarity : Horizontal

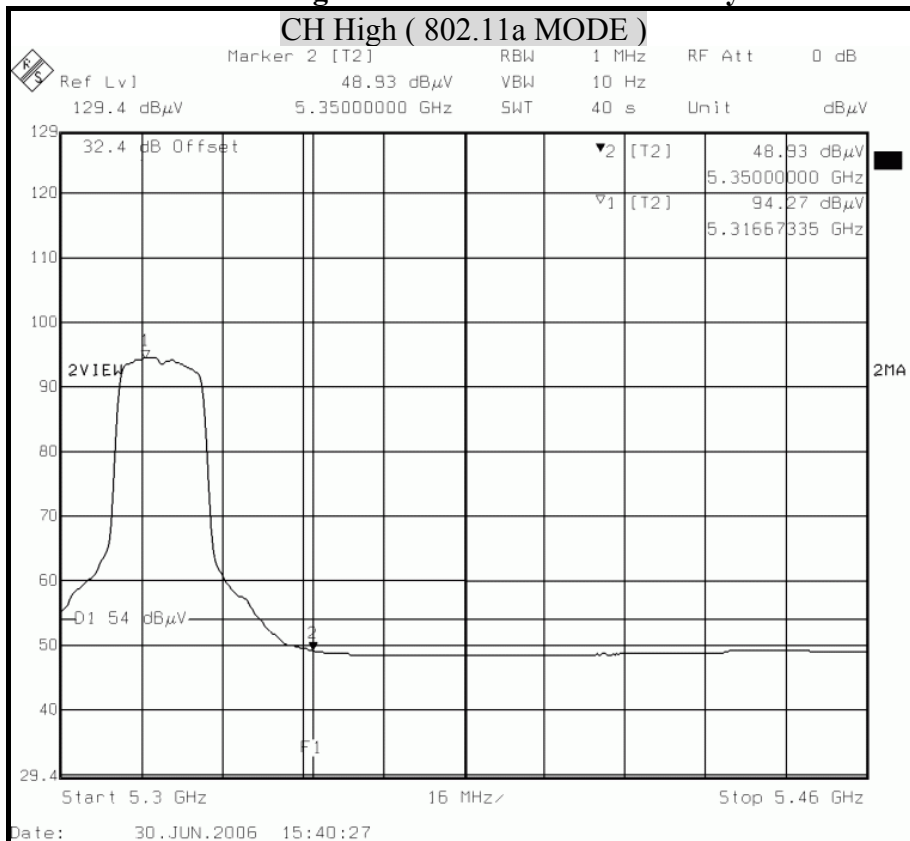



Detector mode : Peak

Polarity : Vertical

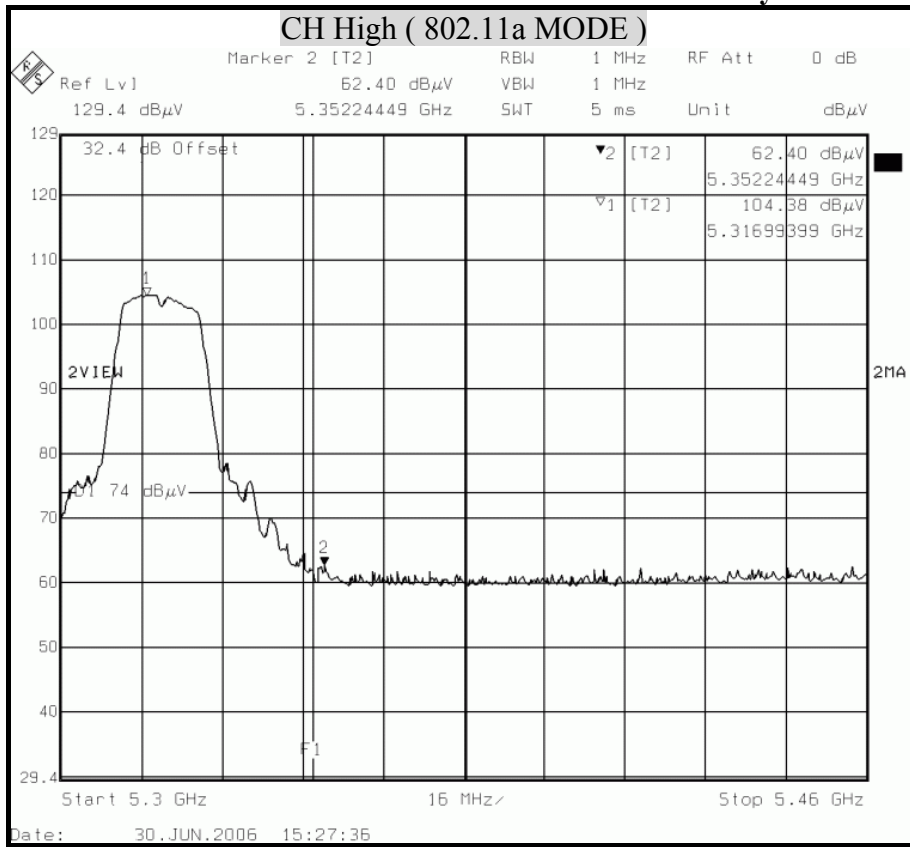

Detector mode : Average

Polarity : Vertical

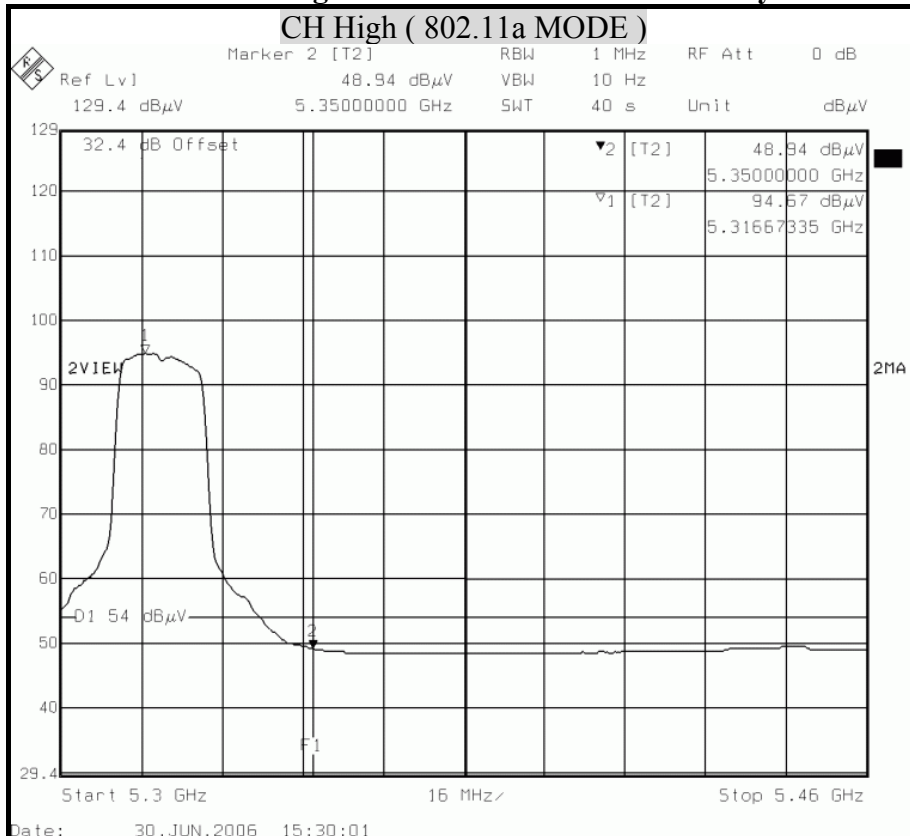



8.8 POWERLINE CONDUCTED EMISSIONS

LIMITS

§ 15.207 (a) Except as shown in paragraph (b) and (c) this section, for an intentional radiator that is designed to be connected to the public utility (AC) power line, the radio frequency voltage that is conducted back onto the AC power line on any frequency or frequencies within the band 150 kHz to 30 MHz shall not exceed the limits in the following table, as measured using a 50 μ H/50 ohms line impedance stabilization network (LISN). Compliance with the provisions of this paragraph shall be based on the measurement of the radio frequency voltage between each power line and ground at the power terminal.

The lower limit applies at the boundary between the frequency ranges.

Frequency of Emission (MHz)	Conducted limit (dB μ v)	
	Quasi-peak	Average
0.15 - 0.5	66 to 56	56 to 46
0.5 - 5	56	46
5 - 30	60	50

TEST EQUIPMENTS

The following test equipments are used during the conducted powerline tests :

Manufacturer or Type	Model No.	Serial No.	Date of Calibration	Calibration Period	Remark
EMCO L.I.S.N.	3850/2	9311-1025	January 16, 2006	1 Year	FINAL
CHASE L.I.S.N	NNLK 8129	8129118	January 16, 2006	1 Year	FINAL
R & S TEST RECEIVER	ESHS30	838550/003	February 27, 2006	1 Year	FINAL
KEENE SHIELDED ROOM	5983	No.1	N/A	N/A	FINAL
R & S PULSE LIMIT	EHS3Z2	357.8810.52	July 10, 2005	1 Year	FINAL
N TYPE COAXIAL CABLE	-----	-----	July 10, 2005	1 Year	FINAL
50 Ω TERMINATOR	-----	-----	July 10, 2005	1 Year	FINAL



TEST SETUP

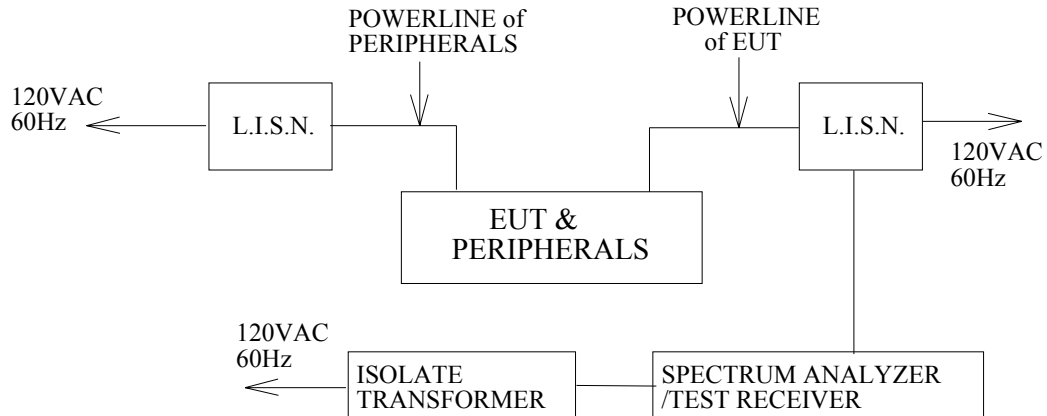

TEST PROCEDURE

The EUT is placed on a non-conducting table 40 cm from the vertical ground plane and 80cm above the horizontal ground plane. The EUT is configured in accordance with ANSI C63.4.

The resolution bandwidth is set to 9 kHz for both quasi-peak detection and average detection measurements.

Line conducted data is recorded for both NEUTRAL and LINE.

TEST RESULTS

No non-compliance noted

**CONDUCTED RF VOLTAGE MEASUREMENT**

Product Name	802.11a/g Wireless CardBus Card	Test Date	2006/0/25
Model Name	AG-120	Test By	Angus Wu
Test Mode	Normal operating (worst case)	TEMP & Humidity	27°C, 60%

LINE

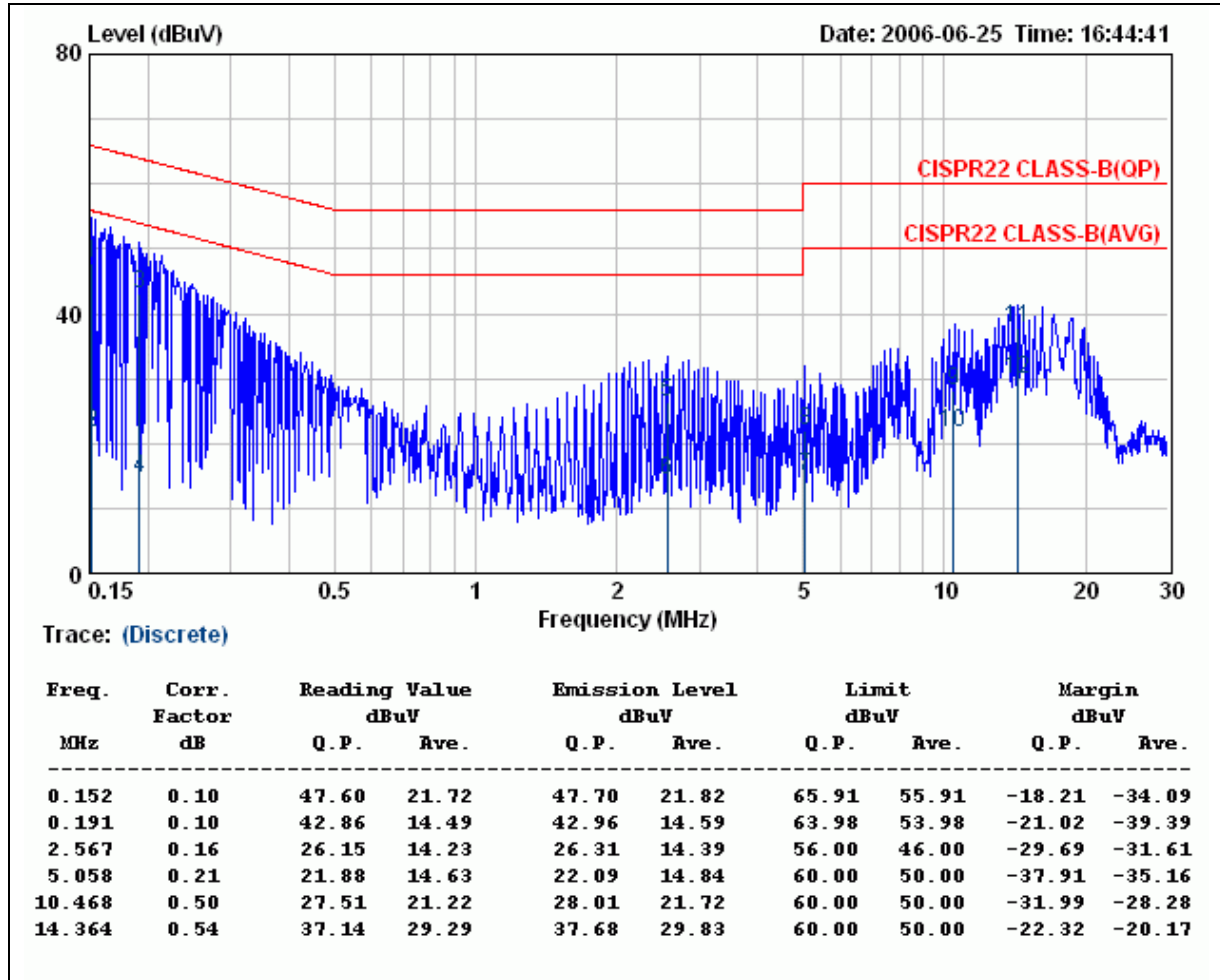
**Remark:**

1. Correction Factor = Insertion loss + cable loss
2. Margin value = Emission level - Limit value



Product Name	802.11a/g Wireless CardBus Card	Test Date	2006/0/25
Model Name	AG-120	Test By	Angus Wu
Test Mode	Normal operating (worst case)	TEMP & Humidity	27°C, 60%

NEUTRAL

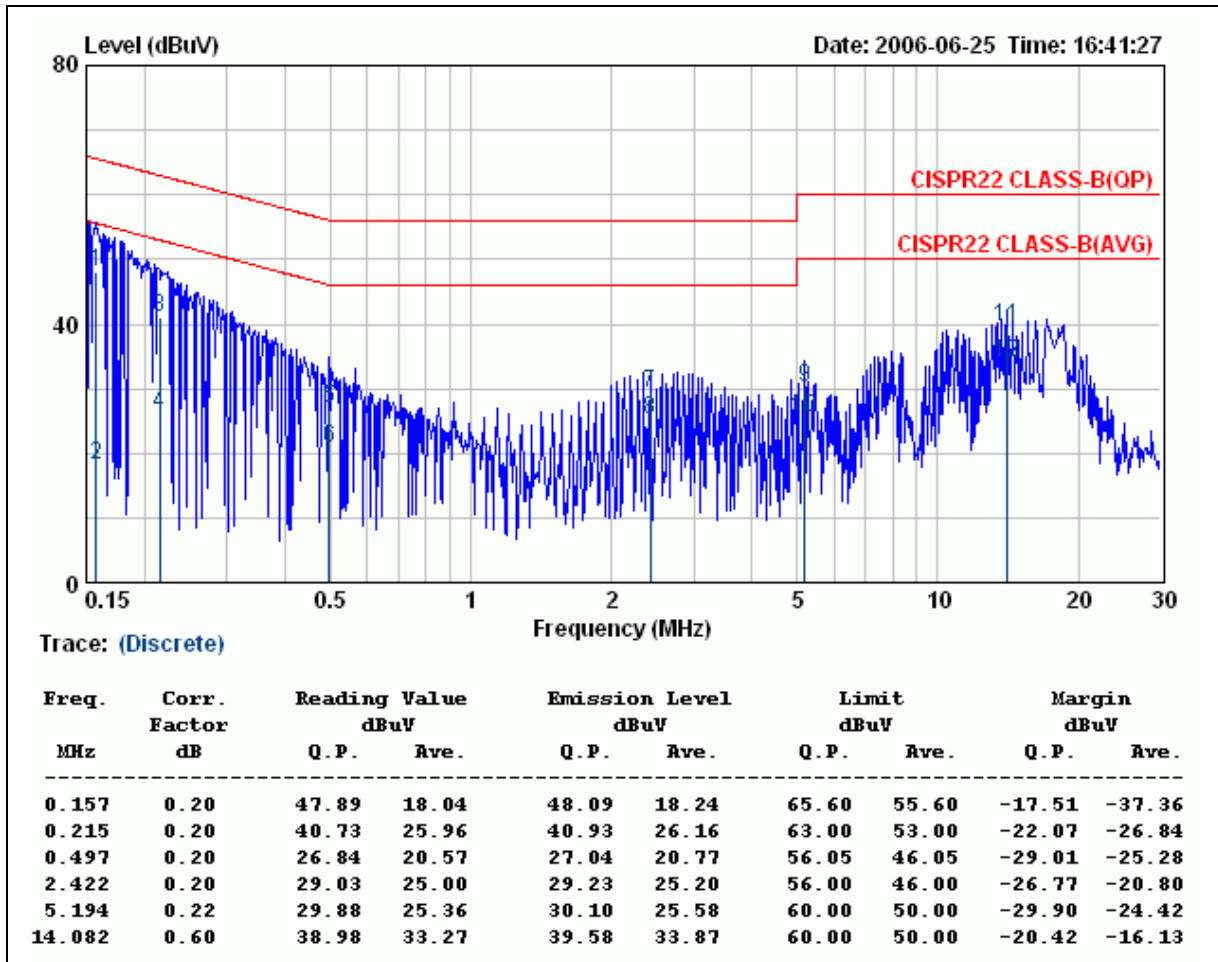

Remark:

1. Correction Factor = Insertion loss + cable loss
2. Margin value = Emission level – Limit value



9. TRANSMISSION IN ABSENCE OF DATA

LIMITS

The device shall automatically discontinue transmission in case of either absence of information to transmit or operation failure. These provisions are not intended to preclude the transmission of control or signaling information or the use of repetitive codes used by certain digital technologies to complete frame or burst intervals. Applicants shall include in their application for equipment authorization a description of how this requirement is met.

TEST RESULTS

Please refer to the operational description for details.

Remark: For the details, refer to the theory of the operation.

10. FREQUENCY STABILITY

LIMITS OF FREQUENCY STABILITY MEASUREMENT

The frequency tolerance of the carrier signal shall be maintained within +/- 0.02% of the operating frequency over a temperature variation of -30 degrees to 50 degrees C at normal supply voltage, and for a variation in the primary supply voltage from 85% to 115% of the rated supply voltage at a temperature of 20 degrees C.

TEST EQUIPMENTS

Description & Manufacturer	Model No.	Serial No.	Date of Calibration
ROHDE & SCHWARZ SPECTRUM ANALYZER	FSEK30	835253/002	September 06, 2004
AGILENT SPECTRUM ANALYZER	E4446A	MY433601.32	March 22, 2006
HP SPECTRUM ANALYZER	8595E	3829U01362	July 03, 2006

TEST SETUP

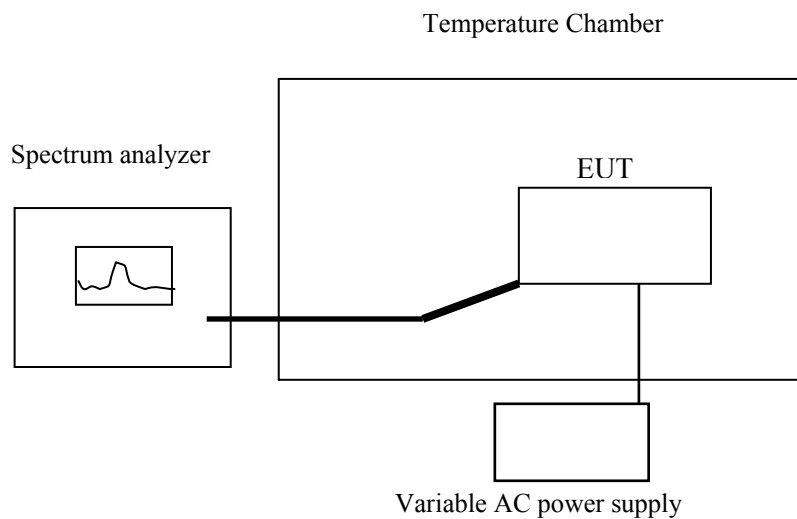

TEST PROCEDURE

1. The EUT was placed inside the environmental test chamber and powered by nominal DC voltage.
2. Turn the EUT on and couple its output to a spectrum analyzer.
3. Turn the EUT off and set the chamber to the highest temperature specified.
4. Allow sufficient time (approximately 30 min) for the temperature of the chamber to stabilize, turn the EUT on and measure the operating frequency after 2, 5, and 10 minutes.
5. Repeat step 2 and 3 with the temperature chamber set to the lowest temperature.
6. The test chamber was allowed to stabilize at +20 degree C for a minimum of 30 minutes. The supply voltage was then adjusted on the EUT from 85% to 115% and the frequency record.

**TEST RESULTS**

No non-compliance noted

Operating frequency:5320MHz								Limit:±0.02%	
Temp. (°C)	Voltage (VAC)	0 minutes		2 minutes		5 minutes		10 minutes	
		measured (MHz)	tolerance (%)	measured (MHz)	tolerance (%)	measured (MHz)	tolerance (%)	measured (MHz)	tolerance (%)
-30	102	5319.976431	-0.00044303	5319.975819	-0.00045453	5319.974017	-0.00048840	5319.971403	-0.00053754
	120	5319.976414	-0.00044335	5319.975605	-0.00045855	5319.973920	-0.00049023	5319.971360	-0.00053835
	138	5319.976309	-0.00044532	5319.975072	-0.00046857	5319.973869	-0.00049118	5319.911289	-0.00166750
-20	102	5319.993132	-0.00012910	5319.993418	-0.00012372	5319.992060	-0.00014925	5319.990195	-0.00018430
	120	5319.993330	-0.00012538	5319.993396	-0.00012414	5319.992030	-0.00014981	5319.990176	-0.00018467
	138	5319.993325	-0.00012547	5319.993361	-0.00012479	5319.992015	-0.00015009	5319.990188	-0.00018444
-10	102	5319.997671	-0.00004378	5319.997694	-0.00004335	5319.997372	-0.00004940	5319.996710	-0.00006184
	120	5319.997680	-0.00004361	5319.997688	-0.00004346	5319.997291	-0.00005092	5319.996700	-0.00006203
	138	5319.997664	-0.00004391	5319.997698	-0.00004327	5319.997206	-0.00005252	5319.996703	-0.00006197
0	102	5319.992206	-0.00014650	5319.993502	-0.00012214	5319.994472	-0.00010391	5319.995885	-0.00007735
	120	5319.992227	-0.00014611	5319.993601	-0.00012028	5319.994478	-0.00010380	5319.995890	-0.00007726
	138	5319.992214	-0.00014635	5319.993123	-0.00012927	5319.994486	-0.00010365	5319.995903	-0.00007701
10	102	5319.995488	-0.00008481	5319.995320	-0.00008797	5319.994737	-0.00009893	5319.994479	-0.00010378
	120	5319.995412	-0.00008624	5319.995274	-0.00008883	5319.994720	-0.00009925	5319.994474	-0.00010387
	138	5319.995422	-0.00008605	5319.995250	-0.00008929	5319.994714	-0.00009936	5319.994472	-0.00010391
20	102	5319.989339	-0.00020039	5319.988637	-0.00021359	5319.988242	-0.00022102	5319.987967	-0.00022618
	120	5319.989152	-0.00020391	5319.988588	-0.00021451	5319.988219	-0.00022145	5319.987982	-0.00022590
	138	5319.989205	-0.00020291	5319.988569	-0.00021487	5319.988207	-0.00022167	5319.987976	-0.00022602
30	102	5319.985859	-0.00026581	5319.985254	-0.00027718	5319.984644	-0.00028865	5319.984291	-0.00029528
	120	5319.985738	-0.00026808	5319.985207	-0.00027806	5319.984632	-0.00028887	5319.984311	-0.00029491
	138	5319.985672	-0.00026932	5319.985134	-0.00027944	5319.984620	-0.00028910	5319.984306	-0.00029500
40	102	5319.983510	-0.00030996	5319.983322	-0.00031350	5319.983263	-0.00031461	5319.983390	-0.00031222
	120	5319.983519	-0.00030979	5319.983309	-0.00031374	5319.983263	-0.00031461	5319.983388	-0.00031226
	138	5319.983485	-0.00031043	5319.983304	-0.00031383	5319.983263	-0.00031461	5319.983395	-0.00031212
50	102	5319.984632	-0.00028887	5319.986374	-0.00025613	5319.989132	-0.00020429	5319.991641	-0.00015712
	120	5319.984851	-0.00028476	5319.986545	-0.00025291	5319.989233	-0.00020239	5319.991688	-0.00015624
	138	5319.985940	-0.00026429	5319.986612	-0.00025165	5319.989349	-0.00020021	5319.991746	-0.00015515



11. ANTENNA REQUIREMENT

11.1 STANDARD APPLICABLE

For intentional device, according to FCC 47 CFR Section 15.203, an intentional radiator shall be designed to ensure that no antenna other than that furnished by the responsible party shall be used with the device.

And according to FCC 47 CFR Section 15.247 (a), if transmitting antennas of directional gain greater than 6dBi are used, the power shall be reduced by the amount in dB that the directional gain of the antenna exceeds 6dBi.

11.2 ANTENNA CONNECTED CONSTRUCTION

The antenna used for this product is PCB antenna. The peak Gain of this antenna is only 2dBi at 5GHz, 2dBi at 2.4GHz.