

FCC Test Report

FCC ID : I8811AXAP2246E
Equipment : 802.11ax (WiFi 6E) Triple-Radio Unified Pro
Access Point
Model No. : WAX640S-6E
Brand Name : ZYXEL
Applicant : Zyxel Communications Corporation
Address : No.2 Industry East RD. IX, Hsinchu Science
Park, Hsinchu 30075, Taiwan, R.O.C
Standard : 47 CFR FCC Part 15.247
Received Date : May 10, 2022
Tested Date : Jun. 08 ~ Jun. 21, 2022

We, International Certification Corporation, would like to declare that the tested sample has been evaluated and in compliance with the requirement of the above standards. The test results contained in this report refer exclusively to the product. It shall not be reproduced except in full without the written approval of our laboratory.

Reviewed by:

Approved by:



Along Chen / Assistant Manager



Gary Chang / Manager

Table of Contents

1	GENERAL DESCRIPTION	5
1.1	Information.....	5
1.2	Local Support Equipment List	8
1.3	Test Setup Chart	9
1.4	Test Equipment List and Calibration Data.....	11
1.5	Test Standards	12
1.6	Reference Guidance	12
1.7	Deviation from Test Standard and Measurement Procedure.....	12
1.8	Measurement Uncertainty	12
2	TEST CONFIGURATION	13
2.1	Testing Facility.....	13
2.2	The Worst Test Modes and Channel Details	13
3	TRANSMITTER TEST RESULTS.....	14
3.1	6dB and Occupied Bandwidth	14
3.2	Conducted Output Power	15
3.3	Power Spectral Density	16
3.4	Unwanted Emissions in Restricted Frequency Bands	17
3.5	Emissions in non-restricted Frequency Bands.....	19
3.6	AC Power Line Conducted Emissions	20
4	TEST LABORATORY INFORMATION	21

Appendix A. 6dB and Occupied Bandwidth

Appendix B. Conducted Output Power

Appendix C. Power Spectral Density

Appendix D. Unwanted Emissions into Restricted Frequency Bands

Appendix E. Emissions in Non-Restricted Frequency Bands

Appendix F. AC Power Line Conducted Emissions

Release Record

Report No.	Version	Description	Issued Date
FR251701AE	Rev. 01	Initial issue	Aug. 02, 2022

Summary of Test Results

FCC Rules	Test Items	Measured	Result
15.207	AC Power Line Conducted Emissions	[dBuV]: 0.447MHz 33.24 (Margin -13.69dB) - AV	Pass
15.247(d) 15.209	Unwanted Emissions	[dBuV/m at 3m]: 45.52MHz 36.95 (Margin -3.05dB) - QP	Pass
15.247(b)(3)	Conducted Output Power	Power [dBm]: 3.36	Pass
15.247(a)(2)	6dB Bandwidth	Meet the requirement of limit	Pass
15.247(e)	Power Spectral Density	Meet the requirement of limit	Pass
15.203	Antenna Requirement	Meet the requirement of limit	Pass

Declaration of Conformity:

The test results with all measurement uncertainty excluded are presented in accordance with the regulation limits or requirements declared by manufacturers.

Comments and Explanations:

The declared of product specification for EUT presented in the report are provided by the manufacturer, and the manufacturer takes all the responsibilities for the accuracy of product specification.

1 General Description

1.1 Information

1.1.1 Specification of the Equipment under Test (EUT)

RF General Information				
Frequency Range (MHz)	Bluetooth Mode	Ch. Freq. (MHz)	Channel Number	Data Rate
2400-2483.5	V5.2 LE	2402-2480	0-39 [40]	125 kbps
				500 kbps
				1 Mbps
				2 Mbps
Note: Bluetooth LE (Low energy) uses GFSK modulation.				

1.1.2 Antenna Details

Ant. No.	Brand	Model	Type	Connector	Gain (dBi)
1	DNI	WAX640S-6E-ANT	PIFA	No	3

1.1.3 Power Supply Type of Equipment under Test (EUT)

Power Supply Type	12Vdc from adapter 56Vdc from POE
--------------------------	--------------------------------------

Note: The above power supplies are not bundled in market.

1.1.4 Accessories

N/A

1.1.5 Channel List

Frequency band (MHz)				2400~2483.5			
Channel	Frequency (MHz)	Channel	Frequency (MHz)	Channel	Frequency (MHz)	Channel	Frequency (MHz)
37	2402	9	2422	18	2442	28	2462
0	2404	10	2424	19	2444	29	2464
1	2406	38	2426	20	2446	30	2466
2	2408	11	2428	21	2448	31	2468
3	2410	12	2430	22	2450	32	2470
4	2412	13	2432	23	2452	33	2472
5	2414	14	2434	24	2454	34	2474
6	2416	15	2436	25	2456	35	2476
7	2418	16	2438	26	2458	36	2478
8	2420	17	2440	27	2460	39	2480

1.1.6 Test Tool and Duty Cycle

Test Tool	Qualcomm Radio Control Tool, V 4.0.00195.0	
Modulation Mode	Duty Cycle Of Test Signal (%)	Duty Factor (dB)
BT-LE(125kbps)	85.00%	0.71
BT-LE(500kbps)	59.14%	2.28
BT-LE(1Mbps)	64.35%	1.91
BT-LE(2Mbps)	34.72%	4.59

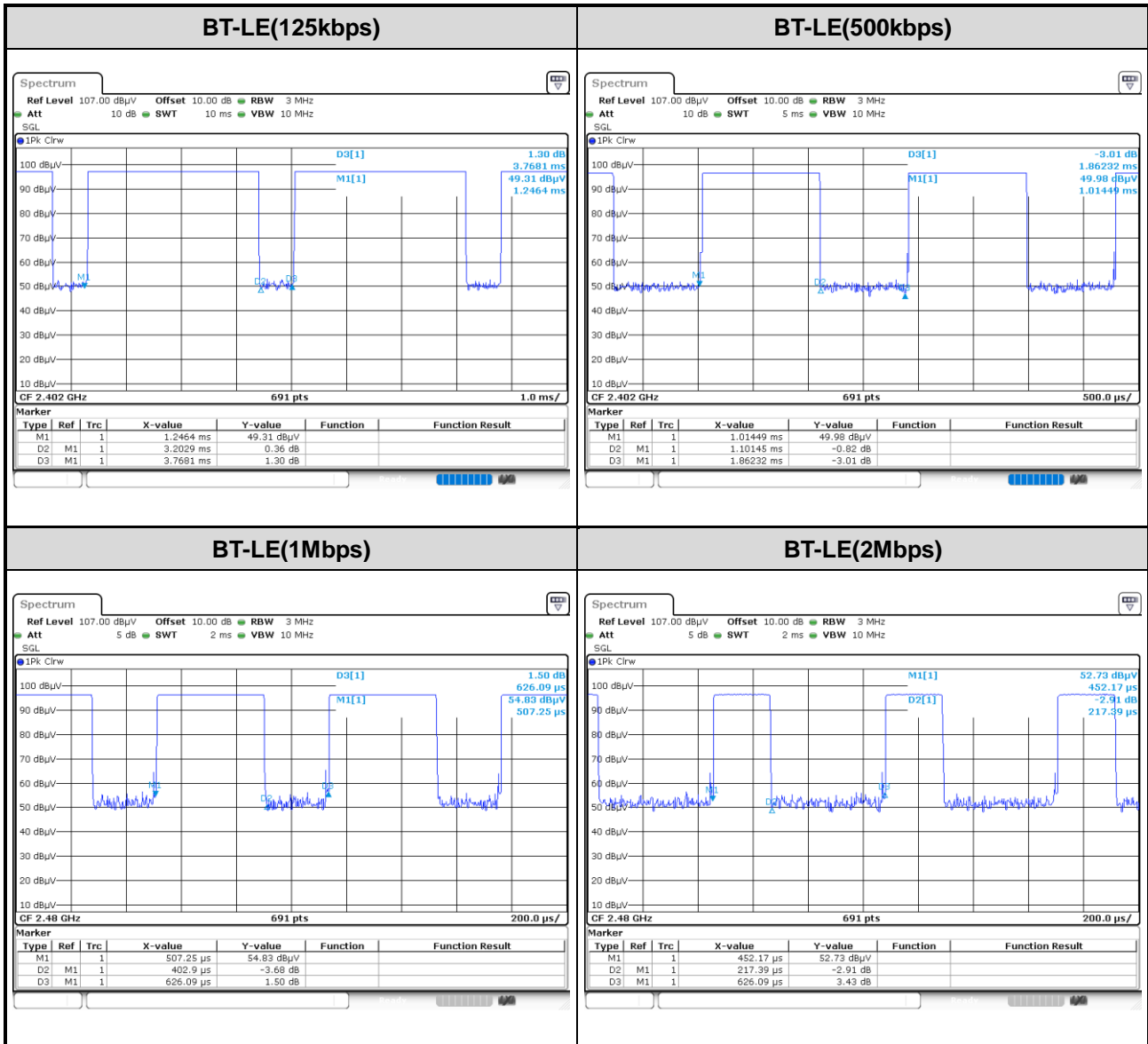

1.1.7 Power Index of Test Tool

Modulation Mode	Test Frequency (MHz)		
	2402	2440	2480
BT-LE(125kbps)	Default	Default	Default
BT-LE(500kbps)	Default	Default	Default
BT-LE(1Mbps)	Default	Default	Default
BT-LE(2Mbps)	Default	Default	Default

1.2 Local Support Equipment List

Adapter mode

Support Equipment List					
No.	Equipment	Brand	Model	FCC ID	Remarks
1	Notebook	DELL	Latitude E5470	DoC	---
2	Notebook	DELL	Latitude 5400	DoC	---
3	Adapter	APD	WA-30P12R	---	Remarks: I/P: 100-240Vac, 50-60Hz, 0.9A Max O/P: 12Vdc, 2.5A The plug can be replaced. (Provided by applicant.)

POE mode

Support Equipment List					
No.	Equipment	Brand	Model	FCC ID	Remarks
1	Notebook	DELL	Latitude E5470	DoC	---
2	Notebook	DELL	Latitude 5400	DoC	---
3	POE	ZYXEL	PoE12-60W	---	Remarks: I/P: 100-240Vac, 50-60Hz, 2.0A O/P: 56Vdc, 1.161A (Provided by applicant.)

1.3 Test Setup Chart

Adapter mode

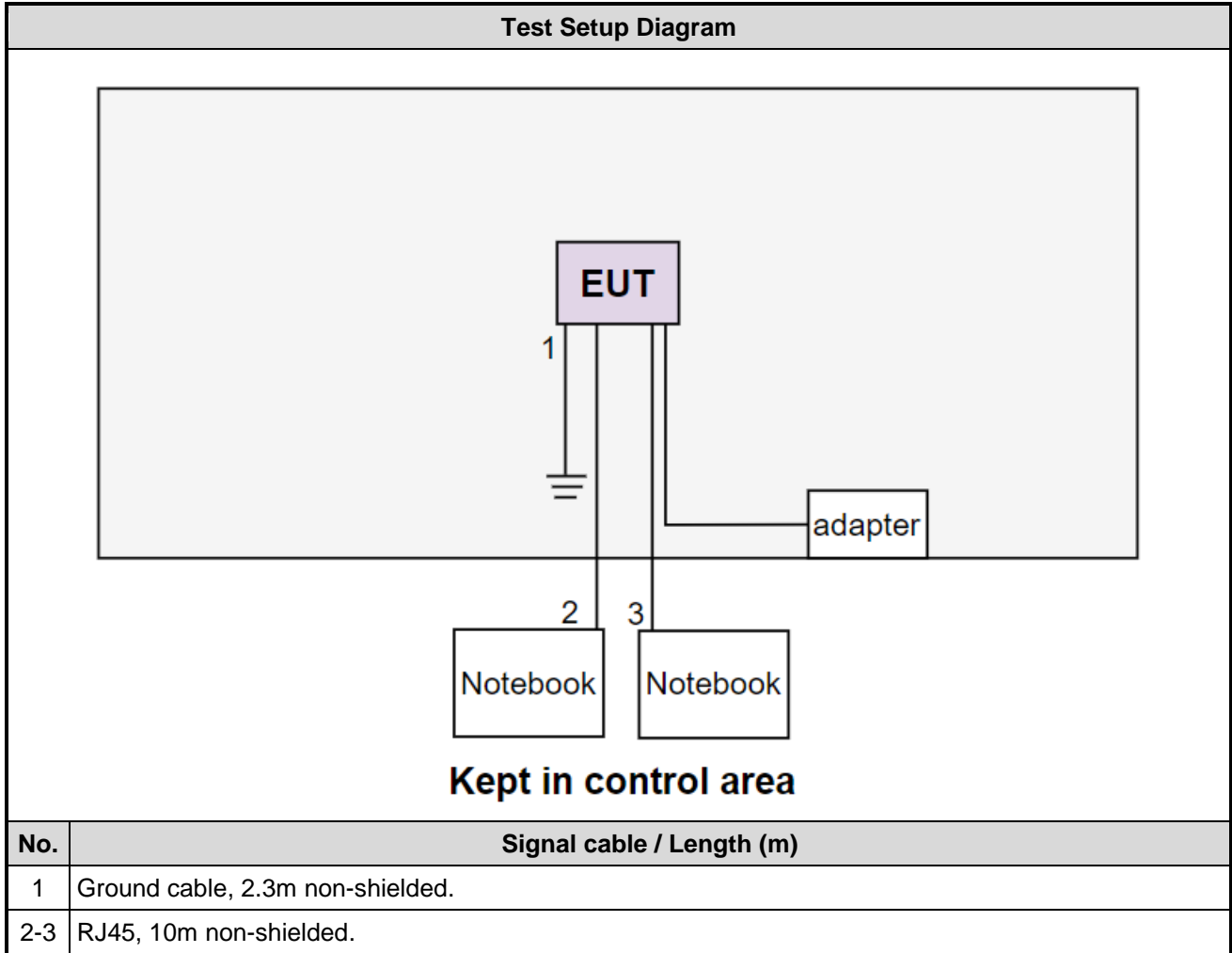

POE mode

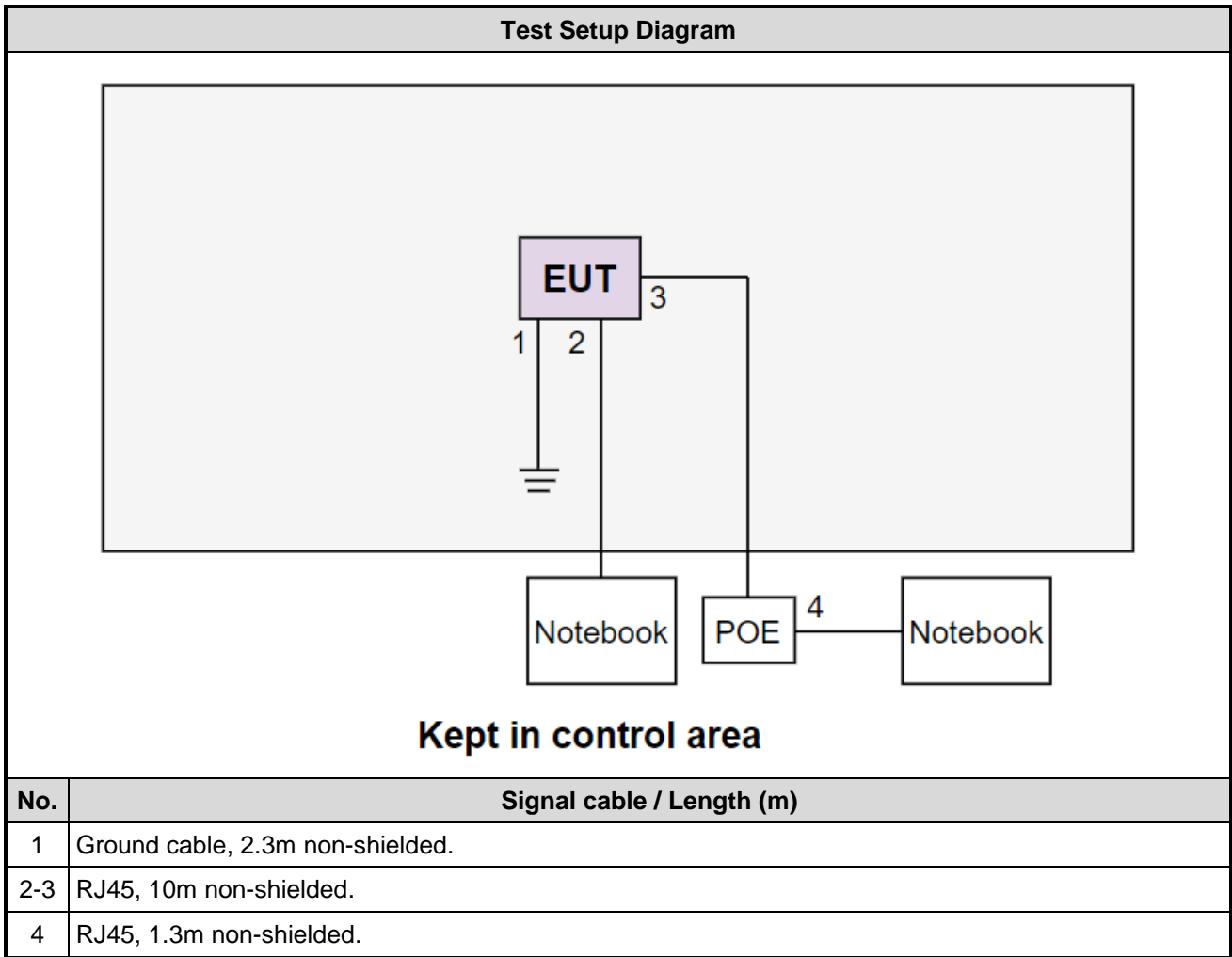

1.4 Test Equipment List and Calibration Data

Test Item	Conducted Emission				
Test Site	Conduction room 1 / (CO01-WS)				
Tested Date	Jun. 17, 2022				
Instrument	Brand	Model No.	Serial No.	Calibration Date	Calibration Until
Receiver	R&S	ESR3	101658	Feb. 16, 2022	Feb. 15, 2023
LISN	R&S	ENV216	101579	Apr. 21, 2022	Apr. 20, 2023
LISN (Support Unit)	SCHWARZBECK	Schwarzbeck 8127	8127667	Jan. 07, 2022	Jan. 06, 2023
RF Cable-CON	Woken	CFD200-NL	CFD200-NL-001	Oct. 19, 2021	Oct. 18, 2022
50 ohm terminal (Support Unit)	NA	50	01	May 10, 2022	May 09, 2023
Measurement Software	AUDIX	e3	6.120210k	NA	NA

Note: Calibration Interval of instruments listed above is one year.

Test Item	Radiated Emission				
Test Site	966 chamber3 / (03CH03-WS)				
Tested Date	Jun. 08 ~ Jun. 11, 2022				
Instrument	Brand	Model No.	Serial No.	Calibration Date	Calibration Until
Receiver	R&S	ESR3	101657	Mar. 15, 2022	Mar. 14, 2023
Spectrum Analyzer	R&S	FSV40	101499	Mar. 08, 2022	Mar. 07, 2023
Loop Antenna	R&S	HFH2-Z2	100330	Nov. 08, 2021	Nov. 07, 2022
Bilog Antenna	SCHWARZBECK	VULB9168	VULB9168-522	Jun. 30, 2021	Jun. 29, 2022
Horn Antenna 1G-18G	SCHWARZBECK	BBHA 9120 D	BBHA 9120 D 1206	Dec. 20, 2021	Dec. 19, 2022
Horn Antenna 18G-40G	SCHWARZBECK	BBHA 9170	BBHA 9170508	Jan. 11, 2022	Jan. 10, 2023
Preamplifier	EMC	EMC02325	980187	Jul. 26, 2021	Jul. 25, 2022
Preamplifier	Agilent	83017A	MY39501309	Sep. 06, 2021	Sep. 05, 2022
Preamplifier	EMC	EMC184045B	980192	Jul. 14, 2021	Jul. 13, 2022
Loop Antenna Cable	KOAX KABEL	101354-BW	101354-BW	Oct. 05, 2021	Oct. 04, 2022
LF cable 3M	EMC	EMC8D-NM-NM-800	EMC8D-NM-NM-800-001	Sep. 24, 2021	Sep. 23, 2022
LF cable 11M	EMC	EMC8D-NM-NM-3000	131103	Sep. 24, 2021	Sep. 23, 2022
LF cable 1M	EMC	EMC8D-NM-NM-13000	131104	Sep. 24, 2021	Sep. 23, 2022
RF Cable	HUBER+SUHNER	SUCOFLEX104	MY22620/4	Sep. 24, 2021	Sep. 23, 2022
RF Cable	EMC	EMC104-SM-SM-8000	181107	Sep. 24, 2021	Sep. 23, 2022
Measurement Software	AUDIX	e3	6.120210g	NA	NA

Note: Calibration Interval of instruments listed above is one year.

Test Item	RF Conducted				
Test Site	(TH01-WS)				
Tested Date	Jun. 21, 2022				
Instrument	Brand	Model No.	Serial No.	Calibration Date	Calibration Until
Spectrum Analyzer	R&S	FSV40	101910	Apr. 18, 2022	Apr. 17, 2023
Power Meter	Anritsu	ML2495A	1241002	Nov. 07, 2021	Nov. 06, 2022
Power Sensor	Anritsu	MA2411B	1207366	Nov. 07, 2021	Nov. 06, 2022
Measurement Software	Sporton	SENSE-15247_DTS	V5.10.7.18	NA	NA
Note: Calibration Interval of instruments listed above is one year.					

1.5 Test Standards

47 CFR FCC Part 15.247
ANSI C63.10-2013

1.6 Reference Guidance

FCC KDB 558074 D01 15.247 Meas Guidance v05r02

1.7 Deviation from Test Standard and Measurement Procedure

None

1.8 Measurement Uncertainty

The measurement uncertainties given below are based on a 95% confidence level (based on a coverage factor ($k=2$)).

Measurement Uncertainty	
Parameters	Uncertainty
Bandwidth	± 34.130 Hz
Conducted power	± 0.808 dB
Power density	± 0.583 dB
Conducted emission	± 2.715 dB
AC conducted emission	± 2.92 dB
Unwanted Emission ≤ 1 GHz	± 3.96 dB
Unwanted Emission > 1 GHz	± 4.51 dB

2 Test Configuration

2.1 Testing Facility

Test Laboratory	International Certification Corporation
Test Site	CO01-WS, TH01-WS
Address of Test Site	No.3-1, Lane 6, Wen San 3rd St., Kwei Shan Dist., Tao Yuan City 33381, Taiwan (R.O.C.)
Test Site	03CH03-WS
Address of Test Site	No.14-1, Lane 19, Wen San 3rd St., Kwei Shan Dist., Tao Yuan City 333, Taiwan (R.O.C.)

- FCC Designation No.: TW0009
- FCC site registration No.: 207696
- ISED#: 10807C
- CAB identifier: TW2732

2.2 The Worst Test Modes and Channel Details

Test item	Mode	Test Frequency (MHz)	Test Configuration
AC Power Line Conducted Emissions	BT-LE(2Mbps)	2402	1,2
Unwanted Emissions ≤ 1GHz	BT-LE(2Mbps)	2402	1,2
Unwanted Emissions > 1GHz	BT-LE(1Mbps) BT-LE(2Mbps)	2402, 2440, 2480	1
Conducted Output Power 6dB bandwidth Power spectral density	BT-LE(125kbps) BT-LE(500kbps) BT-LE(1Mbps) BT-LE(2Mbps)	2402, 2440, 2480	1
NOTE:			
1. The EUT was pretested with 3 orientations placed on the table for the radiated emission measurement – X, Y, and Z-plane. The Z-plane results were found as the worst case and were shown in this report.			
2. Test configurations are listed as below:			
1) Configuration 1: Adapter Mode			
2) Configuration 2: POE Mode			

3 Transmitter Test Results

3.1 6dB and Occupied Bandwidth

3.1.1 Limit of 6dB Bandwidth

The minimum 6dB bandwidth shall be at least 500 kHz.

3.1.2 Test Procedures

6dB Bandwidth

1. Set resolution bandwidth (RBW) = 100 kHz, Video bandwidth = 300 kHz.
2. Detector = Peak, Trace mode = max hold.
3. Sweep = auto couple, Allow the trace to stabilize.
4. Measure the maximum width of the emission that is constrained by the frequencies associated with the two outermost amplitude points (upper and lower) that are attenuated by 6dB relative to the maximum level measured in the fundamental emission.

Occupied Bandwidth

1. Set resolution bandwidth (RBW) = 1% ~ 5 % of OBW, Video bandwidth = 3 x RBW
2. Detector = Sample, Trace mode = max hold.
3. Sweep = auto couple, Allow the trace to stabilize.
4. Use the OBW measurement function of spectrum analyzer to measure the occupied bandwidth.

3.1.3 Test Setup

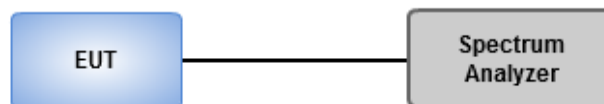

3.1.4 Test Results

Ambient Condition	24°C / 63%	Tested By	Roger Lu
--------------------------	------------	------------------	----------

Refer to Appendix A.

3.2 Conducted Output Power

3.2.1 Limit of Conducted Output Power

Conducted power shall not exceed 1Watt.

Antenna gain $\leq 6\text{dBi}$, no any corresponding reduction is in output power limit.

3.2.2 Test Procedures

A broadband RF power meter is used for output power measurement. The video bandwidth of power meter is greater than DTS bandwidth of EUT. If duty cycle of test signal is not 100 %, trigger and gating function of power meter will be enabled to capture transmission burst for measuring output power.

3.2.3 Test Setup

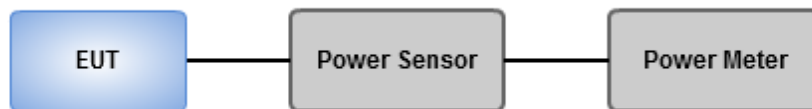

3.2.4 Test Results

Ambient Condition	24°C / 63%	Tested By	Roger Lu
--------------------------	------------	------------------	----------

Refer to Appendix B.

3.3 Power Spectral Density

3.3.1 Limit of Power Spectral Density

Power spectral density shall not be greater than 8 dBm in any 3 kHz band.

3.3.2 Test Procedures

1. Set the RBW = 3 kHz, VBW = 10 kHz.
2. Detector = Peak, Sweep time = auto couple.
3. Trace mode = max hold, allow trace to fully stabilize.
4. Use the peak marker function to determine the maximum amplitude level.

3.3.3 Test Setup

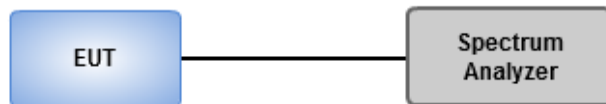

3.3.4 Test Results

Ambient Condition	24°C / 63%	Tested By	Roger Lu
--------------------------	------------	------------------	----------

Refer to Appendix C.

3.4 Unwanted Emissions in Restricted Frequency Bands

3.4.1 Limit of Unwanted Emissions in Restricted Frequency Bands

Restricted Band Emissions Limit			
Frequency Range (MHz)	Field Strength (uV/m)	Field Strength (dBuV/m)	Measure Distance (m)
0.009~0.490	2400/F(kHz)	48.5 - 13.8	300
0.490~1.705	24000/F(kHz)	33.8 - 23	30
1.705~30.0	30	29	30
30~88	100	40	3
88~216	150	43.5	3
216~960	200	46	3
Above 960	500	54	3

Note 1:
Quasi-Peak value is measured for frequency below 1GHz except for 9–90 kHz, 110–490 kHz frequency band. Peak and average value are measured for frequency above 1GHz. The limit on average radio frequency emission is as above table. The limit on peak radio frequency emissions is 20 dB above the maximum permitted average emission limit

Note 2:
Measurements may be performed at a distance other than what is specified provided. When performing measurements at a distance other than that specified, the results shall be extrapolated to the specified distance using an extrapolation factor as below, Frequency at or above 30 MHz: 20 dB/decade Frequency below 30 MHz: 40 dB/decade.

3.4.2 Test Procedures

1. Measurement is made at a semi-anechoic chamber that incorporates a turntable allowing a EUT rotation of 360°. A continuously-rotating, remotely-controlled turntable is installed at the test site to support the EUT and facilitate determination of the direction of maximum radiation for each EUT emission frequency. The EUT is placed at test table. For emissions testing at or below 1 GHz, the table height is 80 cm above the reference ground plane. For emission measurements above 1 GHz, the table height is 1.5 m
2. Measurement is made with the antenna positioned in both the horizontal and vertical planes of polarization. The measurement antenna is varied in height (1m ~ 4m) above the reference ground plane to obtain the maximum signal strength. Distance between EUT and antenna is 3 m.
3. This investigation is performed with the EUT rotated 360°, the antenna height scanned between 1 m and 4 m, and the antenna rotated to repeat the measurements for both the horizontal and vertical antenna polarizations.

Note:

1. 120kHz measurement bandwidth of test receiver and Quasi-peak detector is for radiated emission below 1GHz.
2. RBW=1MHz, VBW=3MHz and Peak detector is for peak measured value of radiated emission above 1GHz.
3. RBW=1MHz, VBW=1/T and Peak detector is for average measured value of radiated emission above 1GHz.

3.4.3 Test Setup

Radiated Emissions below 1 GHz

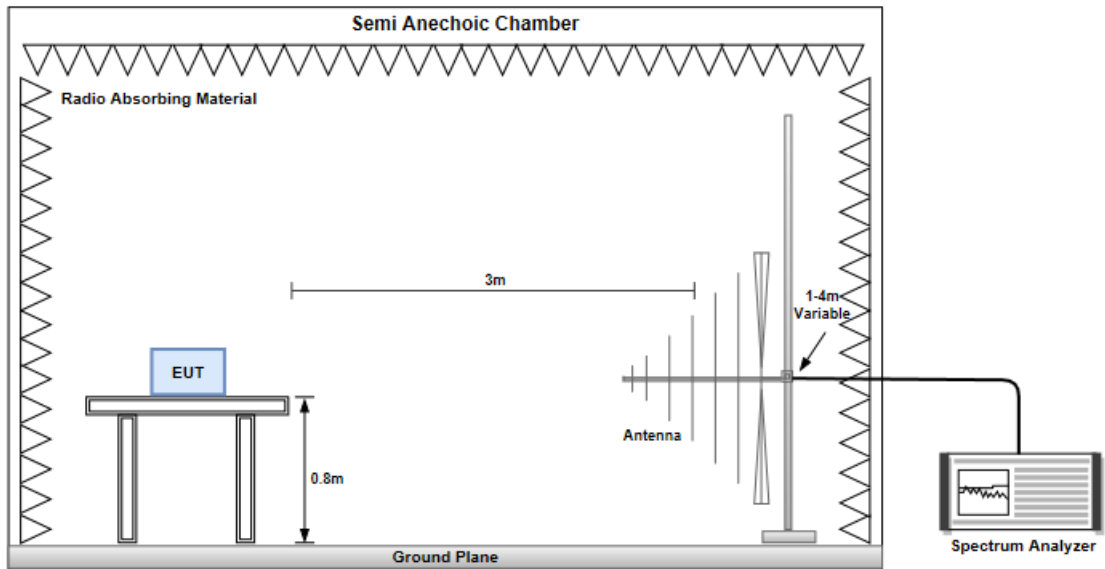

Radiated Emissions above 1 GHz

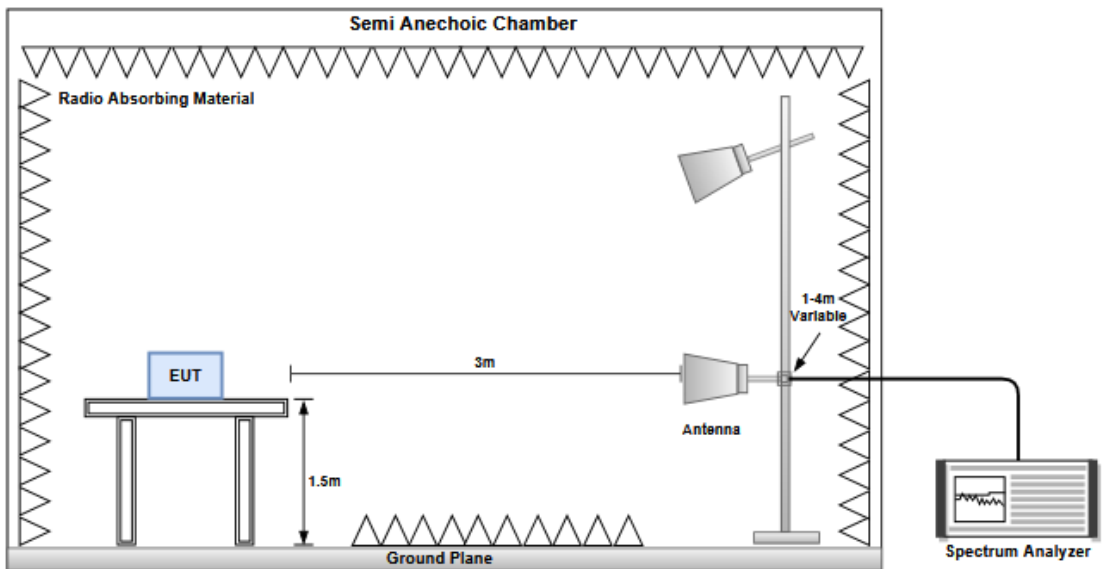

3.4.4 Test Results

Refer to Appendix D.

3.5 Emissions in non-restricted Frequency Bands

3.5.1 Emissions in non-restricted frequency bands limit

Peak power in any 100 kHz bandwidth outside of the authorized frequency band shall be attenuated by at least 20 dB relative to the maximum in-band peak PSD level in 100 kHz.

3.5.2 Test Procedures

Reference level measurement

1. Set RBW=100kHz, VBW = 300kHz , Detector = Peak, Sweep time = Auto
2. Trace = max hold , Allow Trace to fully stabilize
3. Use the peak marker function to determine the maximum PSD level

Emission level measurement

1. Set RBW=100kHz, VBW = 300kHz , Detector = Peak, Sweep time = Auto
2. Trace = max hold , Allow Trace to fully stabilize
3. Scan Frequency range is up to 25GHz
4. Use the peak marker function to determine the maximum amplitude level

3.5.3 Test Setup

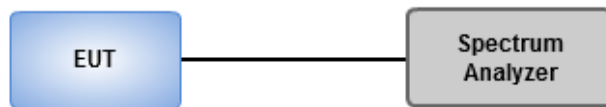

3.5.4 Test Results

Ambient Condition	24°C / 63%	Tested By	Roger Lu
--------------------------	------------	------------------	----------

Refer to Appendix E.

3.6 AC Power Line Conducted Emissions

3.6.1 Limit of AC Power Line Conducted Emissions

Conducted Emissions Limit		
Frequency Emission (MHz)	Quasi-Peak	Average
0.15-0.5	66 - 56 *	56 - 46 *
0.5-5	56	46
5-30	60	50

Note 1: * Decreases with the logarithm of the frequency.

3.6.2 Test Procedures

1. The device is placed on a test table, raised 80 cm above the reference ground plane. The vertical conducting plane is located 40 cm to the rear of the device.
2. The device is connected to line impedance stabilization network (LISN) and other accessories are connected to other LISN. Measured levels of AC power line conducted emission are across the 50 Ω LISN port.
3. AC conducted emission measurements is made over frequency range from 150 kHz to 30 MHz.
4. This measurement was performed with AC 120V/60Hz

3.6.3 Test Setup

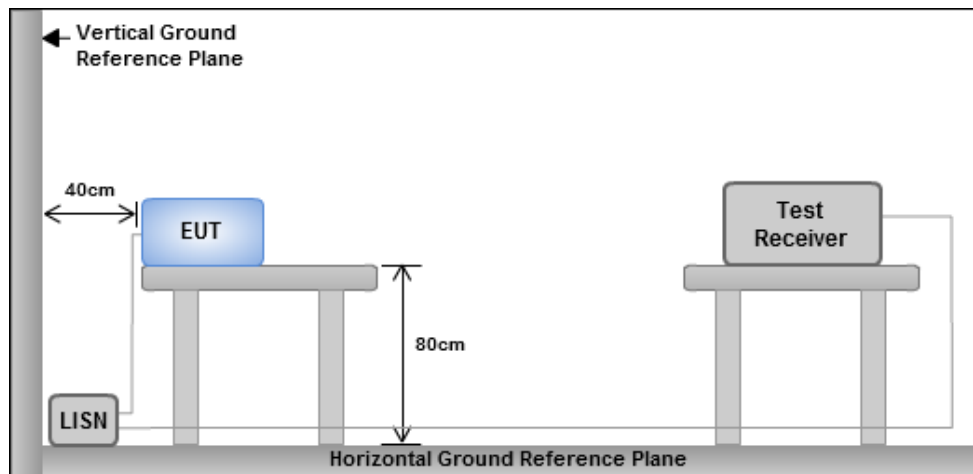

- Note: 1. Support units were connected to second LISN.
 2. Both of LISNs (AMN) are 80 cm from EUT and at least 80 cm from other units and other metal planes

3.6.4 Test Results

Refer to Appendix F.

4 Test laboratory information

Established in 2012, ICC provides foremost EMC & RF Testing and advisory consultation services by our skilled engineers and technicians. Our services employ a wide variety of advanced edge test equipment and one of the widest certification extents in the business.

International Certification Corporation (EMC and Wireless Communication Laboratory), it is our definitive objective is to institute long term, trust-based associations with our clients. The expectation we set up with our clients is based on outstanding service, practical expertise and devotion to a certified value structure. Our passion is to grant our clients with best EMC / RF services by oriented knowledgeable and accommodating staff.

Our Test sites are located at Linkou District and Kwei Shan District. Location map can be found on our website <http://www.icertifi.com.tw>.

Linkou

Tel: 886-2-2601-1640

No.30-2, Ding Fwu Tsuen, Lin Kou
District, New Taipei City, Taiwan
(R.O.C.)

Kwei Shan

Tel: 886-3-271-8666

No.3-1, Lane 6, Wen San 3rd
St., Kwei Shan Dist., Tao Yuan
City 33381, Taiwan (R.O.C.)
No.2-1, Lane 6, Wen San 3rd
St., Kwei Shan Dist., Tao Yuan
City 33381, Taiwan (R.O.C.)

Kwei Shan Site II

Tel: 886-3-271-8640

No.14-1, Lane 19, Wen San 3rd
St., Kwei Shan Dist., Tao Yuan
City 333, Taiwan (R.O.C.)

If you have any suggestion, please feel free to contact us as below information.

Tel: 886-3-271-8666

Fax: 886-3-318-0155

Email: ICC_Service@icertifi.com.tw

==END==



Summary

Mode	Max-N dB (Hz)	Max-OBW (Hz)	ITU-Code	Min-N dB (Hz)	Min-OBW (Hz)
2.4-2.4835GHz	-	-	-	-	-
BT-LE(125kbps)	630.435k	1.049M	1M05F1D	626.812k	1.046M
BT-LE(500kbps)	663.043k	1.02M	1M02F1D	655.797k	1.017M
BT-LE(1Mbps)	681.159k	1.02M	1M02F1D	666.667k	1.02M
BT-LE(2Mbps)	1.174M	2.012M	2M01F1D	1.138M	2.012M

Max-N dB = Maximum 6dB down bandwidth; Max-OBW = Maximum 99% occupied bandwidth;
Min-N dB = Minimum 6dB down bandwidth; Min-OBW = Minimum 99% occupied bandwidth

Result

Mode	Result	Limit (Hz)	Port 1-N dB (Hz)	Port 1-OBW (Hz)
BT-LE(125kbps)	-	-	-	-
2402MHz	Pass	500k	626.812k	1.046M
2440MHz	Pass	500k	630.435k	1.049M
2480MHz	Pass	500k	626.812k	1.049M
BT-LE(500kbps)	-	-	-	-
2402MHz	Pass	500k	663.043k	1.017M
2440MHz	Pass	500k	655.797k	1.02M
2480MHz	Pass	500k	663.043k	1.017M
BT-LE(1Mbps)	-	-	-	-
2402MHz	Pass	500k	673.913k	1.02M
2440MHz	Pass	500k	666.667k	1.02M
2480MHz	Pass	500k	681.159k	1.02M
BT-LE(2Mbps)	-	-	-	-
2402MHz	Pass	500k	1.138M	2.012M
2440MHz	Pass	500k	1.138M	2.012M
2480MHz	Pass	500k	1.174M	2.012M

Port X-N dB = Port X 6dB down bandwidth;
Port X-OBW = Port X 99% occupied bandwidth

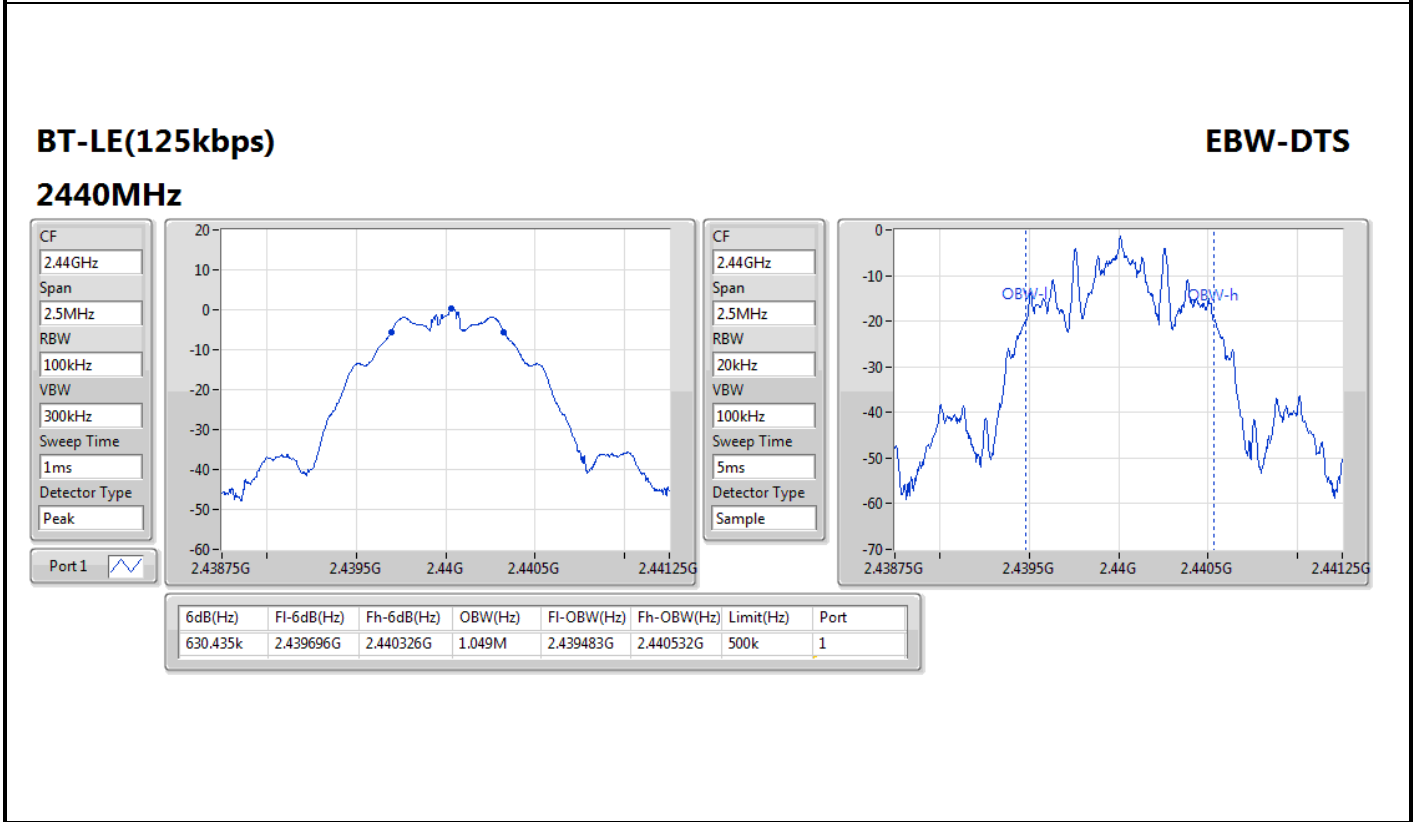
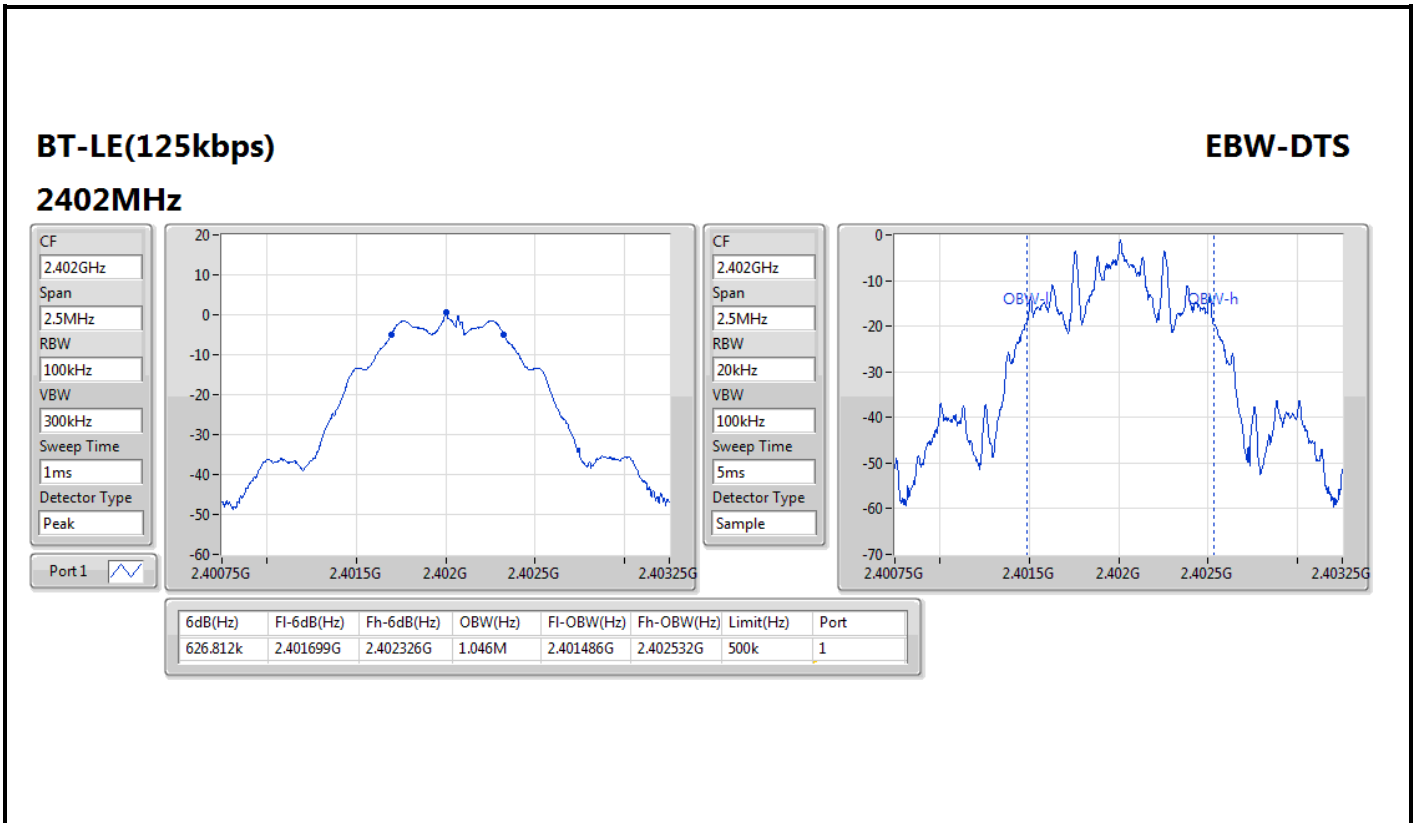



BT-LE(125kbps)

EBW-DTS

2480MHz

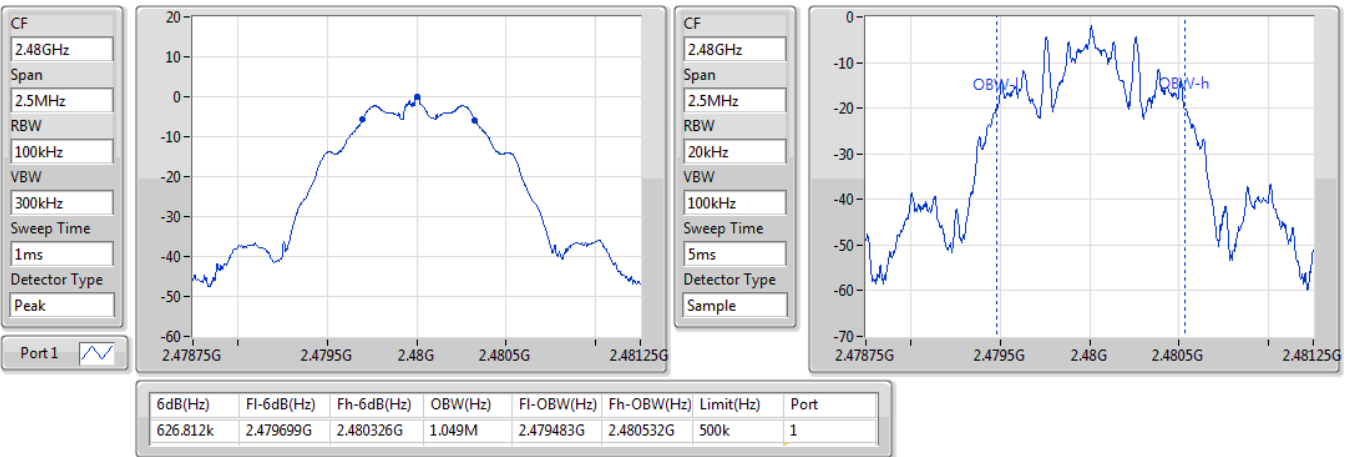

BT-LE(500kbps)

EBW-DTS

2402MHz

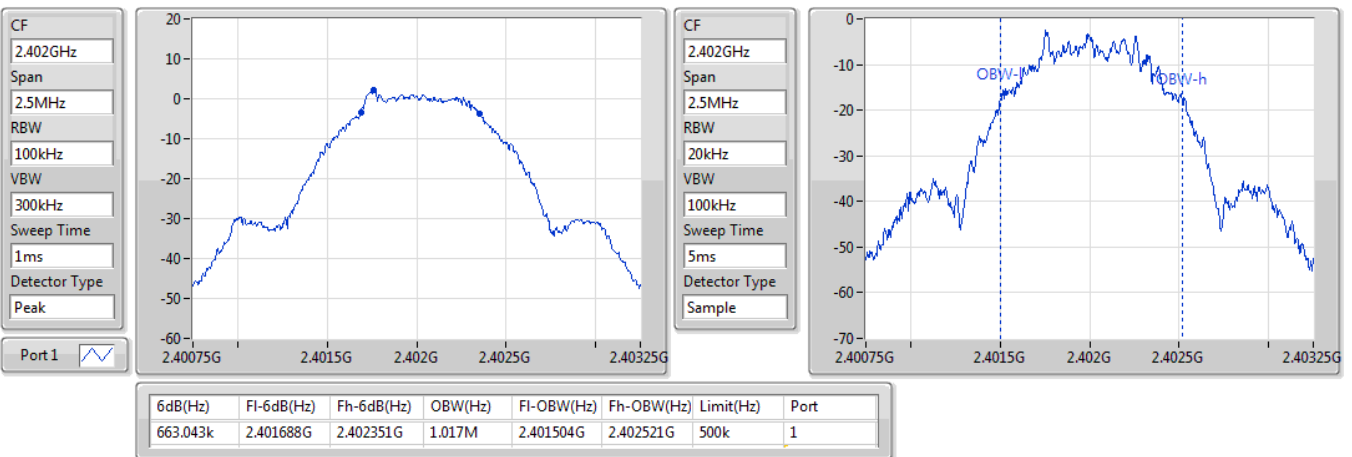

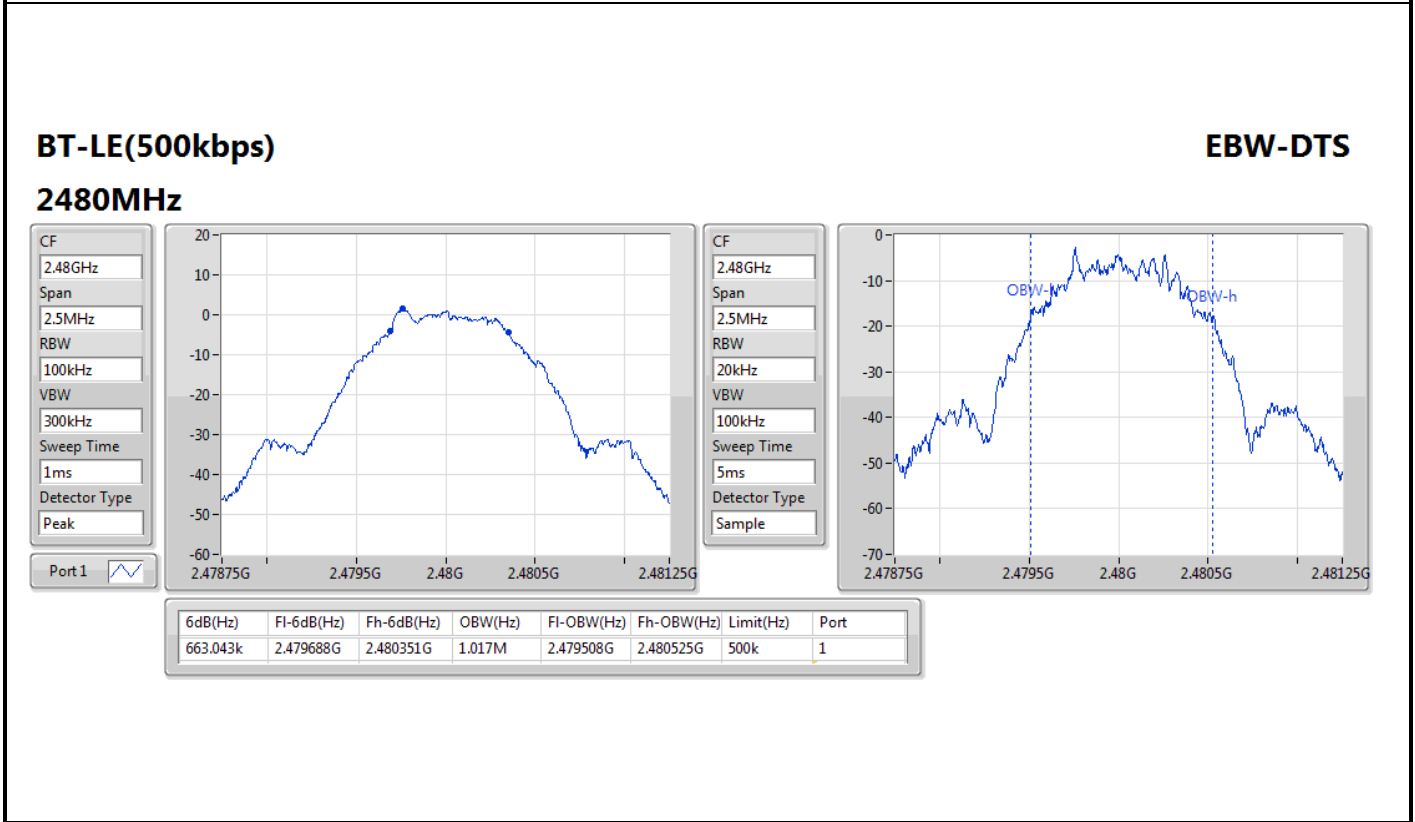
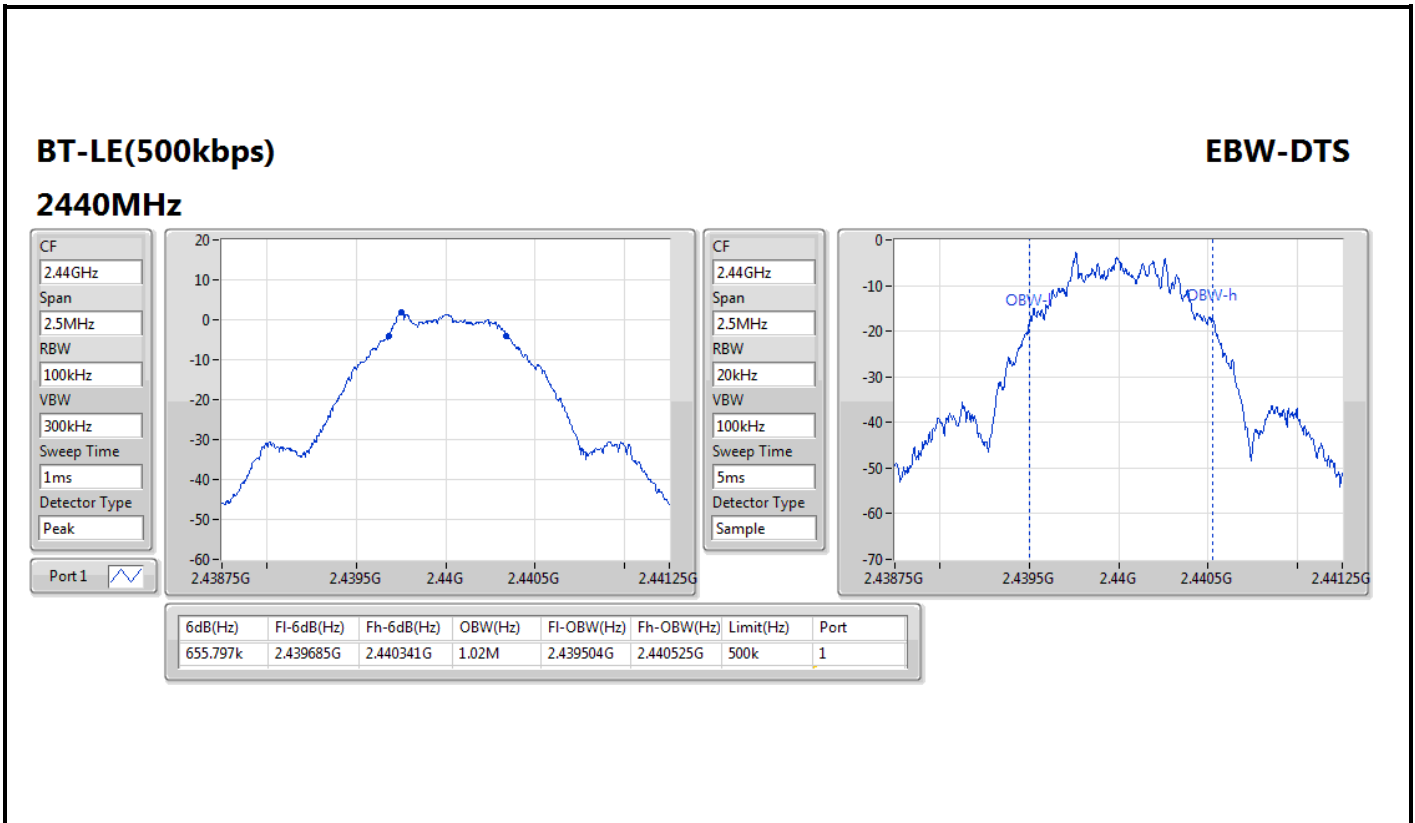

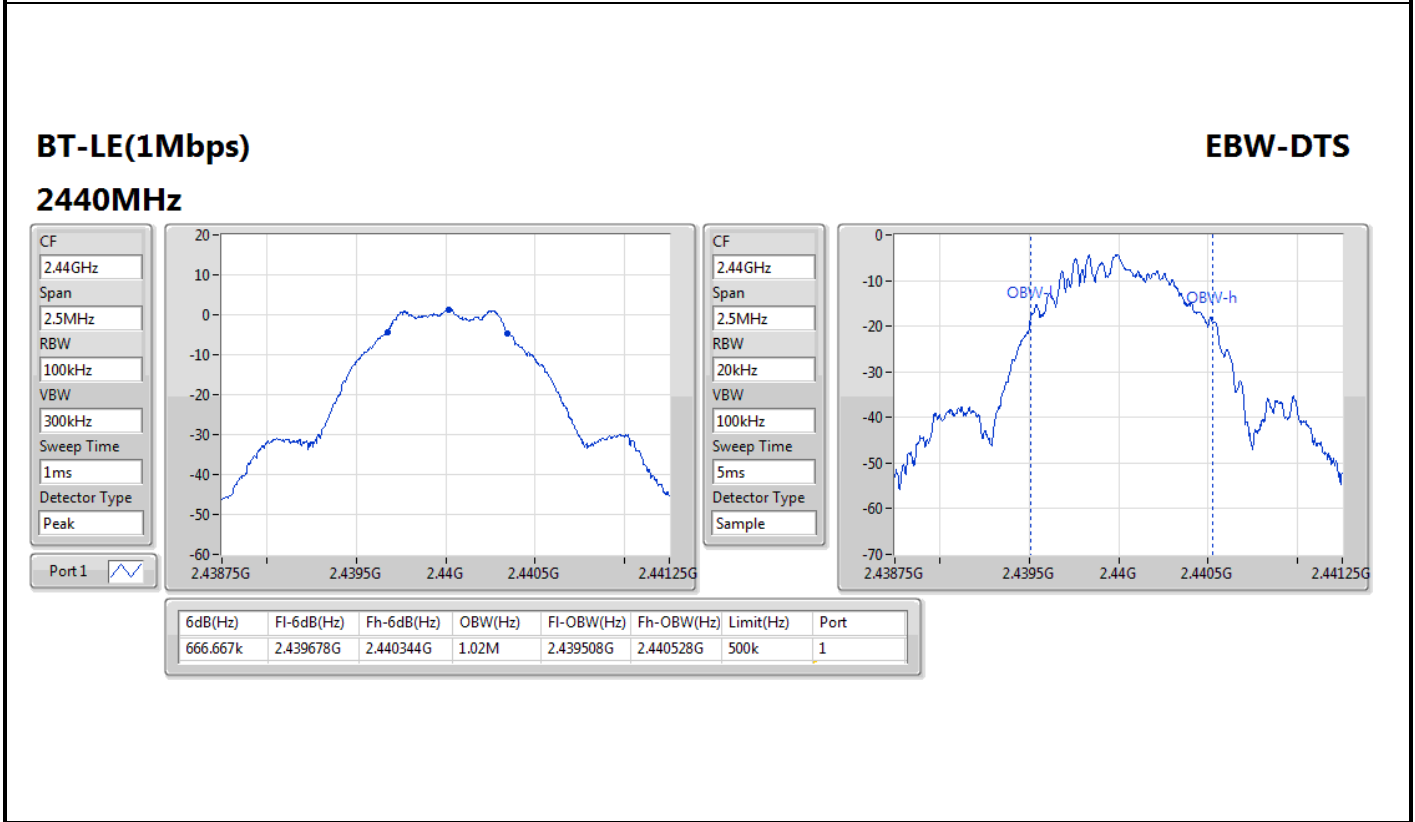
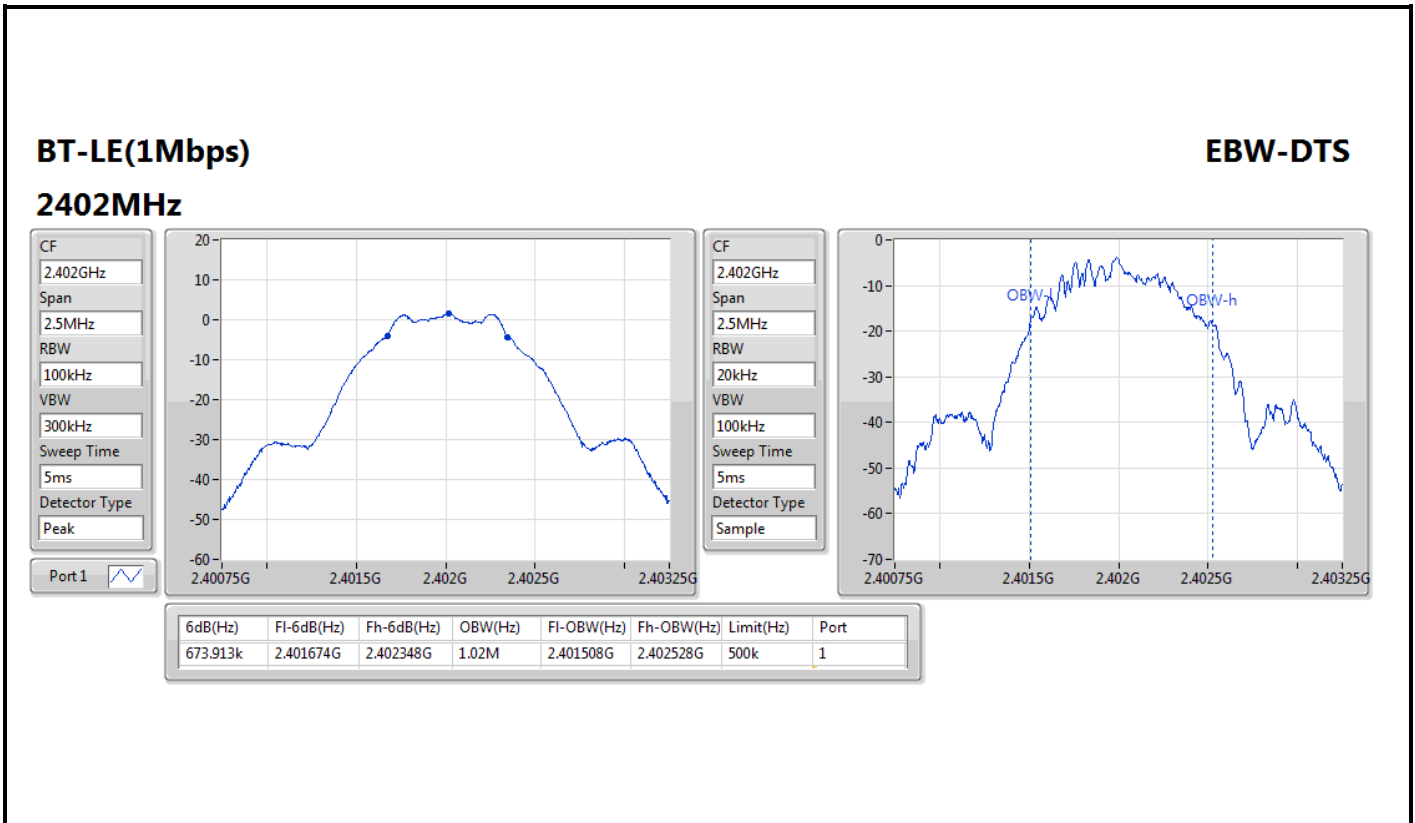



BT-LE(1Mbps)

EBW-DTS

2480MHz

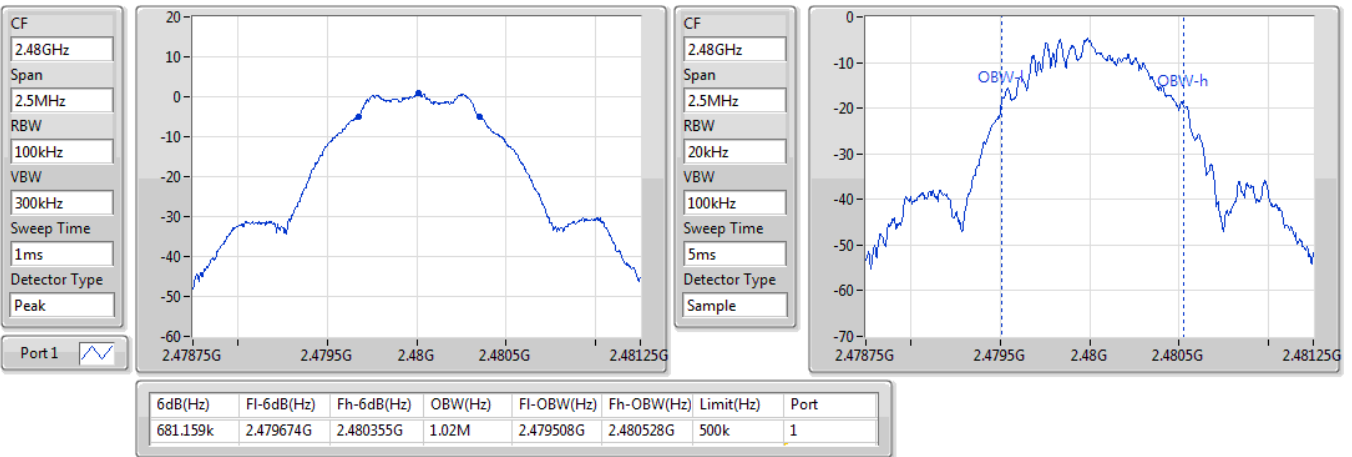

BT-LE(2Mbps)

EBW-DTS

2402MHz

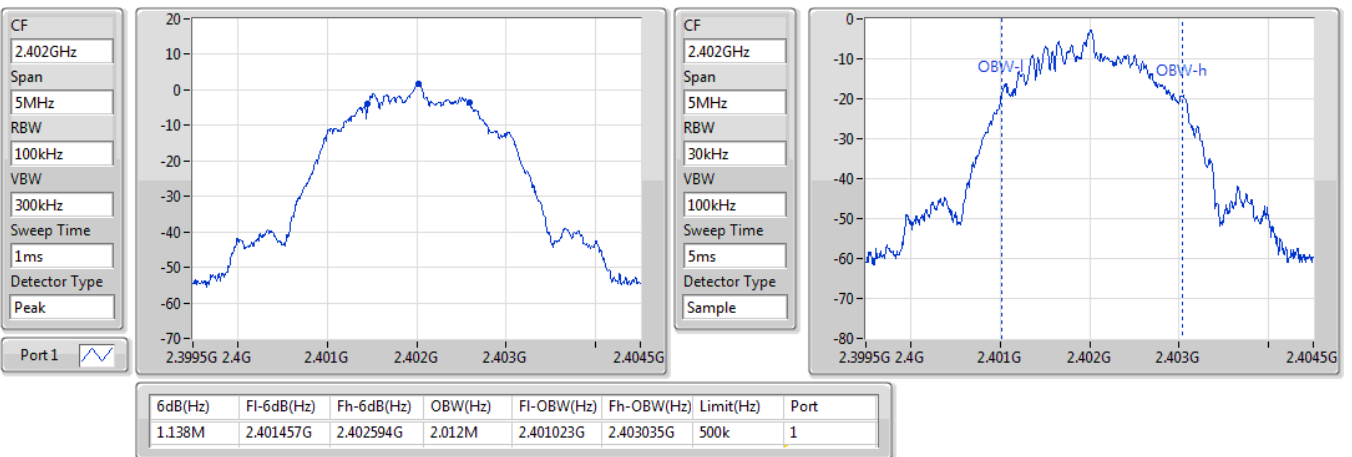

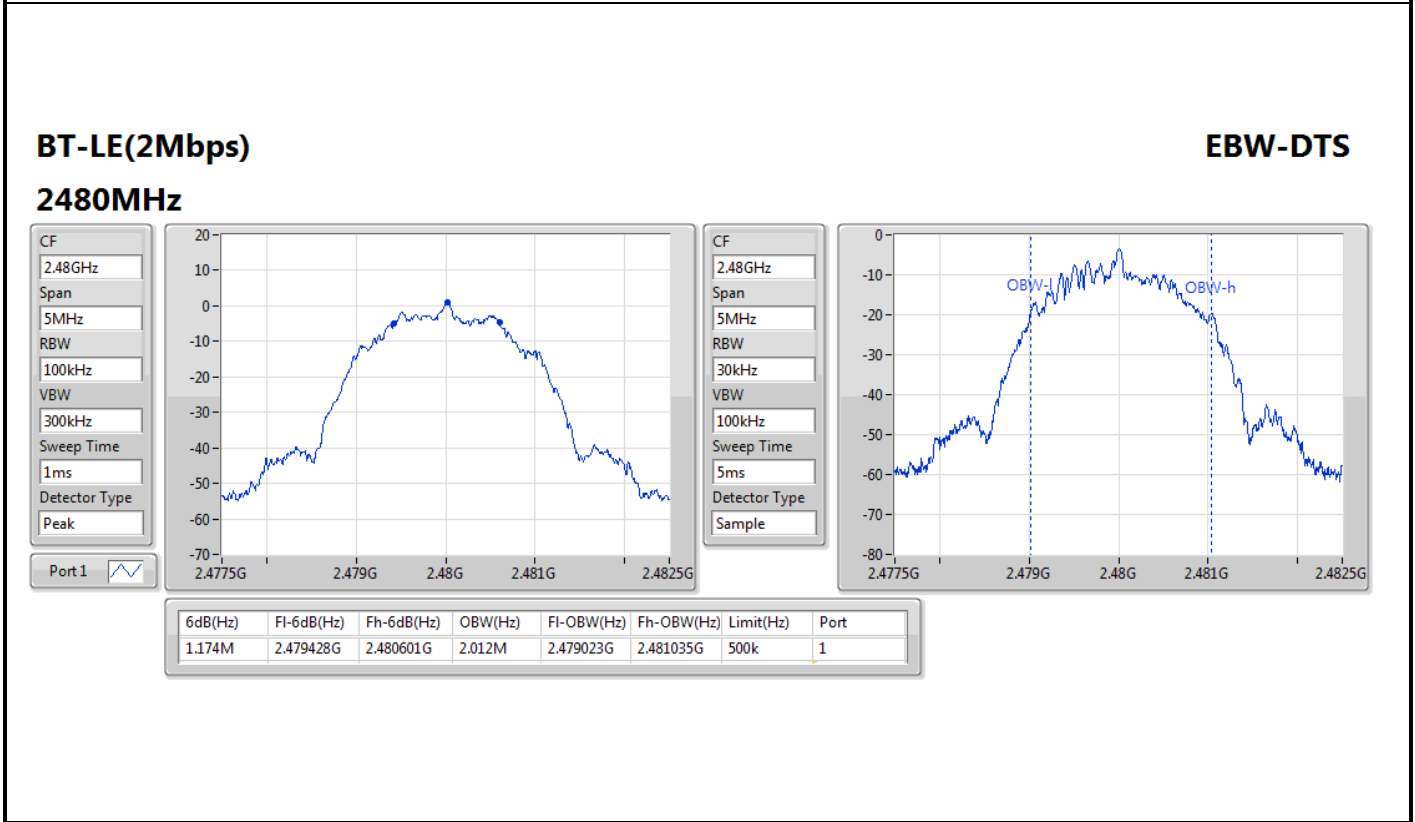
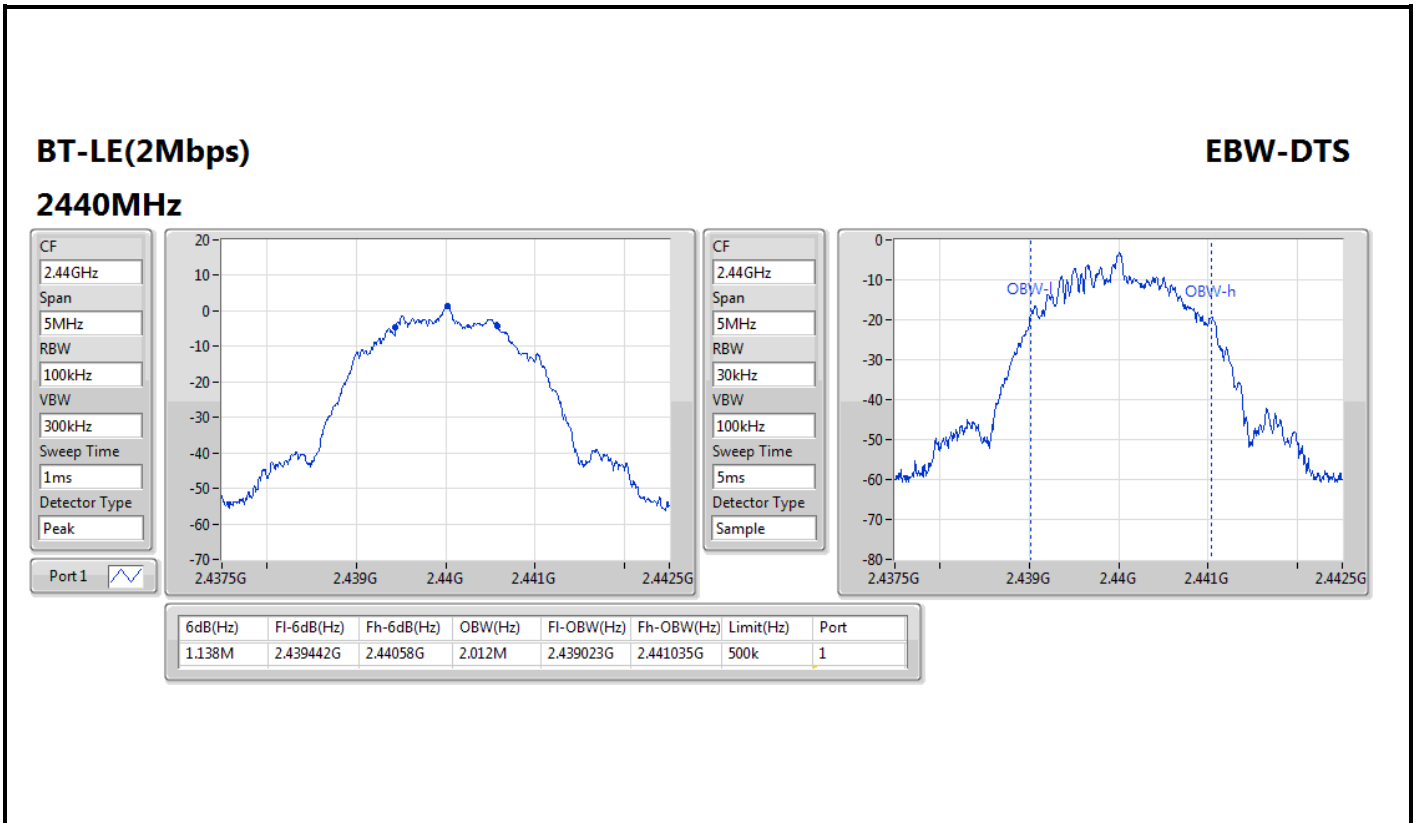



Conducted Output Power (Average)

Appendix B

Summary

Mode	Power (dBm)	Power (W)
2.4-2.4835GHz	-	-
BT-LE(125kbps)	3.00	0.00200
BT-LE(500kbps)	3.00	0.00200
BT-LE(1Mbps)	3.02	0.00200
BT-LE(2Mbps)	3.01	0.00200

Result

Mode	Result	Antenna Gain (dBi)	Power (dBm)	Power Limit (dBm)
BT-LE(125kbps)	-	-	-	-
2402MHz	Pass	3.00	3.00	-
2440MHz	Pass	3.00	2.72	-
2480MHz	Pass	3.00	2.40	-
BT-LE(500kbps)	-	-	-	-
2402MHz	Pass	3.00	3.00	-
2440MHz	Pass	3.00	2.71	-
2480MHz	Pass	3.00	2.39	-
BT-LE(1Mbps)	-	-	-	-
2402MHz	Pass	3.00	3.02	-
2440MHz	Pass	3.00	2.76	-
2480MHz	Pass	3.00	2.45	-
BT-LE(2Mbps)	-	-	-	-
2402MHz	Pass	3.00	3.01	-
2440MHz	Pass	3.00	2.72	-
2480MHz	Pass	3.00	2.41	-

Note: Average power is for reference only.



Conducted Output Power (Peak)

Appendix B

Summary

Mode	Power (dBm)	Power (W)
2.4-2.4835GHz	-	-
BT-LE(125kbps)	3.13	0.00206
BT-LE(500kbps)	3.12	0.00205
BT-LE(1Mbps)	3.17	0.00207
BT-LE(2Mbps)	3.36	0.00217

Result

Mode	Result	Antenna Gain (dBi)	Power (dBm)	Power Limit (dBm)
BT-LE(125kbps)	-	-	-	-
2402MHz	Pass	3.00	3.13	30.00
2440MHz	Pass	3.00	2.88	30.00
2480MHz	Pass	3.00	2.56	30.00
BT-LE(500kbps)	-	-	-	-
2402MHz	Pass	3.00	3.12	30.00
2440MHz	Pass	3.00	2.87	30.00
2480MHz	Pass	3.00	2.55	30.00
BT-LE(1Mbps)	-	-	-	-
2402MHz	Pass	3.00	3.17	30.00
2440MHz	Pass	3.00	2.89	30.00
2480MHz	Pass	3.00	2.58	30.00
BT-LE(2Mbps)	-	-	-	-
2402MHz	Pass	3.00	3.36	30.00
2440MHz	Pass	3.00	3.09	30.00
2480MHz	Pass	3.00	2.78	30.00



Summary

Mode	PD (dBm/3kHz)
2.4-2.4835GHz	-
BT-LE(125kbps)	-3.87
BT-LE(500kbps)	-4.10
BT-LE(1Mbps)	-12.68
BT-LE(2Mbps)	-15.32

Result

Mode	Result	Antenna Gain (dBi)	Power Density (dBm/3kHz)	Power Density Limit (dBm/3kHz)
BT-LE(125kbps)	-	-	-	-
2402MHz	Pass	3.00	-3.87	8.00
2440MHz	Pass	3.00	-4.25	8.00
2480MHz	Pass	3.00	-4.61	8.00
BT-LE(500kbps)	-	-	-	-
2402MHz	Pass	3.00	-4.10	8.00
2440MHz	Pass	3.00	-4.45	8.00
2480MHz	Pass	3.00	-4.83	8.00
BT-LE(1Mbps)	-	-	-	-
2402MHz	Pass	3.00	-12.68	8.00
2440MHz	Pass	3.00	-12.95	8.00
2480MHz	Pass	3.00	-13.49	8.00
BT-LE(2Mbps)	-	-	-	-
2402MHz	Pass	3.00	-15.32	8.00
2440MHz	Pass	3.00	-15.68	8.00
2480MHz	Pass	3.00	-16.06	8.00



BT-LE(125kbps)

PSD

2402MHz

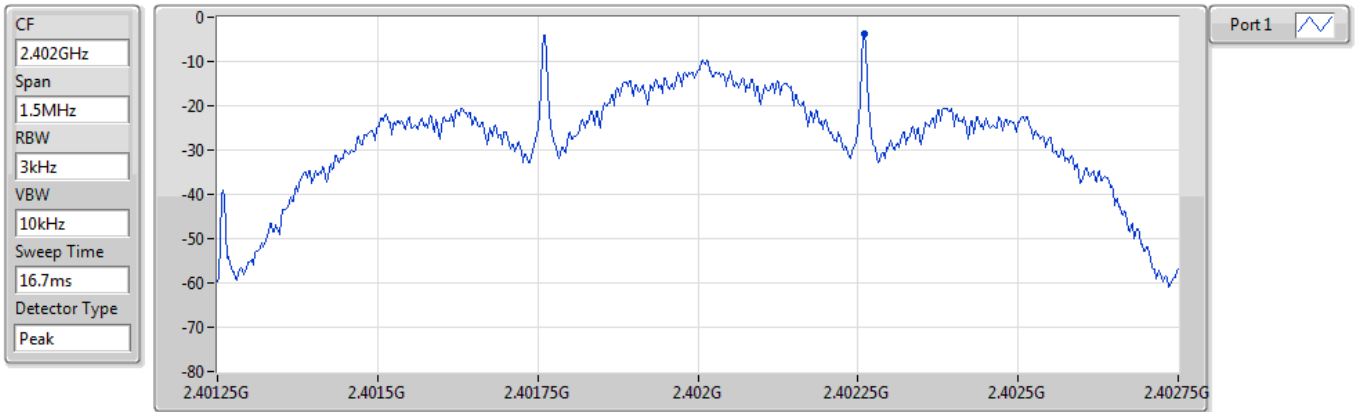

Sum	PD	Port 1
(dBm/RBW)	(dBm/RBW)	(dBm/RBW)
-3.87	-3.87	-3.87

BT-LE(125kbps)

PSD

2440MHz

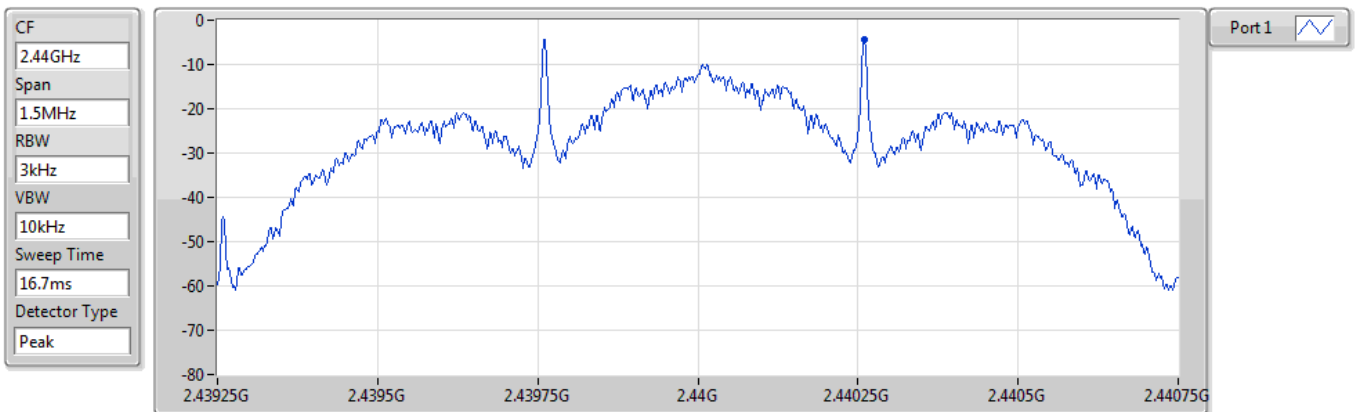

Sum	PD	Port 1
(dBm/RBW)	(dBm/RBW)	(dBm/RBW)
-4.25	-4.25	-4.25



BT-LE(125kbps)

PSD

2480MHz

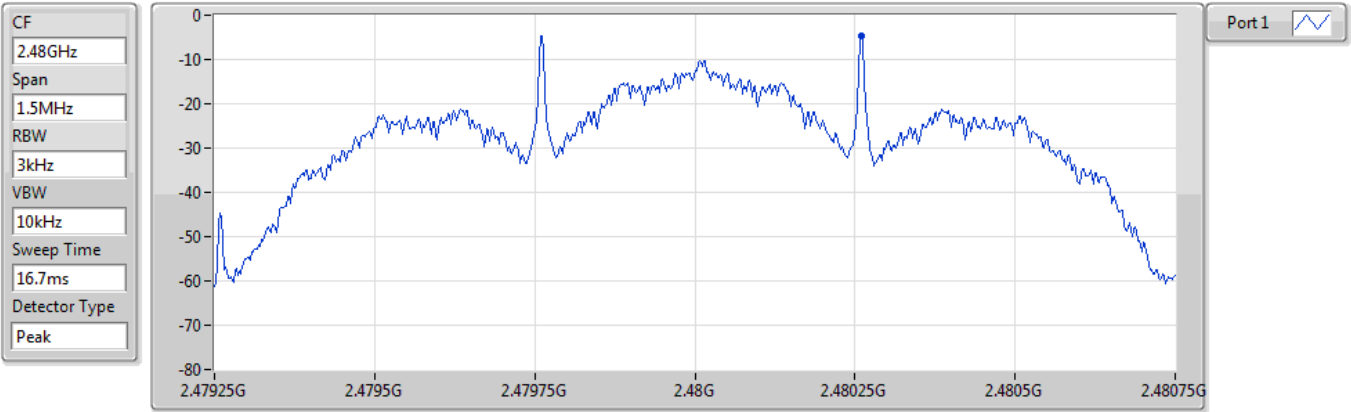

Sum	PD	Port 1
(dBm/RBW)	(dBm/RBW)	(dBm/RBW)
-4.61	-4.61	-4.61

BT-LE(500kbps)

PSD

2402MHz

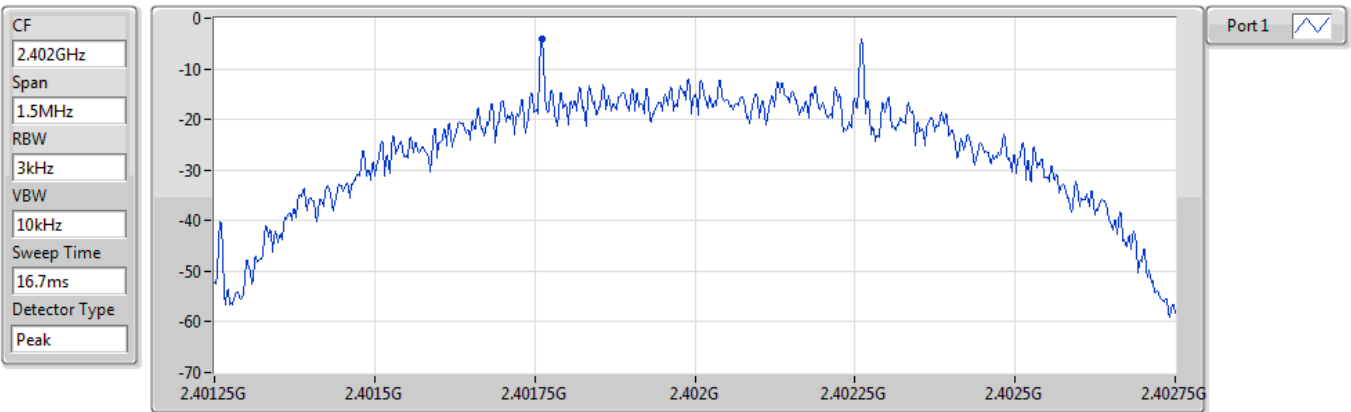

Sum	PD	Port 1
(dBm/RBW)	(dBm/RBW)	(dBm/RBW)
-4.10	-4.10	-4.10



BT-LE(500kbps)

PSD

2440MHz

CF
2.44GHz
Span
1.5MHz
RBW
3kHz
VBW
10kHz
Sweep Time
16.7ms
Detector Type
Peak

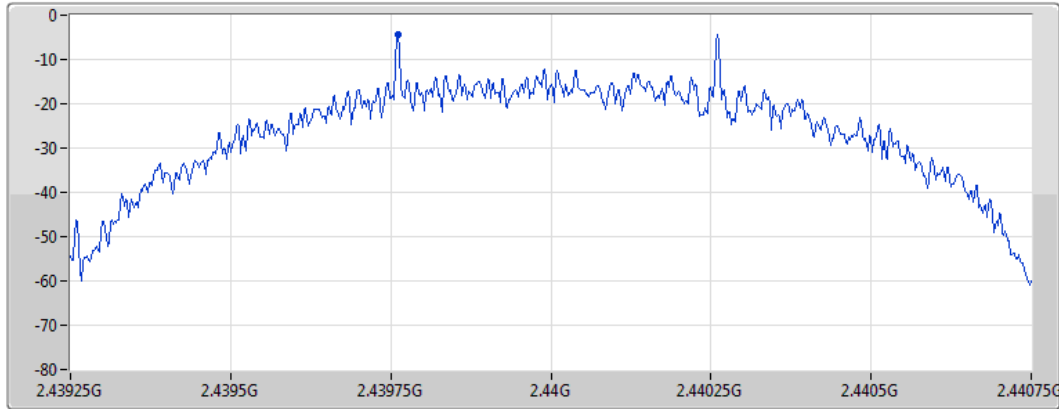

Port 1

Sum	PD	Port 1
(dBm/RBW)	(dBm/RBW)	(dBm/RBW)
-4.45	-4.45	-4.45

BT-LE(500kbps)

PSD

2480MHz

CF
2.48GHz
Span
1.5MHz
RBW
3kHz
VBW
10kHz
Sweep Time
16.7ms
Detector Type
Peak

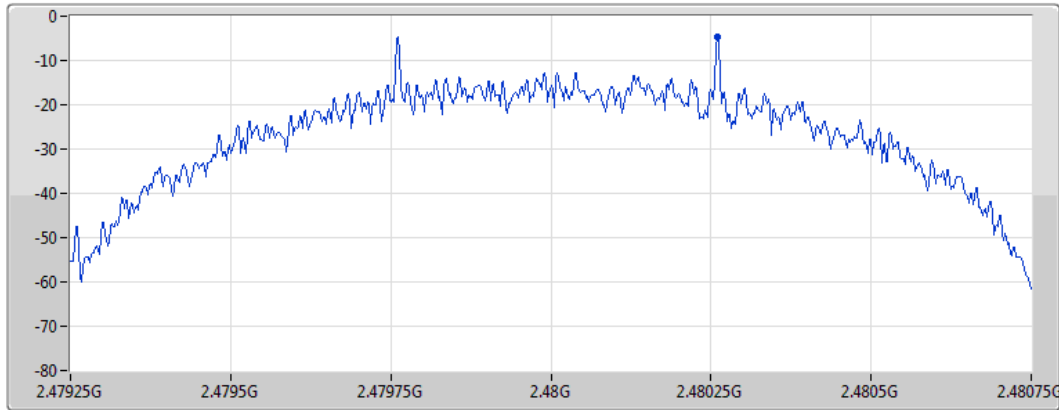

Port 1

Sum	PD	Port 1
(dBm/RBW)	(dBm/RBW)	(dBm/RBW)
-4.83	-4.83	-4.83



BT-LE(1Mbps)

PSD

2402MHz

CF
2.402GHz
Span
1.5MHz
RBW
3kHz
VBW
10kHz
Sweep Time
16.7ms
Detector Type
Peak

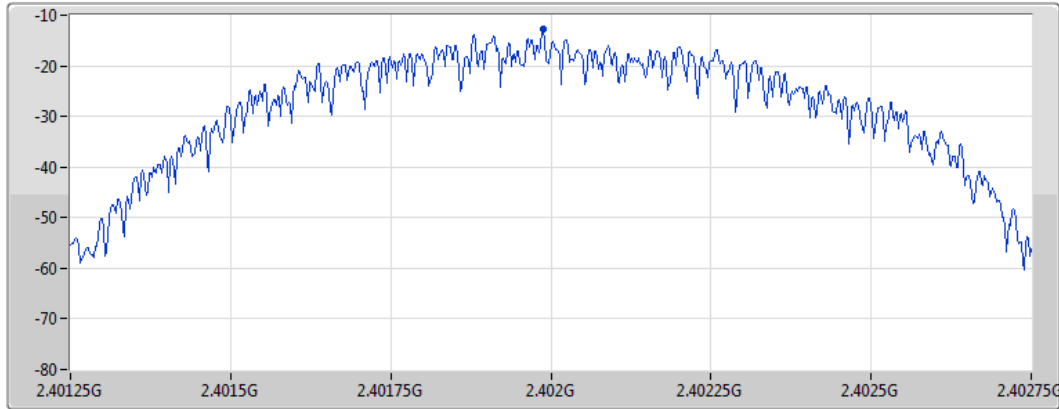

Port 1

Sum	PD	Port 1
(dBm/RBW)	(dBm/RBW)	(dBm/RBW)
-12.68	-12.68	-12.68

BT-LE(1Mbps)

PSD

2440MHz

CF
2.44GHz
Span
1.5MHz
RBW
3kHz
VBW
10kHz
Sweep Time
16.7ms
Detector Type
Peak

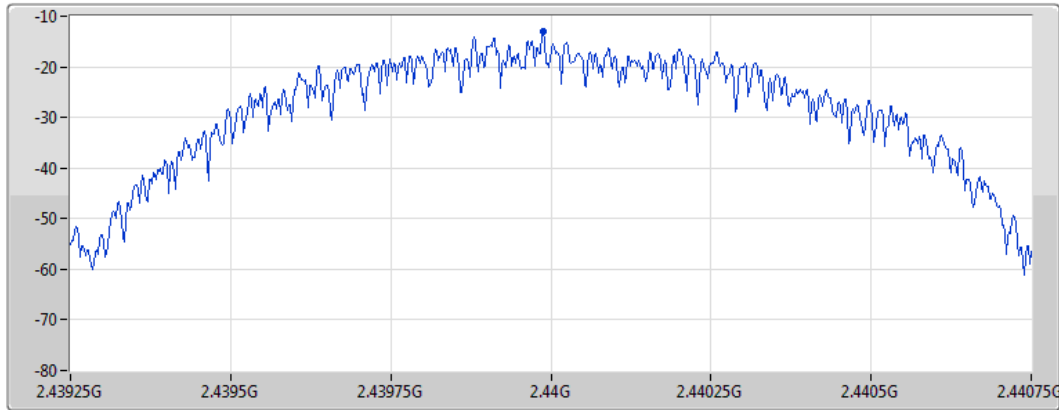

Port 1

Sum	PD	Port 1
(dBm/RBW)	(dBm/RBW)	(dBm/RBW)
-12.95	-12.95	-12.95



BT-LE(1Mbps)

PSD

2480MHz

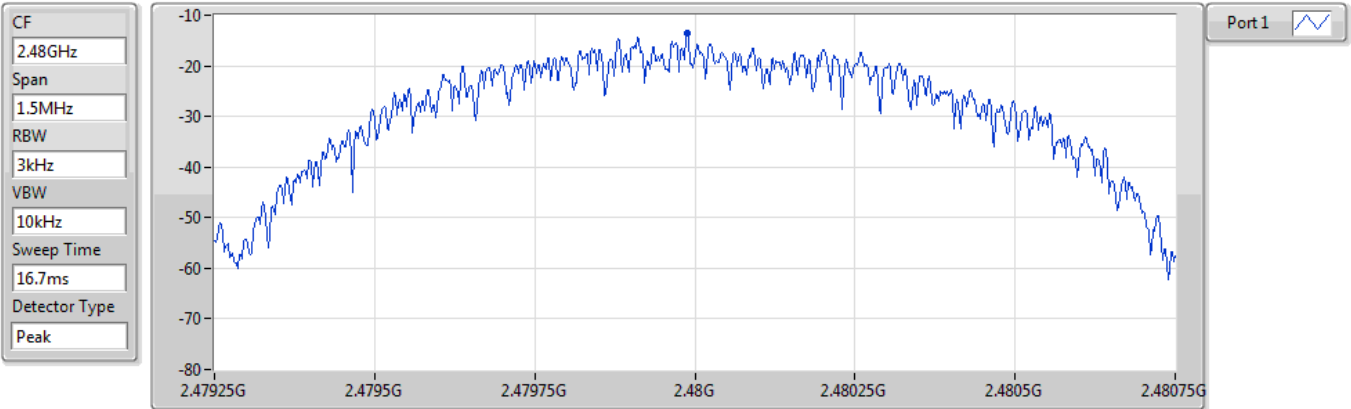

Sum	PD	Port 1
(dBm/RBW)	(dBm/RBW)	(dBm/RBW)
-13.49	-13.49	-13.49

BT-LE(2Mbps)

PSD

2402MHz

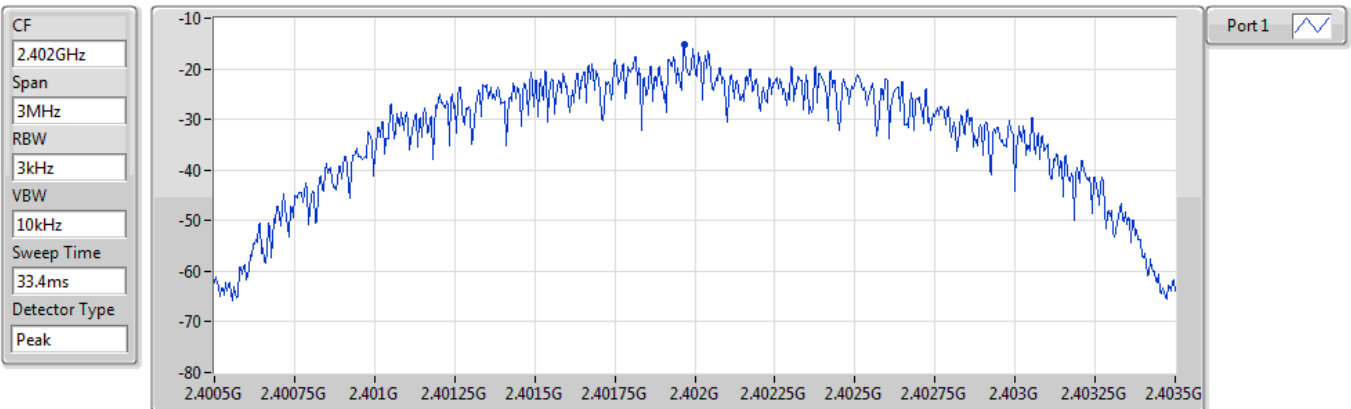

Sum	PD	Port 1
(dBm/RBW)	(dBm/RBW)	(dBm/RBW)
-15.32	-15.32	-15.32



BT-LE(2Mbps)

PSD

2440MHz

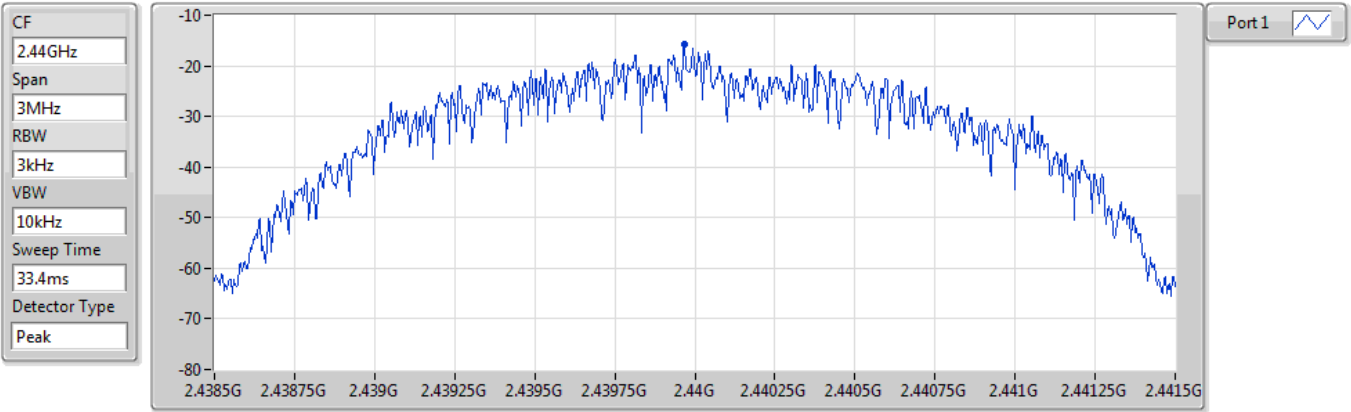

Sum	PD	Port 1
(dBm/RBW)	(dBm/RBW)	(dBm/RBW)
-15.68	-15.68	-15.68

BT-LE(2Mbps)

PSD

2480MHz

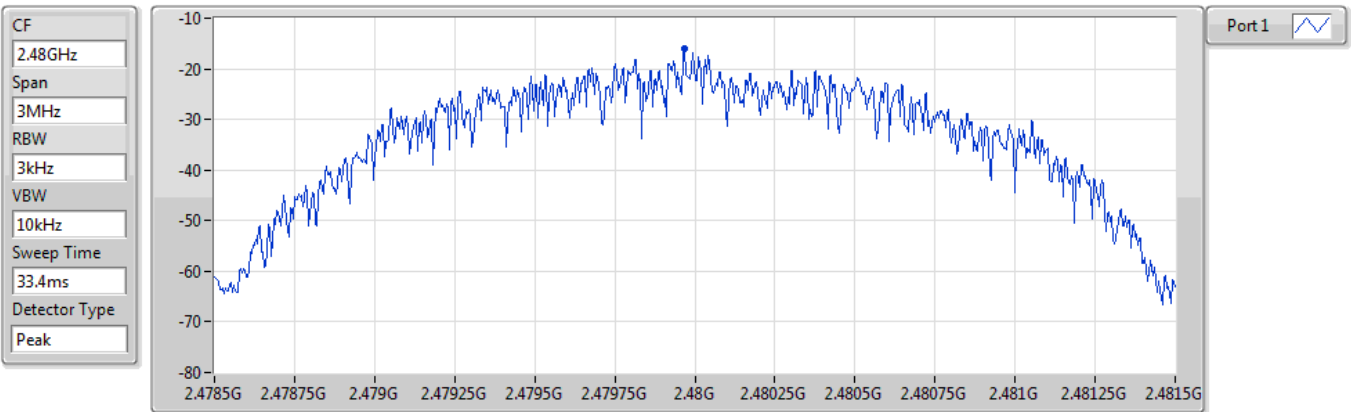

Sum	PD	Port 1
(dBm/RBW)	(dBm/RBW)	(dBm/RBW)
-16.06	-16.06	-16.06



Adapter mode

Unwanted Emissions (Below 1GHz)

Modulation	BT-LE (1Mbps)	Test Freq. (MHz)	2402
Polarization	Horizontal		

Test By :Akun Chung Temperature(°C):23 Humidity(%):68

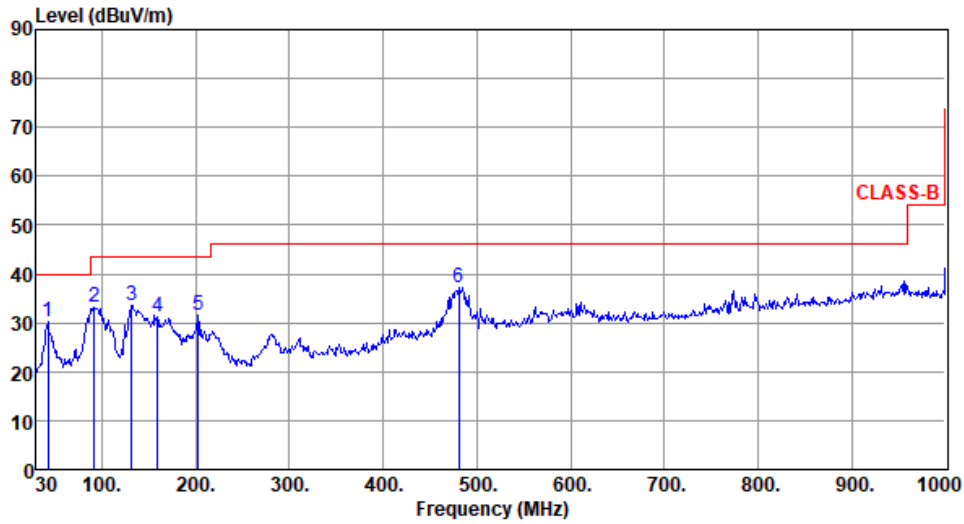

	Freq. MHz	Emission level dBuV/m	Limit dBuV/m	Margin dB	SA reading dBuV	Factor dB/m	Remark	ANT High cm	Turn Table deg
1	42.61	30.31	40.00	-9.69	38.71	-8.40	Peak	---	---
2	92.08	33.18	43.50	-10.32	47.56	-14.38	Peak	---	---
3	131.85	33.52	43.50	-9.98	42.83	-9.31	Peak	---	---
4	159.01	31.33	43.50	-12.17	39.72	-8.39	Peak	---	---
5	202.66	31.39	43.50	-12.11	42.94	-11.55	Peak	---	---
6	481.05	37.23	46.00	-8.77	40.03	-2.80	Peak	---	---

Note 1: Emission Level (dBuV/m) = SA Reading (dBuV/m) + Factor* (dB)

*Factor includes antenna factor , cable loss and amplifier gain

Note 2: Margin (dB) = Emission level (dBuV/m) – Limit (dBuV/m).

Note 3: All spurious emissions below 30MHz are more than 20 dB below the limit.



Modulation	BT-LE (1Mbps)	Test Freq. (MHz)	2402
Polarization	Vertical		

Test By :Akun Chung Temperature(°C):23 Humidity(%):68

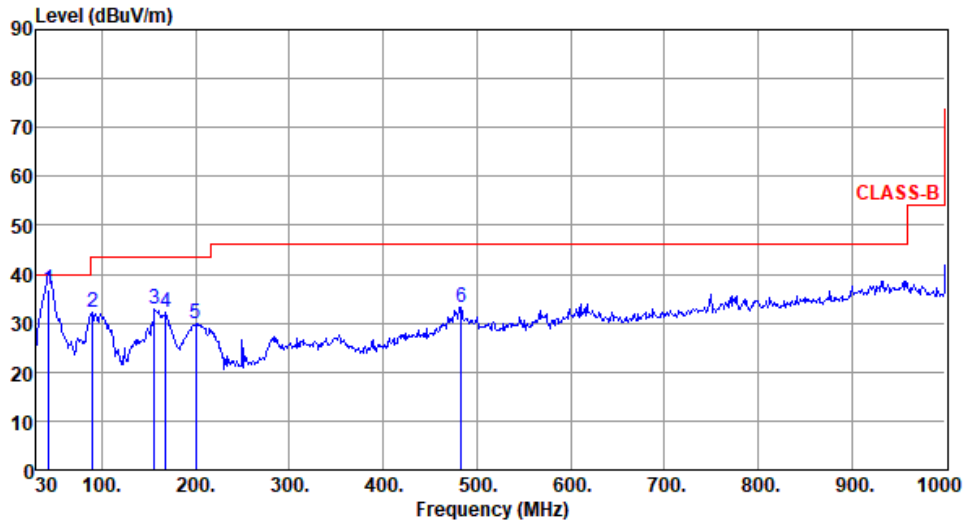

	Freq. MHz	Emission level dBuV/m	Limit dBuV/m	Margin dB	SA reading dBuV	Factor dB/m	Remark	ANT High cm	Turn Table deg
1	43.58	36.91	40.00	-3.09	45.40	-8.49	QP	100	195
2	90.14	32.16	43.50	-11.34	46.67	-14.51	Peak	---	---
3	156.10	32.86	43.50	-10.64	41.27	-8.41	Peak	---	---
4	167.74	32.07	43.50	-11.43	40.74	-8.67	Peak	---	---
5	199.75	30.02	43.50	-13.48	41.50	-11.48	Peak	---	---
6	482.99	33.37	46.00	-12.63	36.15	-2.78	Peak	---	---

Note 1: Emission Level (dBuV/m) = SA Reading (dBuV/m) + Factor* (dB)

*Factor includes antenna factor , cable loss and amplifier gain

Note 2: Margin (dB) = Emission level (dBuV/m) – Limit (dBuV/m).

Note 3: All spurious emissions below 30MHz are more than 20 dB below the limit.



Unwanted Emissions (Above 1GHz) for BT-LE (1Mbps)

Modulation	BT-LE (1Mbps)	Test Freq. (MHz)	2402
Polarization	Horizontal		

Test By :Akun Chung Temperature(°C):24 Humidity(%):67

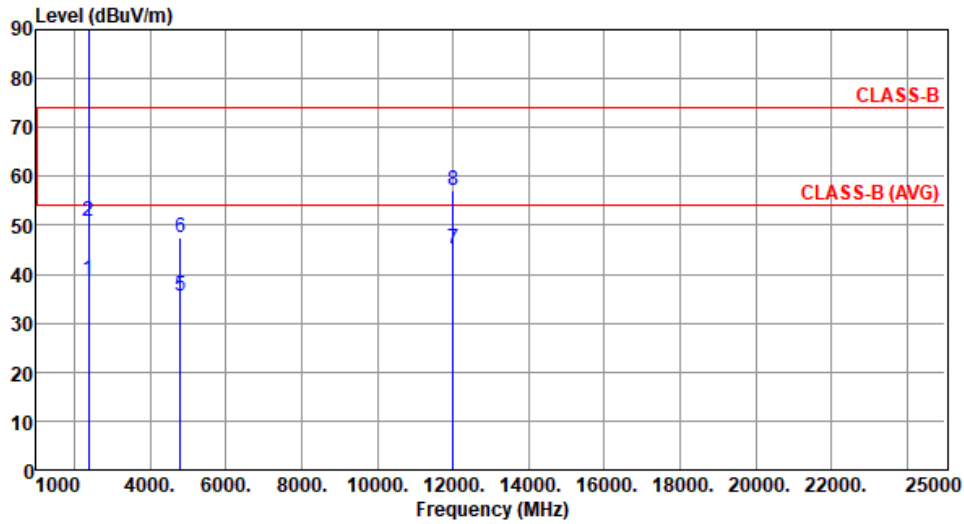

	Freq. MHz	Emission level dBuV/m	Limit dBuV/m	Margin dB	SA reading dBuV	Factor dB/m	Remark	ANT High cm	Turn Table deg
1	2390.00	38.75	54.00	-15.25	40.24	-1.49	Average	103	122
2	2390.00	50.86	74.00	-23.14	52.35	-1.49	Peak	103	122
3 *	2402.00	93.54			95.06	-1.52	Average	103	122
4 *	2402.00	94.49			96.01	-1.52	Peak	103	122
5	4804.00	35.64	54.00	-18.36	30.44	5.20	Average	100	125
6	4804.00	47.65	74.00	-26.35	42.45	5.20	Peak	100	125
7	12010.00	45.16	54.00	-8.84	30.42	14.74	Average	100	129
8	12010.00	57.23	74.00	-16.77	42.49	14.74	Peak	100	129

Note 1: Emission Level (dBuV/m) = SA Reading (dBuV/m) + Factor* (dB)

*Factor includes antenna factor , cable loss and amplifier gain

Note 2: Margin (dB) = Emission level (dBuV/m) – Limit (dBuV/m).

Note 3: "*" is Peak / Average value of fundamental frequency



Modulation	BT-LE (1Mbps)	Test Freq. (MHz)	2402
Polarization	Vertical		

Test By :Akun Chung Temperature(°C):24 Humidity(%):67

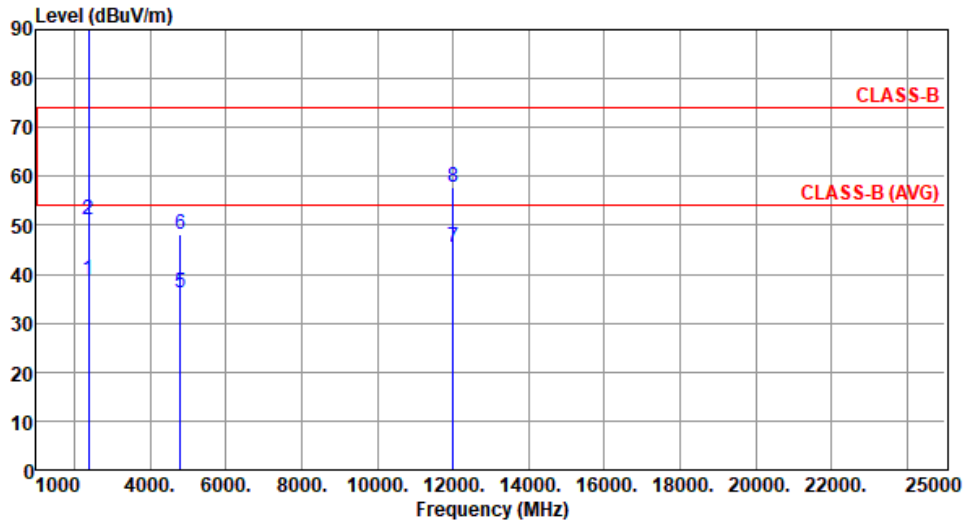

	Freq. MHz	Emission level dBuV/m	Limit dBuV/m	Margin dB	SA reading dBuV	Factor dB/m	Remark	ANT High cm	Turn Table deg
1	2390.00	38.98	54.00	-15.02	40.47	-1.49	Average	100	75
2	2390.00	51.09	74.00	-22.91	52.58	-1.49	Peak	100	75
3 *	2402.00	95.18			96.70	-1.52	Average	100	75
4 *	2402.00	96.14			97.66	-1.52	Peak	100	75
5	4804.00	36.08	54.00	-17.92	30.88	5.20	Average	100	71
6	4804.00	48.15	74.00	-25.85	42.95	5.20	Peak	100	71
7	12010.00	45.61	54.00	-8.39	30.87	14.74	Average	100	80
8	12010.00	57.63	74.00	-16.37	42.89	14.74	Peak	100	80

Note 1: Emission Level (dBuV/m) = SA Reading (dBuV/m) + Factor* (dB)

*Factor includes antenna factor , cable loss and amplifier gain

Note 2: Margin (dB) = Emission level (dBuV/m) – Limit (dBuV/m).

Note 3:"*" is Peak / Average value of fundamental frequency



Modulation	BT-LE (1Mbps)	Test Freq. (MHz)	2440
Polarization	Horizontal		

Test By :Akun Chung Temperature(°C):24 Humidity(%):67

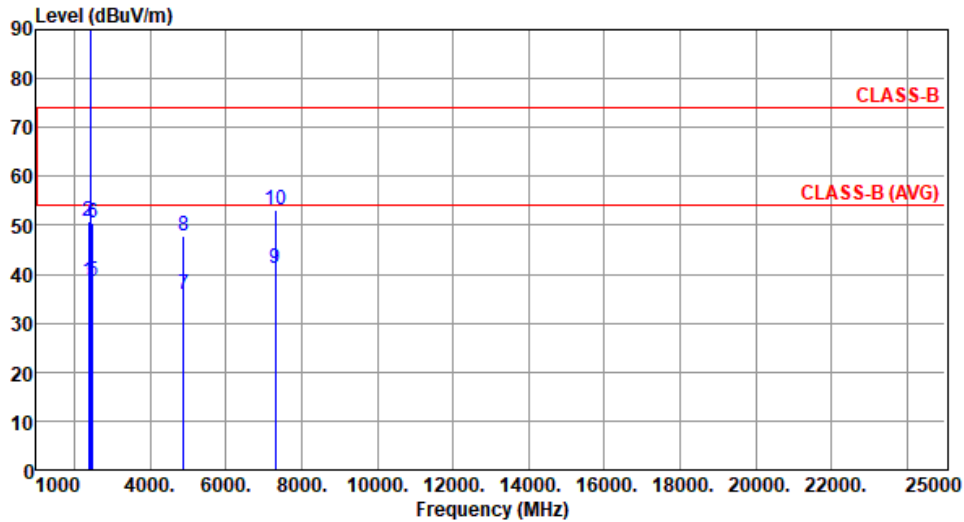

	Freq. MHz	Emission level dBuV/m	Limit dBuV/m	Margin dB	SA reading dBuV	Factor dB/m	Remark	ANT High cm	Turn Table deg
1	2390.00	38.61	54.00	-15.39	40.10	-1.49	Average	104	119
2	2390.00	50.71	74.00	-23.29	52.20	-1.49	Peak	104	119
3 *	2440.00	92.98			94.58	-1.60	Average	104	119
4 *	2440.00	93.88			95.48	-1.60	Peak	104	119
5	2483.50	38.57	54.00	-15.43	40.15	-1.58	Average	104	119
6	2483.50	50.61	74.00	-23.39	52.19	-1.58	Peak	104	119
7	4880.00	35.71	54.00	-18.29	30.39	5.32	Average	100	124
8	4880.00	47.75	74.00	-26.25	42.43	5.32	Peak	100	124
9	7320.00	41.22	54.00	-12.78	30.39	10.83	Average	100	127
10	7320.00	53.29	74.00	-20.71	42.46	10.83	Peak	100	127

Note 1: Emission Level (dBuV/m) = SA Reading (dBuV/m) + Factor* (dB)

*Factor includes antenna factor , cable loss and amplifier gain

Note 2: Margin (dB) = Emission level (dBuV/m) – Limit (dBuV/m).

Note 3:"*" is Peak / Average value of fundamental frequency



Modulation	BT-LE (1Mbps)	Test Freq. (MHz)	2440
Polarization	Vertical		

Test By :Akun Chung Temperature(°C):24 Humidity(%):67

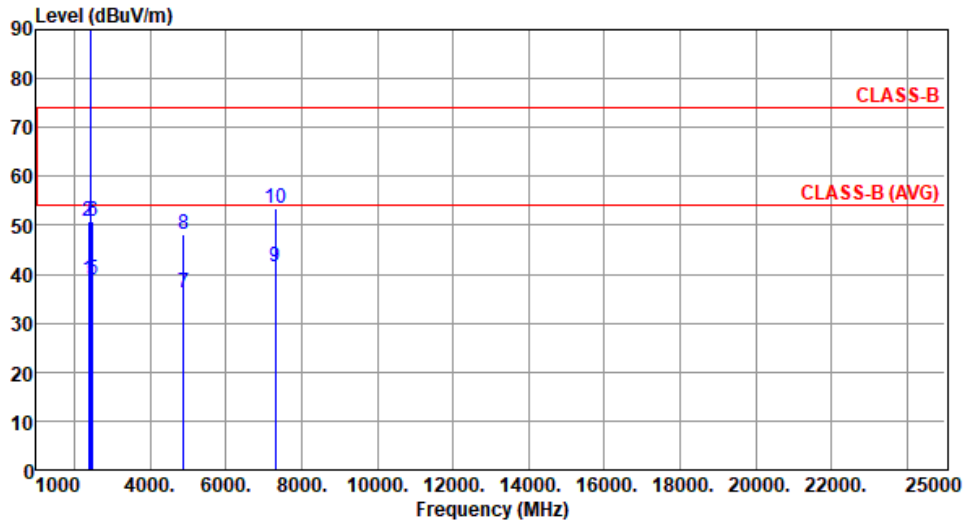

	Freq. MHz	Emission level dBuV/m	Limit dBuV/m	Margin dB	SA reading dBuV	Factor dB/m	Remark	ANT High cm	Turn Table deg
1	2390.00	38.83	54.00	-15.17	40.32	-1.49	Average	100	76
2	2390.00	50.88	74.00	-23.12	52.37	-1.49	Peak	100	76
3 *	2440.00	94.58			96.18	-1.60	Average	100	76
4 *	2440.00	95.57			97.17	-1.60	Peak	100	76
5	2483.50	38.79	54.00	-15.21	40.37	-1.58	Average	100	76
6	2483.50	50.85	74.00	-23.15	52.43	-1.58	Peak	100	76
7	4880.00	36.18	54.00	-17.82	30.86	5.32	Average	100	78
8	4880.00	48.17	74.00	-25.83	42.85	5.32	Peak	100	78
9	7320.00	41.67	54.00	-12.33	30.84	10.83	Average	100	71
10	7320.00	53.62	74.00	-20.38	42.79	10.83	Peak	100	71

Note 1: Emission Level (dBuV/m) = SA Reading (dBuV/m) + Factor* (dB)

*Factor includes antenna factor , cable loss and amplifier gain

Note 2: Margin (dB) = Emission level (dBuV/m) – Limit (dBuV/m).

Note 3:"*" is Peak / Average value of fundamental frequency



Modulation	BT-LE (1Mbps)	Test Freq. (MHz)	2480
Polarization	Horizontal		

Test By :Akun Chung Temperature(°C):24 Humidity(%):67

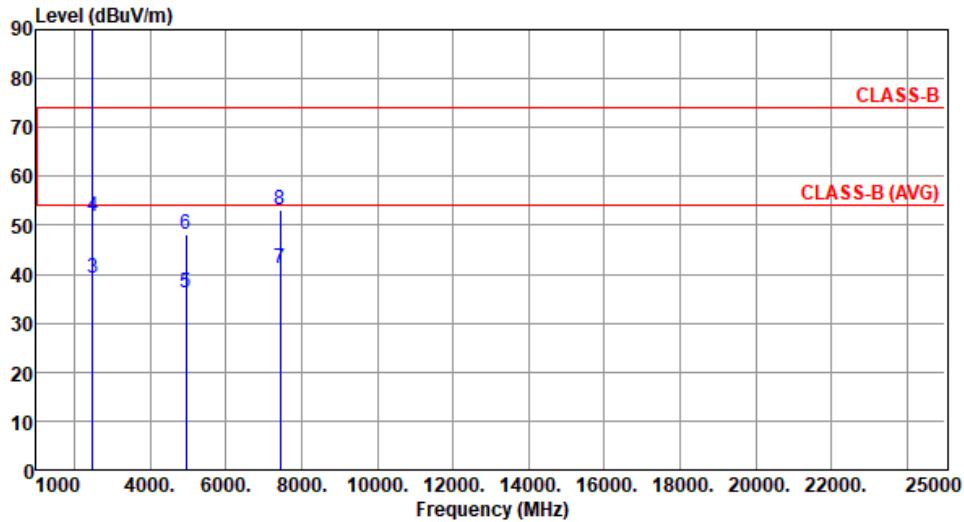

		Freq. MHz	Emission level dBuV/m	Limit dBuV/m	Margin dB	SA reading dBuV	Factor dB/m	Remark	ANT High cm	Turn Table deg
1	*	2480.00	92.41			94.00	-1.59	Average	107	120
2	*	2480.00	93.36			94.95	-1.59	Peak	107	120
3		2483.50	39.11	54.00	-14.89	40.69	-1.58	Average	107	120
4		2483.50	51.90	74.00	-22.10	53.48	-1.58	Peak	107	120
5		4960.00	36.10	54.00	-17.90	30.39	5.71	Average	100	115
6		4960.00	48.06	74.00	-25.94	42.35	5.71	Peak	100	115
7		7440.00	41.05	54.00	-12.95	30.40	10.65	Average	100	126
8		7440.00	53.08	74.00	-20.92	42.43	10.65	Peak	100	126

Note 1: Emission Level (dBuV/m) = SA Reading (dBuV/m) + Factor* (dB)

*Factor includes antenna factor , cable loss and amplifier gain

Note 2: Margin (dB) = Emission level (dBuV/m) – Limit (dBuV/m).

Note 3:"*" is Peak / Average value of fundamental frequency



Modulation	BT-LE (1Mbps)	Test Freq. (MHz)	2480
Polarization	Vertical		

Test By :Akun Chung Temperature(°C):24 Humidity(%):67

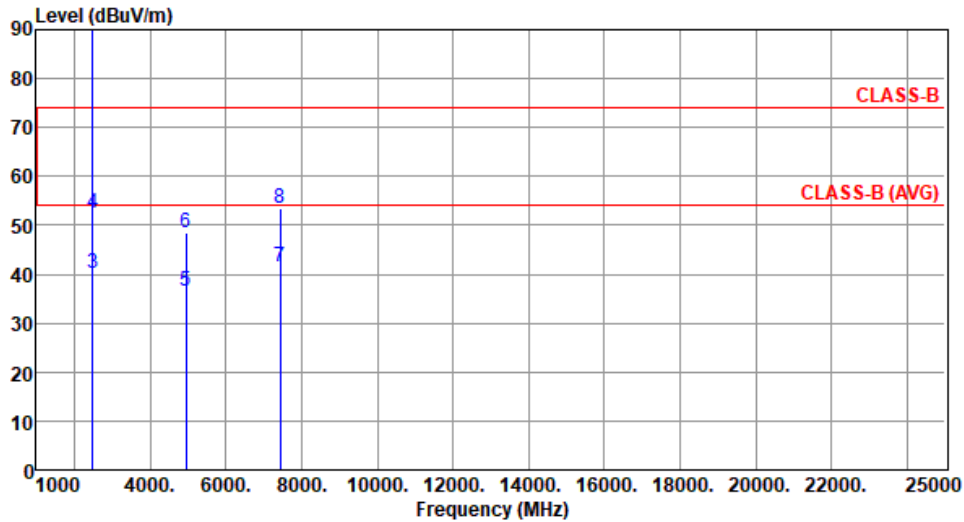

		Freq. MHz	Emission level dBuV/m	Limit dBuV/m	Margin dB	SA reading dBuV	Factor dB/m	Remark	ANT High cm	Turn Table deg
1	*	2480.00	94.17			95.76	-1.59	Average	100	74
2	*	2480.00	95.11			96.70	-1.59	Peak	100	74
3		2483.50	40.08	54.00	-13.92	41.66	-1.58	Average	100	74
4		2483.50	52.36	74.00	-21.64	53.94	-1.58	Peak	100	74
5		4960.00	36.49	54.00	-17.51	30.78	5.71	Average	100	68
6		4960.00	48.51	74.00	-25.49	42.80	5.71	Peak	100	68
7		7440.00	41.39	54.00	-12.61	30.74	10.65	Average	100	73
8		7440.00	53.41	74.00	-20.59	42.76	10.65	Peak	100	73

Note 1: Emission Level (dBuV/m) = SA Reading (dBuV/m) + Factor* (dB)

*Factor includes antenna factor , cable loss and amplifier gain

Note 2: Margin (dB) = Emission level (dBuV/m) – Limit (dBuV/m).

Note 3:"*" is Peak / Average value of fundamental frequency



Unwanted Emissions (Above 1GHz) for BT-LE (2Mbps)

Modulation	BT-LE (2Mbps)	Test Freq. (MHz)	2402
Polarization	Horizontal		

Test By :Akun Chung Temperature(°C):24 Humidity(%):67

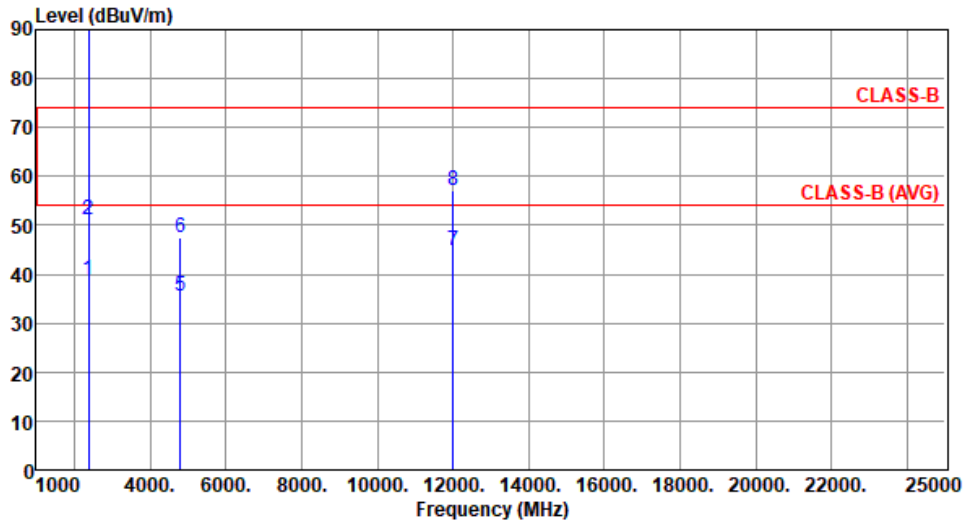

	Freq. MHz	Emission level dBuV/m	Limit dBuV/m	Margin dB	SA reading dBuV	Factor dB/m	Remark	ANT High cm	Turn Table deg
1	2390.00	38.86	54.00	-15.14	40.35	-1.49	Average	103	123
2	2390.00	50.98	74.00	-23.02	52.47	-1.49	Peak	103	123
3 *	2402.00	91.76			93.28	-1.52	Average	103	123
4 *	2402.00	94.20			95.72	-1.52	Peak	103	123
5	4804.00	35.41	54.00	-18.59	30.21	5.20	Average	100	129
6	4804.00	47.45	74.00	-26.55	42.25	5.20	Peak	100	129
7	12010.00	44.93	54.00	-9.07	30.19	14.74	Average	100	122
8	12010.00	57.02	74.00	-16.98	42.28	14.74	Peak	100	122

Note 1: Emission Level (dBuV/m) = SA Reading (dBuV/m) + Factor* (dB)

*Factor includes antenna factor , cable loss and amplifier gain

Note 2: Margin (dB) = Emission level (dBuV/m) – Limit (dBuV/m).

Note 3: "*" is Peak / Average value of fundamental frequency



Modulation	BT-LE (2Mbps)	Test Freq. (MHz)	2402
Polarization	Vertical		

Test By : Akun Chung Temperature(°C): 24 Humidity(%): 67

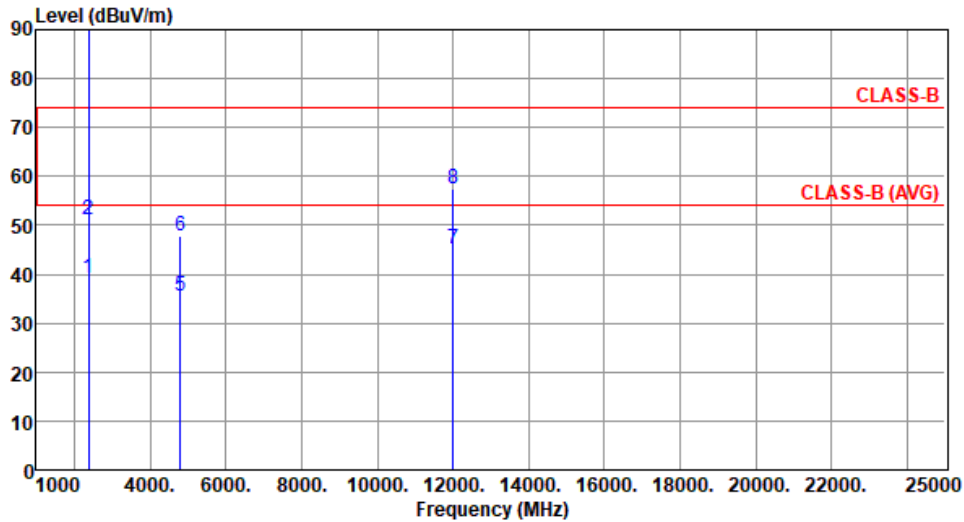

	Freq. MHz	Emission level dBuV/m	Limit dBuV/m	Margin dB	SA reading dBuV	Factor dB/m	Remark	ANT High cm	Turn Table deg
1	2390.00	39.25	54.00	-14.75	40.74	-1.49	Average	100	78
2	2390.00	51.30	74.00	-22.70	52.79	-1.49	Peak	100	78
3 *	2402.00	93.20			94.72	-1.52	Average	100	78
4 *	2402.00	95.76			97.28	-1.52	Peak	100	78
5	4804.00	35.69	54.00	-18.31	30.49	5.20	Average	100	82
6	4804.00	47.78	74.00	-26.22	42.58	5.20	Peak	100	82
7	12010.00	45.29	54.00	-8.71	30.55	14.74	Average	100	72
8	12010.00	57.34	74.00	-16.66	42.60	14.74	Peak	100	72

Note 1: Emission Level (dBuV/m) = SA Reading (dBuV/m) + Factor* (dB)

*Factor includes antenna factor , cable loss and amplifier gain

Note 2: Margin (dB) = Emission level (dBuV/m) – Limit (dBuV/m).

Note 3: "*" is Peak / Average value of fundamental frequency



Modulation	BT-LE (2Mbps)	Test Freq. (MHz)	2440
Polarization	Horizontal		

Test By :Akun Chung Temperature(°C):24 Humidity(%):67

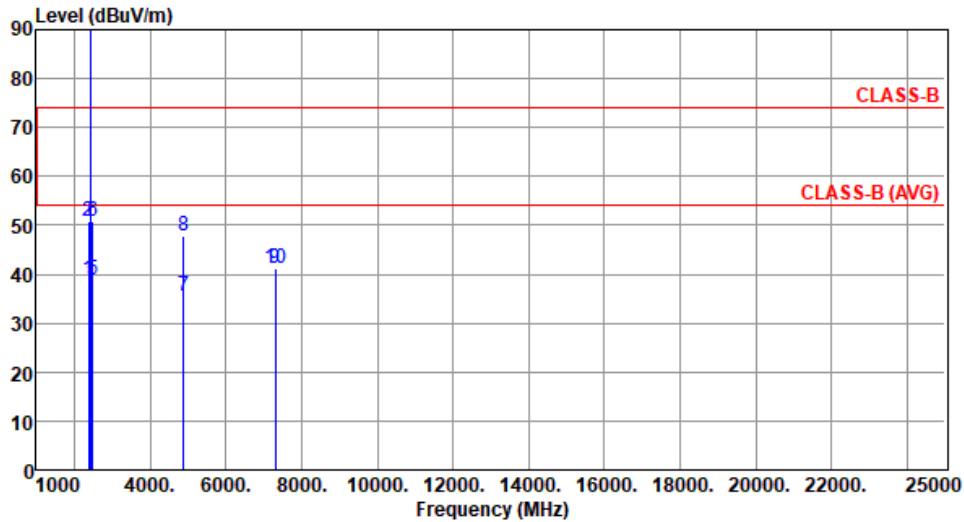

	Freq. MHz	Emission level dBuV/m	Limit dBuV/m	Margin dB	SA reading dBuV	Factor dB/m	Remark	ANT High cm	Turn Table deg
1	2390.00	38.89	54.00	-15.11	40.38	-1.49	Average	106	119
2	2390.00	50.94	74.00	-23.06	52.43	-1.49	Peak	106	119
3 *	2440.00	91.18			92.78	-1.60	Average	106	119
4 *	2440.00	93.72			95.32	-1.60	Peak	106	119
5	2483.50	38.84	54.00	-15.16	40.42	-1.58	Average	106	119
6	2483.50	50.90	74.00	-23.10	52.48	-1.58	Peak	106	119
7	4880.00	35.68	54.00	-18.32	30.36	5.32	Average	100	128
8	4880.00	47.67	74.00	-26.33	42.35	5.32	Peak	100	128
9	7320.00	41.13	54.00	-12.87	30.30	10.83	Average	100	131
10	7320.00	41.26	54.00	-12.74	30.43	10.83	Average	100	131

Note 1: Emission Level (dBuV/m) = SA Reading (dBuV/m) + Factor* (dB)

*Factor includes antenna factor , cable loss and amplifier gain

Note 2: Margin (dB) = Emission level (dBuV/m) – Limit (dBuV/m).

Note 3:"*" is Peak / Average value of fundamental frequency



Modulation	BT-LE (2Mbps)	Test Freq. (MHz)	2440
Polarization	Vertical		

Test By :Akun Chung Temperature(°C):24 Humidity(%):67

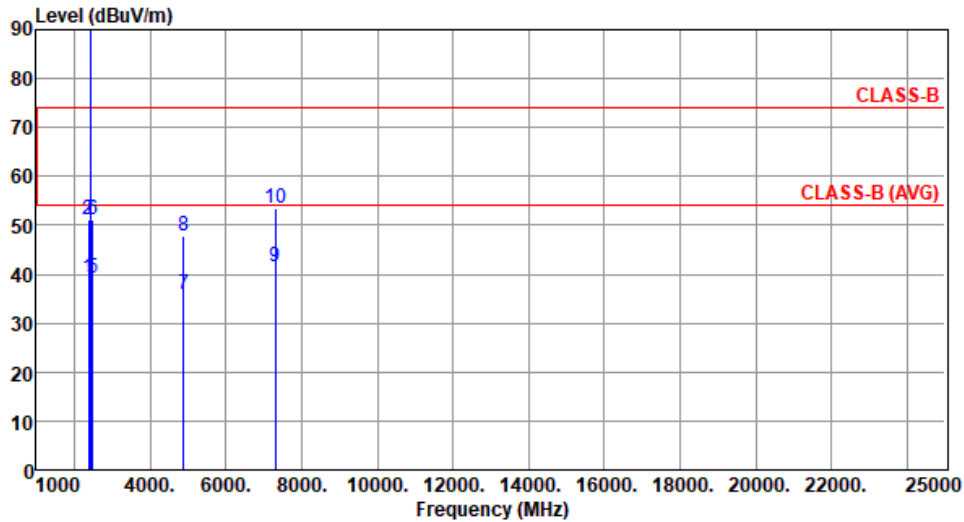

	Freq. MHz	Emission level dBuV/m	Limit dBuV/m	Margin dB	SA reading dBuV	Factor dB/m	Remark	ANT High cm	Turn Table deg
1	2390.00	39.19	54.00	-14.81	40.68	-1.49	Average	100	79
2	2390.00	51.25	74.00	-22.75	52.74	-1.49	Peak	100	79
3 *	2440.00	92.76			94.36	-1.60	Average	100	79
4 *	2440.00	95.27			96.87	-1.60	Peak	100	79
5	2483.50	39.12	54.00	-14.88	40.70	-1.58	Average	100	79
6	2483.50	51.20	74.00	-22.80	52.78	-1.58	Peak	100	79
7	4880.00	35.87	54.00	-18.13	30.55	5.32	Average	100	85
8	4880.00	47.91	74.00	-26.09	42.59	5.32	Peak	100	85
9	7320.00	41.37	54.00	-12.63	30.54	10.83	Average	100	81
10	7320.00	53.36	74.00	-20.64	42.53	10.83	Peak	100	81

Note 1: Emission Level (dBuV/m) = SA Reading (dBuV/m) + Factor* (dB)

*Factor includes antenna factor , cable loss and amplifier gain

Note 2: Margin (dB) = Emission level (dBuV/m) – Limit (dBuV/m).

Note 3:"*" is Peak / Average value of fundamental frequency



Modulation	BT-LE (2Mbps)	Test Freq. (MHz)	2480
Polarization	Horizontal		

Test By :Akun Chung Temperature(°C):24 Humidity(%):67

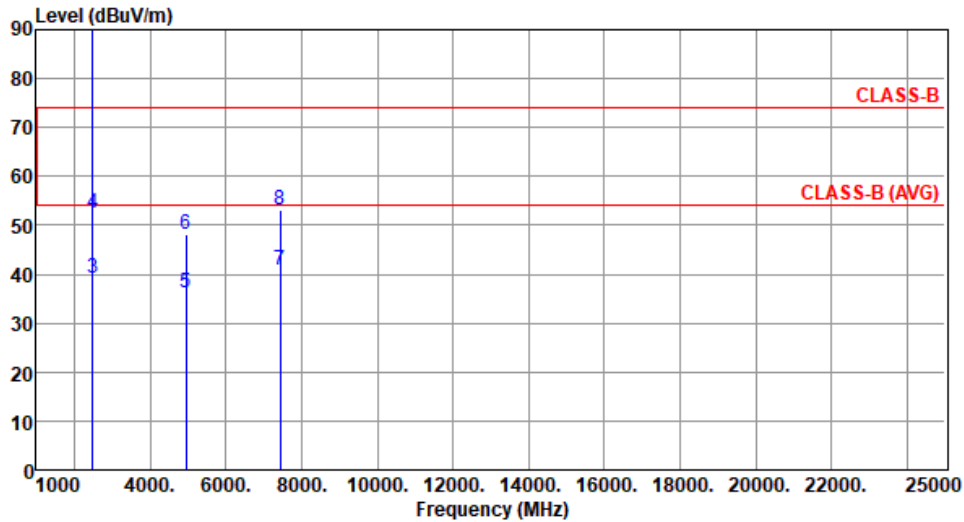

		Freq.	Emission	Limit	Margin	SA	Factor	Remark	ANT	Turn
		MHz	level	dBuV/m	dB	reading	dB/m		High	Table
			dBuV/m			dBuV			cm	deg
1	*	2480.00	90.85			92.44	-1.59	Average	105	121
2	*	2480.00	93.39			94.98	-1.59	Peak	105	121
3		2483.50	39.30	54.00	-14.70	40.88	-1.58	Average	105	121
4		2483.50	52.37	74.00	-21.63	53.95	-1.58	Peak	105	121
5		4960.00	36.08	54.00	-17.92	30.37	5.71	Average	100	127
6		4960.00	48.09	74.00	-25.91	42.38	5.71	Peak	100	127
7		7440.00	40.97	54.00	-13.03	30.32	10.65	Average	100	126
8		7440.00	52.99	74.00	-21.01	42.34	10.65	Peak	100	126

Note 1: Emission Level (dBuV/m) = SA Reading (dBuV/m) + Factor* (dB)

*Factor includes antenna factor , cable loss and amplifier gain

Note 2: Margin (dB) = Emission level (dBuV/m) – Limit (dBuV/m).

Note 3:"*" is Peak / Average value of fundamental frequency



Modulation	BT-LE (2Mbps)	Test Freq. (MHz)	2480
Polarization	Vertical		

Test By :Akun Chung Temperature(°C):24 Humidity(%):67

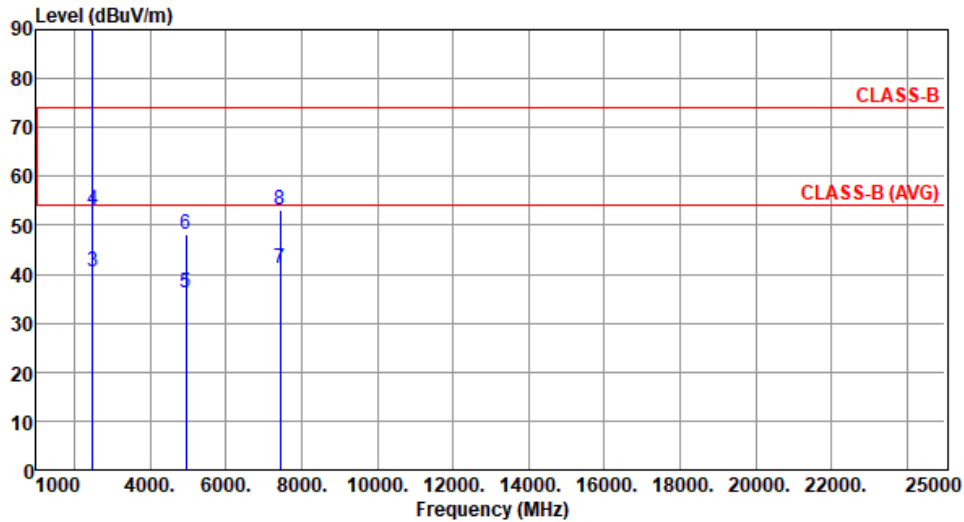

		Freq. MHz	Emission level dBuV/m	Limit dBuV/m	Margin dB	SA reading dBuV	Factor dB/m	Remark	ANT High cm	Turn Table deg
1	*	2480.00	92.34			93.93	-1.59	Average	100	77
2	*	2480.00	94.86			96.45	-1.59	Peak	100	77
3		2483.50	40.39	54.00	-13.61	41.97	-1.58	Average	100	77
4		2483.50	53.22	74.00	-20.78	54.80	-1.58	Peak	100	77
5		4960.00	36.24	54.00	-17.76	30.53	5.71	Average	100	82
6		4960.00	48.31	74.00	-25.69	42.60	5.71	Peak	100	82
7		7440.00	41.25	54.00	-12.75	30.60	10.65	Average	100	79
8		7440.00	53.22	74.00	-20.78	42.57	10.65	Peak	100	79

Note 1: Emission Level (dBuV/m) = SA Reading (dBuV/m) + Factor* (dB)

*Factor includes antenna factor , cable loss and amplifier gain

Note 2: Margin (dB) = Emission level (dBuV/m) – Limit (dBuV/m).

Note 3:"*" is Peak / Average value of fundamental frequency



POE mode

Unwanted Emissions (Below 1GHz)

Modulation	BT-LE (1Mbps)	Test Freq. (MHz)	2402
Polarization	Horizontal		

Test By :Akun Chung Temperature(°C):22 Humidity(%):69

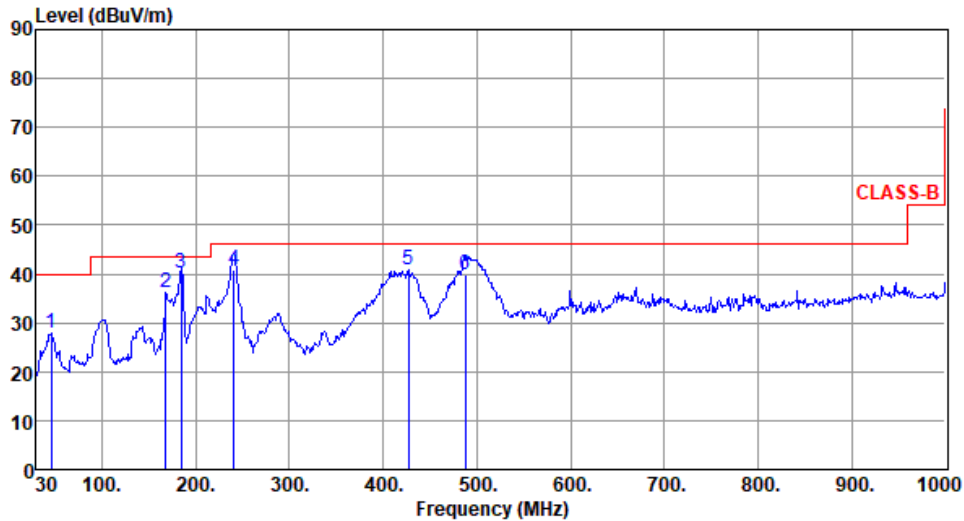

	Freq. MHz	Emission level dBuV/m	Limit dBuV/m	Margin dB	SA reading dBuV	Factor dB/m	Remark	ANT High cm	Turn Table deg
1	45.52	27.83	40.00	-12.17	36.25	-8.42	Peak	---	---
2	167.74	36.34	43.50	-7.16	45.01	-8.67	Peak	---	---
3	184.23	40.11	43.50	-3.39	50.43	-10.32	QP	152	126
4	240.49	40.99	46.00	-5.01	50.97	-9.98	QP	108	112
5	426.73	40.97	46.00	-5.03	45.20	-4.23	Peak	---	---
6	487.84	39.85	46.00	-6.15	42.54	-2.69	QP	163	206

Note 1: Emission Level (dBuV/m) = SA Reading (dBuV/m) + Factor* (dB)

*Factor includes antenna factor , cable loss and amplifier gain

Note 2: Margin (dB) = Emission level (dBuV/m) – Limit (dBuV/m).

Note 3: All spurious emissions below 30MHz are more than 20 dB below the limit.



Modulation	BT-LE (1Mbps)	Test Freq. (MHz)	2402
Polarization	Vertical		

Test By :Akun Chung Temperature(°C):22 Humidity(%):69

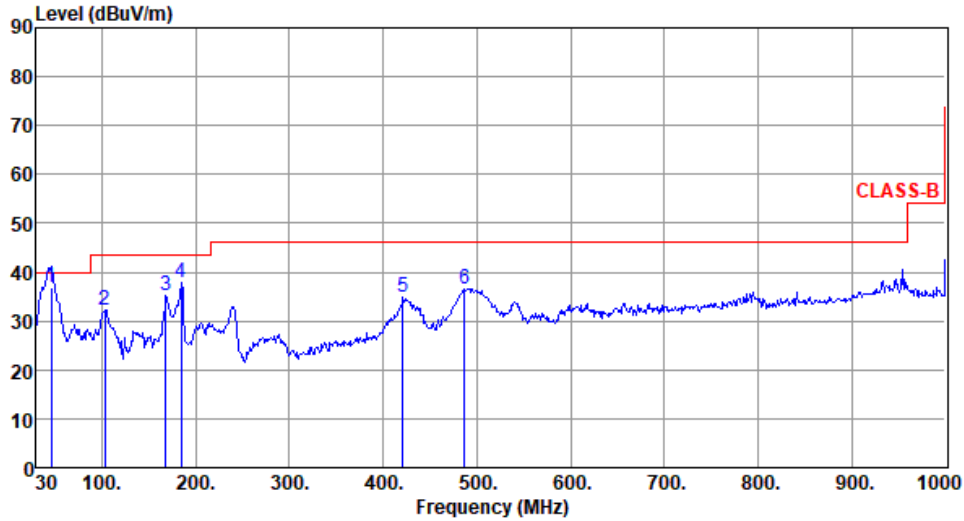

	Freq. MHz	Emission level dBuV/m	Limit dBuV/m	Margin dB	SA reading dBuV	Factor dB/m	Remark	ANT High cm	Turn Table deg
1	45.52	36.95	40.00	-3.05	45.37	-8.42	QP	100	11
2	102.75	32.12	43.50	-11.38	44.74	-12.62	Peak	---	---
3	167.74	35.13	43.50	-8.37	43.80	-8.67	Peak	---	---
4	184.23	37.70	43.50	-5.80	48.02	-10.32	Peak	---	---
5	420.91	34.74	46.00	-11.26	39.16	-4.42	Peak	---	---
6	486.87	36.65	46.00	-9.35	39.36	-2.71	Peak	---	---

Note 1: Emission Level (dBuV/m) = SA Reading (dBuV/m) + Factor* (dB)

*Factor includes antenna factor , cable loss and amplifier gain

Note 2: Margin (dB) = Emission level (dBuV/m) – Limit (dBuV/m).

Note 3: All spurious emissions below 30MHz are more than 20 dB below the limit.



BT-LE(125kbps)
2402MHz

CSEndB-DTS

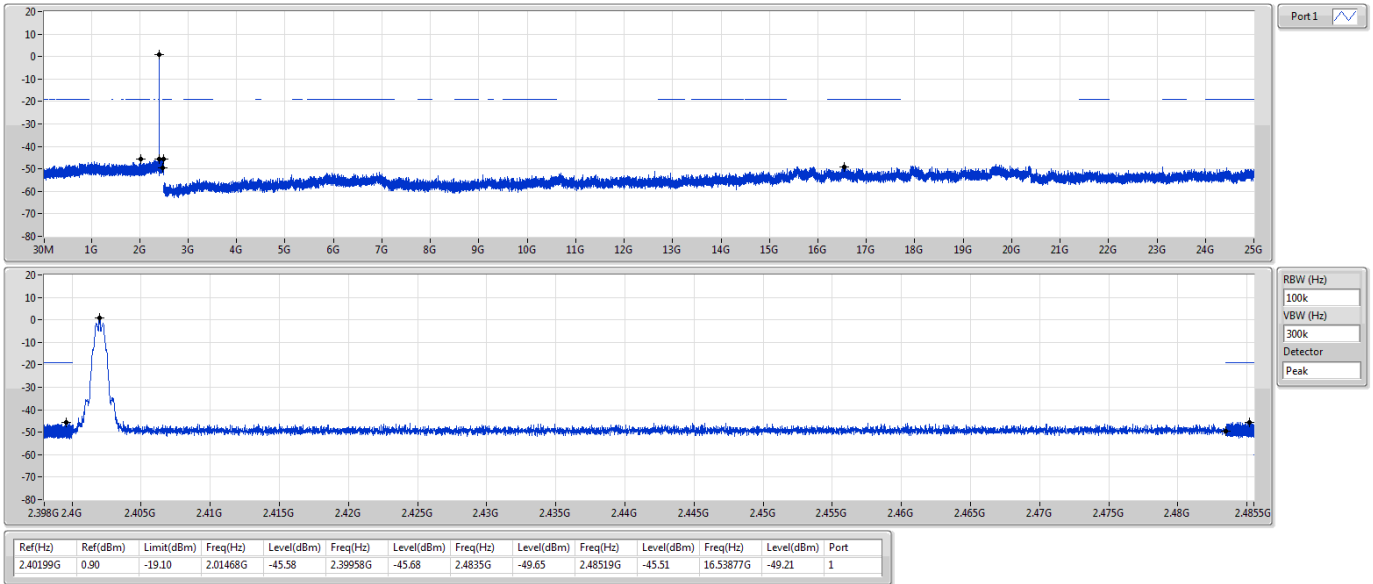

BT-LE(125kbps)
2440MHz

CSEndB-DTS

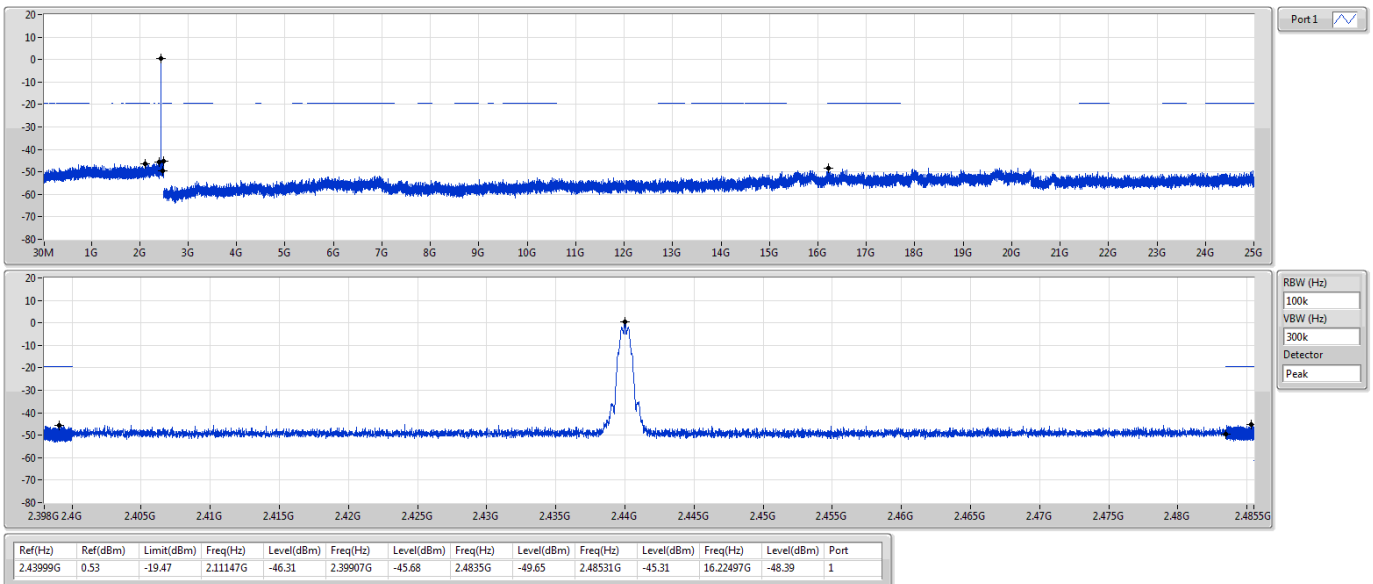

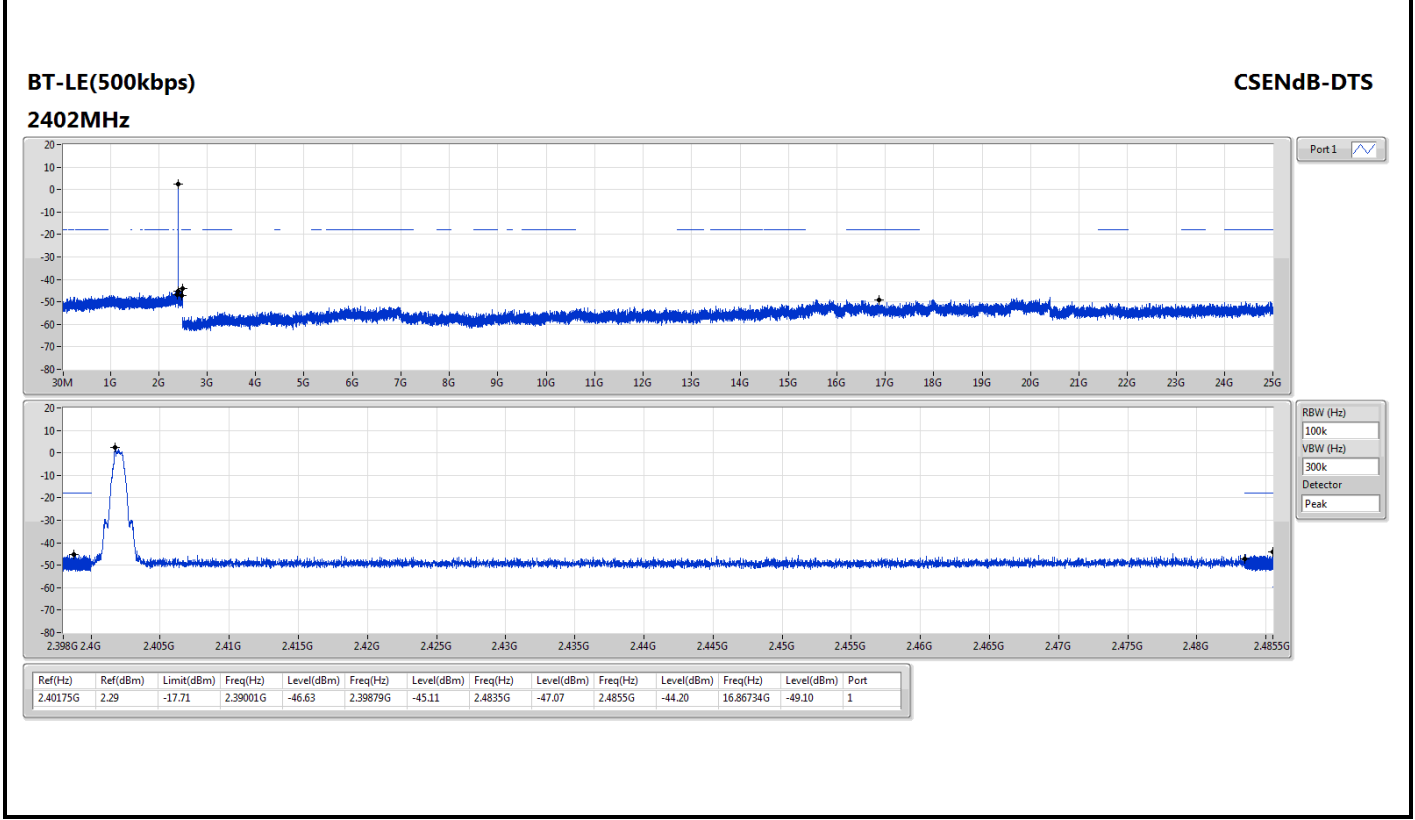
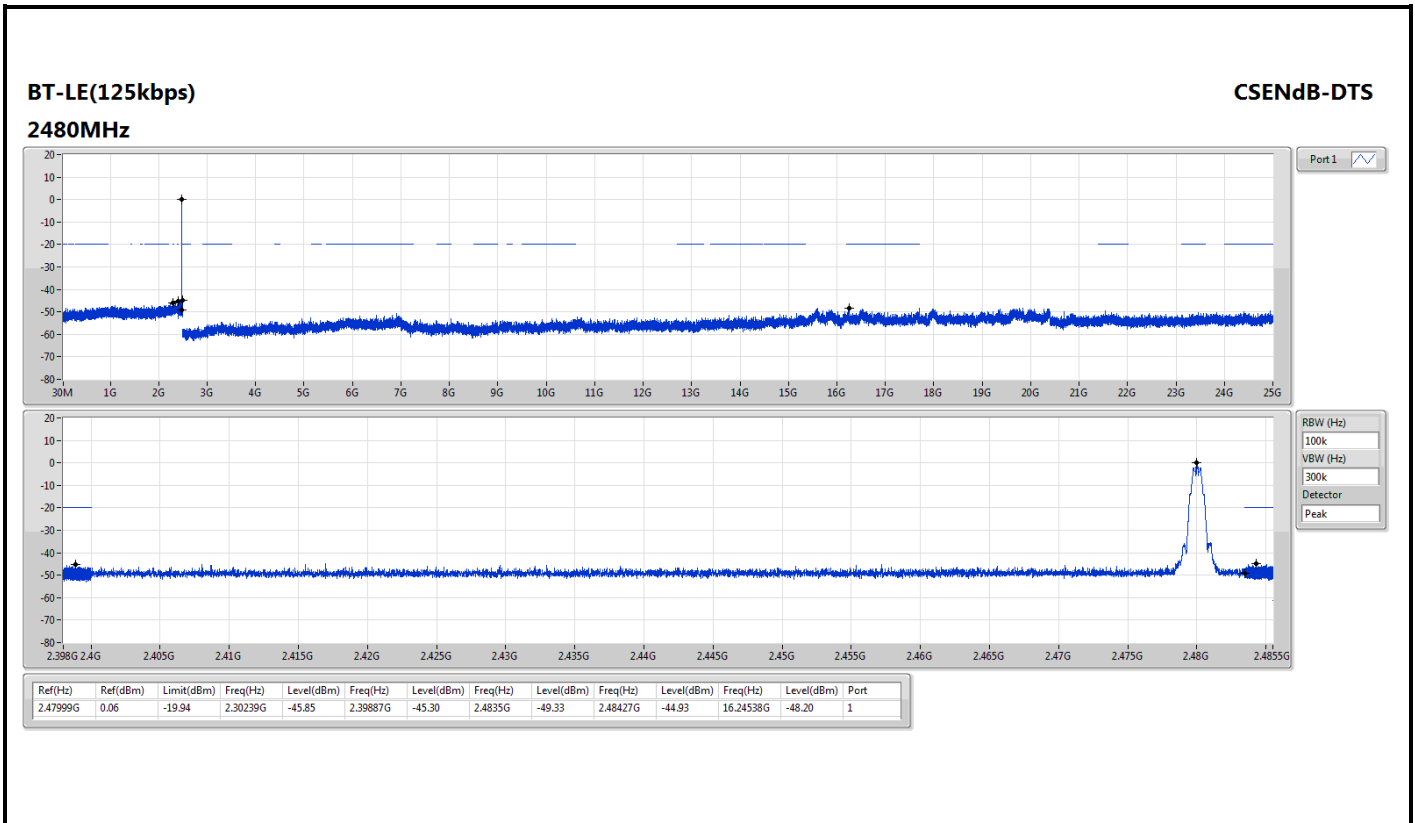

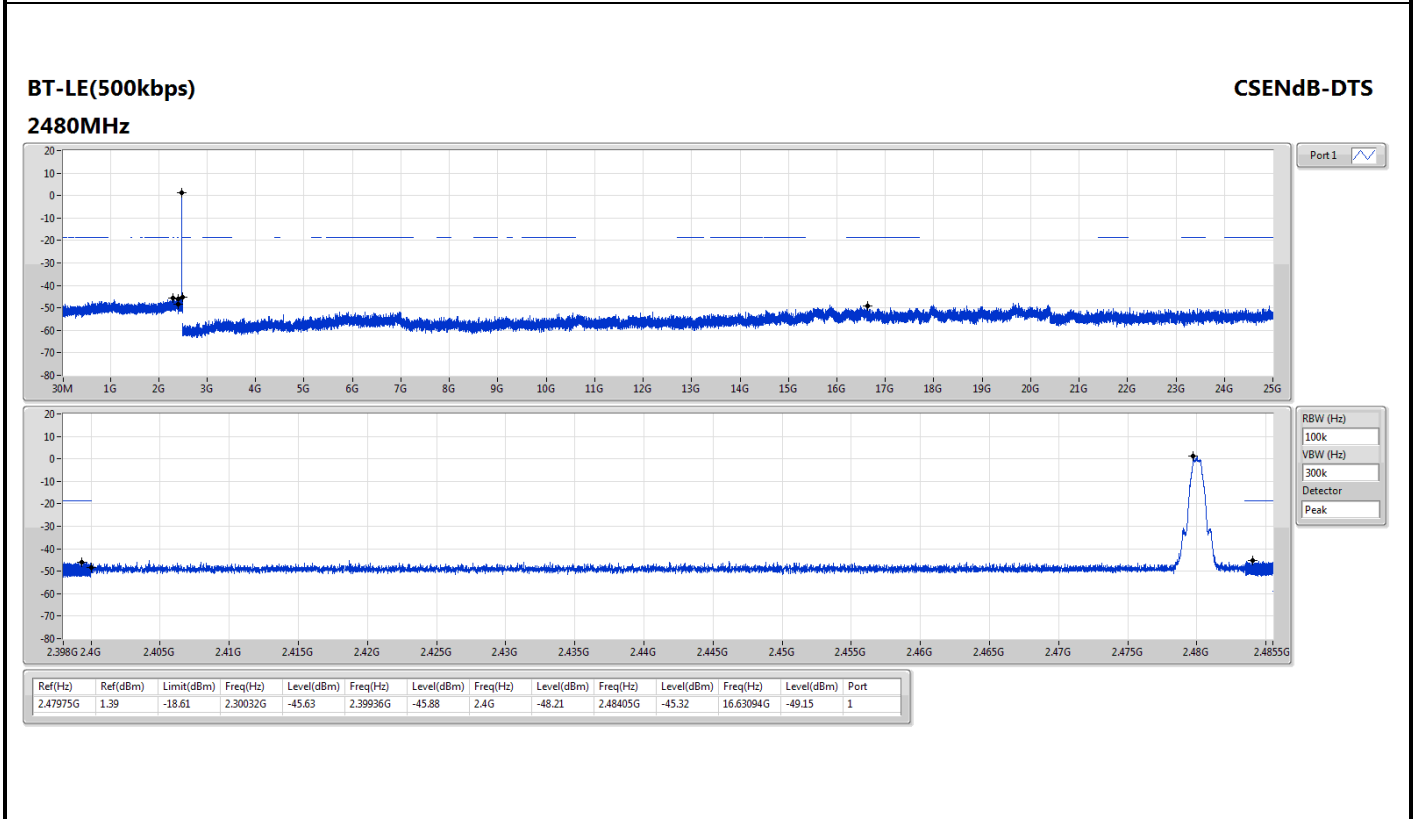
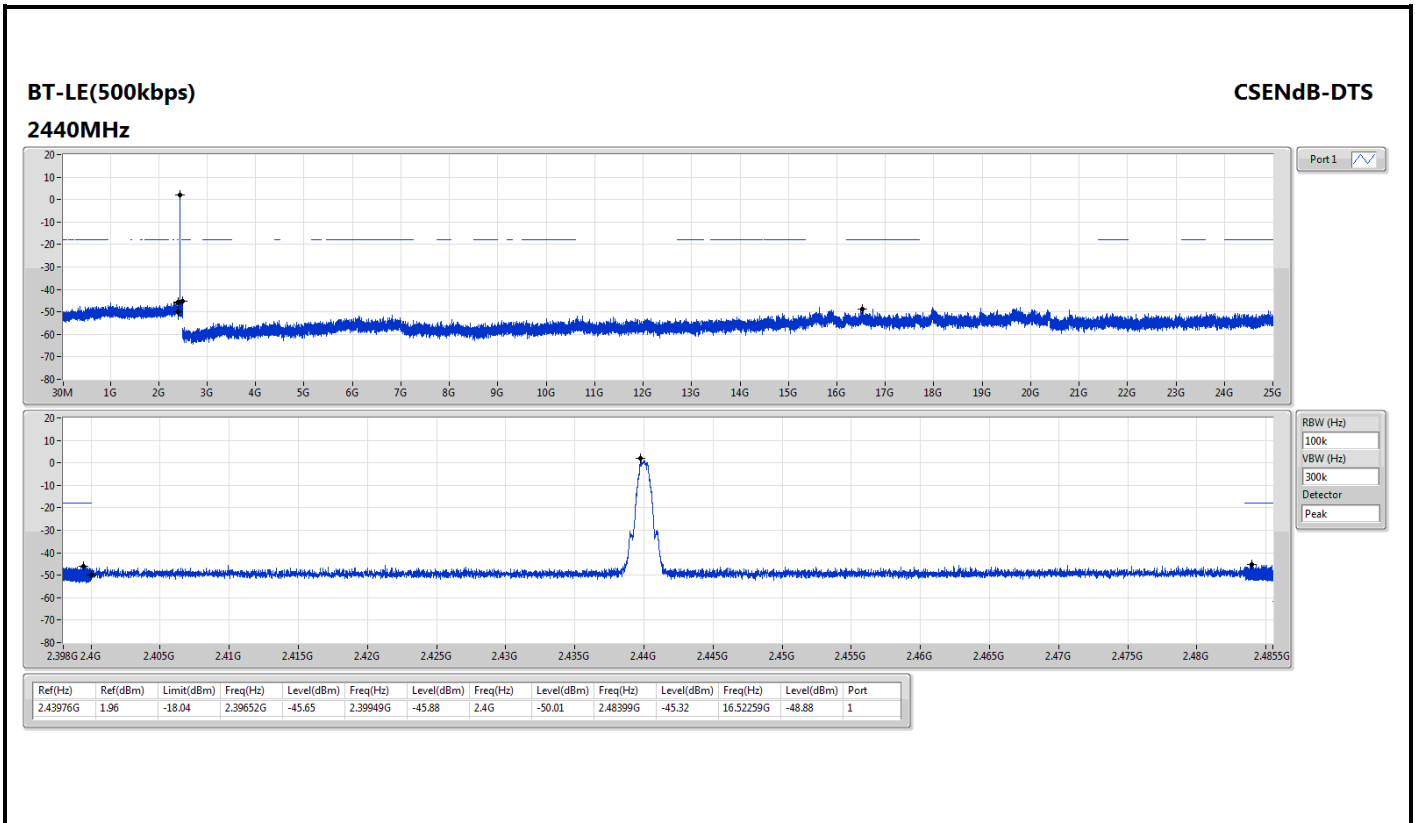

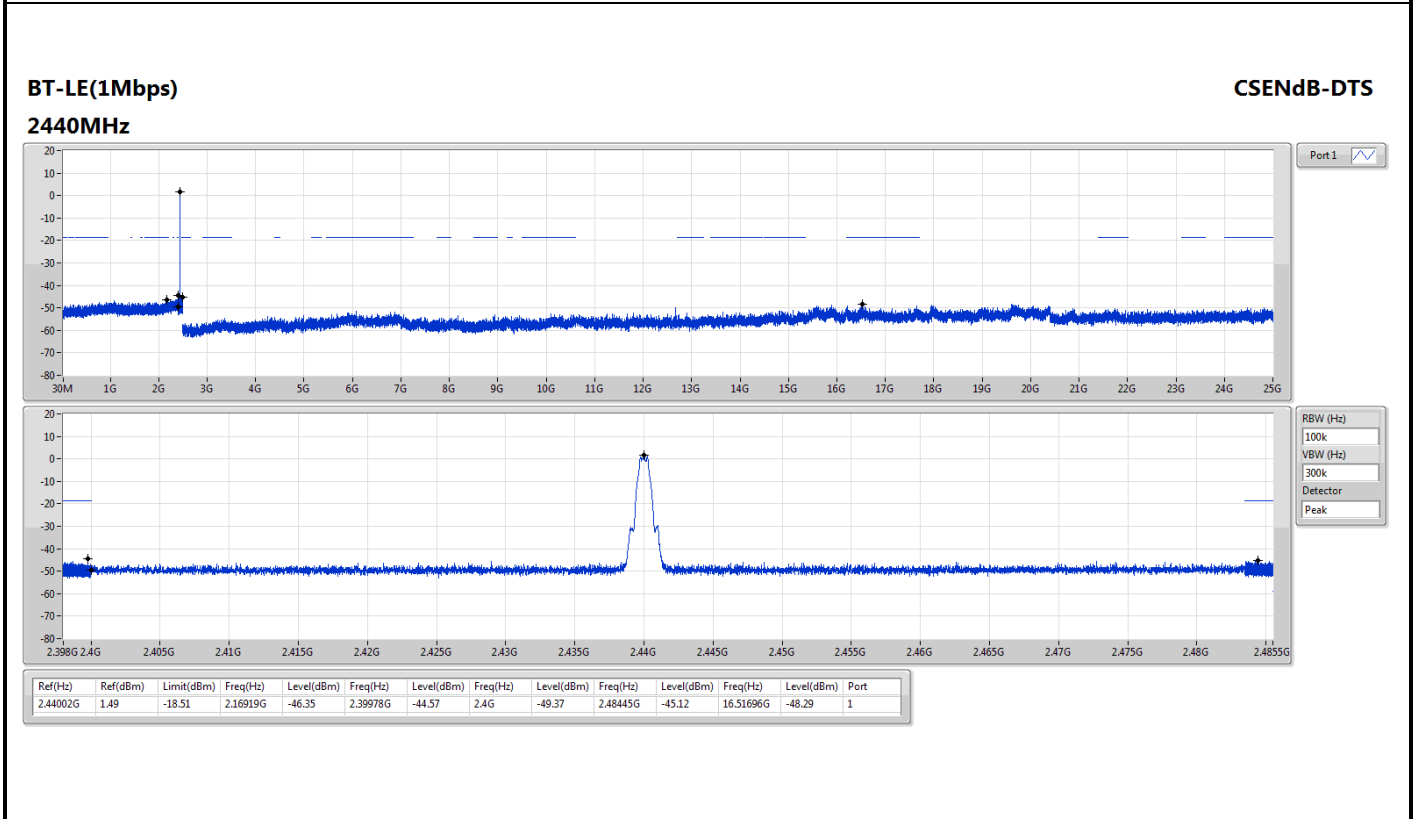
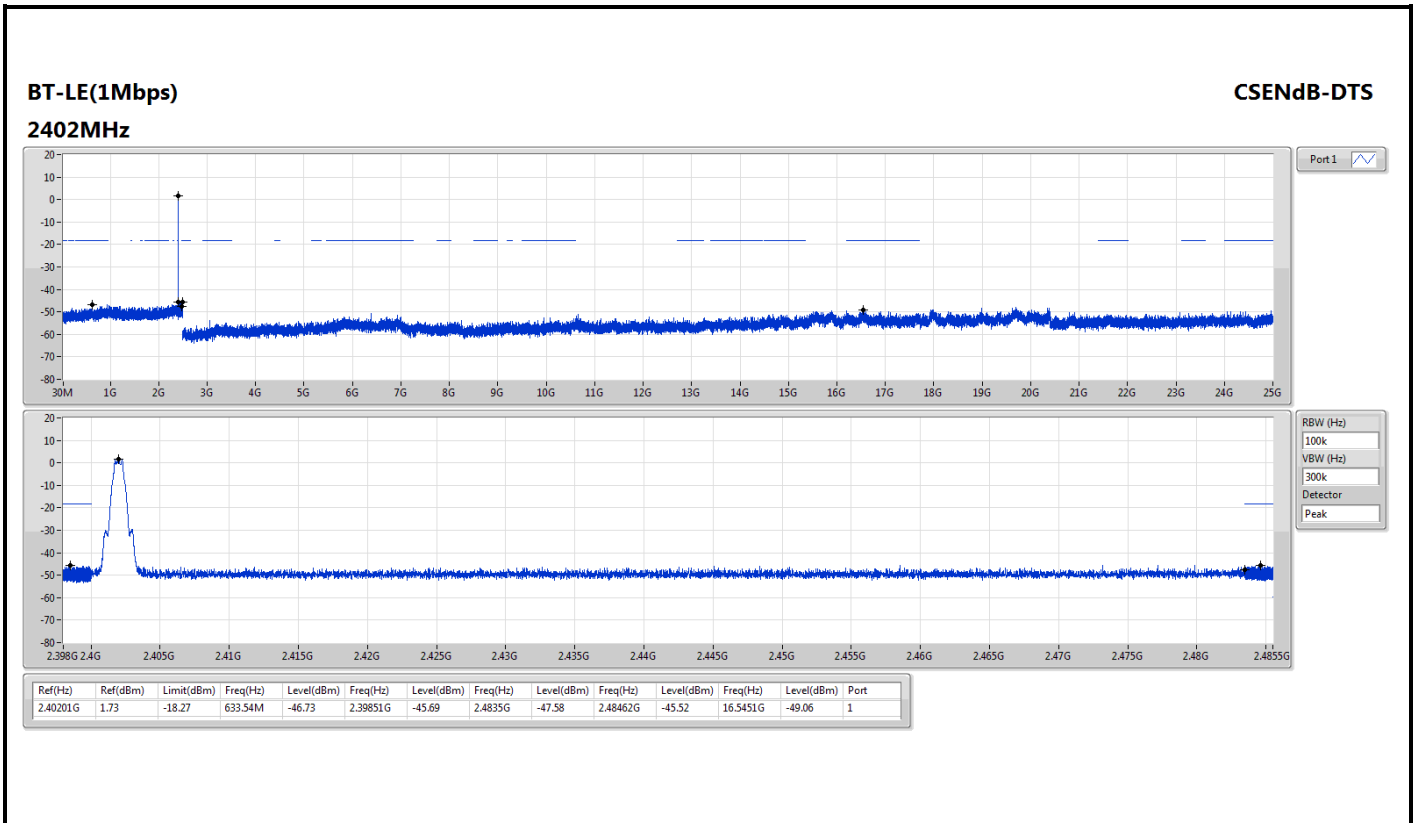

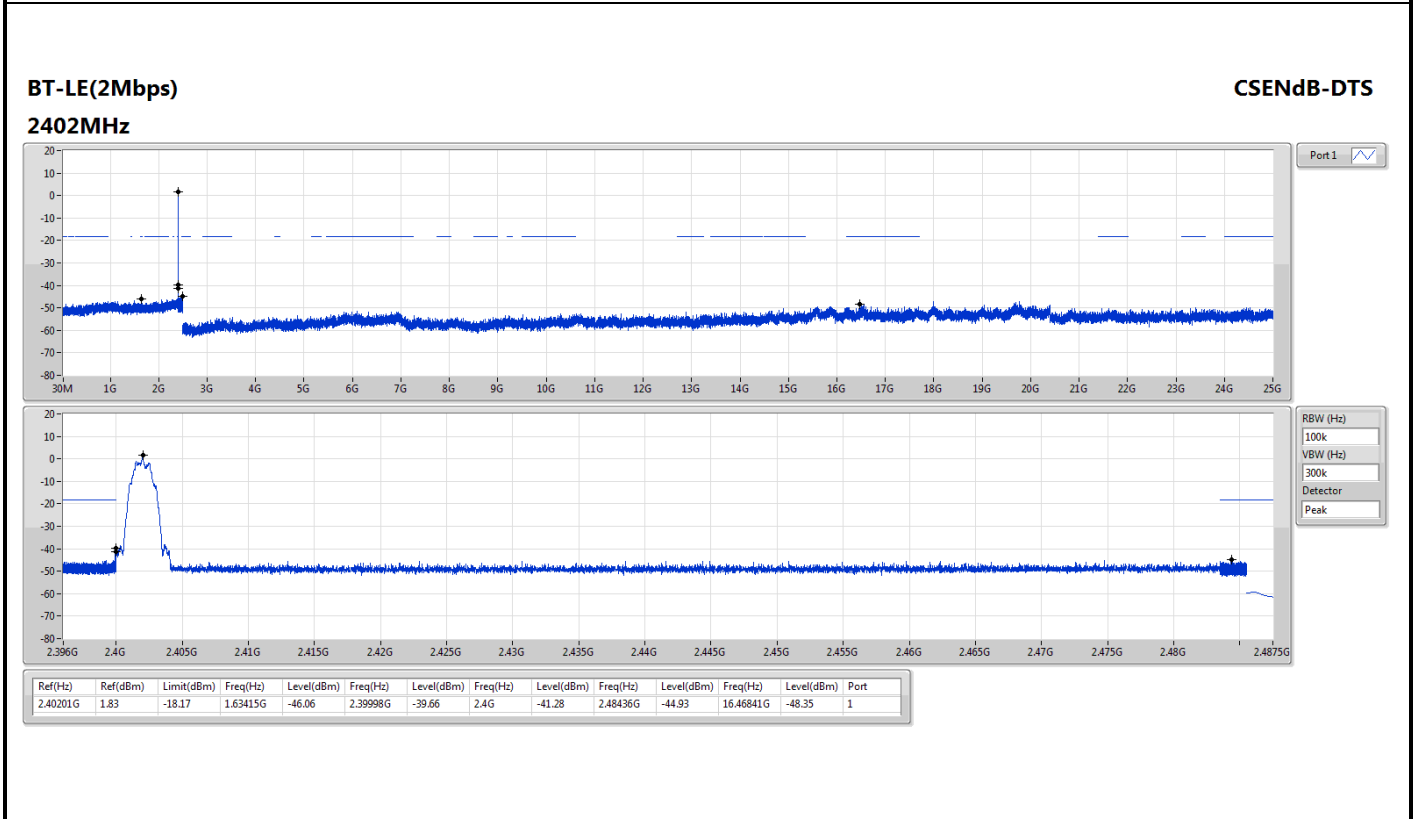
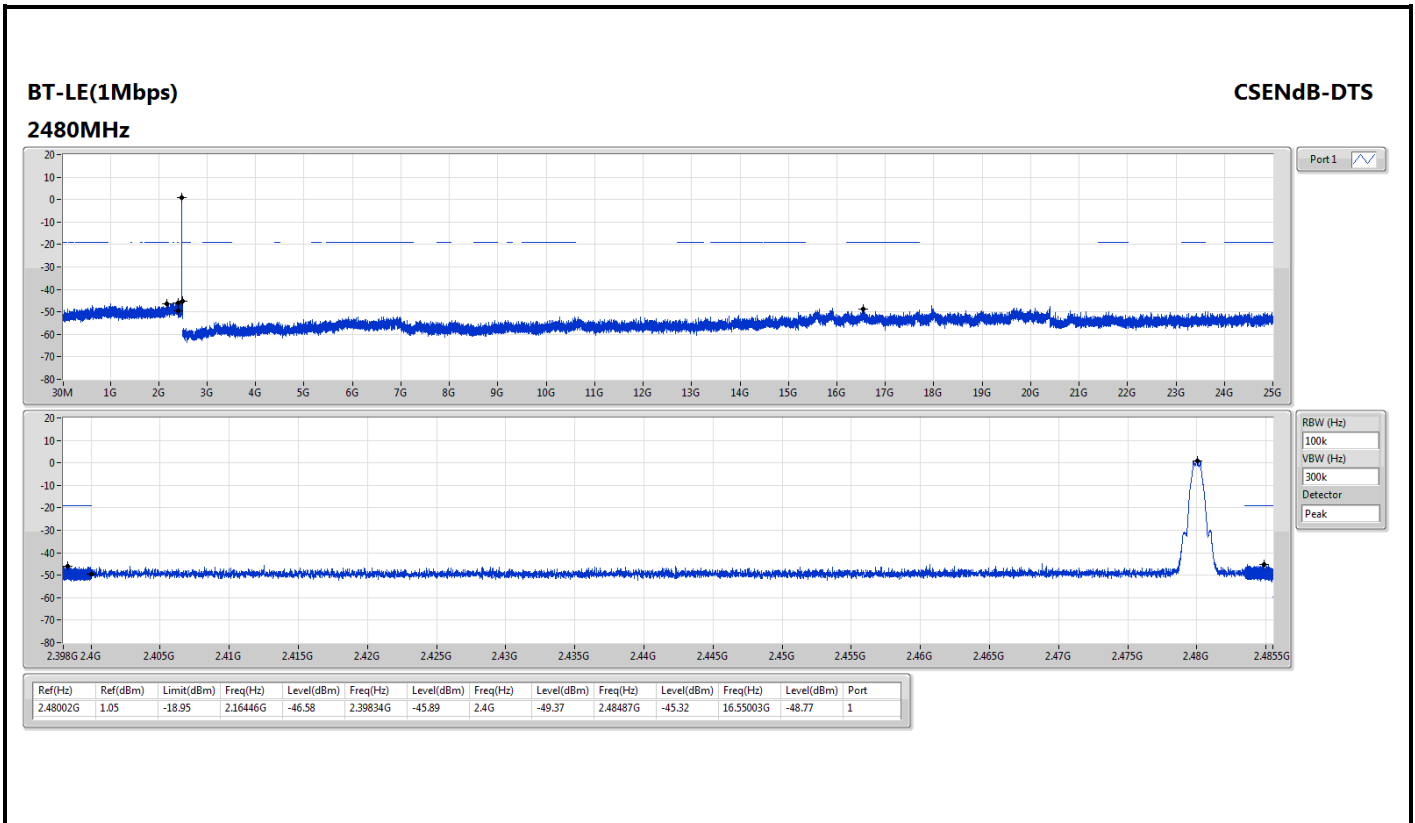

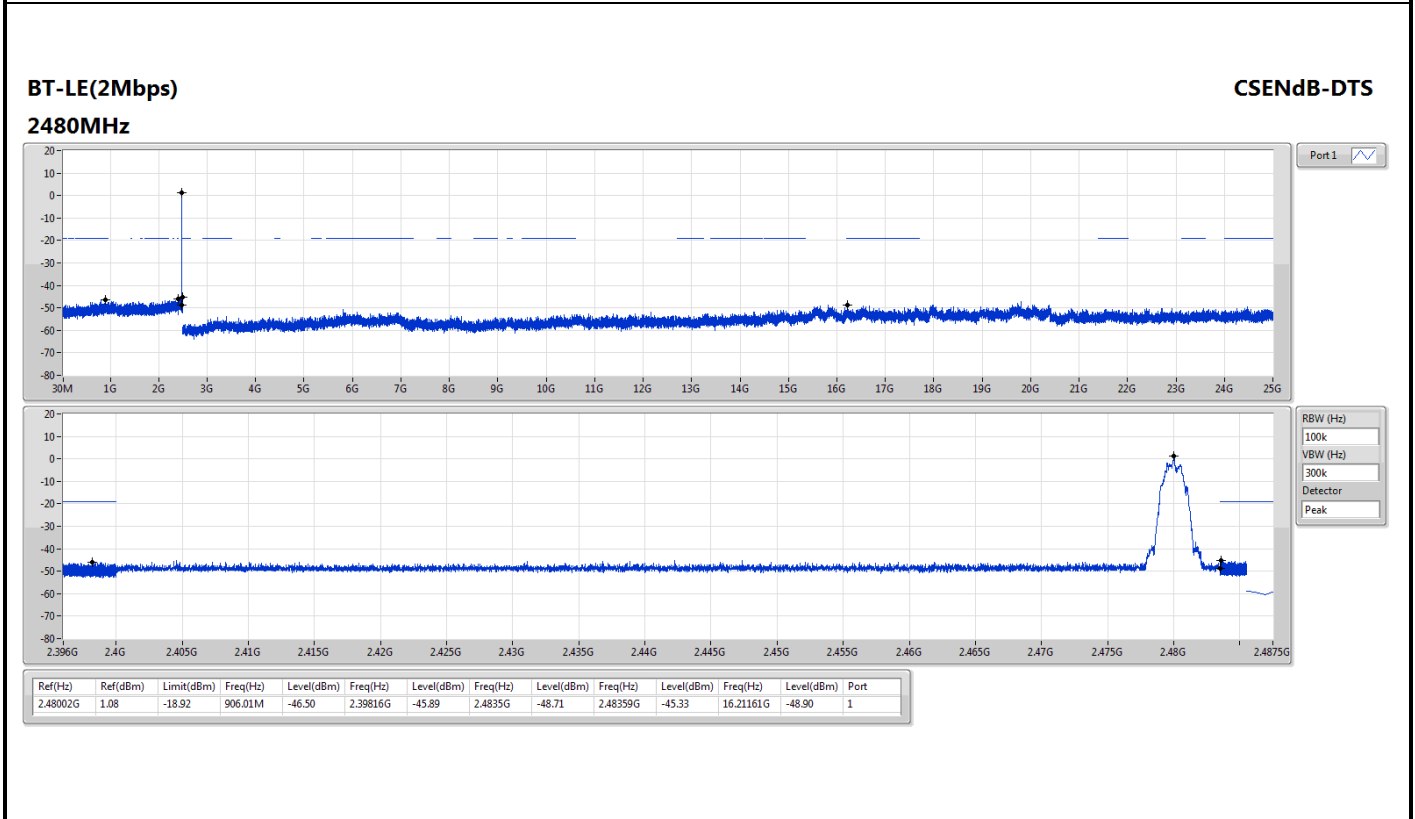
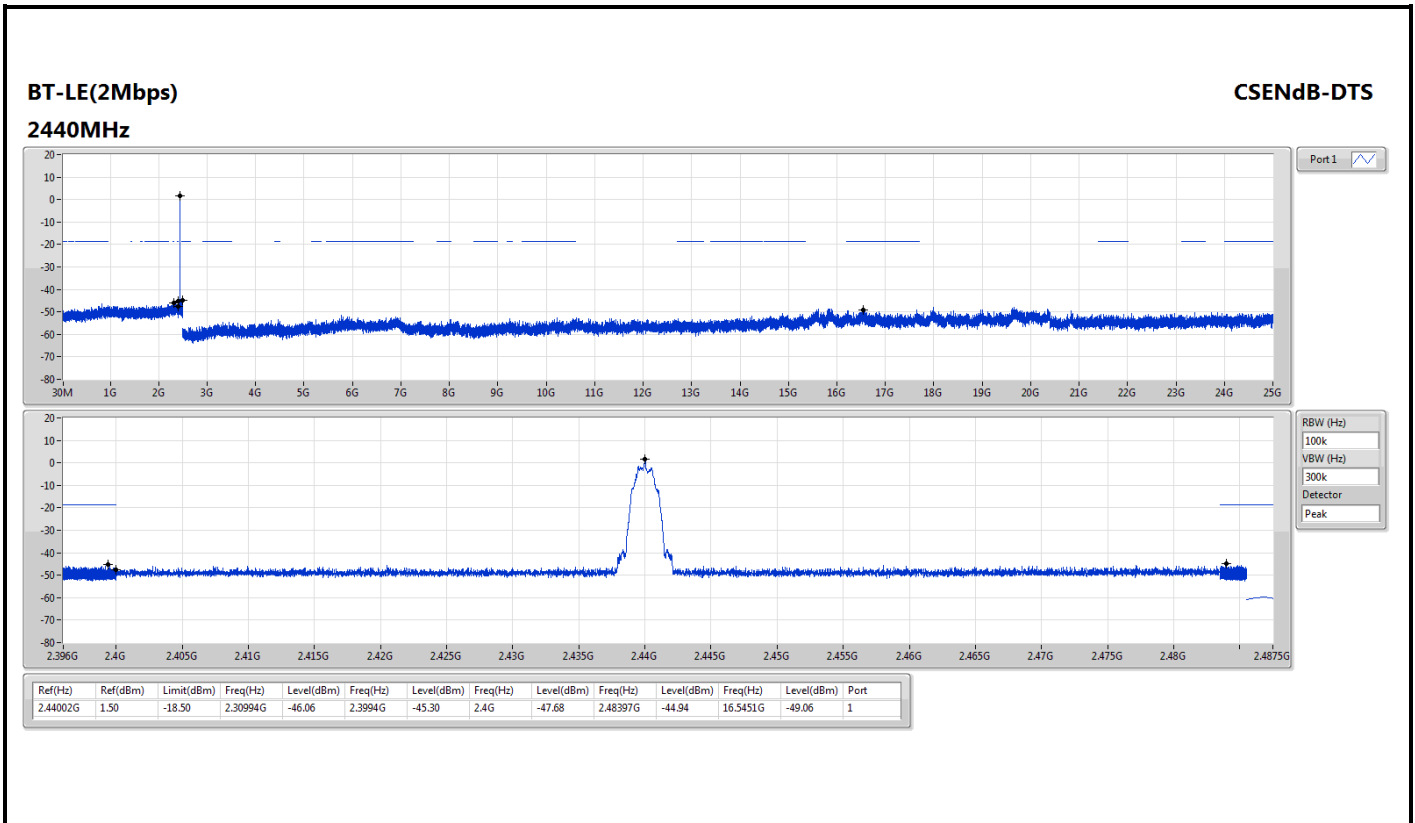



Adapter mode

Modulation	BT-LE(2Mbps)	Test Freq. (MHz)	2402
Power Phase	Line		

Test by : Joe Liao Temperature: 21°C Humidity: 64%

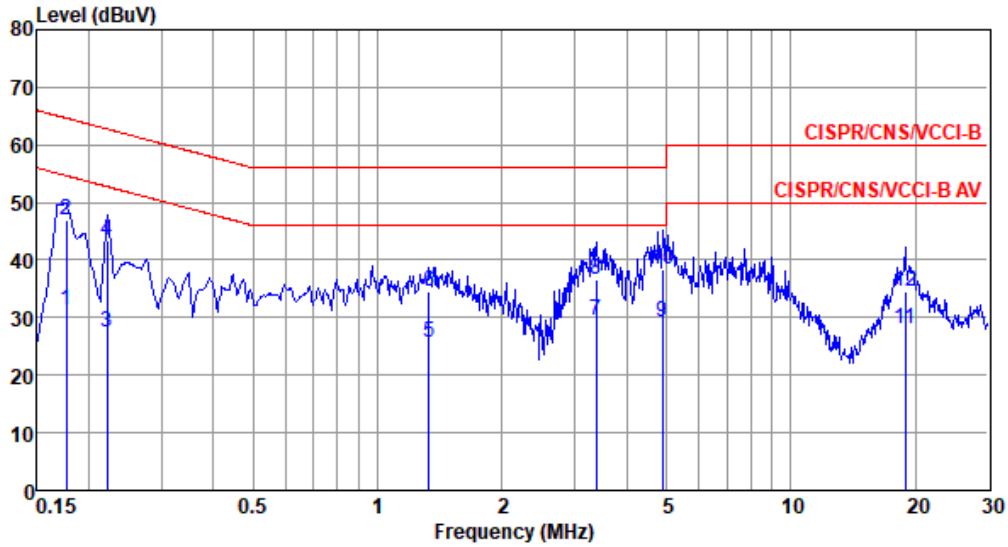

	Freq MHz	Level dBuV	Limit Line dBuV	Over Limit dB	Read Level dBuV	Factor dB	Cable loss dB	Aux dB	Remark
1	0.177	31.42	54.64	-23.22	21.45	9.68	0.08	0.21	Average
2	0.177	46.97	64.64	-17.67	37.00	9.68	0.08	0.21	QP
3	0.222	27.59	52.74	-25.15	17.59	9.68	0.08	0.24	Average
4	0.222	43.40	62.74	-19.34	33.40	9.68	0.08	0.24	QP
5	1.331	25.75	46.00	-20.25	15.51	9.68	0.18	0.38	Average
6	1.331	34.47	56.00	-21.53	24.23	9.68	0.18	0.38	QP
7*	3.381	29.55	46.00	-16.45	19.23	9.70	0.21	0.41	Average
8	3.381	36.74	56.00	-19.26	26.42	9.70	0.21	0.41	QP
9	4.900	29.15	46.00	-16.85	18.76	9.71	0.26	0.42	Average
10	4.900	38.48	56.00	-17.52	28.09	9.71	0.26	0.42	QP
11	18.920	27.95	50.00	-22.05	16.96	9.73	0.64	0.62	Average
12	18.920	34.48	60.00	-25.52	23.49	9.73	0.64	0.62	QP

Note 1: Level (dBuV) = Read Level (dBuV) + LISN Factor (dB) + Cable Loss (dB) + Aux (dB).
 Note 2: Over Limit (dB) = Level (dBuV) - Limit Line (dBuV).



Modulation	BT-LE(2Mbps)	Test Freq. (MHz)	2402
Power Phase	Neutral		

Test by : Joe Liao Temperature: 21°C Humidity: 64%

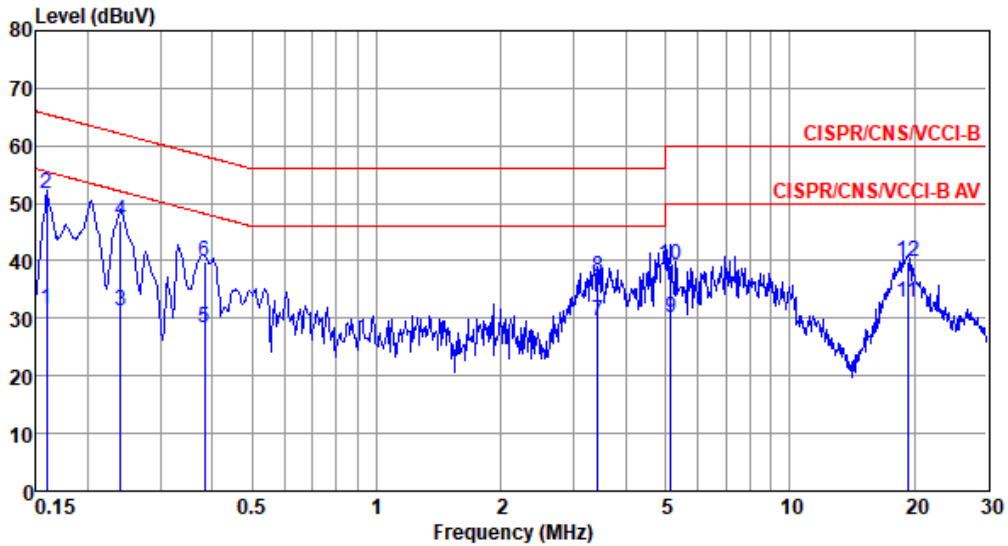

	Freq MHz	Level dBuV	Limit Line dBuV	Over Limit dB	Read Level dBuV	Factor dB	Cable loss dB	Aux dB	Remark
1	0.159	31.73	55.52	-23.79	21.88	9.61	0.08	0.16	Average
2*	0.159	51.60	65.52	-13.92	41.75	9.61	0.08	0.16	QP
3	0.240	31.31	52.08	-20.77	21.44	9.61	0.08	0.18	Average
4	0.240	47.02	62.08	-15.06	37.15	9.61	0.08	0.18	QP
5	0.383	28.28	48.21	-19.93	18.40	9.61	0.08	0.19	Average
6	0.383	39.99	58.21	-18.22	30.11	9.61	0.08	0.19	QP
7	3.436	29.58	46.00	-16.42	19.41	9.64	0.21	0.32	Average
8	3.436	37.09	56.00	-18.91	26.92	9.64	0.21	0.32	QP
9	5.139	30.23	50.00	-19.77	19.97	9.65	0.27	0.34	Average
10	5.139	39.20	60.00	-20.80	28.94	9.65	0.27	0.34	QP
11	19.326	32.68	50.00	-17.32	21.79	9.79	0.65	0.45	Average
12	19.326	39.71	60.00	-20.29	28.82	9.79	0.65	0.45	QP

Note 1: Level (dBuV) = Read Level (dBuV) + LISN Factor (dB) + Cable Loss (dB) + Aux (dB).
 2: Over Limit (dB) = Level (dBuV) – Limit Line (dBuV).



POE mode

Modulation	BT-LE(2Mbps)	Test Freq. (MHz)	2402
Power Phase	Line		

Test by : Joe Liao Temperature: 21°C Humidity: 64%

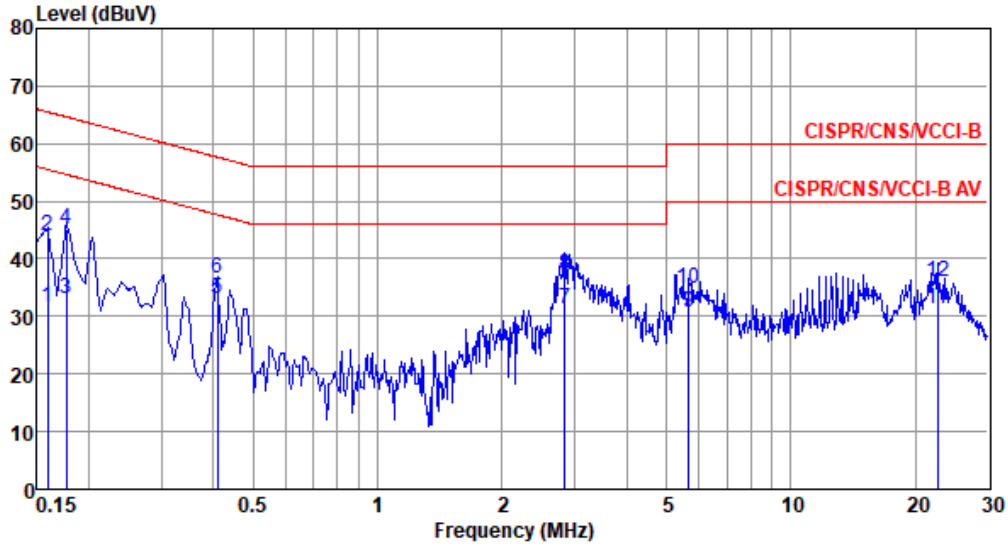

	Freq MHz	Level dBuV	Limit Line dBuV	Over Limit dB	Read Level dBuV	Factor dB	Cable loss dB	Aux dB	Remark
1	0.159	31.71	55.52	-23.81	21.95	9.68	0.08	0.00	Average
2	0.159	43.93	65.52	-21.59	34.17	9.68	0.08	0.00	QP
3	0.177	33.06	54.64	-21.58	23.30	9.68	0.08	0.00	Average
4	0.177	45.14	64.64	-19.50	35.38	9.68	0.08	0.00	QP
5*	0.411	33.19	47.64	-14.45	23.44	9.67	0.08	0.00	Average
6	0.411	36.49	57.64	-21.15	26.74	9.67	0.08	0.00	QP
7	2.839	31.31	46.00	-14.69	21.42	9.69	0.20	0.00	Average
8	2.839	37.25	56.00	-18.75	27.36	9.69	0.20	0.00	QP
9	5.653	30.57	50.00	-19.43	20.56	9.71	0.30	0.00	Average
10	5.653	34.86	60.00	-25.14	24.85	9.71	0.30	0.00	QP
11	22.655	31.29	50.00	-18.71	20.90	9.71	0.68	0.00	Average
12	22.655	36.00	60.00	-24.00	25.61	9.71	0.68	0.00	QP

Note 1: Level (dBuV) = Read Level (dBuV) + LISN Factor (dB) + Cable Loss (dB) + Aux (dB).
 Note 2: Over Limit (dB) = Level (dBuV) - Limit Line (dBuV).



Modulation	BT-LE(2Mbps)	Test Freq. (MHz)	2402
Power Phase	Neutral		

Test by : Joe Liao Temperature: 21°C Humidity: 64%

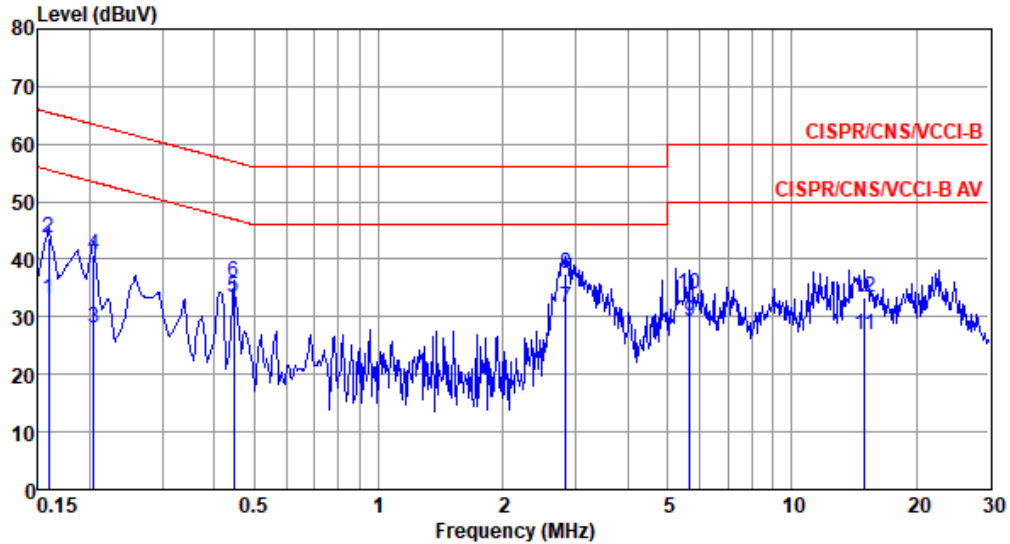

	Freq MHz	Level dBuV	Limit Line dBuV	Over Limit dB	Read Level dBuV	Factor dB	Cable loss dB	Aux dB	Remark
1	0.159	33.15	55.52	-22.37	23.46	9.61	0.08	0.00	Average
2	0.159	43.72	65.52	-21.80	34.03	9.61	0.08	0.00	QP
3	0.204	28.18	53.45	-25.27	18.49	9.61	0.08	0.00	Average
4	0.204	40.85	63.45	-22.60	31.16	9.61	0.08	0.00	QP
5*	0.447	33.24	46.93	-13.69	23.54	9.61	0.09	0.00	Average
6	0.447	35.88	56.93	-21.05	26.18	9.61	0.09	0.00	QP
7	2.839	31.50	46.00	-14.50	21.67	9.63	0.20	0.00	Average
8	2.839	37.51	56.00	-18.49	27.68	9.63	0.20	0.00	QP
9	5.653	29.33	50.00	-20.67	19.37	9.66	0.30	0.00	Average
10	5.653	34.01	60.00	-25.99	24.05	9.66	0.30	0.00	QP
11	14.986	26.97	50.00	-23.03	16.66	9.75	0.56	0.00	Average
12	14.986	33.26	60.00	-26.74	22.95	9.75	0.56	0.00	QP

Note 1: Level (dBuV) = Read Level (dBuV) + LISN Factor (dB) + Cable Loss (dB) + Aux (dB).
 2: Over Limit (dB) = Level (dBuV) – Limit Line (dBuV).