

FCC Test Report

FCC ID : I8811AXAP22
Equipment : 802.11ax (WiFi 6) Dual-Radio Unified Access Point
Model No. : WAX510D, NWA110AX
Multiple Listing : Refer to item 1.1.1 for more details.
Brand Name : ZYXEL
Applicant : Zyxel Communications Corporation
Address : No.2 Industry East RD. IX, Hsinchu Science Park,
Hsinchu 30075, Taiwan, R.O.C
Standard : 47 CFR FCC Part 15.407
Received Date : Dec. 18, 2019
Tested Date : Dec. 23, 2019 ~ Jan. 14, 2020

We, International Certification Corp., would like to declare that the tested sample has been evaluated and in compliance with the requirement of the above standards. The test results contained in this report refer exclusively to the product. It may be duplicated completely for legal use with the approval of the applicant. It shall not be reproduced except in full without the written approval of our laboratory.

Reviewed by:

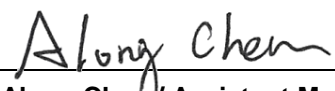

Along Chen / Assistant Manager

Approved by:



Gary Chang / Manager



Table of Contents

1	GENERAL DESCRIPTION	5
1.1	Information.....	5
1.2	Local Support Equipment List	12
1.3	Test Setup Chart	12
1.4	The Equipment List	13
1.5	Testing Applied Standards	14
1.6	Deviation from Test Standard and Measurement Procedure.....	14
1.7	Measurement Uncertainty	15
2	TEST CONFIGURATION	16
2.1	Testing Condition	16
2.2	The Worst Test Modes and Channel Details	17
3	TRANSMITTER TEST RESULTS.....	19
3.1	Conducted Emissions.....	19
3.2	Emission Bandwidth	28
3.3	RF Output Power.....	48
3.4	Peak Power Spectral Density.....	56
3.5	Transmitter Radiated and Band Edge Emissions	77
3.6	Frequency Stability.....	172
4	TEST LABORATORY INFORMATION	174

Release Record

Report No.	Version	Description	Issued Date
FR9D0202AN	Rev. 01	Initial issue	Jan. 21, 2020
FR9D0202AN	Rev. 02	1. Adding B2 & B3 information 2. Revising the accessories description & FCC ID	Apr. 23, 2020

Summary of Test Results

FCC Rules	Test Items	Measured	Result
15.207	Conducted Emissions	[dBuV]: 19.428MHz 41.177 (Margin -8.83dB) - AV	Pass
15.407(b) 15.209	Radiated Emissions	[dBuV/m at 3m]: 5150.00MHz 53.83 (Margin -0.17dB) - PK	Pass
15.407(a)	Emission Bandwidth	Meet the requirement of limit	Pass
15.407(e)	6dB bandwidth	Meet the requirement of limit	Pass
15.407(a)	RF Output Power	Max Power [dBm]: Non-beamforming mode 5150~5250MHz: 25.67 5250~5350MHz: 23.79 5470~5725MHz: 23.77 5725~5850MHz: 26.02 Beamforming mode 5150~5250MHz: 21.28 5250~5350MHz: 20.78 5470~5725MHz: 20.76 5725~5850MHz: 23.01	Pass
15.407(a)	Peak Power Spectral Density	Meet the requirement of limit	Pass
15.407(g)	Frequency Stability	Meet the requirement of limit	Pass
15.203	Antenna Requirement	Meet the requirement of limit	Pass

Declaration of Conformity:

The test results with all measurement uncertainty excluded are presented in accordance with the regulation limits or requirements declared by manufacturers.

Comments and Explanations:

The declared of product specification for EUT presented in the report are provided by the manufacturer, and the manufacturer takes all the responsibilities for the accuracy of product specification.

1 General Description

1.1 Information

1.1.1 Product Details

The following models are provided to this EUT.

Brand Name	Model Name	Product Name	Description
ZYXEL	WAX510D	802.11ax (WiFi 6) Dual-Radio Unified Access Point	Difference between two models is software. WAX510D (FAT/Thin/Cloud AP), NWA110AX (FAT/Cloud AP).
	NWA110AX	802.11ax (WiFi 6) Dual-Radio PoE Access Point	

✦ The above models, model **WAX510D** was selected as a representative one for the final test and only its data was recorded in this report.

1.1.2 Specification of the Equipment under Test (EUT)

RF General Information					
Frequency Range (MHz)	IEEE Std. 802.11	Ch. Freq. (MHz)	Channel Number	Transmit Chains (N _{TX})	Data Rate / MCS
5150-5250 5250-5350 5470-5725 5725-5850	a	5180-5240 5260-5320 5500-5720 5745-5825	36-48 [4] 52-64 [4] 100-144 [12] 149-165 [5]	2	6-54 Mbps
5150-5250 5250-5350 5470-5725 5725-5850	n (HT20)	5180-5240 5260-5320 5500-5720 5745-5825	36-48 [4] 52-64 [4] 100-144 [12] 149-165 [5]	2	MCS 0-15
5150-5250 5250-5350 5470-5725 5725-5850	n (HT40)	5190-5230 5270-5310 5510-5710 5755-5795	38-46 [2] 54-62 [2] 102-142 [6] 151-159 [2]	2	MCS 0-15
5150-5250 5250-5350 5470-5725 5725-5850	ac (VHT20)	5180-5240 5260-5320 5500-5720 5745-5825	36-48 [4] 52-64 [4] 100-144 [12] 149-165 [5]	2	MCS 0-9
5150-5250 5250-5350 5470-5725 5725-5850	ac (VHT40)	5190-5230 5270-5310 5510-5710 5755-5795	38-46 [2] 54-62 [2] 102-142 [6] 151-159 [2]	2	MCS 0-9
5150-5250 5250-5350 5470-5725 5725-5850	ac (VHT80)	5210 5290 5530~5690 5775	42 [1] 58 [1] 106-138 [3] 155 [1]	2	MCS 0-9
5150-5250 5250-5350 5470-5725 5725-5850	ax (HE20)	5180-5240 5260-5320 5500-5720 5745-5825	36-48 [4] 52-64 [4] 100-144 [12] 149-165 [5]	2	MCS 0-11
5150-5250 5250-5350 5470-5725 5725-5850	ax (HE40)	5190-5230 5270-5310 5510-5710 5755-5795	38-46 [2] 54-62 [2] 102-142 [6] 151-159 [2]	2	MCS 0-11
5150-5250 5250-5350 5470-5725 5725-5850	ax (HE80)	5210 5290 5530~5690 5775	42 [1] 58 [1] 106-138 [3] 155 [1]	2	MCS 0-11

Note 1: Chip feature: OFDM/OFDMA- BPSK, QPSK, 16QAM, 64QAM, 256QAM and 1024 QAM modulation.
Note 2: Operating modes of this device are listed as above table.
Note 3: 802.11ax supports beamforming function.

1.1.3 Antenna Details

Ant. No.	Model	Type	Connector	Operating Frequencies (MHz) / Antenna Gain (dBi)				
				2400~2483.5	5150~5250	5250~5350	5470~5725	5725~5850
1	AP886-V3	Dipole	IPEX	--	4.5	4.5	5.2	5.5
2	AP886-V3	PIFA	IPEX	0	--	--	--	--
3	AP886-V3	Dipole	IPEX	0	4.5	4.5	5.2	5.5
4	AP886-V3	Dipole	IPEX	0	4.5	4.5	5.2	5.5

1.1.4 Power Supply Type of Equipment under Test (EUT)

Power Supply Type	12Vdc from adapter 30~57Vdc from POE
--------------------------	---

Note: The above power supply for POE is not bundled in market.

1.1.5 Accessories

Accessories		
No.	Equipment	Description
1	AC adapter (Only for model: NWA110AX)	Brand: APD Model: WB-18Q12R I/P: 100-240Vac, 50-60Hz, 0.6A Max O/P: 12Vdc, 1.5A Power Line: DC 1.5m non-shielded without core

1.1.6 Channel List

802.11a / n HT20 / ac VHT20 / ax HE20		802.11n HT40 / ac VHT40 / ax HE40	
Channel	Frequency(MHz)	Channel	Frequency(MHz)
36	5180	38	5190
40	5200	46	5230
44	5220	54	5270
48	5240	62	5310
52	5260	102	5510
56	5280	110	5550
60	5300	118	5590
64	5320	126	5630
100	5500	134	5670
104	5520	142	5710
108	5540	151	5755
112	5560	159	5795
116	5580	802.11ac VHT80 / ax HE80	
120	5600	42	5210
124	5620	58	5290
128	5640	106	5530
132	5660	122	5610
136	5680	138	5690
140	5700	155	5775
144	5720	---	---
149	5745	---	---
153	5765	---	---
157	5785	---	---
161	5805	---	---
165	5825	---	---

1.1.7 Test Tool and Duty Cycle

Test Tool	QSPR, v5.0-00170		
Duty Cycle and Duty Factor	Mode	Duty Cycle (%)	Duty Factor (dB)
	11a	94.90%	0.23
	ax (HE20)	89.69%	0.47
	ax (HE40)	86.44%	0.63
	ax (HE80)	91.63%	0.38

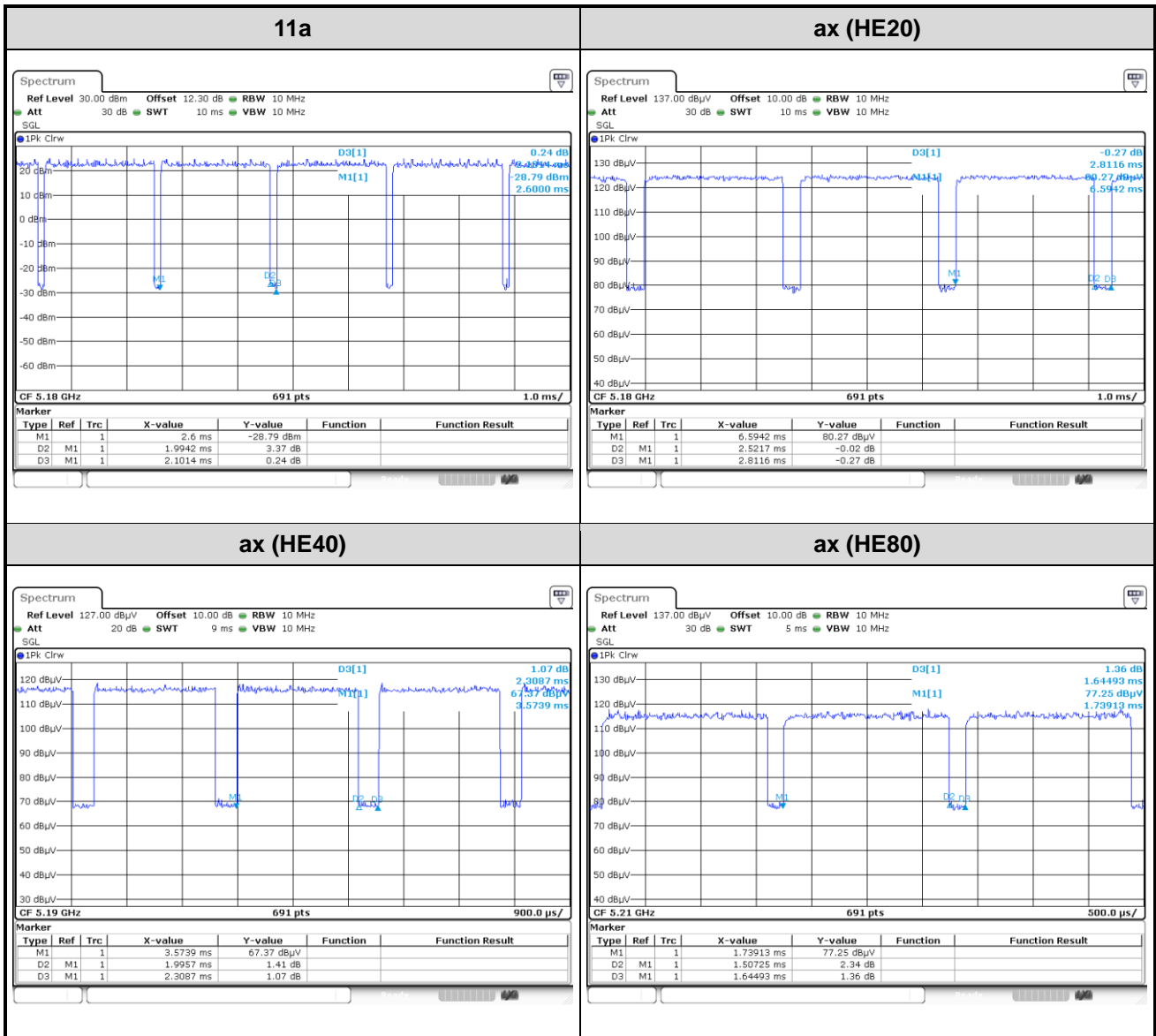

1.1.8 Power Index of Test Tool

For Frequency band 5150-5250 MHz		
Modulation Mode	Test Frequency (MHz)	Power Index
11a	5180	19.5
11a	5200	23
11a	5240	23.5
ax (HE20)	5180	14.5
ax (HE20)	5200	21
ax (HE20)	5240	22
ax (HE40)	5190	14.5
ax (HE40)	5230	21.5
ax (HE80)	5210	13.5

For Frequency band 5250~5350 MHz		
Modulation Mode	Test Frequency (MHz)	Power Index
11a	5260	20
11a	5300	20
11a	5320	20
ax (HE20)	5260	20
ax (HE20)	5300	20
ax (HE20)	5320	16.5
ax (HE40)	5270	21.5
ax (HE40)	5310	15.5
ax (HE80)	5290	15

For Frequency band 5470~5725 MHz		
Modulation Mode	Test Frequency (MHz)	Power Index
11a	5500	19
11a	5580	19
11a	5700	19
ax (HE20)	5500	14.5
ax (HE20)	5580	19
ax (HE20)	5700	14
ax (HE40)	5510	13.5
ax (HE40)	5590	21.5
ax (HE40)	5670	15
ax (HE80)	5530	16
ax (HE80)	5610	19.5

Channel that extends across the 5.725 GHz boundary

For Frequency band 5470~5725 MHz		
Modulation Mode	Test Frequency (MHz)	Power Index
11a	5720MHz	19
ax (HE20)	5720MHz	19
ax (HE40)	5710MHz	21.5
ax (HE80)	5690MHz	21.5

For Frequency band 5725~5850 MHz		
Modulation Mode	Test Frequency (MHz)	Power Index
11a	5745	24
11a	5785	24
11a	5825	24
ax (HE20)	5745	24
ax (HE20)	5785	24
ax (HE20)	5825	24
ax (HE40)	5755	24
ax (HE40)	5795	24
ax (HE80)	5775	21

1.2 Local Support Equipment List

Support Equipment List					
No.	Equipment	Brand	Model	FCC ID	Remarks
1	Notebook	DELL	Latitude E5470	DoC	---
2	POE Switch	ZYXEL	XS1930-12HP	---	Provided by applicant.
3	Ground Cable	ICC	GC-2.3m	---	---
4	RJ45	ICC	RJ45-10m	---	---

1.3 Test Setup Chart

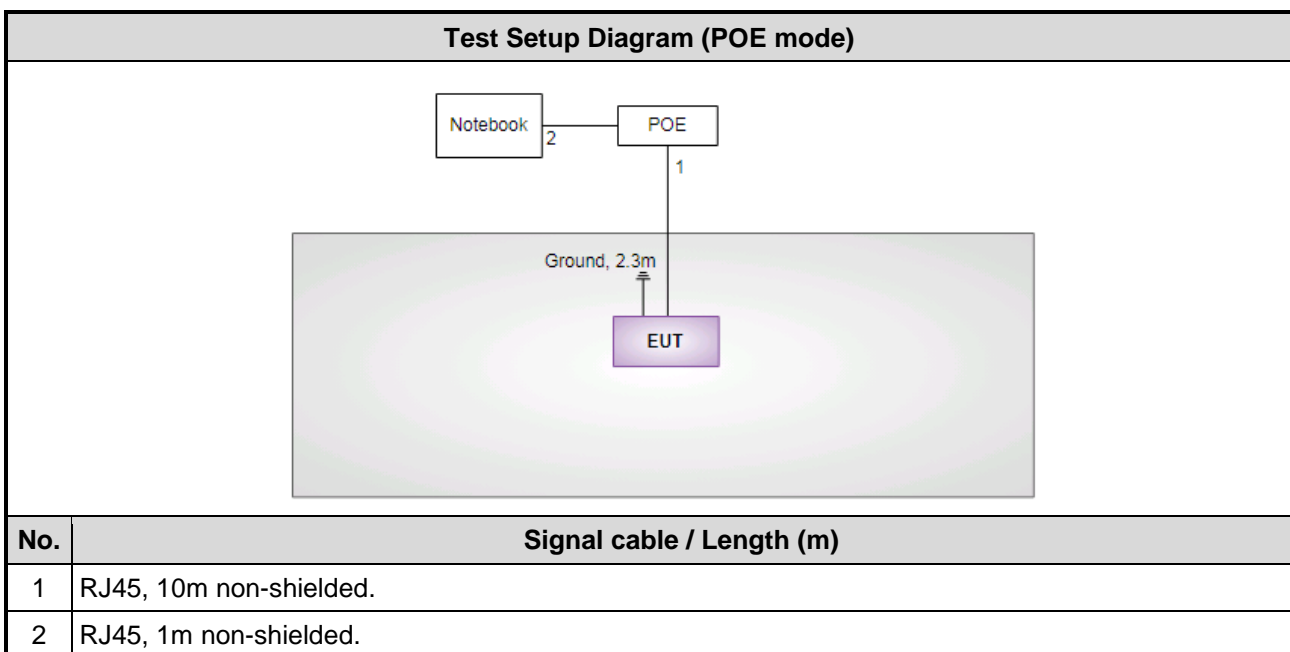
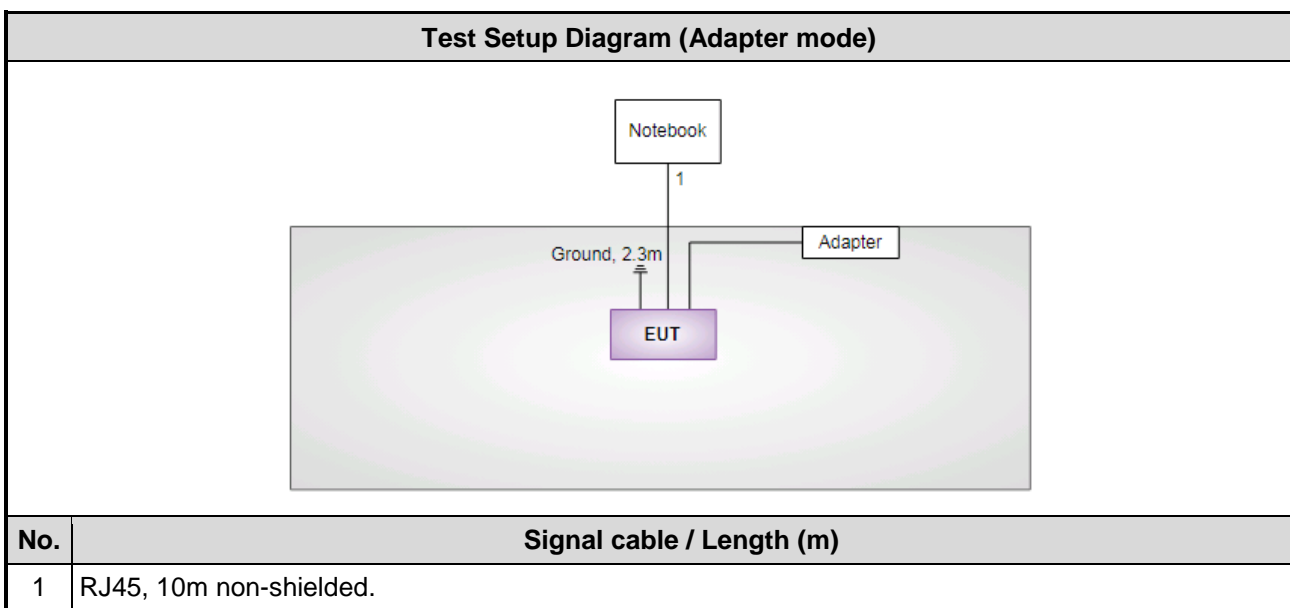

1.4 The Equipment List

Test Item	Conducted Emission				
Test Site	Conduction room 1 / (CO01-WS)				
Tested Date	Jan. 06, 2020				
Instrument	Manufacturer	Model No.	Serial No.	Calibration Date	Calibration Until
Receiver	R&S	ESR3	101657	Jan. 08, 2019	Jan. 07, 2020
LISN	R&S	ENV216	101579	Mar. 08, 2019	Mar. 07, 2020
RF Cable-CON	Woken	CFD200-NL	CFD200-NL-001	Oct. 22, 2019	Oct. 21, 2020
Measurement Software	AUDIX	e3	6.120210k	NA	NA
Note: Calibration Interval of instruments listed above is one year.					

Test Item	Radiated Emission				
Test Site	966 chamber 3 / (03CH03-WS)				
Tested Date	Dec. 23, 2019 ~ Jan. 14, 2020				
Instrument	Manufacturer	Model No.	Serial No.	Calibration Date	Calibration Until
Spectrum Analyzer	R&S	FSV40	101498	Dec. 17, 2019	Dec. 16, 2020
Receiver	R&S	ESR3	101658	Dec. 12, 2019	Dec. 11, 2020
Bilog Antenna	SCHWARZBECK	VULB9168	VULB9168-685	Apr. 17, 2019	Apr. 16, 2020
Horn Antenna 1G-18G	SCHWARZBECK	BBHA 9120 D	BBHA 9120 D 1096	Dec. 12, 2019	Dec. 11, 2020
Horn Antenna 18G-40G	SCHWARZBECK	BBHA 9170	BBHA 9170517	Nov. 15, 2019	Nov. 14, 2020
Loop Antenna	R&S	HFH2-Z2	100330	Nov. 13, 2019	Nov. 12, 2020
Loop Antenna Cable	KOAX KABEL	101354-BW	101354-BW	Oct. 07, 2019	Oct. 06, 2020
Preamplifier	EMC	EMC02325	980187	Aug. 14, 2019	Aug. 13, 2020
Preamplifier	Agilent	83017A	MY53270014	Aug. 07, 2019	Aug. 06, 2020
Preamplifier	EMC	EMC184045B	980192	Aug. 01, 2019	Jul. 31, 2020
RF cable-3M	HUBER+SUHNER	SUCOFLEX104	MY22620/4	Sep. 27, 2019	Sep. 26, 2020
RF cable-8M	EMC	EMC104-SM-SM-8000	181107	Sep. 27, 2019	Sep. 26, 2020
RF cable-1M	HUBER+SUHNER	SUCOFLEX104	MY22624/4	Sep. 27, 2019	Sep. 26, 2020
LF cable-0.8M	EMC	EMC8D-NM-NM-8000	EMC8D-NM-NM-800-001	Sep. 27, 2019	Sep. 26, 2020
LF cable-3M	EMC	EMC8D-NM-NM-3000	131103	Sep. 27, 2019	Sep. 26, 2020
LF cable-13M	EMC	EMC8D-NM-NM-13000	131104	Sep. 27, 2019	Sep. 26, 2020
Measurement Software	AUDIX	e3	6.120210g	NA	NA
Note: Calibration Interval of instruments listed above is one year.					

Test Item	RF Conducted				
Test Site	(TH01-WS)				
Tested Date	Jan. 06, 2020				
Instrument	Manufacturer	Model No.	Serial No.	Calibration Date	Calibration Until
Spectrum Analyzer	R&S	FSV40	101063	Apr. 17, 2019	Apr. 16, 2020
Power Meter	Anritsu	ML2495A	1241002	Oct. 23, 2019	Oct. 22, 2020
Power Sensor	Anritsu	MA2411B	1207366	Oct. 23, 2019	Oct. 22, 2020
AC POWER SOURCE	APC	AFC-500W	F312060012	Dec. 02, 2019	Dec. 01, 2020
Measurement Software	Sporton	SENSE-15247_DTS	V5.9	NA	NA
Note: Calibration Interval of instruments listed above is one year.					

1.5 Testing Applied Standards

According to the specification of EUT, the EUT must comply with following standards and KDB documents.

47 CFR FCC Part 15.407

ANSI C63.10-2013

FCC KDB 789033 D02 General UNII Test Procedures New Rules

FCC KDB 662911 D01 Multiple Transmitter Output v02r01

FCC KDB 412172 D01 Determining ERP and EIRP v01r01

1.6 Deviation from Test Standard and Measurement Procedure

None

1.7 Measurement Uncertainty

ISO/IEC 17025 requires that an estimate of the measurement uncertainties associated with the emissions test results be included in the report. The measurement uncertainties given below are based on a 95% confidence level (based on a coverage factor (k=2))

Measurement Uncertainty	
Parameters	Uncertainty
Bandwidth	±34.130 Hz
Conducted power	±0.808 dB
Frequency error	±1×10 ⁻⁹
Power density	±0.583 dB
Conducted emission	±2.715 dB
AC conducted emission	±2.92 dB
Radiated emission ≤ 1GHz	±3.96 dB
Radiated emission > 1GHz	±4.51 dB
Time	±0.1%
Temperature	±0.4 °C

2 Test Configuration

2.1 Testing Condition

Test Item	Test Site	Ambient Condition	Tested By
AC Conduction	CO01-WS	23°C / 69%	Akun Chung
Radiated Emissions	03CH03-WS	21-22°C / 66-67%	Roger Lu Akun Chung
RF Conducted	TH01-WS	22°C / 63%	Brad Wu

- FCC Designation No.: TW0009
- FCC site registration No.: 207696
- ISED#: 10807A
- CAB identifier: TW2732

2.2 The Worst Test Modes and Channel Details

Frequency band 5150~5250 MHz / 5250~5350 MHz / 5470~5725 MHz					
Test item	Modulation Mode	Test Frequency (MHz)	Data Rate (Mbps) / MCS	Mode	Test Configuration
Conducted Emissions	11a	5240	6 Mbps	TX	1, 2
Radiated Emissions ≤1GHz	11a	5240	6 Mbps	TX	1, 2
RF Output Power	11a	5180 / 5200 / 5240 / 5260 / 5300 / 5320 / 5500 / 5580 / 5700 / 5720	6 Mbps	TX	1
	ax (HE20)	5180 / 5200 / 5240 / 5260 / 5300 / 5320 / 5500 / 5580 / 5700 / 5720	MCS 0	TX	
	ax (HE40)	5190 / 5230 / 5270 / 5310 / 5510 / 5590 / 5670 / 5710	MCS 0	TX	
	ax (HE80)	5210 / 5290 / 5530 / 5610 / 5690	MCS 0	TX	
RF Output Power	ax (HE20)	5180 / 5200 / 5240 / 5260 / 5300 / 5320 / 5500 / 5580 / 5700 / 5720	MCS 0	TX	3
	ax (HE40)	5190 / 5230 / 5270 / 5310 / 5510 / 5590 / 5670 / 5710	MCS 0	TX	
	ax (HE80)	5210 / 5290 / 5530 / 5610 / 5690	MCS 0	TX	
Radiated Emissions >1GHz Emission Bandwidth Peak Power Spectral Density	11a	5180 / 5200 / 5240 / 5260 / 5300 / 5320 / 5500 / 5580 / 5700 / 5720	6 Mbps	TX	1
	ax (HE20)	5180 / 5200 / 5240 / 5260 / 5300 / 5320 / 5500 / 5580 / 5700 / 5720	MCS 0	TX	
	ax (HE40)	5190 / 5230 / 5270 / 5310 / 5510 / 5590 / 5670 / 5710	MCS 0	TX	
	ax (HE80)	5210 / 5290 / 5530 / 5610 / 5690	MCS 0	TX	
Frequency Stability	Un-modulation	5320	---	TX	1
NOTE:					
1. The EUT was pretested with 3 orientations placed on the table for the radiated emission measurement – X, Y, and Z-plane. The Z-plane results were found as the worst case and were shown in this report.					
2. The EUT had been tested by following test configurations.					
1) Configuration 1: Adapter mode, Non-Beamforming					
2) Configuration 2: POE mode, Non-Beamforming					
3) Configuration 3: Adapter mode, Beamforming					

Frequency band 5725-5850 MHz					
Test item	Modulation Mode	Test Frequency (MHz)	Data Rate (Mbps) / MCS	Mode	Test Configuration
Conducted Emissions	ax (HE40)	5795	MCS 0	TX	1, 2
Radiated Emissions ≤1GHz	ax (HE40)	5795	MCS 0	TX	1, 2
RF Output Power	11a	5745 / 5785 / 5825	6 Mbps	TX	1
	ax (HE20)	5745 / 5785 / 5825	MCS 0		
	ax (HE40)	5755 / 5795	MCS 0		
	ax (HE80)	5775	MCS 0		
RF Output Power	ax (HE20)	5745 / 5785 / 5825	MCS 0	TX	3
	ax (HE40)	5755 / 5795	MCS 0		
	ax (HE80)	5775	MCS 0		
Radiated Emissions >1GHz Emission Bandwidth 6dB bandwidth Peak Power Spectral Density	11a	5745 / 5785 / 5825	6 Mbps	TX	1
	ax (HE20)	5745 / 5785 / 5825	MCS 0		
	ax (HE40)	5755 / 5795	MCS 0		
	ax (HE80)	5775	MCS 0		
Frequency Stability	Un-modulation	5785	---	TX	1

NOTE:

- The EUT was pretested with 3 orientations placed on the table for the radiated emission measurement – X, Y, and Z-plane. The **Z-plane** results were found as the worst case and were shown in this report.
- The EUT had been tested by following test configurations.
 - Configuration 1: Adapter mode, Non-Beamforming
 - Configuration 2: POE mode, Non-Beamforming
 - Configuration 3: Adapter mode, Beamforming

3 Transmitter Test Results

3.1 Conducted Emissions

3.1.1 Limit of Conducted Emissions

Conducted Emissions Limit		
Frequency Emission (MHz)	Quasi-Peak	Average
0.15-0.5	66 - 56 *	56 - 46 *
0.5-5	56	46
5-30	60	50

Note 1: * Decreases with the logarithm of the frequency.

3.1.2 Test Procedures

1. The device is placed on a test table, raised 80 cm above the reference ground plane. The vertical conducting plane is located 40 cm to the rear of the device.
2. The device is connected to line impedance stabilization network (LISN) and other accessories are connected to other LISN. Measured levels of AC power line conducted emission are across the 50 Ω LISN port.
3. AC conducted emission measurements is made over frequency range from 150 kHz to 30 MHz.
4. This measurement was performed with AC 120V/60Hz

3.1.3 Test Setup



- Note: 1. Support units were connected to second LISN.
2. Both of LISNs (AMN) are 80 cm from EUT and at least 80 cm from other units and other metal planes

3.1.4 Test Result of Conducted Emissions

Modulation	11a	Test Freq. (MHz)	5240
Power Phase	Line	Test Configuration	1

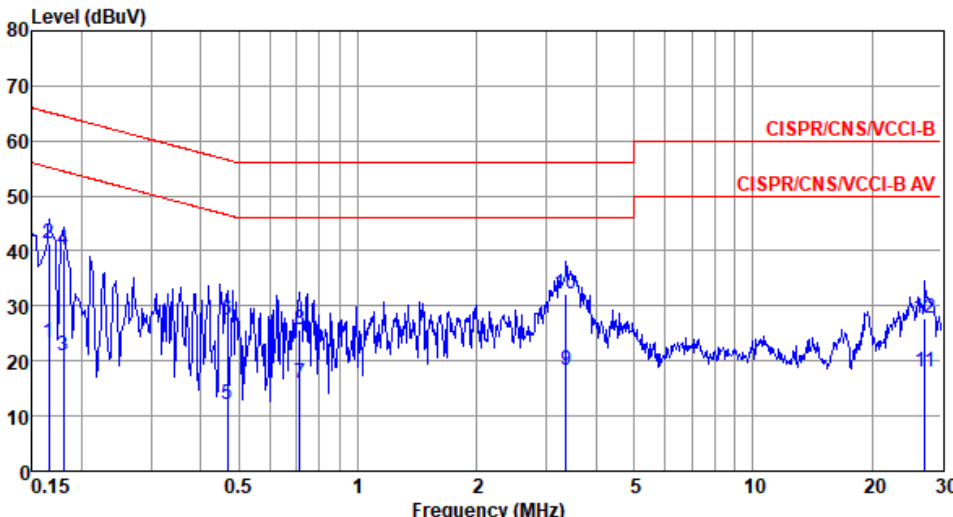

	Freq MHz	Level dBuV	Limit Line dBuV	Over Limit dB	Read Level dBuV	LISN factor dB	cable loss dB	Remark
1	0.165	23.24	55.21	-31.97	13.49	9.53	0.05	Average
2	0.165	41.19	65.21	-24.02	31.44	9.53	0.05	QP
3	0.180	20.97	54.50	-33.53	11.19	9.54	0.06	Average
4	0.180	40.29	64.50	-24.21	30.51	9.54	0.06	QP
5	0.469	12.09	46.54	-34.45	2.16	9.58	0.09	Average
6	0.469	27.59	56.54	-28.95	17.66	9.58	0.09	QP
7	0.712	16.04	46.00	-29.96	6.05	9.59	0.11	Average
8	0.712	25.78	56.00	-30.22	15.79	9.59	0.11	QP
9	3.364	18.28	46.00	-27.72	8.05	9.61	0.26	Average
10*	3.364	32.07	56.00	-23.93	21.84	9.61	0.26	QP
11	27.271	17.95	50.00	-32.05	6.80	9.63	0.74	Average
12	27.271	27.61	60.00	-32.39	16.46	9.63	0.74	QP

Note 1: Level (dBuV) = Read Level (dBuV) + LISN Factor (dB) + Cable Loss (dB).
 Note 2: Over Limit (dB) = Level (dBuV) – Limit Line (dBuV).

Modulation	11a	Test Freq. (MHz)	5240
Power Phase	Neutral	Test Configuration	1

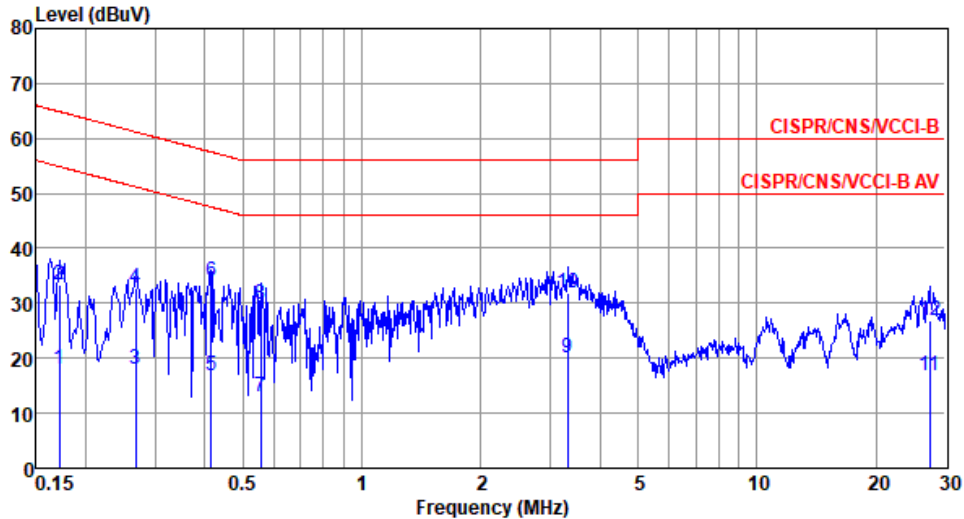

	Freq MHz	Level dBuV	Limit Line dBuV	Over Limit dB	Read Level dBuV	LISN factor dB	cable loss dB	Remark
1	0.171	17.86	54.90	-37.04	8.11	9.57	0.05	Average
2	0.171	33.37	64.90	-31.53	23.62	9.57	0.05	QP
3	0.267	17.91	51.20	-33.29	8.09	9.59	0.07	Average
4	0.267	32.66	61.20	-28.54	22.84	9.59	0.07	QP
5	0.415	16.86	47.55	-30.69	7.00	9.61	0.08	Average
6*	0.415	33.89	57.55	-23.66	24.03	9.61	0.08	QP
7	0.555	13.01	46.00	-32.99	3.12	9.62	0.09	Average
8	0.555	29.92	56.00	-26.08	20.03	9.62	0.09	QP
9	3.310	19.98	46.00	-26.02	9.80	9.66	0.26	Average
10	3.310	31.82	56.00	-24.18	21.64	9.66	0.26	QP
11	27.416	16.72	50.00	-33.28	5.43	9.82	0.75	Average
12	27.416	26.78	60.00	-33.22	15.49	9.82	0.75	QP

Note 1: Level (dBuV) = Read Level (dBuV) + LISN Factor (dB) + Cable Loss (dB).
 2: Over Limit (dB) = Level (dBuV) – Limit Line (dBuV).

Modulation	ax (HE40)	Test Freq. (MHz)	5795
Power Phase	Line	Test Configuration	1

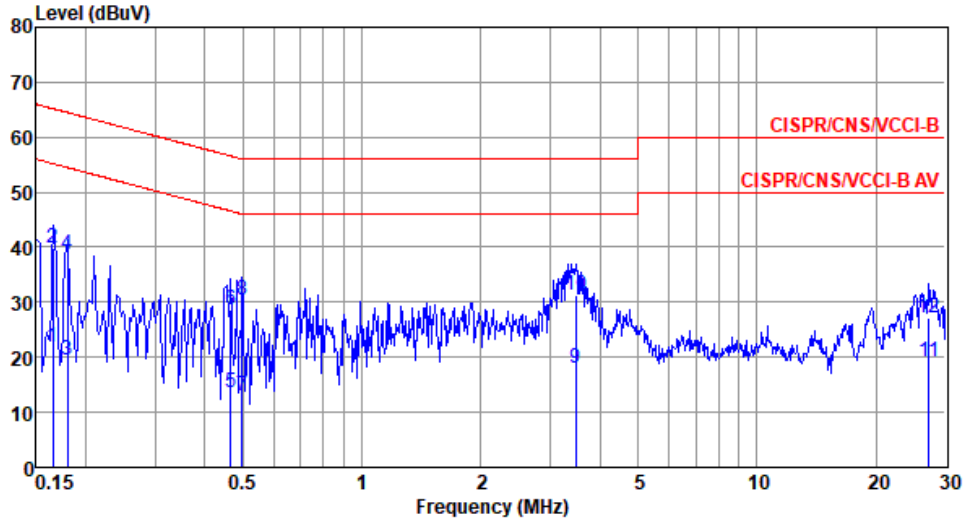

	Freq MHz	Level dBuV	Limit Line dBuV	Over Limit dB	Read Level dBuV	LISN factor dB	cable loss dB	Remark
1	0.165	21.98	55.21	-33.23	12.23	9.53	0.05	Average
2	0.165	39.79	65.21	-25.42	30.04	9.53	0.05	QP
3	0.180	19.55	54.50	-34.95	9.77	9.54	0.06	Average
4	0.180	38.79	64.50	-25.71	29.01	9.54	0.06	QP
5	0.466	13.61	46.58	-32.97	3.68	9.58	0.09	Average
6	0.466	28.73	56.58	-27.85	18.80	9.58	0.09	QP
7	0.497	12.86	46.05	-33.19	2.92	9.58	0.09	Average
8	0.497	30.37	56.05	-25.68	20.43	9.58	0.09	QP
9	3.472	17.89	46.00	-28.11	7.65	9.61	0.27	Average
10*	3.472	31.33	56.00	-24.67	21.09	9.61	0.27	QP
11	27.271	19.19	50.00	-30.81	8.04	9.63	0.74	Average
12	27.271	27.05	60.00	-32.95	15.90	9.63	0.74	QP

Note 1: Level (dBUV) = Read Level (dBUV) + LISN Factor (dB) + Cable Loss (dB).
 2: Over Limit (dB) = Level (dBUV) – Limit Line (dBUV).

Modulation	ax (HE40)	Test Freq. (MHz)	5795
Power Phase	Neutral	Test Configuration	1

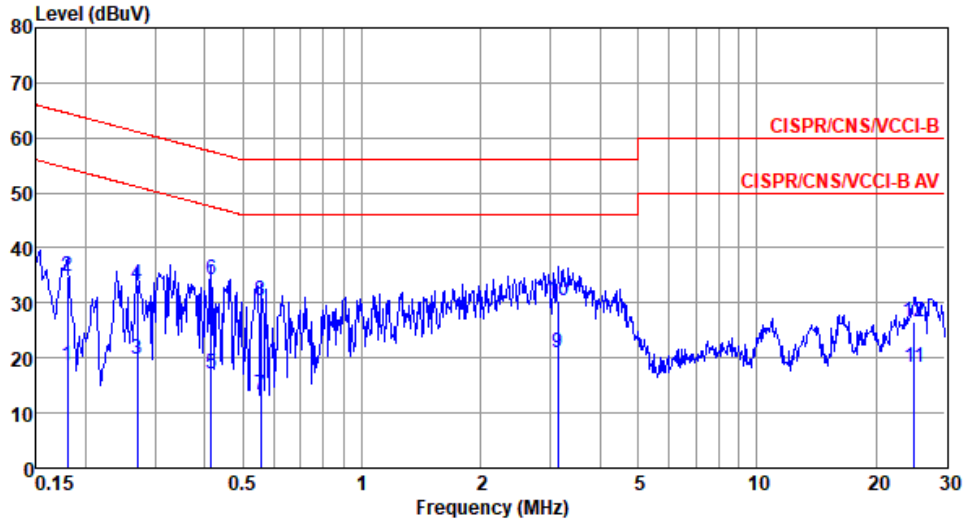

	Freq MHz	Level dBuV	Limit Line dBuV	Over Limit dB	Read Level dBuV	LISN factor dB	cable loss dB	Remark
1	0.180	18.55	54.50	-35.95	8.77	9.58	0.06	Average
2	0.180	34.78	64.50	-29.72	25.00	9.58	0.06	QP
3	0.270	19.67	51.12	-31.45	9.85	9.59	0.07	Average
4	0.270	33.43	61.12	-27.69	23.61	9.59	0.07	QP
5	0.415	16.98	47.55	-30.57	7.12	9.61	0.08	Average
6*	0.415	34.38	57.55	-23.17	24.52	9.61	0.08	QP
7	0.555	13.43	46.00	-32.57	3.54	9.62	0.09	Average
8	0.555	30.37	56.00	-25.63	20.48	9.62	0.09	QP
9	3.140	20.95	46.00	-25.05	10.78	9.66	0.25	Average
10	3.140	30.45	56.00	-25.55	20.28	9.66	0.25	QP
11	25.055	18.43	50.00	-31.57	7.22	9.82	0.71	Average
12	25.055	26.56	60.00	-33.44	15.35	9.82	0.71	QP

Note 1: Level (dBuV) = Read Level (dBuV) + LISN Factor (dB) + Cable Loss (dB).
 2: Over Limit (dB) = Level (dBuV) – Limit Line (dBuV).

Modulation	11a	Test Freq. (MHz)	5240
Power Phase	Line	Test Configuration	2

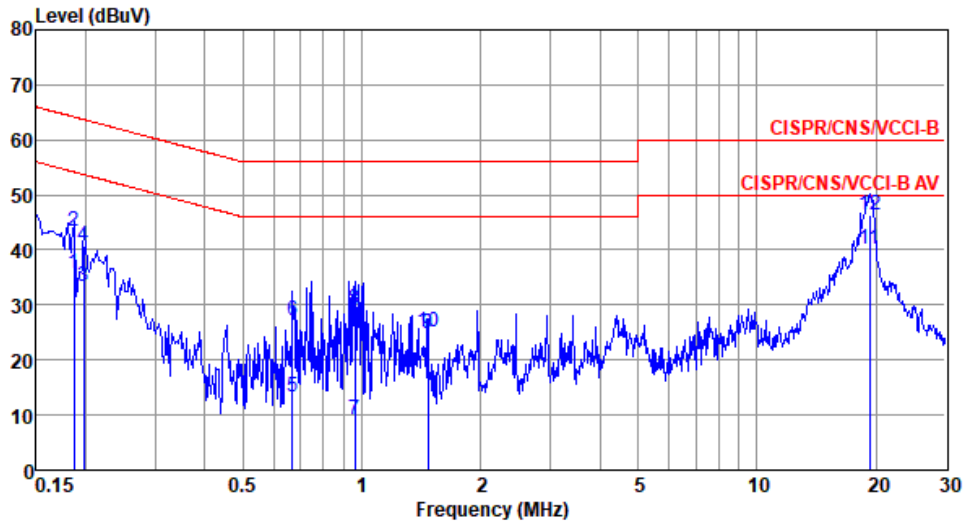

	Freq MHz	Level dBuV	Limit Line dBuV	Over Limit dB	Read Level dBuV	LISN factor dB	cable loss dB	Remark
1	0.186	35.62	54.20	-18.58	26.02	9.54	0.06	Average
2	0.186	43.37	64.20	-20.83	33.77	9.54	0.06	QP
3	0.198	33.44	53.71	-20.27	23.84	9.54	0.06	Average
4	0.198	40.78	63.71	-22.93	31.18	9.54	0.06	QP
5	0.668	13.22	46.00	-32.78	3.53	9.59	0.10	Average
6	0.668	27.30	56.00	-28.70	17.61	9.59	0.10	QP
7	0.958	9.25	46.00	-36.75	-0.47	9.60	0.12	Average
8	0.958	29.16	56.00	-26.84	19.44	9.60	0.12	QP
9	1.472	24.87	46.00	-21.13	15.12	9.60	0.15	Average
10	1.472	25.20	56.00	-30.80	15.45	9.60	0.15	QP
11*	19.326	40.29	50.00	-9.71	29.98	9.66	0.65	Average
12	19.326	46.27	60.00	-13.73	35.96	9.66	0.65	QP

Note 1: Level (dBuV) = Read Level (dBuV) + LISN Factor (dB) + Cable Loss (dB).
 2: Over Limit (dB) = Level (dBuV) – Limit Line (dBuV).

Modulation	11a	Test Freq. (MHz)	5240
Power Phase	Neutral	Test Configuration	2

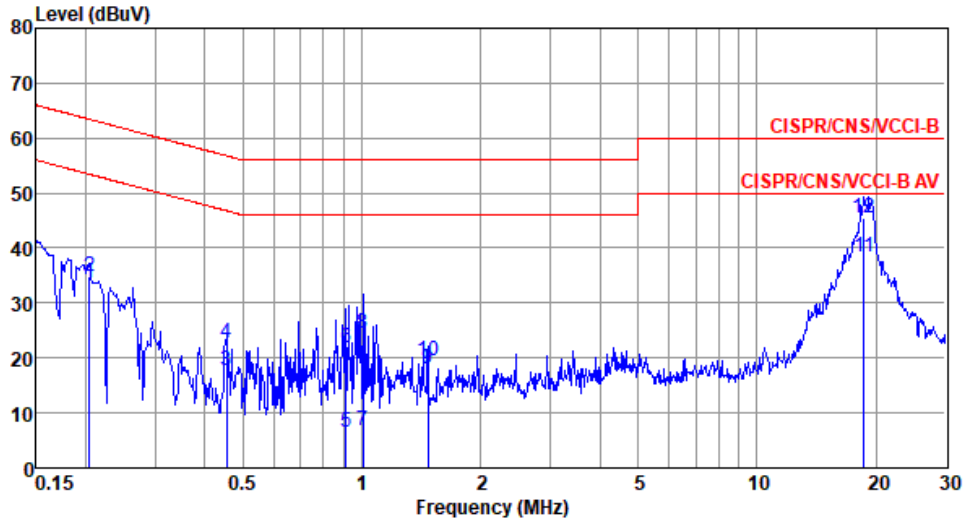

	Freq MHz	Level dBuV	Limit Line dBuV	Over Limit dB	Read Level dBuV	LISN factor dB	cable loss dB	Remark
1	0.204	33.66	53.45	-19.79	24.02	9.58	0.06	Average
2	0.204	34.97	63.45	-28.48	25.33	9.58	0.06	QP
3	0.454	17.70	46.80	-29.10	8.00	9.61	0.09	Average
4	0.454	22.72	56.80	-34.08	13.02	9.61	0.09	QP
5	0.914	6.52	46.00	-39.48	-3.24	9.64	0.12	Average
6	0.914	21.81	56.00	-34.19	12.05	9.64	0.12	QP
7	1.005	6.67	46.00	-39.33	-3.09	9.64	0.12	Average
8	1.005	24.54	56.00	-31.46	14.78	9.64	0.12	QP
9	1.472	17.92	46.00	-28.08	8.12	9.65	0.15	Average
10	1.472	19.50	56.00	-36.50	9.70	9.65	0.15	QP
11*	18.622	38.45	50.00	-11.55	28.01	9.80	0.64	Average
12	18.622	45.45	60.00	-14.55	35.01	9.80	0.64	QP

Note 1: Level (dBuV) = Read Level (dBuV) + LISN Factor (dB) + Cable Loss (dB).
 2: Over Limit (dB) = Level (dBuV) – Limit Line (dBuV).

Modulation	ax (HE40)	Test Freq. (MHz)	5795
Power Phase	Line	Test Configuration	2

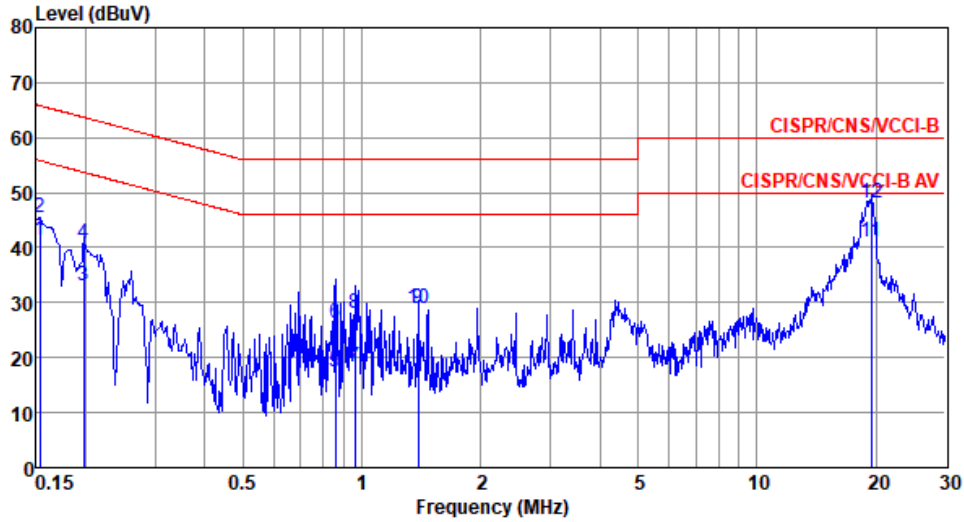

	Freq MHz	Level dBuV	Limit Line dBuV	Over Limit dB	Read Level dBuV	LISN factor dB	cable loss dB	Remark
1	0.153	41.21	55.82	-14.61	31.63	9.53	0.05	Average
2	0.153	45.48	65.82	-20.34	35.90	9.53	0.05	QP
3	0.198	33.05	53.71	-20.66	23.45	9.54	0.06	Average
4	0.198	40.84	63.71	-22.87	31.24	9.54	0.06	QP
5	0.857	17.33	46.00	-28.67	7.63	9.59	0.11	Average
6	0.857	26.32	56.00	-29.68	16.62	9.59	0.11	QP
7	0.958	18.43	46.00	-27.57	8.71	9.60	0.12	Average
8	0.958	27.98	56.00	-28.02	18.26	9.60	0.12	QP
9	1.388	28.80	46.00	-17.20	19.05	9.60	0.15	Average
10	1.388	29.06	56.00	-26.94	19.31	9.60	0.15	QP
11*	19.428	41.17	50.00	-8.83	30.86	9.66	0.65	Average
12	19.428	48.13	60.00	-11.87	37.82	9.66	0.65	QP

Note 1: Level (dBuV) = Read Level (dBuV) + LISN Factor (dB) + Cable Loss (dB).
 2: Over Limit (dB) = Level (dBuV) – Limit Line (dBuV).

Modulation	ax (HE40)	Test Freq. (MHz)	5795
Power Phase	Neutral	Test Configuration	2

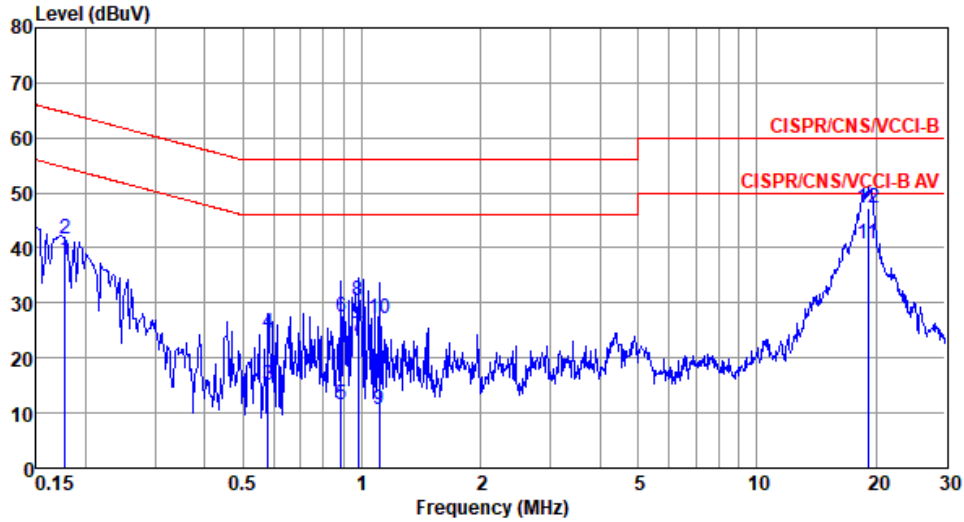

	Freq MHz	Level dBuV	Limit Line dBuV	Over Limit dB	Read Level dBuV	LISN factor dB	cable loss dB	Remark
1	0.178	37.77	54.59	-16.82	28.13	9.58	0.06	Average
2	0.178	41.68	64.59	-22.91	32.04	9.58	0.06	QP
3	0.579	15.18	46.00	-30.82	5.46	9.62	0.10	Average
4	0.579	24.57	56.00	-31.43	14.85	9.62	0.10	QP
5	0.885	11.50	46.00	-34.50	1.75	9.64	0.11	Average
6	0.885	27.58	56.00	-28.42	17.83	9.64	0.11	QP
7	0.979	23.78	46.00	-22.22	14.02	9.64	0.12	Average
8	0.979	30.33	56.00	-25.67	20.57	9.64	0.12	QP
9	1.106	10.51	46.00	-35.49	0.74	9.64	0.13	Average
10	1.106	27.07	56.00	-28.93	17.30	9.64	0.13	QP
11*	19.122	40.61	50.00	-9.39	30.16	9.80	0.65	Average
12	19.122	47.34	60.00	-12.66	36.89	9.80	0.65	QP

Note 1: Level (dBuV) = Read Level (dBuV) + LISN Factor (dB) + Cable Loss (dB).
 2: Over Limit (dB) = Level (dBuV) – Limit Line (dBuV).

3.2 Emission Bandwidth

3.2.1 Limit of Emission Bandwidth

Within the 5.725-5.85 GHz band, the minimum 6 dB bandwidth of U-NII devices shall be at least 500 kHz.

3.2.2 Test Procedures

26dB Bandwidth

1. Set RBW = approximately 1% of the emission bandwidth.
2. Set the VBW > RBW, Detector = Peak.
3. Trace mode = max hold.
4. Measure the maximum width of the emission that is 26 dB down from the peak of the emission.

Occupied Bandwidth

1. Set RBW = 1 % to 5 % of the OBW.
2. Set VBW \geq 3 RBW.
3. Sample detection and single sweep mode shall be used.
4. Use the 99 % power bandwidth function of the instrument.

6dB Bandwidth

1. Set RBW = 100kHz, VBW = 300kHz.
2. Detector = Peak, Trace mode = max hold.
3. Allow the trace to stabilize.
4. Measure the maximum width of the emission that is constrained by the frequencies associated with the two outermost amplitude points (upper and lower frequencies) that are attenuated by 6 dB relative to the maximum level measured in the fundamental emission.

3.2.3 Test Setup

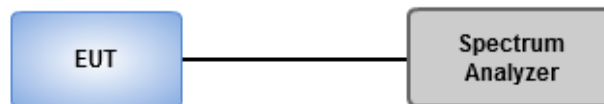

3.2.4 Test Result of Emission Bandwidth

Summary

Mode	Max-N dB (Hz)	Max-OBW (Hz)	ITU-Code	Min-N dB (Hz)	Min-OBW (Hz)
5.15-5.25GHz	-	-	-	-	-
802.11a_Nss1,(6Mbps)_2TX	23.696M	16.498M	16M5D1D	19.13M	16.353M
802.11ax HEW20_Nss1,(MCS0)_2TX	40.145M	18.958M	19M0D1D	22.174M	18.886M
802.11ax HEW40_Nss1,(MCS0)_2TX	73.333M	37.916M	37M9D1D	43.623M	37.916M
802.11ax HEW80_Nss1,(MCS0)_2TX	82.319M	76.99M	77M0D1D	81.739M	76.99M
5.25-5.35GHz	-	-	-	-	-
802.11a_Nss1,(6Mbps)_2TX	19.348M	16.425M	16M4D1D	18.841M	16.353M
802.11ax HEW20_Nss1,(MCS0)_2TX	28.116M	18.958M	19M0D1D	22.681M	18.813M
802.11ax HEW40_Nss1,(MCS0)_2TX	73.043M	37.916M	37M9D1D	44.928M	37.771M
802.11ax HEW80_Nss1,(MCS0)_2TX	82.319M	76.99M	77M0D1D	82.319M	76.99M
5.47-5.725GHz	-	-	-	-	-
802.11a_Nss1,(6Mbps)_2TX	19.348M	16.425M	16M4D1D	14.348M	13.155M
802.11ax HEW20_Nss1,(MCS0)_2TX	27.754M	18.958M	19M0D1D	16.87M	14.414M
802.11ax HEW40_Nss1,(MCS0)_2TX	76.232M	37.916M	37M9D1D	37.029M	33.734M
802.11ax HEW80_Nss1,(MCS0)_2TX	82.319M	77.279M	77M3D1D	75.217M	73.155M
5.725-5.85GHz	-	-	-	-	-
802.11a_Nss1,(6Mbps)_2TX	16.377M	16.932M	16M9D1D	3.13M	3.415M
802.11ax HEW20_Nss1,(MCS0)_2TX	18.913M	22.576M	22M6D1D	4.406M	4.457M
802.11ax HEW40_Nss1,(MCS0)_2TX	37.971M	43.994M	44M0D1D	4M	4.226M
802.11ax HEW80_Nss1,(MCS0)_2TX	77.101M	77.569M	77M6D1D	4M	4.631M

Max-N dB = Maximum 6dB down bandwidth for 5.725-5.85GHz band / Maximum 26dB down bandwidth for other band;

Max-OBW = Maximum 99% occupied bandwidth;

Min-N dB = Minimum 6dB down bandwidth for 5.725-5.85GHz band / Maximum 26dB down bandwidth for other band;

Min-OBW = Minimum 99% occupied bandwidth;

Result

Mode	Result	Limit (Hz)	Port 1- N dB (Hz)	Port 1- OBW (Hz)	Port 2- N dB (Hz)	Port 2- OBW (Hz)
802.11a_Nss1,(6Mbps)_2TX	-	-	-	-	-	-
5180MHz	Pass	Inf	19.203M	16.353M	19.203M	16.353M
5200MHz	Pass	Inf	19.13M	16.353M	19.783M	16.353M
5240MHz	Pass	Inf	19.203M	16.425M	23.696M	16.498M
5260MHz	Pass	Inf	18.986M	16.425M	19.058M	16.353M
5300MHz	Pass	Inf	18.986M	16.353M	19.348M	16.353M
5320MHz	Pass	Inf	18.841M	16.353M	19.275M	16.353M
5500MHz	Pass	Inf	18.841M	16.353M	18.768M	16.353M
5580MHz	Pass	Inf	18.913M	16.353M	19.203M	16.425M
5700MHz	Pass	Inf	19.13M	16.353M	19.348M	16.353M
5720MHz Straddle 5.47-5.725GHz	Pass	Inf	14.609M	13.155M	14.348M	13.198M
5720MHz Straddle 5.725-5.85GHz	Pass	500k	3.13M	3.415M	3.13M	3.415M
5745MHz	Pass	500k	16.304M	16.425M	15.942M	16.932M
5785MHz	Pass	500k	16.304M	16.425M	15.435M	16.932M
5825MHz	Pass	500k	16.377M	16.425M	16.014M	16.715M
802.11ax HEW20_Nss1,(MCS0)_2TX	-	-	-	-	-	-
5180MHz	Pass	Inf	22.174M	18.958M	22.826M	18.886M
5200MHz	Pass	Inf	22.536M	18.886M	25.58M	18.886M
5240MHz	Pass	Inf	24.638M	18.958M	40.145M	18.958M
5260MHz	Pass	Inf	22.681M	18.886M	27.464M	18.958M
5300MHz	Pass	Inf	22.754M	18.886M	28.116M	18.958M
5320MHz	Pass	Inf	22.754M	18.813M	23.043M	18.958M
5500MHz	Pass	Inf	22.899M	18.813M	22.319M	18.886M
5580MHz	Pass	Inf	22.681M	18.958M	27.754M	18.886M
5700MHz	Pass	Inf	22.609M	18.886M	21.812M	18.958M
5720MHz Straddle 5.47-5.725GHz	Pass	Inf	16.87M	14.414M	19.217M	14.501M
5720MHz Straddle 5.725-5.85GHz	Pass	500k	4.406M	4.457M	4.406M	4.573M
5745MHz	Pass	500k	18.913M	18.958M	18.551M	22.431M
5785MHz	Pass	500k	18.913M	18.958M	18.841M	22.576M
5825MHz	Pass	500k	18.913M	19.03M	18.478M	21.056M
802.11ax HEW40_Nss1,(MCS0)_2TX	-	-	-	-	-	-
5190MHz	Pass	Inf	44.638M	37.916M	43.623M	37.916M
5230MHz	Pass	Inf	46.522M	37.916M	73.333M	37.916M
5270MHz	Pass	Inf	47.971M	37.916M	73.043M	37.916M
5310MHz	Pass	Inf	44.928M	37.771M	45.362M	37.916M
5510MHz	Pass	Inf	43.333M	37.916M	44.058M	37.627M
5590MHz	Pass	Inf	44.348M	37.916M	76.232M	37.916M

Mode	Result	Limit (Hz)	Port 1- N dB (Hz)	Port 1- OBW (Hz)	Port 2- N dB (Hz)	Port 2- OBW (Hz)
5670MHz	Pass	Inf	43.768M	37.916M	44.058M	37.771M
5710MHz Straddle 5.47-5.725GHz	Pass	Inf	37.029M	33.734M	54.478M	34.038M
5710MHz Straddle 5.725-5.85GHz	Pass	500k	4M	4.226M	4M	8.973M
5755MHz	Pass	500k	37.971M	37.916M	37.826M	38.495M
5795MHz	Pass	500k	37.971M	37.916M	37.826M	43.994M
802.11ax HEW80_Nss1,(MCS0)_2TX	-	-	-	-	-	-
5210MHz	Pass	Inf	82.319M	76.99M	81.739M	76.99M
5290MHz	Pass	Inf	82.319M	76.99M	82.319M	76.99M
5530MHz	Pass	Inf	82.029M	76.99M	82.319M	76.99M
5610MHz	Pass	Inf	82.319M	76.99M	82.029M	77.279M
5690MHz Straddle 5.47-5.725GHz	Pass	Inf	75.217M	73.155M	75.87M	73.372M
5690MHz Straddle 5.725-5.85GHz	Pass	500k	4.116M	4.631M	4M	10.709M
5775MHz	Pass	500k	77.101M	76.99M	75.072M	77.569M

Port X-N dB = Port X 6dB down bandwidth for 5.725-5.85GHz band / 26dB down bandwidth for other band

Port X-OBW = Port X 99% occupied bandwidth;

802.11a_Nss1,(6Mbps)_2TX

EBW

5180MHz

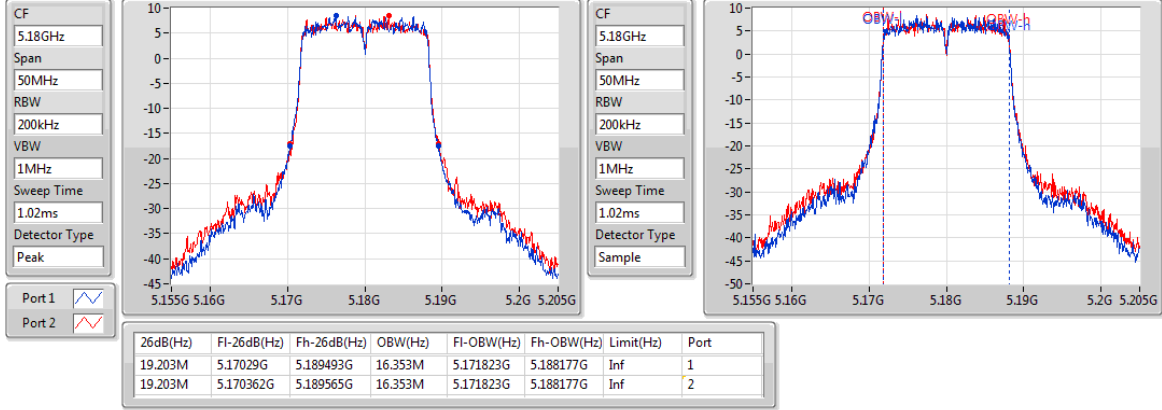

802.11a_Nss1,(6Mbps)_2TX

EBW

5200MHz

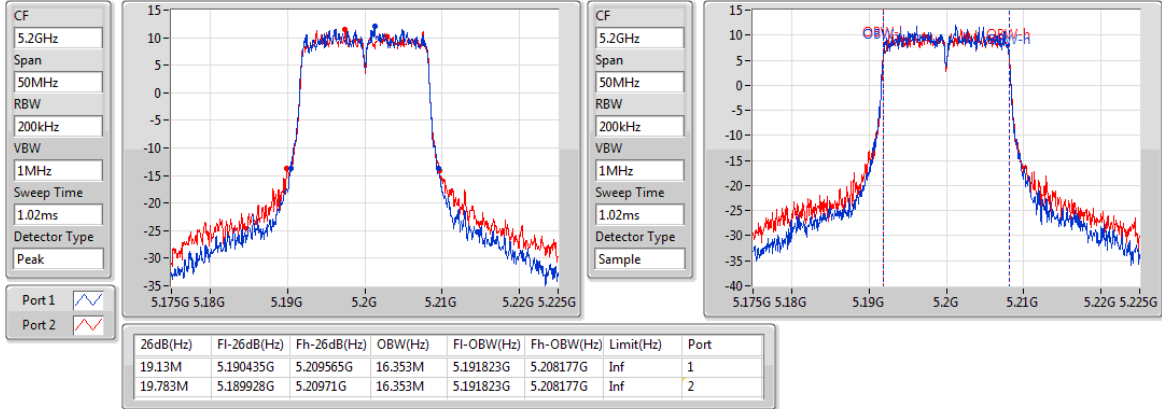

802.11a_Nss1,(6Mbps)_2TX

EBW

5240MHz

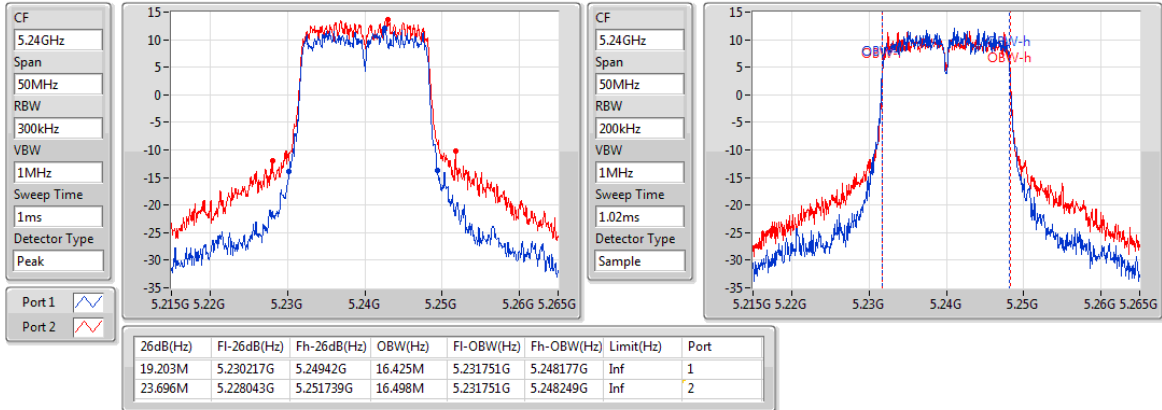

802.11a_Nss1,(6Mbps)_2TX

EBW

5260MHz

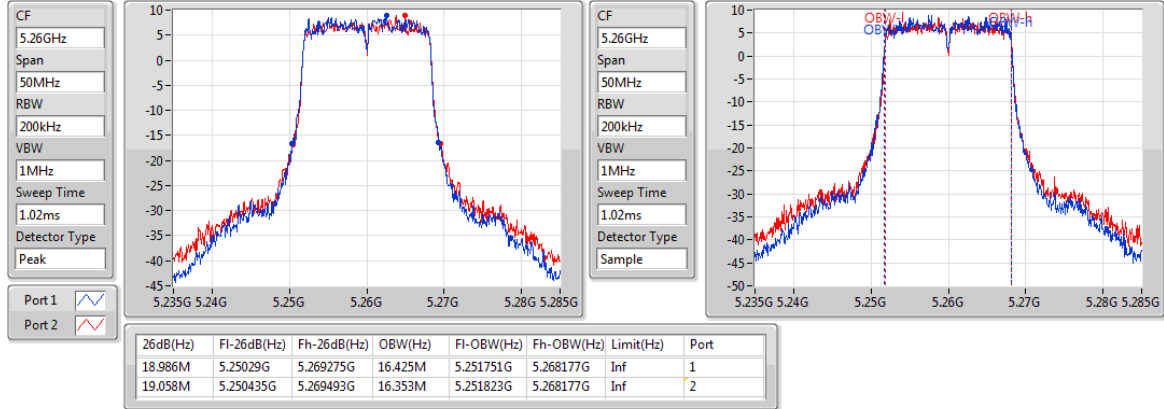

802.11a_Nss1,(6Mbps)_2TX

EBW

5300MHz

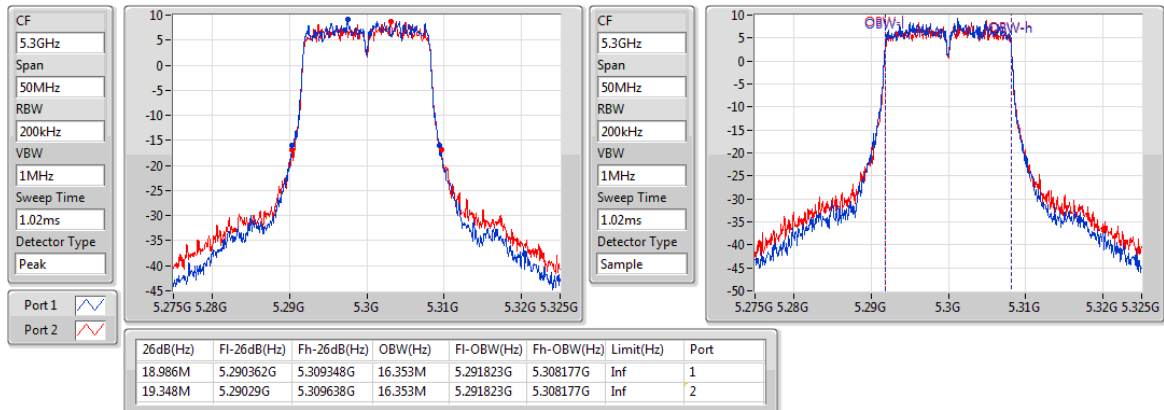

802.11a_Nss1,(6Mbps)_2TX

EBW

5320MHz

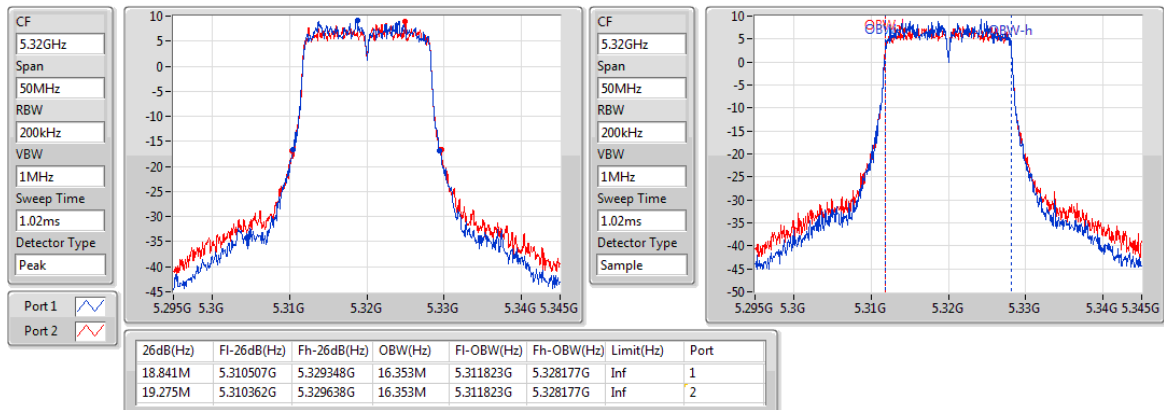

802.11a_Nss1,(6Mbps)_2TX

EBW

5500MHz

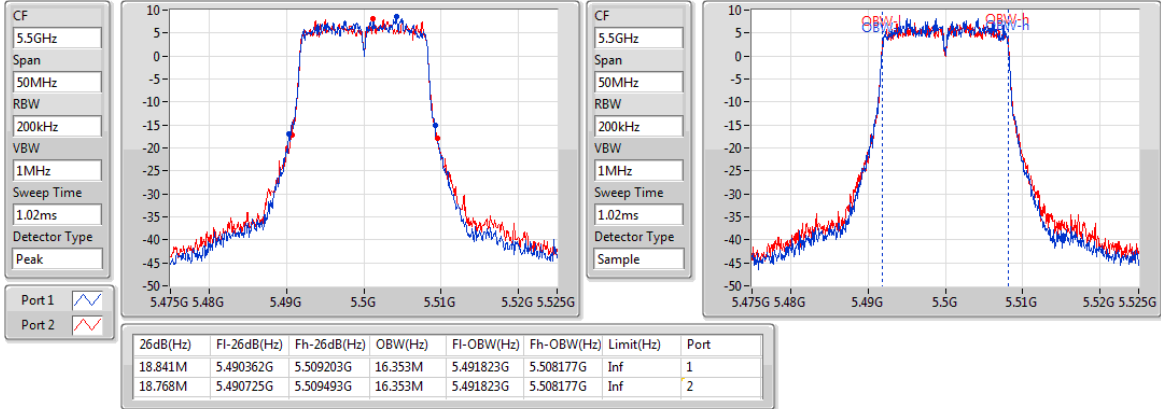

802.11a_Nss1,(6Mbps)_2TX

EBW

5580MHz

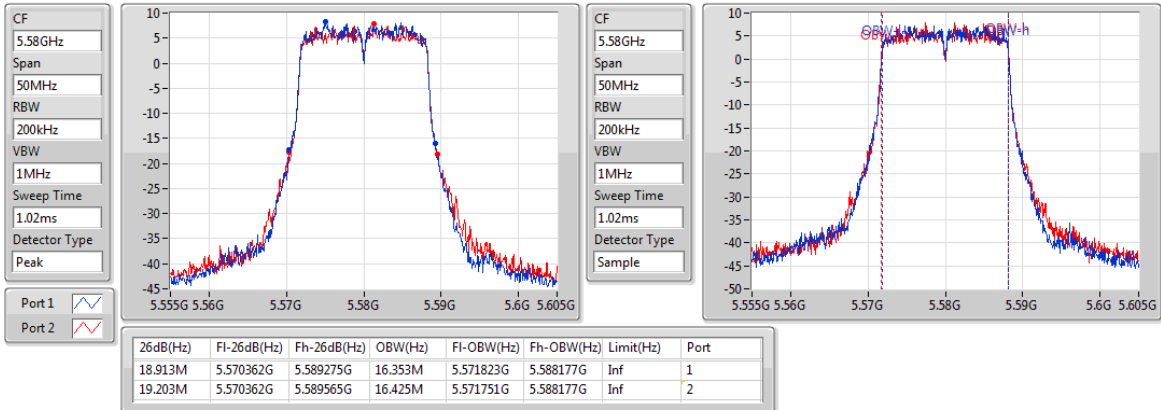

802.11a_Nss1,(6Mbps)_2TX

EBW

5700MHz

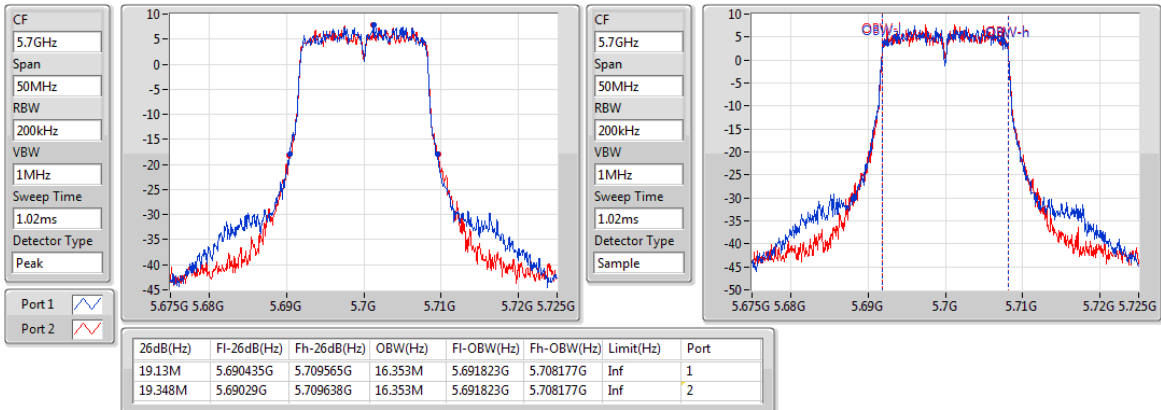

802.11a_Nss1,(6Mbps)_2TX

EBW

5720MHz Straddle 5.47-5.725GHz

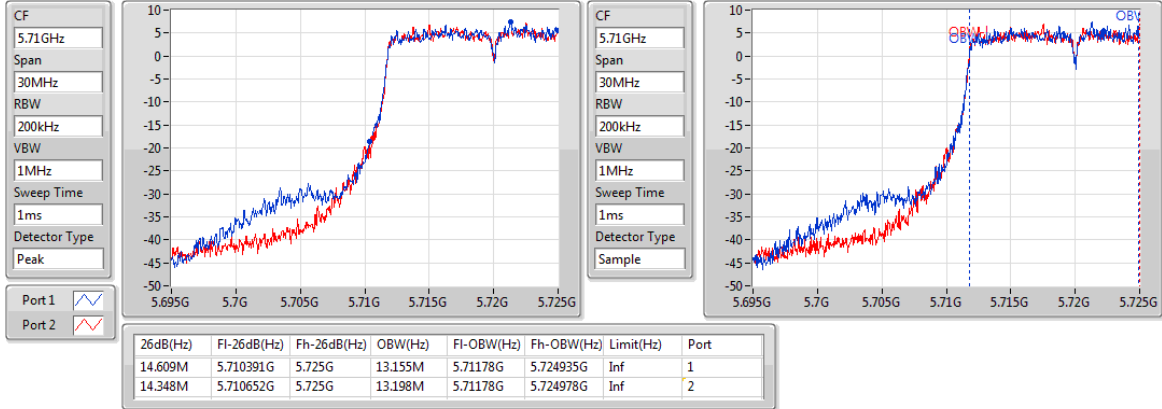

802.11a_Nss1,(6Mbps)_2TX

EBW

5720MHz Straddle 5.725-5.85GHz

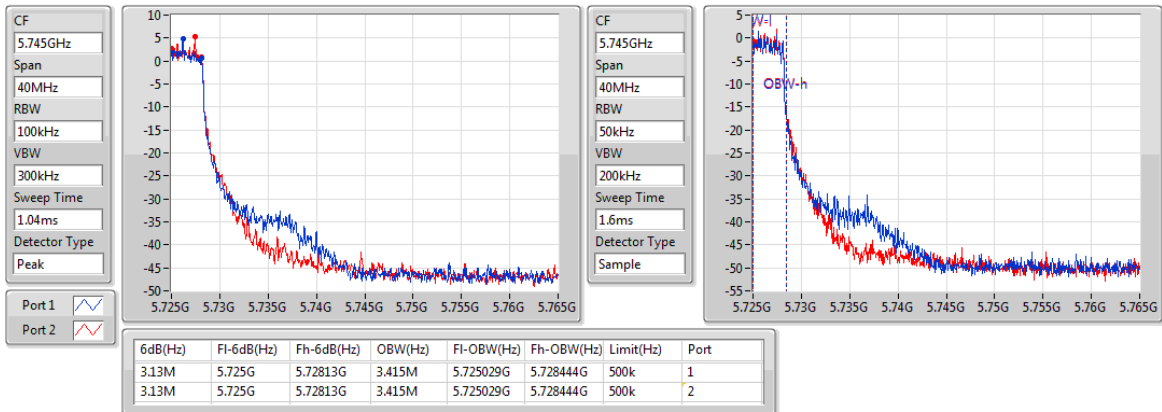

802.11a_Nss1,(6Mbps)_2TX

EBW

5745MHz

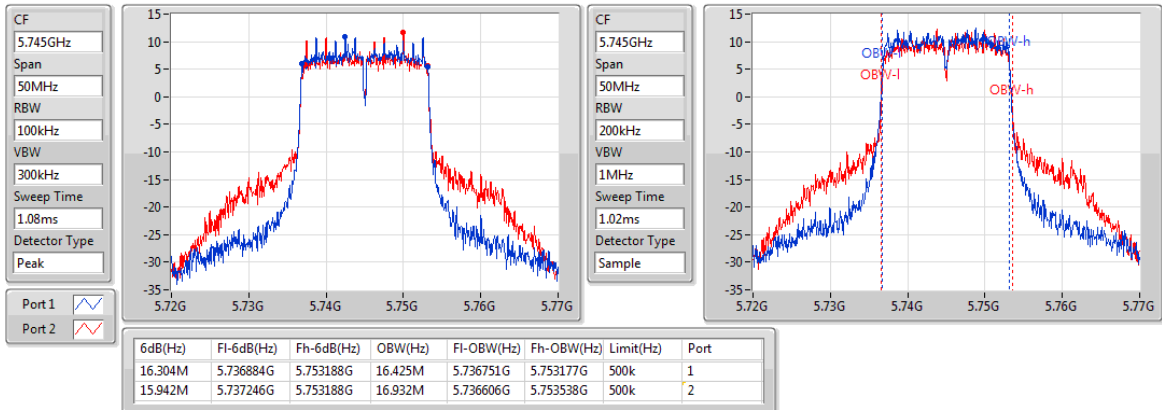

802.11a_Nss1,(6Mbps)_2TX

EBW

5785MHz

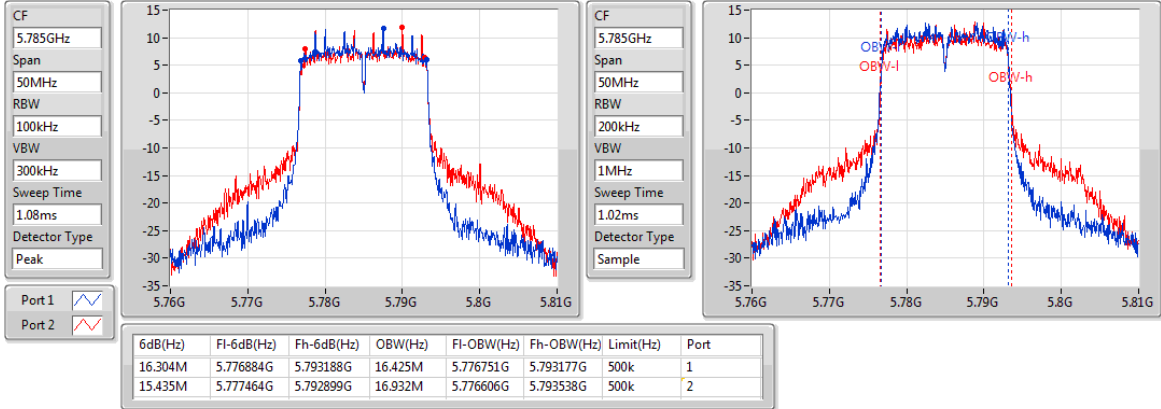

802.11a_Nss1,(6Mbps)_2TX

EBW

5825MHz

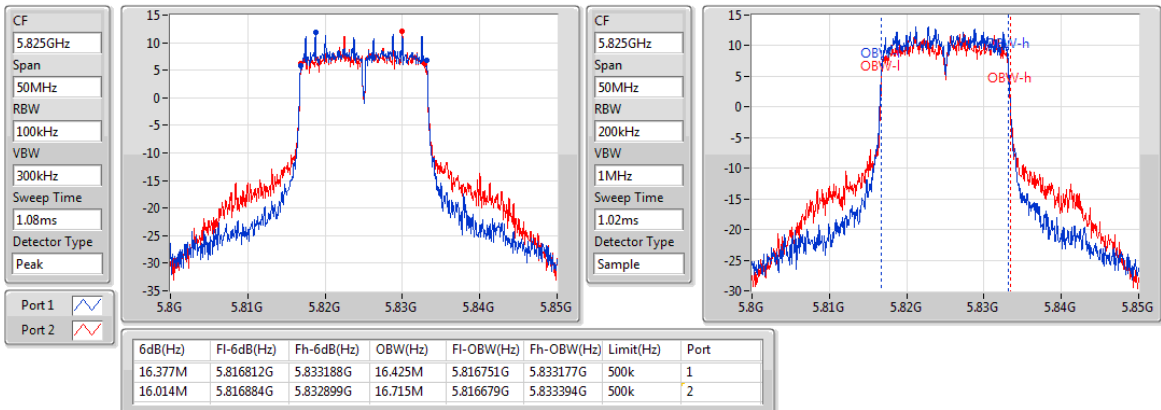

802.11ax HEW20_Nss1,(MCS0)_2TX

EBW

5180MHz

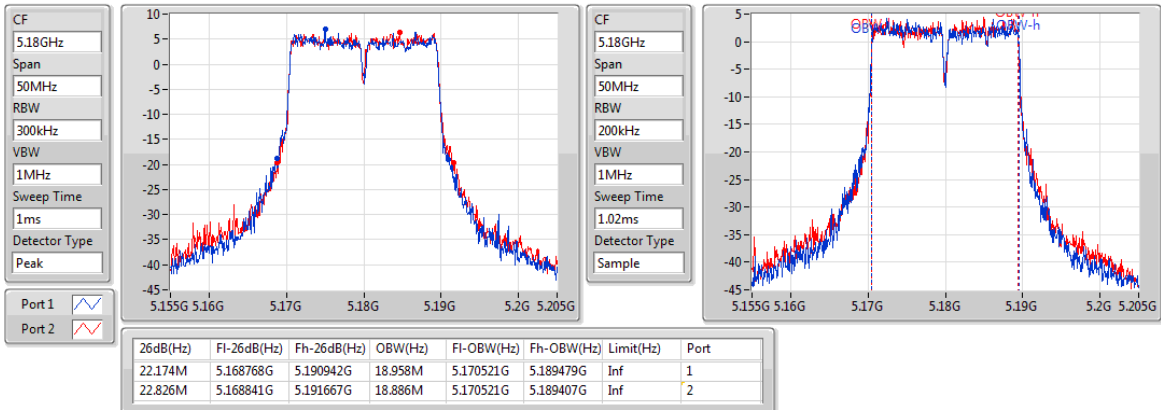

802.11ax HEW20_Nss1,(MCS0)_2TX

EBW

5200MHz

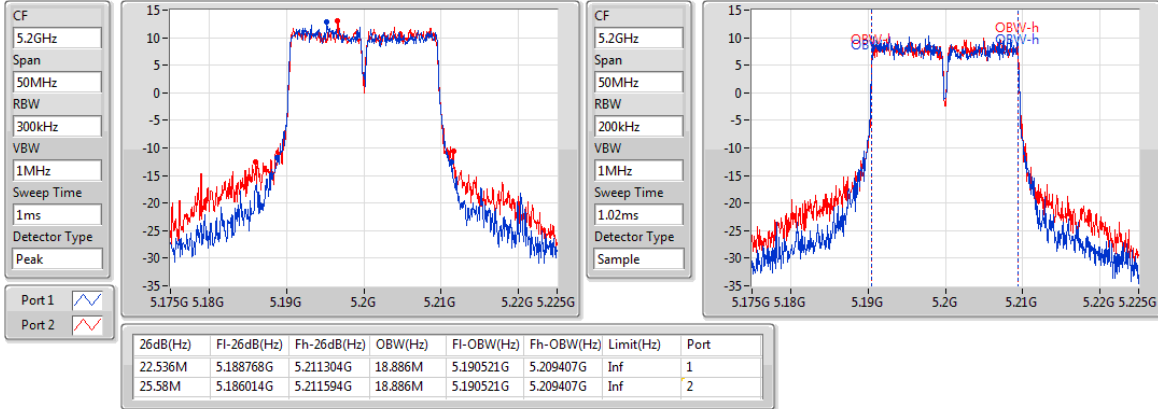

802.11ax HEW20_Nss1,(MCS0)_2TX

EBW

5240MHz

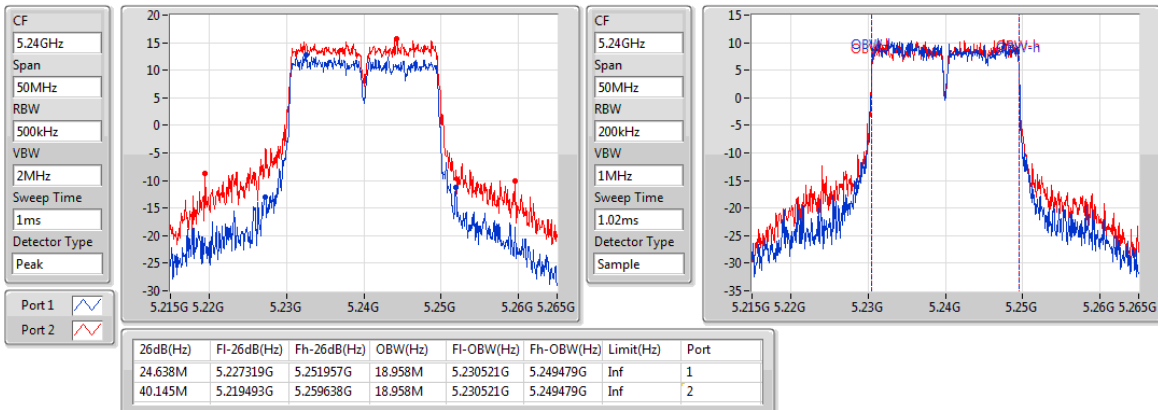

802.11ax HEW20_Nss1,(MCS0)_2TX

EBW

5260MHz

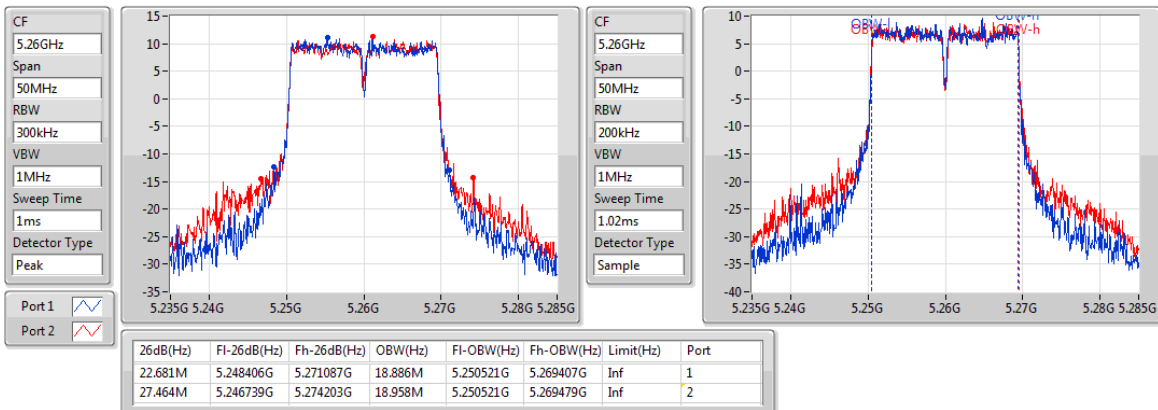

802.11ax HEW20_Nss1,(MCS0)_2TX

EBW

5300MHz

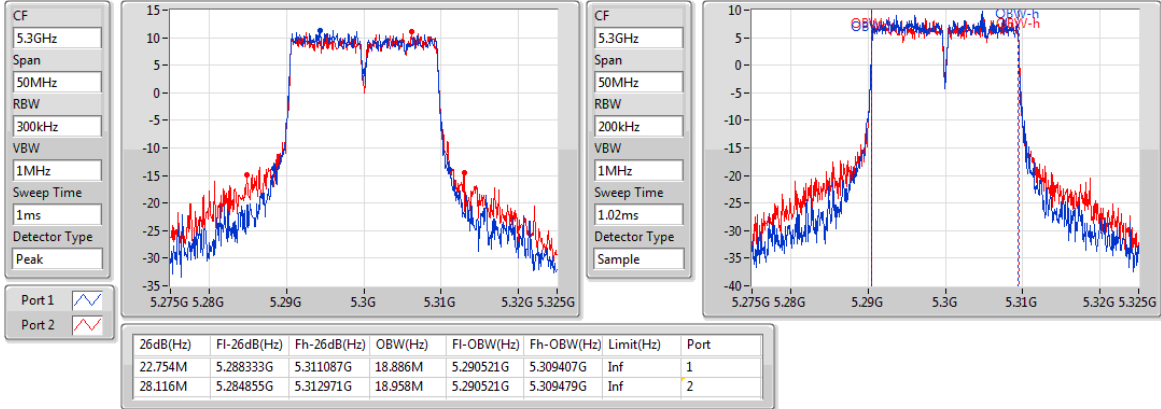

802.11ax HEW20_Nss1,(MCS0)_2TX

EBW

5320MHz

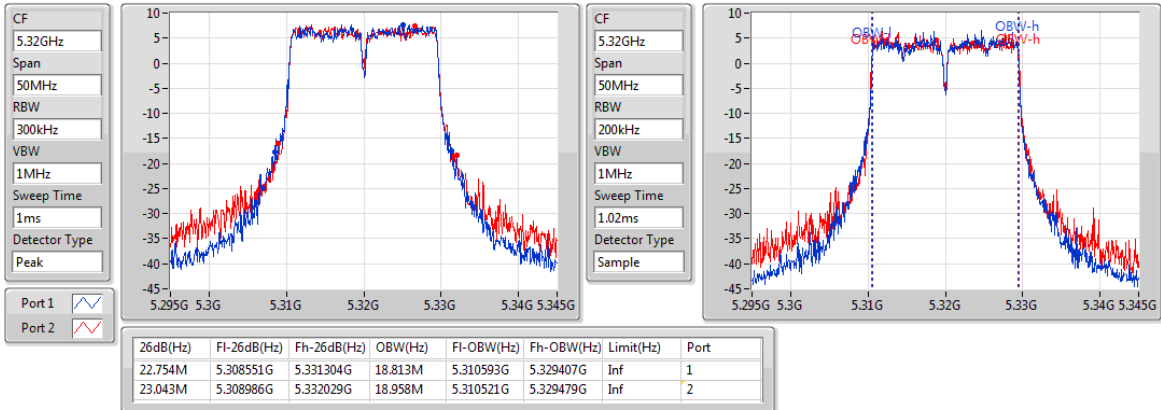

802.11ax HEW20_Nss1,(MCS0)_2TX

EBW

5500MHz

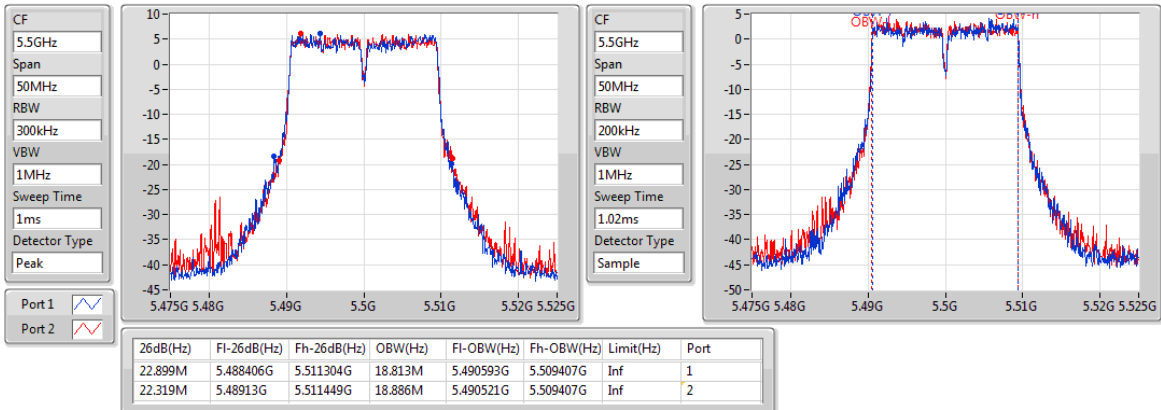

802.11ax HEW20_Nss1,(MCS0)_2TX

EBW

5580MHz

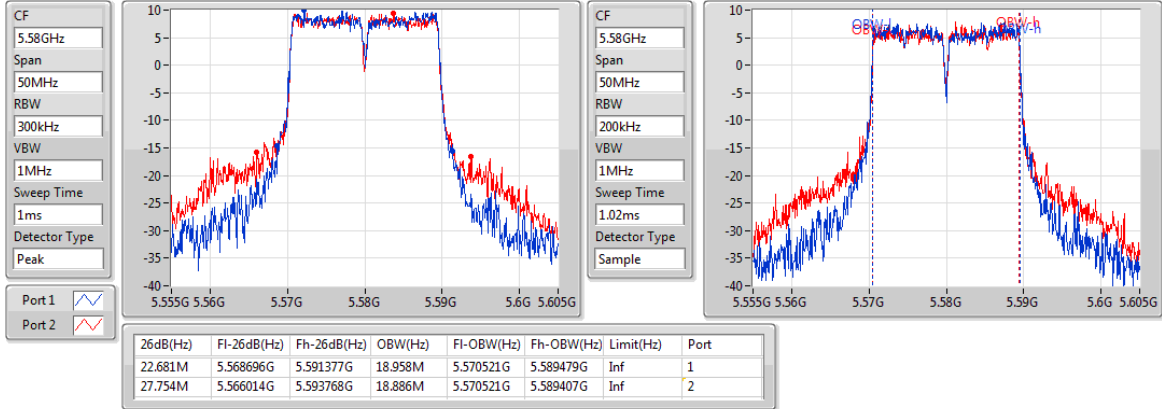

802.11ax HEW20_Nss1,(MCS0)_2TX

EBW

5700MHz

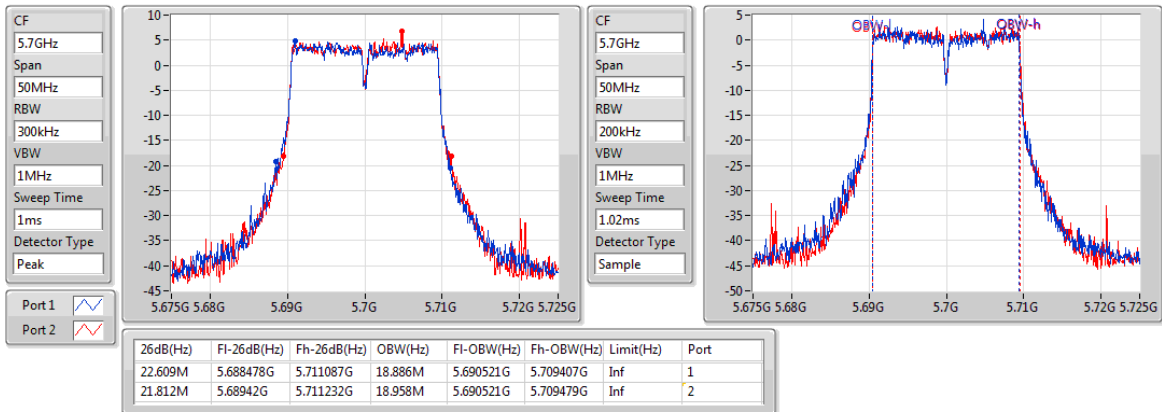

802.11ax HEW20_Nss1,(MCS0)_2TX

EBW

5720MHz Straddle 5.47-5.725GHz

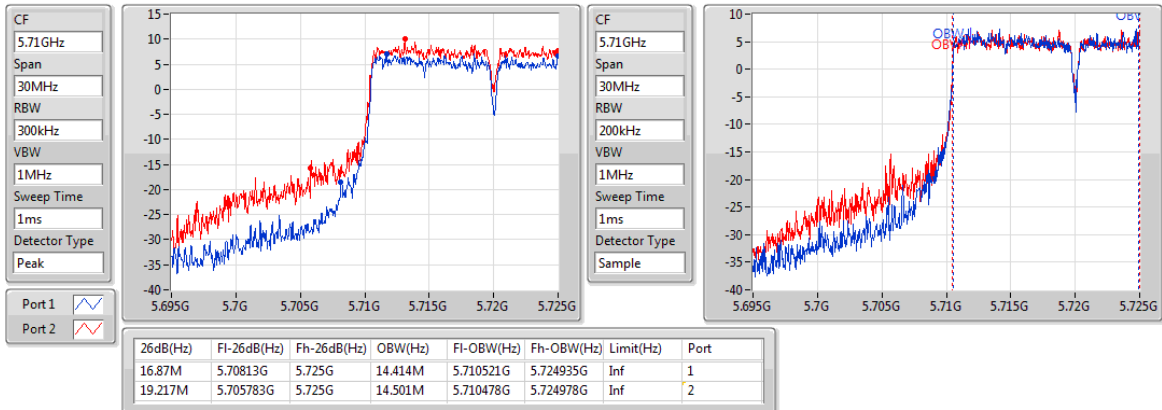

802.11ax HEW20_Nss1,(MCS0)_2TX

EBW

5720MHz Straddle 5.725-5.85GHz

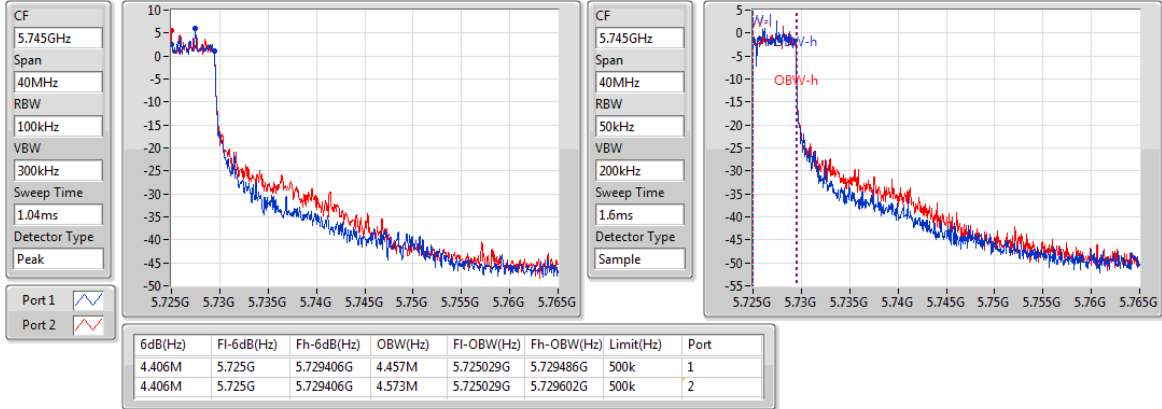

802.11ax HEW20_Nss1,(MCS0)_2TX

EBW

5745MHz

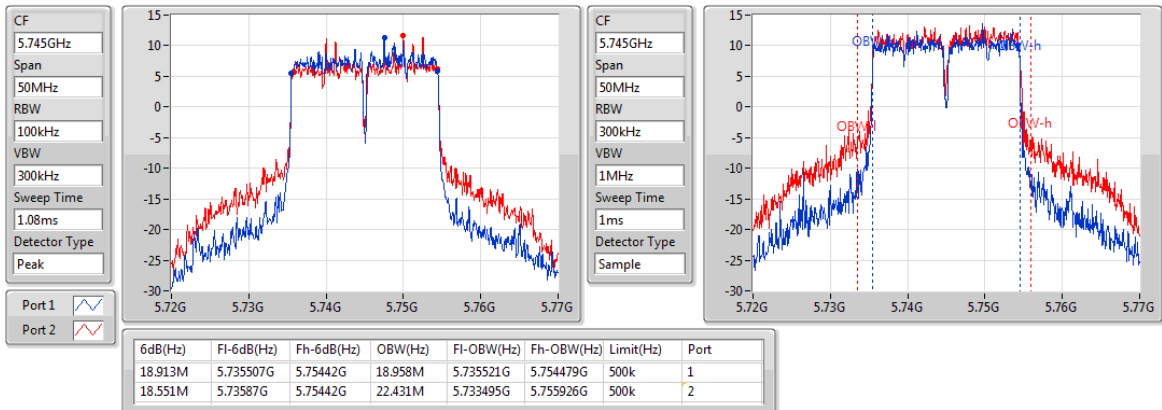

802.11ax HEW20_Nss1,(MCS0)_2TX

EBW

5785MHz

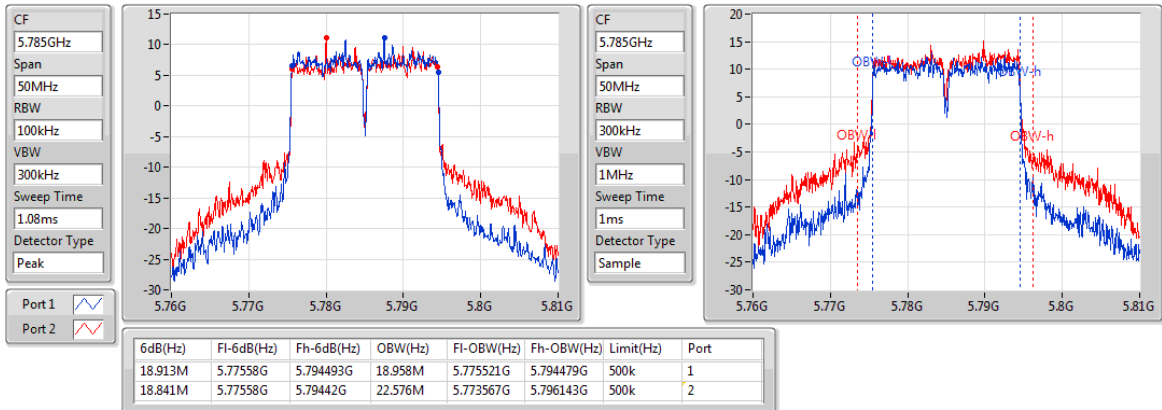

802.11ax HEW20_Nss1,(MCS0)_2TX

EBW

5825MHz

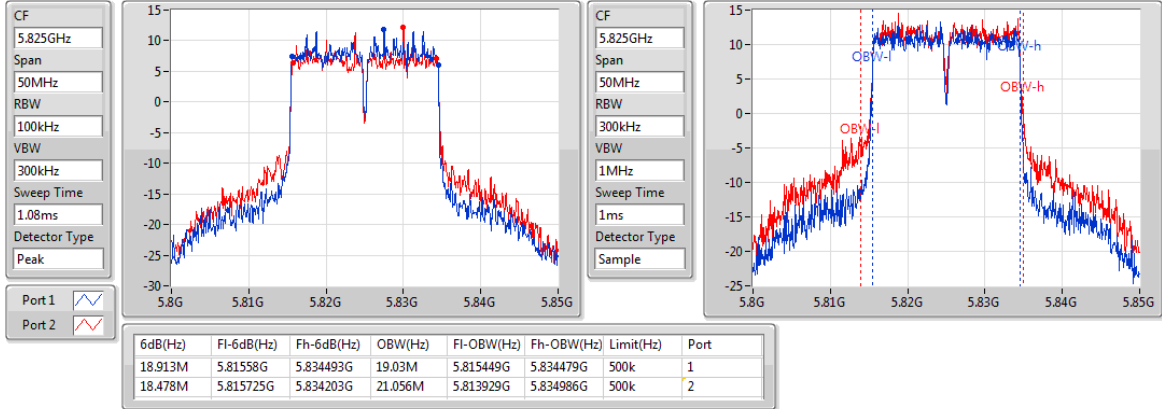

802.11ax HEW40_Nss1,(MCS0)_2TX

EBW

5190MHz

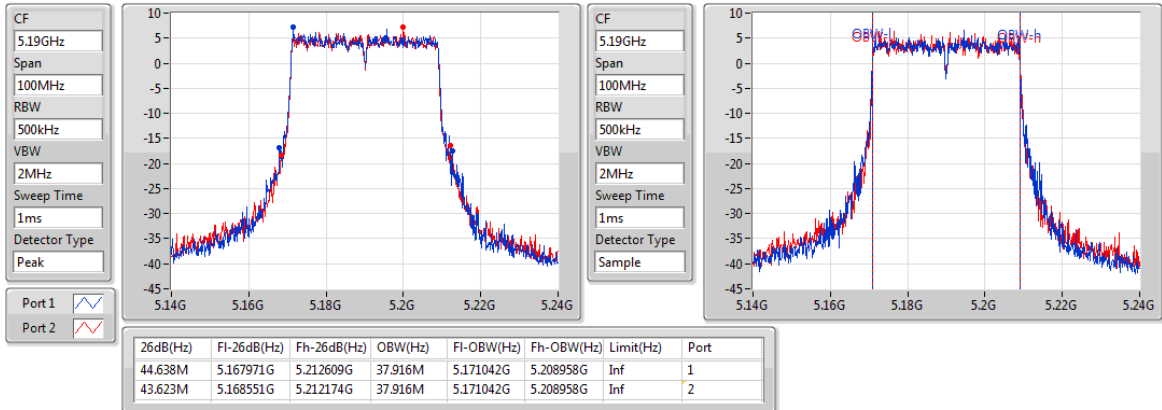

802.11ax HEW40_Nss1,(MCS0)_2TX

EBW

5230MHz

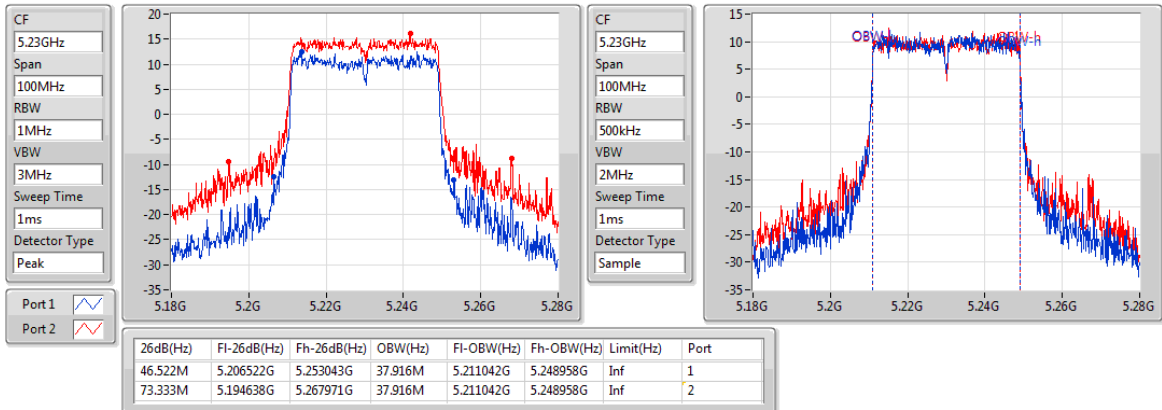

802.11ax HEW40_Nss1,(MCS0)_2TX

EBW

5270MHz

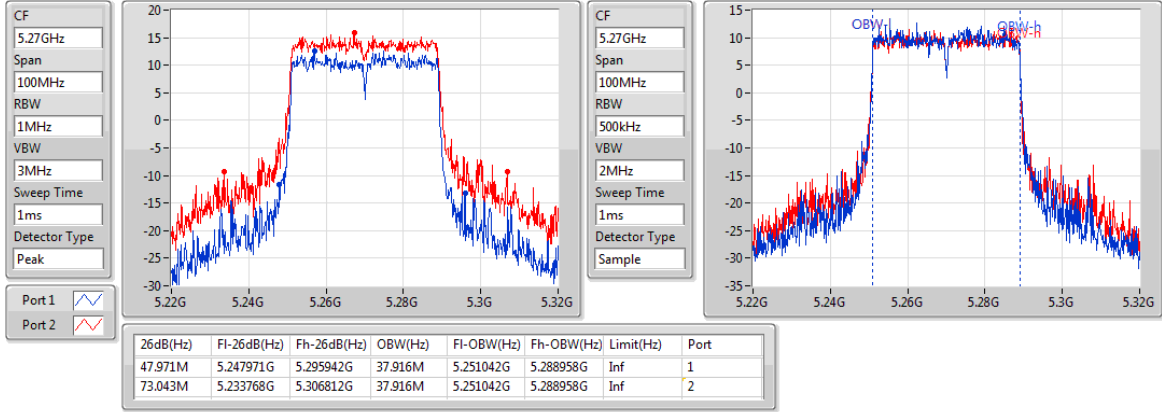

802.11ax HEW40_Nss1,(MCS0)_2TX

EBW

5310MHz

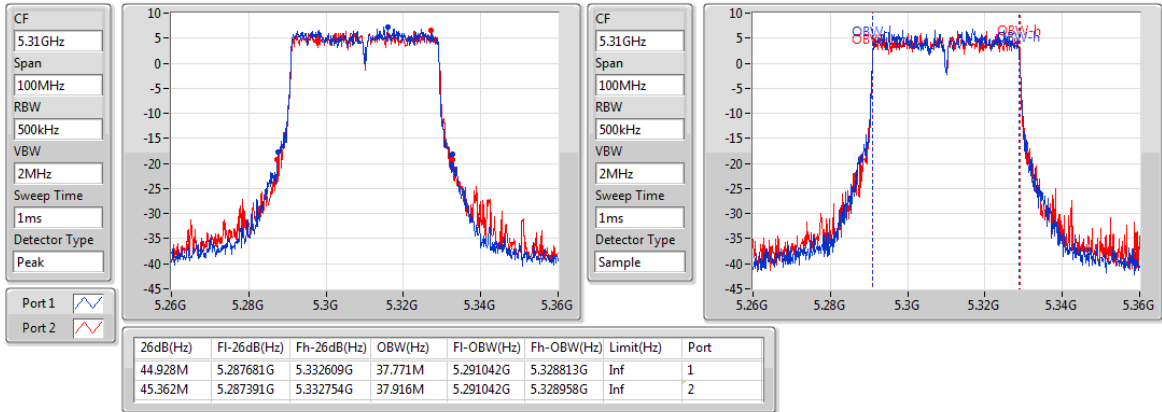

802.11ax HEW40_Nss1,(MCS0)_2TX

EBW

5510MHz

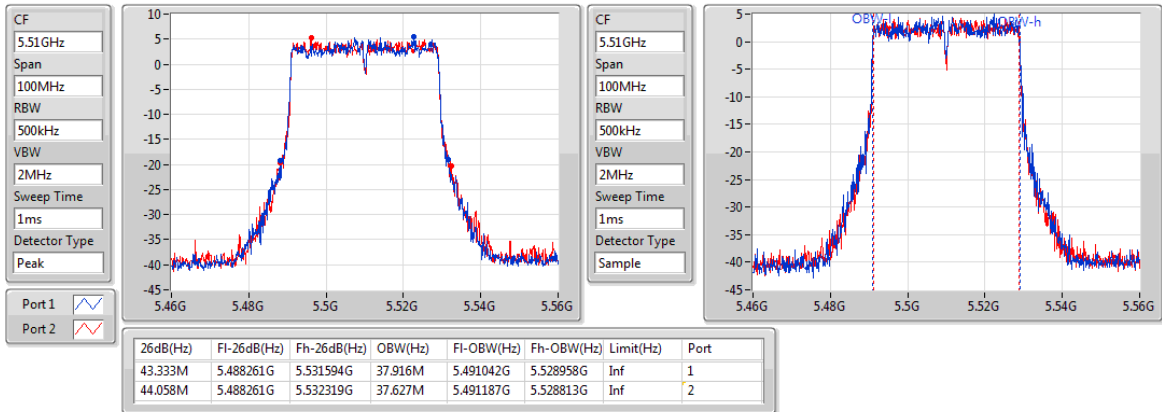

802.11ax HEW40_Nss1,(MCS0)_2TX

EBW

5590MHz

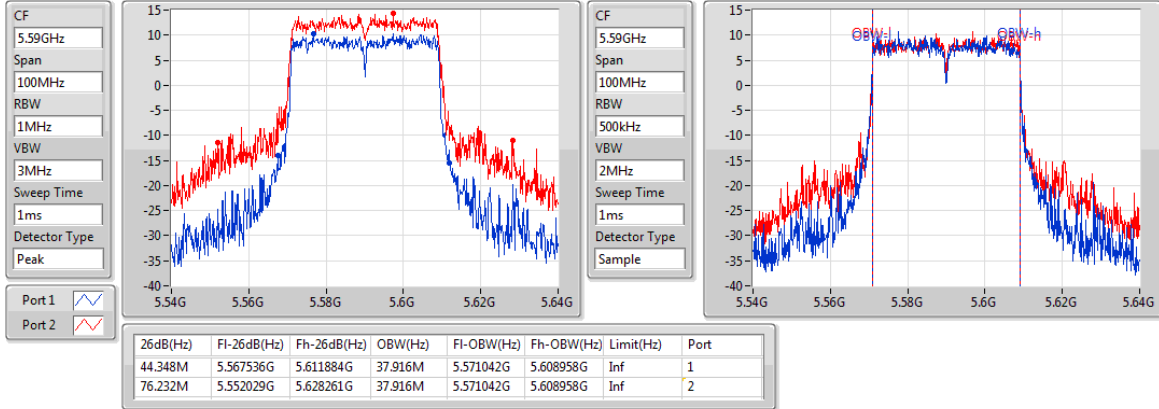

802.11ax HEW40_Nss1,(MCS0)_2TX

EBW

5670MHz

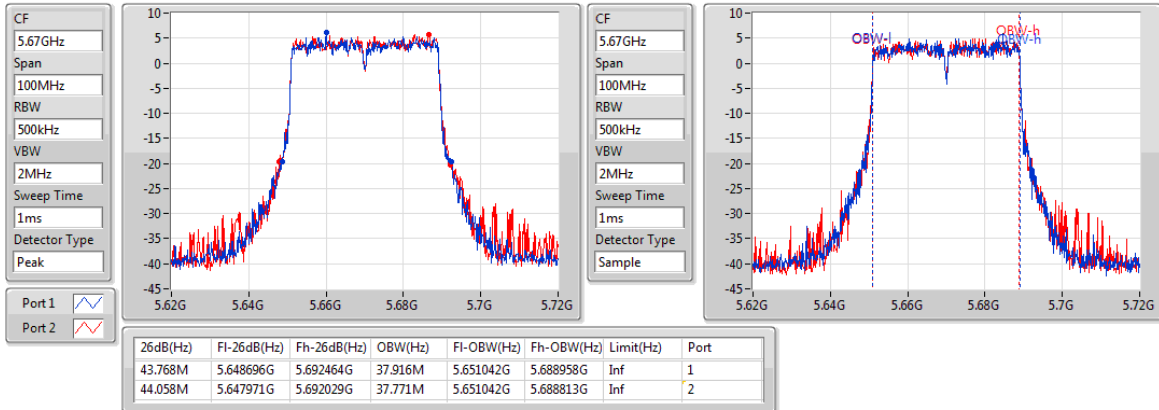

802.11ax HEW40_Nss1,(MCS0)_2TX

EBW

5710MHz Straddle 5.47-5.725GHz

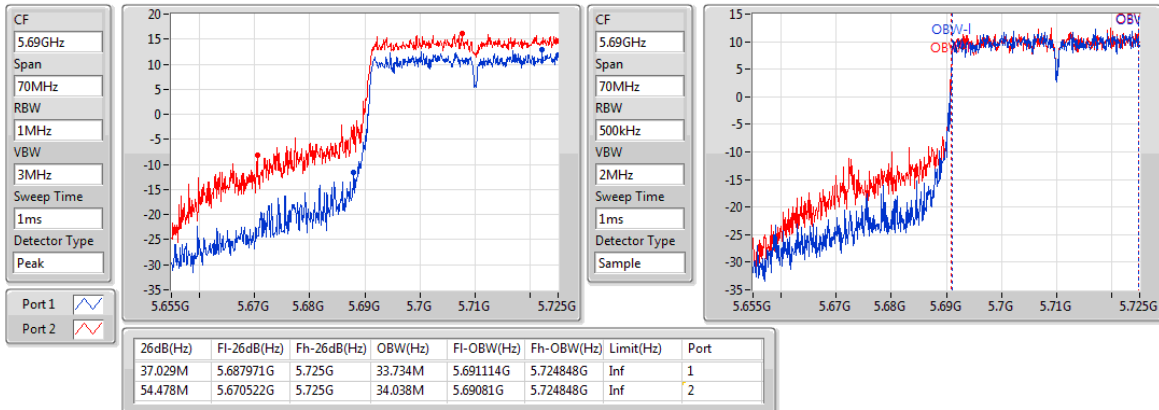

802.11ax HEW40_Nss1,(MCS0)_2TX

EBW

5710MHz Straddle 5.725-5.85GHz

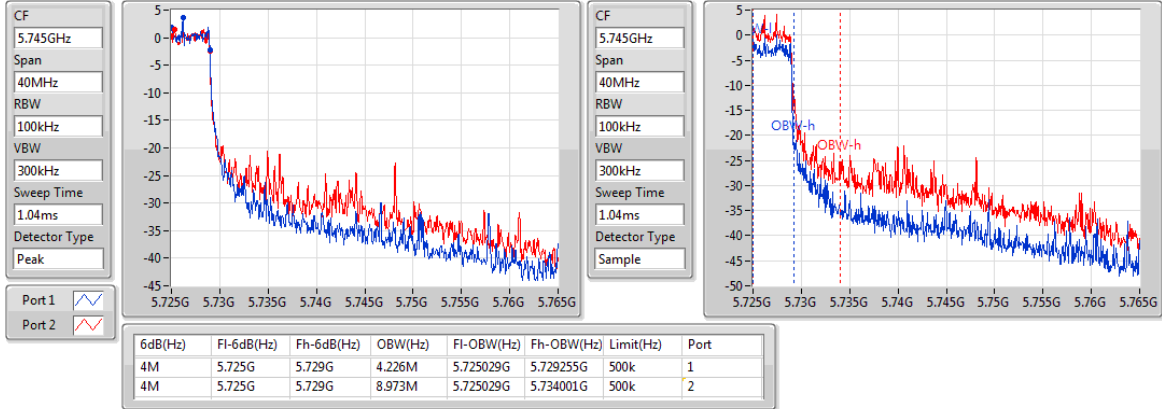

802.11ax HEW40_Nss1,(MCS0)_2TX

EBW

5755MHz

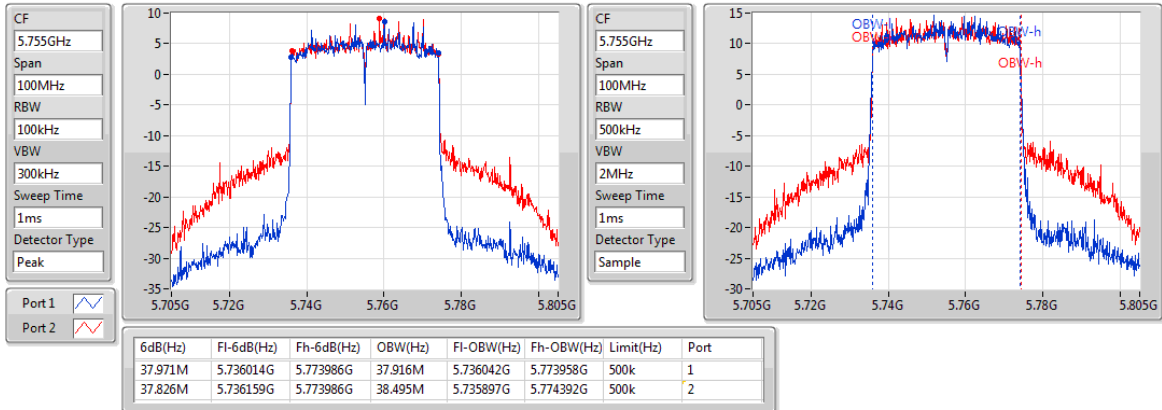

802.11ax HEW40_Nss1,(MCS0)_2TX

EBW

5795MHz

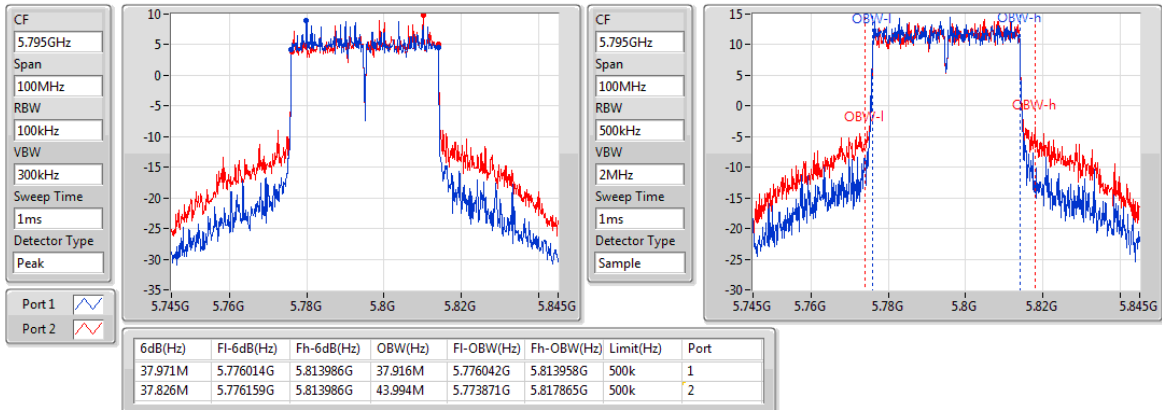

802.11ax HEW80_Nss1,(MCS0)_2TX

EBW

5210MHz

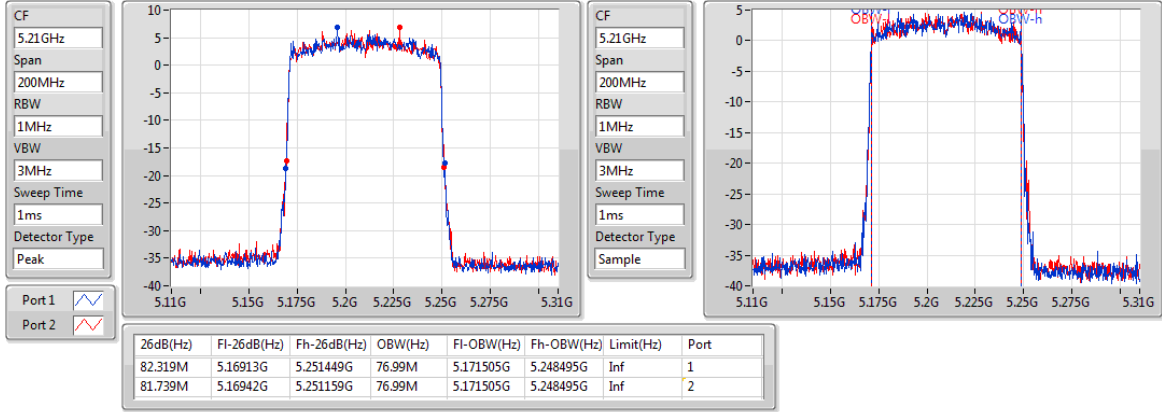

802.11ax HEW80_Nss1,(MCS0)_2TX

EBW

5290MHz

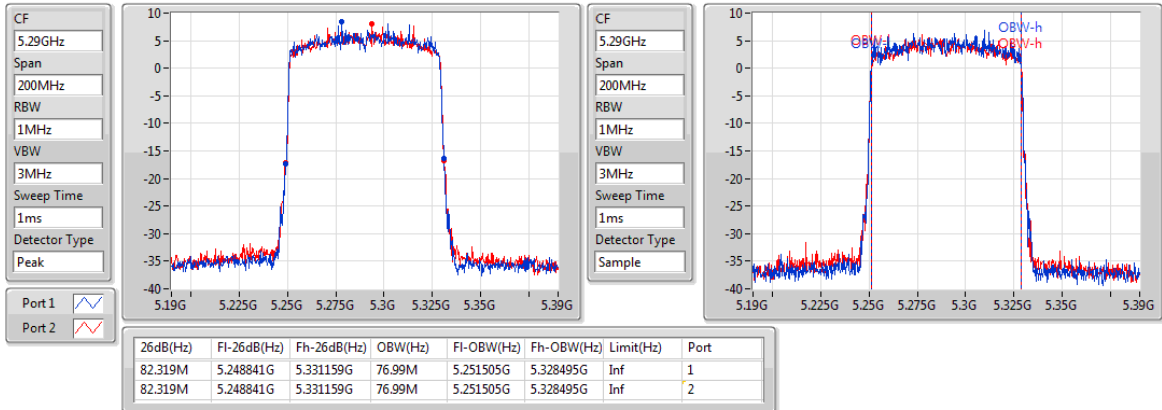

802.11ax HEW80_Nss1,(MCS0)_2TX

EBW

5530MHz

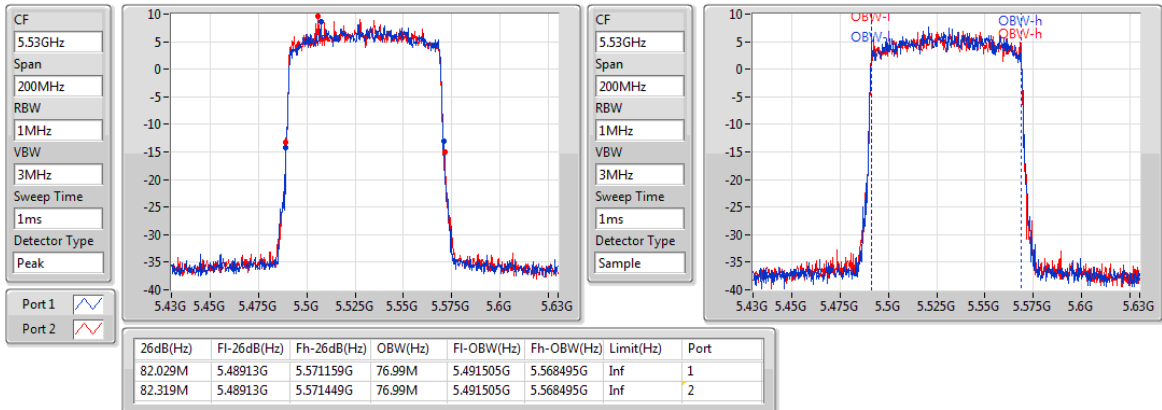

802.11ax HEW80_Nss1,(MCS0)_2TX

EBW

5610MHz

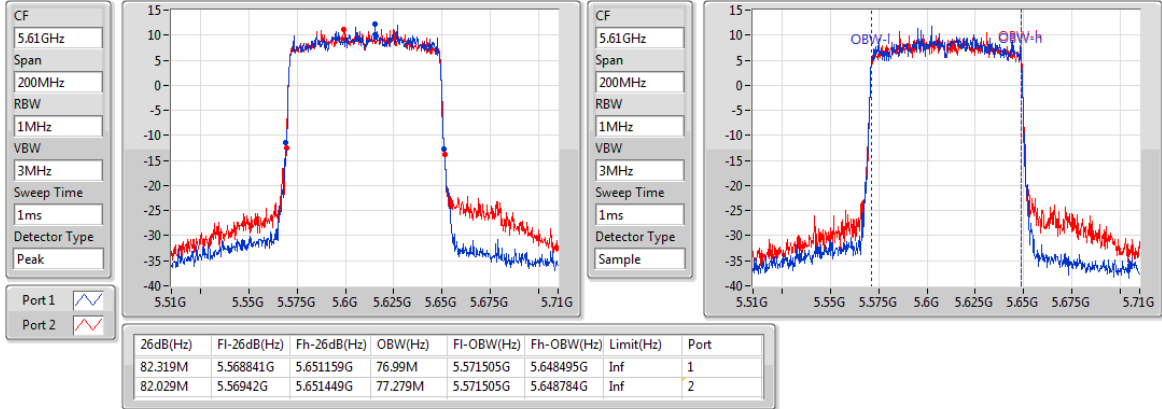

802.11ax HEW80_Nss1,(MCS0)_2TX

EBW

5690MHz Straddle 5.47-5.725GHz

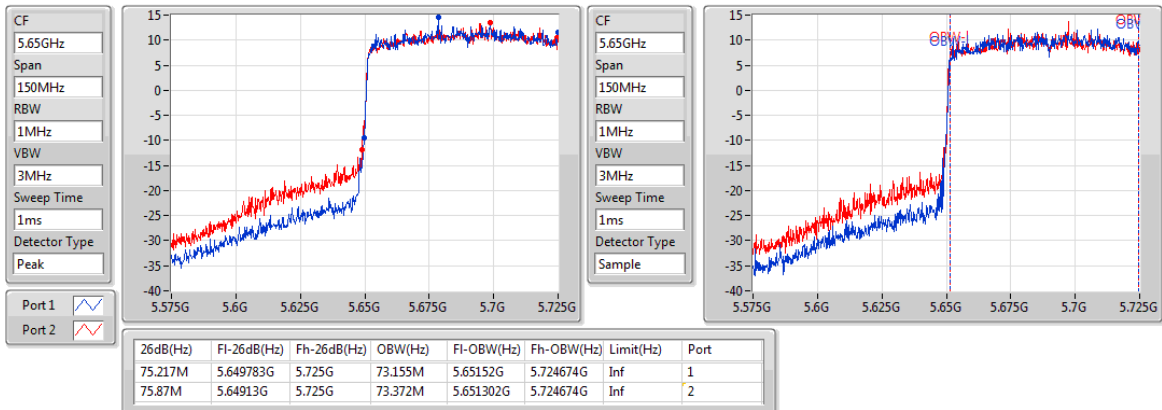

802.11ax HEW80_Nss1,(MCS0)_2TX

EBW

5690MHz Straddle 5.725-5.85GHz

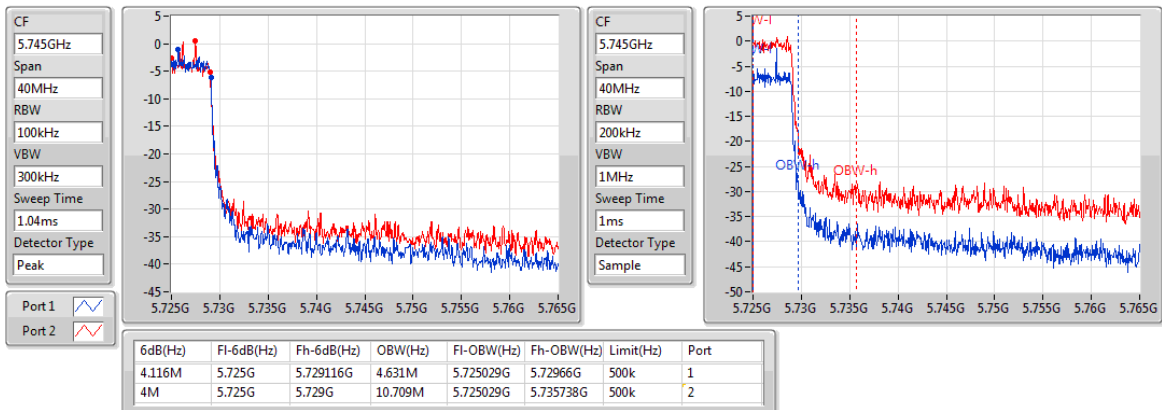

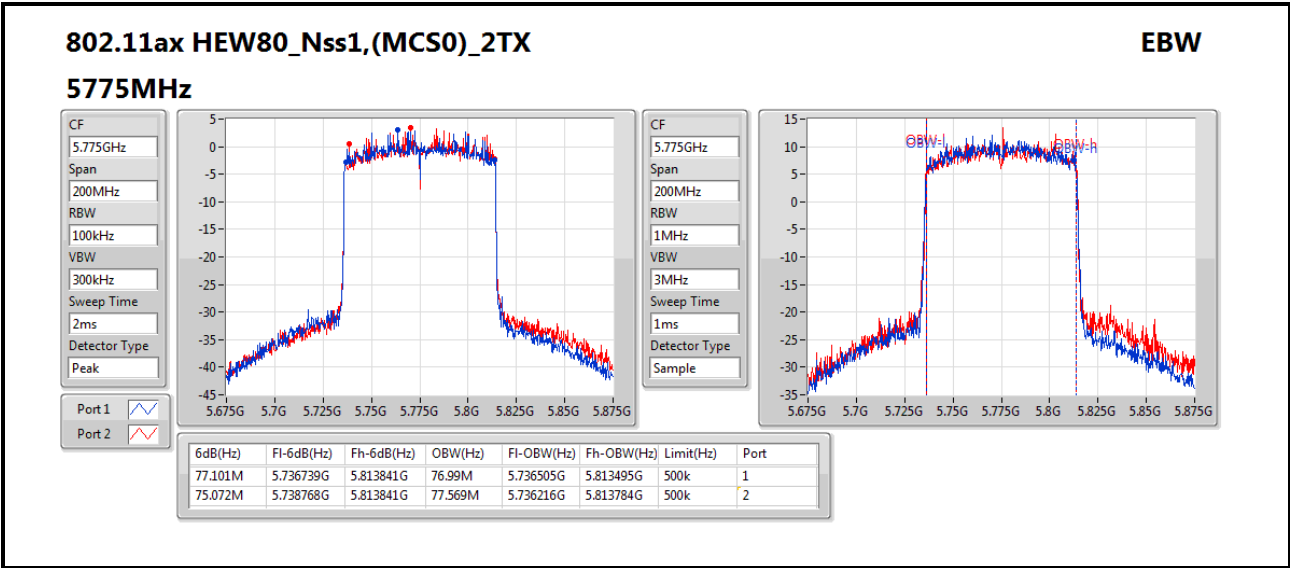

3.3 RF Output Power

3.3.1 Limit of RF Output Power

Frequency band 5150-5250 MHz		
Operating Mode		Limit
<input type="checkbox"/>	Outdoor access point	Conducted Power: 1 W The maximum e.i.r.p. at any elevation angle above 30 degrees as measured from the horizon must not exceed 125 mW (21 dBm)
<input checked="" type="checkbox"/>	Indoor access point	Conducted Power: 1 W
<input type="checkbox"/>	Fixed point-to-point access points	Conducted Power: 1 W
<input type="checkbox"/>	Client devices	Conducted Power: 250 mW

Frequency Band (MHz)		Limit
<input checked="" type="checkbox"/>	5250 ~ 5350	Conducted Power: 250mW or 11dBm+10 log B
<input checked="" type="checkbox"/>	5470 ~ 5725	Conducted Power: 250mW or 11dBm+10 log B
<input checked="" type="checkbox"/>	5725 ~ 5850	Conducted Power: 1 W

Note: "B" is the 26dB emission bandwidth in MHz.

3.3.2 Test Procedures

Method PM-G (Measurement using a gated RF average power meter)

Measurements is performed using a wideband gated RF power meter provided that the gate parameters are adjusted such that the power is measured only when the EUT is transmitting at its maximum power control level. Since the measurement is made only during the ON time of the transmitter, no duty cycle correction factor is required.

Spectrum analyzer (For channel that extends across the 5.725 GHz boundary)

1. Set RBW = 1MHz, VBW = 3MHz, Sweep time = Auto, Detector = RMS.
2. Trace average at least 100 traces in power averaging mode.
3. Compute power by integrating the spectrum across the 26 dB EBW.
4. Add $10 \log(1/X)$, X:duty cycle) if duty cycle is <98%).

3.3.3 Test Setup

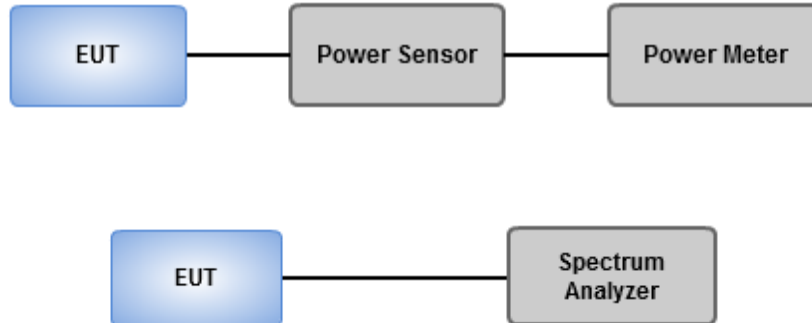

3.3.4 Test Result of Maximum Conducted Output Power

Non-beamforming mode

Summary

Mode	Total Power (dBm)	Total Power (W)	EIRP (dBm)	EIRP (W)
5.15-5.25GHz	-	-	-	-
802.11a_Nss1,(6Mbps)_2TX	25.67	0.36898	30.17	1.03992
802.11ax HEW20_Nss1,(MCS0)_2TX	24.29	0.26853	28.79	0.75683
802.11ax HEW40_Nss1,(MCS0)_2TX	23.97	0.24946	28.47	0.70307
802.11ax HEW80_Nss1,(MCS0)_2TX	16.73	0.04710	21.23	0.13274
5.25-5.35GHz	-	-	-	-
802.11a_Nss1,(6Mbps)_2TX	22.44	0.17539	26.94	0.49431
802.11ax HEW20_Nss1,(MCS0)_2TX	22.49	0.17742	26.99	0.50003
802.11ax HEW40_Nss1,(MCS0)_2TX	23.79	0.23933	28.29	0.67453
802.11ax HEW80_Nss1,(MCS0)_2TX	18.02	0.06339	22.52	0.17865
5.47-5.725GHz	-	-	-	-
802.11a_Nss1,(6Mbps)_2TX	21.46	0.13996	26.66	0.46345
802.11ax HEW20_Nss1,(MCS0)_2TX	21.29	0.13459	26.49	0.44566
802.11ax HEW40_Nss1,(MCS0)_2TX	23.77	0.23823	28.97	0.78886
802.11ax HEW80_Nss1,(MCS0)_2TX	23.03	0.20091	28.23	0.66527
5.725-5.85GHz	-	-	-	-
802.11a_Nss1,(6Mbps)_2TX	25.90	0.38905	31.40	1.38038
802.11ax HEW20_Nss1,(MCS0)_2TX	25.78	0.37844	31.28	1.34276
802.11ax HEW40_Nss1,(MCS0)_2TX	26.02	0.39994	31.52	1.41906
802.11ax HEW80_Nss1,(MCS0)_2TX	23.32	0.21478	28.82	0.76208

Result

Mode	Result	DG (dBi)	Port 1 (dBm)	Port 2 (dBm)	Total Power (dBm)	Power Limit (dBm)	EIRP (dBm)	EIRP Limit (dBm)
802.11a_Nss1,(6Mbps)_2TX	-	-	-	-	-	-	-	-
5180MHz	Pass	4.50	19.11	19.35	22.24	30.00	26.74	36.00
5200MHz	Pass	4.50	22.28	22.13	25.22	30.00	29.72	36.00
5240MHz	Pass	4.50	22.84	22.47	25.67	30.00	30.17	36.00
5260MHz	Pass	4.50	19.47	19.38	22.44	23.78	26.94	29.78
5300MHz	Pass	4.50	19.38	19.21	22.31	23.78	26.81	29.78
5320MHz	Pass	4.50	19.37	19.20	22.30	23.75	26.80	29.75
5500MHz	Pass	5.20	18.47	18.43	21.46	23.73	26.66	29.73
5580MHz	Pass	5.20	18.36	18.18	21.28	23.77	26.48	29.77
5700MHz	Pass	5.20	18.15	18.13	21.15	23.82	26.35	29.82
5720MHz Straddle 5.47-5.725GHz	Pass	5.20	17.45	17.64	20.56	22.57	25.76	28.57
5720MHz Straddle 5.725-5.85GHz	Pass	5.50	10.38	10.59	13.50	30.00	19.00	36.00
5745MHz	Pass	5.50	23.08	22.05	25.61	30.00	31.11	36.00
5785MHz	Pass	5.50	23.11	22.16	25.67	30.00	31.17	36.00
5825MHz	Pass	5.50	23.46	22.23	25.90	30.00	31.40	36.00
802.11ax HEW20_Nss1,(MCS0)_2TX	-	-	-	-	-	-	-	-
5180MHz	Pass	4.50	14.76	14.67	17.73	30.00	22.23	36.00
5200MHz	Pass	4.50	20.44	20.37	23.42	30.00	27.92	36.00
5240MHz	Pass	4.50	21.43	21.13	24.29	30.00	28.79	36.00
5260MHz	Pass	4.50	19.52	19.43	22.49	24.00	26.99	30.00
5300MHz	Pass	4.50	19.47	19.26	22.38	24.00	26.88	30.00
5320MHz	Pass	4.50	16.25	16.26	19.27	24.00	23.77	30.00
5500MHz	Pass	5.20	14.31	14.63	17.48	24.00	22.68	30.00
5580MHz	Pass	5.20	18.42	18.14	21.29	24.00	26.49	30.00
5700MHz	Pass	5.20	13.27	13.64	16.47	24.00	21.67	30.00
5720MHz Straddle 5.47-5.725GHz	Pass	5.20	17.19	17.15	20.18	23.27	25.38	29.27
5720MHz Straddle 5.725-5.85GHz	Pass	5.50	11.45	11.56	14.52	30.00	20.02	36.00
5745MHz	Pass	5.50	23.01	22.03	25.56	30.00	31.06	36.00
5785MHz	Pass	5.50	23.02	22.23	25.65	30.00	31.15	36.00
5825MHz	Pass	5.50	23.32	22.13	25.78	30.00	31.28	36.00
802.11ax HEW40_Nss1,(MCS0)_2TX	-	-	-	-	-	-	-	-
5190MHz	Pass	4.50	14.67	14.68	17.69	30.00	22.19	36.00
5230MHz	Pass	4.50	20.99	20.93	23.97	30.00	28.47	36.00
5270MHz	Pass	4.50	20.93	20.63	23.79	24.00	28.29	30.00
5310MHz	Pass	4.50	15.54	15.46	18.51	24.00	23.01	30.00

Mode	Result	DG (dBi)	Port 1 (dBm)	Port 2 (dBm)	Total Power (dBm)	Power Limit (dBm)	EIRP (dBm)	EIRP Limit (dBm)
5510MHz	Pass	5.20	13.39	13.67	16.54	24.00	21.74	30.00
5590MHz	Pass	5.20	20.89	20.63	23.77	24.00	28.97	30.00
5670MHz	Pass	5.20	14.34	14.29	17.33	24.00	22.53	30.00
5710MHz Straddle 5.47-5.725GHz	Pass	5.20	19.75	19.89	22.83	24.00	28.03	30.00
5710MHz Straddle 5.725-5.85GHz	Pass	5.50	11.42	11.62	14.53	30.00	20.03	36.00
5755MHz	Pass	5.50	22.99	22.56	25.79	30.00	31.29	36.00
5795MHz	Pass	5.50	23.25	22.76	26.02	30.00	31.52	36.00
802.11ax HEW80_Nss1,(MCS0)_2TX	-	-	-	-	-	-	-	-
5210MHz	Pass	4.50	13.71	13.73	16.73	30.00	21.23	36.00
5290MHz	Pass	4.50	15.02	14.99	18.02	24.00	22.52	30.00
5530MHz	Pass	5.20	15.83	15.77	18.81	24.00	24.01	30.00
5610MHz	Pass	5.20	18.55	18.71	21.64	24.00	26.84	30.00
5690MHz Straddle 5.47-5.725GHz	Pass	5.20	20.05	19.99	23.03	24.00	28.23	30.00
5690MHz Straddle 5.725-5.85GHz	Pass	5.50	7.19	7.15	10.18	30.00	15.68	36.00
5775MHz	Pass	5.50	20.59	20.02	23.32	30.00	28.82	36.00

DG = Directional Gain; **Port X** = Port X output power

Beamforming mode

Summary

Mode	Total Power (dBm)	Total Power (W)	EIRP (dBm)	EIRP (W)
5.15-5.25GHz	-	-	-	-
802.11ax HEW20-BF_Nss1,(MCS0)_2TX	21.28	0.13428	28.79	0.75683
802.11ax HEW40-BF_Nss1,(MCS0)_2TX	20.96	0.12474	28.47	0.70307
802.11ax HEW80-BF_Nss1,(MCS0)_2TX	13.72	0.02355	21.23	0.13274
5.25-5.35GHz	-	-	-	-
802.11ax HEW20-BF_Nss1,(MCS0)_2TX	19.48	0.08872	26.99	0.50003
802.11ax HEW40-BF_Nss1,(MCS0)_2TX	20.78	0.11967	28.29	0.67453
802.11ax HEW80-BF_Nss1,(MCS0)_2TX	15.01	0.03170	22.52	0.17865
5.47-5.725GHz	-	-	-	-
802.11ax HEW20-BF_Nss1,(MCS0)_2TX	18.28	0.06730	26.49	0.44566
802.11ax HEW40-BF_Nss1,(MCS0)_2TX	20.76	0.11912	28.97	0.78886
802.11ax HEW80-BF_Nss1,(MCS0)_2TX	20.02	0.10046	28.23	0.66527
5.725-5.85GHz	-	-	-	-
802.11ax HEW20-BF_Nss1,(MCS0)_2TX	22.77	0.18923	31.28	1.34276
802.11ax HEW40-BF_Nss1,(MCS0)_2TX	23.01	0.19999	31.52	1.41906
802.11ax HEW80-BF_Nss1,(MCS0)_2TX	20.31	0.10740	28.82	0.76208

Result

Mode	Result	DG (dBi)	Port 1 (dBm)	Port 2 (dBm)	Total Power (dBm)	Power Limit (dBm)	EIRP (dBm)	EIRP Limit (dBm)
802.11ax HEW20-BF_Nss1,(MCS0)_2TX	-	-	-	-	-	-	-	-
5180MHz	Pass	7.51	11.75	11.66	14.72	28.49	22.23	36.00
5200MHz	Pass	7.51	17.43	17.36	20.41	28.49	27.92	36.00
5240MHz	Pass	7.51	18.42	18.12	21.28	28.49	28.79	36.00
5260MHz	Pass	7.51	16.51	16.42	19.48	22.49	26.99	30.00
5300MHz	Pass	7.51	16.46	16.25	19.37	22.49	26.88	30.00
5320MHz	Pass	7.51	13.24	13.25	16.26	22.49	23.77	30.00
5500MHz	Pass	8.21	11.3	11.62	14.47	21.79	22.68	30.00
5580MHz	Pass	8.21	15.41	15.13	18.28	21.79	26.49	30.00
5700MHz	Pass	8.21	10.26	10.63	13.46	21.79	21.67	30.00
5720MHz Straddle 5.47-5.725GHz	Pass	8.21	14.18	14.14	17.17	21.06	25.38	29.27
5720MHz Straddle 5.725-5.85GHz	Pass	8.51	8.44	8.55	11.51	27.49	20.02	36.00
5745MHz	Pass	8.51	20	19.02	22.55	27.49	31.06	36.00
5785MHz	Pass	8.51	20.01	19.22	22.64	27.49	31.15	36.00
5825MHz	Pass	8.51	20.31	19.12	22.77	27.49	31.28	36.00
802.11ax HEW40-BF_Nss1,(MCS0)_2TX	-	-	-	-	-	-	-	-
5190MHz	Pass	7.51	11.66	11.67	14.68	28.49	22.19	36.00
5230MHz	Pass	7.51	17.98	17.92	20.96	28.49	28.47	36.00
5270MHz	Pass	7.51	17.92	17.62	20.78	22.49	28.29	30.00
5310MHz	Pass	7.51	12.53	12.45	15.50	22.49	23.01	30.00
5510MHz	Pass	8.21	10.38	10.66	13.53	21.79	21.74	30.00
5550MHz	Pass	8.21	17.88	17.62	20.76	21.79	28.97	30.00
5670MHz	Pass	8.21	11.33	11.28	14.32	21.79	22.53	30.00
5710MHz Straddle 5.47-5.725GHz	Pass	8.21	16.74	16.88	19.82	21.79	28.03	30.00
5710MHz Straddle 5.725-5.85GHz	Pass	8.51	8.41	8.61	11.52	27.49	20.03	36.00
5755MHz	Pass	8.51	19.98	19.55	22.78	27.49	31.29	36.00
5795MHz	Pass	8.51	20.24	19.75	23.01	27.49	31.52	36.00

Port X = Port X output power

DG = Directional Gain

For 5.15 ~ 5.25 GHz

Directional gain = $4.5 + 10 \cdot \log(2/1) = 7.51$ dBi > 6 dBi , Power limit shall be reduced to 30 dBm – (7.51 dBi – 6 dBi) = 28.49 dBm

For 5.25 ~ 5.35 GHz

Directional gain = $4.5 + 10 \cdot \log(2/1) = 7.51$ dBi > 6 dBi , Power limit shall be reduced to 24 dBm – (7.51 dBi – 6 dBi) = 22.49 dBm

For 5.47 ~ 5.725 GHz

Directional gain = $5.2 + 10 \cdot \log(2/1) = 8.21$ dBi > 6 dBi , Power limit shall be reduced to 24 dBm – (8.21 dBi – 6 dBi) = 21.79 dBm

For 5.725 ~ 5.85 GHz

Directional gain = $5.5 + 10 \cdot \log(2/1) = 8.51$ dBi > 6 dBi , Power limit shall be reduced to 30 dBm – (8.51 dBi – 6 dBi) = 27.49 dBm

Mode	Result	DG (dBi)	Port 1 (dBm)	Port 2 (dBm)	Total Power (dBm)	Power Limit (dBm)	EIRP (dBm)	EIRP Limit (dBm)
802.11ax HEW80-BF_Nss1,(MCS0)_2TX	-	-	-	-	-	-	-	-
5210MHz	Pass	7.51	10.7	10.72	13.72	28.49	21.23	36.00
5290MHz	Pass	7.51	12.01	11.98	15.01	22.49	22.52	30.00
5530MHz	Pass	8.21	12.82	12.76	15.80	21.79	24.01	30.00
5610MHz	Pass	8.21	15.54	15.7	18.63	21.79	26.84	30.00
5690MHz Straddle 5.47-5.725GHz	Pass	8.21	17.04	16.98	20.02	21.79	28.23	30.00
5690MHz Straddle 5.725-5.85GHz	Pass	8.51	4.18	4.14	7.17	27.49	15.68	36.00
5775MHz	Pass	8.51	17.58	17.01	20.31	27.49	28.82	36.00

Port X = Port X output power

DG = Directional Gain

For 5.15 ~ 5.25 GHz

Directional gain = $4.5 + 10 \cdot \log(2/1) = 7.51 \text{ dBi} > 6 \text{ dBi}$, Power limit shall be reduced to $30 \text{ dBm} - (7.51 \text{ dBi} - 6 \text{ dBi}) = 28.49 \text{ dBm}$

For 5.25 ~ 5.35 GHz

Directional gain = $4.5 + 10 \cdot \log(2/1) = 7.51 \text{ dBi} > 6 \text{ dBi}$, Power limit shall be reduced to $24 \text{ dBm} - (7.51 \text{ dBi} - 6 \text{ dBi}) = 22.49 \text{ dBm}$

For 5.47 ~ 5.725 GHz

Directional gain = $5.2 + 10 \cdot \log(2/1) = 8.21 \text{ dBi} > 6 \text{ dBi}$, Power limit shall be reduced to $24 \text{ dBm} - (8.21 \text{ dBi} - 6 \text{ dBi}) = 21.79 \text{ dBm}$

For 5.725 ~ 5.85 GHz

Directional gain = $5.5 + 10 \cdot \log(2/1) = 8.51 \text{ dBi} > 6 \text{ dBi}$, Power limit shall be reduced to $30 \text{ dBm} - (8.51 \text{ dBi} - 6 \text{ dBi}) = 27.49 \text{ dBm}$

3.4 Peak Power Spectral Density

3.4.1 Limit of Peak Power Spectral Density

Frequency band 5150-5250 MHz		
Operating Mode		Limit
<input type="checkbox"/>	Outdoor access point	17 dBm / MHz
<input checked="" type="checkbox"/>	Indoor access point	17 dBm / MHz
<input type="checkbox"/>	Fixed point-to-point access points	17 dBm / MHz
<input type="checkbox"/>	Client devices	11 dBm / MHz

Frequency Band (MHz)		Limit
<input checked="" type="checkbox"/>	5250 ~ 5350	11 dBm / MHz
<input checked="" type="checkbox"/>	5470 ~ 5725	11 dBm / MHz
<input checked="" type="checkbox"/>	5725 ~ 5850	30 dBm /500 kHz

3.4.2 Test Procedures

For 5150 ~ 5250 MHz / 5250 ~ 5350 MHz / 5470 ~ 5725 MHz

Duty cycle \geq 98 %

1. Set RBW = 1 MHz, VBW = 3 MHz, Sweep time = auto, Detector = RMS.
2. Trace average 100 traces.
3. Use the peak marker function to determine the maximum amplitude level.

Duty cycle $<$ 98 %

1. Set RBW = 1 MHz, VBW = 3 MHz, Detector = RMS.
2. Set sweep time $\geq 10 * (\text{number of points in sweep}) * (\text{total on/off period of the transmitted signal})$.
3. Perform a single sweep.
4. Use the peak marker function to determine the maximum amplitude level.
5. Add $10 \log(1/x)$, where x is the duty cycle.

For 5725 ~ 5850 MHz

Duty cycle \geq 98 %

1. Set RBW = 500 kHz, VBW = 3 MHz, Sweep time = auto, Detector = RMS.
2. Trace average 100 traces.
3. Use the peak marker function to determine the maximum amplitude level.

Duty cycle $<$ 98 %

1. Set RBW = 500 kHz, VBW = 3 MHz, Detector = RMS.
2. Set sweep time $\geq 10 * (\text{number of points in sweep}) * (\text{total on/off period of the transmitted signal})$.
3. Perform a single sweep.
4. Use the peak marker function to determine the maximum amplitude level.
5. Add $10 \log(1/x)$, where x is the duty cycle.

3.4.3 Test Setup

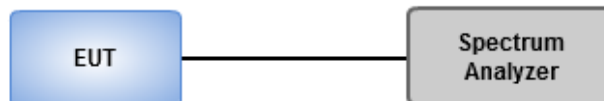

3.4.4 Test Result of Peak Power Spectral Density

Summary

Mode	PD (dBm/RBW)	EIRP PD (dBm/RBW)
5.15-5.25GHz	-	-
802.11a_Nss1,(6Mbps)_2TX	12.33	19.84
802.11ax HEW20_Nss1,(MCS0)_2TX	10.04	17.55
802.11ax HEW40_Nss1,(MCS0)_2TX	7.33	14.84
802.11ax HEW80_Nss1,(MCS0)_2TX	-2.57	4.94
5.25-5.35GHz	-	-
802.11a_Nss1,(6Mbps)_2TX	9.34	16.85
802.11ax HEW20_Nss1,(MCS0)_2TX	9.33	16.84
802.11ax HEW40_Nss1,(MCS0)_2TX	8.19	15.70
802.11ax HEW80_Nss1,(MCS0)_2TX	-1.21	6.30
5.47-5.725GHz	-	-
802.11a_Nss1,(6Mbps)_2TX	8.43	16.64
802.11ax HEW20_Nss1,(MCS0)_2TX	8.31	16.52
802.11ax HEW40_Nss1,(MCS0)_2TX	8.03	16.24
802.11ax HEW80_Nss1,(MCS0)_2TX	4.98	13.19
5.725-5.85GHz	-	-
802.11a_Nss1,(6Mbps)_2TX	11.65	20.16
802.11ax HEW20_Nss1,(MCS0)_2TX	10.58	19.09
802.11ax HEW40_Nss1,(MCS0)_2TX	7.96	16.47
802.11ax HEW80_Nss1,(MCS0)_2TX	2.65	11.16

RBW = 500kHz for 5.725-5.85GHz band / 1MHz for other band;

Result

Mode	Result	DG (dBi)	Port 1 (dBm/R BW)	Port 2 (dBm/R BW)	PD (dBm/R BW)	PD Limit (dBm/R BW)	EIRP PD (dBm/R BW)	EIRP PD Limit (dBm/R BW)
802.11a_Nss1,(6Mbps)_2TX	-	-	-	-	-	-	-	-
5180MHz	Pass	7.51	6.07	6.08	8.96	15.49	16.47	23.00
5200MHz	Pass	7.51	9.27	9.02	12.05	15.49	19.56	23.00
5240MHz	Pass	7.51	9.62	9.11	12.33	15.49	19.84	23.00
5260MHz	Pass	7.51	6.60	6.19	9.34	9.49	16.85	17.00
5300MHz	Pass	7.51	6.48	6.06	9.27	9.49	16.78	17.00
5320MHz	Pass	7.51	6.57	6.15	9.24	9.49	16.75	17.00
5500MHz	Pass	8.21	5.57	5.23	8.35	8.79	16.56	17.00
5580MHz	Pass	8.21	5.70	5.24	8.43	8.79	16.64	17.00
5700MHz	Pass	8.21	5.05	4.98	8.02	8.79	16.23	17.00
5720MHz Straddle 5.47-5.725GHz	Pass	8.21	5.31	5.52	8.40	8.79	16.61	17.00
5720MHz Straddle 5.725-5.85GHz	Pass	8.51	2.59	2.69	5.65	27.49	14.16	36.00
5745MHz	Pass	8.51	8.46	7.72	11.09	27.49	19.60	36.00
5785MHz	Pass	8.51	8.55	8.09	11.31	27.49	19.82	36.00
5825MHz	Pass	8.51	8.96	8.33	11.65	27.49	20.16	36.00
802.11ax HEW20_Nss1,(MCS0)_2TX	-	-	-	-	-	-	-	-
5180MHz	Pass	7.51	1.06	1.03	4.03	15.49	11.54	23.00
5200MHz	Pass	7.51	6.95	6.73	9.79	15.49	17.30	23.00
5240MHz	Pass	7.51	7.41	6.74	10.04	15.49	17.55	23.00
5260MHz	Pass	7.51	6.59	6.21	9.33	9.49	16.84	17.00
5300MHz	Pass	7.51	6.49	6.06	9.20	9.49	16.71	17.00
5320MHz	Pass	7.51	2.90	2.53	5.63	9.49	13.14	17.00
5500MHz	Pass	8.21	0.98	0.83	3.87	8.79	12.08	17.00
5580MHz	Pass	8.21	5.59	5.14	8.31	8.79	16.52	17.00
5700MHz	Pass	8.21	-0.12	-0.15	2.83	8.79	11.04	17.00
5720MHz Straddle 5.47-5.725GHz	Pass	8.21	5.33	5.18	8.24	8.79	16.45	17.00
5720MHz Straddle 5.725-5.85GHz	Pass	8.51	2.24	2.30	5.27	27.49	13.78	36.00
5745MHz	Pass	8.51	7.63	6.92	10.29	27.49	18.80	36.00
5785MHz	Pass	8.51	7.65	7.25	10.44	27.49	18.95	36.00
5825MHz	Pass	8.51	7.98	7.19	10.58	27.49	19.09	36.00
802.11ax HEW40_Nss1,(MCS0)_2TX	-	-	-	-	-	-	-	-
5190MHz	Pass	7.51	-1.83	-1.95	1.06	15.49	8.57	23.00
5230MHz	Pass	7.51	4.57	4.20	7.33	15.49	14.84	23.00
5270MHz	Pass	7.51	5.63	4.90	8.19	9.49	15.70	17.00
5310MHz	Pass	7.51	-0.86	-1.38	1.82	9.49	9.33	17.00

Mode	Result	DG (dBi)	Port 1 (dBm/R BW)	Port 2 (dBm/R BW)	PD (dBm/R BW)	PD Limit (dBm/R BW)	EIRP PD (dBm/R BW)	EIRP PD Limit (dBm/R BW)
5510MHz	Pass	8.21	-2.80	-2.98	-0.01	8.79	8.20	17.00
5590MHz	Pass	8.21	5.33	4.85	8.03	8.79	16.24	17.00
5670MHz	Pass	8.21	-2.22	-2.29	0.70	8.79	8.91	17.00
5710MHz Straddle 5.47-5.725GHz	Pass	8.21	4.74	4.86	7.79	8.79	16.00	17.00
5710MHz Straddle 5.725-5.85GHz	Pass	8.51	2.57	2.66	5.60	27.49	14.11	36.00
5755MHz	Pass	8.51	4.75	4.64	7.71	27.49	16.22	36.00
5795MHz	Pass	8.51	4.93	5.12	7.96	27.49	16.47	36.00
802.11ax HEW80_Nss1,(MCS0)_2TX	-	-	-	-	-	-	-	-
5210MHz	Pass	7.51	-5.32	-5.62	-2.57	15.49	4.94	23.00
5290MHz	Pass	7.51	-3.94	-4.35	-1.21	9.49	6.30	17.00
5530MHz	Pass	8.21	-3.08	-3.43	-0.40	8.79	7.81	17.00
5610MHz	Pass	8.21	-0.17	-0.44	2.62	8.79	10.83	17.00
5690MHz Straddle 5.47-5.725GHz	Pass	8.21	2.09	1.89	4.98	8.79	13.19	17.00
5690MHz Straddle 5.725-5.85GHz	Pass	8.51	-1.80	-1.88	1.16	27.49	9.67	36.00
5775MHz	Pass	8.51	-0.31	-0.32	2.65	27.49	11.16	36.00

RBW = 500kHz for 5.725-5.85GHz band / 1MHz for other band;

PD = trace bin-by-bin of each transmits port summing can be performed maximum power density; **Port X** = Port Xpower density;

DG = Directional Gain

For 5.15 ~ 5.25 GHz

Directional gain = $4.5 + 10 \cdot \log(2/1) = 7.51 \text{ dBi} > 6 \text{ dBi}$, PD limit shall be reduced to $17 \text{ dBm} - (7.51 \text{ dBi} - 6 \text{ dBi}) = 15.49 \text{ dBm}$

For 5.25 ~ 5.35 GHz

Directional gain = $4.5 + 10 \cdot \log(2/1) = 7.51 \text{ dBi} > 6 \text{ dBi}$, PD limit shall be reduced to $11 \text{ dBm} - (7.51 \text{ dBi} - 6 \text{ dBi}) = 9.49 \text{ dBm}$

For 5.47 ~ 5.725 GHz

Directional gain = $5.2 + 10 \cdot \log(2/1) = 8.21 \text{ dBi} > 6 \text{ dBi}$, PD limit shall be reduced to $11 \text{ dBm} - (8.21 \text{ dBi} - 6 \text{ dBi}) = 8.79 \text{ dBm}$

For 5.725 ~ 5.85 GHz

Directional gain = $5.5 + 10 \cdot \log(2/1) = 8.51 \text{ dBi} > 6 \text{ dBi}$, PD limit shall be reduced to $30 \text{ dBm} - (8.51 \text{ dBi} - 6 \text{ dBi}) = 27.49 \text{ dBm}$

802.11a_Nss1,(6Mbps)_2TX

PSD

5180MHz

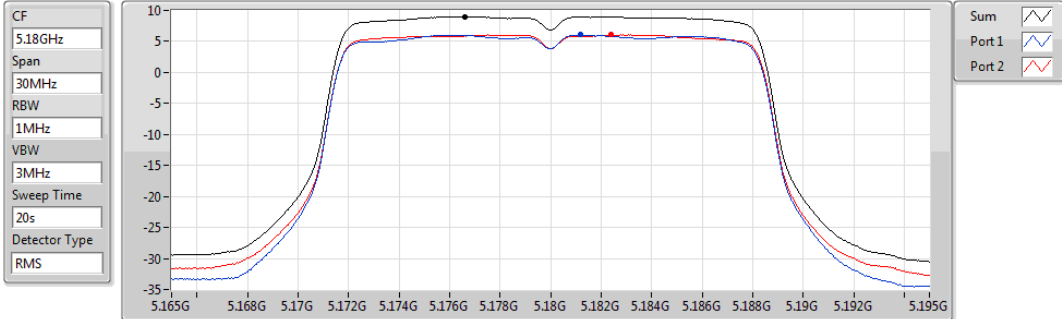

Sum	PD	Port 1	Port 2
(dBm/100kHz)	(dBm/100kHz)	(dBm/100kHz)	(dBm/100kHz)
8.96	8.96	6.07	6.08

802.11a_Nss1,(6Mbps)_2TX

PSD

5200MHz

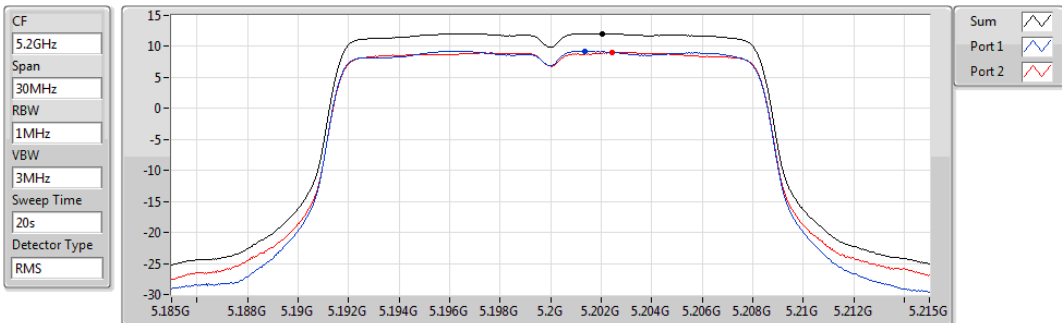

Sum	PD	Port 1	Port 2
(dBm/100kHz)	(dBm/100kHz)	(dBm/100kHz)	(dBm/100kHz)
12.05	12.05	9.27	9.02

802.11a_Nss1,(6Mbps)_2TX

PSD

5240MHz

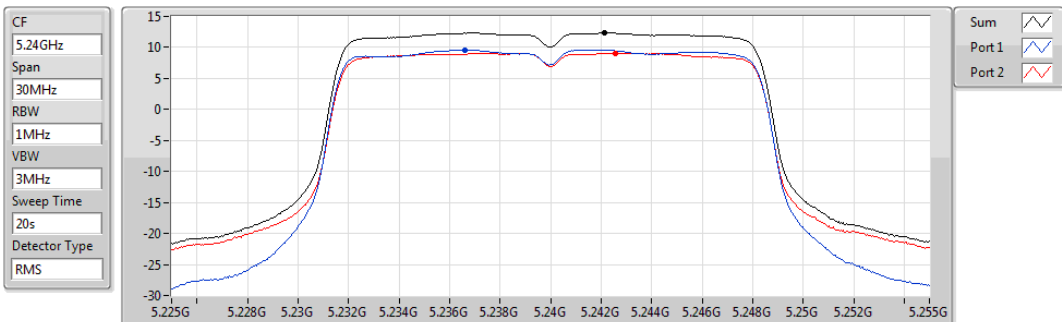

Sum	PD	Port 1	Port 2
(dBm/100kHz)	(dBm/100kHz)	(dBm/100kHz)	(dBm/100kHz)
12.33	12.33	9.62	9.11

802.11a_Nss1,(6Mbps)_2TX

PSD

5260MHz

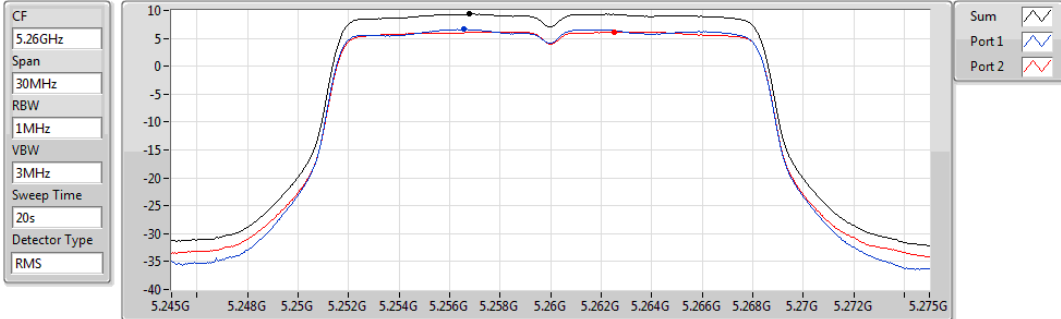

Sum	PD	Port 1	Port 2
(dBm/RBW)	(dBm/RBW)	(dBm/RBW)	(dBm/RBW)
9.34	9.34	6.60	6.19

802.11a_Nss1,(6Mbps)_2TX

PSD

5300MHz

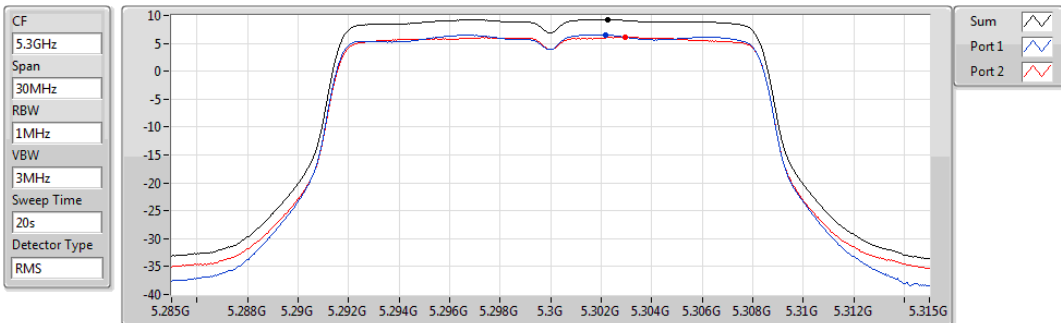

Sum	PD	Port 1	Port 2
(dBm/RBW)	(dBm/RBW)	(dBm/RBW)	(dBm/RBW)
9.27	9.27	6.48	6.06

802.11a_Nss1,(6Mbps)_2TX

PSD

5320MHz

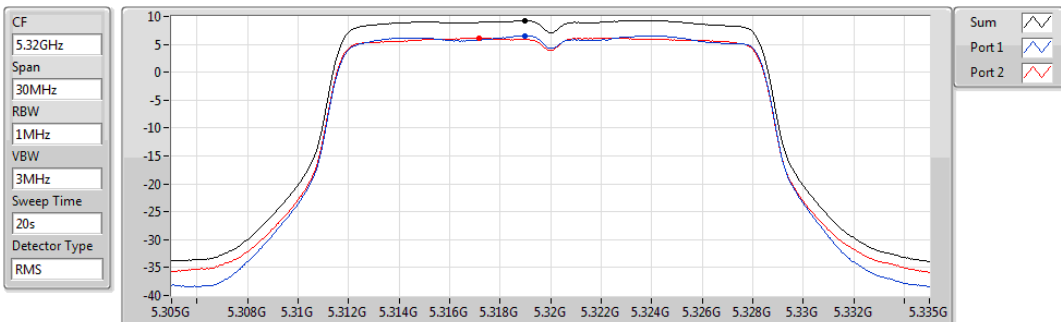

Sum	PD	Port 1	Port 2
(dBm/RBW)	(dBm/RBW)	(dBm/RBW)	(dBm/RBW)
9.24	9.24	6.57	6.15

802.11a_Nss1,(6Mbps)_2TX

PSD

5500MHz

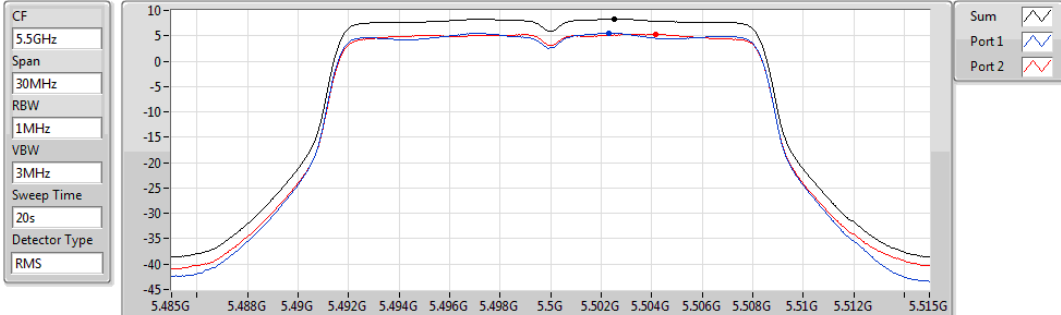

Sum	PD	Port 1	Port 2
(dBm/1MHz)	(dBm/1MHz)	(dBm/1MHz)	(dBm/1MHz)
8.35	8.35	5.57	5.23

802.11a_Nss1,(6Mbps)_2TX

PSD

5580MHz

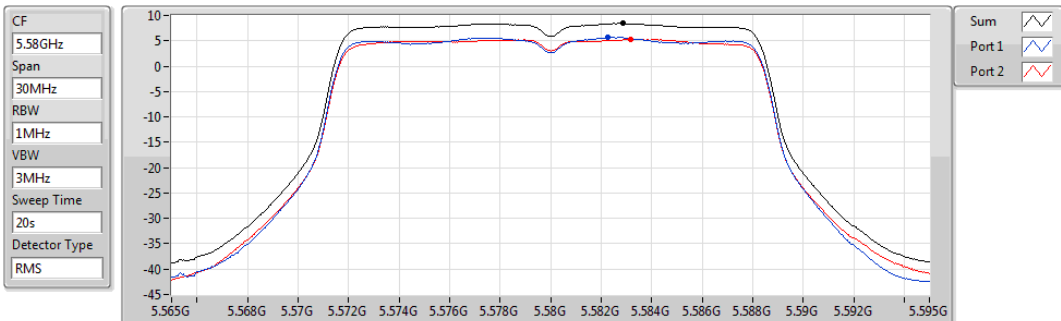

Sum	PD	Port 1	Port 2
(dBm/1MHz)	(dBm/1MHz)	(dBm/1MHz)	(dBm/1MHz)
8.43	8.43	5.70	5.24

802.11a_Nss1,(6Mbps)_2TX

PSD

5700MHz

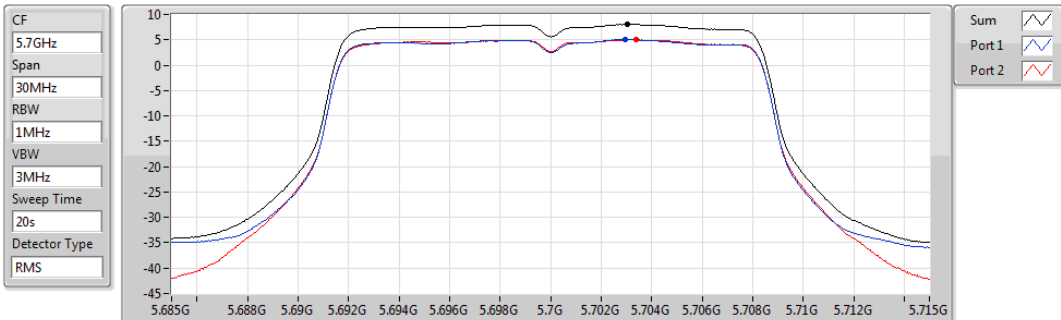

Sum	PD	Port 1	Port 2
(dBm/1MHz)	(dBm/1MHz)	(dBm/1MHz)	(dBm/1MHz)
8.02	8.02	5.05	4.98

802.11a_Nss1,(6Mbps)_2TX

PSD

5720MHz Straddle 5.47-5.725GHz

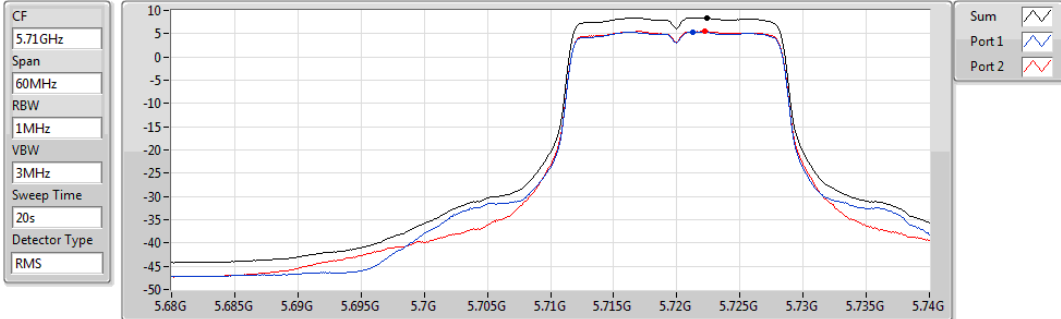

Sum	PD	Port 1	Port 2
(dBm/RBW)	(dBm/RBW)	(dBm/RBW)	(dBm/RBW)
8.40	8.40	5.31	5.52

802.11a_Nss1,(6Mbps)_2TX

PSD

5720MHz Straddle 5.725-5.85GHz

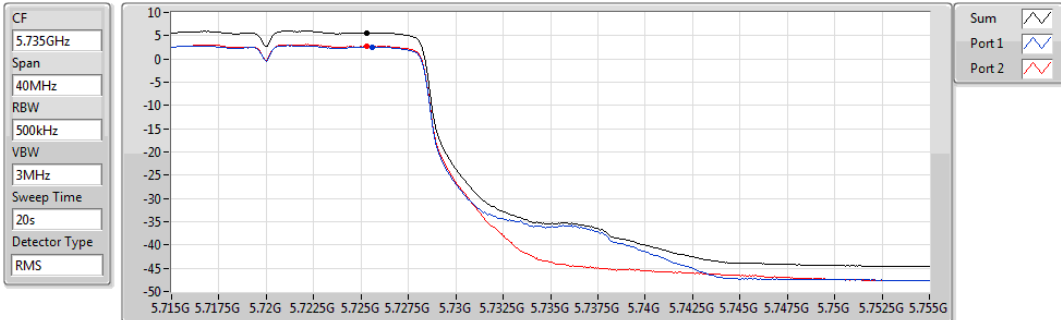

Sum	PD	Port 1	Port 2
(dBm/RBW)	(dBm/RBW)	(dBm/RBW)	(dBm/RBW)
5.65	5.65	2.59	2.69

802.11a_Nss1,(6Mbps)_2TX

PSD

5745MHz

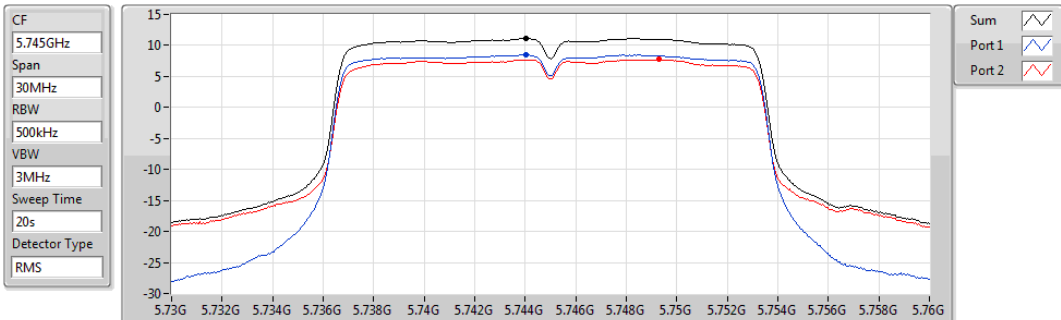

Sum	PD	Port 1	Port 2
(dBm/RBW)	(dBm/RBW)	(dBm/RBW)	(dBm/RBW)
11.09	11.09	8.46	7.72

802.11a_Nss1,(6Mbps)_2TX

PSD

5785MHz

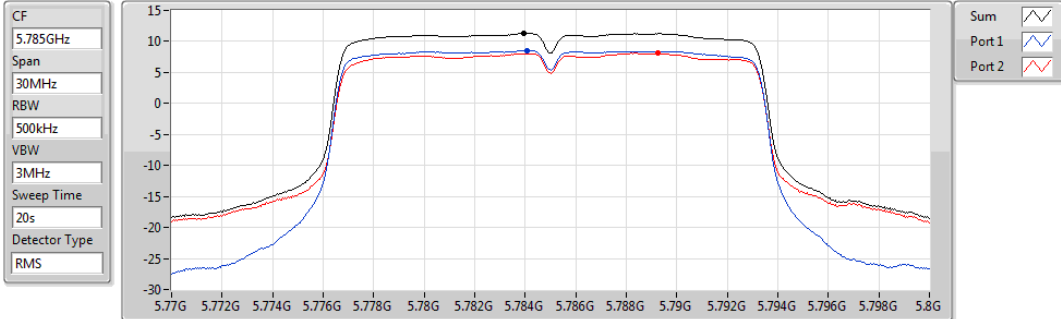

Sum	PD	Port 1	Port 2
(dBm/RBW)	(dBm/RBW)	(dBm/RBW)	(dBm/RBW)
11.31	11.31	8.55	8.09

802.11a_Nss1,(6Mbps)_2TX

PSD

5825MHz

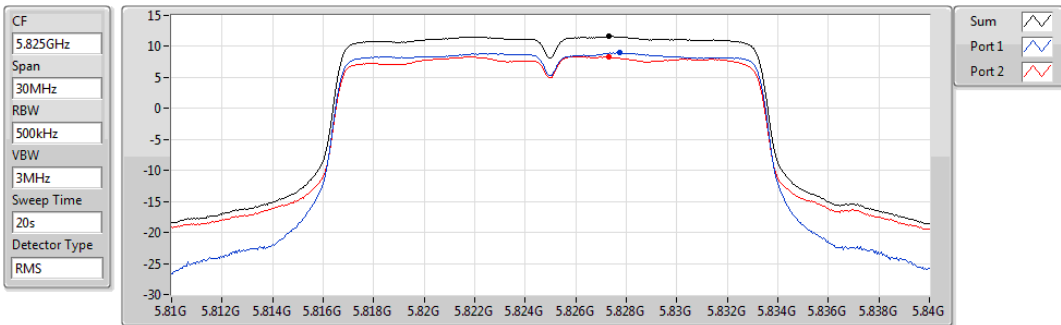

Sum	PD	Port 1	Port 2
(dBm/RBW)	(dBm/RBW)	(dBm/RBW)	(dBm/RBW)
11.65	11.65	8.96	8.33

802.11ax HEW20_Nss1,(MCS0)_2TX

PSD

5180MHz

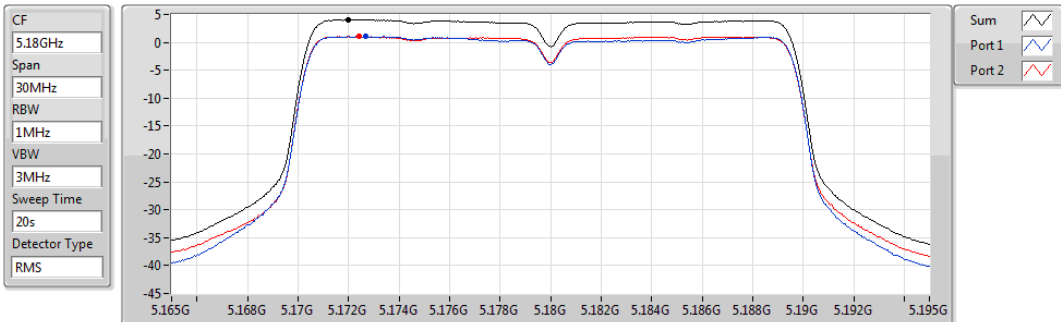

Sum	PD	Port 1	Port 2
(dBm/RBW)	(dBm/RBW)	(dBm/RBW)	(dBm/RBW)
4.03	4.03	1.06	1.03

802.11ax HEW20_Nss1,(MCS0)_2TX

PSD

5200MHz

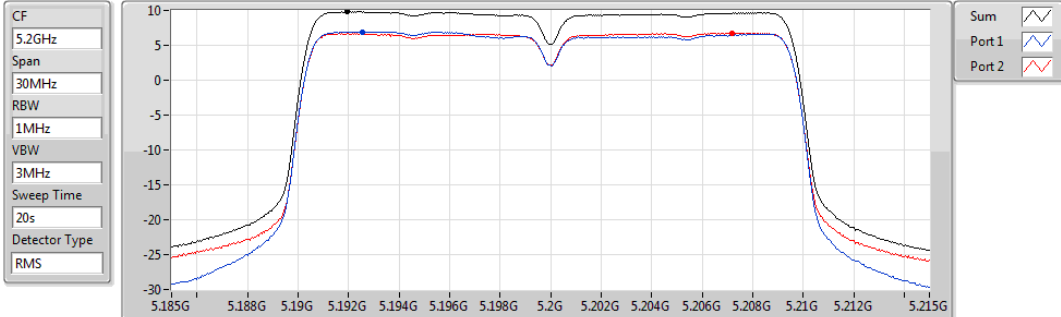

Sum	PD	Port 1	Port 2
(dBm/100kHz)	(dBm/100kHz)	(dBm/100kHz)	(dBm/100kHz)
9.79	9.79	6.95	6.73

802.11ax HEW20_Nss1,(MCS0)_2TX

PSD

5240MHz

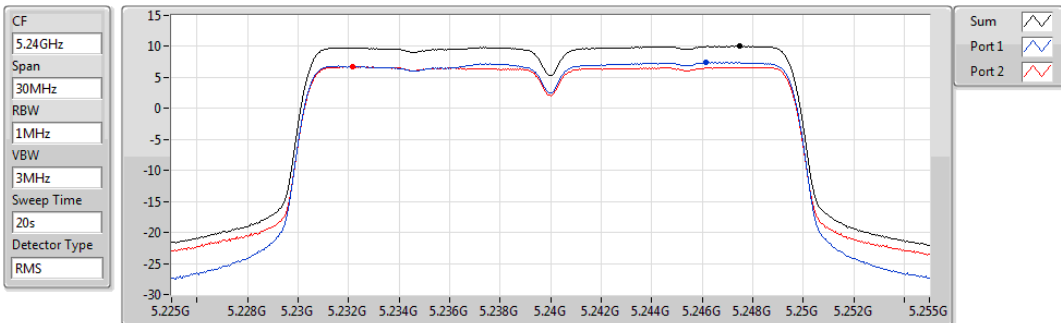

Sum	PD	Port 1	Port 2
(dBm/100kHz)	(dBm/100kHz)	(dBm/100kHz)	(dBm/100kHz)
10.04	10.04	7.41	6.74

802.11ax HEW20_Nss1,(MCS0)_2TX

PSD

5260MHz

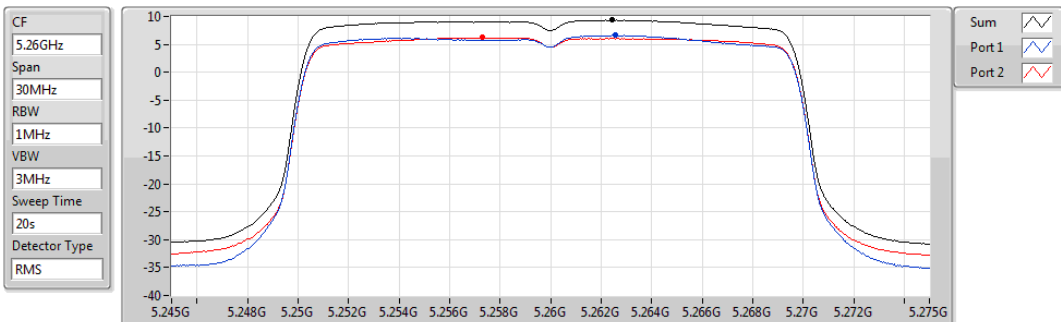

Sum	PD	Port 1	Port 2
(dBm/100kHz)	(dBm/100kHz)	(dBm/100kHz)	(dBm/100kHz)
9.33	9.33	6.59	6.21

802.11ax HEW20_Nss1,(MCS0)_2TX

PSD

5300MHz

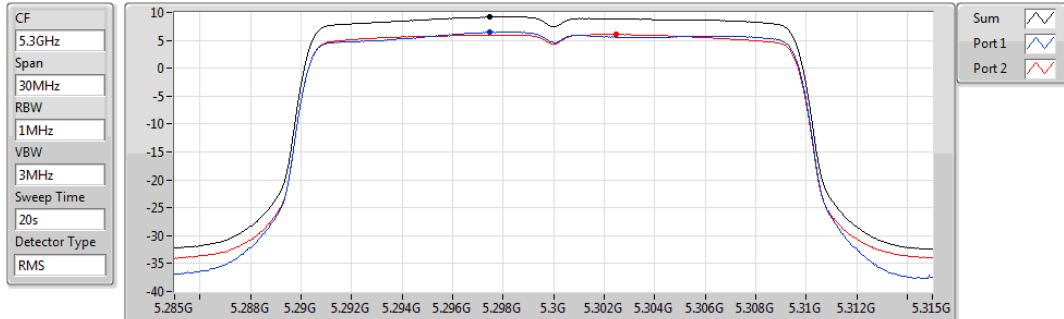

Sum	PD	Port 1	Port 2
(dBm/RBW)	(dBm/RBW)	(dBm/RBW)	(dBm/RBW)
9.20	9.20	6.49	6.06

802.11ax HEW20_Nss1,(MCS0)_2TX

PSD

5320MHz

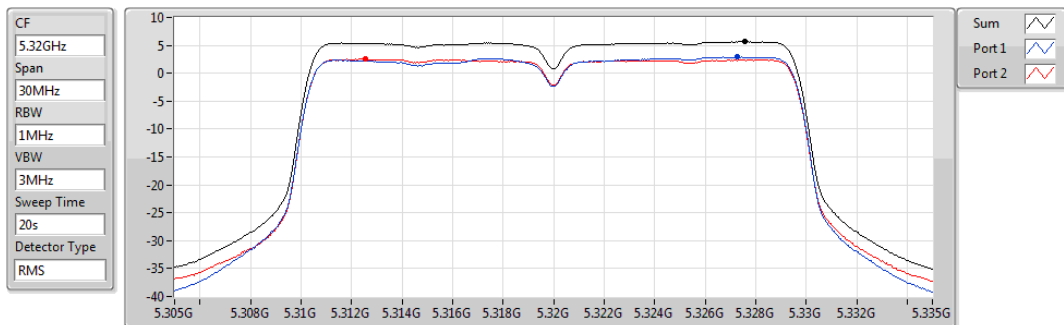

Sum	PD	Port 1	Port 2
(dBm/RBW)	(dBm/RBW)	(dBm/RBW)	(dBm/RBW)
5.63	5.63	2.90	2.53

802.11ax HEW20_Nss1,(MCS0)_2TX

PSD

5500MHz

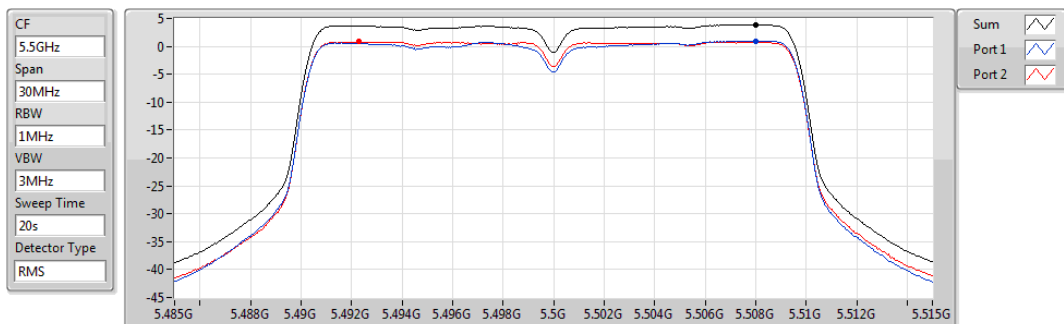

Sum	PD	Port 1	Port 2
(dBm/RBW)	(dBm/RBW)	(dBm/RBW)	(dBm/RBW)
3.87	3.87	0.98	0.83

802.11ax HEW20_Nss1,(MCS0)_2TX

PSD

5580MHz

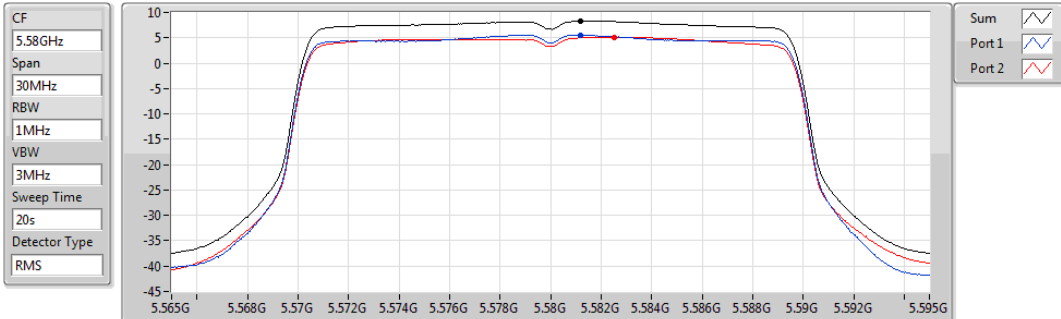

Sum	PD	Port 1	Port 2
(dBm/RBW)	(dBm/RBW)	(dBm/RBW)	(dBm/RBW)
8.31	8.31	5.59	5.14

802.11ax HEW20_Nss1,(MCS0)_2TX

PSD

5700MHz

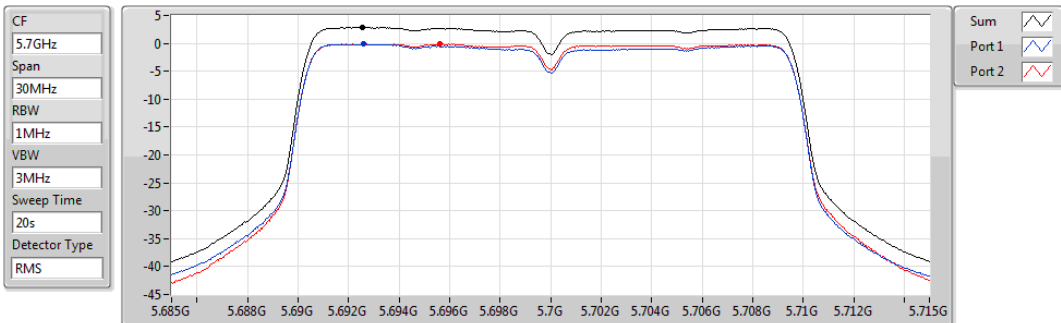

Sum	PD	Port 1	Port 2
(dBm/RBW)	(dBm/RBW)	(dBm/RBW)	(dBm/RBW)
2.83	2.83	-0.12	-0.15

802.11ax HEW20_Nss1,(MCS0)_2TX

PSD

5720MHz Straddle 5.47-5.725GHz

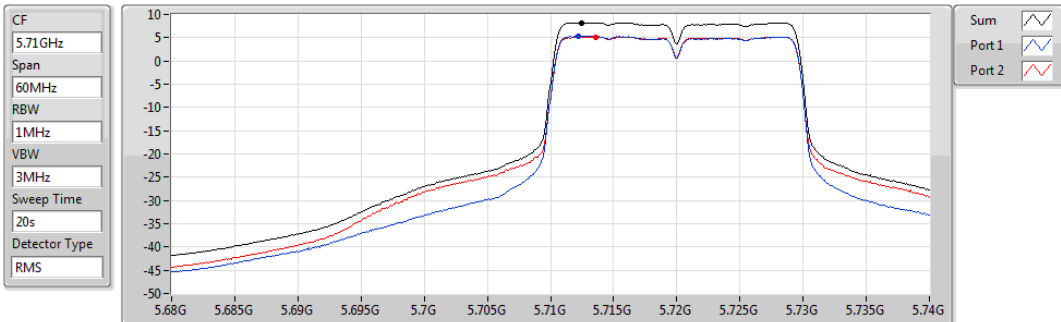

Sum	PD	Port 1	Port 2
(dBm/RBW)	(dBm/RBW)	(dBm/RBW)	(dBm/RBW)
8.24	8.24	5.33	5.18

802.11ax HEW20_Nss1,(MCS0)_2TX

PSD

5720MHz Straddle 5.725-5.85GHz

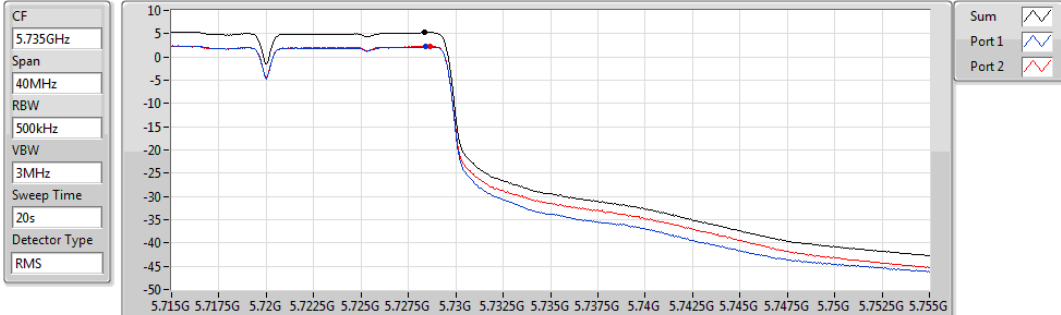

Sum	PD	Port 1	Port 2
(dBm/RBW)	(dBm/RBW)	(dBm/RBW)	(dBm/RBW)
5.27	5.27	2.24	2.30

802.11ax HEW20_Nss1,(MCS0)_2TX

PSD

5745MHz

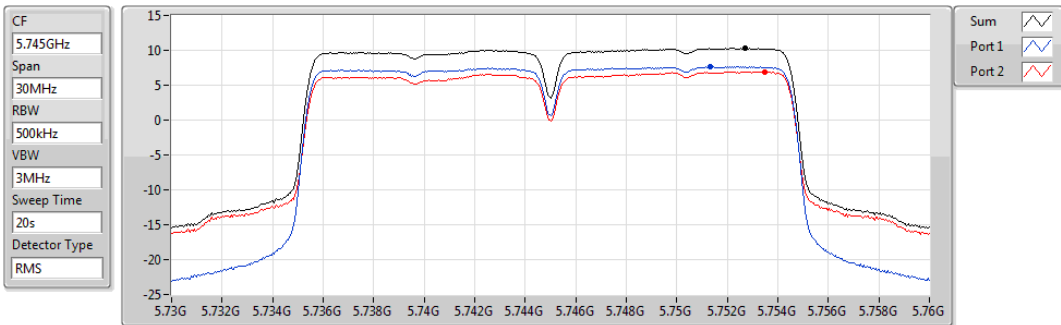

Sum	PD	Port 1	Port 2
(dBm/RBW)	(dBm/RBW)	(dBm/RBW)	(dBm/RBW)
10.29	10.29	7.63	6.92

802.11ax HEW20_Nss1,(MCS0)_2TX

PSD

5785MHz

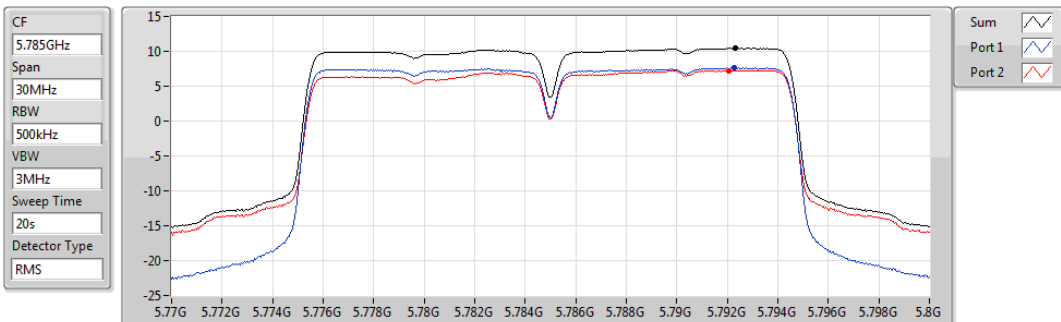

Sum	PD	Port 1	Port 2
(dBm/RBW)	(dBm/RBW)	(dBm/RBW)	(dBm/RBW)
10.44	10.44	7.65	7.25

802.11ax HEW20_Nss1,(MCS0)_2TX

PSD

5825MHz

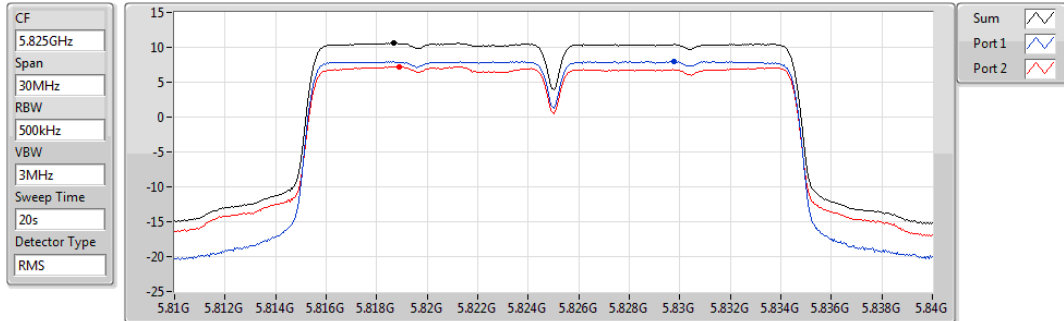

Sum	PD	Port 1	Port 2
(dBm/RBW)	(dBm/RBW)	(dBm/RBW)	(dBm/RBW)
10.58	10.58	7.98	7.19

802.11ax HEW40_Nss1,(MCS0)_2TX

PSD

5190MHz

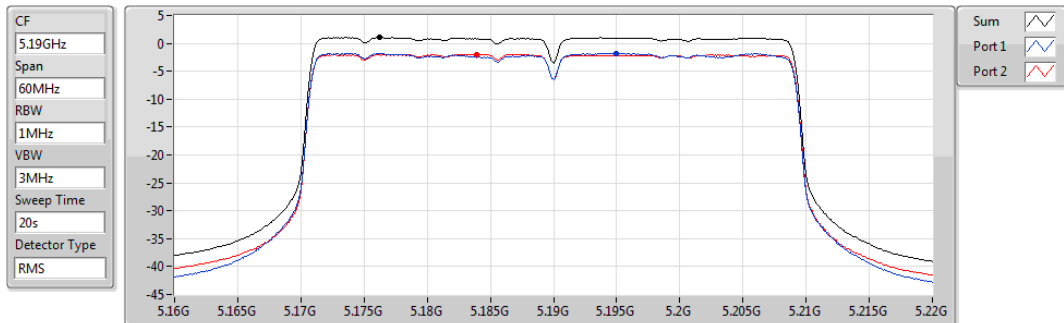

Sum	PD	Port 1	Port 2
(dBm/RBW)	(dBm/RBW)	(dBm/RBW)	(dBm/RBW)
1.06	1.06	-1.83	-1.95

802.11ax HEW40_Nss1,(MCS0)_2TX

PSD

5230MHz

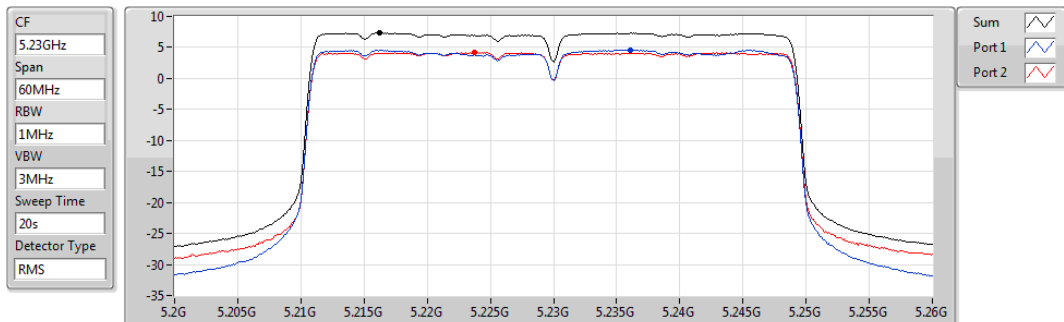

Sum	PD	Port 1	Port 2
(dBm/RBW)	(dBm/RBW)	(dBm/RBW)	(dBm/RBW)
7.33	7.33	4.57	4.20

802.11ax HEW40_Nss1,(MCS0)_2TX

PSD

5270MHz

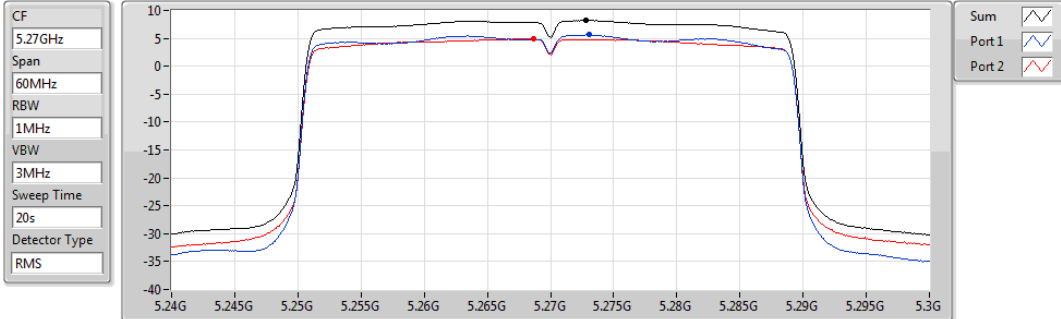

Sum	PD	Port 1	Port 2
(dBm/RBW)	(dBm/RBW)	(dBm/RBW)	(dBm/RBW)
8.19	8.19	5.63	4.90

802.11ax HEW40_Nss1,(MCS0)_2TX

PSD

5310MHz

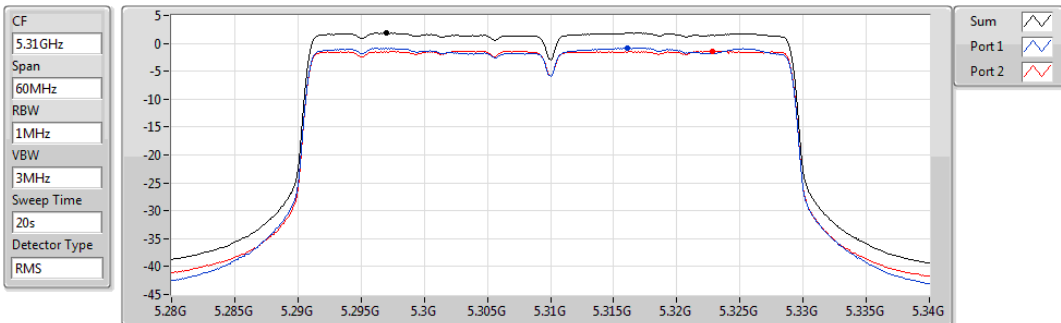

Sum	PD	Port 1	Port 2
(dBm/RBW)	(dBm/RBW)	(dBm/RBW)	(dBm/RBW)
1.82	1.82	-0.86	-1.38

802.11ax HEW40_Nss1,(MCS0)_2TX

PSD

5510MHz

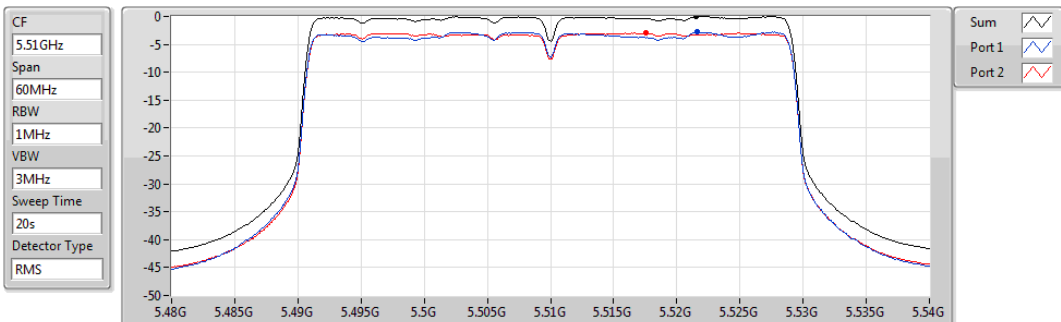

Sum	PD	Port 1	Port 2
(dBm/RBW)	(dBm/RBW)	(dBm/RBW)	(dBm/RBW)
-0.01	-0.01	-2.80	-2.98

802.11ax HEW40_Nss1,(MCS0)_2TX

PSD

5590MHz

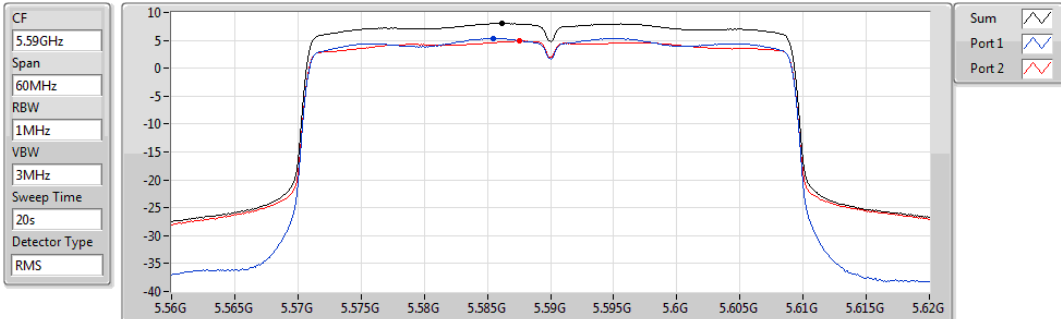

Sum	PD	Port 1	Port 2
(dBm/100kHz)	(dBm/100kHz)	(dBm/100kHz)	(dBm/100kHz)
8.03	8.03	5.33	4.85

802.11ax HEW40_Nss1,(MCS0)_2TX

PSD

5670MHz

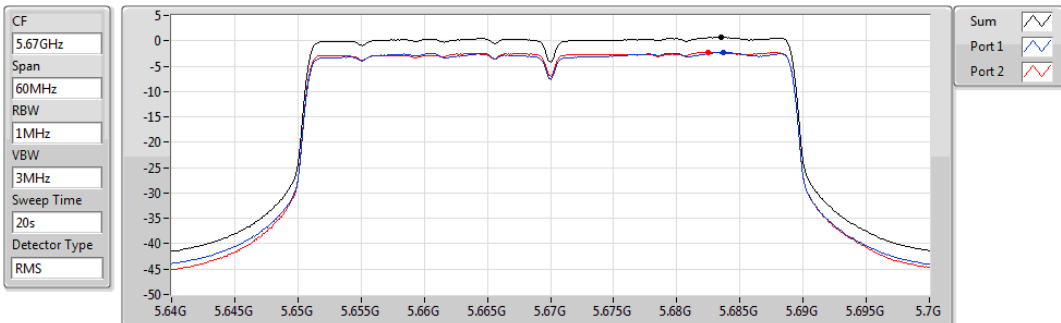

Sum	PD	Port 1	Port 2
(dBm/100kHz)	(dBm/100kHz)	(dBm/100kHz)	(dBm/100kHz)
0.70	0.70	-2.22	-2.29

802.11ax HEW40_Nss1,(MCS0)_2TX

PSD

5710MHz Straddle 5.47-5.725GHz

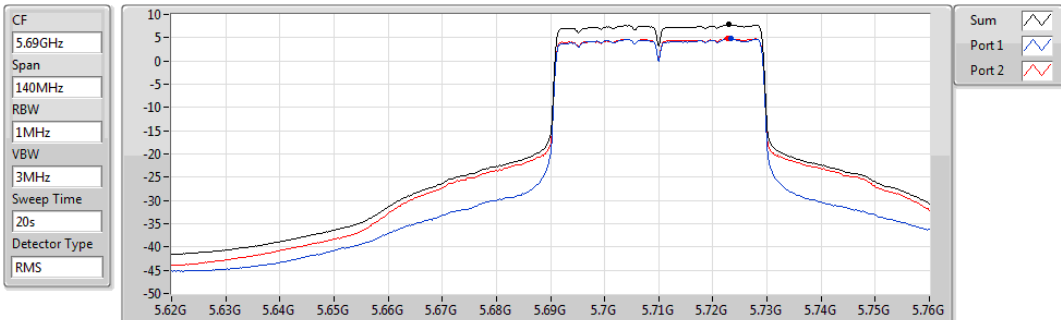

Sum	PD	Port 1	Port 2
(dBm/100kHz)	(dBm/100kHz)	(dBm/100kHz)	(dBm/100kHz)
7.79	7.79	4.74	4.86

802.11ax HEW40_Nss1,(MCS0)_2TX

PSD

5710MHz Straddle 5.725-5.85GHz

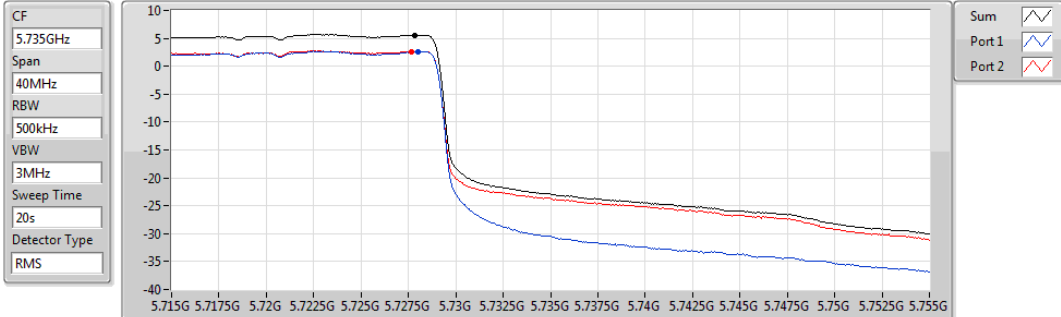

Sum	PD	Port 1	Port 2
(dBm/RBW)	(dBm/RBW)	(dBm/RBW)	(dBm/RBW)
5.60	5.60	2.57	2.66

802.11ax HEW40_Nss1,(MCS0)_2TX

PSD

5755MHz

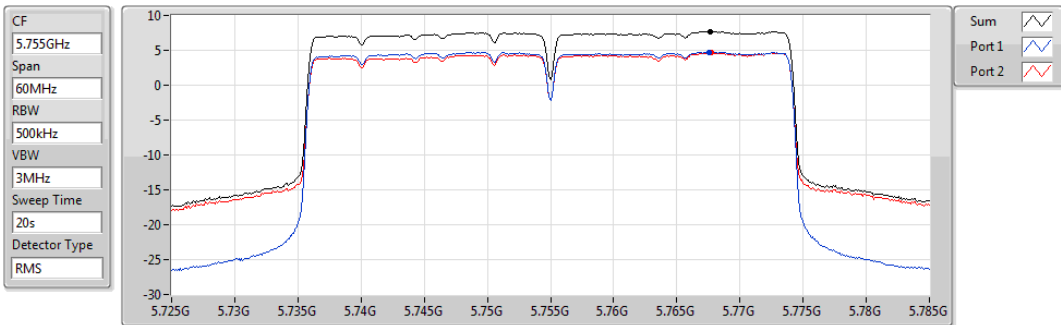

Sum	PD	Port 1	Port 2
(dBm/RBW)	(dBm/RBW)	(dBm/RBW)	(dBm/RBW)
7.71	7.71	4.75	4.64

802.11ax HEW40_Nss1,(MCS0)_2TX

PSD

5795MHz

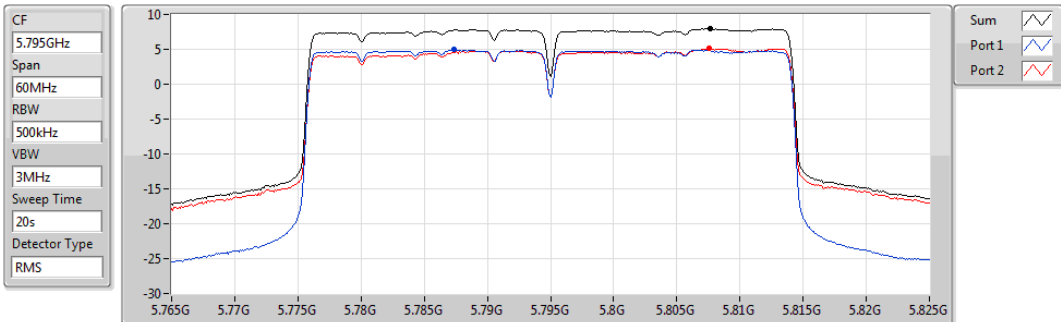

Sum	PD	Port 1	Port 2
(dBm/RBW)	(dBm/RBW)	(dBm/RBW)	(dBm/RBW)
7.96	7.96	4.93	5.12

802.11ax HEW80_Nss1,(MCS0)_2TX

PSD

5210MHz

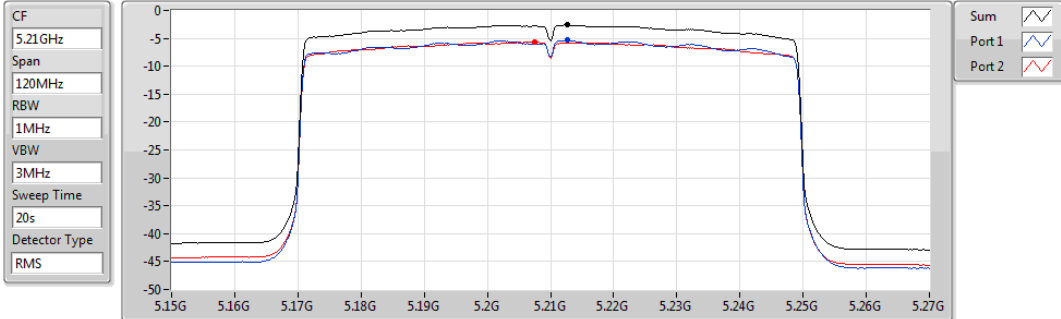

Sum	PD	Port 1	Port 2
(dBm/RBW)	(dBm/RBW)	(dBm/RBW)	(dBm/RBW)
-2.57	-2.57	-5.32	-5.62

802.11ax HEW80_Nss1,(MCS0)_2TX

PSD

5290MHz

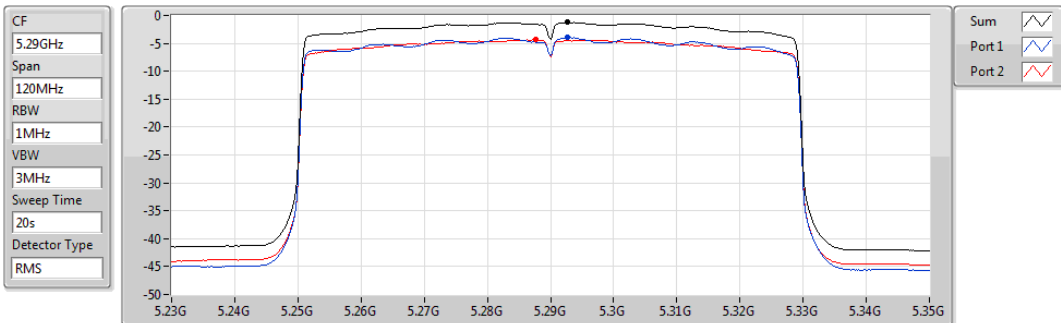

Sum	PD	Port 1	Port 2
(dBm/RBW)	(dBm/RBW)	(dBm/RBW)	(dBm/RBW)
-1.21	-1.21	-3.94	-4.35

802.11ax HEW80_Nss1,(MCS0)_2TX

PSD

5530MHz

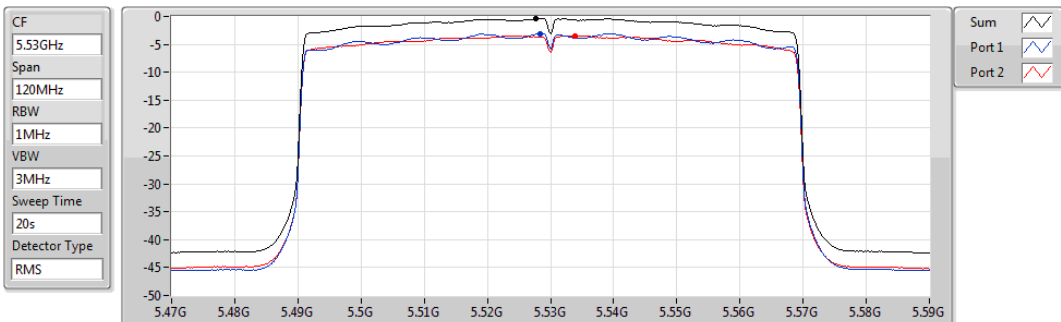

Sum	PD	Port 1	Port 2
(dBm/RBW)	(dBm/RBW)	(dBm/RBW)	(dBm/RBW)
-0.40	-0.40	-3.08	-3.43

802.11ax HEW80_Nss1,(MCS0)_2TX

PSD

5610MHz

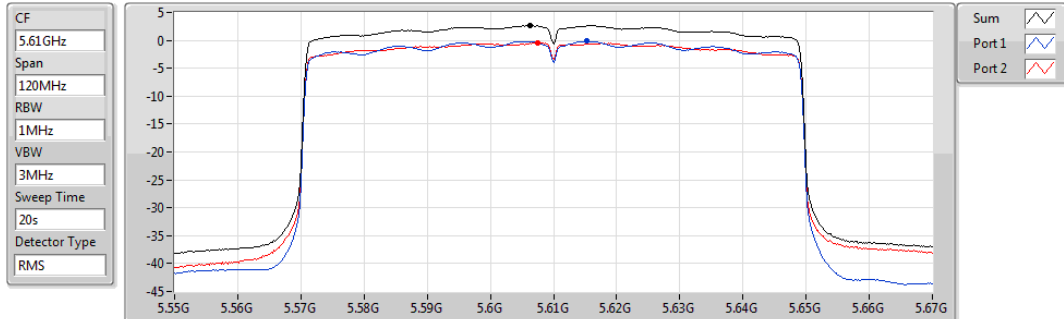

Sum	PD	Port 1	Port 2
(dBm/120MHz)	(dBm/120MHz)	(dBm/120MHz)	(dBm/120MHz)
2.62	2.62	-0.17	-0.44

802.11ax HEW80_Nss1,(MCS0)_2TX

PSD

5690MHz Straddle 5.47-5.725GHz

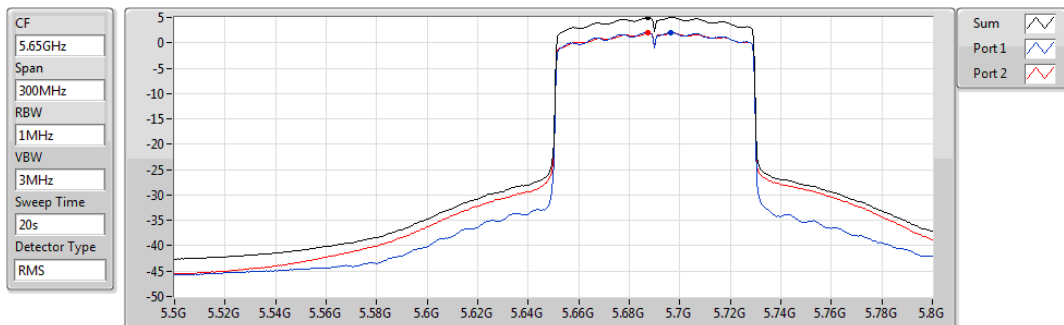

Sum	PD	Port 1	Port 2
(dBm/300MHz)	(dBm/300MHz)	(dBm/300MHz)	(dBm/300MHz)
4.98	4.98	2.09	1.89

802.11ax HEW80_Nss1,(MCS0)_2TX

PSD

5690MHz Straddle 5.725-5.85GHz

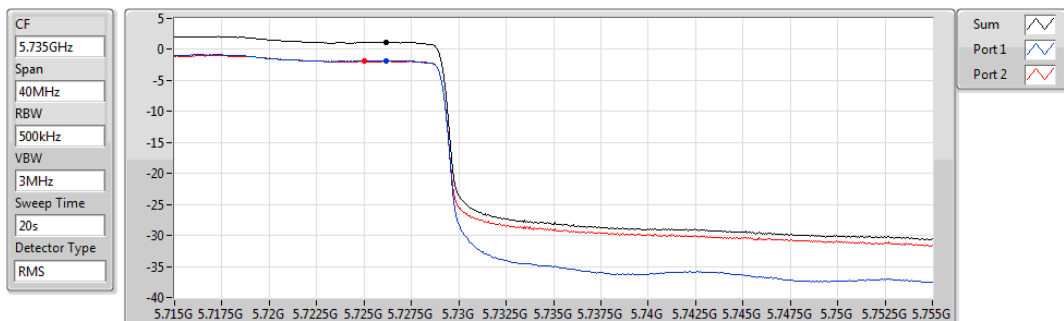

Sum	PD	Port 1	Port 2
(dBm/40MHz)	(dBm/40MHz)	(dBm/40MHz)	(dBm/40MHz)
1.16	1.16	-1.80	-1.88

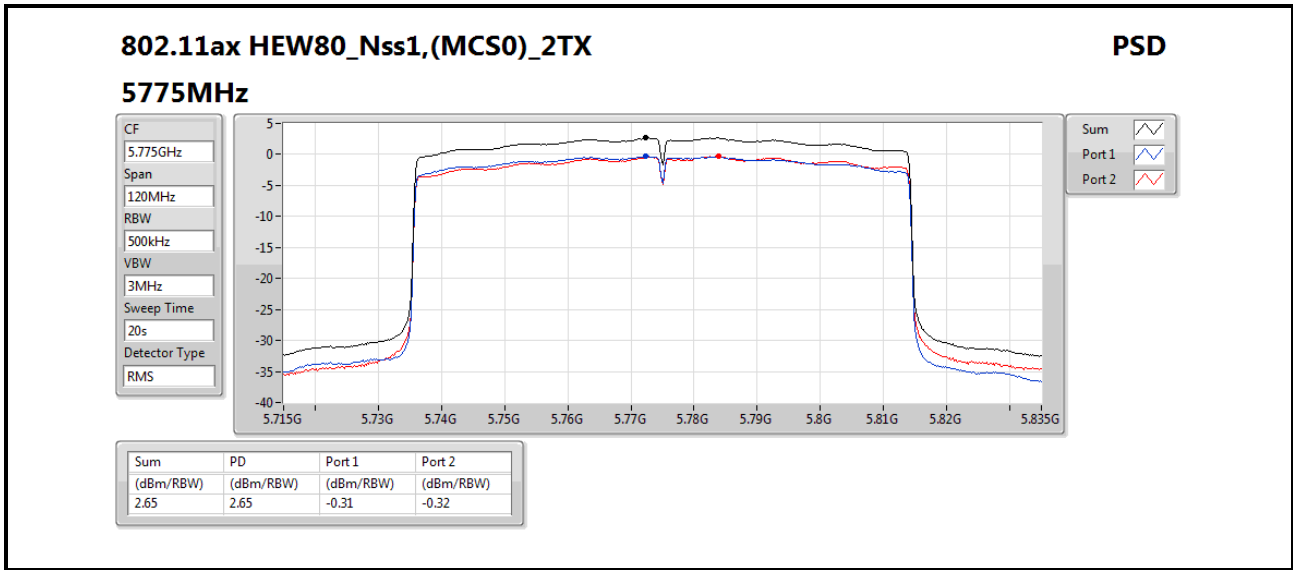

3.5 Transmitter Radiated and Band Edge Emissions

3.5.1 Limit of Transmitter Radiated and Band Edge Emissions

Restricted Band Emissions Limit			
Frequency Range (MHz)	Field Strength (uV/m)	Field Strength (dBuV/m)	Measure Distance (m)
0.009~0.490	2400/F(kHz)	48.5 - 13.8	300
0.490~1.705	24000/F(kHz)	33.8 - 23	30
1.705~30.0	30	29	30
30~88	100	40	3
88~216	150	43.5	3
216~960	200	46	3
Above 960	500	54	3

Note 1:
Qusai-Peak value is measured for frequency below 1GHz except for 9–90 kHz, 110–490 kHz frequency band. Peak and average value are measured for frequency above 1GHz. The limit on average radio frequency emission is as above table. The limit on peak radio frequency emissions is 20 dB above the maximum permitted average emission limit

Note 2:
Measurements may be performed at a distance other than what is specified provided. When performing measurements at a distance other than that specified, the results shall be extrapolated to the specified distance using an extrapolation factor as below, Frequency at or above 30 MHz: 20 dB/decade Frequency below 30 MHz: 40 dB/decade.

Un-restricted band emissions above 1GHz Limit	
Operating Band	Limit
5.15 - 5.25 GHz	e.i.r.p. -27 dBm [68.2 dBuV/m@3m]
5.25 - 5.35 GHz	e.i.r.p. -27 dBm [68.2 dBuV/m@3m]
5.47 - 5.725 GHz	e.i.r.p. -27 dBm [68.2 dBuV/m@3m]
5.725 - 5.850 GHz	All emissions shall be limited to a level of -27 dBm/MHz at 75 MHz or more above or below the band edge increasing linearly to 10 dBm/MHz at 25 MHz above or below the band edge, and from 25 MHz above or below the band edge increasing linearly to a level of 15.6 dBm/MHz at 5 MHz above or below the band edge, and from 5 MHz above or below the band edge increasing linearly to a level of 27 dBm/MHz at the band edge.

Note 1: Measurements may be performed at a distance other than the limit distance provided they are not performed in the near field and the emissions to be measured can be detected by the measurement equipment. When performing measurements at a distance other than that specified, the results shall be extrapolated to the specified distance using an extrapolation factor of 20 dB/decade (inverse of linear distance for field-strength measurements, inverse of linear distance-squared for power-density measurements).

3.5.2 Test Procedures

1. Measurement is made at a semi-anechoic chamber that incorporates a turntable allowing a EUT rotation of 360°. A continuously-rotating, remotely-controlled turntable is installed at the test site to support the EUT and facilitate determination of the direction of maximum radiation for each EUT emission frequency. The EUT is placed at test table. For emissions testing at or below 1 GHz, the table height is 80 cm above the reference ground plane. For emission measurements above 1 GHz, the table height is 1.5 m
2. Measurement is made with the antenna positioned in both the horizontal and vertical planes of polarization. The measurement antenna is varied in height (1m ~ 4m) above the reference ground plane to obtain the maximum signal strength. Distance between EUT and antenna is 3 m.
3. This investigation is performed with the EUT rotated 360°, the antenna height scanned between 1 m and 4 m, and the antenna rotated to repeat the measurements for both the horizontal and vertical antenna polarizations.

Note:

1. 120kHz measurement bandwidth of test receiver and Quasi-peak detector is for radiated emission below 1GHz.
2. RBW=1MHz, VBW=3MHz and Peak detector is for peak measured value of radiated emission above 1GHz.
3. RBW=1MHz, VBW=1/T and Peak detector is for average measured value of radiated emission above 1GHz.

3.5.3 Test Setup

Radiated Emissions below 1 GHz



Radiated Emissions above 1 GHz

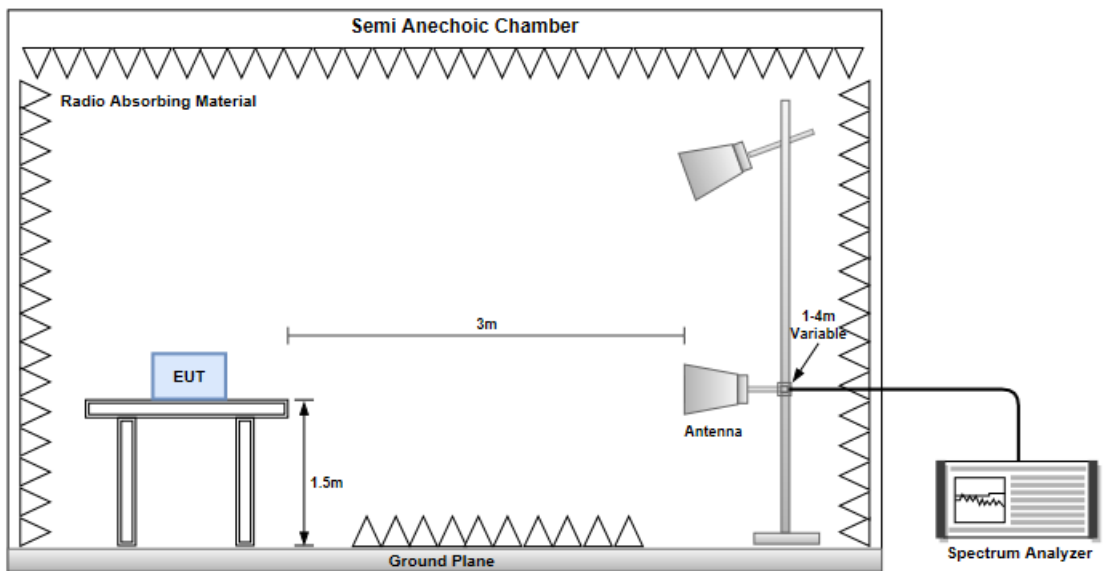

3.5.4 Transmitter Radiated Unwanted Emissions (Below 1GHz)

Modulation	11a	Test Freq. (MHz)	5240
Polarization	Horizontal	Test Configuration	1

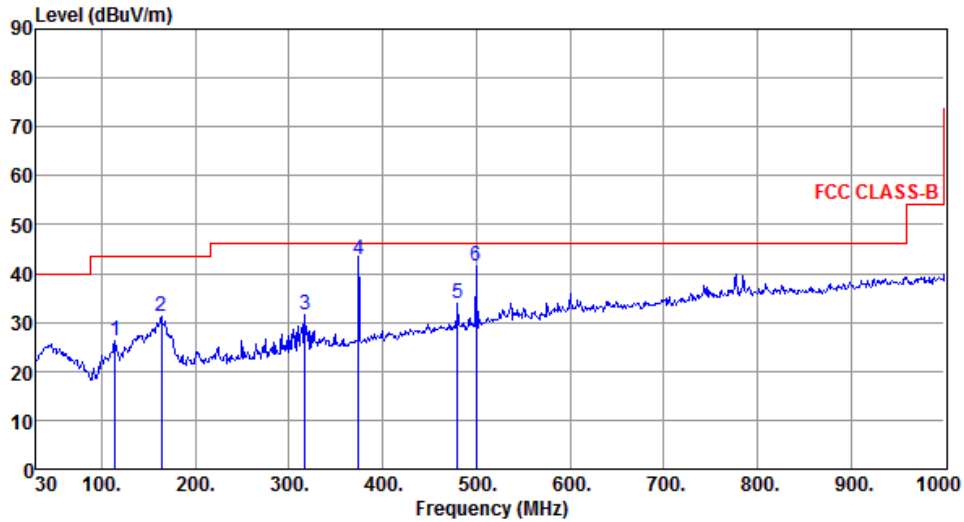

	Freq. MHz	Emission level dBUV/m	Limit dBUV/m	Margin dB	SA reading dBUV	Factor dB	Remark	ANT High cm	Turn Table deg
1	114.39	26.20	43.50	-17.30	37.78	-11.58	Peak	---	---
2	163.86	31.19	43.50	-12.31	39.98	-8.79	Peak	---	---
3	317.12	31.50	46.00	-14.50	39.20	-7.70	Peak	---	---
4	374.42	42.76	46.00	-3.24	49.02	-6.26	QP	100	188
5	480.08	33.93	46.00	-12.07	37.36	-3.43	Peak	---	---
6	499.48	41.41	46.00	-4.59	44.46	-3.05	Peak	---	---

Note 1: Emission Level (dBUV/m) = SA Reading (dBUV/m) + Factor* (dB)

*Factor includes antenna factor , cable loss and amplifier gain

Note 2: Margin (dB) = Emission level (dBUV/m) – Limit (dBUV/m).

Note 3: All spurious emissions below 30MHz are more than 20 dB below the limit.

Modulation	11a	Test Freq. (MHz)	5240
Polarization	Vertical	Test Configuration	1

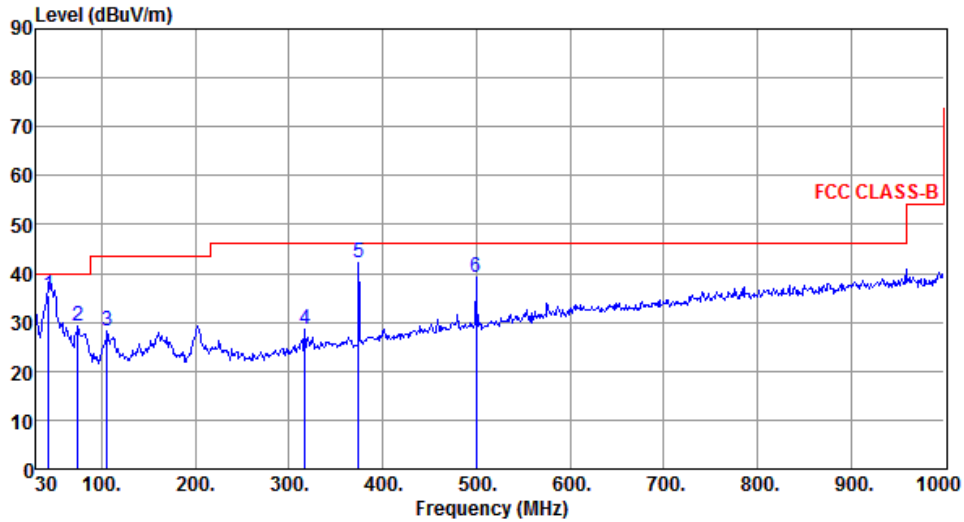

	Freq. MHz	Emission level dBuV/m	Limit dBuV/m	Margin dB	SA reading dBuV	Factor dB	Remark	ANT High cm	Turn Table deg
1	43.46	35.38	40.00	-4.62	44.26	-8.88	QP	100	184
2	74.62	29.06	40.00	-10.94	40.94	-11.88	Peak	---	---
3	105.66	28.15	43.50	-15.35	40.80	-12.65	Peak	---	---
4	317.12	28.47	46.00	-17.53	36.17	-7.70	Peak	---	---
5	374.35	42.10	46.00	-3.90	48.37	-6.27	Peak	---	---
6	499.48	39.13	46.00	-6.87	42.18	-3.05	Peak	---	---

Note 1: Emission Level (dBuV/m) = SA Reading (dBuV/m) + Factor* (dB)

*Factor includes antenna factor, cable loss and amplifier gain

Note 2: Margin (dB) = Emission level (dBuV/m) – Limit (dBuV/m).

Note 3: All spurious emissions below 30MHz are more than 20 dB below the limit.

Modulation	ax (HE40)	Test Freq. (MHz)	5795
Polarization	Horizontal	Test Configuration	1

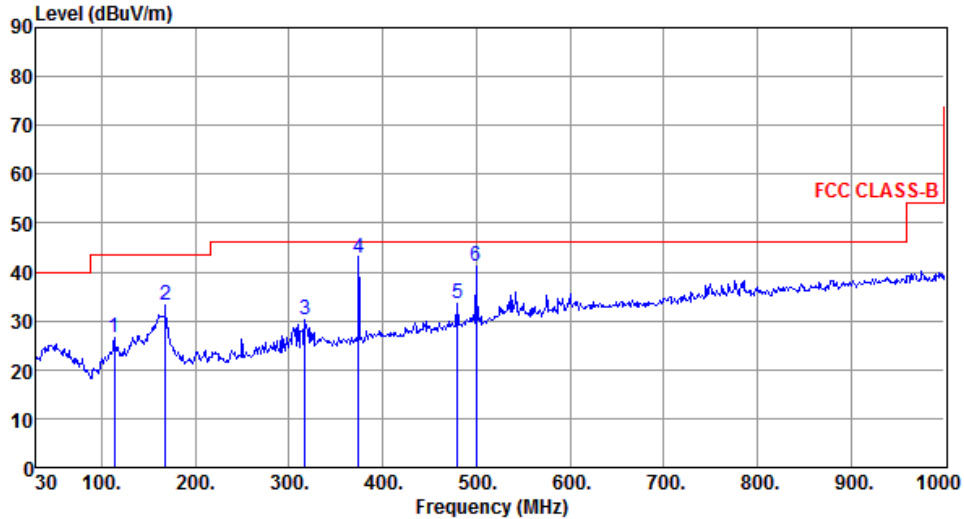

	Freq. MHz	Emission level dBuV/m	Limit dBuV/m	Margin dB	SA reading dBuV	Factor dB	Remark	ANT High cm	Turn Table deg
1	113.42	26.72	43.50	-16.78	38.41	-11.69	Peak	---	---
2	167.74	33.21	43.50	-10.29	42.18	-8.97	Peak	---	---
3	317.12	30.23	46.00	-15.77	37.93	-7.70	Peak	---	---
4	374.45	42.86	46.00	-3.14	49.12	-6.26	QP	100	189
5	480.08	33.60	46.00	-12.40	37.03	-3.43	Peak	---	---
6	499.48	41.11	46.00	-4.89	44.16	-3.05	Peak	---	---

Note 1: Emission Level (dBuV/m) = SA Reading (dBuV/m) + Factor* (dB)

*Factor includes antenna factor , cable loss and amplifier gain

Note 2: Margin (dB) = Emission level (dBuV/m) – Limit (dBuV/m).

Note 3: All spurious emissions below 30MHz are more than 20 dB below the limit.

Modulation	ax (HE40)	Test Freq. (MHz)	5795
Polarization	Vertical	Test Configuration	1

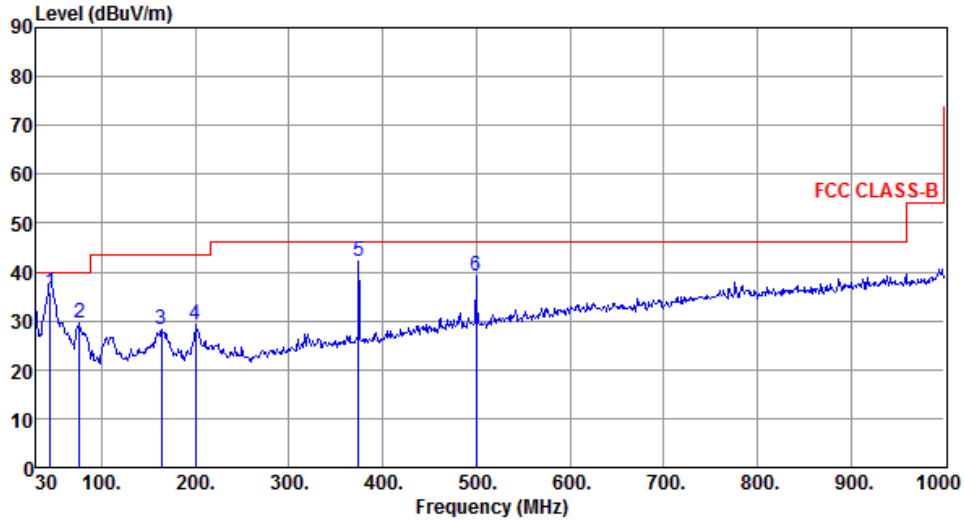

	Freq. MHz	Emission level dBUV/m	Limit dBUV/m	Margin dB	SA reading dBUV	Factor dB	Remark	ANT High cm	Turn Table deg
1	45.48	35.80	40.00	-4.20	44.46	-8.66	QP	100	18
2	76.56	29.56	40.00	-10.44	42.08	-12.52	Peak	---	---
3	163.86	28.21	43.50	-15.29	37.00	-8.79	Peak	---	---
4	199.75	29.06	43.50	-14.44	41.03	-11.97	Peak	---	---
5	374.35	42.02	46.00	-3.98	48.29	-6.27	Peak	---	---
6	499.48	39.24	46.00	-6.76	42.29	-3.05	Peak	---	---

Note 1: Emission Level (dBUV/m) = SA Reading (dBUV/m) + Factor* (dB)

*Factor includes antenna factor , cable loss and amplifier gain

Note 2: Margin (dB) = Emission level (dBUV/m) – Limit (dBUV/m).

Note 3: All spurious emissions below 30MHz are more than 20 dB below the limit.

Modulation	11a	Test Freq. (MHz)	5240
Polarization	Horizontal	Test Configuration	2

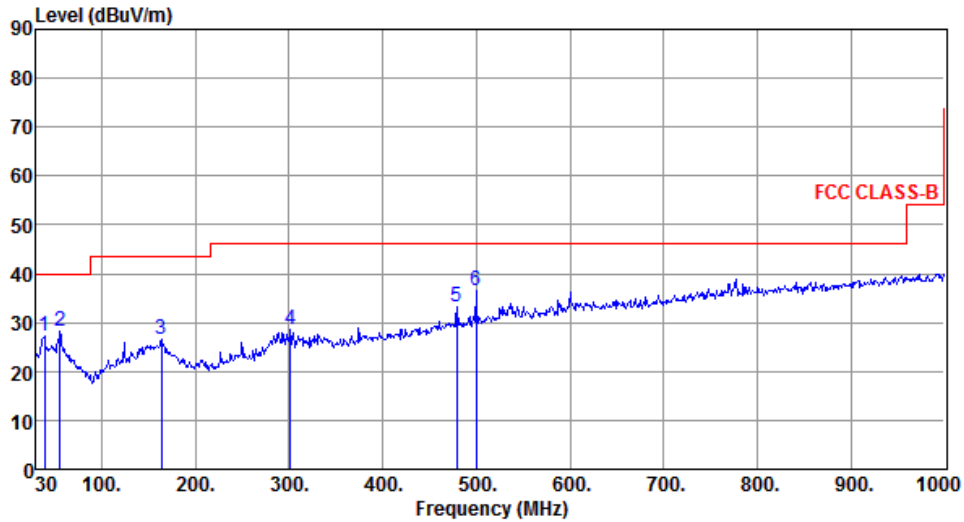

	Freq. MHz	Emission level dBuV/m	Limit dBuV/m	Margin dB	SA reading dBuV	Factor dB	Remark	ANT High cm	Turn Table deg
1	38.73	27.12	40.00	-12.88	36.45	-9.33	Peak	---	---
2	55.22	28.11	40.00	-11.89	37.02	-8.91	Peak	---	---
3	163.86	26.64	43.50	-16.86	35.43	-8.79	Peak	---	---
4	301.60	28.53	46.00	-17.47	36.83	-8.30	Peak	---	---
5	479.11	33.16	46.00	-12.84	36.59	-3.43	Peak	---	---
6	499.48	36.48	46.00	-9.52	39.53	-3.05	Peak	---	---

Note 1: Emission Level (dBuV/m) = SA Reading (dBuV/m) + Factor* (dB)

*Factor includes antenna factor, cable loss and amplifier gain

Note 2: Margin (dB) = Emission level (dBuV/m) – Limit (dBuV/m).

Note 3: All spurious emissions below 30MHz are more than 20 dB below the limit.

Modulation	11a	Test Freq. (MHz)	5240
Polarization	Vertical	Test Configuration	2

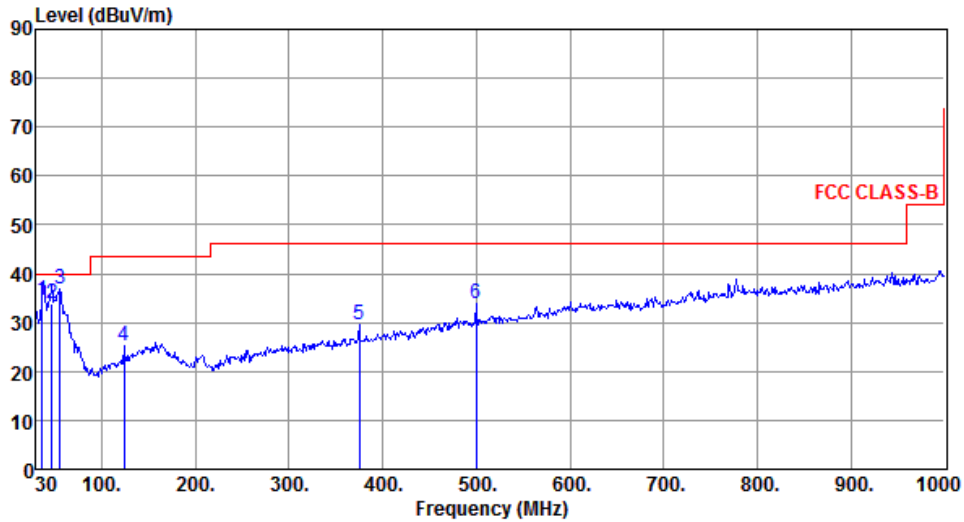

	Freq. MHz	Emission level dBuV/m	Limit dBuV/m	Margin dB	SA reading dBuV	Factor dB	Remark	ANT High cm	Turn Table deg
1	36.45	34.51	40.00	-5.49	44.23	-9.72	QP	100	356
2	46.58	33.97	40.00	-6.03	42.58	-8.61	QP	100	354
3	55.22	36.79	40.00	-3.21	45.70	-8.91	Peak	---	---
4	124.09	25.30	43.50	-18.20	35.99	-10.69	Peak	---	---
5	375.32	29.70	46.00	-16.30	35.93	-6.23	Peak	---	---
6	499.48	33.96	46.00	-12.04	37.01	-3.05	Peak	---	---

Note 1: Emission Level (dBuV/m) = SA Reading (dBuV/m) + Factor* (dB)

*Factor includes antenna factor, cable loss and amplifier gain

Note 2: Margin (dB) = Emission level (dBuV/m) – Limit (dBuV/m).

Note 3: All spurious emissions below 30MHz are more than 20 dB below the limit.

Modulation	ax (HE40)	Test Freq. (MHz)	5795
Polarization	Horizontal	Test Configuration	2

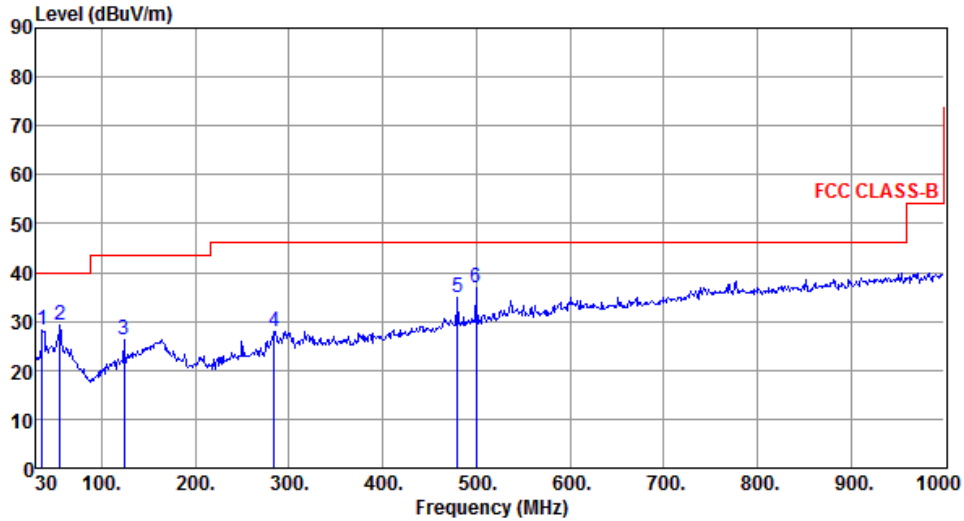

	Freq. MHz	Emission level dBuV/m	Limit dBuV/m	Margin dB	SA reading dBuV	Factor dB	Remark	ANT High cm	Turn Table deg
1	36.79	28.22	40.00	-11.78	37.94	-9.72	Peak	---	---
2	55.22	29.14	40.00	-10.86	38.05	-8.91	Peak	---	---
3	124.09	26.21	43.50	-17.29	36.90	-10.69	Peak	---	---
4	284.14	27.87	46.00	-18.13	36.59	-8.72	Peak	---	---
5	480.08	35.01	46.00	-10.99	38.44	-3.43	Peak	---	---
6	499.48	36.72	46.00	-9.28	39.77	-3.05	Peak	---	---

Note 1: Emission Level (dBuV/m) = SA Reading (dBuV/m) + Factor* (dB)

*Factor includes antenna factor , cable loss and amplifier gain

Note 2: Margin (dB) = Emission level (dBuV/m) – Limit (dBuV/m).

Note 3: All spurious emissions below 30MHz are more than 20 dB below the limit.

Modulation	ax (HE40)	Test Freq. (MHz)	5795
Polarization	Vertical	Test Configuration	2

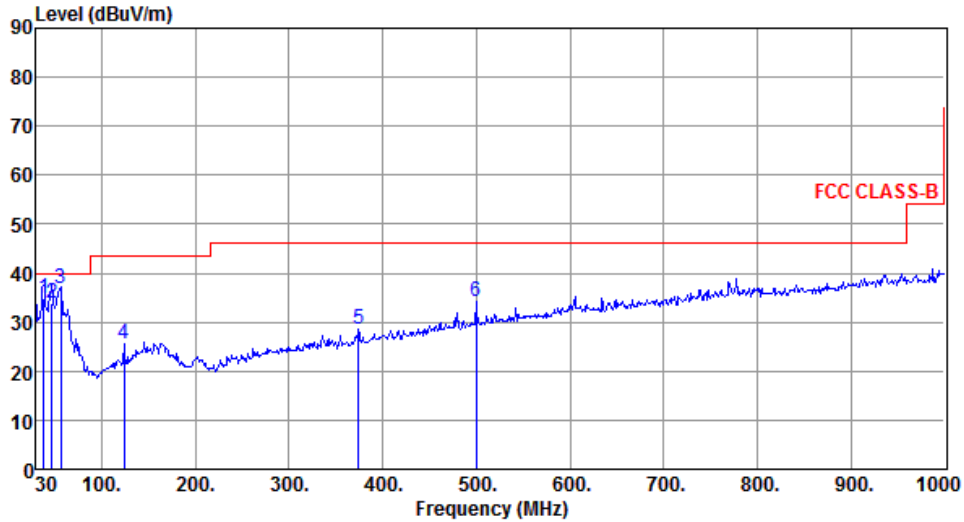

	Freq. MHz	Emission level dBuV/m	Limit dBuV/m	Margin dB	SA reading dBuV	Factor dB	Remark	ANT High cm	Turn Table deg
1	38.47	34.93	40.00	-5.07	44.28	-9.35	QP	100	352
2	46.55	33.94	40.00	-6.06	42.54	-8.60	QP	100	358
3	56.19	36.95	40.00	-3.05	45.80	-8.85	Peak	---	---
4	124.09	25.61	43.50	-17.89	36.30	-10.69	Peak	---	---
5	374.35	28.63	46.00	-17.37	34.90	-6.27	Peak	---	---
6	499.48	34.12	46.00	-11.88	37.17	-3.05	Peak	---	---

Note 1: Emission Level (dBuV/m) = SA Reading (dBuV/m) + Factor* (dB)

*Factor includes antenna factor , cable loss and amplifier gain

Note 2: Margin (dB) = Emission level (dBuV/m) – Limit (dBuV/m).

Note 3: All spurious emissions below 30MHz are more than 20 dB below the limit.

3.5.1 Transmitter Radiated Unwanted Emissions (Above 1GHz) for 11a

Modulation	11a	Test Freq. (MHz)	5180
Polarization	Horizontal	Test Configuration	1

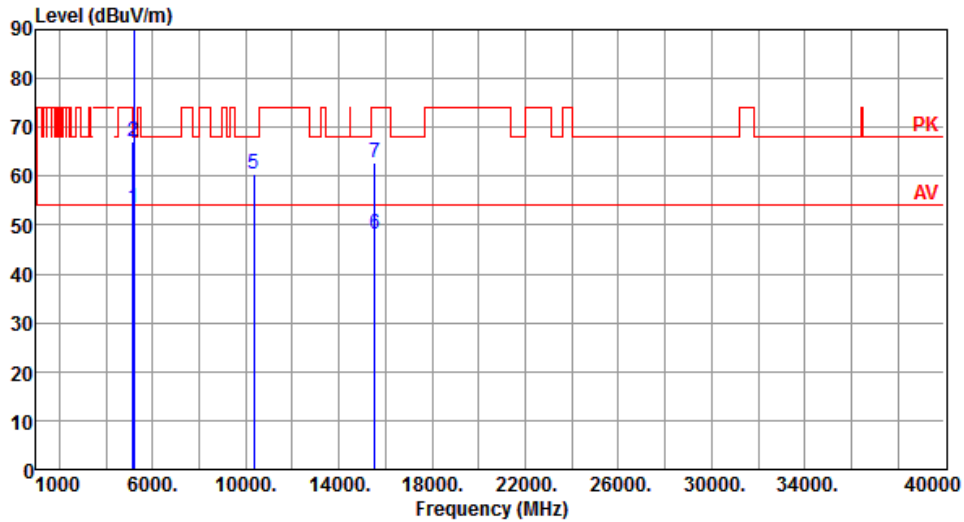

	Freq. MHz	Emission level dBuV/m	Limit dBuV/m	Margin dB	SA reading dBuV	Factor dB	Remark	ANT High cm	Turn Table deg
1	5150.00	53.56	54.00	-0.44	46.44	7.12	Average	176	340
2	5150.00	67.15	74.00	-6.85	60.03	7.12	Peak	176	340
3 *	5180.00	108.17			101.17	7.00	Average	176	340
4 *	5180.00	119.05			112.05	7.00	Peak	176	340
5	10360.00	60.52	68.20	-7.68	44.25	16.27	Peak	100	122
6	15540.00	48.25	54.00	-5.75	30.84	17.41	Average	100	205
7	15540.00	62.83	74.00	-11.17	45.42	17.41	Peak	100	205

Note 1: Emission Level (dBuV/m) = SA Reading (dBuV/m) + Factor* (dB)

*Factor includes antenna factor , cable loss and amplifier gain

Note 2: Margin (dB) = Emission level (dBuV/m) – Limit (dBuV/m).

Note 3: "*" is Peak / Average value of fundamental frequency

Modulation	11a	Test Freq. (MHz)	5180
Polarization	Vertical	Test Configuration	1

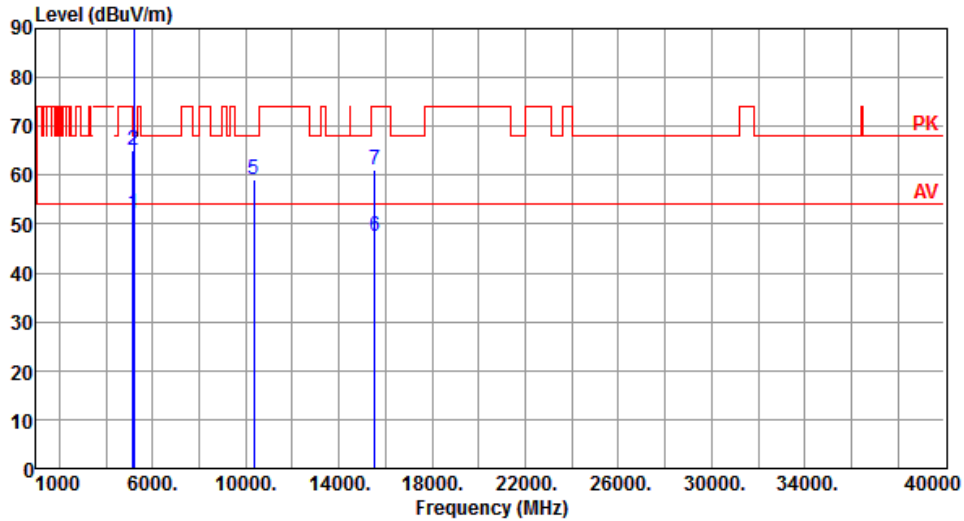

	Freq. MHz	Emission level dBUV/m	Limit dBUV/m	Margin dB	SA reading dBUV	Factor dB	Remark	ANT High cm	Turn Table deg
1	5150.00	51.97	54.00	-2.03	44.85	7.12	Average	218	321
2	5150.00	65.24	74.00	-8.76	58.12	7.12	Peak	218	321
3 *	5180.00	107.63			100.63	7.00	Average	218	321
4 *	5180.00	118.04			111.04	7.00	Peak	218	321
5	10360.00	59.27	68.20	-8.93	43.00	16.27	Peak	225	24
6	15540.00	47.63	54.00	-6.37	30.22	17.41	Average	286	204
7	15540.00	61.04	74.00	-12.96	43.63	17.41	Peak	286	204

Note 1: Emission Level (dBUV/m) = SA Reading (dBUV/m) + Factor* (dB)

*Factor includes antenna factor , cable loss and amplifier gain

Note 2: Margin (dB) = Emission level (dBUV/m) – Limit (dBUV/m).

Note 3: "*" is Peak / Average value of fundamental frequency

Modulation	11a	Test Freq. (MHz)	5200
Polarization	Horizontal	Test Configuration	1

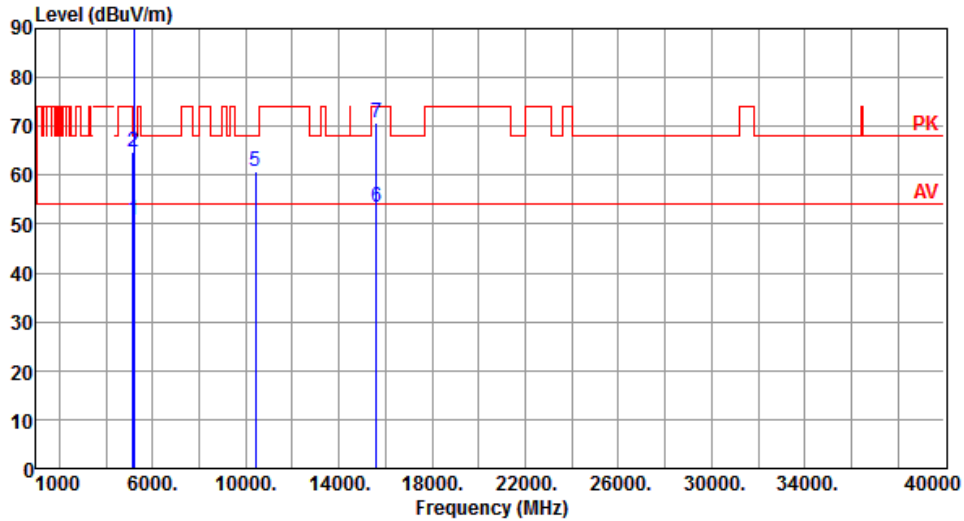

	Freq. MHz	Emission level dBuV/m	Limit dBuV/m	Margin dB	SA reading dBuV	Factor dB	Remark	ANT High cm	Turn Table deg
1	5150.00	50.67	54.00	-3.33	43.55	7.12	Average	185	345
2	5150.00	64.63	74.00	-9.37	57.51	7.12	Peak	185	345
3 *	5200.00	111.88			104.95	6.93	Average	185	345
4 *	5200.00	120.96			114.03	6.93	Peak	185	345
5	10400.00	60.63	68.20	-7.57	44.25	16.38	Peak	100	125
6	15600.00	53.55	54.00	-0.45	36.18	17.37	Average	300	239
7	15600.00	70.81	74.00	-3.19	53.44	17.37	Peak	300	239

Note 1: Emission Level (dBuV/m) = SA Reading (dBuV/m) + Factor* (dB)

*Factor includes antenna factor , cable loss and amplifier gain

Note 2: Margin (dB) = Emission level (dBuV/m) – Limit (dBuV/m).

Note 3: "*" is Peak / Average value of fundamental frequency

Modulation	11a	Test Freq. (MHz)	5200
Polarization	Vertical	Test Configuration	1

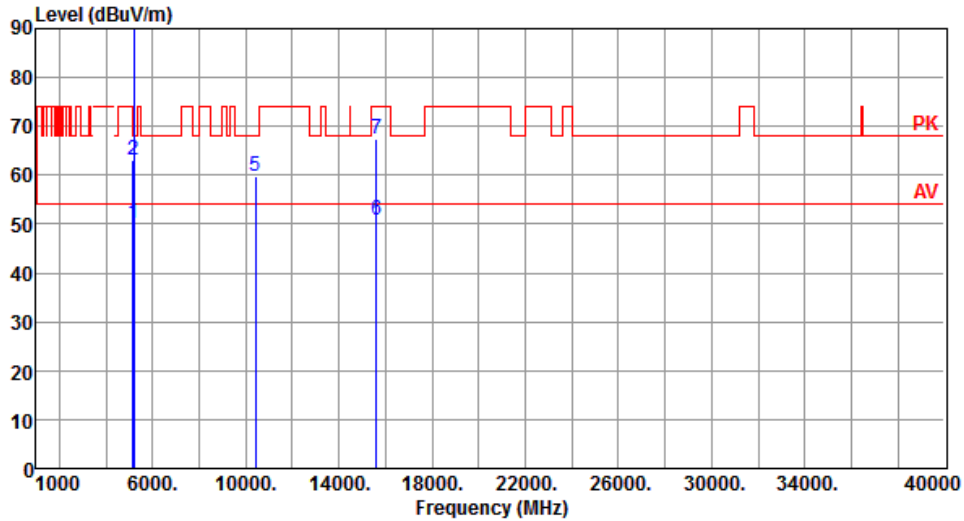

	Freq. MHz	Emission level dBuV/m	Limit dBuV/m	Margin dB	SA reading dBuV	Factor dB	Remark	ANT High cm	Turn Table deg
1	5150.00	50.08	54.00	-3.92	42.96	7.12	Average	201	326
2	5150.00	62.97	74.00	-11.03	55.85	7.12	Peak	201	326
3 *	5200.00	110.81			103.88	6.93	Average	201	326
4 *	5200.00	120.78			113.85	6.93	Peak	201	326
5	10400.00	59.65	68.20	-8.55	43.27	16.38	Peak	266	20
6	15600.00	50.92	54.00	-3.08	33.55	17.37	Average	289	206
7	15600.00	67.30	74.00	-6.70	49.93	17.37	Peak	289	206

Note 1: Emission Level (dBuV/m) = SA Reading (dBuV/m) + Factor* (dB)

*Factor includes antenna factor, cable loss and amplifier gain

Note 2: Margin (dB) = Emission level (dBuV/m) – Limit (dBuV/m).

Note 3: "*" is Peak / Average value of fundamental frequency

Modulation	11a	Test Freq. (MHz)	5240
Polarization	Horizontal	Test Configuration	1

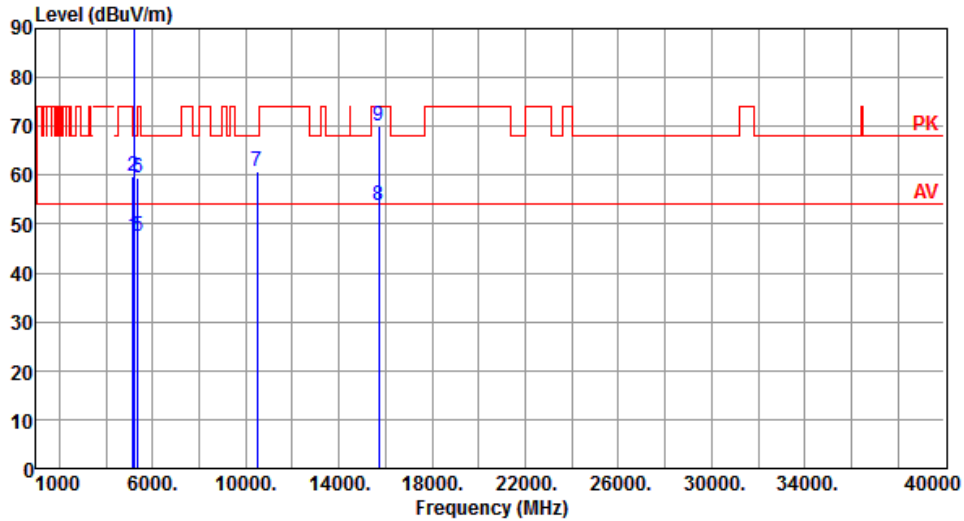

	Freq. MHz	Emission level dBUV/m	Limit dBUV/m	Margin dB	SA reading dBUV	Factor dB	Remark	ANT High cm	Turn Table deg
1	5150.00	47.62	54.00	-6.38	40.50	7.12	Average	188	345
2	5150.00	59.67	74.00	-14.33	52.55	7.12	Peak	188	345
3 *	5240.00	112.18			105.38	6.80	Average	188	345
4 *	5240.00	121.56			114.76	6.80	Peak	188	345
5	5350.00	47.38	54.00	-6.62	40.53	6.85	Average	188	345
6	5350.00	59.36	74.00	-14.64	52.51	6.85	Peak	188	345
7	10480.00	60.63	68.20	-7.57	44.12	16.51	Peak	105	124
8	15720.00	53.64	54.00	-0.36	36.72	16.92	Average	303	229
9	15720.00	69.94	74.00	-4.06	53.02	16.92	Peak	303	229

Note 1: Emission Level (dBUV/m) = SA Reading (dBUV/m) + Factor* (dB)

*Factor includes antenna factor , cable loss and amplifier gain

Note 2: Margin (dB) = Emission level (dBUV/m) – Limit (dBUV/m).

Note 3: "*" is Peak / Average value of fundamental frequency

Modulation	11a	Test Freq. (MHz)	5240
Polarization	Vertical	Test Configuration	1

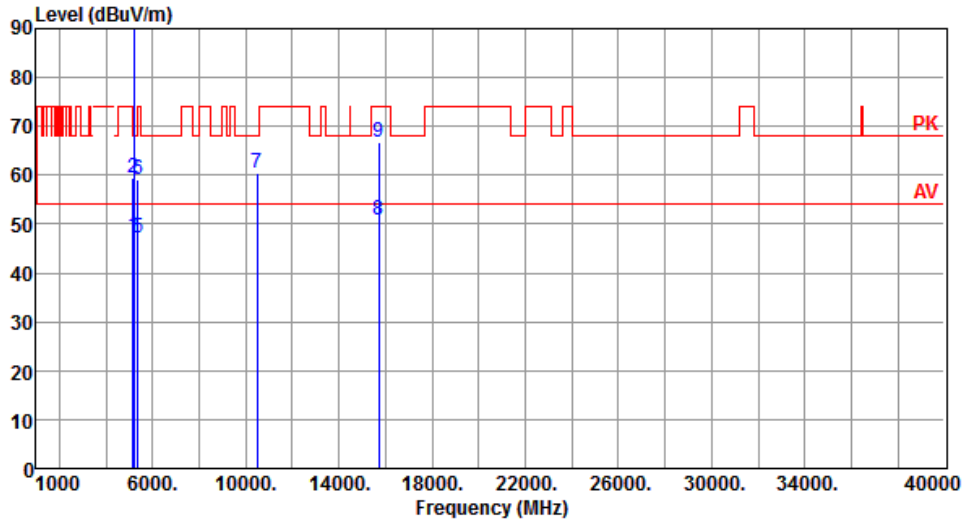

	Freq. MHz	Emission level dBUV/m	Limit dBUV/m	Margin dB	SA reading dBUV	Factor dB	Remark	ANT High cm	Turn Table deg
1	5150.00	47.33	54.00	-6.67	40.21	7.12	Average	208	321
2	5150.00	59.28	74.00	-14.72	52.16	7.12	Peak	208	321
3 *	5240.00	111.05			104.25	6.80	Average	208	321
4 *	5240.00	120.32			113.52	6.80	Peak	208	321
5	5350.00	47.27	54.00	-6.73	40.42	6.85	Average	208	321
6	5350.00	59.26	74.00	-14.74	52.41	6.85	Peak	208	321
7	10480.00	60.40	68.20	-7.80	43.89	16.51	Peak	252	16
8	15720.00	50.88	54.00	-3.12	33.96	16.92	Average	285	201
9	15720.00	66.79	74.00	-7.21	49.87	16.92	Peak	285	201

Note 1: Emission Level (dBUV/m) = SA Reading (dBUV/m) + Factor* (dB)

*Factor includes antenna factor , cable loss and amplifier gain

Note 2: Margin (dB) = Emission level (dBUV/m) – Limit (dBUV/m).

Note 3: "*" is Peak / Average value of fundamental frequency

Modulation	11a	Test Freq. (MHz)	5260
Polarization	Horizontal	Test Configuration	1

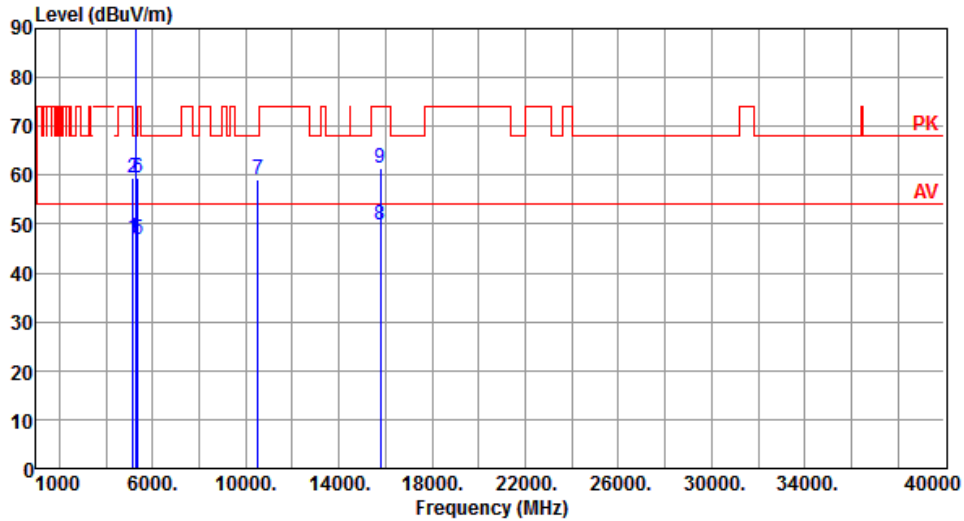

	Freq. MHz	Emission level dBuV/m	Limit dBuV/m	Margin dB	SA reading dBuV	Factor dB	Remark	ANT High cm	Turn Table deg
1	5150.00	46.99	54.00	-7.01	39.87	7.12	Average	176	340
2	5150.00	59.58	74.00	-14.42	52.46	7.12	Peak	176	340
3 *	5260.00	110.38			103.58	6.80	Average	176	340
4 *	5260.00	119.49			112.69	6.80	Peak	176	340
5	5350.00	46.73	54.00	-7.27	39.88	6.85	Average	176	340
6	5350.00	59.48	74.00	-14.52	52.63	6.85	Peak	176	340
7	10520.00	59.19	68.20	-9.01	42.69	16.50	Peak	100	357
8	15780.00	49.76	54.00	-4.24	32.82	16.94	Average	100	350
9	15780.00	61.49	74.00	-12.51	44.55	16.94	Peak	100	350

Note 1: Emission Level (dBuV/m) = SA Reading (dBuV/m) + Factor* (dB)

*Factor includes antenna factor , cable loss and amplifier gain

Note 2: Margin (dB) = Emission level (dBuV/m) – Limit (dBuV/m).

Note 3: "*" is Peak / Average value of fundamental frequency

Modulation	11a	Test Freq. (MHz)	5260
Polarization	Vertical	Test Configuration	1

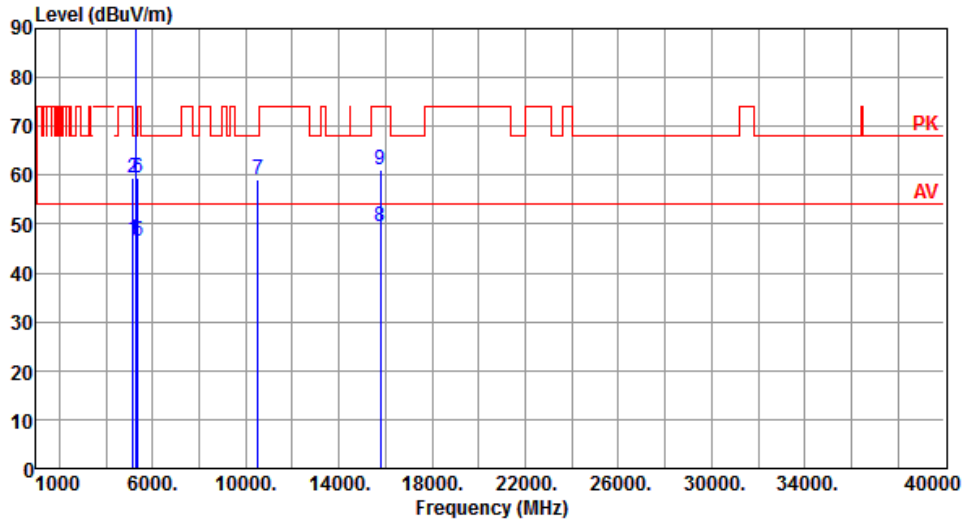

	Freq.	Emission	Limit	Margin	SA	Factor	Remark	ANT	Turn
	MHz	level	dBuV/m	dB	reading	dB		High	Table
		dBuV/m			dBuV			cm	deg
1	5150.00	46.76	54.00	-7.24	39.64	7.12	Average	220	331
2	5150.00	59.44	74.00	-14.56	52.32	7.12	Peak	220	331
3 *	5260.00	110.21			103.41	6.80	Average	220	331
4 *	5260.00	119.36			112.56	6.80	Peak	220	331
5	5350.00	46.53	54.00	-7.47	39.68	6.85	Average	220	331
6	5350.00	59.30	74.00	-14.70	52.45	6.85	Peak	220	331
7	10520.00	59.06	68.20	-9.14	42.56	16.50	Peak	100	185
8	15780.00	49.59	54.00	-4.41	32.65	16.94	Average	100	190
9	15780.00	61.26	74.00	-12.74	44.32	16.94	Peak	100	190

Note 1: Emission Level (dBUV/m) = SA Reading (dBUV/m) + Factor* (dB)

*Factor includes antenna factor , cable loss and amplifier gain

Note 2: Margin (dB) = Emission level (dBUV/m) – Limit (dBUV/m).

Note 3: "*" is Peak / Average value of fundamental frequency

Modulation	11a	Test Freq. (MHz)	5300
Polarization	Horizontal	Test Configuration	1

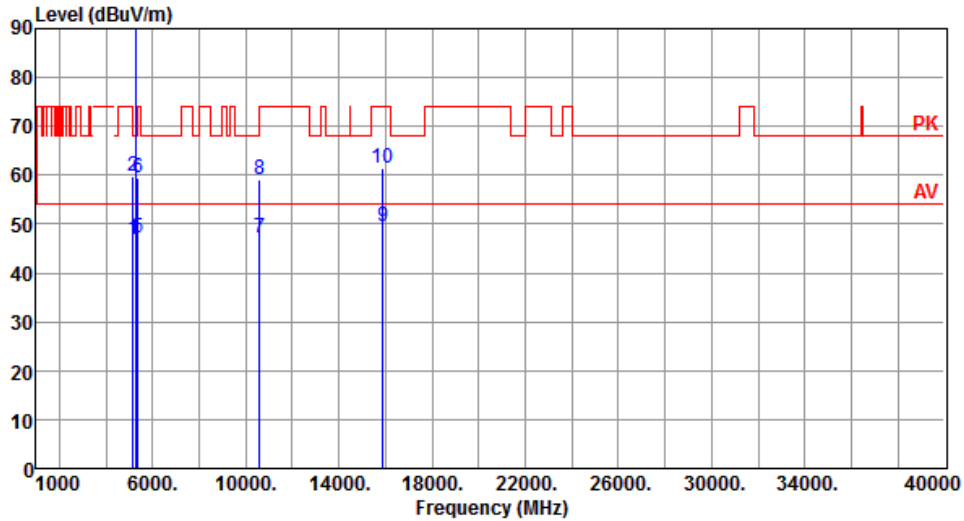

	Freq. MHz	Emission level dBUV/m	Limit dBUV/m	Margin dB	SA reading dBUV	Factor dB	Remark	ANT High cm	Turn Table deg
1	5150.00	46.69	54.00	-7.31	39.57	7.12	Average	192	341
2	5150.00	59.69	74.00	-14.31	52.57	7.12	Peak	192	341
3 *	5300.00	110.26			103.35	6.91	Average	192	341
4 *	5300.00	119.43			112.52	6.91	Peak	192	341
5	5350.00	47.21	54.00	-6.79	40.36	6.85	Average	192	341
6	5350.00	59.51	74.00	-14.49	52.66	6.85	Peak	192	341
7	10600.00	47.20	54.00	-6.80	30.84	16.36	Average	100	349
8	10600.00	59.21	74.00	-14.79	42.85	16.36	Peak	100	349
9	15900.00	49.56	54.00	-4.44	32.47	17.09	Average	100	353
10	15900.00	61.57	74.00	-12.43	44.48	17.09	Peak	100	353

Note 1: Emission Level (dBUV/m) = SA Reading (dBUV/m) + Factor* (dB)

*Factor includes antenna factor , cable loss and amplifier gain

Note 2: Margin (dB) = Emission level (dBUV/m) – Limit (dBUV/m).

Note 3: "*" is Peak / Average value of fundamental frequency

Modulation	11a	Test Freq. (MHz)	5300
Polarization	Vertical	Test Configuration	1

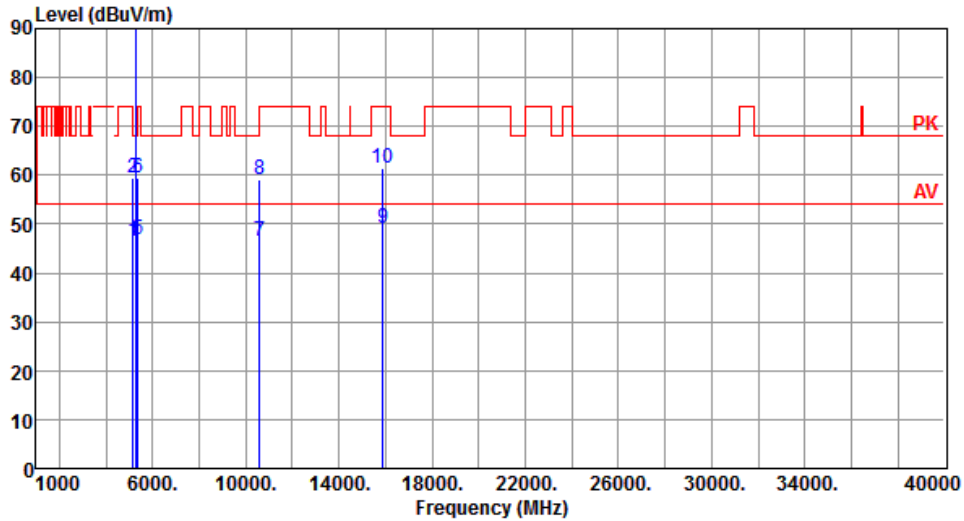

	Freq. MHz	Emission level dBUV/m	Limit dBUV/m	Margin dB	SA reading dBUV	Factor dB	Remark	ANT High cm	Turn Table deg
1	5150.00	46.56	54.00	-7.44	39.44	7.12	Average	225	332
2	5150.00	59.58	74.00	-14.42	52.46	7.12	Peak	225	332
3 *	5300.00	110.12			103.21	6.91	Average	225	332
4 *	5300.00	119.32			112.41	6.91	Peak	225	332
5	5350.00	46.96	54.00	-7.04	40.11	6.85	Average	225	332
6	5350.00	59.41	74.00	-14.59	52.56	6.85	Peak	225	332
7	10600.00	46.60	54.00	-7.40	30.24	16.36	Average	100	182
8	10600.00	59.20	74.00	-14.80	42.84	16.36	Peak	100	182
9	15900.00	49.26	54.00	-4.74	32.17	17.09	Average	100	189
10	15900.00	61.42	74.00	-12.58	44.33	17.09	Peak	100	189

Note 1: Emission Level (dBUV/m) = SA Reading (dBUV/m) + Factor* (dB)

*Factor includes antenna factor , cable loss and amplifier gain

Note 2: Margin (dB) = Emission level (dBUV/m) – Limit (dBUV/m).

Note 3: "*" is Peak / Average value of fundamental frequency

Modulation	11a	Test Freq. (MHz)	5320
Polarization	Horizontal	Test Configuration	1

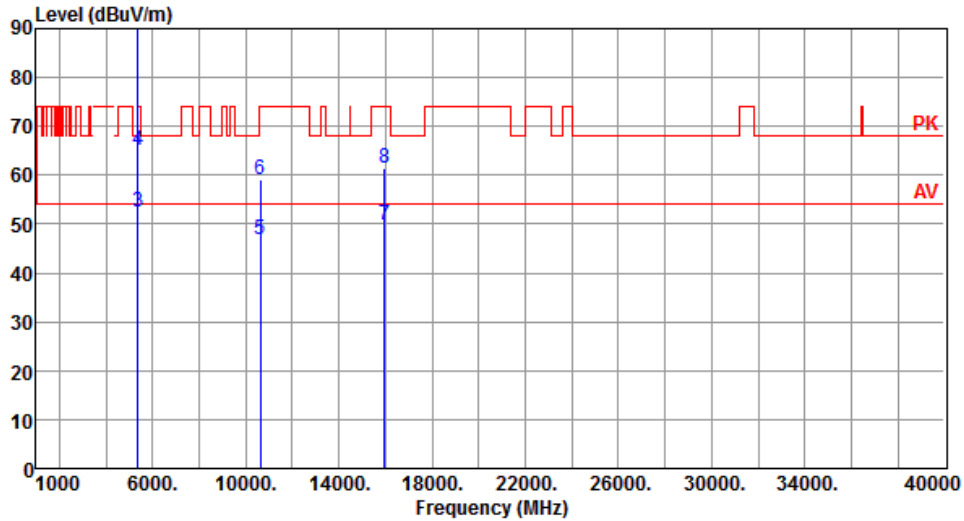

		Freq. MHz	Emission level dBUV/m	Limit dBUV/m	Margin dB	SA reading dBUV	Factor dB	Remark	ANT High cm	Turn Table deg
1	*	5320.00	110.16			103.27	6.89	Average	189	344
2	*	5320.00	119.37			112.48	6.89	Peak	189	344
3		5350.00	52.59	54.00	-1.41	45.74	6.85	Average	189	344
4		5350.00	65.18	74.00	-8.82	58.33	6.85	Peak	189	344
5		10640.00	46.93	54.00	-7.07	30.52	16.41	Average	100	352
6		10640.00	59.25	74.00	-14.75	42.84	16.41	Peak	100	352
7		15960.00	49.72	54.00	-4.28	32.85	16.87	Average	100	353
8		15960.00	61.39	74.00	-12.61	44.52	16.87	Peak	100	353

Note 1: Emission Level (dBUV/m) = SA Reading (dBUV/m) + Factor* (dB)

*Factor includes antenna factor , cable loss and amplifier gain

Note 2: Margin (dB) = Emission level (dBUV/m) – Limit (dBUV/m).

Note 3: "*" is Peak / Average value of fundamental frequency

Modulation	11a	Test Freq. (MHz)	5320
Polarization	Vertical	Test Configuration	1

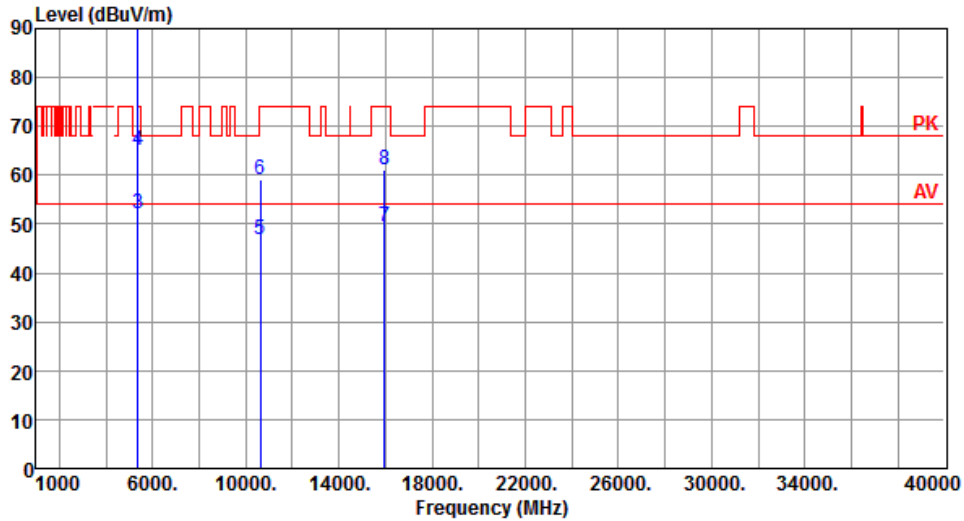

		Freq.	Emission	Limit	Margin	SA	Factor	Remark	ANT	Turn
		MHz	level	dBuV/m	dB	reading	dB		High	Table
			dBuV/m			dBuV			cm	deg
1	*	5320.00	110.02			103.13	6.89	Average	221	335
2	*	5320.00	119.21			112.32	6.89	Peak	221	335
3		5350.00	52.21	54.00	-1.79	45.36	6.85	Average	221	335
4		5350.00	64.96	74.00	-9.04	58.11	6.85	Peak	221	335
5		10640.00	46.87	54.00	-7.13	30.46	16.41	Average	100	183
6		10640.00	59.07	74.00	-14.93	42.66	16.41	Peak	100	183
7		15960.00	49.64	54.00	-4.36	32.77	16.87	Average	100	180
8		15960.00	61.22	74.00	-12.78	44.35	16.87	Peak	100	180

Note 1: Emission Level (dBuV/m) = SA Reading (dBuV/m) + Factor* (dB)

*Factor includes antenna factor , cable loss and amplifier gain

Note 2: Margin (dB) = Emission level (dBuV/m) – Limit (dBuV/m).

Note 3: "*" is Peak / Average value of fundamental frequency

Modulation	11a	Test Freq. (MHz)	5500
Polarization	Horizontal	Test Configuration	1

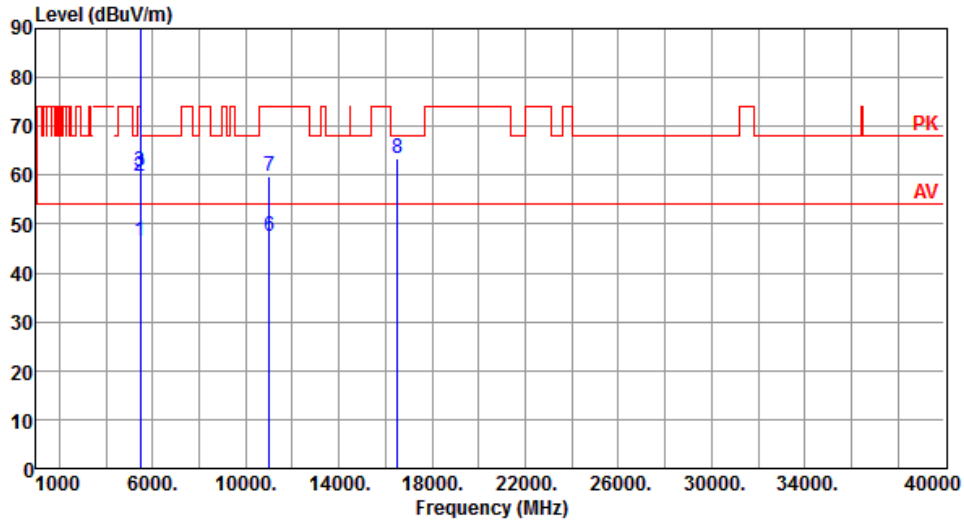

	Freq. MHz	Emission level dBUV/m	Limit dBUV/m	Margin dB	SA reading dBUV	Factor dB	Remark	ANT High cm	Turn Table deg
1	5460.00	46.38	54.00	-7.62	39.21	7.17	Average	189	340
2	5460.00	59.80	74.00	-14.20	52.63	7.17	Peak	189	340
3	5470.00	60.87	68.20	-7.33	53.65	7.22	Peak	189	340
4 *	5500.00	107.08			99.72	7.36	Average	189	340
5 *	5500.00	115.56			108.20	7.36	Peak	189	340
6	11000.00	47.62	54.00	-6.38	30.58	17.04	Average	100	178
7	11000.00	59.90	74.00	-14.10	42.86	17.04	Peak	100	178
8	16500.00	63.38	68.20	-4.82	44.84	18.54	Peak	100	183

Note 1: Emission Level (dBUV/m) = SA Reading (dBUV/m) + Factor* (dB)

*Factor includes antenna factor , cable loss and amplifier gain

Note 2: Margin (dB) = Emission level (dBUV/m) – Limit (dBUV/m).

Note 3: "*" is Peak / Average value of fundamental frequency

Modulation	11a	Test Freq. (MHz)	5500
Polarization	Vertical	Test Configuration	1

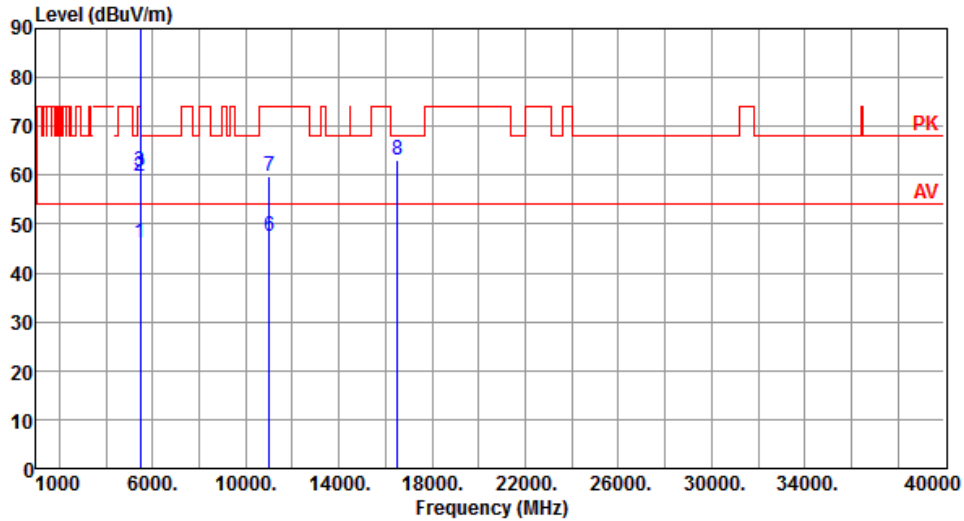

	Freq. MHz	Emission level dBUV/m	Limit dBUV/m	Margin dB	SA reading dBUV	Factor dB	Remark	ANT High cm	Turn Table deg
1	5460.00	46.28	54.00	-7.72	39.11	7.17	Average	221	333
2	5460.00	59.62	74.00	-14.38	52.45	7.17	Peak	221	333
3	5470.00	60.68	68.20	-7.52	53.46	7.22	Peak	221	333
4 *	5500.00	106.31			98.95	7.36	Average	221	333
5 *	5500.00	114.81			107.45	7.36	Peak	221	333
6	11000.00	47.45	54.00	-6.55	30.41	17.04	Average	100	181
7	11000.00	59.69	74.00	-14.31	42.65	17.04	Peak	100	181
8	16500.00	63.19	68.20	-5.01	44.65	18.54	Peak	100	189

Note 1: Emission Level (dBUV/m) = SA Reading (dBUV/m) + Factor* (dB)

*Factor includes antenna factor , cable loss and amplifier gain

Note 2: Margin (dB) = Emission level (dBUV/m) – Limit (dBUV/m).

Note 3: "*" is Peak / Average value of fundamental frequency

Modulation	11a	Test Freq. (MHz)	5580
Polarization	Horizontal	Test Configuration	1

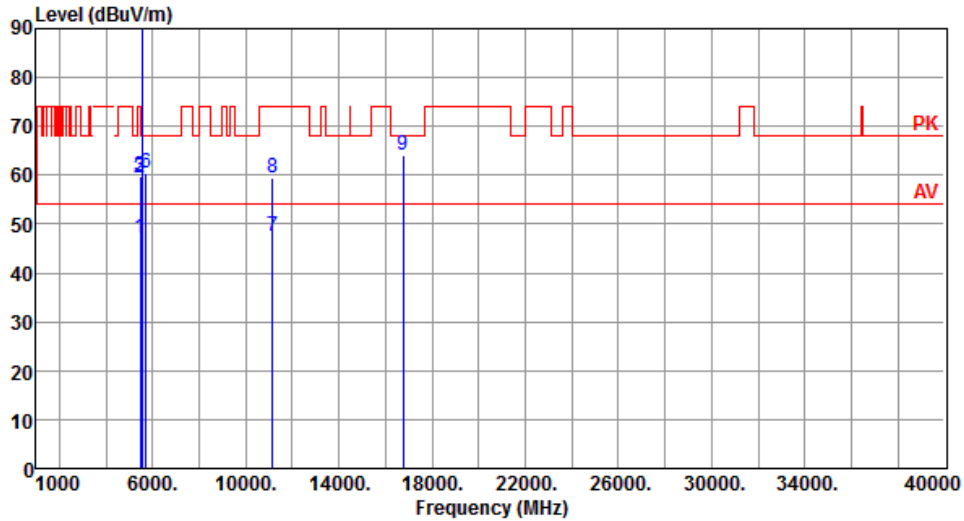

	Freq. MHz	Emission level dBuV/m	Limit dBuV/m	Margin dB	SA reading dBuV	Factor dB	Remark	ANT High cm	Turn Table deg
1	5460.00	47.16	54.00	-6.84	39.99	7.17	Average	179	349
2	5460.00	59.42	74.00	-14.58	52.25	7.17	Peak	179	349
3	5470.00	59.85	68.20	-8.35	52.63	7.22	Peak	179	349
4 *	5580.00	107.17			99.69	7.48	Average	179	349
5 *	5580.00	116.87			109.39	7.48	Peak	179	349
6	5725.00	60.43	68.20	-7.77	52.87	7.56	Peak	179	349
7	11160.00	47.38	54.00	-6.62	30.85	16.53	Average	100	187
8	11160.00	59.42	74.00	-14.58	42.89	16.53	Peak	100	187
9	16740.00	64.14	68.20	-4.06	44.67	19.47	Peak	100	184

Note 1: Emission Level (dBuV/m) = SA Reading (dBuV/m) + Factor* (dB)

*Factor includes antenna factor , cable loss and amplifier gain

Note 2: Margin (dB) = Emission level (dBuV/m) – Limit (dBuV/m).

Note 3: "*" is Peak / Average value of fundamental frequency

Modulation	11a	Test Freq. (MHz)	5580
Polarization	Vertical	Test Configuration	1

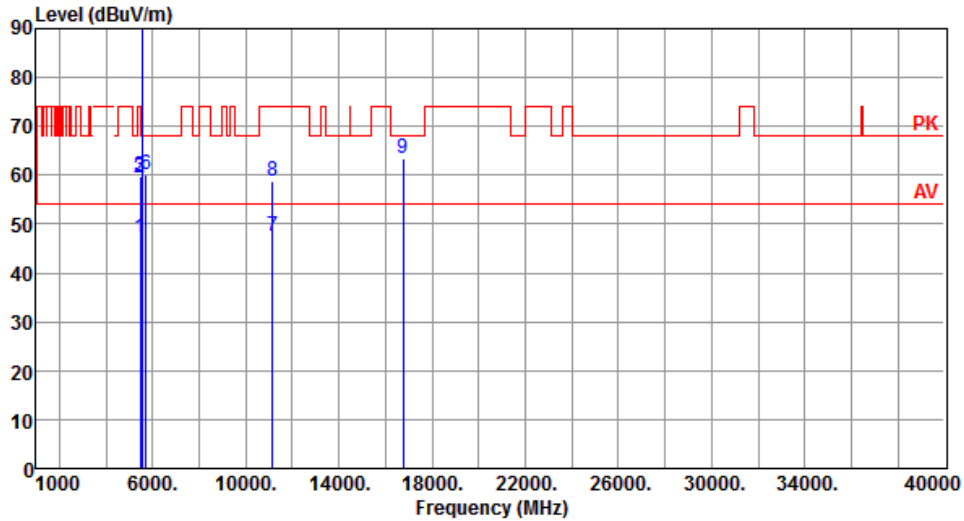

	Freq. MHz	Emission level dBUV/m	Limit dBUV/m	Margin dB	SA reading dBUV	Factor dB	Remark	ANT High cm	Turn Table deg
1	5460.00	47.03	54.00	-6.97	39.86	7.17	Average	225	333
2	5460.00	59.28	74.00	-14.72	52.11	7.17	Peak	225	333
3	5470.00	59.78	68.20	-8.42	52.56	7.22	Peak	225	333
4 *	5580.00	106.69			99.21	7.48	Average	225	333
5 *	5580.00	116.60			109.12	7.48	Peak	225	333
6	5725.00	60.24	68.20	-7.96	52.68	7.56	Peak	225	333
7	11160.00	47.34	54.00	-6.66	30.81	16.53	Average	100	184
8	11160.00	58.89	74.00	-15.11	42.36	16.53	Peak	100	184
9	16740.00	63.58	68.20	-4.62	44.11	19.47	Peak	100	188

Note 1: Emission Level (dBUV/m) = SA Reading (dBUV/m) + Factor* (dB)

*Factor includes antenna factor , cable loss and amplifier gain

Note 2: Margin (dB) = Emission level (dBUV/m) – Limit (dBUV/m).

Note 3: "*" is Peak / Average value of fundamental frequency

Modulation	11a	Test Freq. (MHz)	5700
Polarization	Horizontal	Test Configuration	1

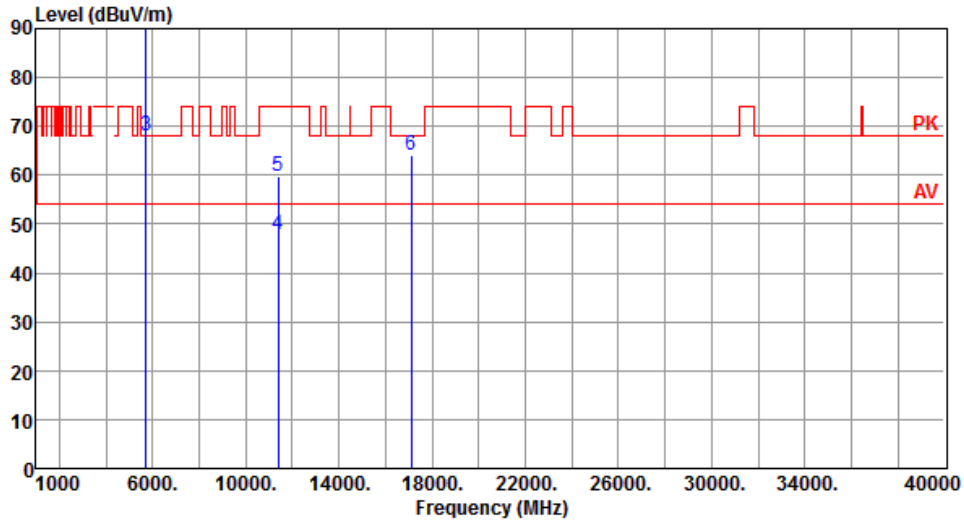

		Freq.	Emission	Limit	Margin	SA	Factor	Remark	ANT	Turn
		MHz	level	dBuV/m	dB	reading	dB		High	Table
			dBuV/m			dBuV			cm	deg
1	*	5700.00	107.24			99.84	7.40	Average	196	340
2	*	5700.00	117.35			109.95	7.40	Peak	196	340
3		5725.00	67.99	68.20	-0.21	60.43	7.56	Peak	196	340
4		11400.00	47.67	54.00	-6.33	30.84	16.83	Average	100	174
5		11400.00	59.68	74.00	-14.32	42.85	16.83	Peak	100	174
6		17100.00	64.20	68.20	-4.00	44.46	19.74	Peak	100	175

Note 1: Emission Level (dBuV/m) = SA Reading (dBuV/m) + Factor* (dB)

*Factor includes antenna factor , cable loss and amplifier gain

Note 2: Margin (dB) = Emission level (dBuV/m) – Limit (dBuV/m).

Note 3: "*" is Peak / Average value of fundamental frequency

Modulation	11a	Test Freq. (MHz)	5700
Polarization	Vertical	Test Configuration	1

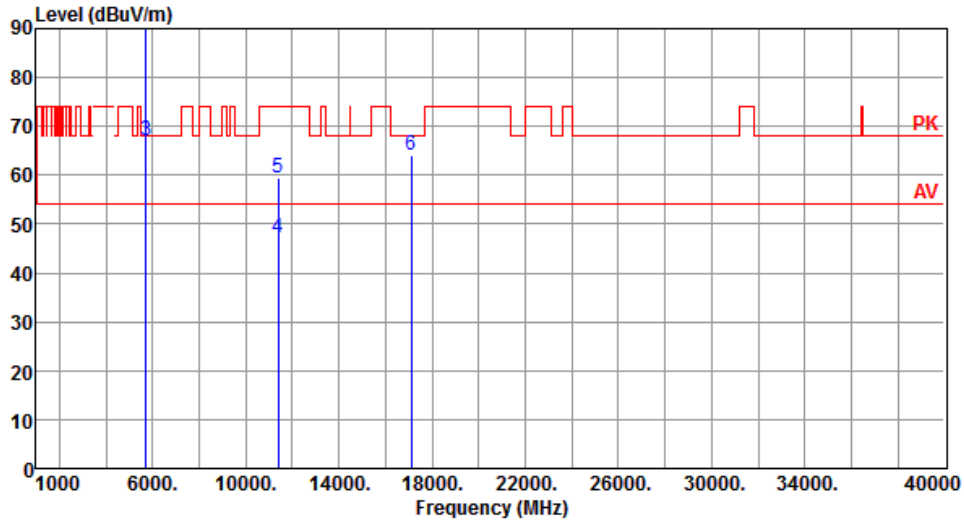

		Freq.	Emission	Limit	Margin	SA	Factor	Remark	ANT	Turn
		MHz	level	dBuV/m	dB	reading	dB		High	Table
			dBuV/m			dBuV			cm	deg
1	*	5700.00	106.42			99.02	7.40	Average	223	331
2	*	5700.00	116.85			109.45	7.40	Peak	223	331
3		5725.00	67.20	68.20	-1.00	59.64	7.56	Peak	223	331
4		11400.00	47.27	54.00	-6.73	30.44	16.83	Average	100	180
5		11400.00	59.46	74.00	-14.54	42.63	16.83	Peak	100	180
6		17100.00	64.06	68.20	-4.14	44.32	19.74	Peak	100	178

Note 1: Emission Level (dBuV/m) = SA Reading (dBuV/m) + Factor* (dB)

*Factor includes antenna factor , cable loss and amplifier gain

Note 2: Margin (dB) = Emission level (dBuV/m) – Limit (dBuV/m).

Note 3: "*" is Peak / Average value of fundamental frequency

Modulation	11a	Test Freq. (MHz)	5720
Polarization	Horizontal	Test Configuration	1

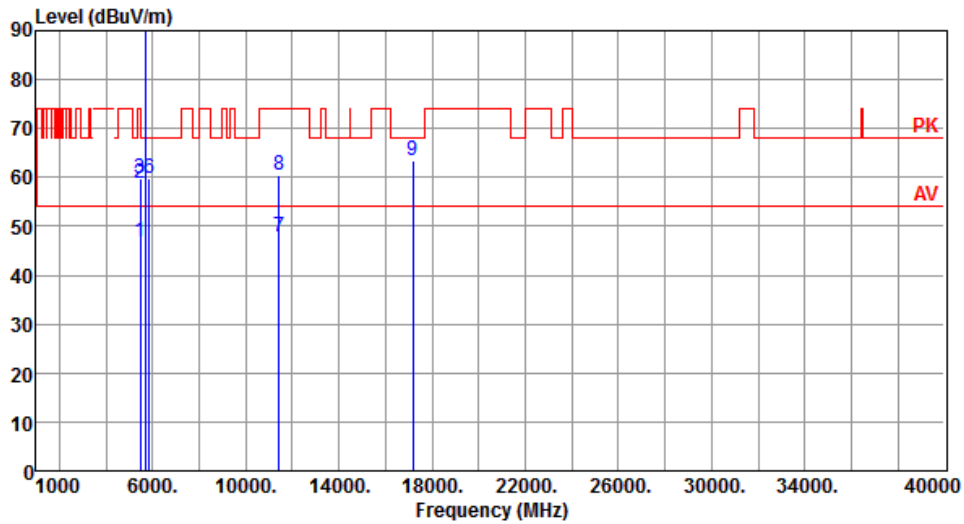

	Freq. MHz	Emission level dBuV/m	Limit dBuV/m	Margin dB	SA reading dBuV	Factor dB	Remark	ANT High cm	Turn Table deg
1	5460.00	46.71	54.00	-7.29	39.34	7.37	Average	182	351
2	5460.00	58.81	74.00	-15.19	51.44	7.37	Peak	182	351
3	5470.00	59.75	68.20	-8.45	52.33	7.42	Peak	182	351
4 *	5720.00	107.66			99.92	7.74	Average	182	351
5 *	5720.00	117.20			109.46	7.74	Peak	182	351
6	5850.00	59.66	68.20	-8.54	51.54	8.12	Peak	182	351
7	11440.00	47.91	54.00	-6.09	31.13	16.78	Average	100	189
8	11440.00	60.32	74.00	-13.68	43.54	16.78	Peak	100	189
9	17160.00	63.54	68.20	-4.66	45.04	18.50	Peak	100	185

Note 1: Emission Level (dBuV/m) = SA Reading (dBuV/m) + Factor* (dB)

*Factor includes antenna factor , cable loss and amplifier gain

Note 2: Margin (dB) = Emission level (dBuV/m) – Limit (dBuV/m).

Note 3: "*" is Peak / Average value of fundamental frequency

Modulation	11a	Test Freq. (MHz)	5720
Polarization	Vertical	Test Configuration	1

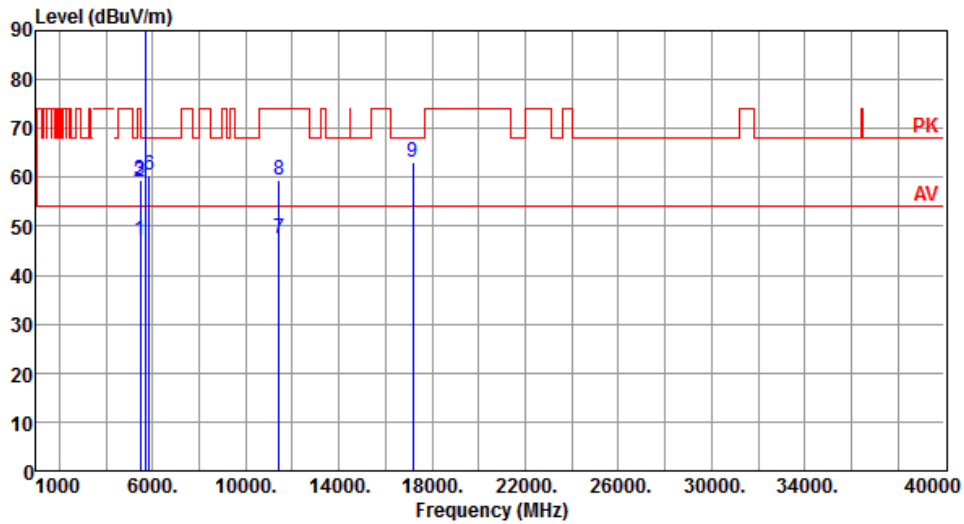

	Freq. MHz	Emission level dBuV/m	Limit dBuV/m	Margin dB	SA reading dBuV	Factor dB	Remark	ANT High cm	Turn Table deg
1	5460.00	47.32	54.00	-6.68	39.95	7.37	Average	224	331
2	5460.00	59.25	74.00	-14.75	51.88	7.37	Peak	224	331
3	5470.00	59.39	68.20	-8.81	51.97	7.42	Peak	224	331
4 *	5720.00	107.20			99.46	7.74	Average	224	331
5 *	5720.00	117.01			109.27	7.74	Peak	224	331
6	5850.00	60.33	68.20	-7.87	52.21	8.12	Peak	224	331
7	11440.00	47.61	54.00	-6.39	30.83	16.78	Average	100	182
8	11440.00	59.29	74.00	-14.71	42.51	16.78	Peak	100	182
9	17160.00	62.98	68.20	-5.22	44.48	18.50	Peak	100	189

Note 1: Emission Level (dBuV/m) = SA Reading (dBuV/m) + Factor* (dB)

*Factor includes antenna factor , cable loss and amplifier gain

Note 2: Margin (dB) = Emission level (dBuV/m) – Limit (dBuV/m).

Note 3: "*" is Peak / Average value of fundamental frequency

Modulation	11a	Test Freq. (MHz)	5745
Polarization	Horizontal	Test Configuration	1

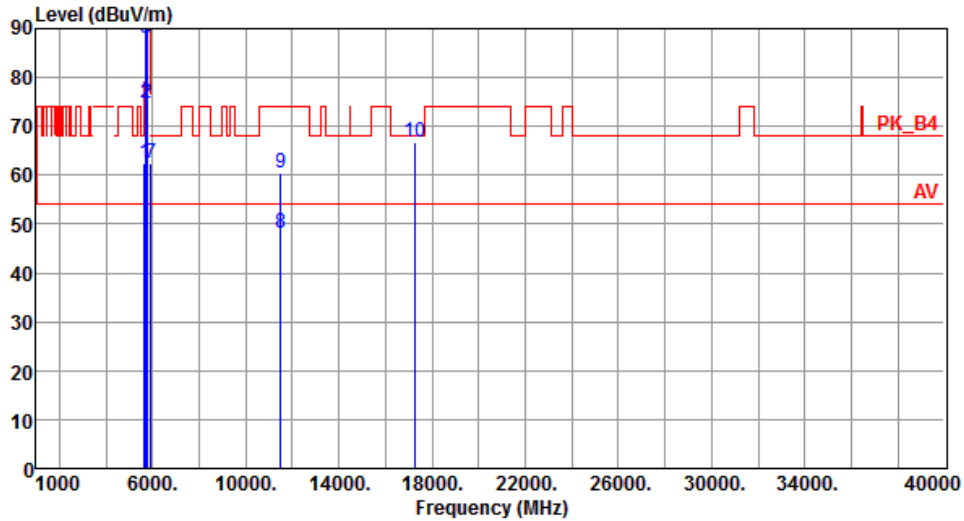

	Freq. MHz	Emission level dBuV/m	Limit dBuV/m	Margin dB	SA reading dBuV	Factor dB	Remark	ANT High cm	Turn Table deg
1	5650.00	62.50	68.20	-5.70	55.11	7.39	Peak	130	13
2	5700.00	74.62	105.20	-30.58	67.22	7.40	Peak	130	13
3	5720.00	88.15	110.80	-22.65	80.63	7.52	Peak	130	13
4	5725.00	93.66	122.20	-28.54	86.10	7.56	Peak	130	13
5 *	5745.00	110.60			102.92	7.68	Average	130	13
6 *	5745.00	122.58			114.90	7.68	Peak	130	13
7	5925.00	62.38	68.20	-5.82	54.21	8.17	Peak	130	13
8	11490.00	48.00	54.00	-6.00	31.23	16.77	Average	235	118
9	11490.00	60.33	74.00	-13.67	43.56	16.77	Peak	235	118
10	17235.00	66.59	68.20	-1.61	46.28	20.31	Peak	283	311

Note 1: Emission Level (dBuV/m) = SA Reading (dBuV/m) + Factor* (dB)

*Factor includes antenna factor , cable loss and amplifier gain

Note 2: Margin (dB) = Emission level (dBuV/m) – Limit (dBuV/m).

Note 3: "*" is Peak / Average value of fundamental frequency

Modulation	11a	Test Freq. (MHz)	5745
Polarization	Vertical	Test Configuration	1

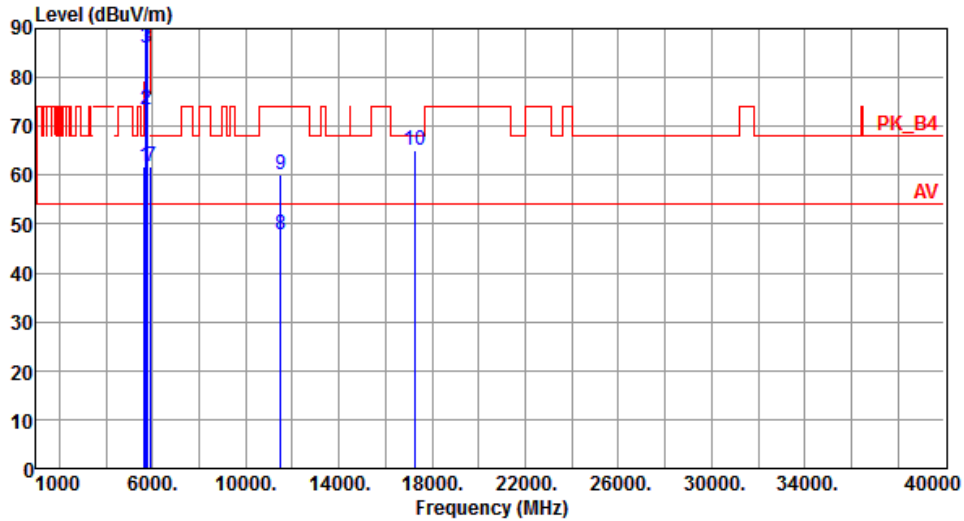

	Freq. MHz	Emission level dBuV/m	Limit dBuV/m	Margin dB	SA reading dBuV	Factor dB	Remark	ANT High cm	Turn Table deg
1	5650.00	61.64	68.20	-6.56	54.25	7.39	Peak	183	325
2	5700.00	73.26	105.20	-31.94	65.86	7.40	Peak	183	325
3	5720.00	86.04	110.80	-24.76	78.52	7.52	Peak	183	325
4	5725.00	91.80	122.20	-30.40	84.24	7.56	Peak	183	325
5 *	5745.00	109.09			101.41	7.68	Average	183	325
6 *	5745.00	121.19			113.51	7.68	Peak	183	325
7	5925.00	61.76	68.20	-6.44	53.59	8.17	Peak	183	325
8	11490.00	47.83	54.00	-6.17	31.06	16.77	Average	100	122
9	11490.00	59.99	74.00	-14.01	43.22	16.77	Peak	100	122
10	17235.00	65.20	68.20	-3.00	44.89	20.31	Peak	100	249

Note 1: Emission Level (dBuV/m) = SA Reading (dBuV/m) + Factor* (dB)

*Factor includes antenna factor , cable loss and amplifier gain

Note 2: Margin (dB) = Emission level (dBuV/m) – Limit (dBuV/m).

Note 3: "*" is Peak / Average value of fundamental frequency

Modulation	11a	Test Freq. (MHz)	5785
Polarization	Horizontal	Test Configuration	1

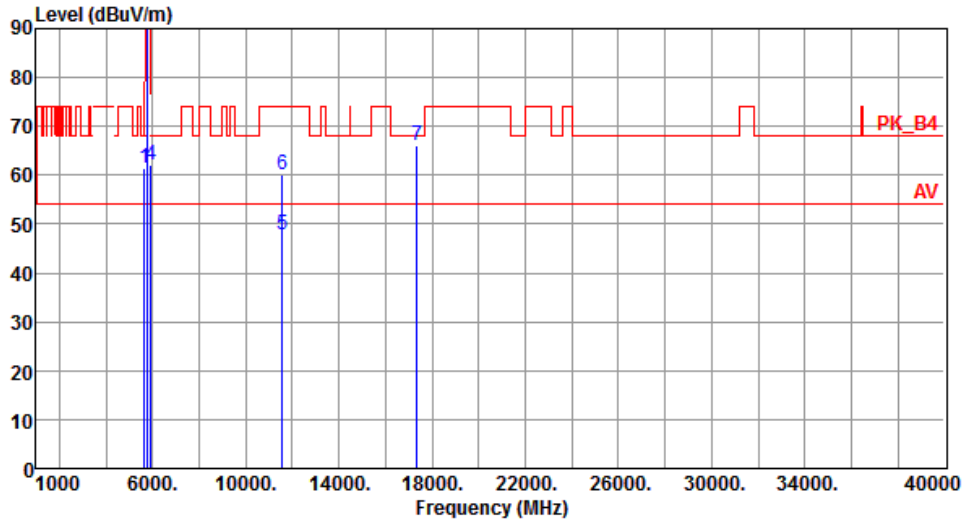

	Freq. MHz	Emission level dBuV/m	Limit dBuV/m	Margin dB	SA reading dBuV	Factor dB	Remark	ANT High cm	Turn Table deg
1	5650.00	61.56	68.20	-6.64	54.17	7.39	Peak	152	25
2 *	5785.00	110.78			103.00	7.78	Average	152	25
3 *	5785.00	121.66			113.88	7.78	Peak	152	25
4	5925.00	62.17	68.20	-6.03	54.00	8.17	Peak	152	25
5	11570.00	47.96	54.00	-6.04	31.21	16.75	Average	240	124
6	11570.00	60.26	74.00	-13.74	43.51	16.75	Peak	240	124
7	17355.00	66.22	68.20	-1.98	45.33	20.89	Peak	300	302

Note 1: Emission Level (dBuV/m) = SA Reading (dBuV/m) + Factor* (dB)

*Factor includes antenna factor , cable loss and amplifier gain

Note 2: Margin (dB) = Emission level (dBuV/m) – Limit (dBuV/m).

Note 3: "*" is Peak / Average value of fundamental frequency

Modulation	11a	Test Freq. (MHz)	5785
Polarization	Vertical	Test Configuration	1

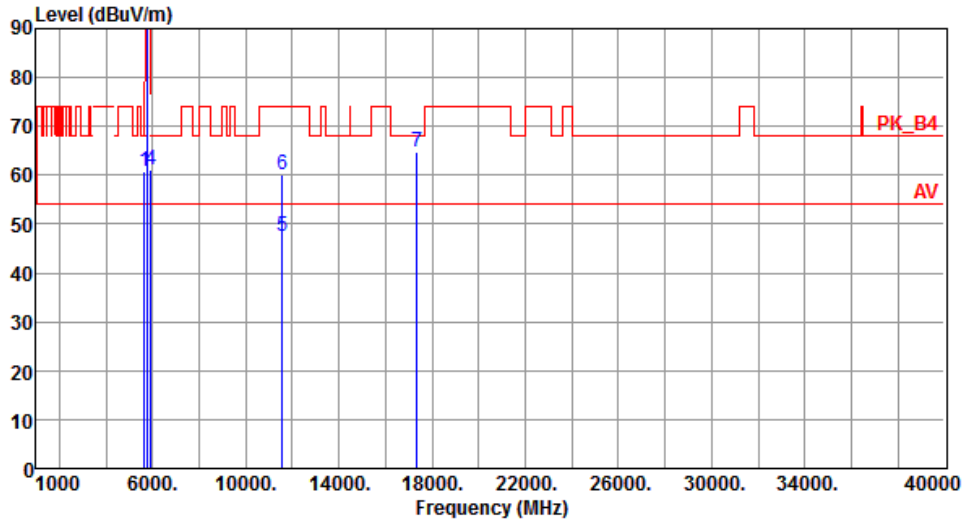

	Freq. MHz	Emission level dBuV/m	Limit dBuV/m	Margin dB	SA reading dBuV	Factor dB	Remark	ANT High cm	Turn Table deg
1	5650.00	60.91	68.20	-7.29	53.52	7.39	Peak	179	318
2 *	5785.00	109.77			101.99	7.78	Average	179	318
3 *	5785.00	120.52			112.74	7.78	Peak	179	318
4	5925.00	61.03	68.20	-7.17	52.86	8.17	Peak	179	318
5	11570.00	47.63	54.00	-6.37	30.88	16.75	Average	100	129
6	11570.00	59.95	74.00	-14.05	43.20	16.75	Peak	100	129
7	17355.00	64.73	68.20	-3.47	43.84	20.89	Peak	100	247

Note 1: Emission Level (dBuV/m) = SA Reading (dBuV/m) + Factor* (dB)

*Factor includes antenna factor , cable loss and amplifier gain

Note 2: Margin (dB) = Emission level (dBuV/m) – Limit (dBuV/m).

Note 3: "*" is Peak / Average value of fundamental frequency

Modulation	11a	Test Freq. (MHz)	5825
Polarization	Horizontal	Test Configuration	1

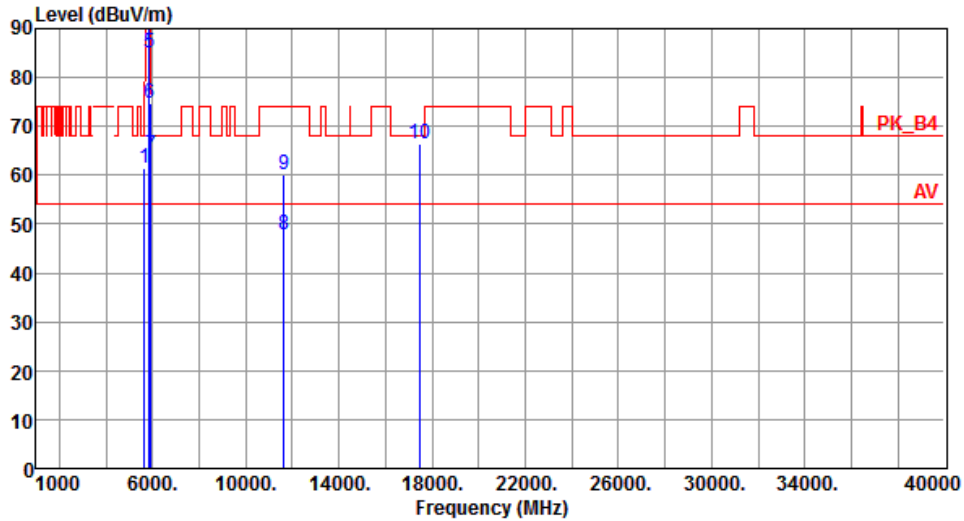

	Freq. MHz	Emission level dBuV/m	Limit dBuV/m	Margin dB	SA reading dBuV	Factor dB	Remark	ANT High cm	Turn Table deg
1	5650.00	61.50	68.20	-6.70	54.11	7.39	Peak	235	122
2 *	5825.00	110.86			102.95	7.91	Average	235	122
3 *	5825.00	123.00			115.09	7.91	Peak	235	122
4	5850.00	91.01	122.20	-31.19	82.99	8.02	Peak	235	122
5	5855.00	84.99	110.80	-25.81	76.96	8.03	Peak	235	122
6	5875.00	74.84	105.20	-30.36	66.76	8.08	Peak	235	122
7	5925.00	63.98	68.20	-4.22	55.81	8.17	Peak	235	122
8	11650.00	47.86	54.00	-6.14	31.33	16.53	Average	235	122
9	11650.00	60.10	74.00	-13.90	43.57	16.53	Peak	235	122
10	17475.00	66.51	68.20	-1.69	45.00	21.51	Peak	271	316

Note 1: Emission Level (dBuV/m) = SA Reading (dBuV/m) + Factor* (dB)

*Factor includes antenna factor , cable loss and amplifier gain

Note 2: Margin (dB) = Emission level (dBuV/m) – Limit (dBuV/m).

Note 3: "*" is Peak / Average value of fundamental frequency

Modulation	11a	Test Freq. (MHz)	5825
Polarization	Vertical	Test Configuration	1

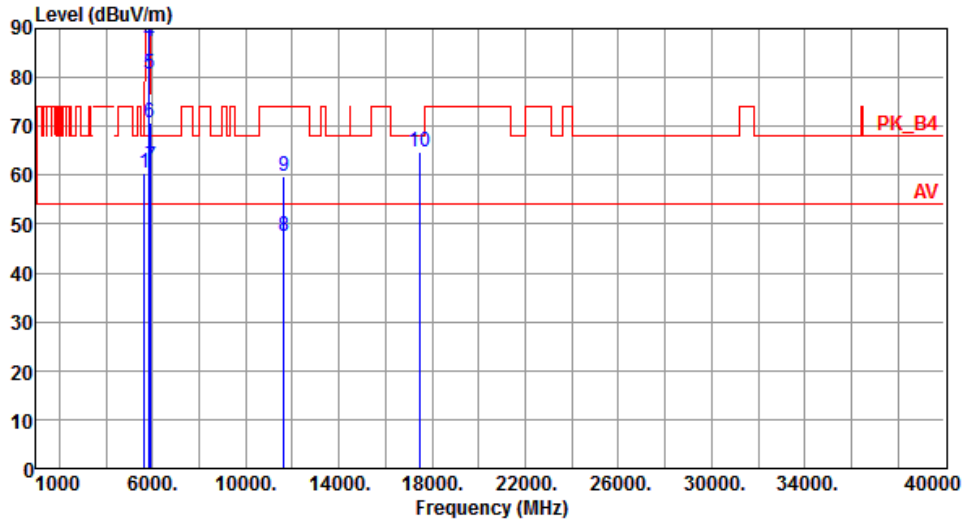

	Freq. MHz	Emission level dBuV/m	Limit dBuV/m	Margin dB	SA reading dBuV	Factor dB	Remark	ANT High cm	Turn Table deg
1	5650.00	60.60	68.20	-7.60	53.21	7.39	Peak	187	329
2 *	5825.00	109.37			101.46	7.91	Average	187	329
3 *	5825.00	121.92			114.01	7.91	Peak	187	329
4	5850.00	87.24	122.20	-34.96	79.22	8.02	Peak	187	329
5	5855.00	80.69	110.80	-30.11	72.66	8.03	Peak	187	329
6	5875.00	70.59	105.20	-34.61	62.51	8.08	Peak	187	329
7	5925.00	61.76	68.20	-6.44	53.59	8.17	Peak	187	329
8	11650.00	47.38	54.00	-6.62	30.85	16.53	Average	100	123
9	11650.00	59.73	74.00	-14.27	43.20	16.53	Peak	100	123
10	17475.00	64.71	68.20	-3.49	43.20	21.51	Peak	100	247

Note 1: Emission Level (dBuV/m) = SA Reading (dBuV/m) + Factor* (dB)

*Factor includes antenna factor , cable loss and amplifier gain

Note 2: Margin (dB) = Emission level (dBuV/m) – Limit (dBuV/m).

Note 3: "*" is Peak / Average value of fundamental frequency

3.5.2 Transmitter Radiated Unwanted Emissions (Above 1GHz) for ax (HE20)

Modulation	ax (HE20)	Test Freq. (MHz)	5180
Polarization	Horizontal	Test Configuration	1

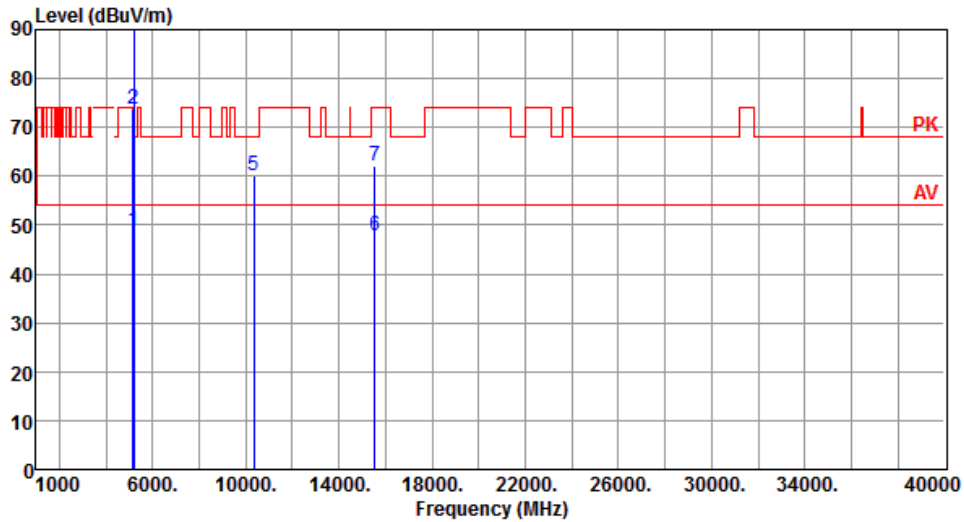

	Freq. MHz	Emission level dBuV/m	Limit dBuV/m	Margin dB	SA reading dBuV	Factor dB	Remark	ANT High cm	Turn Table deg
1	5150.00	48.97	54.00	-5.03	41.85	7.12	Average	113	11
2	5150.00	73.60	74.00	-0.40	66.48	7.12	Peak	113	11
3 *	5180.00	103.25			96.25	7.00	Average	113	11
4 *	5180.00	114.68			107.68	7.00	Peak	113	11
5	10360.00	60.23	68.20	-7.97	43.96	16.27	Peak	100	120
6	15540.00	47.97	54.00	-6.03	30.56	17.41	Average	100	220
7	15540.00	62.17	74.00	-11.83	44.76	17.41	Peak	100	220

Note 1: Emission Level (dBuV/m) = SA Reading (dBuV/m) + Factor* (dB)

*Factor includes antenna factor, cable loss and amplifier gain

Note 2: Margin (dB) = Emission level (dBuV/m) – Limit (dBuV/m).

Note 3: "*" is Peak / Average value of fundamental frequency

Modulation	ax (HE20)	Test Freq. (MHz)	5180
Polarization	Vertical	Test Configuration	1

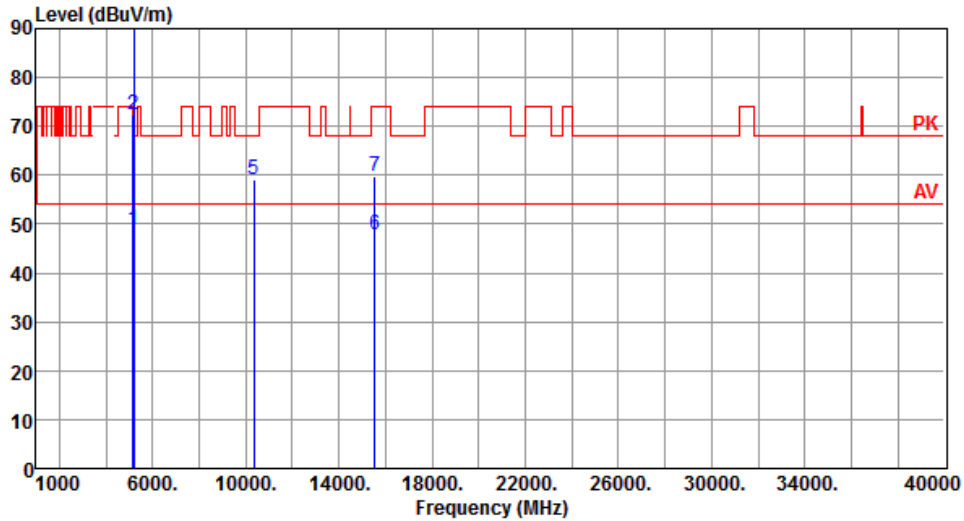

	Freq. MHz	Emission level dBuV/m	Limit dBuV/m	Margin dB	SA reading dBuV	Factor dB	Remark	ANT High cm	Turn Table deg
1	5150.00	48.83	54.00	-5.17	41.71	7.12	Average	189	324
2	5150.00	72.49	74.00	-1.51	65.37	7.12	Peak	189	324
3 *	5180.00	102.44			95.44	7.00	Average	189	324
4 *	5180.00	114.35			107.35	7.00	Peak	189	324
5	10360.00	59.16	68.20	-9.04	42.89	16.27	Peak	254	23
6	15540.00	47.70	54.00	-6.30	30.29	17.41	Average	300	204
7	15540.00	59.78	74.00	-14.22	42.37	17.41	Peak	300	204

Note 1: Emission Level (dBuV/m) = SA Reading (dBuV/m) + Factor* (dB)

*Factor includes antenna factor , cable loss and amplifier gain

Note 2: Margin (dB) = Emission level (dBuV/m) – Limit (dBuV/m).

Note 3: "*" is Peak / Average value of fundamental frequency

Modulation	ax (HE20)	Test Freq. (MHz)	5200
Polarization	Horizontal	Test Configuration	1

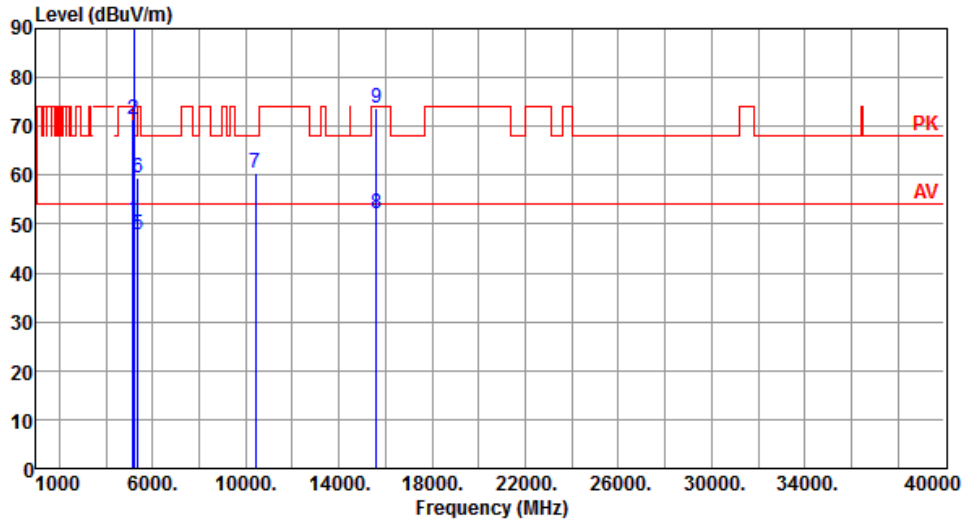

	Freq. MHz	Emission level dBUV/m	Limit dBUV/m	Margin dB	SA reading dBUV	Factor dB	Remark	ANT High cm	Turn Table deg
1	5150.00	50.80	54.00	-3.20	43.68	7.12	Average	118	13
2	5150.00	71.36	74.00	-2.64	64.24	7.12	Peak	118	13
3 *	5200.00	109.53			102.60	6.93	Average	118	13
4 *	5200.00	121.11			114.18	6.93	Peak	118	13
5	5350.00	47.84	54.00	-6.16	40.99	6.85	Average	118	13
6	5350.00	59.54	74.00	-14.46	52.69	6.85	Peak	118	13
7	10400.00	60.36	68.20	-7.84	43.98	16.38	Peak	100	122
8	15600.00	52.06	54.00	-1.94	34.69	17.37	Average	301	222
9	15600.00	73.58	74.00	-0.42	56.21	17.37	Peak	301	222

Note 1: Emission Level (dBUV/m) = SA Reading (dBUV/m) + Factor* (dB)

*Factor includes antenna factor , cable loss and amplifier gain

Note 2: Margin (dB) = Emission level (dBUV/m) – Limit (dBUV/m).

Note 3: "*" is Peak / Average value of fundamental frequency

Modulation	ax (HE20)	Test Freq. (MHz)	5200
Polarization	Vertical	Test Configuration	1

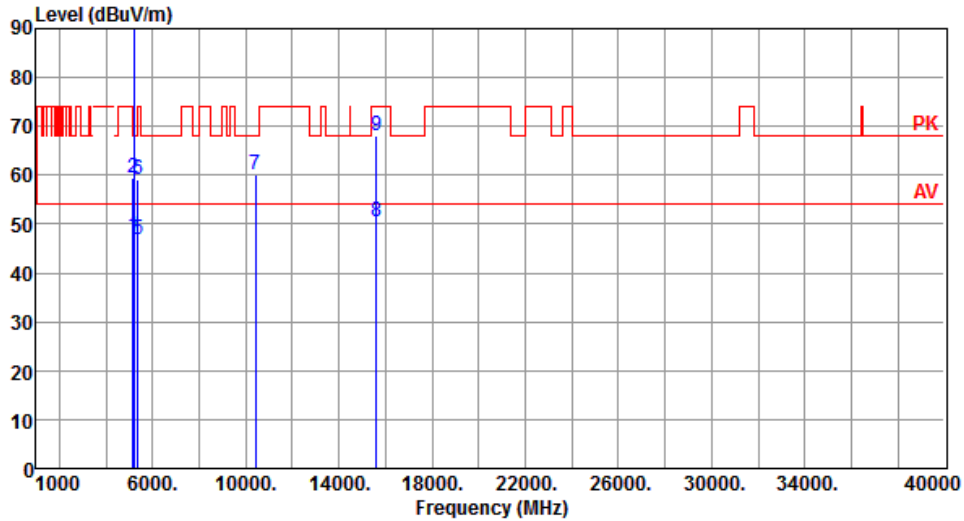

	Freq. MHz	Emission level dBUV/m	Limit dBUV/m	Margin dB	SA reading dBUV	Factor dB	Remark	ANT High cm	Turn Table deg
1	5150.00	47.56	54.00	-6.44	40.44	7.12	Average	189	327
2	5150.00	59.47	74.00	-14.53	52.35	7.12	Peak	189	327
3 *	5200.00	108.68			101.75	6.93	Average	189	327
4 *	5200.00	121.29			114.36	6.93	Peak	189	327
5	5350.00	46.96	54.00	-7.04	40.11	6.85	Average	189	327
6	5350.00	59.24	74.00	-14.76	52.39	6.85	Peak	189	327
7	10400.00	60.23	68.20	-7.97	43.85	16.38	Peak	253	15
8	15600.00	50.63	54.00	-3.37	33.26	17.37	Average	284	206
9	15600.00	67.93	74.00	-6.07	50.56	17.37	Peak	284	206

Note 1: Emission Level (dBUV/m) = SA Reading (dBUV/m) + Factor* (dB)

*Factor includes antenna factor , cable loss and amplifier gain

Note 2: Margin (dB) = Emission level (dBUV/m) – Limit (dBUV/m).

Note 3: "*" is Peak / Average value of fundamental frequency

Modulation	ax (HE20)	Test Freq. (MHz)	5240
Polarization	Horizontal	Test Configuration	1

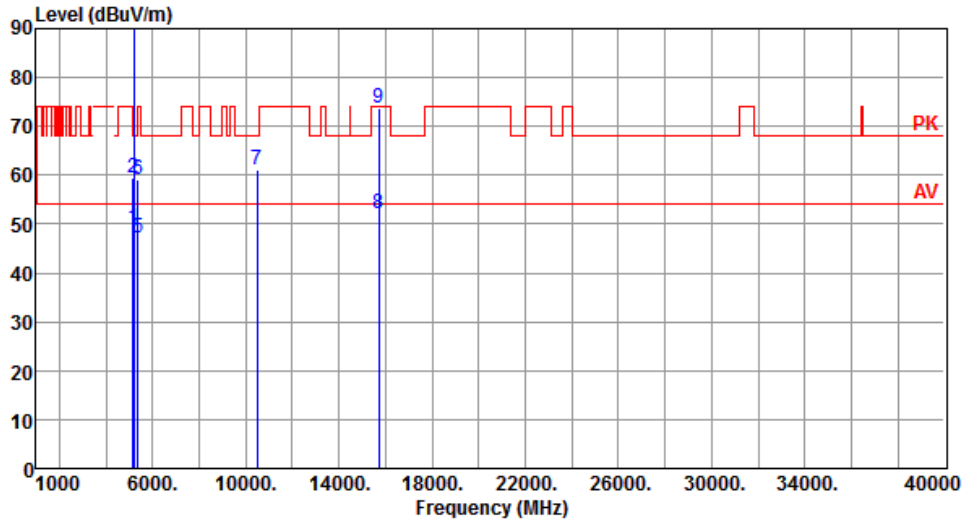

	Freq. MHz	Emission level dBuV/m	Limit dBuV/m	Margin dB	SA reading dBuV	Factor dB	Remark	ANT High cm	Turn Table deg
1	5150.00	48.99	54.00	-5.01	41.87	7.12	Average	120	21
2	5150.00	59.47	74.00	-14.53	52.35	7.12	Peak	120	21
3 *	5240.00	110.42			103.62	6.80	Average	120	21
4 *	5240.00	121.85			115.05	6.80	Peak	120	21
5	5350.00	47.18	54.00	-6.82	40.33	6.85	Average	120	21
6	5350.00	59.26	74.00	-14.74	52.41	6.85	Peak	120	21
7	10480.00	61.09	68.20	-7.11	44.58	16.51	Peak	100	125
8	15720.00	52.30	54.00	-1.70	35.38	16.92	Average	304	233
9	15720.00	73.69	74.00	-0.31	56.77	16.92	Peak	304	233

Note 1: Emission Level (dBuV/m) = SA Reading (dBuV/m) + Factor* (dB)

*Factor includes antenna factor , cable loss and amplifier gain

Note 2: Margin (dB) = Emission level (dBuV/m) – Limit (dBuV/m).

Note 3: "*" is Peak / Average value of fundamental frequency

Modulation	ax (HE20)	Test Freq. (MHz)	5240
Polarization	Vertical	Test Configuration	1

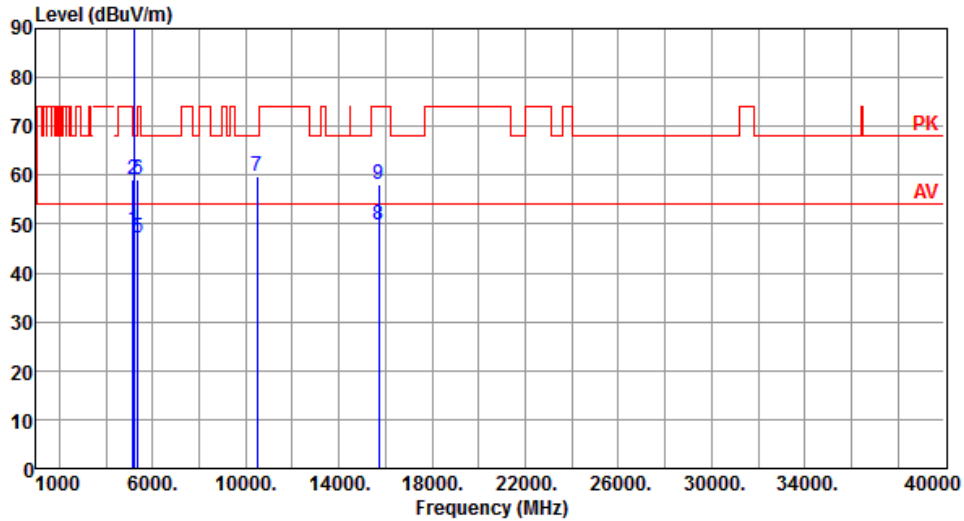

	Freq. MHz	Emission level dBuV/m	Limit dBuV/m	Margin dB	SA reading dBuV	Factor dB	Remark	ANT High cm	Turn Table deg
1	5150.00	48.69	54.00	-5.31	41.57	7.12	Average	188	326
2	5150.00	59.26	74.00	-14.74	52.14	7.12	Peak	188	326
3 *	5240.00	109.68			102.88	6.80	Average	188	326
4 *	5240.00	120.89			114.09	6.80	Peak	188	326
5	5350.00	47.02	54.00	-6.98	40.17	6.85	Average	188	326
6	5350.00	59.02	74.00	-14.98	52.17	6.85	Peak	188	326
7	10480.00	59.76	68.20	-8.44	43.25	16.51	Peak	255	23
8	15720.00	49.91	54.00	-4.09	32.99	16.92	Average	284	204
9	15720.00	58.09	74.00	-15.91	41.17	16.92	Peak	284	204

Note 1: Emission Level (dBuV/m) = SA Reading (dBuV/m) + Factor* (dB)

*Factor includes antenna factor , cable loss and amplifier gain

Note 2: Margin (dB) = Emission level (dBuV/m) – Limit (dBuV/m).

Note 3: "*" is Peak / Average value of fundamental frequency

Modulation	ax (HE20)	Test Freq. (MHz)	5260
Polarization	Horizontal	Test Configuration	1

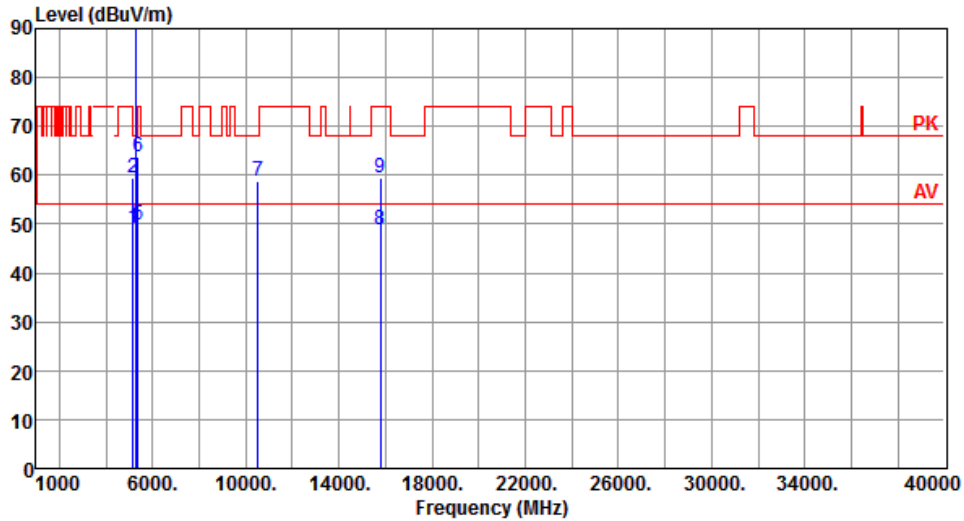

	Freq. MHz	Emission level dBUV/m	Limit dBUV/m	Margin dB	SA reading dBUV	Factor dB	Remark	ANT High cm	Turn Table deg
1	5150.00	49.19	54.00	-4.81	42.07	7.12	Average	199	345
2	5150.00	59.44	74.00	-14.56	52.32	7.12	Peak	199	345
3 *	5260.00	109.21			102.41	6.80	Average	199	345
4 *	5260.00	121.92			115.12	6.80	Peak	199	345
5	5350.00	49.85	54.00	-4.15	43.00	6.85	Average	199	345
6	5350.00	63.73	74.00	-10.27	56.88	6.85	Peak	199	345
7	10520.00	58.73	68.20	-9.47	42.23	16.50	Peak	100	188
8	15780.00	48.98	54.00	-5.02	32.04	16.94	Average	100	352
9	15780.00	59.57	74.00	-14.43	42.63	16.94	Peak	100	352

Note 1: Emission Level (dBUV/m) = SA Reading (dBUV/m) + Factor* (dB)

*Factor includes antenna factor , cable loss and amplifier gain

Note 2: Margin (dB) = Emission level (dBUV/m) – Limit (dBUV/m).

Note 3: "*" is Peak / Average value of fundamental frequency

Modulation	ax (HE20)	Test Freq. (MHz)	5260
Polarization	Vertical	Test Configuration	1

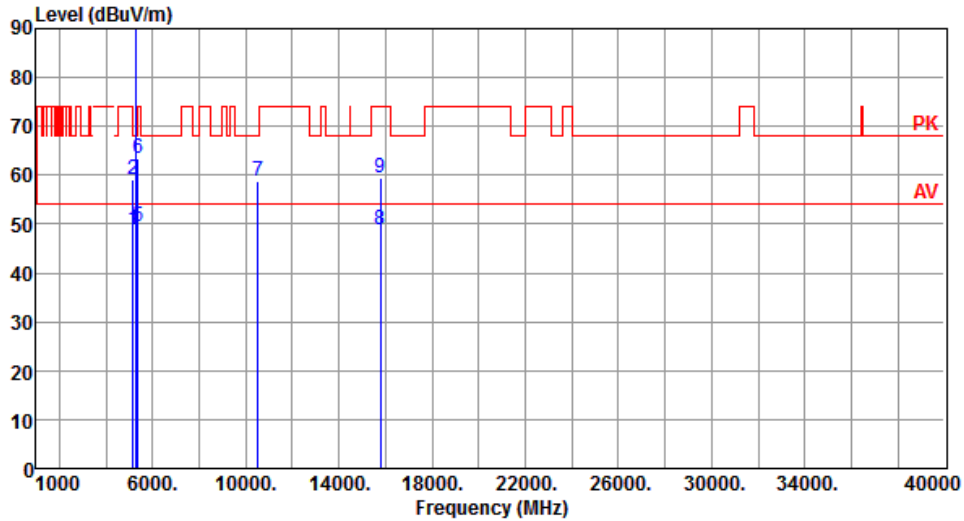

	Freq. MHz	Emission level dBuV/m	Limit dBuV/m	Margin dB	SA reading dBuV	Factor dB	Remark	ANT High cm	Turn Table deg
1	5150.00	48.67	54.00	-5.33	41.55	7.12	Average	223	331
2	5150.00	59.24	74.00	-14.76	52.12	7.12	Peak	223	331
3 *	5260.00	108.93			102.13	6.80	Average	223	331
4 *	5260.00	121.81			115.01	6.80	Peak	223	331
5	5350.00	49.41	54.00	-4.59	42.56	6.85	Average	223	331
6	5350.00	63.27	74.00	-10.73	56.42	6.85	Peak	223	331
7	10520.00	58.86	68.20	-9.34	42.36	16.50	Peak	200	182
8	15780.00	48.83	54.00	-5.17	31.89	16.94	Average	100	185
9	15780.00	59.50	74.00	-14.50	42.56	16.94	Peak	100	185

Note 1: Emission Level (dBuV/m) = SA Reading (dBuV/m) + Factor* (dB)

*Factor includes antenna factor , cable loss and amplifier gain

Note 2: Margin (dB) = Emission level (dBuV/m) – Limit (dBuV/m).

Note 3: "*" is Peak / Average value of fundamental frequency

Modulation	ax (HE20)	Test Freq. (MHz)	5300
Polarization	Horizontal	Test Configuration	1

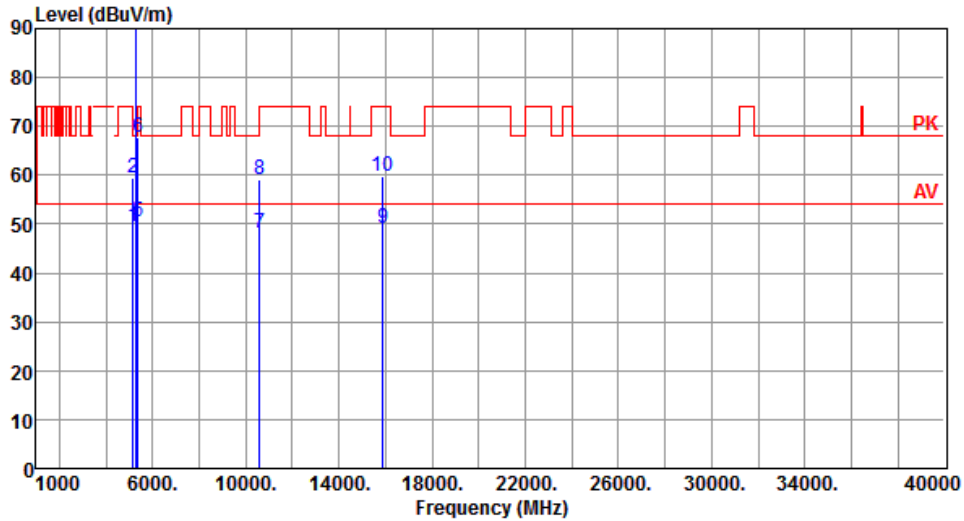

	Freq. MHz	Emission level dBUV/m	Limit dBUV/m	Margin dB	SA reading dBUV	Factor dB	Remark	ANT High cm	Turn Table deg
1	5150.00	49.37	54.00	-4.63	42.25	7.12	Average	218	343
2	5150.00	59.42	74.00	-14.58	52.30	7.12	Peak	218	343
3 *	5300.00	109.26			102.35	6.91	Average	218	343
4 *	5300.00	122.16			115.25	6.91	Peak	218	343
5	5350.00	50.39	54.00	-3.61	43.54	6.85	Average	218	343
6	5350.00	67.83	74.00	-6.17	60.98	6.85	Peak	218	343
7	10600.00	48.12	54.00	-5.88	31.76	16.36	Average	100	351
8	10600.00	59.24	74.00	-14.76	42.88	16.36	Peak	100	351
9	15900.00	49.31	54.00	-4.69	32.22	17.09	Average	100	350
10	15900.00	59.94	74.00	-14.06	42.85	17.09	Peak	100	350

Note 1: Emission Level (dBUV/m) = SA Reading (dBUV/m) + Factor* (dB)

*Factor includes antenna factor , cable loss and amplifier gain

Note 2: Margin (dB) = Emission level (dBUV/m) – Limit (dBUV/m).

Note 3: "*" is Peak / Average value of fundamental frequency

Modulation	ax (HE20)	Test Freq. (MHz)	5300
Polarization	Vertical	Test Configuration	1

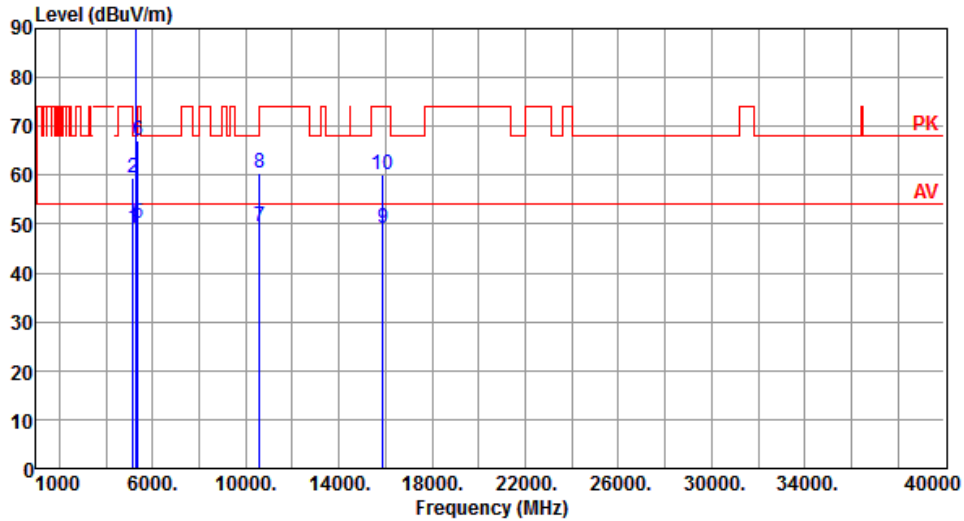

	Freq. MHz	Emission level dBUV/m	Limit dBUV/m	Margin dB	SA reading dBUV	Factor dB	Remark	ANT High cm	Turn Table deg
1	5150.00	49.24	54.00	-4.76	42.12	7.12	Average	223	335
2	5150.00	59.28	74.00	-14.72	52.16	7.12	Peak	223	335
3 *	5300.00	108.93			102.02	6.91	Average	223	335
4 *	5300.00	122.04			115.13	6.91	Peak	223	335
5	5350.00	50.09	54.00	-3.91	43.24	6.85	Average	223	335
6	5350.00	67.10	74.00	-6.90	60.25	6.85	Peak	223	335
7	10600.00	49.47	54.00	-4.53	33.11	16.36	Average	204	188
8	10600.00	60.58	74.00	-13.42	44.22	16.36	Peak	204	188
9	15900.00	49.10	54.00	-4.90	32.01	17.09	Average	100	158
10	15900.00	59.95	74.00	-14.05	42.86	17.09	Peak	100	158

Note 1: Emission Level (dBUV/m) = SA Reading (dBUV/m) + Factor* (dB)

*Factor includes antenna factor , cable loss and amplifier gain

Note 2: Margin (dB) = Emission level (dBUV/m) – Limit (dBUV/m).

Note 3: "*" is Peak / Average value of fundamental frequency

Modulation	ax (HE20)	Test Freq. (MHz)	5320
Polarization	Horizontal	Test Configuration	1

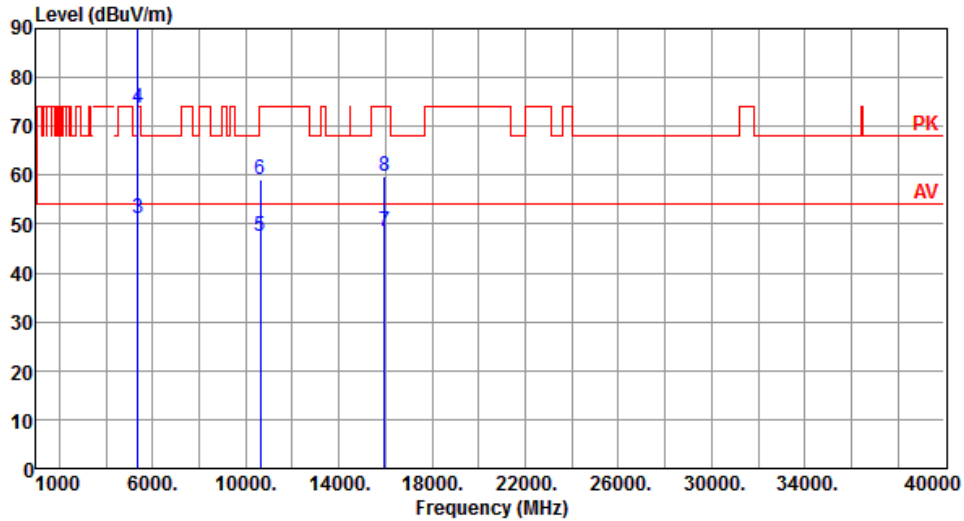

		Freq. MHz	Emission level dBuV/m	Limit dBuV/m	Margin dB	SA reading dBuV	Factor dB	Remark	ANT High cm	Turn Table deg
1	*	5320.00	105.18			98.29	6.89	Average	185	341
2	*	5320.00	117.11			110.22	6.89	Peak	185	341
3		5350.00	51.08	54.00	-2.92	44.23	6.85	Average	185	18
4		5350.00	73.72	74.00	-0.28	66.87	6.85	Peak	185	18
5		10640.00	47.64	54.00	-6.36	31.23	16.41	Average	100	353
6		10640.00	59.19	74.00	-14.81	42.78	16.41	Peak	100	353
7		15960.00	48.53	54.00	-5.47	31.66	16.87	Average	100	354
8		15960.00	59.74	74.00	-14.26	42.87	16.87	Peak	100	354

Note 1: Emission Level (dBuV/m) = SA Reading (dBuV/m) + Factor* (dB)

*Factor includes antenna factor , cable loss and amplifier gain

Note 2: Margin (dB) = Emission level (dBuV/m) – Limit (dBuV/m).

Note 3: "*" is Peak / Average value of fundamental frequency

Modulation	ax (HE20)	Test Freq. (MHz)	5320
Polarization	Vertical	Test Configuration	1

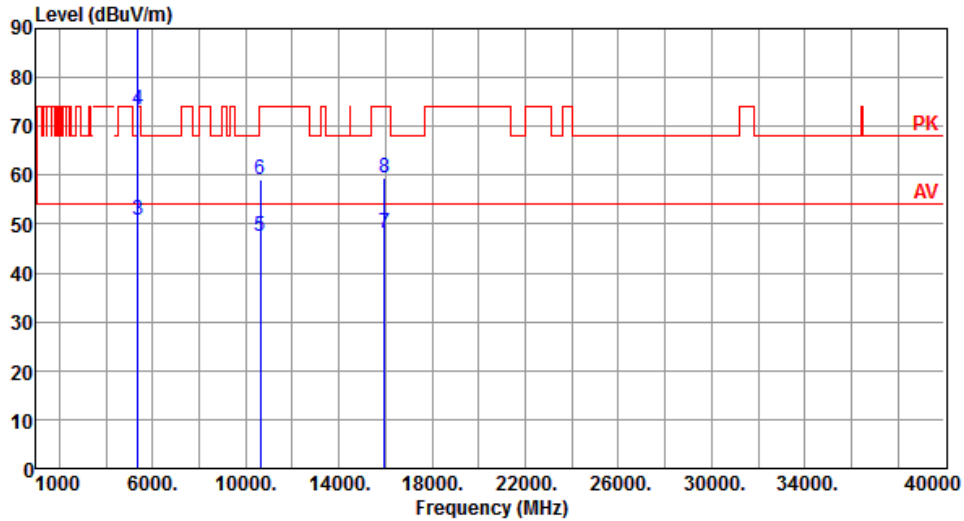

		Freq. MHz	Emission level dBuV/m	Limit dBuV/m	Margin dB	SA reading dBuV	Factor dB	Remark	ANT High cm	Turn Table deg
1	*	5320.00	104.90			98.01	6.89	Average	228	330
2	*	5320.00	116.92			110.03	6.89	Peak	228	330
3		5350.00	50.97	54.00	-3.03	44.12	6.85	Average	228	330
4		5350.00	73.32	74.00	-0.68	66.47	6.85	Peak	228	330
5		10640.00	47.56	54.00	-6.44	31.15	16.41	Average	100	189
6		10640.00	59.10	74.00	-14.90	42.69	16.41	Peak	100	189
7		15960.00	48.10	54.00	-5.90	31.23	16.87	Average	100	185
8		15960.00	59.33	74.00	-14.67	42.46	16.87	Peak	100	185

Note 1: Emission Level (dBuV/m) = SA Reading (dBuV/m) + Factor* (dB)

*Factor includes antenna factor , cable loss and amplifier gain

Note 2: Margin (dB) = Emission level (dBuV/m) – Limit (dBuV/m).

Note 3: "*" is Peak / Average value of fundamental frequency

Modulation	ax (HE20)	Test Freq. (MHz)	5500
Polarization	Horizontal	Test Configuration	1

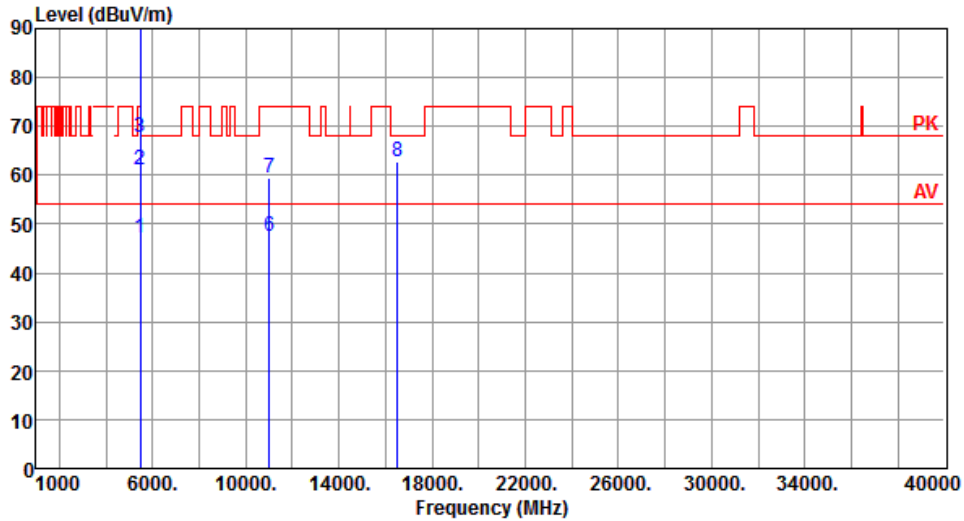

	Freq. MHz	Emission level dBuV/m	Limit dBuV/m	Margin dB	SA reading dBuV	Factor dB	Remark	ANT High cm	Turn Table deg
1	5460.00	47.05	54.00	-6.95	39.88	7.17	Average	196	344
2	5460.00	60.99	74.00	-13.01	53.82	7.17	Peak	196	344
3	5470.00	67.73	68.20	-0.47	60.51	7.22	Peak	196	344
4 *	5500.00	102.90			95.54	7.36	Average	196	344
5 *	5500.00	115.92			108.56	7.36	Peak	196	344
6	11000.00	47.56	54.00	-6.44	30.52	17.04	Average	100	184
7	11000.00	59.43	74.00	-14.57	42.39	17.04	Peak	100	184
8	16500.00	62.76	68.20	-5.44	44.22	18.54	Peak	100	182

Note 1: Emission Level (dBuV/m) = SA Reading (dBuV/m) + Factor* (dB)

*Factor includes antenna factor , cable loss and amplifier gain

Note 2: Margin (dB) = Emission level (dBuV/m) – Limit (dBuV/m).

Note 3: "*" is Peak / Average value of fundamental frequency

Modulation	ax (HE20)	Test Freq. (MHz)	5500
Polarization	Vertical	Test Configuration	1

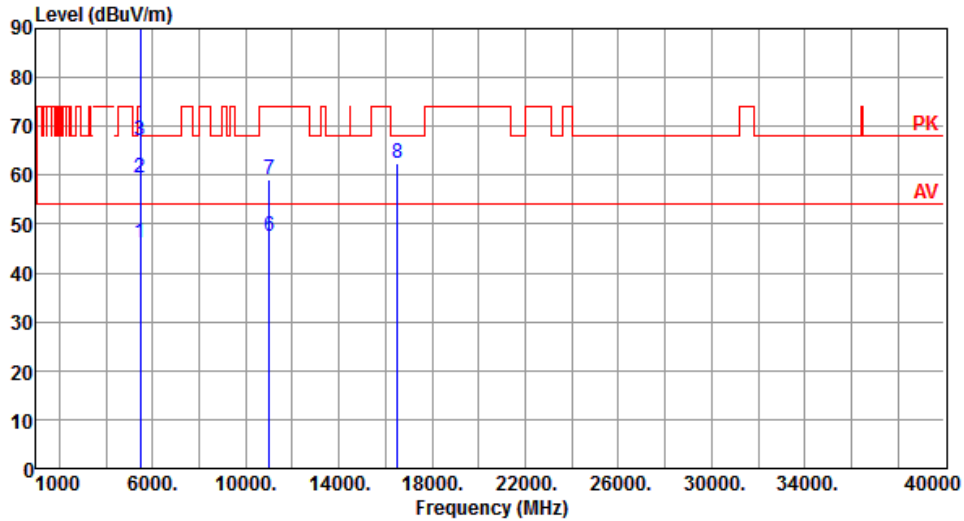

	Freq. MHz	Emission level dBUV/m	Limit dBUV/m	Margin dB	SA reading dBUV	Factor dB	Remark	ANT High cm	Turn Table deg
1	5460.00	46.15	54.00	-7.85	38.98	7.17	Average	241	320
2	5460.00	59.34	74.00	-14.66	52.17	7.17	Peak	241	320
3	5470.00	67.04	68.20	-1.16	59.82	7.22	Peak	241	320
4 *	5500.00	102.24			94.88	7.36	Average	241	320
5 *	5500.00	115.32			107.96	7.36	Peak	241	320
6	11000.00	47.46	54.00	-6.54	30.42	17.04	Average	100	185
7	11000.00	59.26	74.00	-14.74	42.22	17.04	Peak	100	185
8	16500.00	62.59	68.20	-5.61	44.05	18.54	Peak	100	188

Note 1: Emission Level (dBUV/m) = SA Reading (dBUV/m) + Factor* (dB)

*Factor includes antenna factor , cable loss and amplifier gain

Note 2: Margin (dB) = Emission level (dBUV/m) – Limit (dBUV/m).

Note 3: "*" is Peak / Average value of fundamental frequency

Modulation	ax (HE20)	Test Freq. (MHz)	5580
Polarization	Horizontal	Test Configuration	1

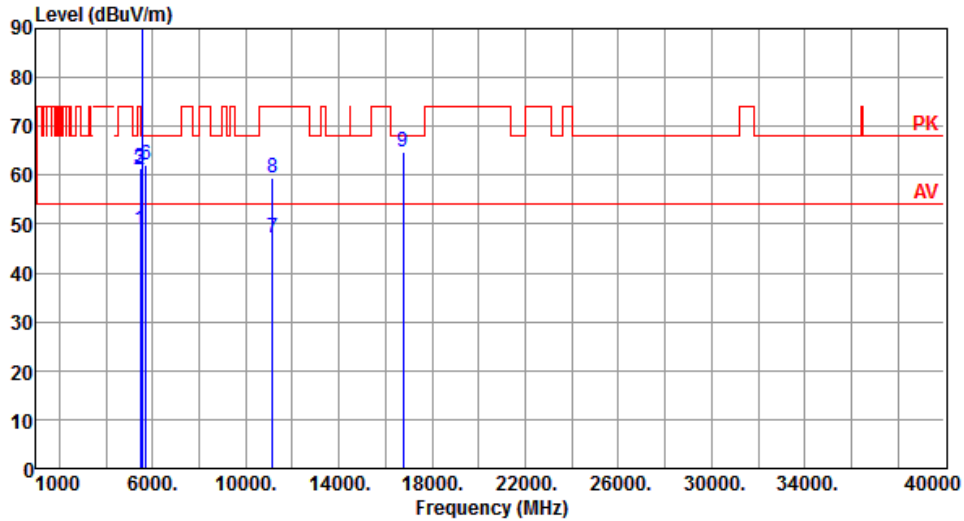

	Freq. MHz	Emission level dBUV/m	Limit dBUV/m	Margin dB	SA reading dBUV	Factor dB	Remark	ANT High cm	Turn Table deg
1	5460.00	48.80	54.00	-5.20	41.63	7.17	Average	194	346
2	5460.00	61.07	74.00	-12.93	53.90	7.17	Peak	194	346
3	5470.00	61.47	68.20	-6.73	54.25	7.22	Peak	194	346
4 *	5580.00	107.45			99.97	7.48	Average	194	346
5 *	5580.00	119.01			111.53	7.48	Peak	194	346
6	5725.00	62.18	68.20	-6.02	54.62	7.56	Peak	194	346
7	11160.00	47.20	54.00	-6.80	30.67	16.53	Average	100	187
8	11160.00	59.49	74.00	-14.51	42.96	16.53	Peak	100	187
9	16740.00	64.87	68.20	-3.33	45.40	19.47	Peak	100	189

Note 1: Emission Level (dBUV/m) = SA Reading (dBUV/m) + Factor* (dB)

*Factor includes antenna factor , cable loss and amplifier gain

Note 2: Margin (dB) = Emission level (dBUV/m) – Limit (dBUV/m).

Note 3: "*" is Peak / Average value of fundamental frequency

Modulation	ax (HE20)	Test Freq. (MHz)	5580
Polarization	Vertical	Test Configuration	1

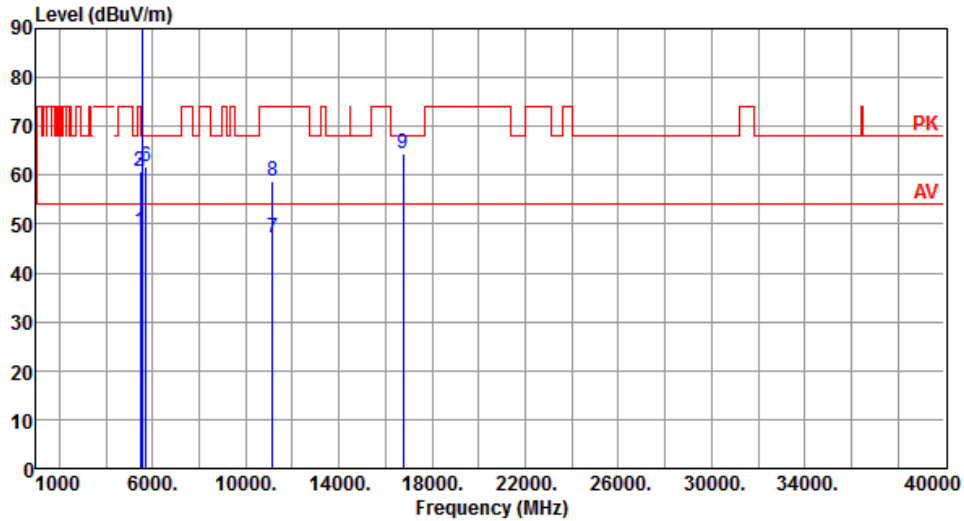

	Freq. MHz	Emission level dBUV/m	Limit dBUV/m	Margin dB	SA reading dBUV	Factor dB	Remark	ANT High cm	Turn Table deg
1	5460.00	48.32	54.00	-5.68	41.15	7.17	Average	222	334
2	5460.00	60.71	74.00	-13.29	53.54	7.17	Peak	222	334
3	5470.00	60.90	68.20	-7.30	53.68	7.22	Peak	222	334
4 *	5580.00	106.33	---	---	98.85	7.48	Average	222	334
5 *	5580.00	117.94	---	---	110.46	7.48	Peak	222	334
6	5725.00	61.79	68.20	-6.41	54.23	7.56	Peak	222	334
7	11160.00	47.05	54.00	-6.95	30.52	16.53	Average	100	48
8	11160.00	58.89	74.00	-15.11	42.36	16.53	Peak	100	48
9	16740.00	64.34	68.20	-3.86	44.87	19.47	Peak	100	52

Note 1: Emission Level (dBUV/m) = SA Reading (dBUV/m) + Factor* (dB)

*Factor includes antenna factor , cable loss and amplifier gain

Note 2: Margin (dB) = Emission level (dBUV/m) – Limit (dBUV/m).

Note 3: "*" is Peak / Average value of fundamental frequency

Modulation	ax (HE20)	Test Freq. (MHz)	5700
Polarization	Horizontal	Test Configuration	1

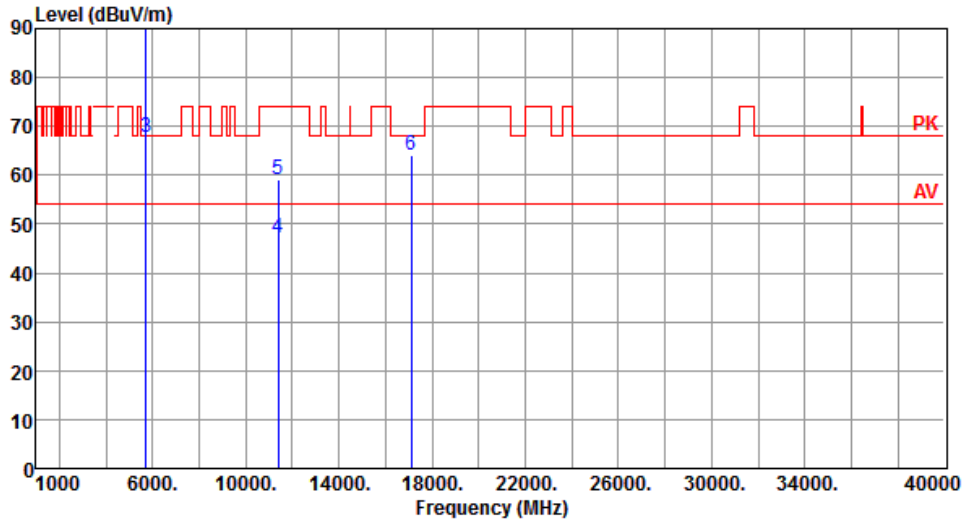

		Freq. MHz	Emission level dBuV/m	Limit dBuV/m	Margin dB	SA reading dBuV	Factor dB	Remark	ANT High cm	Turn Table deg
1	*	5700.00	102.66			95.26	7.40	Average	169	342
2	*	5700.00	115.62			108.22	7.40	Peak	169	342
3		5725.00	67.91	68.20	-0.29	60.35	7.56	Peak	169	342
4		11400.00	47.15	54.00	-6.85	30.32	16.83	Average	100	183
5		11400.00	59.16	74.00	-14.84	42.33	16.83	Peak	100	183
6		17100.00	64.09	68.20	-4.11	44.35	19.74	Peak	100	182

Note 1: Emission Level (dBuV/m) = SA Reading (dBuV/m) + Factor* (dB)

*Factor includes antenna factor , cable loss and amplifier gain

Note 2: Margin (dB) = Emission level (dBuV/m) – Limit (dBuV/m).

Note 3: "*" is Peak / Average value of fundamental frequency

Modulation	ax (HE20)	Test Freq. (MHz)	5700
Polarization	Vertical	Test Configuration	1

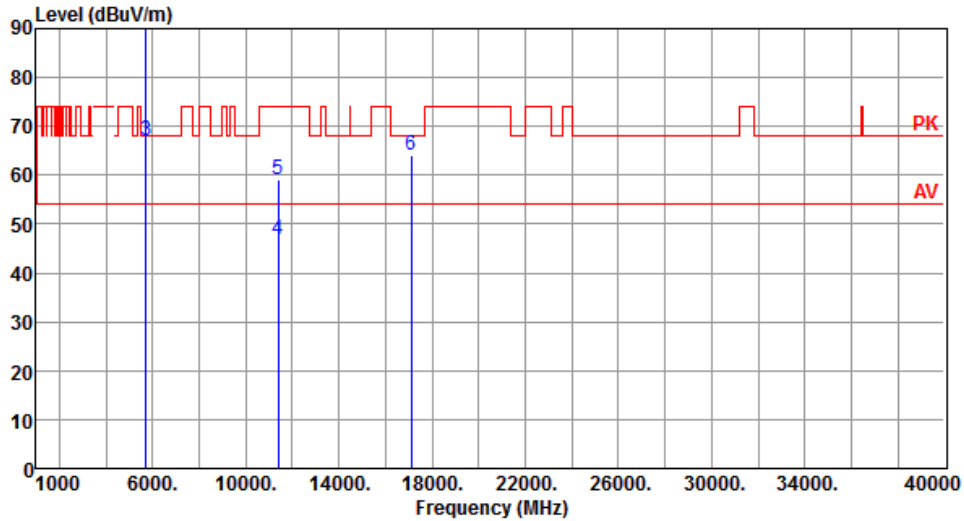

		Freq.	Emission	Limit	Margin	SA	Factor	Remark	ANT	Turn
		MHz	level	dBuV/m	dB	reading	dB		High	Table
			dBuV/m			dBuV			cm	deg
1	*	5700.00	101.72			94.32	7.40	Average	226	320
2	*	5700.00	115.03			107.63	7.40	Peak	226	320
3		5725.00	67.03	68.20	-1.17	59.47	7.56	Peak	226	320
4		11400.00	46.97	54.00	-7.03	30.14	16.83	Average	100	189
5		11400.00	59.10	74.00	-14.90	42.27	16.83	Peak	100	189
6		17100.00	63.99	68.20	-4.21	44.25	19.74	Peak	100	184

Note 1: Emission Level (dBuV/m) = SA Reading (dBuV/m) + Factor* (dB)

*Factor includes antenna factor , cable loss and amplifier gain

Note 2: Margin (dB) = Emission level (dBuV/m) – Limit (dBuV/m).

Note 3: "*" is Peak / Average value of fundamental frequency

Modulation	ax (HE20)	Test Freq. (MHz)	5720
Polarization	Horizontal	Test Configuration	1

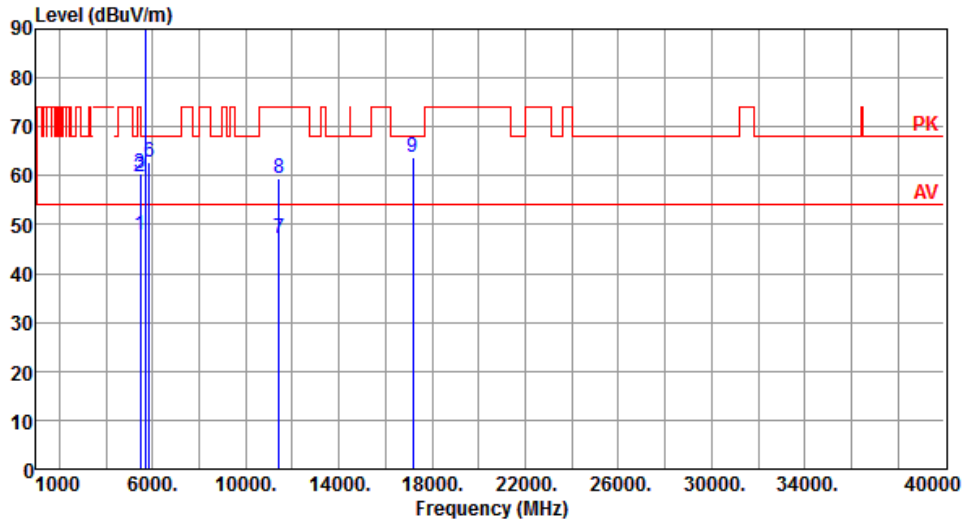

	Freq. MHz	Emission level dBuV/m	Limit dBuV/m	Margin dB	SA reading dBuV	Factor dB	Remark	ANT High cm	Turn Table deg
1	5460.00	47.70	54.00	-6.30	40.33	7.37	Average	192	341
2	5460.00	59.71	74.00	-14.29	52.34	7.37	Peak	192	341
3	5470.00	60.31	68.20	-7.89	52.89	7.42	Peak	192	341
4 *	5720.00	107.80			100.06	7.74	Average	192	341
5 *	5720.00	119.66			111.92	7.74	Peak	192	341
6	5850.00	62.66	68.20	-5.54	54.54	8.12	Peak	192	341
7	11440.00	47.18	54.00	-6.82	30.40	16.78	Average	100	183
8	11440.00	59.54	74.00	-14.46	42.76	16.78	Peak	100	183
9	17160.00	63.91	68.20	-4.29	45.41	18.50	Peak	100	190

Note 1: Emission Level (dBuV/m) = SA Reading (dBuV/m) + Factor* (dB)

*Factor includes antenna factor , cable loss and amplifier gain

Note 2: Margin (dB) = Emission level (dBuV/m) – Limit (dBuV/m).

Note 3: "*" is Peak / Average value of fundamental frequency

Modulation	ax (HE20)	Test Freq. (MHz)	5720
Polarization	Vertical	Test Configuration	1

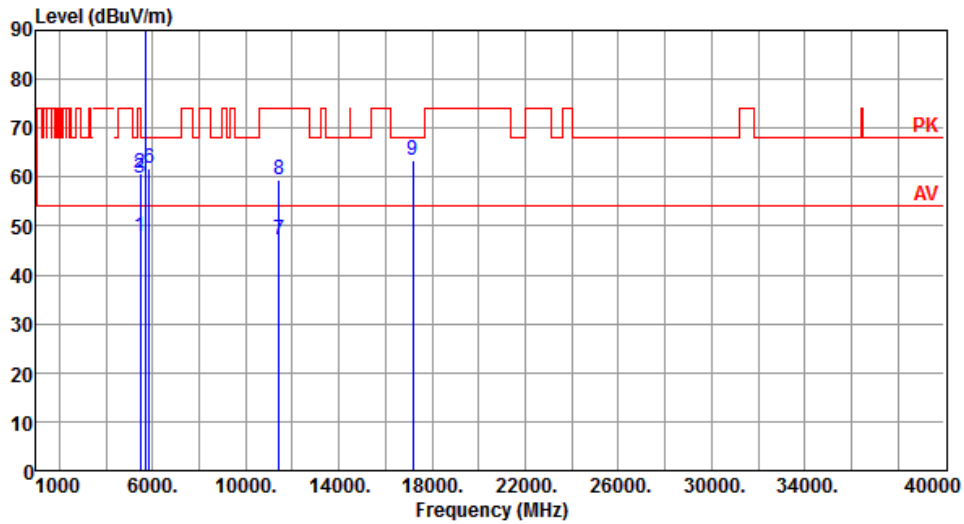

	Freq. MHz	Emission level dBuV/m	Limit dBuV/m	Margin dB	SA reading dBuV	Factor dB	Remark	ANT High cm	Turn Table deg
1	5460.00	47.71	54.00	-6.29	40.34	7.37	Average	223	335
2	5460.00	60.78	74.00	-13.22	53.41	7.37	Peak	223	335
3	5470.00	59.64	68.20	-8.56	52.22	7.42	Peak	223	335
4 *	5720.00	106.69			98.95	7.74	Average	223	335
5 *	5720.00	118.33			110.59	7.74	Peak	223	335
6	5850.00	61.85	68.20	-6.35	53.73	8.12	Peak	223	335
7	11440.00	47.28	54.00	-6.72	30.50	16.78	Average	100	50
8	11440.00	59.48	74.00	-14.52	42.70	16.78	Peak	100	50
9	17160.00	63.32	68.20	-4.88	44.82	18.50	Peak	100	53

Note 1: Emission Level (dBuV/m) = SA Reading (dBuV/m) + Factor* (dB)

*Factor includes antenna factor , cable loss and amplifier gain

Note 2: Margin (dB) = Emission level (dBuV/m) – Limit (dBuV/m).

Note 3: "*" is Peak / Average value of fundamental frequency

Modulation	ax (HE20)	Test Freq. (MHz)	5745
Polarization	Horizontal	Test Configuration	1

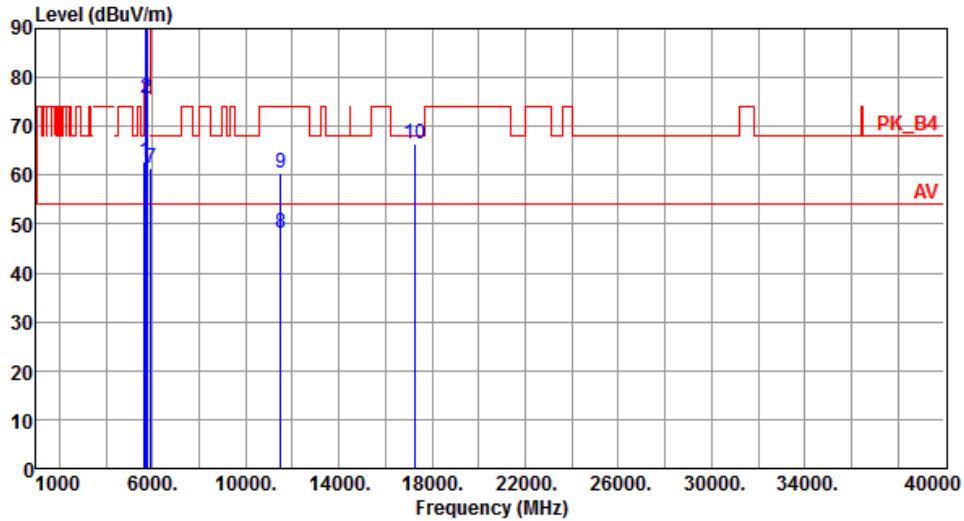

	Freq. MHz	Emission level dBuV/m	Limit dBuV/m	Margin dB	SA reading dBuV	Factor dB	Remark	ANT High cm	Turn Table deg
1	5650.00	62.75	68.20	-5.45	55.36	7.39	Peak	138	17
2	5700.00	75.79	105.20	-29.41	68.39	7.40	Peak	138	17
3	5720.00	88.98	110.80	-21.82	81.46	7.52	Peak	138	17
4	5725.00	93.81	122.20	-28.39	86.25	7.56	Peak	138	17
5 *	5745.00	110.51			102.83	7.68	Average	138	17
6 *	5745.00	122.33			114.65	7.68	Peak	138	17
7	5925.00	61.39	68.20	-6.81	53.22	8.17	Peak	138	17
8	11490.00	48.23	54.00	-5.77	31.46	16.77	Average	235	129
9	11490.00	60.35	74.00	-13.65	43.58	16.77	Peak	235	129
10	17235.00	66.49	68.20	-1.71	46.18	20.31	Peak	320	316

Note 1: Emission Level (dBuV/m) = SA Reading (dBuV/m) + Factor* (dB)

*Factor includes antenna factor , cable loss and amplifier gain

Note 2: Margin (dB) = Emission level (dBuV/m) – Limit (dBuV/m).

Note 3: "*" is Peak / Average value of fundamental frequency

Modulation	ax (HE20)	Test Freq. (MHz)	5745
Polarization	Vertical	Test Configuration	1

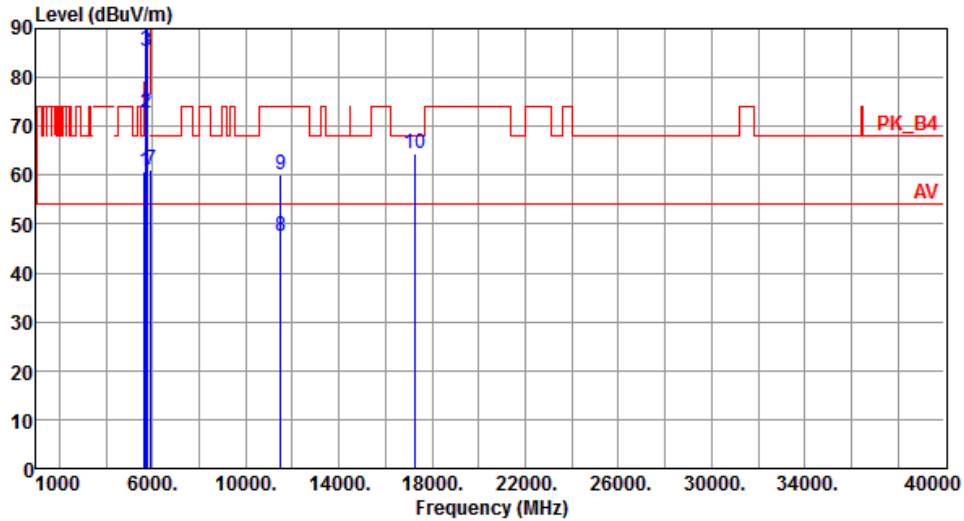

	Freq. MHz	Emission level dBuV/m	Limit dBuV/m	Margin dB	SA reading dBuV	Factor dB	Remark	ANT High cm	Turn Table deg
1	5650.00	60.64	68.20	-7.56	53.25	7.39	Peak	193	332
2	5700.00	72.65	105.20	-32.55	65.25	7.40	Peak	193	332
3	5720.00	85.38	110.80	-25.42	77.86	7.52	Peak	193	332
4	5725.00	90.80	122.20	-31.40	83.24	7.56	Peak	193	332
5 *	5745.00	109.23			101.55	7.68	Average	193	332
6 *	5745.00	121.20			113.52	7.68	Peak	193	332
7	5925.00	61.18	68.20	-7.02	53.01	8.17	Peak	193	332
8	11490.00	47.63	54.00	-6.37	30.86	16.77	Average	100	120
9	11490.00	59.98	74.00	-14.02	43.21	16.77	Peak	100	120
10	17235.00	64.36	68.20	-3.84	44.05	20.31	Peak	100	244

Note 1: Emission Level (dBuV/m) = SA Reading (dBuV/m) + Factor* (dB)

*Factor includes antenna factor , cable loss and amplifier gain

Note 2: Margin (dB) = Emission level (dBuV/m) – Limit (dBuV/m).

Note 3: "*" is Peak / Average value of fundamental frequency

Modulation	ax (HE20)	Test Freq. (MHz)	5785
Polarization	Horizontal	Test Configuration	1

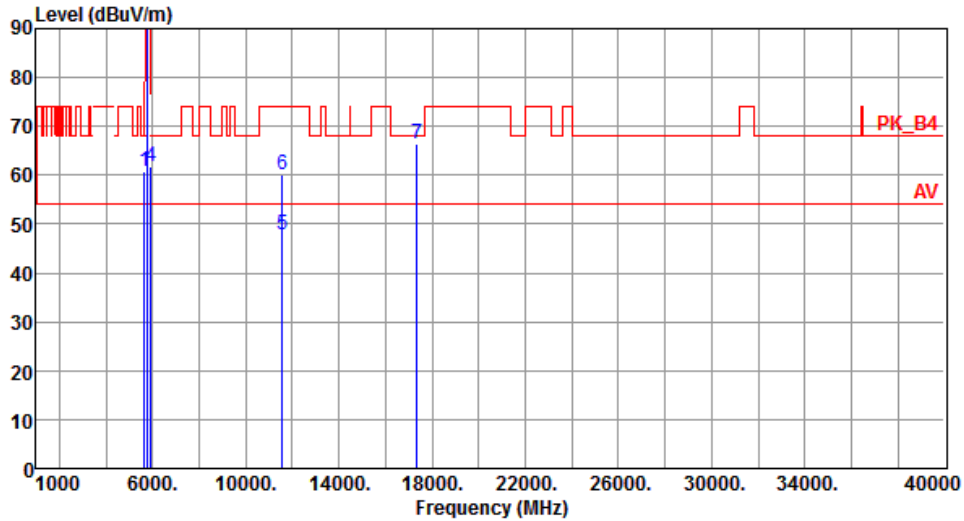

	Freq. MHz	Emission level dBUV/m	Limit dBUV/m	Margin dB	SA reading dBUV	Factor dB	Remark	ANT High cm	Turn Table deg
1	5650.00	60.61	68.20	-7.59	53.22	7.39	Peak	142	25
2 *	5785.00	110.63			102.85	7.78	Average	142	25
3 *	5785.00	122.45			114.67	7.78	Peak	142	25
4	5925.00	61.78	68.20	-6.42	53.61	8.17	Peak	142	25
5	11570.00	47.98	54.00	-6.02	31.23	16.75	Average	240	121
6	11570.00	60.21	74.00	-13.79	43.46	16.75	Peak	240	121
7	17355.00	66.34	68.20	-1.86	45.45	20.89	Peak	296	314

Note 1: Emission Level (dBUV/m) = SA Reading (dBUV/m) + Factor* (dB)

*Factor includes antenna factor , cable loss and amplifier gain

Note 2: Margin (dB) = Emission level (dBUV/m) – Limit (dBUV/m).

Note 3: "*" is Peak / Average value of fundamental frequency

Modulation	ax (HE20)	Test Freq. (MHz)	5785
Polarization	Vertical	Test Configuration	1

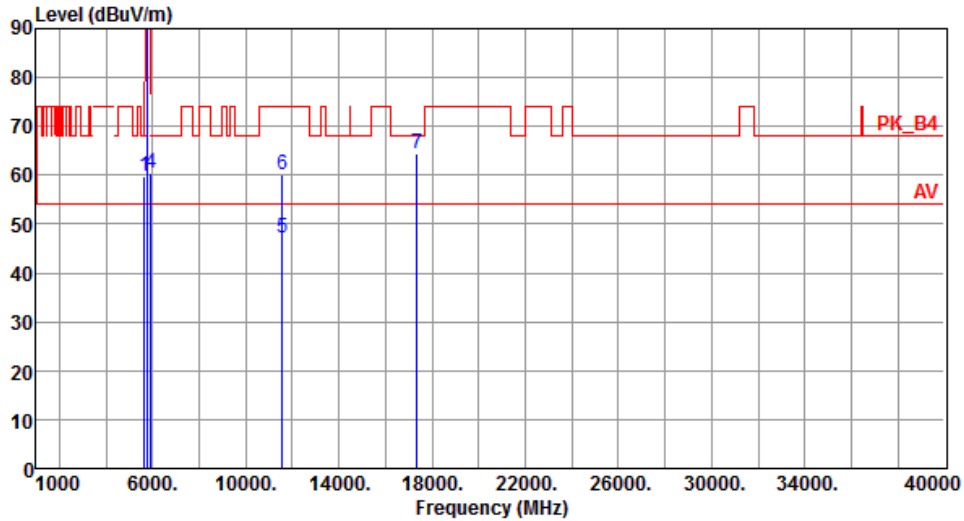

	Freq. MHz	Emission level dBuV/m	Limit dBuV/m	Margin dB	SA reading dBuV	Factor dB	Remark	ANT High cm	Turn Table deg
1	5650.00	59.92	68.20	-8.28	52.53	7.39	Peak	186	329
2 *	5785.00	109.03			101.25	7.78	Average	186	329
3 *	5785.00	121.34			113.56	7.78	Peak	186	329
4	5925.00	60.32	68.20	-7.88	52.15	8.17	Peak	186	329
5	11570.00	47.31	54.00	-6.69	30.56	16.75	Average	100	129
6	11570.00	60.26	74.00	-13.74	43.51	16.75	Peak	100	129
7	17355.00	64.50	68.20	-3.70	43.61	20.89	Peak	100	245

Note 1: Emission Level (dBuV/m) = SA Reading (dBuV/m) + Factor* (dB)

*Factor includes antenna factor , cable loss and amplifier gain

Note 2: Margin (dB) = Emission level (dBuV/m) – Limit (dBuV/m).

Note 3: "*" is Peak / Average value of fundamental frequency

Modulation	ax (HE20)	Test Freq. (MHz)	5825
Polarization	Horizontal	Test Configuration	1

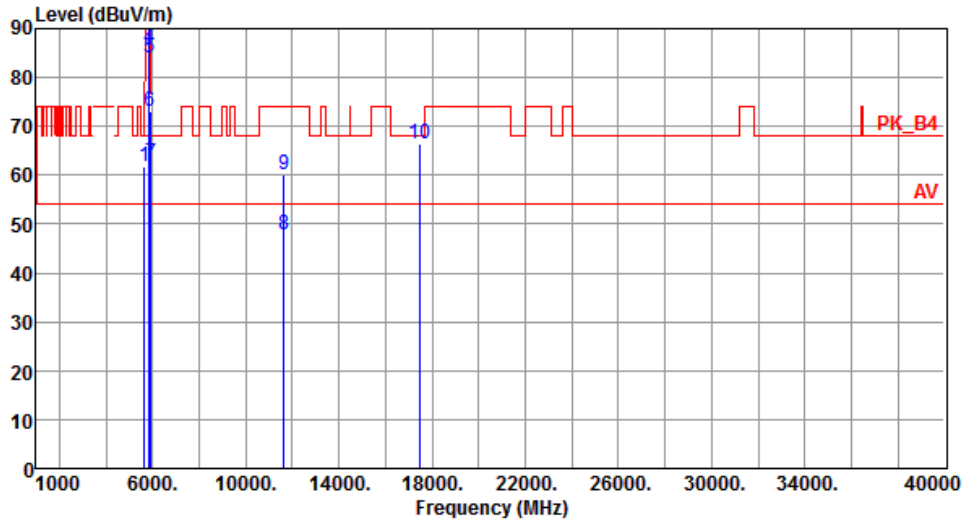

	Freq. MHz	Emission level dBuV/m	Limit dBuV/m	Margin dB	SA reading dBuV	Factor dB	Remark	ANT High cm	Turn Table deg
1	5650.00	61.61	68.20	-6.59	54.22	7.39	Peak	142	23
2 *	5825.00	110.72			102.81	7.91	Average	142	23
3 *	5825.00	112.67			104.76	7.91	Peak	142	23
4	5850.00	85.90	122.20	-36.30	77.88	8.02	Peak	142	23
5	5855.00	83.99	110.80	-26.81	75.96	8.03	Peak	142	23
6	5875.00	72.93	105.20	-32.27	64.85	8.08	Peak	142	23
7	5925.00	62.51	68.20	-5.69	54.34	8.17	Peak	142	23
8	11650.00	47.81	54.00	-6.19	31.28	16.53	Average	233	124
9	11650.00	59.95	74.00	-14.05	43.42	16.53	Peak	233	124
10	17475.00	66.47	68.20	-1.73	44.96	21.51	Peak	283	290

Note 1: Emission Level (dBuV/m) = SA Reading (dBuV/m) + Factor* (dB)

*Factor includes antenna factor , cable loss and amplifier gain

Note 2: Margin (dB) = Emission level (dBuV/m) – Limit (dBuV/m).

Note 3: "*" is Peak / Average value of fundamental frequency

Modulation	ax (HE20)	Test Freq. (MHz)	5825
Polarization	Vertical	Test Configuration	1

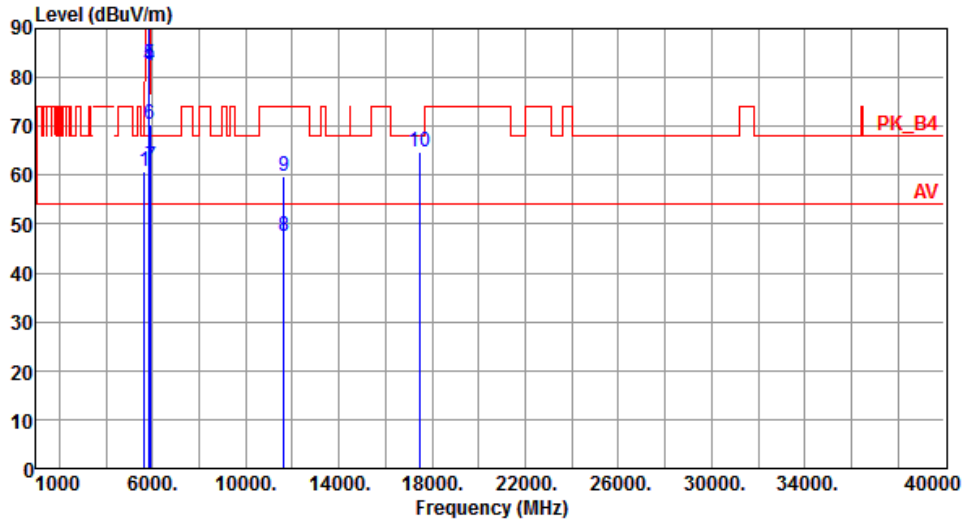

	Freq. MHz	Emission level dBuV/m	Limit dBuV/m	Margin dB	SA reading dBuV	Factor dB	Remark	ANT High cm	Turn Table deg
1	5650.00	60.67	68.20	-7.53	53.28	7.39	Peak	187	328
2 *	5825.00	109.61			101.70	7.91	Average	187	328
3 *	5825.00	111.44			103.53	7.91	Peak	187	328
4	5850.00	82.27	122.20	-39.93	74.25	8.02	Peak	187	328
5	5855.00	82.61	110.80	-28.19	74.58	8.03	Peak	187	328
6	5875.00	70.37	105.20	-34.83	62.29	8.08	Peak	187	328
7	5925.00	61.76	68.20	-6.44	53.59	8.17	Peak	187	328
8	11650.00	47.39	54.00	-6.61	30.86	16.53	Average	100	127
9	11650.00	59.73	74.00	-14.27	43.20	16.53	Peak	100	127
10	17475.00	64.71	68.20	-3.49	43.20	21.51	Peak	100	247

Note 1: Emission Level (dBuV/m) = SA Reading (dBuV/m) + Factor* (dB)

*Factor includes antenna factor , cable loss and amplifier gain

Note 2: Margin (dB) = Emission level (dBuV/m) – Limit (dBuV/m).

Note 3: "*" is Peak / Average value of fundamental frequency

3.5.3 Transmitter Radiated Unwanted Emissions (Above 1GHz) for ax (HE40)

Modulation	ax (HE40)	Test Freq. (MHz)	5190
Polarization	Horizontal	Test Configuration	1

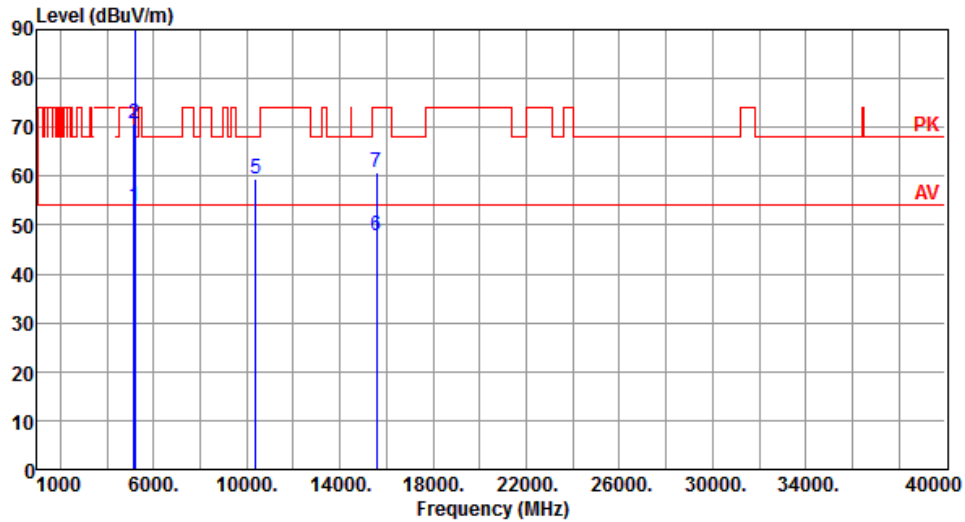

	Freq. MHz	Emission level dBuV/m	Limit dBuV/m	Margin dB	SA reading dBuV	Factor dB	Remark	ANT High cm	Turn Table deg
1	5150.00	53.83	54.00	-0.17	46.71	7.12	Average	209	344
2	5150.00	70.64	74.00	-3.36	63.52	7.12	Peak	209	344
3 *	5190.00	101.22			94.25	6.97	Average	209	344
4 *	5190.00	113.96			106.99	6.97	Peak	209	344
5	10380.00	59.58	68.20	-8.62	43.26	16.32	Peak	100	121
6	15570.00	47.72	54.00	-6.28	30.33	17.39	Average	100	225
7	15570.00	60.64	74.00	-13.36	43.25	17.39	Peak	100	225

Note 1: Emission Level (dBuV/m) = SA Reading (dBuV/m) + Factor* (dB)

*Factor includes antenna factor , cable loss and amplifier gain

Note 2: Margin (dB) = Emission level (dBuV/m) – Limit (dBuV/m).

Note 3: "*" is Peak / Average value of fundamental frequency

Modulation	ax (HE40)	Test Freq. (MHz)	5190
Polarization	Vertical	Test Configuration	1

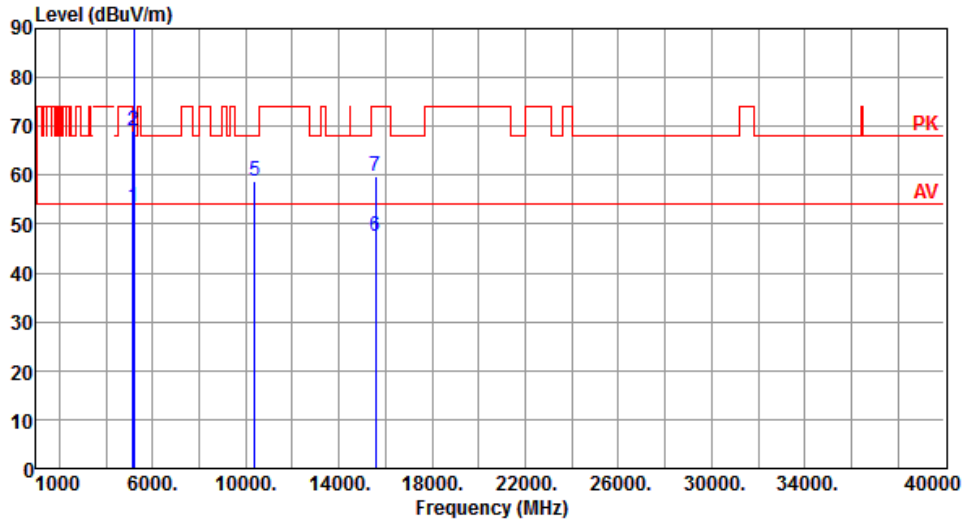

	Freq. MHz	Emission level dBuV/m	Limit dBuV/m	Margin dB	SA reading dBuV	Factor dB	Remark	ANT High cm	Turn Table deg
1	5150.00	53.40	54.00	-0.60	46.28	7.12	Average	196	326
2	5150.00	69.00	74.00	-5.00	61.88	7.12	Peak	196	326
3 *	5190.00	100.60			93.63	6.97	Average	196	326
4 *	5190.00	112.59			105.62	6.97	Peak	196	326
5	10380.00	58.65	68.20	-9.55	42.33	16.32	Peak	251	17
6	15570.00	47.53	54.00	-6.47	30.14	17.39	Average	284	205
7	15570.00	59.86	74.00	-14.14	42.47	17.39	Peak	284	205

Note 1: Emission Level (dBuV/m) = SA Reading (dBuV/m) + Factor* (dB)

*Factor includes antenna factor , cable loss and amplifier gain

Note 2: Margin (dB) = Emission level (dBuV/m) – Limit (dBuV/m).

Note 3: "*" is Peak / Average value of fundamental frequency

Modulation	ax (HE40)	Test Freq. (MHz)	5230
Polarization	Horizontal	Test Configuration	1

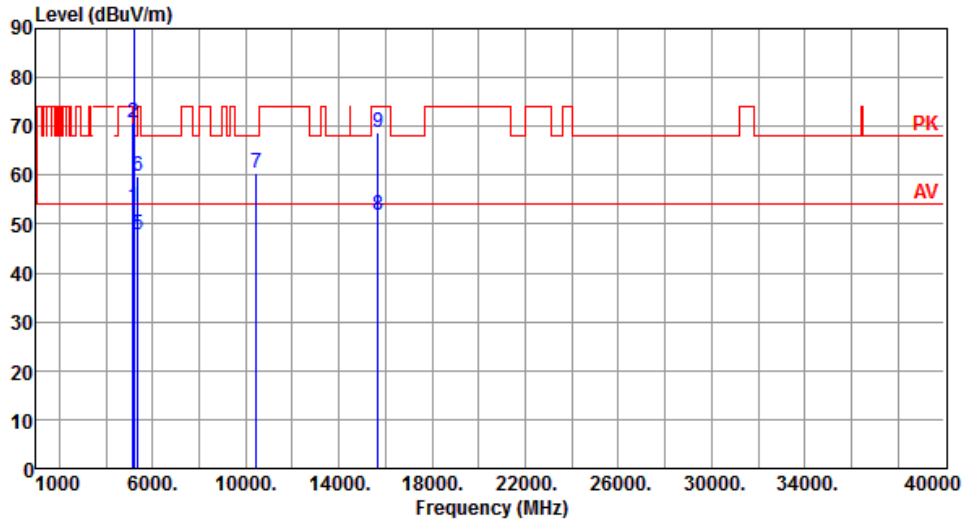

	Freq. MHz	Emission level dBUV/m	Limit dBUV/m	Margin dB	SA reading dBUV	Factor dB	Remark	ANT High cm	Turn Table deg
1	5150.00	53.56	54.00	-0.44	46.44	7.12	Average	175	337
2	5150.00	70.82	74.00	-3.18	63.70	7.12	Peak	175	337
3 *	5230.00	107.49			100.66	6.83	Average	175	337
4 *	5230.00	119.05			112.22	6.83	Peak	175	337
5	5350.00	47.96	54.00	-6.04	41.11	6.85	Average	175	337
6	5350.00	59.81	74.00	-14.19	52.96	6.85	Peak	175	337
7	10460.00	60.37	68.20	-7.83	43.90	16.47	Peak	100	122
8	15690.00	51.83	54.00	-2.17	34.87	16.96	Average	178	214
9	15690.00	68.78	74.00	-5.22	51.82	16.96	Peak	178	214

Note 1: Emission Level (dBUV/m) = SA Reading (dBUV/m) + Factor* (dB)

*Factor includes antenna factor , cable loss and amplifier gain

Note 2: Margin (dB) = Emission level (dBUV/m) – Limit (dBUV/m).

Note 3: "*" is Peak / Average value of fundamental frequency

Modulation	ax (HE40)	Test Freq. (MHz)	5230
Polarization	Vertical	Test Configuration	1

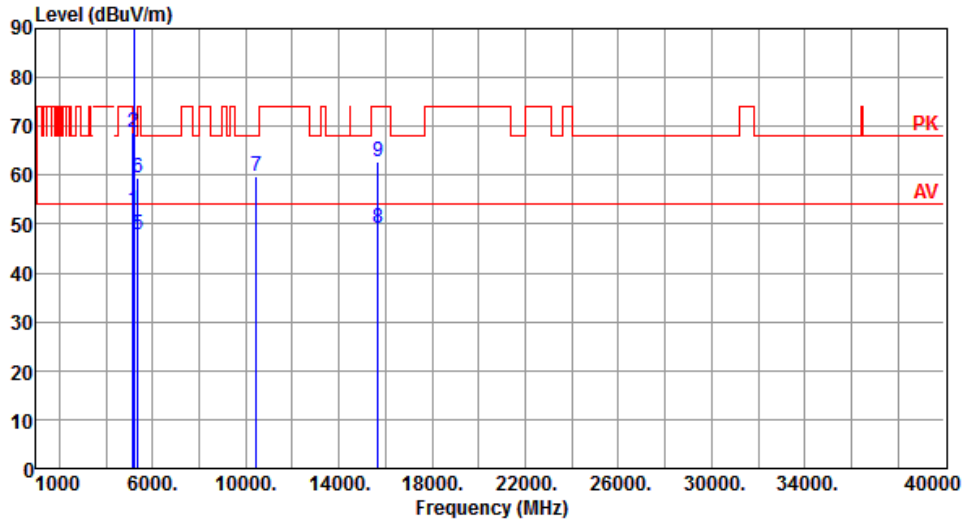

	Freq. MHz	Emission level dBUV/m	Limit dBUV/m	Margin dB	SA reading dBUV	Factor dB	Remark	ANT High cm	Turn Table deg
1	5150.00	52.97	54.00	-1.03	45.85	7.12	Average	200	321
2	5150.00	68.69	74.00	-5.31	61.57	7.12	Peak	200	321
3 *	5230.00	106.70			99.87	6.83	Average	200	321
4 *	5230.00	118.30			111.47	6.83	Peak	200	321
5	5350.00	47.94	54.00	-6.06	41.09	6.85	Average	200	321
6	5350.00	59.32	74.00	-14.68	52.47	6.85	Peak	200	321
7	10460.00	59.73	68.20	-8.47	43.26	16.47	Peak	251	19
8	15690.00	49.07	54.00	-4.93	32.11	16.96	Average	281	212
9	15690.00	62.82	74.00	-11.18	45.86	16.96	Peak	281	212

Note 1: Emission Level (dBUV/m) = SA Reading (dBUV/m) + Factor* (dB)

*Factor includes antenna factor , cable loss and amplifier gain

Note 2: Margin (dB) = Emission level (dBUV/m) – Limit (dBUV/m).

Note 3: "*" is Peak / Average value of fundamental frequency

Modulation	ax (HE40)	Test Freq. (MHz)	5270
Polarization	Horizontal	Test Configuration	1

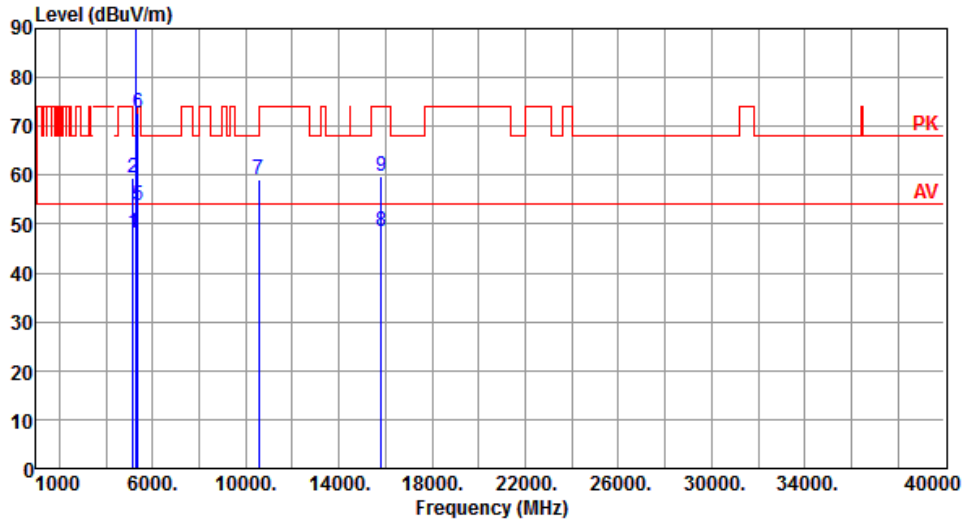

	Freq. MHz	Emission level dBuV/m	Limit dBuV/m	Margin dB	SA reading dBuV	Factor dB	Remark	ANT High cm	Turn Table deg
1	5150.00	48.10	54.00	-5.90	40.98	7.12	Average	198	349
2	5150.00	59.47	74.00	-14.53	52.35	7.12	Peak	198	349
3 *	5270.00	108.68			101.85	6.83	Average	198	349
4 *	5270.00	120.65			113.82	6.83	Peak	198	349
5	5350.00	53.88	54.00	-0.12	47.03	6.85	Average	198	349
6	5350.00	72.75	74.00	-1.25	65.90	6.85	Peak	198	349
7	10540.00	59.11	68.20	-9.09	42.64	16.47	Peak	100	345
8	15810.00	48.49	54.00	-5.51	31.53	16.96	Average	100	351
9	15810.00	59.82	74.00	-14.18	42.86	16.96	Peak	100	351

Note 1: Emission Level (dBuV/m) = SA Reading (dBuV/m) + Factor* (dB)

*Factor includes antenna factor , cable loss and amplifier gain

Note 2: Margin (dB) = Emission level (dBuV/m) – Limit (dBuV/m).

Note 3: "*" is Peak / Average value of fundamental frequency

Modulation	ax (HE40)	Test Freq. (MHz)	5270
Polarization	Vertical	Test Configuration	1

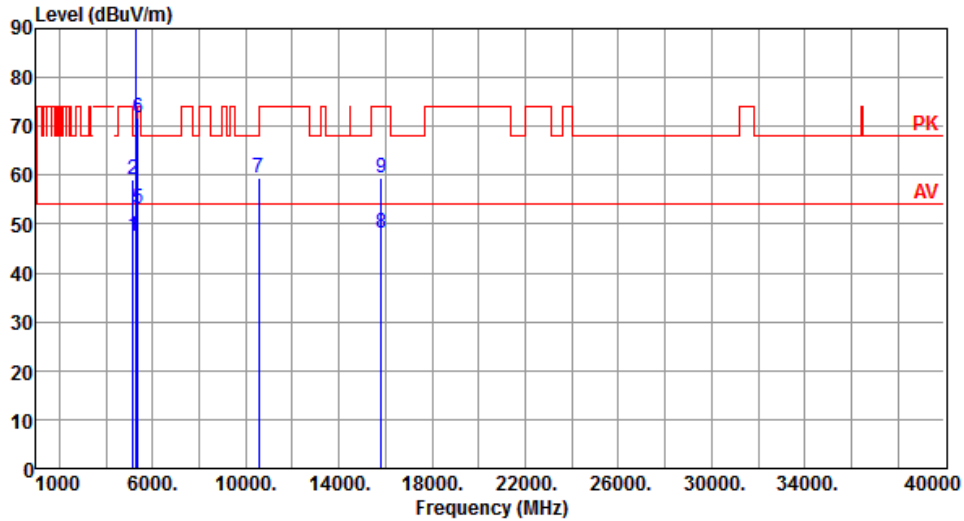

	Freq. MHz	Emission level dBUV/m	Limit dBUV/m	Margin dB	SA reading dBUV	Factor dB	Remark	ANT High cm	Turn Table deg
1	5150.00	47.60	54.00	-6.40	40.48	7.12	Average	222	335
2	5150.00	59.26	74.00	-14.74	52.14	7.12	Peak	222	335
3 *	5270.00	108.28			101.45	6.83	Average	222	335
4 *	5270.00	120.40			113.57	6.83	Peak	222	335
5	5350.00	53.10	54.00	-0.90	46.25	6.85	Average	222	335
6	5350.00	71.74	74.00	-2.26	64.89	6.85	Peak	222	335
7	10540.00	59.32	68.20	-8.88	42.85	16.47	Peak	100	153
8	15810.00	48.20	54.00	-5.80	31.24	16.96	Average	100	188
9	15810.00	59.52	74.00	-14.48	42.56	16.96	Peak	100	188

Note 1: Emission Level (dBUV/m) = SA Reading (dBUV/m) + Factor* (dB)

*Factor includes antenna factor , cable loss and amplifier gain

Note 2: Margin (dB) = Emission level (dBUV/m) – Limit (dBUV/m).

Note 3: "*" is Peak / Average value of fundamental frequency

Modulation	ax (HE40)	Test Freq. (MHz)	5310
Polarization	Horizontal	Test Configuration	1

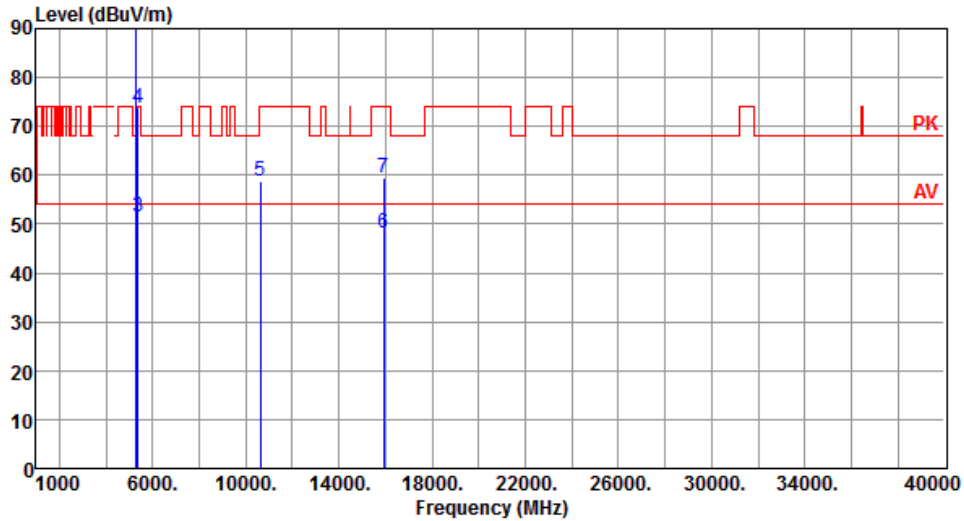

		Freq. MHz	Emission level dBuV/m	Limit dBuV/m	Margin dB	SA reading dBuV	Factor dB	Remark	ANT High cm	Turn Table deg
1	*	5310.00	101.92			95.02	6.90	Average	186	348
2	*	5310.00	114.79			107.89	6.90	Peak	186	348
3		5350.00	51.41	54.00	-2.59	44.56	6.85	Average	186	348
4		5350.00	73.70	74.00	-0.30	66.85	6.85	Peak	186	348
5		10620.00	58.94	74.00	-15.06	42.55	16.39	Peak	100	350
6		15930.00	48.23	54.00	-5.77	31.25	16.98	Average	100	355
7		15930.00	59.56	74.00	-14.44	42.58	16.98	Peak	100	355

Note 1: Emission Level (dBuV/m) = SA Reading (dBuV/m) + Factor* (dB)

*Factor includes antenna factor , cable loss and amplifier gain

Note 2: Margin (dB) = Emission level (dBuV/m) – Limit (dBuV/m).

Note 3: "*" is Peak / Average value of fundamental frequency

Modulation	ax (HE40)	Test Freq. (MHz)	5310
Polarization	Vertical	Test Configuration	1

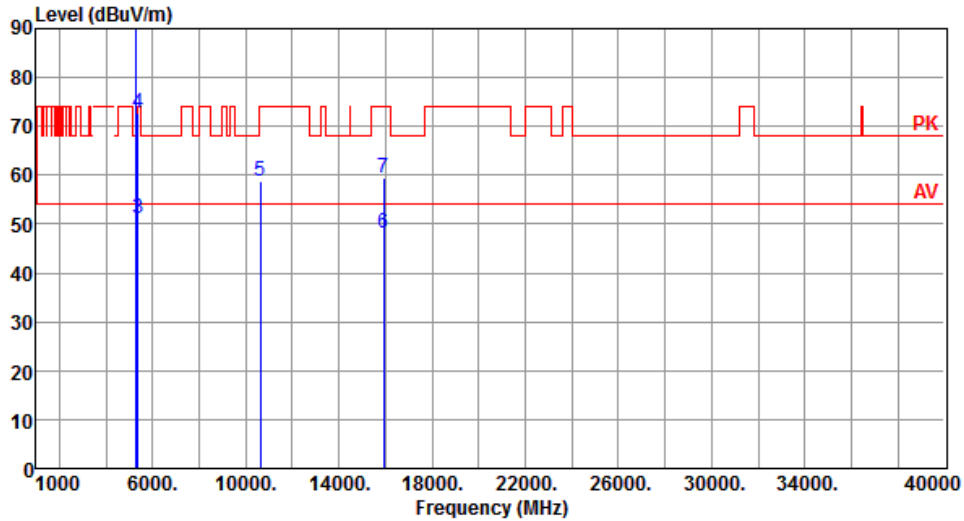

		Freq. MHz	Emission level dBuV/m	Limit dBuV/m	Margin dB	SA reading dBuV	Factor dB	Remark	ANT High cm	Turn Table deg
1	*	5310.00	101.24			94.34	6.90	Average	247	323
2	*	5310.00	113.70			106.80	6.90	Peak	247	323
3		5350.00	51.14	54.00	-2.86	44.29	6.85	Average	247	323
4		5350.00	72.88	74.00	-1.12	66.03	6.85	Peak	247	323
5		10620.00	58.84	74.00	-15.16	42.45	16.39	Peak	100	187
6		15930.00	48.11	54.00	-5.89	31.13	16.98	Average	100	190
7		15930.00	59.52	74.00	-14.48	42.54	16.98	Peak	100	190

Note 1: Emission Level (dBuV/m) = SA Reading (dBuV/m) + Factor* (dB)

*Factor includes antenna factor , cable loss and amplifier gain

Note 2: Margin (dB) = Emission level (dBuV/m) – Limit (dBuV/m).

Note 3: "*" is Peak / Average value of fundamental frequency

Modulation	ax (HE40)	Test Freq. (MHz)	5510
Polarization	Horizontal	Test Configuration	1

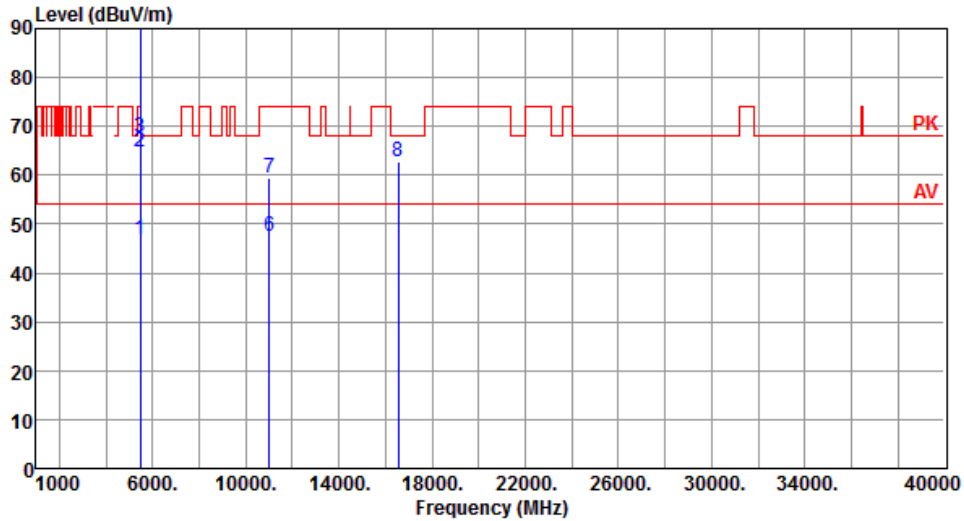

	Freq. MHz	Emission level dBuV/m	Limit dBuV/m	Margin dB	SA reading dBuV	Factor dB	Remark	ANT High cm	Turn Table deg
1	5460.00	46.93	54.00	-7.07	39.76	7.17	Average	176	347
2	5460.00	64.67	74.00	-9.33	57.50	7.17	Peak	176	347
3	5470.00	67.80	68.20	-0.40	60.58	7.22	Peak	176	347
4 *	5510.00	100.03			92.64	7.39	Average	176	347
5 *	5510.00	111.27			103.88	7.39	Peak	176	347
6	11020.00	47.36	54.00	-6.64	30.39	16.97	Average	100	185
7	11020.00	59.36	74.00	-14.64	42.39	16.97	Peak	100	185
8	16530.00	62.81	68.20	-5.39	44.11	18.70	Peak	100	185

Note 1: Emission Level (dBuV/m) = SA Reading (dBuV/m) + Factor* (dB)

*Factor includes antenna factor , cable loss and amplifier gain

Note 2: Margin (dB) = Emission level (dBuV/m) – Limit (dBuV/m).

Note 3: "*" is Peak / Average value of fundamental frequency

Modulation	ax (HE40)	Test Freq. (MHz)	5510
Polarization	Vertical	Test Configuration	1

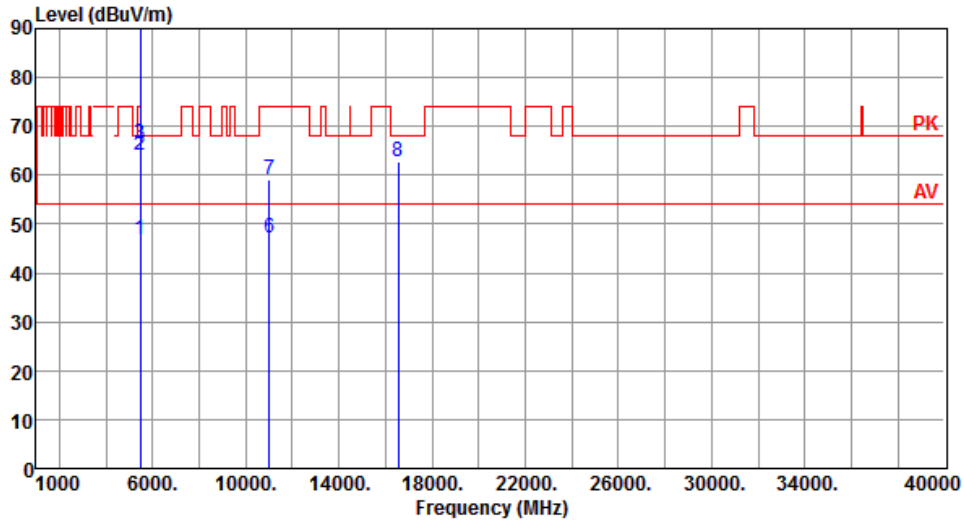

	Freq. MHz	Emission level dBuV/m	Limit dBuV/m	Margin dB	SA reading dBuV	Factor dB	Remark	ANT High cm	Turn Table deg
1	5460.00	46.75	54.00	-7.25	39.58	7.17	Average	278	327
2	5460.00	64.12	74.00	-9.88	56.95	7.17	Peak	278	327
3	5470.00	66.43	68.20	-1.77	59.21	7.22	Peak	278	327
4 *	5510.00	99.43	---	---	92.04	7.39	Average	278	327
5 *	5510.00	110.57	---	---	103.18	7.39	Peak	278	327
6	11020.00	47.18	54.00	-6.82	30.21	16.97	Average	100	188
7	11020.00	59.22	74.00	-14.78	42.25	16.97	Peak	100	188
8	16530.00	62.71	68.20	-5.49	44.01	18.70	Peak	100	191

Note 1: Emission Level (dBuV/m) = SA Reading (dBuV/m) + Factor* (dB)

*Factor includes antenna factor , cable loss and amplifier gain

Note 2: Margin (dB) = Emission level (dBuV/m) – Limit (dBuV/m).

Note 3: "*" is Peak / Average value of fundamental frequency

Modulation	ax (HE40)	Test Freq. (MHz)	5590
Polarization	Horizontal	Test Configuration	1

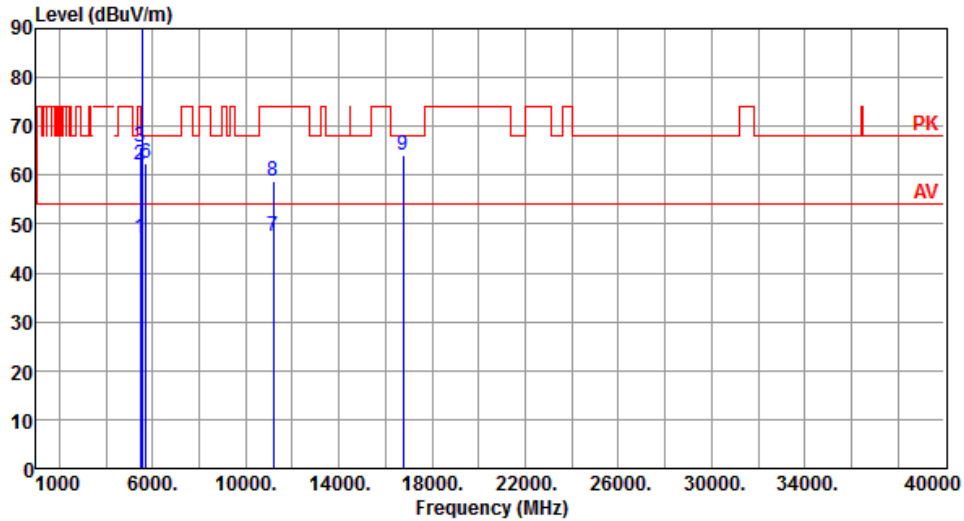

	Freq. MHz	Emission level dBuV/m	Limit dBuV/m	Margin dB	SA reading dBuV	Factor dB	Remark	ANT High cm	Turn Table deg
1	5460.00	47.22	54.00	-6.78	40.05	7.17	Average	198	349
2	5460.00	62.18	74.00	-11.82	55.01	7.17	Peak	198	349
3	5470.00	65.82	68.20	-2.38	58.60	7.22	Peak	198	349
4 *	5590.00	107.59			100.11	7.48	Average	198	349
5 *	5590.00	119.02			111.54	7.48	Peak	198	349
6	5725.00	62.43	68.20	-5.77	54.87	7.56	Peak	198	349
7	11180.00	47.34	54.00	-6.66	30.86	16.48	Average	100	195
8	11180.00	58.87	74.00	-15.13	42.39	16.48	Peak	100	195
9	16770.00	64.16	68.20	-4.04	44.51	19.65	Peak	100	188

Note 1: Emission Level (dBuV/m) = SA Reading (dBuV/m) + Factor* (dB)

*Factor includes antenna factor , cable loss and amplifier gain

Note 2: Margin (dB) = Emission level (dBuV/m) – Limit (dBuV/m).

Note 3: "*" is Peak / Average value of fundamental frequency

Modulation	ax (HE40)	Test Freq. (MHz)	5590
Polarization	Vertical	Test Configuration	1

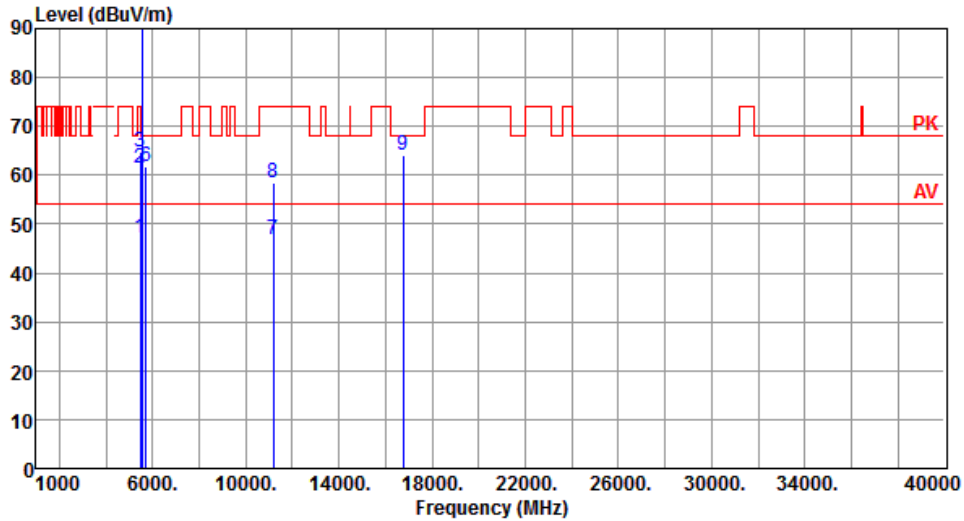

	Freq. MHz	Emission level dBuV/m	Limit dBuV/m	Margin dB	SA reading dBuV	Factor dB	Remark	ANT High cm	Turn Table deg
1	5460.00	47.03	54.00	-6.97	39.86	7.17	Average	222	333
2	5460.00	61.43	74.00	-12.57	54.26	7.17	Peak	222	333
3	5470.00	64.71	68.20	-3.49	57.49	7.22	Peak	222	333
4 *	5590.00	106.74	---	---	99.26	7.48	Average	222	333
5 *	5590.00	118.17	---	---	110.69	7.48	Peak	222	333
6	5725.00	61.67	68.20	-6.53	54.11	7.56	Peak	222	333
7	11180.00	46.96	54.00	-7.04	30.48	16.48	Average	100	55
8	11180.00	58.59	74.00	-15.41	42.11	16.48	Peak	100	55
9	16770.00	63.98	68.20	-4.22	44.33	19.65	Peak	100	44

Note 1: Emission Level (dBuV/m) = SA Reading (dBuV/m) + Factor* (dB)

*Factor includes antenna factor , cable loss and amplifier gain

Note 2: Margin (dB) = Emission level (dBuV/m) – Limit (dBuV/m).

Note 3: "*" is Peak / Average value of fundamental frequency

Modulation	ax (HE40)	Test Freq. (MHz)	5670
Polarization	Horizontal	Test Configuration	1

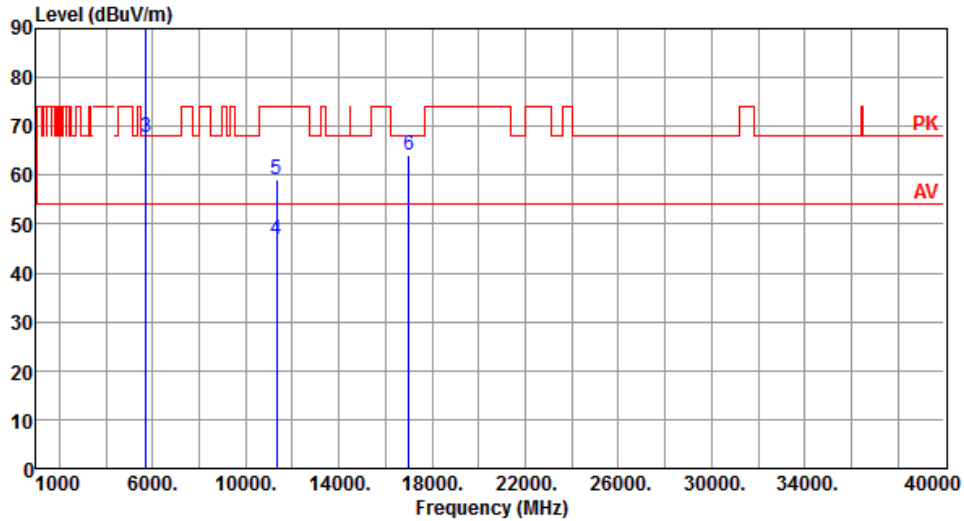

		Freq. MHz	Emission level dBuV/m	Limit dBuV/m	Margin dB	SA reading dBuV	Factor dB	Remark	ANT High cm	Turn Table deg
1	*	5670.00	100.76			93.37	7.39	Average	165	346
2	*	5670.00	114.18			106.79	7.39	Peak	165	346
3		5725.00	67.72	68.20	-0.48	60.16	7.56	Peak	165	346
4		11340.00	46.97	54.00	-7.03	30.35	16.62	Average	100	179
5		11340.00	59.24	74.00	-14.76	42.62	16.62	Peak	100	179
6		17010.00	64.17	68.20	-4.03	44.28	19.89	Peak	100	188

Note 1: Emission Level (dBuV/m) = SA Reading (dBuV/m) + Factor* (dB)

*Factor includes antenna factor , cable loss and amplifier gain

Note 2: Margin (dB) = Emission level (dBuV/m) – Limit (dBuV/m).

Note 3: "*" is Peak / Average value of fundamental frequency

Modulation	ax (HE40)	Test Freq. (MHz)	5670
Polarization	Vertical	Test Configuration	1

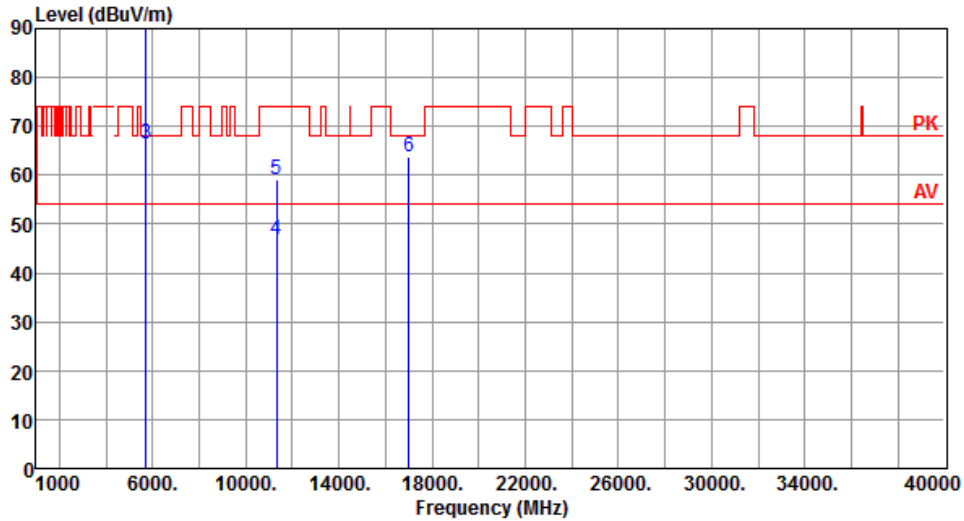

		Freq. MHz	Emission level dBuV/m	Limit dBuV/m	Margin dB	SA reading dBuV	Factor dB	Remark	ANT High cm	Turn Table deg
1	*	5670.00	100.24			92.85	7.39	Average	234	324
2	*	5670.00	113.60			106.21	7.39	Peak	234	324
3		5725.00	66.43	68.20	-1.77	58.87	7.56	Peak	234	324
4		11340.00	46.83	54.00	-7.17	30.21	16.62	Average	100	183
5		11340.00	59.18	74.00	-14.82	42.56	16.62	Peak	100	183
6		17010.00	63.91	68.20	-4.29	44.02	19.89	Peak	100	185

Note 1: Emission Level (dBuV/m) = SA Reading (dBuV/m) + Factor* (dB)

*Factor includes antenna factor , cable loss and amplifier gain

Note 2: Margin (dB) = Emission level (dBuV/m) – Limit (dBuV/m).

Note 3: "*" is Peak / Average value of fundamental frequency

Modulation	ax (HE40)	Test Freq. (MHz)	5710
Polarization	Horizontal	Test Configuration	1

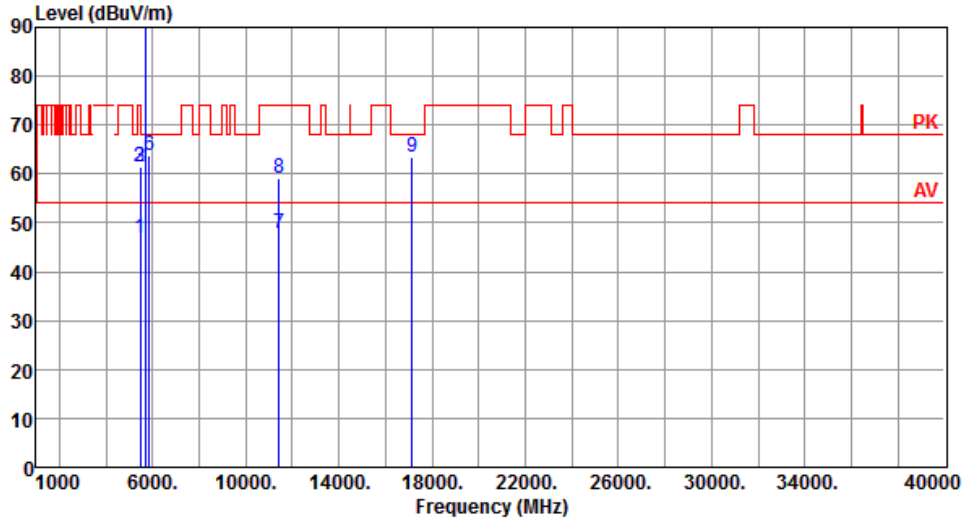

	Freq. MHz	Emission level dBUV/m	Limit dBUV/m	Margin dB	SA reading dBUV	Factor dB	Remark	ANT High cm	Turn Table deg
1	5460.00	46.85	54.00	-7.15	39.48	7.37	Average	199	352
2	5460.00	61.34	74.00	-12.66	53.97	7.37	Peak	199	352
3	5470.00	61.39	68.20	-6.81	53.97	7.42	Peak	199	352
4 *	5710.00	108.03			100.31	7.72	Average	199	352
5 *	5710.00	119.59			111.87	7.72	Peak	199	352
6	5850.00	63.67	68.20	-4.53	55.55	8.12	Peak	199	352
7	11420.00	47.92	54.00	-6.08	31.17	16.75	Average	100	196
8	11420.00	59.06	74.00	-14.94	42.31	16.75	Peak	100	196
9	17130.00	63.30	68.20	-4.90	44.79	18.51	Peak	100	192

Note 1: Emission Level (dBUV/m) = SA Reading (dBUV/m) + Factor* (dB)

*Factor includes antenna factor , cable loss and amplifier gain

Note 2: Margin (dB) = Emission level (dBUV/m) – Limit (dBUV/m).

Note 3: "*" is Peak / Average value of fundamental frequency

Modulation	ax (HE40)	Test Freq. (MHz)	5710
Polarization	Vertical	Test Configuration	1

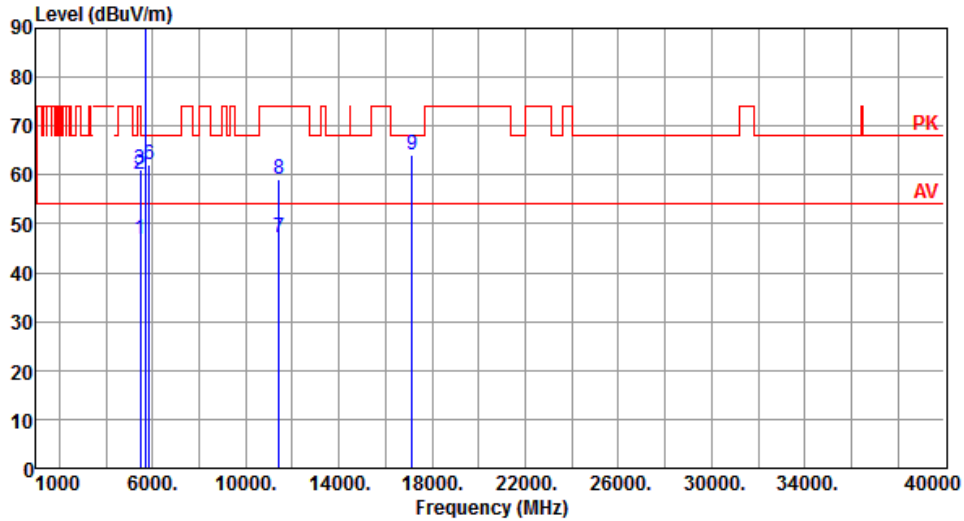

	Freq. MHz	Emission level dBuV/m	Limit dBuV/m	Margin dB	SA reading dBuV	Factor dB	Remark	ANT High cm	Turn Table deg
1	5460.00	46.75	54.00	-7.25	39.38	7.37	Average	221	330
2	5460.00	59.98	74.00	-14.02	52.61	7.37	Peak	221	330
3	5470.00	61.06	68.20	-7.14	53.64	7.42	Peak	221	330
4 *	5710.00	107.11			99.39	7.72	Average	221	330
5 *	5710.00	118.57			110.85	7.72	Peak	221	330
6	5850.00	62.26	68.20	-5.94	54.14	8.12	Peak	221	330
7	11420.00	47.19	54.00	-6.81	30.44	16.75	Average	100	56
8	11420.00	59.00	74.00	-15.00	42.25	16.75	Peak	100	56
9	17130.00	63.94	68.20	-4.26	45.43	18.51	Peak	100	41

Note 1: Emission Level (dBuV/m) = SA Reading (dBuV/m) + Factor* (dB)

*Factor includes antenna factor , cable loss and amplifier gain

Note 2: Margin (dB) = Emission level (dBuV/m) – Limit (dBuV/m).

Note 3: "*" is Peak / Average value of fundamental frequency

Modulation	ax (HE40)	Test Freq. (MHz)	5755
Polarization	Horizontal	Test Configuration	1

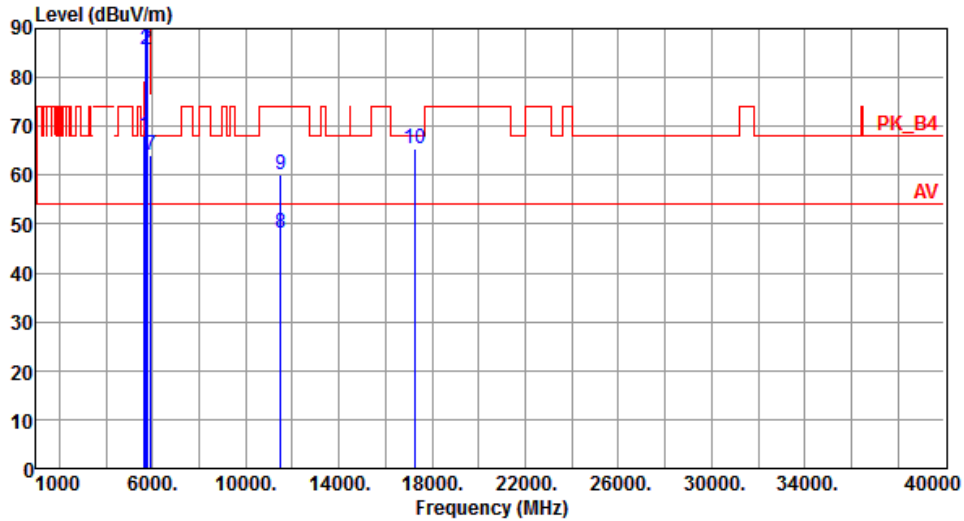

	Freq. MHz	Emission level dBuV/m	Limit dBuV/m	Margin dB	SA reading dBuV	Factor dB	Remark	ANT High cm	Turn Table deg
1	5650.00	67.98	68.20	-0.22	60.59	7.39	Peak	149	20
2	5700.00	85.76	105.20	-19.44	78.36	7.40	Peak	149	20
3	5720.00	97.35	110.80	-13.45	89.83	7.52	Peak	149	20
4	5725.00	97.83	122.20	-24.37	90.27	7.56	Peak	149	20
5 *	5755.00	108.15			100.44	7.71	Average	149	20
6 *	5755.00	119.39			111.68	7.71	Peak	149	20
7	5925.00	64.16	68.20	-4.04	55.99	8.17	Peak	149	20
8	11510.00	48.29	54.00	-5.71	31.52	16.77	Average	244	120
9	11510.00	59.99	74.00	-14.01	43.22	16.77	Peak	244	120
10	17265.00	65.32	68.20	-2.88	44.88	20.44	Peak	240	300

Note 1: Emission Level (dBuV/m) = SA Reading (dBuV/m) + Factor* (dB)

*Factor includes antenna factor , cable loss and amplifier gain

Note 2: Margin (dB) = Emission level (dBuV/m) – Limit (dBuV/m).

Note 3: "*" is Peak / Average value of fundamental frequency

Modulation	ax (HE40)	Test Freq. (MHz)	5755
Polarization	Vertical	Test Configuration	1

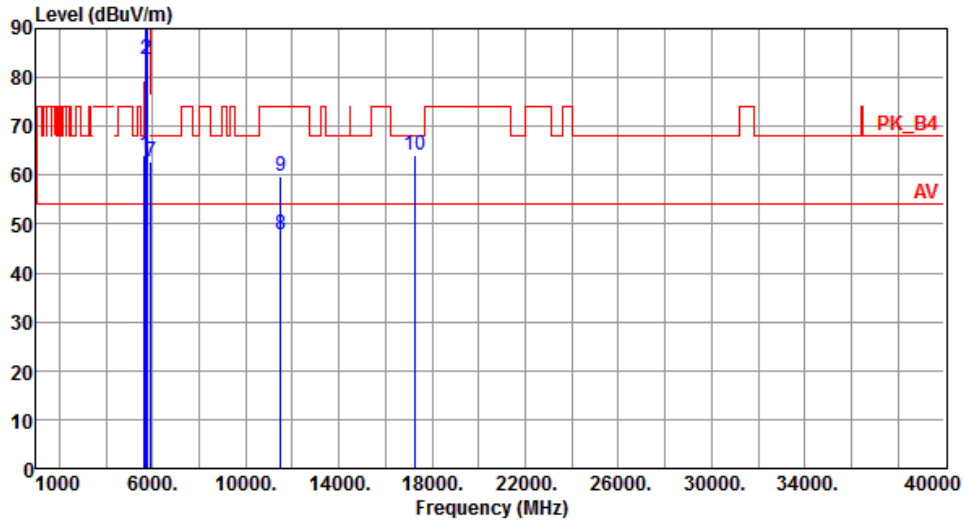

	Freq. MHz	Emission level dBuV/m	Limit dBuV/m	Margin dB	SA reading dBuV	Factor dB	Remark	ANT High cm	Turn Table deg
1	5650.00	64.25	68.20	-3.95	56.86	7.39	Peak	180	322
2	5700.00	83.65	105.20	-21.55	76.25	7.40	Peak	180	322
3	5720.00	93.77	110.80	-17.03	86.25	7.52	Peak	180	322
4	5725.00	92.90	122.20	-29.30	85.34	7.56	Peak	180	322
5 *	5755.00	107.32			99.61	7.71	Average	180	322
6 *	5755.00	118.24			110.53	7.71	Peak	180	322
7	5925.00	62.76	68.20	-5.44	54.59	8.17	Peak	180	322
8	11510.00	47.66	54.00	-6.34	30.89	16.77	Average	100	129
9	11510.00	59.63	74.00	-14.37	42.86	16.77	Peak	100	129
10	17265.00	64.02	68.20	-4.18	43.58	20.44	Peak	100	246

Note 1: Emission Level (dBuV/m) = SA Reading (dBuV/m) + Factor* (dB)

*Factor includes antenna factor , cable loss and amplifier gain

Note 2: Margin (dB) = Emission level (dBuV/m) – Limit (dBuV/m).

Note 3: "*" is Peak / Average value of fundamental frequency

Modulation	ax (HE40)	Test Freq. (MHz)	5795
Polarization	Horizontal	Test Configuration	1

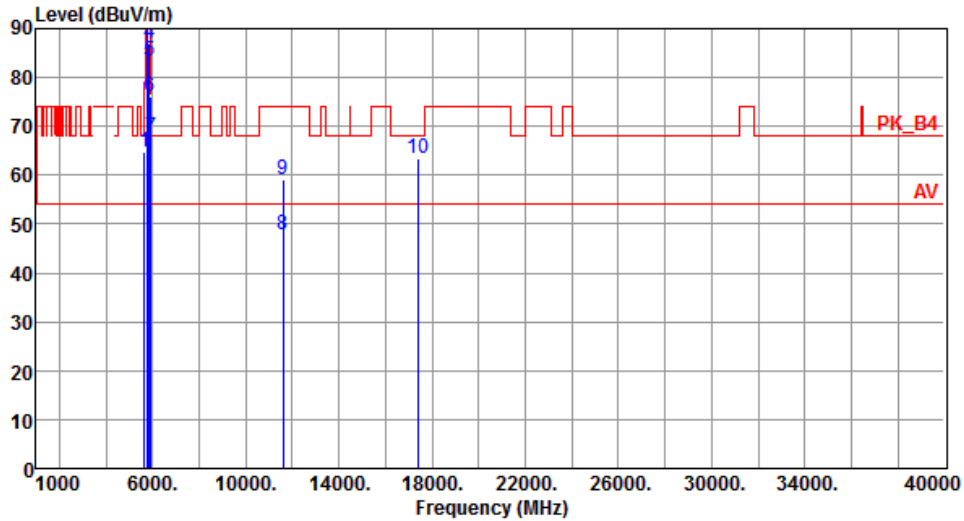

	Freq. MHz	Emission level dBuV/m	Limit dBuV/m	Margin dB	SA reading dBuV	Factor dB	Remark	ANT High cm	Turn Table deg
1	5650.00	64.72	68.20	-3.48	57.33	7.39	Peak	147	29
2 *	5795.00	108.46			100.66	7.80	Average	147	29
3 *	5795.00	119.86			112.06	7.80	Peak	147	29
4	5850.00	87.00	122.20	-35.20	78.98	8.02	Peak	147	29
5	5855.00	83.30	110.80	-27.50	75.27	8.03	Peak	147	29
6	5875.00	76.02	105.20	-29.18	67.94	8.08	Peak	147	29
7	5925.00	67.71	68.20	-0.49	59.54	8.17	Peak	147	29
8	11590.00	47.85	54.00	-6.15	31.10	16.75	Average	204	122
9	11590.00	59.04	74.00	-14.96	42.29	16.75	Peak	204	122
10	17385.00	63.33	68.20	-4.87	42.30	21.03	Peak	236	241

Note 1: Emission Level (dBuV/m) = SA Reading (dBuV/m) + Factor* (dB)

*Factor includes antenna factor , cable loss and amplifier gain

Note 2: Margin (dB) = Emission level (dBuV/m) – Limit (dBuV/m).

Note 3: "*" is Peak / Average value of fundamental frequency

Modulation	ax (HE40)	Test Freq. (MHz)	5795
Polarization	Vertical	Test Configuration	1

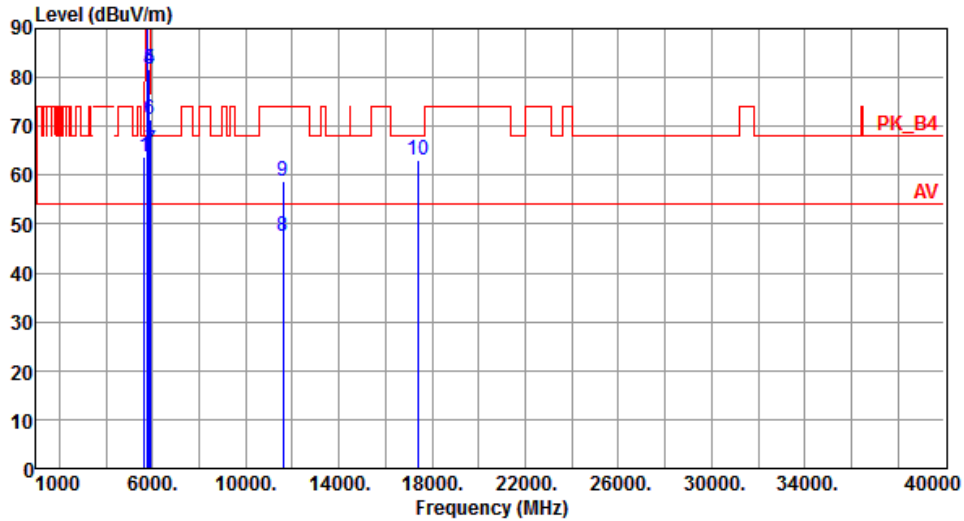

	Freq. MHz	Emission level dBuV/m	Limit dBuV/m	Margin dB	SA reading dBuV	Factor dB	Remark	ANT High cm	Turn Table deg
1	5650.00	63.60	68.20	-4.60	56.21	7.39	Peak	172	317
2 *	5795.00	107.36			99.56	7.80	Average	172	317
3 *	5795.00	118.80			111.00	7.80	Peak	172	317
4	5850.00	81.54	122.20	-40.66	73.52	8.02	Peak	172	317
5	5855.00	81.55	110.80	-29.25	73.52	8.03	Peak	172	317
6	5875.00	71.32	105.20	-33.88	63.24	8.08	Peak	172	317
7	5925.00	65.07	68.20	-3.13	56.90	8.17	Peak	172	317
8	11590.00	47.60	54.00	-6.40	30.85	16.75	Average	100	120
9	11590.00	58.94	74.00	-15.06	42.19	16.75	Peak	100	120
10	17385.00	63.21	68.20	-4.99	42.18	21.03	Peak	100	246

Note 1: Emission Level (dBuV/m) = SA Reading (dBuV/m) + Factor* (dB)

*Factor includes antenna factor , cable loss and amplifier gain

Note 2: Margin (dB) = Emission level (dBuV/m) – Limit (dBuV/m).

Note 3: "*" is Peak / Average value of fundamental frequency

3.5.4 Transmitter Radiated Unwanted Emissions (Above 1GHz) for ax (HE80)

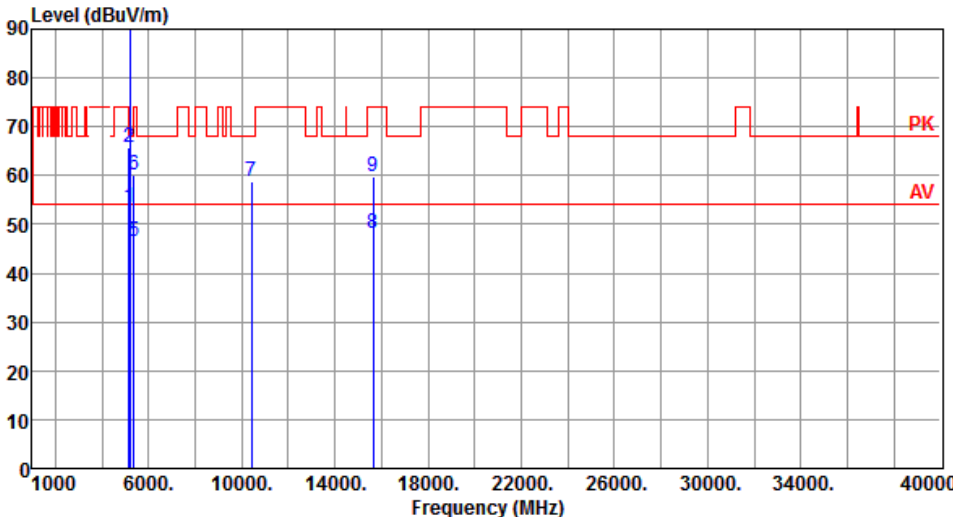
Modulation	ax (HE80)	Test Freq. (MHz)	5210						
Polarization	Horizontal	Test Configuration	1						
									
	Freq. MHz	Emission level dBuV/m	Limit dBuV/m	Margin dB	SA reading dBuV	Factor dB	Remark	ANT High cm	Turn Table deg
1	5150.00	53.53	54.00	-0.47	46.41	7.12	Average	210	342
2	5150.00	65.69	74.00	-8.31	58.57	7.12	Peak	210	342
3 *	5210.00	98.64			91.74	6.90	Average	210	342
4 *	5210.00	109.77			102.87	6.90	Peak	210	342
5	5350.00	46.57	54.00	-7.43	39.72	6.85	Average	210	342
6	5350.00	60.16	74.00	-13.84	53.31	6.85	Peak	210	342
7	10420.00	58.93	68.20	-9.27	42.52	16.41	Peak	100	126
8	15630.00	48.19	54.00	-5.81	30.95	17.24	Average	100	227
9	15630.00	59.92	74.00	-14.08	42.68	17.24	Peak	100	227

Note 1: Emission Level (dBuV/m) = SA Reading (dBuV/m) + Factor* (dB)

*Factor includes antenna factor , cable loss and amplifier gain

Note 2: Margin (dB) = Emission level (dBuV/m) – Limit (dBuV/m).

Note 3: "*" is Peak / Average value of fundamental frequency

Modulation	ax (HE80)	Test Freq. (MHz)	5210
Polarization	Vertical	Test Configuration	1

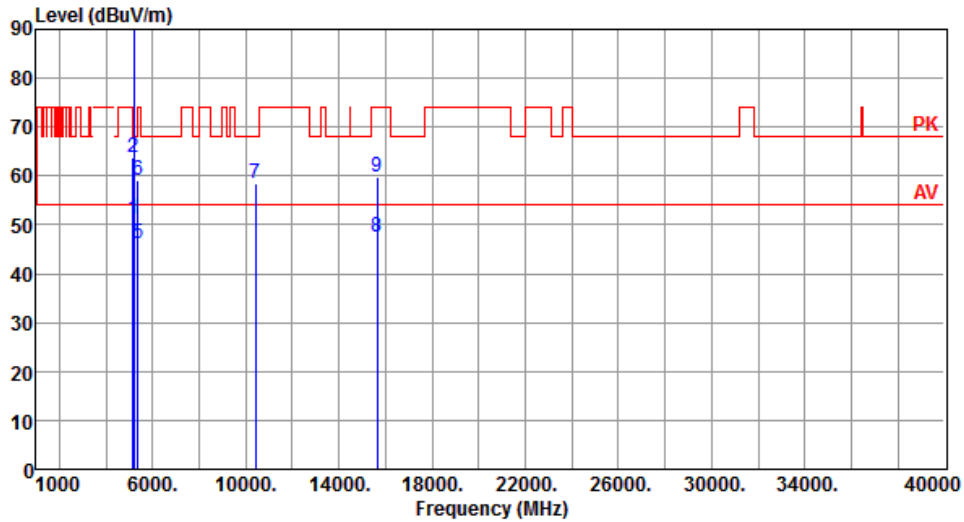

	Freq. MHz	Emission level dBUV/m	Limit dBUV/m	Margin dB	SA reading dBUV	Factor dB	Remark	ANT High cm	Turn Table deg
1	5150.00	51.08	54.00	-2.92	43.96	7.12	Average	245	337
2	5150.00	63.60	74.00	-10.40	56.48	7.12	Peak	245	337
3 *	5210.00	96.35			89.45	6.90	Average	245	337
4 *	5210.00	106.28			99.38	6.90	Peak	245	337
5	5350.00	46.17	54.00	-7.83	39.32	6.85	Average	245	337
6	5350.00	59.26	74.00	-14.74	52.41	6.85	Peak	245	337
7	10420.00	58.58	68.20	-9.62	42.17	16.41	Peak	100	27
8	15630.00	47.48	54.00	-6.52	30.24	17.24	Average	100	355
9	15630.00	59.64	74.00	-14.36	42.40	17.24	Peak	100	355

Note 1: Emission Level (dBUV/m) = SA Reading (dBUV/m) + Factor* (dB)

*Factor includes antenna factor , cable loss and amplifier gain

Note 2: Margin (dB) = Emission level (dBUV/m) – Limit (dBUV/m).

Note 3: "*" is Peak / Average value of fundamental frequency

Modulation	ax (HE80)	Test Freq. (MHz)	5290
Polarization	Horizontal	Test Configuration	1

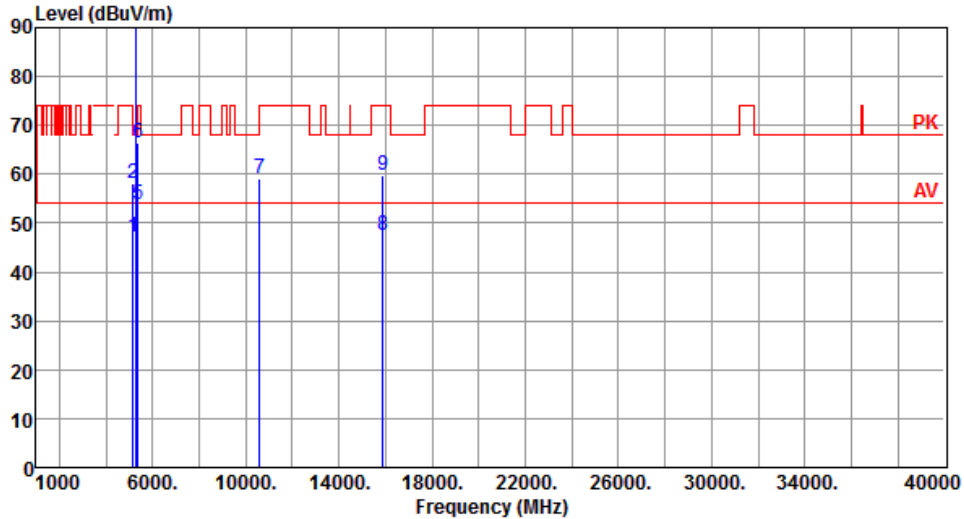

	Freq. MHz	Emission level dBUV/m	Limit dBUV/m	Margin dB	SA reading dBUV	Factor dB	Remark	ANT High cm	Turn Table deg
1	5150.00	47.28	54.00	-6.72	40.16	7.12	Average	191	344
2	5150.00	57.99	74.00	-16.01	50.87	7.12	Peak	191	344
3 *	5290.00	99.80			92.92	6.88	Average	191	344
4 *	5290.00	110.76			103.88	6.88	Peak	191	344
5	5350.00	53.74	54.00	-0.26	46.89	6.85	Average	191	344
6	5350.00	66.40	74.00	-7.60	59.55	6.85	Peak	191	344
7	10580.00	58.96	68.20	-9.24	42.57	16.39	Peak	100	345
8	15870.00	47.61	54.00	-6.39	30.57	17.04	Average	100	350
9	15870.00	59.63	74.00	-14.37	42.59	17.04	Peak	100	350

Note 1: Emission Level (dBUV/m) = SA Reading (dBUV/m) + Factor* (dB)

*Factor includes antenna factor , cable loss and amplifier gain

Note 2: Margin (dB) = Emission level (dBUV/m) – Limit (dBUV/m).

Note 3: "*" is Peak / Average value of fundamental frequency

Modulation	ax (HE80)	Test Freq. (MHz)	5290
Polarization	Vertical	Test Configuration	1

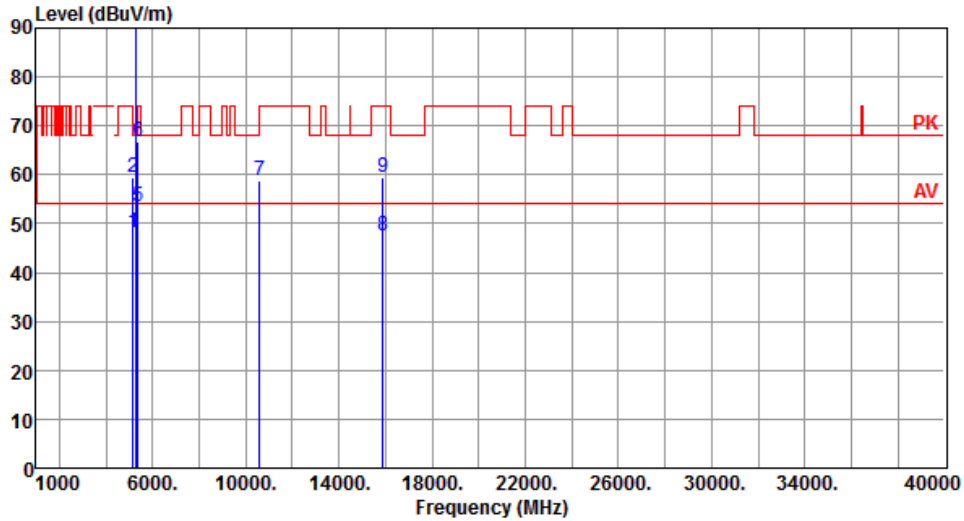

	Freq. MHz	Emission level dBuV/m	Limit dBuV/m	Margin dB	SA reading dBuV	Factor dB	Remark	ANT High cm	Turn Table deg
1	5150.00	48.28	54.00	-5.72	41.16	7.12	Average	251	322
2	5150.00	59.33	74.00	-14.67	52.21	7.12	Peak	251	322
3 *	5290.00	99.06			92.18	6.88	Average	251	322
4 *	5290.00	111.13			104.25	6.88	Peak	251	322
5	5350.00	53.43	54.00	-0.57	46.58	6.85	Average	251	322
6	5350.00	66.73	74.00	-7.27	59.88	6.85	Peak	251	322
7	10580.00	58.85	68.20	-9.35	42.46	16.39	Peak	100	180
8	15870.00	47.47	54.00	-6.53	30.43	17.04	Average	100	189
9	15870.00	59.50	74.00	-14.50	42.46	17.04	Peak	100	189

Note 1: Emission Level (dBuV/m) = SA Reading (dBuV/m) + Factor* (dB)

*Factor includes antenna factor , cable loss and amplifier gain

Note 2: Margin (dB) = Emission level (dBuV/m) – Limit (dBuV/m).

Note 3: "*" is Peak / Average value of fundamental frequency

Modulation	ax (HE80)	Test Freq. (MHz)	5530
Polarization	Horizontal	Test Configuration	1

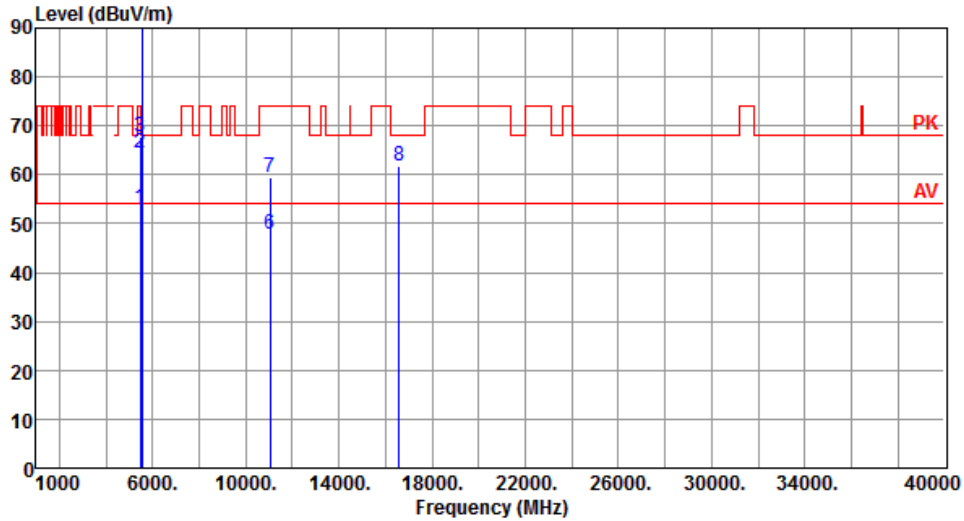

	Freq. MHz	Emission level dBuV/m	Limit dBuV/m	Margin dB	SA reading dBuV	Factor dB	Remark	ANT High cm	Turn Table deg
1	5460.00	53.13	54.00	-0.87	45.96	7.17	Average	179	347
2	5460.00	64.37	74.00	-9.63	57.20	7.17	Peak	179	347
3	5470.00	67.85	68.20	-0.35	60.63	7.22	Peak	179	347
4 *	5530.00	98.66			91.23	7.43	Average	179	347
5 *	5530.00	112.09			104.66	7.43	Peak	179	347
6	11060.00	47.95	54.00	-6.05	31.12	16.83	Average	100	185
7	11060.00	59.37	74.00	-14.63	42.54	16.83	Peak	100	185
8	16590.00	61.71	68.20	-6.49	42.69	19.02	Peak	100	180

Note 1: Emission Level (dBuV/m) = SA Reading (dBuV/m) + Factor* (dB)

*Factor includes antenna factor , cable loss and amplifier gain

Note 2: Margin (dB) = Emission level (dBuV/m) – Limit (dBuV/m).

Note 3: "*" is Peak / Average value of fundamental frequency

Modulation	ax (HE80)	Test Freq. (MHz)	5530
Polarization	Vertical	Test Configuration	1

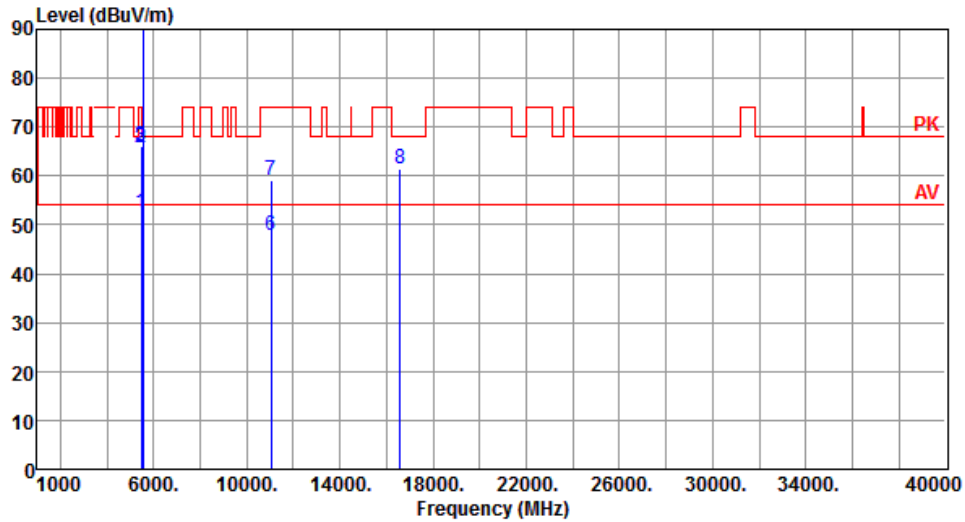

	Freq. MHz	Emission level dBUV/m	Limit dBUV/m	Margin dB	SA reading dBUV	Factor dB	Remark	ANT High cm	Turn Table deg
1	5460.00	52.49	54.00	-1.51	45.32	7.17	Average	256	321
2	5460.00	65.87	74.00	-8.13	58.70	7.17	Peak	256	321
3	5470.00	66.21	68.20	-1.99	58.99	7.22	Peak	256	321
4 *	5530.00	97.82			90.39	7.43	Average	256	321
5 *	5530.00	109.52			102.09	7.43	Peak	256	321
6	11060.00	47.89	54.00	-6.11	31.06	16.83	Average	100	180
7	11060.00	59.28	74.00	-14.72	42.45	16.83	Peak	100	180
8	16590.00	61.58	68.20	-6.62	42.56	19.02	Peak	100	186

Note 1: Emission Level (dBUV/m) = SA Reading (dBUV/m) + Factor* (dB)

*Factor includes antenna factor, cable loss and amplifier gain

Note 2: Margin (dB) = Emission level (dBUV/m) – Limit (dBUV/m).

Note 3: "*" is Peak / Average value of fundamental frequency

Modulation	ax (HE80)	Test Freq. (MHz)	5610
Polarization	Horizontal	Test Configuration	1

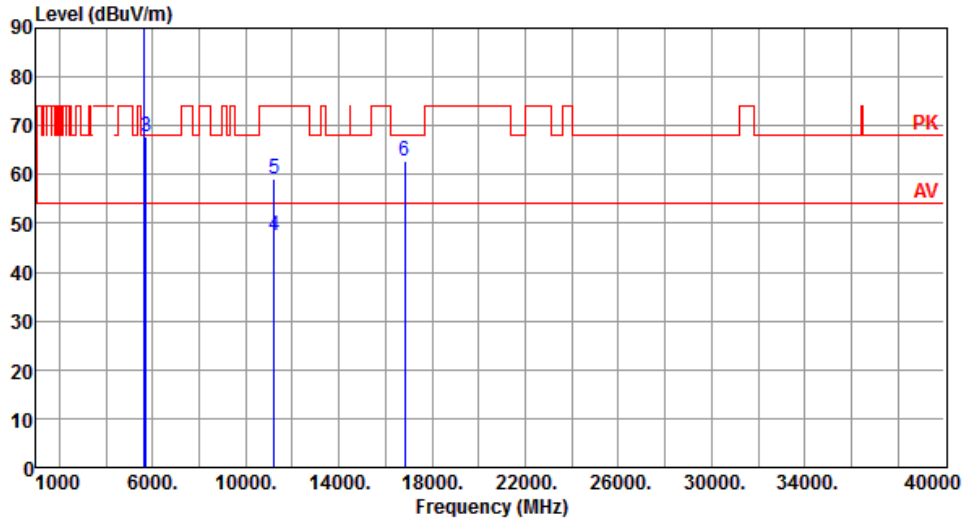

		Freq. MHz	Emission level dBuV/m	Limit dBuV/m	Margin dB	SA reading dBuV	Factor dB	Remark	ANT High cm	Turn Table deg
1	*	5610.00	102.35			94.88	7.47	Average	183	343
2	*	5610.00	113.62			106.15	7.47	Peak	183	343
3		5725.00	67.71	68.20	-0.49	60.15	7.56	Peak	183	16
4		11220.00	47.46	54.00	-6.54	31.02	16.44	Average	100	184
5		11220.00	58.95	74.00	-15.05	42.51	16.44	Peak	100	184
6		16830.00	62.73	68.20	-5.47	42.85	19.88	Peak	100	187

Note 1: Emission Level (dBuV/m) = SA Reading (dBuV/m) + Factor* (dB)

*Factor includes antenna factor, cable loss and amplifier gain

Note 2: Margin (dB) = Emission level (dBuV/m) – Limit (dBuV/m).

Note 3: "*" is Peak / Average value of fundamental frequency

Modulation	ax (HE80)	Test Freq. (MHz)	5610
Polarization	Vertical	Test Configuration	1

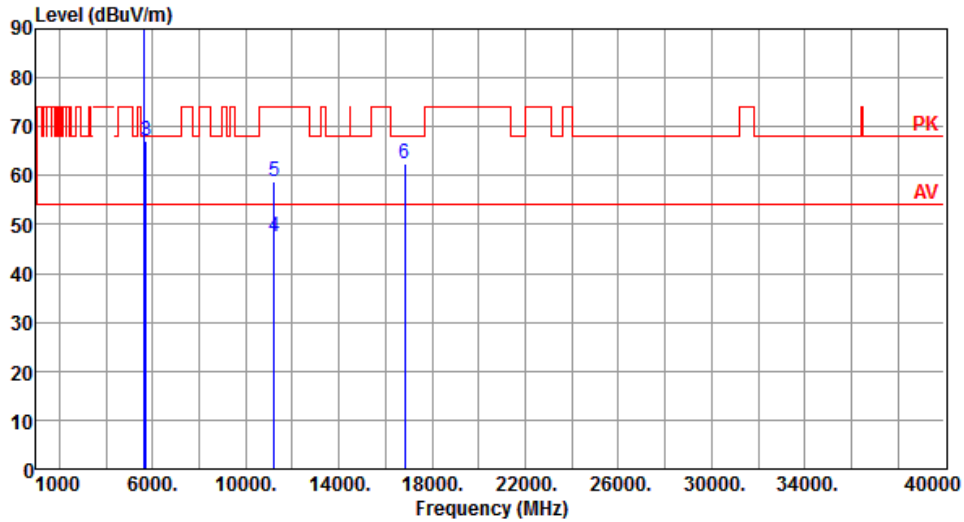

		Freq.	Emission	Limit	Margin	SA	Factor	Remark	ANT	Turn
		MHz	level	dBuV/m	dB	reading	dB		High	Table
			dBuV/m			dBuV			cm	deg
1	*	5610.00	101.86			94.39	7.47	Average	227	318
2	*	5610.00	113.34			105.87	7.47	Peak	227	318
3		5725.00	67.02	68.20	-1.18	59.46	7.56	Peak	227	318
4		11220.00	47.49	54.00	-6.51	31.05	16.44	Average	100	185
5		11220.00	58.90	74.00	-15.10	42.46	16.44	Peak	100	185
6		16830.00	62.56	68.20	-5.64	42.68	19.88	Peak	100	188

Note 1: Emission Level (dBuV/m) = SA Reading (dBuV/m) + Factor* (dB)

*Factor includes antenna factor, cable loss and amplifier gain

Note 2: Margin (dB) = Emission level (dBuV/m) – Limit (dBuV/m).

Note 3: "*" is Peak / Average value of fundamental frequency

Modulation	ax (HE80)	Test Freq. (MHz)	5690
Polarization	Horizontal	Test Configuration	1

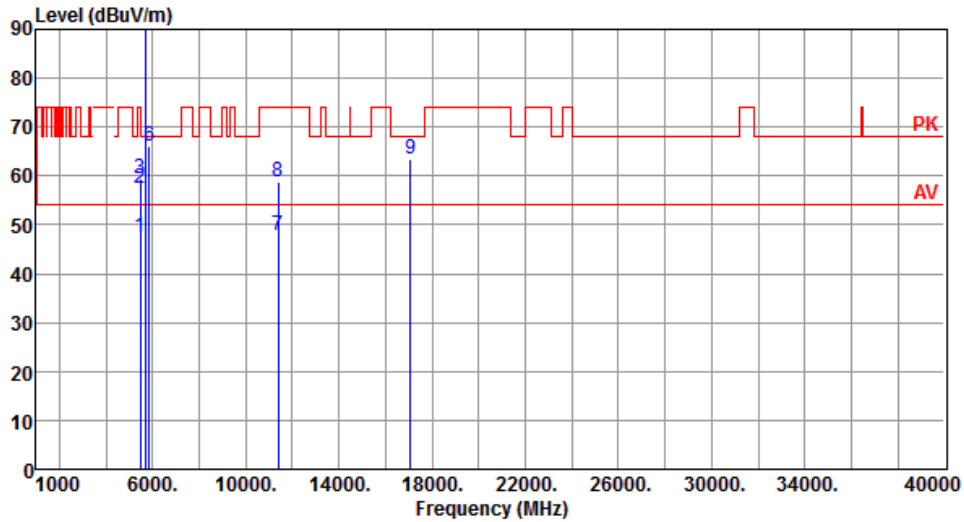

	Freq. MHz	Emission level dBUV/m	Limit dBUV/m	Margin dB	SA reading dBUV	Factor dB	Remark	ANT High cm	Turn Table deg
1	5460.00	47.34	54.00	-6.66	39.97	7.37	Average	148	13
2	5460.00	57.34	74.00	-16.66	49.97	7.37	Peak	148	13
3	5470.00	59.36	68.20	-8.84	51.94	7.42	Peak	148	13
4 *	5690.00	104.28			96.65	7.63	Average	148	13
5 *	5690.00	116.24			108.61	7.63	Peak	148	13
6	5850.00	65.96	68.20	-2.24	57.84	8.12	Peak	148	13
7	11380.00	47.86	54.00	-6.14	31.14	16.72	Average	100	182
8	11380.00	58.93	74.00	-15.07	42.21	16.72	Peak	100	182
9	17070.00	63.38	68.20	-4.82	44.76	18.62	Peak	100	185

Note 1: Emission Level (dBUV/m) = SA Reading (dBUV/m) + Factor* (dB)

*Factor includes antenna factor , cable loss and amplifier gain

Note 2: Margin (dB) = Emission level (dBUV/m) – Limit (dBUV/m).

Note 3: "*" is Peak / Average value of fundamental frequency

Modulation	ax (HE80)	Test Freq. (MHz)	5690
Polarization	Vertical	Test Configuration	1

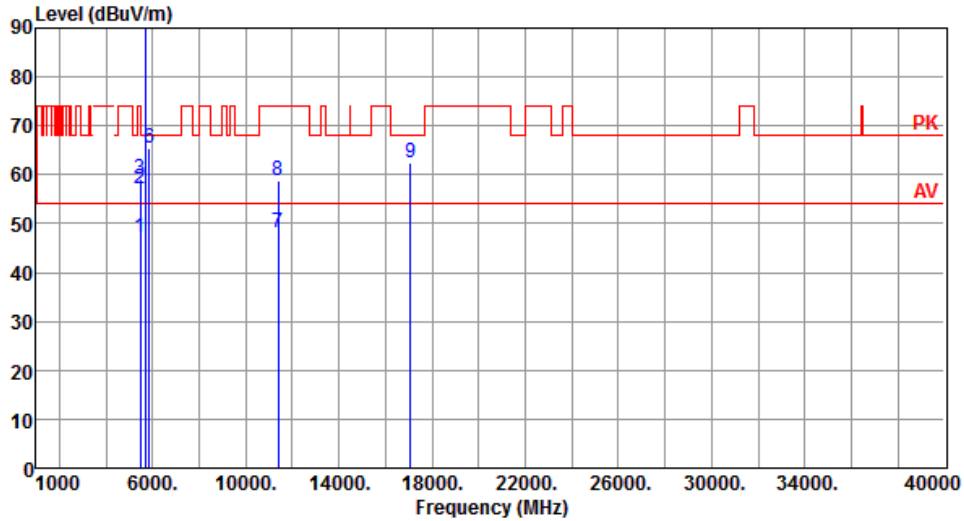

	Freq. MHz	Emission level dBuV/m	Limit dBuV/m	Margin dB	SA reading dBuV	Factor dB	Remark	ANT High cm	Turn Table deg
1	5460.00	47.10	54.00	-6.90	39.73	7.37	Average	225	323
2	5460.00	57.20	74.00	-16.80	49.83	7.37	Peak	225	323
3	5470.00	59.19	68.20	-9.01	51.77	7.42	Peak	225	323
4 *	5690.00	103.76			96.13	7.63	Average	225	323
5 *	5690.00	115.63			108.00	7.63	Peak	225	323
6	5850.00	65.39	68.20	-2.81	57.27	8.12	Peak	225	323
7	11380.00	48.13	54.00	-5.87	31.41	16.72	Average	100	184
8	11380.00	58.89	74.00	-15.11	42.17	16.72	Peak	100	184
9	17070.00	62.59	68.20	-5.61	43.97	18.62	Peak	100	182

Note 1: Emission Level (dBuV/m) = SA Reading (dBuV/m) + Factor* (dB)

*Factor includes antenna factor , cable loss and amplifier gain

Note 2: Margin (dB) = Emission level (dBuV/m) – Limit (dBuV/m).

Note 3: "*" is Peak / Average value of fundamental frequency

Modulation	ax (HE80)	Test Freq. (MHz)	5775
Polarization	Horizontal	Test Configuration	1

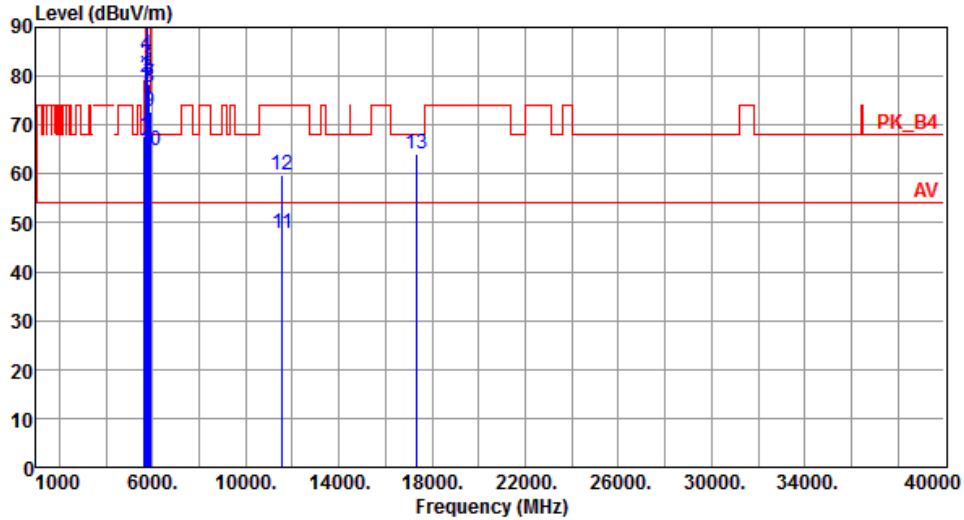

	Freq. MHz	Emission level dBuV/m	Limit dBuV/m	Margin dB	SA reading dBuV	Factor dB	Remark	ANT High cm	Turn Table deg
1	5650.00	67.79	68.20	-0.41	60.40	7.39	Peak	148	18
2	5700.00	79.65	105.20	-25.55	72.25	7.40	Peak	148	18
3	5720.00	82.34	110.80	-28.46	74.82	7.52	Peak	148	18
4	5725.00	84.44	122.20	-37.76	76.88	7.56	Peak	148	18
5 *	5775.00	103.03			95.27	7.76	Average	148	18
6 *	5775.00	115.36			107.60	7.76	Peak	148	18
7	5850.00	78.22	122.20	-43.98	70.20	8.02	Peak	148	18
8	5855.00	77.73	110.80	-33.07	69.70	8.03	Peak	148	18
9	5875.00	72.89	105.20	-32.31	64.81	8.08	Peak	148	18
10	5925.00	64.65	68.20	-3.55	56.48	8.17	Peak	148	18
11	11550.00	47.72	54.00	-6.28	30.96	16.76	Average	250	128
12	11550.00	59.93	74.00	-14.07	43.17	16.76	Peak	250	128
13	17325.00	64.00	68.20	-4.20	43.29	20.71	Peak	250	299

Note 1: Emission Level (dBuV/m) = SA Reading (dBuV/m) + Factor* (dB)

*Factor includes antenna factor , cable loss and amplifier gain

Note 2: Margin (dB) = Emission level (dBuV/m) – Limit (dBuV/m).

Note 3: "*" is Peak / Average value of fundamental frequency

Modulation	ax (HE80)	Test Freq. (MHz)	5775
Polarization	Vertical	Test Configuration	1

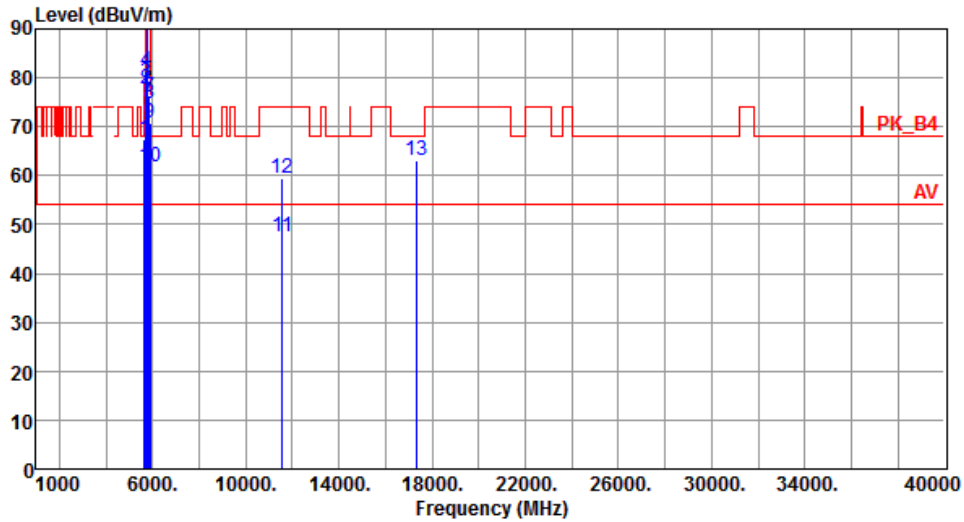

	Freq.	Emission	Limit	Margin	SA	Factor	Remark	ANT	Turn
	MHz	level	dBuV/m	dB	reading	dB		High	Table
		dBuV/m	dBuV/m	dB	dBuV	dB		cm	deg
1	5650.00	67.40	68.20	-0.80	60.01	7.39	Peak	186	320
2	5700.00	77.80	105.20	-27.40	70.40	7.40	Peak	186	320
3	5720.00	79.01	110.80	-31.79	71.49	7.52	Peak	186	320
4	5725.00	81.48	122.20	-40.72	73.92	7.56	Peak	186	320
5 *	5775.00	102.81			95.05	7.76	Average	186	320
6 *	5775.00	115.20			107.44	7.76	Peak	186	320
7	5850.00	75.92	122.20	-46.28	67.90	8.02	Peak	186	320
8	5855.00	74.64	110.80	-36.16	66.61	8.03	Peak	186	320
9	5875.00	70.61	105.20	-34.59	62.53	8.08	Peak	186	320
10	5925.00	61.71	68.20	-6.49	53.54	8.17	Peak	186	320
11	11550.00	47.58	54.00	-6.42	30.82	16.76	Average	100	127
12	11550.00	59.39	74.00	-14.61	42.63	16.76	Peak	100	127
13	17325.00	63.13	68.20	-5.07	42.42	20.71	Peak	100	240

Note 1: Emission Level (dBuV/m) = SA Reading (dBuV/m) + Factor* (dB)

*Factor includes antenna factor , cable loss and amplifier gain

Note 2: Margin (dB) = Emission level (dBuV/m) – Limit (dBuV/m).

Note 3: "*" is Peak / Average value of fundamental frequency

3.6 Frequency Stability

3.6.1 Limit of Frequency Stability

Manufacturers of U-NII devices are responsible for ensuring frequency stability such that an emission is maintained within the band of operation under all conditions of normal operation as specified in the user's manual.

3.6.2 Test Procedures

1. The EUT is installed in an environment test chamber with external power source.
2. Set the chamber to operate at 20 centigrade and external power source to output at nominal voltage of EUT.
3. A sufficient stabilization period at each temperature is used prior to each frequency measurement.
4. When temperature is stabled, measure the frequency stability.
5. The test shall be performed under normal and extreme condition for temperature and voltage.

3.6.3 Test Setup

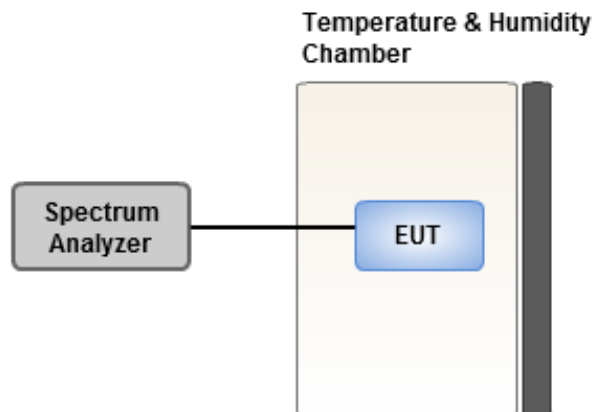

3.6.4 Test Result of Frequency Stability

Frequency: 5320 MHz	Frequency Drift (ppm)			
Temperature (°C)	0 minute	2 minutes	5 minutes	10 minutes
T20°C _{Vmax}	0.58	0.08	0.68	0.30
T20°C _{Vmin}	-0.42	-1.14	-1.41	-0.52
T50°C _{Vnom}	-1.60	-1.40	-0.65	-1.13
T40°C _{Vnom}	1.38	0.95	1.01	0.52
T30°C _{Vnom}	-0.05	0.21	-0.13	0.73
T20°C _{Vnom}	0.56	-0.18	0.68	0.20
T10°C _{Vnom}	-3.12	-3.68	-3.86	-3.66
T0°C _{Vnom}	-4.44	-4.43	-3.76	-3.95
T-10°C _{Vnom}	-2.05	-1.98	-2.38	-1.49
T-20°C _{Vnom}	-6.31	-6.79	-6.58	-6.44
T-30°C _{Vnom}	-8.51	-8.74	-8.68	-8.51
V _{nom} [Vac]: 120		V _{max} [Vac]: 138		V _{min} [Vac]: 102
T _{nom} [°C]: 20		T _{max} [°C]: 50		T _{min} [°C]: -30

Frequency: 5785 MHz	Frequency Drift (ppm)			
Temperature (°C)	0 minute	2 minutes	5 minutes	10 minutes
T20°C _{Vmax}	0.38	0.70	0.86	0.35
T20°C _{Vmin}	0.21	0.82	0.18	-0.12
T50°C _{Vnom}	1.08	0.92	1.51	0.97
T40°C _{Vnom}	0.18	0.41	0.10	0.28
T30°C _{Vnom}	-0.24	-0.71	0.55	0.34
T20°C _{Vnom}	0.32	0.37	0.63	0.40
T10°C _{Vnom}	-3.38	-2.92	-3.45	-3.09
T0°C _{Vnom}	-3.88	-4.03	-4.17	-3.91
T-10°C _{Vnom}	-2.25	-2.31	-1.85	-1.80
T-20°C _{Vnom}	-6.01	-5.99	-5.83	-6.35
T-30°C _{Vnom}	-7.67	-7.04	-7.68	-7.63
V _{nom} [Vac]: 120		V _{max} [Vac]: 138		V _{min} [Vac]: 102
T _{nom} [°C]: 20		T _{max} [°C]: 50		T _{min} [°C]: -30

4 Test laboratory information

Established in 2012, ICC provides foremost EMC & RF Testing and advisory consultation services by our skilled engineers and technicians. Our services employ a wide variety of advanced edge test equipment and one of the widest certification extents in the business.

International Certification Corp (EMC and Wireless Communication Laboratory), it is our definitive objective is to institute long term, trust-based associations with our clients. The expectation we set up with our clients is based on outstanding service, practical expertise and devotion to a certified value structure. Our passion is to grant our clients with best EMC / RF services by oriented knowledgeable and accommodating staff.

Our Test sites are located at Linkou District and Kwei Shan District. Location map can be found on our website <http://www.icertifi.com.tw>.

Linkou

Tel: 886-2-2601-1640

No. 30-2, Ding Fwu Tsuen, Lin
Kou District, New Taipei City,
Taiwan, R.O.C.

Kwei Shan

Tel: 886-3-271-8666

No. 3-1, Lane 6, Wen San 3rd St.,
Kwei Shan District, Tao Yuan City
333, Taiwan, R.O.C.

Kwei Shan Site II

Tel: 886-3-271-8640

No. 14-1, Lane 19, Wen San 3rd
St., Kwei Shan District, Tao Yuan
City 333, Taiwan, R.O.C.

If you have any suggestion, please feel free to contact us as below information.

Tel: 886-3-271-8666

Fax: 886-3-318-0155

Email: ICC_Service@icertifi.com.tw

==END==