



www.nemko.com

Report Reference ID	169122-2TRFWL
---------------------	---------------

Test specification	<p>Title 47 - Telecommunication Chapter I - Federal Communications Commission Subchapter A - General Part 15 - Radio Frequency Devices Subpart C - Intentional Radiators</p> <p>§15.245 - Operation within the bands 902–928 MHz, 2435–2465 MHz, 5785–5815 MHz, 10500–10550 MHz and 24075–24175 MHz</p>
--------------------	---

Applicant	<p>Senstar Corporation 119 John Cavanaugh Dr. Carp, ON K0A 1L0 Canada</p>
-----------	--

Apparatus	Ultrawave Bi-Static Microwave Receiver (K-Band)
-----------	---

Product category	Intrusion Detection System
------------------	----------------------------

Model	E4EM0201-001
-------	--------------

FCC ID	I5T-E4EM0201
--------	--------------

Testing laboratory	<p>Nemko Canada Inc. 303 River Road Ottawa, ON, Canada K1V 1H2</p> <p>Telephone: (613) 737-9680 Facsimile: (613) 737-9691</p>
--------------------	---

	Name and title	Date
Tested by	David Duchesne, Wireless/EMC Specialist	April 1, 2011
Reviewed by	 Andrey Adelberg, Senior Wireless/EMC Specialist	April 1, 2011



Nemko Canada Inc., a testing laboratory, is accredited by the Standards Council of Canada.
 The tests included in this report are within the scope of this accreditation.



Nemko Canada Inc.
303 River Rd, Ottawa, ON, Canada, K1V 1H2

Product: Ultrawave Bi-Static Microwave Receiver (K-Band)

Table of contents

Section 1: Report summary	3
1.1 Test specification	3
1.2 Statement of compliance	3
1.3 Exclusions.....	3
1.4 Registration number	3
1.5 Test report revision history.....	3
1.6 Limits of responsibility.....	3
Section 2: Summary of test results	4
2.1 FCC Part 15 Subpart C – Intentional Radiators, test results.....	4
Section 3: Equipment under test (EUT) and application details.....	5
3.1 Product details	5
3.2 Sample information	5
3.3 EUT technical specifications	5
3.4 EUT description	5
3.5 Operation of the EUT during testing	5
3.6 EUT setup diagram.....	6
Section 4: Engineering considerations.....	7
4.1 Modifications incorporated in the EUT	7
4.2 Technical judgment.....	7
4.3 Deviations from laboratory tests procedures.....	7
Section 5: Test conditions	8
5.1 Power source and ambient temperatures	8
Section 6: Measurement uncertainty	9
Section 7: Test equipment	10
7.1 Test equipment list.....	10
Section 8: Testing data.....	11
8.1 Clause 15.207(a) Conducted limits	11
8.2 Clause 15.245.....	15
8.3 Clause 15.215 (c) 20 dB bandwidth	22
Section 8: Block diagrams of test set-ups.....	23

Section 1: Report summary

1.1 Test specification

FCC Part 15 Subpart C, §15.245

Operation within the bands 902–928 MHz, 2435–2465 MHz, 5785–5815 MHz, 10500–10550 MHz and 24075–24175 MHz

1.2 Statement of compliance

In the configuration tested the EUT was found compliant

This report contains an assessment of apparatus against specifications based upon tests carried out on samples submitted at Nemko Canada Inc. These tests were conducted on a sample of the equipment for the purpose of demonstrating compliance with Part 15; Subpart C. Radiated tests were conducted in accordance with ANSI C63.4-2003.

See “*Summary of test results*” for full details.

1.3 Exclusions

None

1.4 Registration number

Test site FCC ID number: 176392 (3 m Semi anechoic chamber)

1.5 Test report revision history

Revision #	Details of changes made to test report
TRF	Original report issued

1.6 Limits of responsibility

Note that the results contained in this report relate only to the items tested and were obtained in the period between the date of initial receipt of samples and the date of issue of the report.

This test report has been completed in accordance with the requirements of ISO/IEC 17025. All results contained in this report are within Nemko Canada's ISO/IEC 17025 accreditation.

Nemko Canada Inc. authorizes the applicant to reproduce this report provided it is reproduced in its entirety and for use by the company's employees only.

Any use which a third party makes of this report, or any reliance on or decisions to be made based on it, are the responsibility of such third parties.

Nemko Canada Inc. accepts no responsibility for damages, if any, suffered by any third party as a result of decisions made or actions based on this report.

Section 2: Summary of test results

2.1 FCC Part 15 Subpart C – Intentional Radiators, test results

General requirements for FCC Part 15

Part	Test description	Verdict
§15.31(e)	Variation of power source	See Notes 1
§15.31(m)	Number of operating frequencies	See Notes 2
§15.203	Antenna requirement	See Notes 3
§15.207(a)	Conducted limits	Pass (See Notes 4)
§15.215(c)	20 dB bandwidth	Pass

Specific requirements for FCC Part 15 Subpart C, 15.245

Part	Test description	Verdict
§15.245(b)	Operation within the bands 902–928 MHz, 2435–2465 MHz, 5785–5815 MHz, 10500–10550 MHz, and 24075–24175 MHz	Pass

Notes:

1. Transmit output power was measured while supply voltage was varied from 10.2 to 54 V_{DC} (85 to 112.5 % of the nominal rated supply voltage). No change in transmit output power was observed.
2. The frequency range over which the device operates is greater than 10 MHz. Tests were performed on three operating channels (low, mid and high)
3. Antenna is an integral.
4. EUT is DC powered. Client does not provide an AC-DC adapter with EUT. Tested the sample with a representative source to demonstrate compliance.

Section 3: Equipment under test (EUT) and application details

3.1 Product details

Product name	Ultrawave Bi-Static Microwave Receiver (K-Band)
Model	E4EM0201-001
Serial number	E021048002

3.2 Sample information

Receipt date	December 8, 2010
Nemko sample ID number	Item # 1

3.3 EUT technical specifications

Operating band	24.075–24.175 GHz
Operating frequency	24.0775–24.1725 GHz
Modulation type	ASK
Number of channels	10
Channel spacing	5 MHz (odd channel numbers) and 15 MHz (even channel numbers)
Occupied bandwidth	439.1 kHz (20 dB bandwidth)
Antenna data	Integral patch antenna, 3 dBi
Power source	12 to 48 V _{DC} , 3 W (max)

3.4 EUT description

Bi-Static microwave link consisting of a radio transmitter and a radio receiver. The system senses and analyzes disturbances caused by an intruder crossing. Typical link distance of 10–200 m over uniform, flat terrain.

TX unit generates a 24 GHz CW signal with modulated ASK bursts at 1 s intervals consisting of 140 bits @ 19.2 kbps, and transmits via an integrated patch antenna.

Rx unit receives transmitted signal and measures the amplitude of the recovered signal. The signature of this amplitude is analyzed. If detection criteria are met, alarm is generated. Additionally the RX unit transmit constantly a test (maintenance) CW signal with modulated ASK bursts at 1 s intervals consisting of 140 bits @ 19.2 kbps for service.

3.5 Operation of the EUT during testing

EUT was set for continuous transmission.

3.6 EUT setup diagram

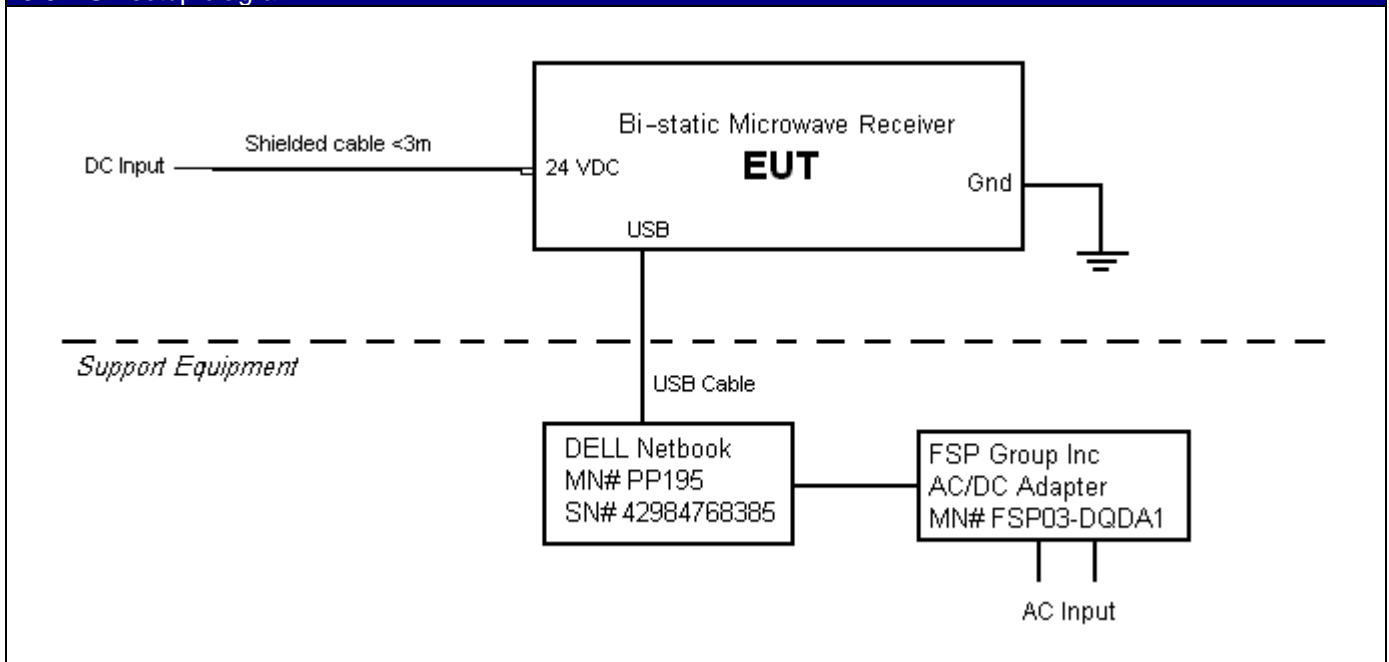

Section 4: Engineering considerations

4.1 Modifications incorporated in the EUT

The following modifications were performed by client for compliance with spurious emissions (Emissions radiated outside of the specified frequency bands, except for harmonics):

New PCB board will be revision 3. C111 (100p)

4.2 Technical judgment

None

4.3 Deviations from laboratory tests procedures

No deviations were made from laboratory test procedures.

Section 5: Test conditions

5.1 Power source and ambient temperatures

Normal temperature, humidity and air pressure test conditions

Temperature: 15–30 °C
Relative humidity: 20–75 %
Air pressure: 86–106 kPa

When it is impracticable to carry out tests under these conditions, a note to this effect stating the ambient temperature and relative humidity during the tests shall be recorded and stated.

Power supply range

The normal test voltage for equipment to be connected to the mains shall be the nominal mains voltage. For the purpose of the present document, the nominal voltage shall be the declared voltage, or any of the declared voltages $\pm 5\%$, for which the equipment was designed.

Section 6: Measurement uncertainty

Nemko Canada measurement uncertainty has been calculated using guidance of UKAS LAB 34:2003 and TIA-603-B Nov 7, 2002. All calculations have been performed to provide a confidence level of 95 % and can be found in Nemko Canada document MU-003.

Section 7: Test equipment

7.1 Test equipment list

Equipment	Manufacturer	Model no.	Asset no.	Cal cycle	Next cal.
3 m EMI test chamber	TDK	SAC-3	FA002047	1 year	Mar. 09/11
Receiver/spectrum analyzer	Rohde & Schwarz	ESU 26	FA002043	1 year	April 14/11
Spectrum analyzer	Rohde & Schwarz	FSU	FA001877	1 year	Dec.06/11
1–18 GHz amplifier	JCA	JCA118-503	FA002091	1 year	Sept. 23/11
18–26 GHz amplifier	Narda	BBS-1826N612	FA001550	—	COU
26–40 GHz amplifier	Narda	DBL-2640N610	FA001556	—	COU
Horn antenna #2	Emco	3115	FA000825	1 year	Feb. 04/12
Horn 18–26.5 GHz	Electro-metrics	SH-50/60-1	FA000479	—	COU
Horn 26.5–40 GHz	Electro-metrics	SH-50/60-2	FA000485	—	COU
Bilog antenna	Sunol	JB3	FA002108	1 year	Jan. 31/12
18–40 GHz horn antenna	EMCO	3116	FA001847	1 year	May 13/11
Horn 40-60 GHz	MILLITECH	SGH-19	FA001523	—	VOU
Horn 60-90 GHz	MILLITECH	SGH-12	FA001524	—	VOU
Horn 90-140 GHz	MILLITECH	SGH-08	FA001525	—	VOU
Mixer 40-60 GHz	OML	WR19	FA001523	—	VOU
Mixer 60-90 GHz	OML	WR12	FA001524	—	VOU
Mixer 90-140 GHz	OML	WR08	FA001525	—	VOU
International power supply	California Inst.	30011	FA001021	1 year	Jan. 26/12
LISN	Rohde & Schwarz	ENV216	FA002023	1 year	Nov. 09/11

Note: NCR = No cal required, COU = Cal on use, VOU = Verified on Use

Section 8: Testing data

8.1 Clause 15.207(a) Conducted limits

§ 15.207 Conducted limits.

(a) Except as shown in paragraphs (b) and (c) of this section, for an intentional radiator that is designed to be connected to the public utility (AC) power line, the radio frequency voltage that is conducted back onto the AC power line on any frequency or frequencies, within the band 150 kHz to 30 MHz, shall not exceed the limits in the following table, as measured using a 50 μ H/50 ohms line impedance stabilization network (LISN). Compliance with the provisions of this paragraph shall be based on the measurement of the radio frequency voltage between each power line and ground at the power terminal. The lower limit applies at the boundary between the frequency ranges.

Frequency of emission (MHz)	Conducted limit (dB μ V)	
	Quasi-peak	Average
0.15–0.5	66 to 56*	56 to 46*
0.5–5	56	46
5–30	60	50

*-Decreases with the logarithm of the frequency.

Special notes

Tested AC input of support DC power supply.



Nemko Canada Inc.,
303 River Rd, Ottawa, ON, Canada, K1V 1H2

Section 8: Testing data	Product: Ultrawave Bi-Static Microwave Receiver (K-Band)	
Test name: Clause 15.207 (a)		
Test date: March 31, 2011	Test engineer: David Duchesne	Verdict: Pass
Specification: FCC Part 15 Subpart C		

Test data

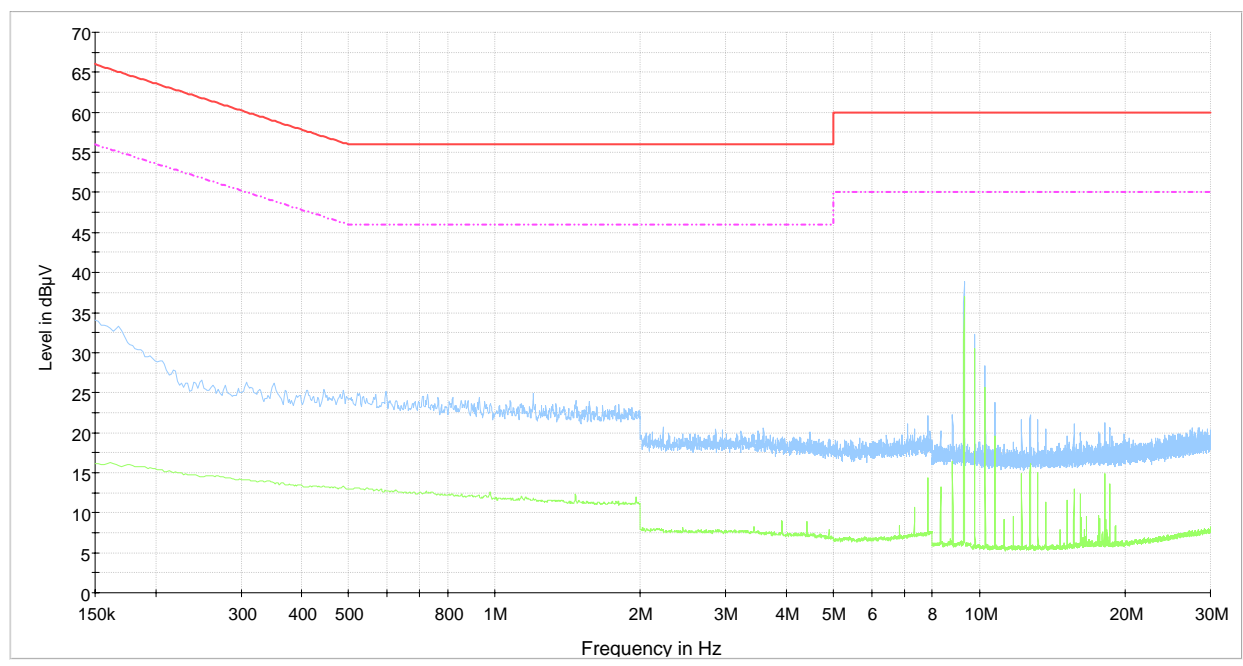

120VAC/60Hz, Phase (AC input of PS280 DC power supply)
 — CISPR Mains QP Class B Limit
 - - - CISPR Mains AV Class B Limit
 — Preview Peak Detector
 — Preview Average Detector

The spectral scan has been corrected with transducer factors (i.e. cable loss, LISN factors, and attenuators) for determination of compliance.

A preview measurement was generated with the receiver in continuous scan mode. Emissions detected within 6 dB or above limit were re-measured with the appropriate detector against the correlating limit and recorded as the final measurement.

Receiver/Spectrum analyzer settings:	
Preview measurements	Final measurement
Receiver: 9 kHz RBW, Peak and Average detector, max hold	Receiver: 9 kHz RBW, Quasi-peak and Average detector
Measurement time 100 ms	



Nemko Canada Inc.,
303 River Rd, Ottawa, ON, Canada, K1V 1H2

Section 8: Testing data	Product: Ultrawave Bi-Static Microwave Receiver (K-Band)	
Test name: Clause 15.207 (a)		
Test date: March 31, 2011	Test engineer: David Duchesne	Verdict: Pass
Specification: FCC Part 15 Subpart C		

Test data, continued

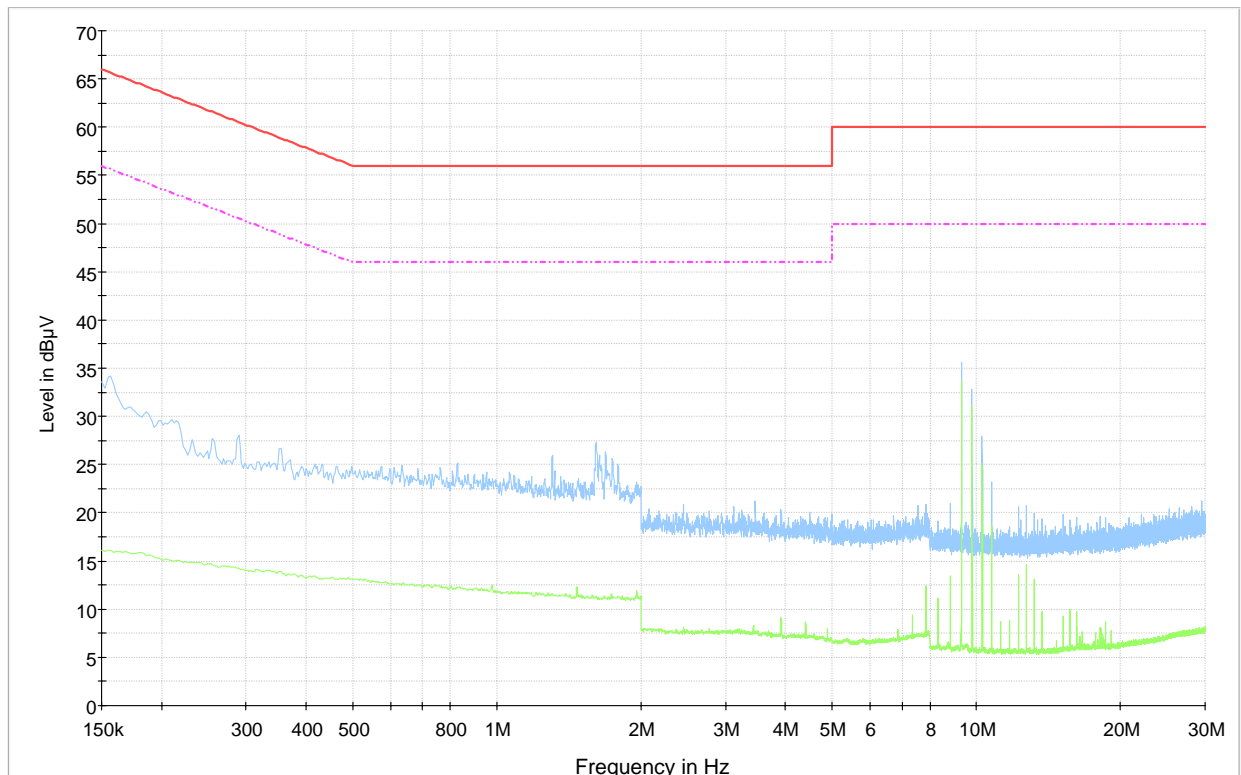

120VAC/60Hz, Neutral (AC input of PS230 DC power supply)

- CISPR Mains QP Class B Limit
- - - CISPR Mains AV Class B Limit
- Preview Peak Detector
- Preview Average Detector

The spectral scan has been corrected with transducer factors (i.e. cable loss, LISN factors, and attenuators) for determination of compliance.

A preview measurement was generated with the receiver in continuous scan mode. Emissions detected within 6 dB or above limit were re-measured with the appropriate detector against the correlating limit and recorded as the final measurement.

Receiver/Spectrum analyzer settings:

Preview measurements	Final measurement
Receiver: 9 kHz RBW, Peak and Average detector, max hold	Receiver: 9 kHz RBW, Quasi-peak and Average detector
Measurement time 100 ms	



Nemko Canada Inc.,
303 River Rd, Ottawa, ON, Canada, K1V 1H2

Section 8: Testing data	Product: Ultrawave Bi-Static Microwave Receiver (K-Band)	
Test name: Clause 15.207 (a)		
Test date: March 31, 2011	Test engineer: David Duchesne	Verdict: Pass
Specification: FCC Part 15 Subpart C		

Setup photo

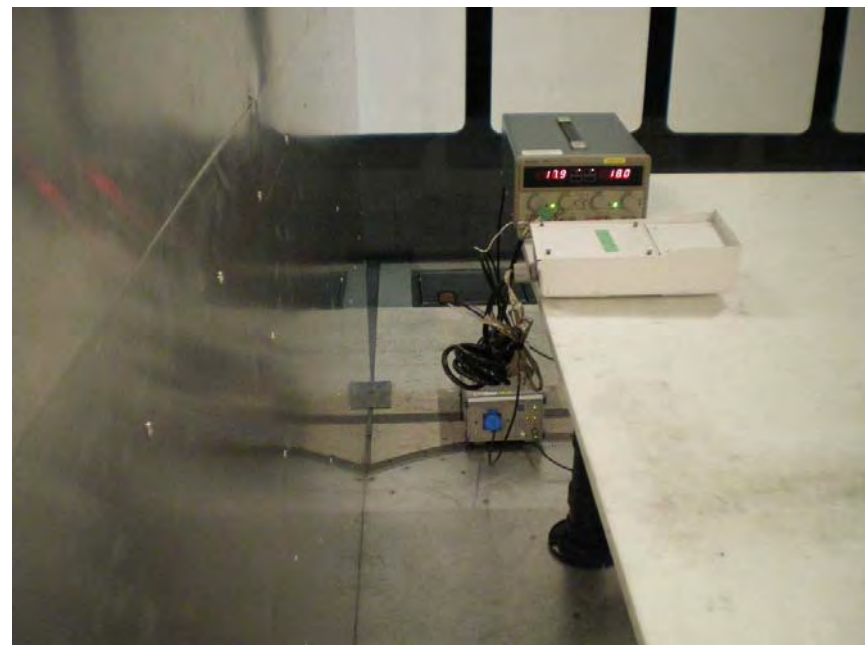

8.2 Clause 15.245

§ 15.245 Operation within the bands 902–928 MHz, 2435–2465 MHz, 5785–5815 MHz, 10500–10550 MHz, and 24075–24175 MHz.

- (a) Operation under the provisions of this section is limited to intentional radiators used as field disturbance sensors, excluding perimeter protection systems.
- (b) The field strength of emissions from intentional radiators operated within these frequency bands shall comply with the following:

Fundamental frequency (MHz)	Field strength of fundamental		Field strength of harmonics	
	(millivolts/meter)	dB μ V/m	(millivolts/meter)	dB μ V/m
902 - 928	500	113.979	1.6	64.08
2435 - 2465	500	113.979	1.6	64.08
5785 - 5815	500	113.979	1.6	64.08
10500 - 10550	2500	127.950	25.0	87.96
24075 - 24175	2500	127.950	25.0	87.96

(1) Regardless of the limits shown in the above table, harmonic emissions in the restricted bands below 17.7 GHz, as specified in §15.205, shall not exceed the field strength limits shown in §15.209. Harmonic emissions in the restricted bands at and above 17.7 GHz shall not exceed the following field strength limits:

- (i) For the second and third harmonics of field disturbance sensors operating in the 24075–24175 MHz band and for other field disturbance sensors designed for use only within a building or to open building doors, 25.0 mV/m.
 - (ii) For all other field disturbance sensors, 7.5 mV/m.
 - (iii) Field disturbance sensors designed to be used in motor vehicles or aircraft must include features to prevent continuous operation unless their emissions in the restricted bands, other than the second and third harmonics from devices operating in the 24075–24175 MHz band, fully comply with the limits given in §15.209. Continuous operation of field disturbance sensors designed to be used in farm equipment, vehicles such as fork lifts that are intended primarily for use indoors or for very specialized operations, or railroad locomotives, railroad cars and other equipment which travels on fixed tracks is permitted. A field disturbance sensor will be considered not to be operating in a continuous mode if its operation is limited to specific activities of limited duration (e.g., putting a vehicle into reverse gear, activating a turn signal, etc.).
- (2) Field strength limits are specified at a distance of 3 meters.
- (3) Emissions radiated outside of the specified frequency bands, except for harmonics, shall be attenuated by at least 50 dB below the level of the fundamental or to the general radiated emission limits in §15.209, whichever is the lesser attenuation.
- (4) The emission limits shown above are based on measurement instrumentation employing an average detector. The provisions in §15.35 for limiting peak emissions apply.



Nemko Canada Inc.,
303 River Rd, Ottawa, ON, Canada, K1V 1H2

Section 8: Testing data	Product: Ultrawave Bi-Static Microwave Receiver (K-Band)	
Test name: Clause 15.245		
Test date: March 1, 2011	Test engineer: David Duchesne	Verdict: Pass
Specification: FCC Part 15 Subpart C		

Special notes

§15.209 Radiated emission limits; general requirements.

Frequency (MHz)	Field strength		Measurement distance (m)
	($\mu\text{V}/\text{m}$)	($\text{dB}\mu\text{V}/\text{m}$)	
0.009–0.490	2400/F	67.6–20log(F)	300
0.490–1.705	24000/F	87.6–20log(F)	30
1.705–30.0	30	29.5	30
30–88	100	40.0	3
88–216	150	43.5	3
216–960	200	46.0	3
above 960	500	54.0	3

Notes:

- F = fundamental frequency in kHz
- In the emission table above, the tighter limit applies at the band edges.

§15.205 Restricted bands of operation.

MHz	MHz	MHz	GHz
0.090–0.110	16.42–16.423	399.9–410	4.5–5.15
0.495–0.505	16.69475–16.69525	608–614	5.35–5.46
2.1735–2.1905	16.80425–16.80475	960–1240	7.25–7.75
4.125–4.128	25.5–25.67	1300–1427	8.025–8.5
4.17725–4.17775	37.5–38.25	1435–1626.5	9.0–9.2
4.20725–4.20775	73–74.6	1645.5–1646.5	9.3–9.5
6.215–6.218	74.8–75.2	1660–1710	10.6–12.7
6.26775–6.26825	108–121.94	1718.8–1722.2	13.25–13.4
6.31175–6.31225	123–138	2200–2300	14.47–14.5
8.291–8.294	149.9–150.05	2310–2390	15.35–16.2
8.362–8.366	156.52475–156.52525	2483.5–2500	17.7–21.4
8.37625–8.38675	156.7–156.9	2690–2900	22.01–23.12
8.41425–8.41475	162.0125–167.17	3260–3267	23.6–24.0
12.29–12.293	167.72–173.2	3332–3339	31.2–31.8
12.51975–12.52025	240–285	3345.8–3358	36.43–36.5
12.57675–12.57725	322–335.4	3600–4400	Above 38.6
13.36–13.41			



Nemko Canada Inc.,
303 River Rd, Ottawa, ON, Canada, K1V 1H2

Section 8: Testing data	Product: Ultrawave Bi-Static Microwave Receiver (K-Band)	
Test name: Clause 15.245		
Test date: March 1, 2011	Test engineer: David Duchesne	Verdict: Pass
Specification: FCC Part 15 Subpart C		

Test data

§ 15.35 Measurement detector functions and bandwidths.

(c) Unless otherwise specified, e.g. §15.255(b), when the radiated emission limits are expressed in terms of the average value of the emission, and pulsed operation is employed, the measurement field strength shall be determined by averaging over one complete pulse train, including blanking intervals, as long as the pulse train does not exceed 0.1 seconds. As an alternative (provided the transmitter operates for longer than 0.1 seconds) or in cases where the pulse train exceeds 0.1 seconds, the measured field strength shall be determined from the average absolute voltage during a 0.1 second interval during which the field strength is at its maximum value. The exact method of calculating the average field strength shall be submitted with any application for certification or shall be retained in the measurement data file for equipment subject to notification or verification.

- The transmit signal CW was modulated with ASK at 1 s intervals consisting of 140 bits @ 19.2kbps.
- The transmitter was continuously enabled during 0.1 seconds interval. The Duty cycle / average factor was calculated as detailed below.

Duty cycle/average factor calculations:

$$Duty\ cycle / average\ factor = 20 \times \log_{10} \left(\frac{T_{x_{100ms}}}{100ms} \right)$$

$$Duty\ cycle / average\ factor = 20 \times \log_{10} \left(\frac{100ms}{100ms} \right)$$

$$Duty\ cycle / average\ factor = 0\ (dB)$$



Nemko Canada Inc.,
303 River Rd, Ottawa, ON, Canada, K1V 1H2

Section 8: Testing data		Product: Ultrawave Bi-Static Microwave Receiver (K-Band)	
Test name: Clause 15.245			
Test date: March 1, 2011		Test engineer: David Duchesne	Verdict: Pass
Specification: FCC Part 15 Subpart C			

Test data, continued

Field strength of fundamental

Freq. (GHz)	Ant. Pol.	Peak field strength (dB μ V/m)	Peak field strength limit (dB μ V/m)	Peak margin (dB)	Duty cycle corr. (dB)	Avg. field strength (dB μ V/m)	Avg. field strength limit (dB μ V/m)	Avg. margin (dB)
24.0775	V	85.19	147.95	62.76	0	85.19	127.95	42.77
	H	70.23	147.95	77.72	0	70.23	127.95	57.72
24.1325	V	84.23	147.95	63.72	0	84.23	127.95	43.72
	H	65.9	147.95	82.05	0	65.9	127.95	62.05
24.1725	V	86.7	147.95	61.25	0	86.7	127.95	41.25
	H	69.8	147.95	78.15	0	69.8	127.95	58.15

- Test distance = 3 m
- Field strength measurement has been corrected with transducer factors (i.e. antenna factor, and cable loss)
- The limit on peak radio frequency emissions is 20 dB above the maximum permitted average emission limit applicable to the equipment under test with pulsed (digital) operation. This peak limit applies to the total peak emission level radiated by the device.
- Average field strength (dB μ V/m) = Peak field strength (dB μ V/m) - dB (Duty cycle correction factor)
- All test were performed with transmitter set to maximum power.
- Spectrum analyzer settings:
 - Peak detector RBW = 1 MHz, VBW = 3 MHz
 - Average detector RBW = 1 MHz, VBW = 10 Hz
 - Measurement time 100 ms

Sample calculation:
 Correction factor (dB) = antenna factor ACF (dB) + cable loss (dB) - amplifier gain (dB)
 Field strength (dB μ V/m) = XX dB μ V (reading from receiver/spectrum analyzer) + XX dB (Correction factor)

Example:
 86.7 dB μ V/m = 91.1 dB μ V (receiver reading) + 45.2 dB (antenna factor ACF) + 5.1 dB (cable loss) - 54.7 dB (Amplifier gain)

Field strength of harmonics

No emissions detected within 10 dB of limit.

- Transmitter was verified at low mid and high channel. (CH1, CH6, and CH10).
- Test distance = 1 m (limit was extrapolated)
- The limit on peak radio frequency emissions is 20 dB above the maximum permitted average emission limit applicable to the equipment under test with pulsed (digital) operation. This peak limit applies to the total peak emission level radiated by the device.
- Average field strength (dB μ V/m) = Peak field strength (dB μ V/m) - dB (Duty cycle correction factor)
- All test were performed with transmitter set to maximum power.
- Spectrum analyzer settings:
 - Peak detector RBW = 1 MHz, VBW = 3 MHz
 - Average detector RBW = 1 MHz, VBW = 10 Hz
 - Measurement time 100 ms



Nemko Canada Inc.,
303 River Rd, Ottawa, ON, Canada, K1V 1H2

Section 8: Testing data		Product: Ultrawave Bi-Static Microwave Receiver (K-Band)	
Test name: Clause 15.245			
Test date: March 1, 2011		Test engineer: David Duchesne	Verdict: Pass
Specification: FCC Part 15 Subpart C			

Test data, continued

Spurious emissions (Emissions radiated outside of the specified frequency bands, except for harmonics)

30 to 1000 MHz

Frequency (MHz)	Antenna Pol.	Peak field strength (dB μ V/m)	Q-peak field strength Limit (dB μ V/m)	Margin (dB)
276.51	V	32.16	46.00	13.84
313.37	V	29.33	46.00	16.67

- Transmitter was verified at low mid and high channel. (CH1, CH6, and CH10). Only the worst-case test results have been provided.
- Field strength measurement has been corrected with transducer factors (i.e. antenna factor, cable loss, amplifier, and attenuators)
- Test distance = 3 m
- All test were performed with transmitter set to maximum power.
- Peak detector with appropriate RBW was used to determine compliance against limit.
- Receiver settings:
 - Peak detector RBW = 120 MHz, VBW = 300 kHz
 - Measurement time 100 ms

Sample calculation:
 Correction factor (dB) = antenna factor ACF (dB) + cable loss (dB)
 Field strength (dB μ V/m) = XX dB μ V (reading from receiver/spectrum analyzer) + XX dB (Correction factor)

Example:
 32.16 dB μ V/m = 18.76 dB μ V (receiver reading) + 12.3 dB (antenna factor ACF) + 1.1 dB (cable loss)

1 to 18 GHz

Freq. (MHz)	Antenna Pol.	Peak field strength (dB μ V/m)	Peak field strength limit (dB μ V/m)	Peak Margin (dB)	Average field strength (dB μ V/m)	Average field strength limit (dB μ V/m)	Average Margin (dB)
1508.4	H	49.6	74.0	24.4	47.4	54	6.6
2441.2	H	47.6	74.0	26.4	45.2	54	8.8
4525.2	V	52.1	74.0	21.9	46.0	54	8.0

- Transmitter was verified at low mid and high channel. (CH1, CH6, and CH10). Only the worst-case test results have been provided.
- Field strength measurement has been corrected with transducer factors (i.e. antenna factor, cable loss, amplifier, and attenuators)
- Test distance = 3 m
- The limit on peak radio frequency emissions is 20 dB above the maximum permitted average emission limit applicable to the equipment under test. This peak limit applies to the total peak emission level radiated by the device.
- All test were performed with transmitter set to maximum power.
- Spectrum analyzer settings:
 - Peak detector RBW = 1 MHz, VBW = 3 MHz
 - Average detector RBW = 1 MHz, VBW = 10 Hz
 - Measurement time 100 ms

Sample calculation:
 Correction factor (dB) = antenna factor ACF (dB) + cable loss (dB) - amplifier gain (dB)
 Field strength (dB μ V/m) = XX dB μ V (reading from receiver/spectrum analyzer) + XX dB (Correction factor)

Example:
 47.4 dB μ V/m = 54.6 dB μ V (receiver reading) + 32 dB (antenna factor ACF) + 6.5 dB (cable loss) - 45.7 dB (amplifier gain)

 Nemko Canada Inc., 303 River Rd, Ottawa, ON, Canada, K1V 1H2	Section 8: Testing data	Product: Ultrawave Bi-Static Microwave Receiver (K-Band)	
	Test name: Clause 15.245		
	Test date: March 1, 2011	Test engineer: David Duchesne	Verdict: Pass
	Specification: FCC Part 15 Subpart C		

Test data, continued
Spurious emissions (Emissions radiated outside of the specified frequency bands, except for harmonics), continued
18 to 24.075 GHz
No emissions detected within 20 dB of §15.209 limit.
24.175 to 40 GHz
No emissions detected within 20 dB of §15.209 limit.
40 to 100 GHz
All emissions were attenuated more than 50 dB below fundamental.
<ul style="list-style-type: none"> - Transmitter was verified at low mid and high channel. (CH1, CH6, and CH10). - All test were performed with transmitter set to maximum power. - Spectrum analyzer settings: <ul style="list-style-type: none"> - Peak detector RBW = 1 MHz, VBW = 3 MHz - Average detector RBW = 1 MHz, VBW = 10 Hz - Measurement time 100 ms

Measurement details
<ul style="list-style-type: none"> - The EUT was placed at 0.8 m height on a non-conducting support above ground plan - The test antenna was located 1 or 3 m from EUT - The test antenna was oriented for vertical or horizontal polarization. The output of the test antenna was connected to a measuring receiver. - The spectrum was searched for frequencies of interest. - The test antenna was raised and lowered through the specified range of heights (1 to 4 m) until a maximum signal level was detected on the measuring receiver. - The EUT was then be rotated through 360° in the horizontal plane, until the maximum signal level was detected. - The maximum signal level detected by the measuring receiver/spectrum analyzer was noted.



Nemko Canada Inc.,
303 River Rd, Ottawa, ON, Canada, K1V 1H2

Section 8: Testing data	Product: Ultrawave Bi-Static Microwave Receiver (K-Band)	
Test name: Clause 15.245		
Test date: March 1, 2011	Test engineer: David Duchesne	Verdict: Pass
Specification: FCC Part 15 Subpart C		

Setup photo

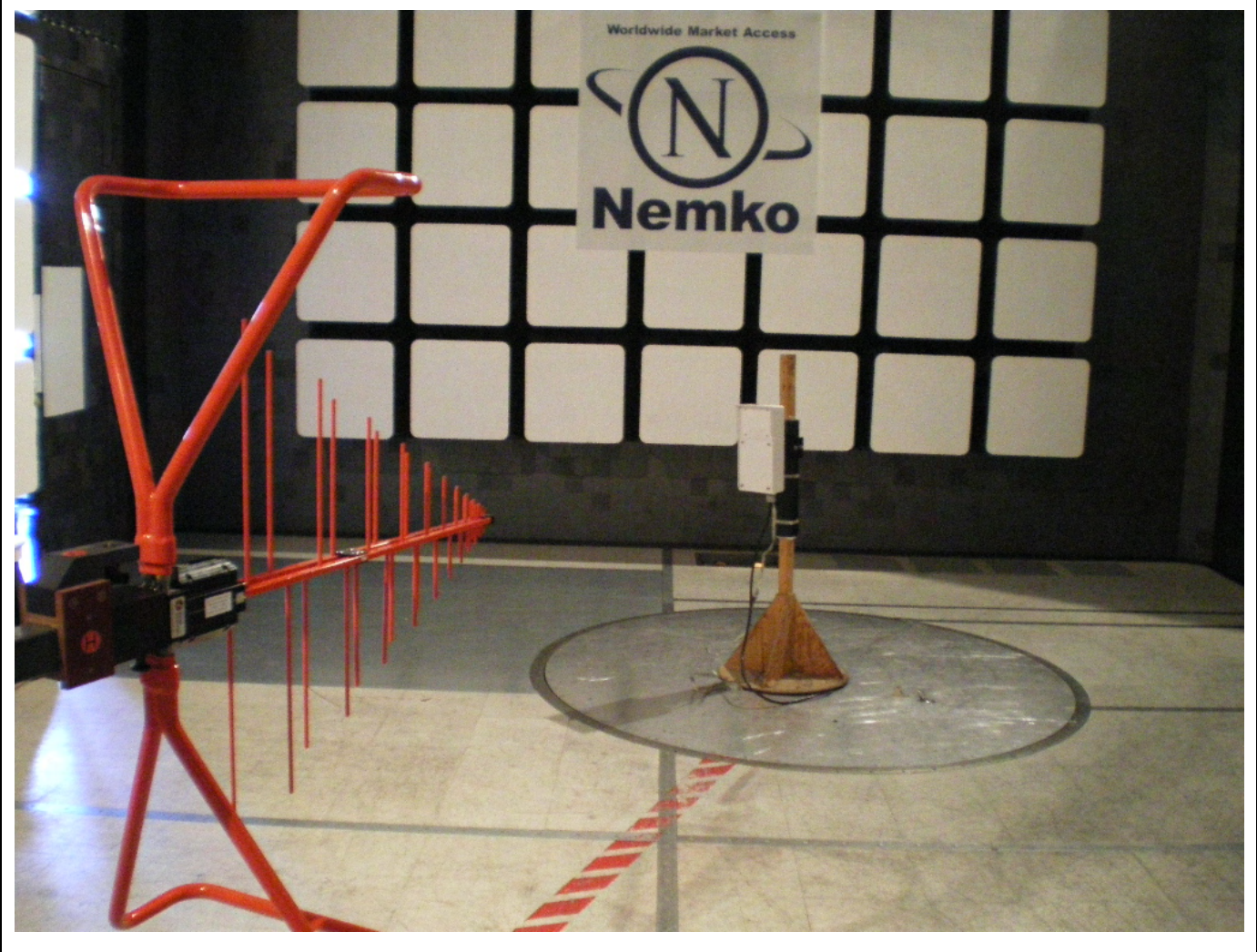



Nemko Canada Inc.,
303 River Rd, Ottawa, ON, Canada, K1V 1H2

Section 8: Testing data		Product: Ultrawave Bi-Static Microwave Receiver (K-Band)	
Test name: Clause 15.215(e) 20 dB bandwidth			
Test date: March 4, 2011		Test engineer: David Duchesne	Verdict: Pass
Specification: FCC Part 15 Subpart C			

8.3 Clause 15.215 (c) 20 dB bandwidth

§ 15.215 Additional provisions to the general radiated emission limitations.

- (c) Intentional radiators operating under the alternative provisions to the general emission limits, as contained in §§15.217 through 15.257 and in Subpart E of this part, must be designed to ensure that the 20 dB bandwidth of the emission, or whatever bandwidth may otherwise be specified in the specific rule section under which the equipment operates, is contained within the frequency band designated in the rule section under which the equipment is operated. The requirement to contain the designated bandwidth of the emission within the specified frequency band includes the effects from frequency sweeping, frequency hopping and other modulation techniques that may be employed as well as the frequency stability of the transmitter over expected variations in temperature and supply voltage. If a frequency stability is not specified in the regulations, it is recommended that the fundamental emission be kept within at least the central 80% of the permitted band in order to minimize the possibility of out-of-band operation.

Special notes

None

Test data

Frequency (GHz)	Measured 20 dB bandwidth (kHz)
24.0775	435.9
24.1325	410.26
24.1725	439.1

Sample spectral plots

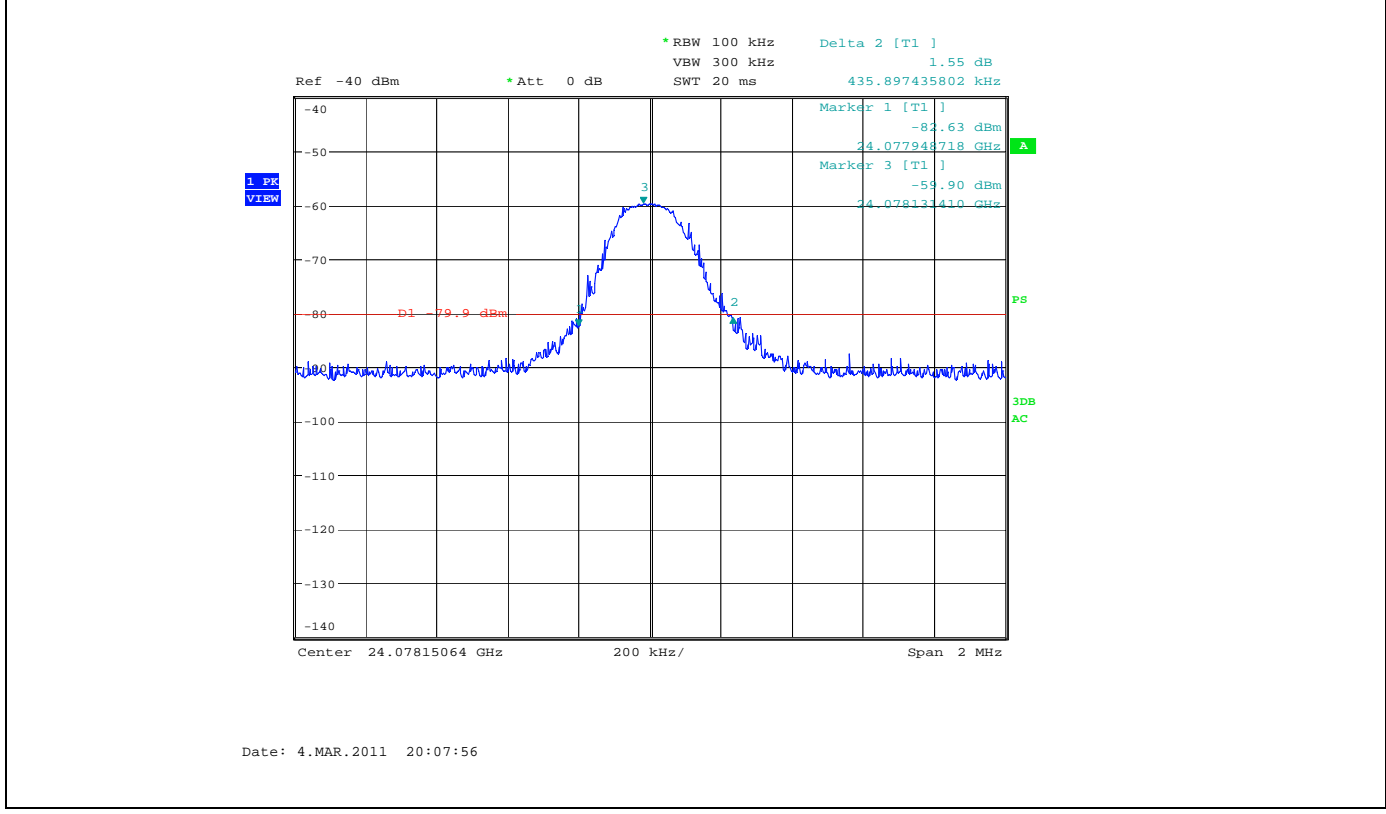

Section 8: Block diagrams of test set-ups

Radiated emissions set-up

