

FCC RADIO TEST REPORT

The device described below is tested by Dongguan Nore Testing Center Co., Ltd. to determine the maximum emission levels emanating from the device, the severe levels which the device can endure and E.U.T.'s performance criterion. The test results, data evaluation, test procedures, and equipment of configurations shown in this report were made in accordance with the procedures in ANSI C63.10(2013).

Applicant/ Manufacturer : Peavey Electronics Corp
Address : 5022 Hartley Peavey Drive, Meridian MS. 39305, United States
Factory : Ningbo Tonwel Audio Co., Ltd.
Address : 500, Qihang North Road, Zhanqi Town, Ningbo, China
E.U.T. : Column Array Powered Speaker System
Brand Name : Peavey
Model No. : LN1263
FCC ID : I4S-LN1263
Measurement Standard : FCC PART 15.247
Date of Receiver : August 02, 2019
Date of Test : August 08, 2019 to November 03, 2019
Date of Report : November 04, 2019

This Test Report is Issued Under the Authority of :

Prepared by

Approved & Authorized Signer



Sundry Jiang / Engineer



Tori Fan / Authorized Signatory

This test report is for the customer shown above and their specific product only. This report applies to above tested sample only and shall not be reproduced in part without written approval of Dongguan Nore Testing Center Co., Ltd.

Table of Contents

1. GENERAL INFORMATION	5
1.1 PRODUCT DESCRIPTION FOR EQUIPMENT UNDER TEST	5
1.2 RELATED SUBMITTAL(S) / GRANT (S)	7
1.3 TEST METHODOLOGY	7
1.4 EQUIPMENT MODIFICATIONS	7
1.5 SUPPORT DEVICE	7
1.6 TEST FACILITY AND LOCATION	8
1.7 SUMMARY OF TEST RESULTS	9
1.8 DEVIATIONS AND ABNORMALITIES FROM STANDARD CONDITIONS.....	9
2. SYSTEM TEST CONFIGURATION.....	10
2.1 EUT CONFIGURATION	10
2.2 SPECIAL ACCESSORIES	10
2.3 DESCRIPTION OF TEST MODES	10
2.4 EUT EXERCISE	10
3. CONDUCTED EMISSIONS TEST	11
3.1 TEST SET-UP (BLOCK DIAGRAM OF CONFIGURATION)	11
3.2 TEST CONDITION.....	11
3.3 MEASUREMENT RESULTS	11
4. RADIATED EMISSION TEST.....	14
4.1 TEST SET-UP (BLOCK DIAGRAM OF CONFIGURATION)	14
4.2 MEASUREMENT PROCEDURE	15
4.3 LIMIT	16
4.4 MEASUREMENT RESULTS	16
5. CHANNEL SEPARATION TEST.....	20
5.1 MEASUREMENT PROCEDURE	20
5.2 TEST SET-UP (BLOCK DIAGRAM OF CONFIGURATION)	20
5.3 MEASUREMENT RESULTS	20
6. 20DB BANDWIDTH.....	26
6.1 MEASUREMENT PROCEDURE	26
6.2 TEST SET-UP (BLOCK DIAGRAM OF CONFIGURATION)	26
6.3 MEASUREMENT RESULTS	26
7. HOPPING CHANNEL NUMBER	32
7.1 MEASUREMENT PROCEDURE	32
7.2 TEST SET-UP (BLOCK DIAGRAM OF CONFIGURATION)	32
7.3 MEASUREMENT RESULTS	32



8. TIME OF OCCUPANCY (DWELL TIME)	35
8.1 MEASUREMENT PROCEDURE	35
8.2 MEASUREMENT RESULTS	35
9. MAXIMUM PEAK OUTPUT POWER	41
9.1 MEASUREMENT PROCEDURE	41
9.2 MEASUREMENT RESULTS	41
10. BAND EDGE	47
10.1 MEASUREMENT PROCEDURE	47
10.2 LIMIT	47
10.3 MEASUREMENT RESULTS	47
11. ANTENNA APPLICATION	54
11.1 ANTENNA REQUIREMENT.....	54
11.2 MEASUREMENT RESULTS	54
12. CONDUCTED SPURIOUS EMISSIONS	55
12.1 MEASUREMENT PROCEDURE	55
12.2. MEASUREMENT RESULTS	55
13. TEST EQUIPMENT LIST	59

1. GENERAL INFORMATION

1.1 Product Description for Equipment under Test

E.U.T. : Column Array Powered Speaker System

Main Model Name : LN1263

Additional Model Name : N/A

Brand Name : Peavey

E.U.T. Type : Floor-standing

Rating : AC 100-120V ~50/60Hz

Test Voltage : AC 120V ~60Hz

Cable : AC Line: 1.5m unshielded
Speaker Line: 4.56m unshielded

Hardware version : VER

Software version : VER1.0.0

Note : N/A

Technical parameters (Bluetooth Function)

Bluetooth Version : V5.0

Frequency Range : 2402-2480MHz

Modulation : GFSK, $\pi/4$ -DQPSK, 8DPSK

Number of Channel : 79

Channel space : 1MHz

Antenna Type : PCB antenna

Antenna Gain : 0dBi (Declared by manufacturer)



Channel List

Channel	Frequency MHz	Channel	Frequency MHz	Channel	Frequency MHz	Channel	Frequency MHz
1	2402	21	2422	41	2442	61	2462
2	2403	22	2423	42	2443	62	2463
3	2404	23	2424	43	2444	63	2464
4	2405	24	2425	44	2445	64	2465
5	2406	25	2426	45	2446	65	2466
6	2407	26	2427	46	2447	66	2467
7	2408	27	2428	47	2448	67	2468
8	2409	28	2429	48	2449	68	2469
9	2410	29	2430	49	2450	69	2470
10	2411	30	2431	50	2451	70	2471
11	2412	31	2432	51	2452	71	2472
12	2413	32	2433	52	2453	72	2473
13	2414	33	2434	53	2454	73	2474
14	2415	34	2435	54	2455	74	2475
15	2416	35	2436	55	2456	75	2476
16	2417	36	2437	56	2457	76	2477
17	2418	37	2438	57	2458	77	2478
18	2419	38	2439	58	2459	78	2479
19	2420	39	2440	59	2460	79	2480
20	2421	40	2441	60	2461		

Note: According to section 15.31(m), regards to the operating frequency range over 10MHz, the Lowest, middle, and the highest frequency of channel were selected to perform the test. The selected frequency and test software see below:

Channel	Frequency MHz
1	2402
40	2441
79	2480

Test SW version	InstallBlueSuite_2_6_2
-----------------	------------------------

1.2 Related Submittal(s) / Grant (s)

This submittal(s) (test report) is intended for **FCC ID: I4S-LN1263** filing to comply with Section 15.247 of the FCC Part 15, Subpart C Rule.

1.3 Test Methodology

Both AC mains line-conducted and radiated emission measurements were performed according to the procedures in ANSI C63.10 (2013). Radiated emission measurement was performed in semi-anechoic chamber and conducted emission measurement was performed in shield room. For radiated emission measurement, preliminary scans were performed in the semi-anechoic chamber only to determine the worst case modes. All radiated tests were performed at an antenna to EUT distance of 3 meters.

1.4 Equipment Modifications

Not available for this EUT intended for grant.

1.5 Support Device

Notebook	:	Manufacturer: Lenovo Model: TP00067A P/N: SL10G10768 S/N: PF-0DS3YC 15/12 CE, FCC: DOC
Adapter	:	Manufacturer: Lenovo Model: ADLX65NLC3A I/P: AC 100-240V 50-60Hz, 1.8A O/P: DC 20V 3.25A

1.6 Test Facility and Location

Site Description

EMC Lab : Listed by CNAS, August 13, 2018
The certificate is valid until August 13, 2024
The Laboratory has been assessed and proved to be in compliance with CNAS/CL01
The Certificate Registration Number is L5795.

Listed by A2LA, November 01, 2017
The certificate is valid until December 31, 2021
The Laboratory has been assessed and proved to be in compliance with ISO17025
The Certificate Registration Number is 4429.01

Listed by FCC, November 06, 2017
The Designation Number is CN1214
Test Firm Registration Number: 907417

Listed by Industry Canada, June 08, 2017
The Certificate Registration Number. Is 46405-9743A

Name of Firm : Dongguan Nore Testing Center Co., Ltd.
(Dongguan NTC Co., Ltd.)

Site Location : Building D, Gaosheng Science and Technology park,
Hongtu road, Nancheng district,
Dongguan city, Guangdong province, China

1.7 Summary of Test Results

FCC Rules	Description Of Test	Uncertainty	Result
§15.247(a)(1)	Channel Separation test	$\pm 1.42 \times 10^{-4}\%$	Compliant
§15.247(a)(1)	20dB Bandwidth	$\pm 1.42 \times 10^{-4}\%$	Compliant
§15.247(a)(1)(iii)	Hopping Channel Number	$\pm 1.42 \times 10^{-4}\%$	Compliant
§15.247(a)(1)(iii)	Time of Occupancy (Dwell Time)	$\pm 5\%$	Compliant
§15.247(b)	Max Peak output Power test	$\pm 1.06\text{dB}$	Compliant
§15.247(d)	Band edge test	$\pm 1.70\text{dB}$	Compliant
§15.207 (a)	AC Power Conducted Emission	$\pm 1.06\text{dB}$	Compliant
§15.247(d), §15.209, §15.205	Radiated Emission	$\pm 4.60\text{dB}$	Compliant
§15.203	Antenna Requirement	N/A	Compliant
§15.247(d)	Conducted Spurious Emission	$\pm 2.52\text{dB}$	Compliant

1.8 Deviations and Abnormalities from Standard Conditions

No additions, deviations and exclusions from the standard.

2. System Test Configuration

2.1 EUT Configuration

The EUT configuration for testing is installed on RF field strength measurement to meet the Commissions requirement and operating in a manner which intends to maximize its emission characteristics in a continuous normal application.

2.2 Special Accessories

Not available for this EUT intended for grant.

2.3 Description of test modes

The EUT has been tested under operating condition. Test program used to control the EUT for staying in continuous transmitting and normal mode is programmed. The Lowest, middle and highest channel were chosen for testing, and all packets DH1, DH3, DH5, 2DH1, 2DH3, 2DH5, 3DH1, 3DH3, 3DH5 mode in all modulation type GFSK, $\pi/4$ -DQPSK, 8DPSK were tested.

2.4 EUT Exercise

The EUT was operated in the engineering mode to fix the Tx frequency that was for the purpose of the measurements.

3. Conducted Emissions Test

3.1 Test SET-UP (Block Diagram of Configuration)

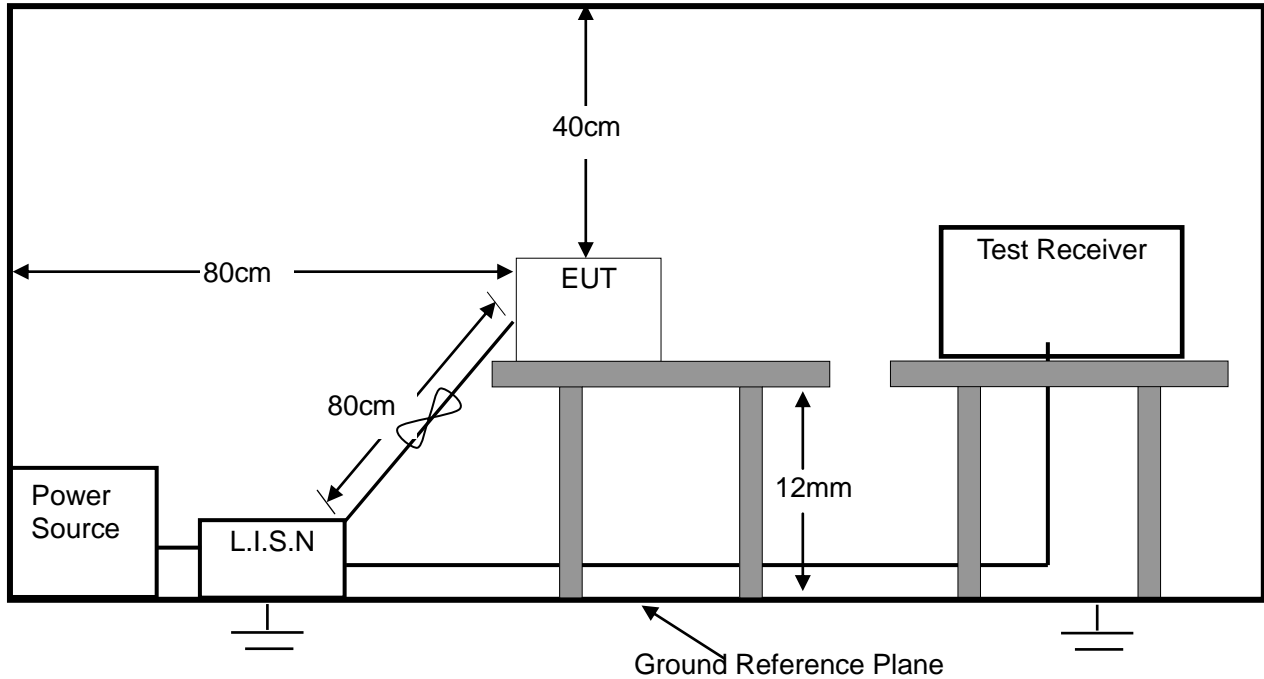

3.2 Test Condition

Test Requirement: FCC Part 15.207

Frequency Range: 150KHz ~ 30MHz

Detector: RBW 9KHz, VBW 30KHz

Operation Mode: TX

3.3 Measurement Results

Please refer to following plots of the worst case: GFSK High channel.



Dongguan NTC Co., Ltd.
 Tel: +86-769-22022444 Fax: +86-769-22022799
 Web: [Http://www.ntc-c.com](http://www.ntc-c.com)

Conducted Emission Measurement

File :LN1263 Data :#68 Date: 2019/9/12 Time: 16:24:42

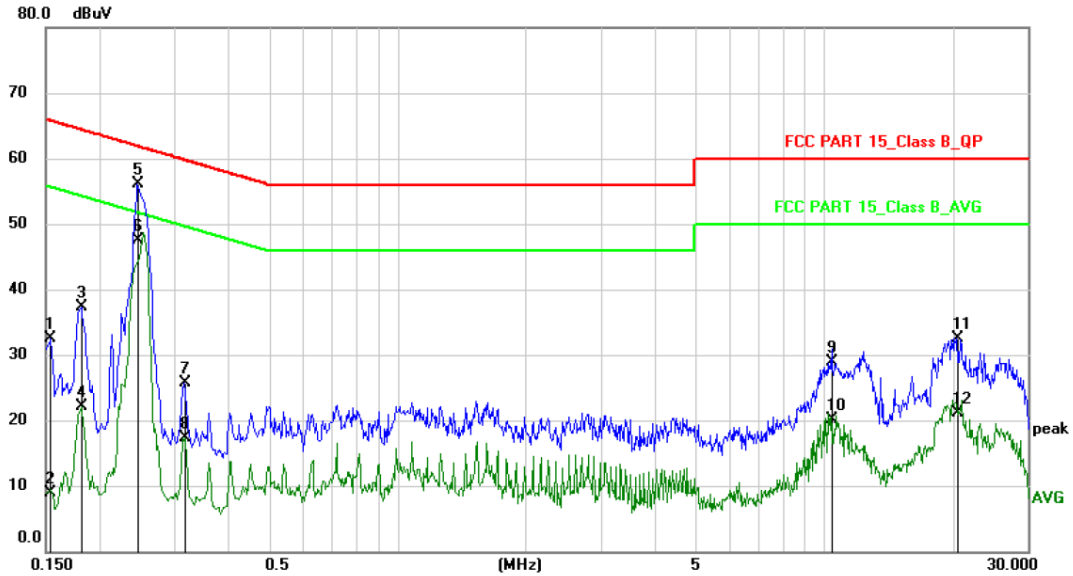

Site: Phase: **L1** Temperature: 26
 Limit: FCC PART 15_Class B_QP Power: AC120V/60Hz Humidity: 60 %
 EUT: Column Array Powered Speaker System
 M/N: LN1263
 Mode: TX
 Note:

No.	Mk.	Freq. MHz	Reading Level dBuV	Correct Factor dB	Measure- ment dBuV	Limit dBuV	Over dB	Detector	Comment
1		0.1539	21.89	10.61	32.50	65.79	-33.29	QP	
2		0.1539	-1.61	10.61	9.00	55.79	-46.79	AVG	
3		0.1819	26.79	10.61	37.40	64.40	-27.00	QP	
4		0.1819	11.59	10.61	22.20	54.40	-32.20	AVG	
5		0.2459	45.49	10.61	56.10	61.89	-5.79	QP	
6	*	0.2459	36.89	10.61	47.50	51.89	-4.39	AVG	
7		0.3180	15.09	10.61	25.70	59.76	-34.06	QP	
8		0.3180	6.79	10.61	17.40	49.76	-32.36	AVG	
9		10.4379	18.33	10.67	29.00	60.00	-31.00	QP	
10		10.4379	9.43	10.67	20.10	50.00	-29.90	AVG	
11		20.4176	21.82	10.68	32.50	60.00	-27.50	QP	
12		20.4176	10.42	10.68	21.10	50.00	-28.90	AVG	



Dongguan NTC Co., Ltd.
 Tel: +86-769-22022444 Fax: +86-769-22022799
 Web: [Http://www.ntc-c.com](http://www.ntc-c.com)

Conducted Emission Measurement

File :LN1263 Data :#69 Date: 2019/9/12 Time: 16:31:25

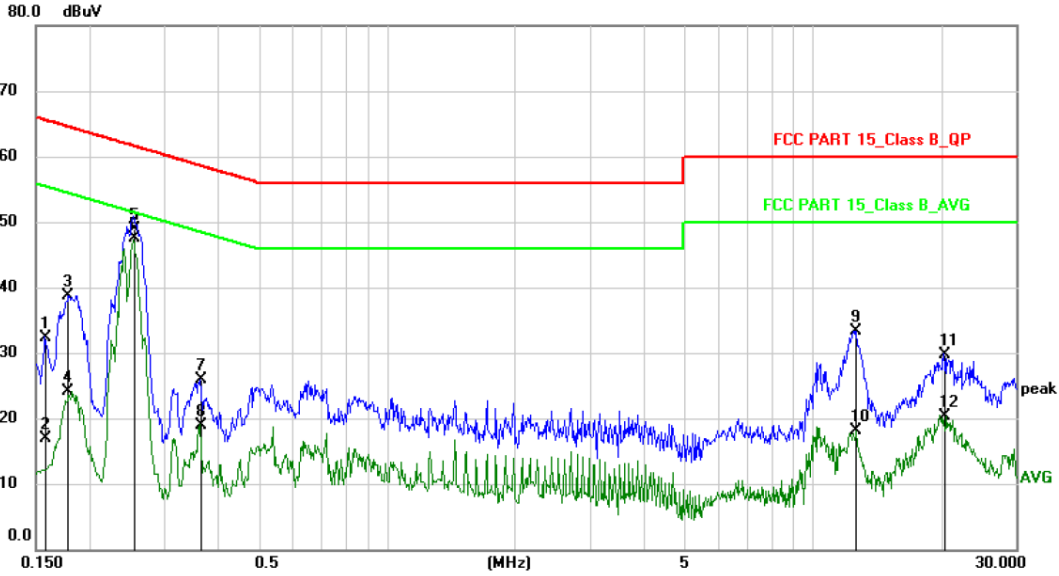

Site Phase: **N** Temperature: 26
 Limit: FCC PART 15_Class B_QP Power: AC120V/60Hz Humidity: 60 %
 EUT: Column Array Powered Speaker System
 M/N: LN1263
 Mode: TX
 Note:

No.	Mk.	Freq. MHz	Reading Level dBuV	Correct Factor dB	Measure- ment dBuV	Limit dBuV	Over dB	Detector	Comment
1		0.1580	21.79	10.61	32.40	65.57	-33.17	QP	
2		0.1580	6.39	10.61	17.00	55.57	-38.57	AVG	
3		0.1785	28.19	10.61	38.80	64.56	-25.76	QP	
4		0.1785	13.59	10.61	24.20	54.56	-30.36	AVG	
5		0.2540	38.39	10.61	49.00	61.63	-12.63	QP	
6	*	0.2540	36.99	10.61	47.60	51.63	-4.03	AVG	
7		0.3634	15.29	10.61	25.90	58.65	-32.75	QP	
8		0.3634	8.39	10.61	19.00	48.65	-29.65	AVG	
9		12.5579	22.73	10.67	33.40	60.00	-26.60	QP	
10		12.5579	7.43	10.67	18.10	50.00	-31.90	AVG	
11		20.3300	19.12	10.68	29.80	60.00	-30.20	QP	
12		20.3300	9.72	10.68	20.40	50.00	-29.60	AVG	

4. Radiated Emission Test

4.1 Test SET-UP (Block Diagram of Configuration)

4.1.1 Radiated Emission Test Set-Up, Frequency Below 30MHz

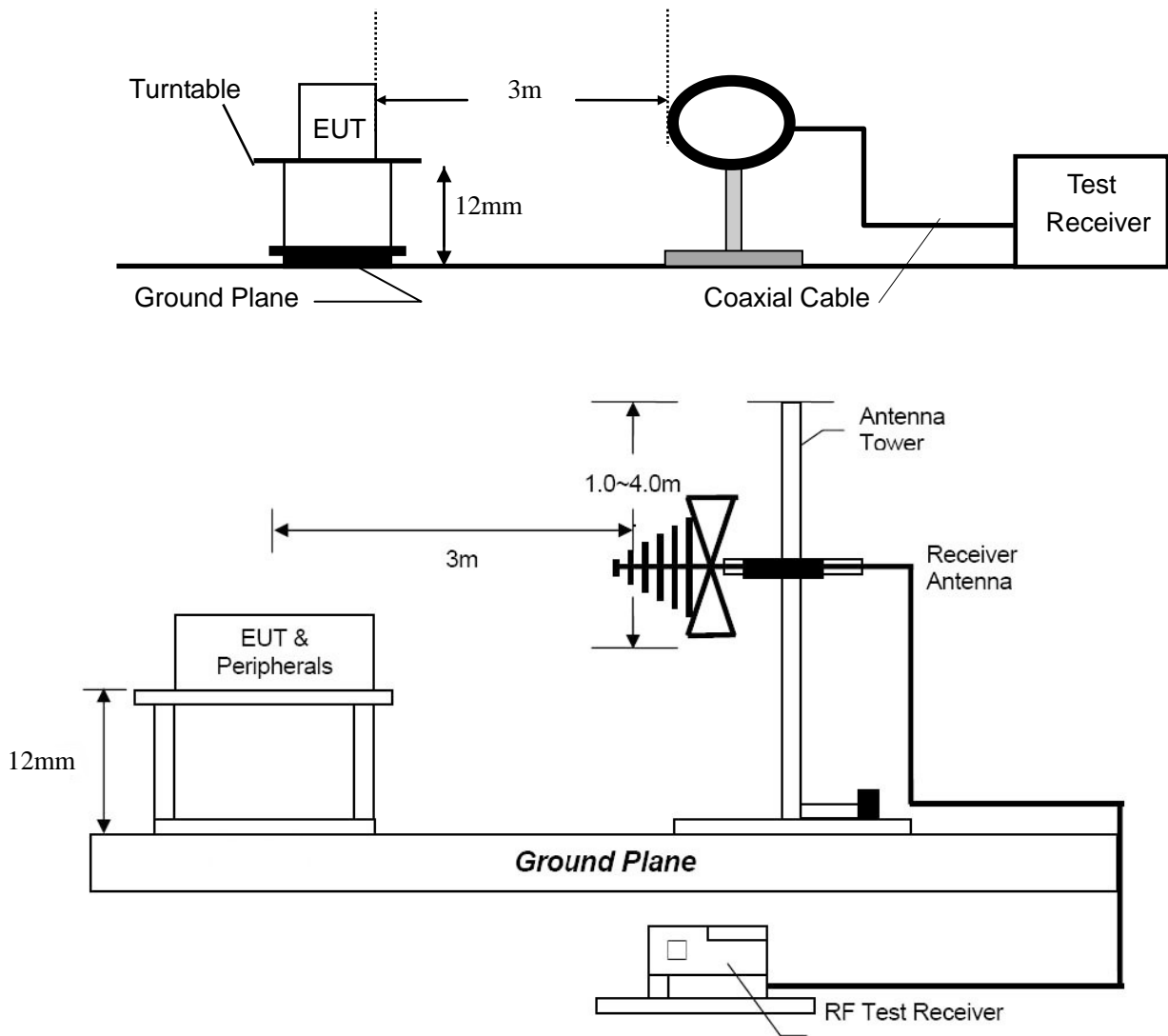

4.1.2 Radiated Emission Test Set-Up, Frequency above 1GHz

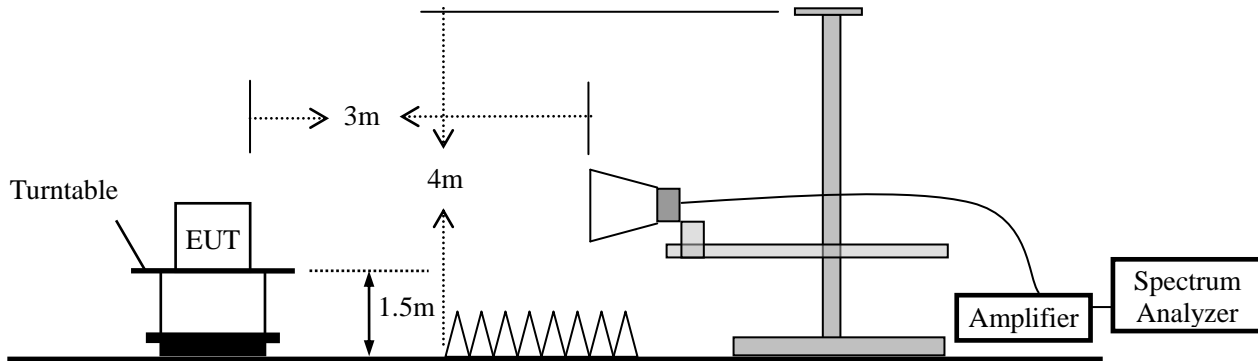

4.2 Measurement Procedure

- Blow 1GHz, the EUT was placed on the top of a rotating table 12mm above the ground at a 3 meter semi- anechoic chamber room.
- For the radiated emission test above 1GHz:
The EUT was placed on the top of a rotating table 1.5 meters above the ground at a 3 meter full anechoic chamber room. The table was rotated 360 degrees to determine the position of the highest radiation. Place the measurement antenna away from each area of the EUT determined to be a source of emissions at the specified measurement distance, while keeping the measurement antenna aimed at the source of emissions at each frequency of significant emissions, with polarization oriented for maximum response. The measurement antenna may have to be higher or lower than the EUT, depending on the radiation pattern of the emission and staying aimed at the emission source for receiving the maximum signal. The final measurement antenna elevation shall be that which maximizes the emissions. The measurement antenna elevation for maximum emissions shall be restricted to a range of heights of from 1 m to 4 m above the ground or reference ground plane.
- The EUT was set 3 meters away from the interference-receiving antenna, which was mounted on the top of a variable-height antenna tower.
- The height of antenna is varied from one meter to four meters above the ground to determine the maximum value of the field strength. Both horizontal and vertical polarizations of the antenna are set to make the measurement.
- For each suspected emission, the EUT was arranged to its worst case and then the antenna was tuned to heights from 1 meter to 4 meters and the rotatable table was turned from 0 degrees to 360 degrees to find the maximum reading. The test-receiver system was set to peak detect function and specified bandwidth with maximum hold mode.
- A Quasi-peak measurement was then made for that frequency point for below 1GHz test. PK and AV for above 1GHz emission test.

During the radiated emission test, the spectrum analyzer was set with the following configurations:

Frequency Band (MHz)	Level	Resolution Bandwidth	Video Bandwidth
30 to 1000	QP	120 kHz	300 kHz
Above 1000	Peak	1 MHz	3 MHz
	Average	1 MHz	10 Hz

4.3 Limit

Frequency range MHz	Distance Meters	Field Strengths Limit (15.209)
		$\mu\text{V/m}$
0.009 ~ 0.490	300	$2400/F(\text{kHz})$
0.490 ~ 1.705	30	$24000/F(\text{kHz})$
1.705 ~ 30	30	30
30 ~ 88	3	100
88 ~ 216	3	150
216 ~ 960	3	200
Above 960	3	500

- Remark :
- (1) Emission level $(\text{dB})\mu\text{V} = 20 \log \text{Emission level } \mu\text{V/m}$
 - (2) The smaller limit shall apply at the cross point between two frequency bands.
 - (3) As shown in 15.35(b), for frequencies above 1000MHz, the field strength limits are based on average detector, however, the peak field strength of any emission shall not exceed the maximum permitted average limits, specified above by more than 20dB under any condition of modulation.
 - (4) The frequency range scanned is from the lowest radio frequency signal generated in the device which is greater than 9 kHz to the tenth harmonic of the highest fundamental frequency or 40 GHz, whichever is lower.

4.4 Measurement Results

Please refer to following plots of the worst case: GFSK High channel.



Dongguan NTC Co., Ltd.
 Tel:+86-769-22022444 Fax:+86-769-22022799
 Web: [Http://www.ntc-c.com](http://www.ntc-c.com)

Radiated Emission Measurement

File :LN1263 Data :#159 Date: 2019/9/9 Time: 14:00:57
 80.0 dBuV/m

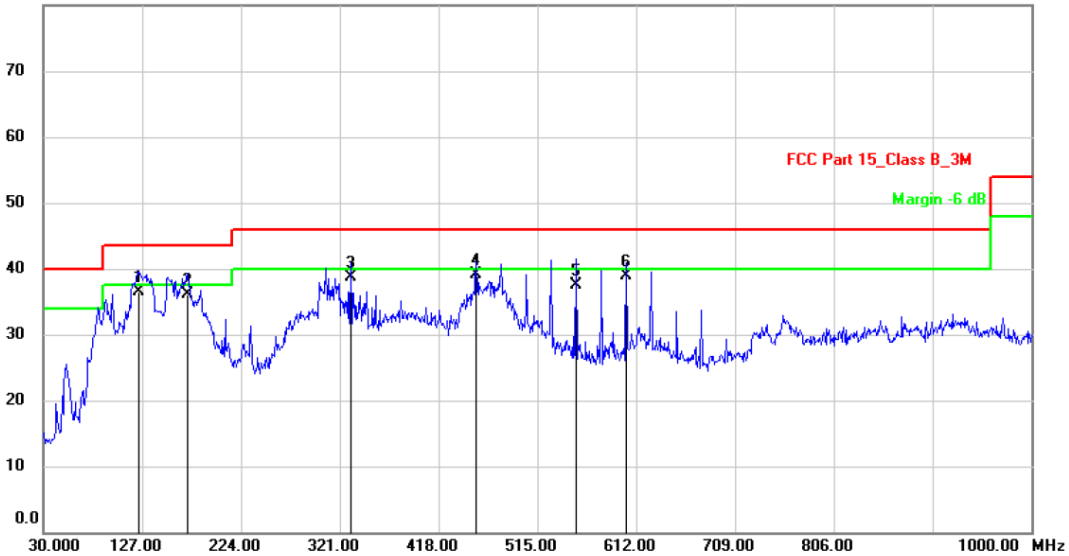

Site Polarization: **Horizontal** Temperature: 26
 Limit: FCC Part 15_Class B_3M Power: AC120V/60Hz Humidity: 47 %
 EUT: Column Array Powered Speaker System Distance: 3m
 M/N: LN1263
 Mode: TX
 Note:

No.	Mk.	Freq. MHz	Reading Level dBuV	Correct Factor dB	Measure- ment dBuV/m	Limit dBuV/m	Over dB	Antenna Height cm	Table Degree degree	Comment
1		124.0900	51.11	-14.51	36.60	43.50	-6.90	QP		
2		171.6200	50.91	-14.71	36.20	43.50	-7.30	QP		
3		331.6700	48.36	-9.56	38.80	46.00	-7.20	QP		
4	*	454.8600	47.04	-7.84	39.20	46.00	-6.80	QP		
5		552.8300	44.06	-6.46	37.60	46.00	-8.40	QP		
6		602.3000	43.90	-5.00	38.90	46.00	-7.10	QP		

Note: Below 30MHz, the emissions are lower than 20dB below the allowable limit.



Dongguan NTC Co., Ltd.
 Tel:+86-769-22022444 Fax:+86-769-22022799
 Web: [Http://www.ntc-c.com](http://www.ntc-c.com)

Radiated Emission Measurement

File :LN1263 Data :#158 Date: 2019/9/9 Time: 13:53:38

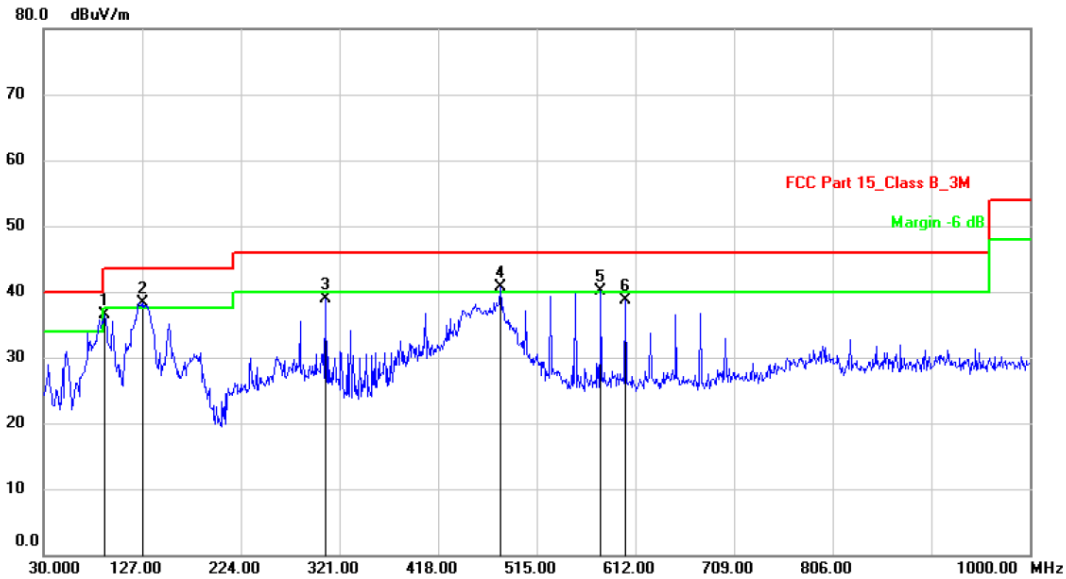

Site Polarization: **Vertical** Temperature: 26
 Limit: FCC Part 15_Class B_3M Power: AC120V/60Hz Humidity: 47 %
 EUT: Column Array Powered Speaker System Distance: 3m
 M/N: LN1263
 Mode: TX
 Note:

No.	Mk.	Freq.	Reading Level	Correct Factor	Measurement	Limit	Over	Antenna Height	Table Degree	Comment
		MHz	dBuV	dB	dBuV/m	dBuV/m	dB	cm	degree	
1		90.1400	53.40	-16.90	36.50	43.50	-7.00	QP		
2	*	127.9700	56.34	-17.94	38.40	43.50	-5.10	QP		
3		307.4200	51.16	-12.26	38.90	46.00	-7.10	QP		
4	!	479.1100	50.04	-9.24	40.80	46.00	-5.20	QP		
5	!	578.0500	47.83	-7.63	40.20	46.00	-5.80	QP		
6		602.3000	45.70	-7.00	38.70	46.00	-7.30	QP		

Note: Below 30MHz, the emissions are lower than 20dB below the allowable limit.



Modulation: GFSK (the worst case)
 Frequency Range: 1-25GHz Test Date : August 21, 2019
 Test Result: PASS Temperature : 24 °C
 Measured Distance: 3m Humidity : 47 %
 Test By: Lee

Freq. (MHz)	Ant.Pol. (H/V)	Reading Level(dBuV)		Factor (dB/m)	Emission Level (dBuV)		Limit 3m (dBuV/m)		Margin (dB)	
		PK	AV		PK	AV	PK	AV	PK	AV
Operation Mode: TX Mode (Low)										
4804	V	46.05	31.95	6.30	52.35	38.25	74.00	54.00	-21.65	-15.75
7206	V	44.82	30.67	10.44	55.26	41.11	74.00	54.00	-18.74	-12.89

4804	H	46.42	31.91	6.30	52.72	38.21	74.00	54.00	-21.28	-15.79
7206	H	45.41	30.69	10.44	55.85	41.13	74.00	54.00	-18.15	-12.87

Operation Mode: TX Mode (Mid)										
4882	V	46.92	31.94	6.60	53.52	38.54	74.00	54.00	-20.48	-15.46
7323	V	45.03	30.70	10.55	55.58	41.25	74.00	54.00	-18.42	-12.75

4882	H	46.84	32.07	6.60	53.44	38.67	74.00	54.00	-20.56	-15.33
7323	H	45.14	30.98	10.55	55.69	41.53	74.00	54.00	-18.31	-12.47

Operation Mode: TX Mode (High)										
4960	V	46.47	31.39	6.89	53.36	38.28	74.00	54.00	-20.64	-15.72
7440	V	44.99	31.20	10.60	55.59	41.80	74.00	54.00	-18.41	-12.20

4960	H	46.13	31.46	6.89	53.02	38.35	74.00	54.00	-20.98	-15.65
7440	H	44.65	30.72	10.60	55.25	41.32	74.00	54.00	-18.75	-12.68

- Note:**
- (1) All Readings are Peak Value and AV.
 - (2) Emission Level= Reading Level + Factor
 - (3) Factor= Antenna Gain + Cable Loss – Amplifier Gain
 - (4) Data of measurement within this frequency range shown “ ---” in the table above means the reading of emissions are attenuated more than 10dB below the permissible limits.
 - (5) Measurement uncertainty : ±3.7dB.
 - (6) Horn antenna used for the emission over 1000MHz.

5. Channel Separation test

5.1 Measurement Procedure

Minimum Hopping Channel Carrier Frequency Separation, FCC Rule 15.247(a)(1): Connect EUT antenna terminal to the spectrum analyzer with a low loss cable, and using the MARKER and Max-Hold function to record the separation of two adjacent channels.

5.2 Test SET-UP (Block Diagram of Configuration)

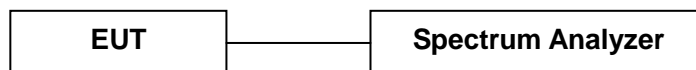

5.3 Measurement Results

Modulation:	GFSK, $\pi/4$ -DQPSK, 8DPSK		
RBW:	100KHz	VBW:	300KHz
Packet:	DH5	Spectrum Detector:	PK
Test By:	Lee	Test Date :	August 21, 2019
Temperature :	22 °C	Humidity :	53 %
Test Result:	PASS		

Channel number	Channel frequency (MHz)	Separation Read Value (KHz)	Separation Limit 2/3 20dB Bandwidth (KHz)
GFSK			
Lowest	2403	1002	>563.60
Middle	2442	1002	>538.40
Highest	2480	1002	>540.93
$\pi/4$-DQPSK			
Lowest	2403	1002	>788.67
Middle	2441	1002	>781.33
Highest	2479	1002	>784.00
8DPSK			
Lowest	2402	1002	>743.33
Middle	2442	1002	>746.67
Highest	2479	1002	>744.67

GFSK Lowest Channel

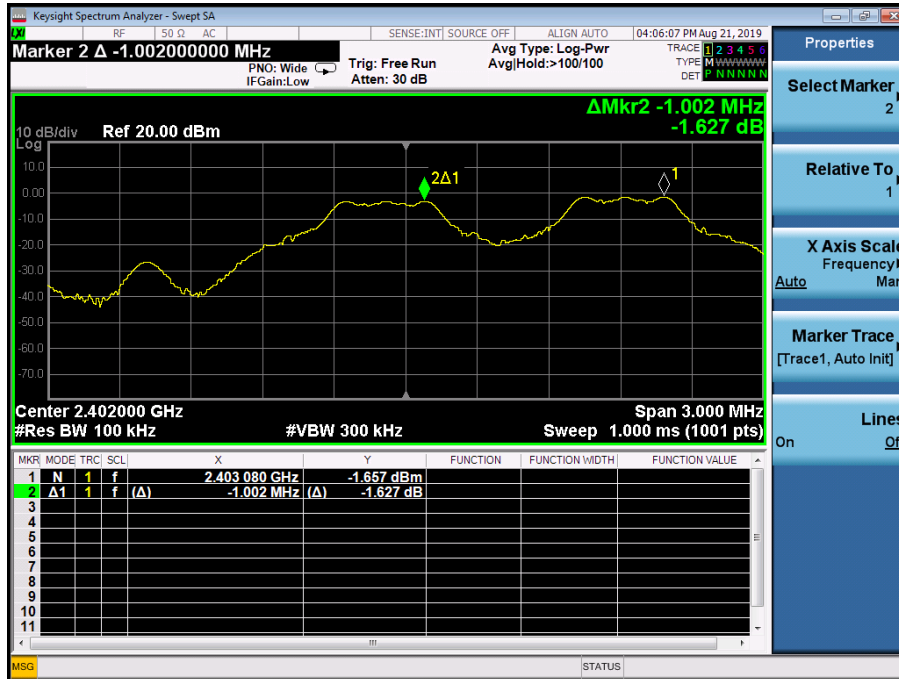

GFSK Middle Channel

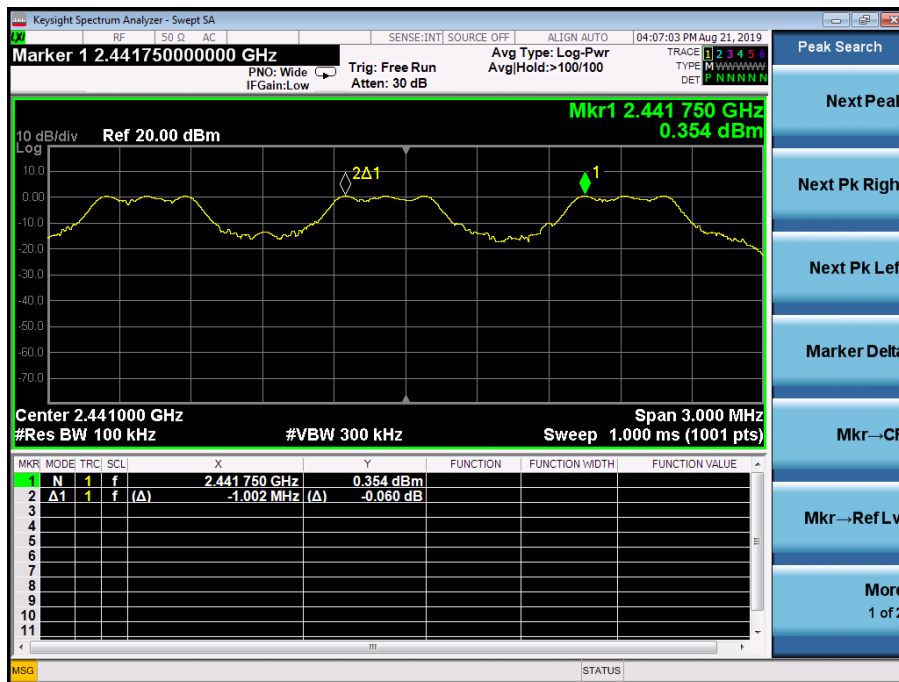

GFSK Highest Channel

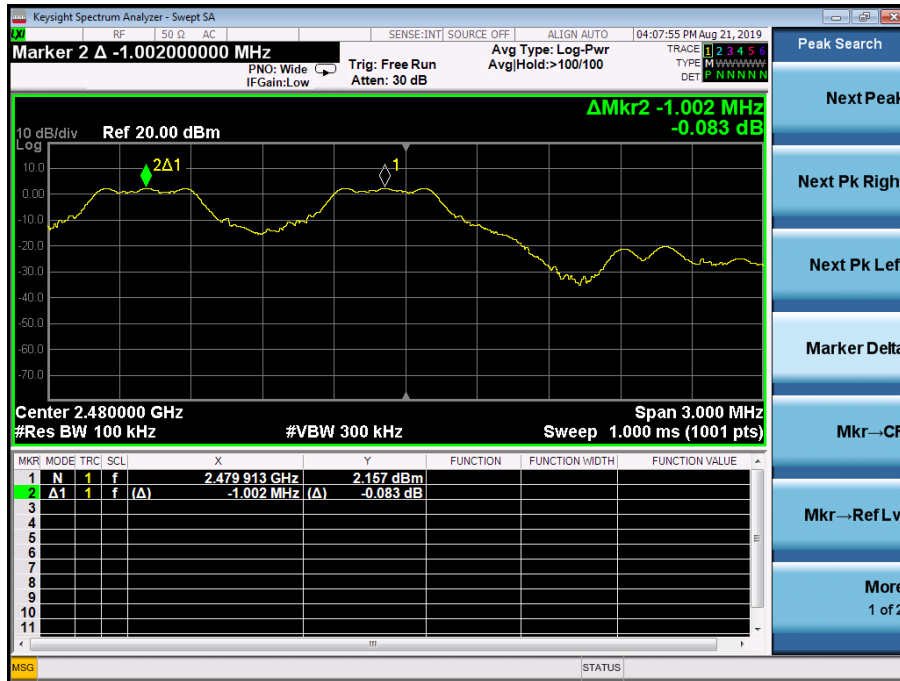

$\pi/4$ -DQPSK Lowest Channel

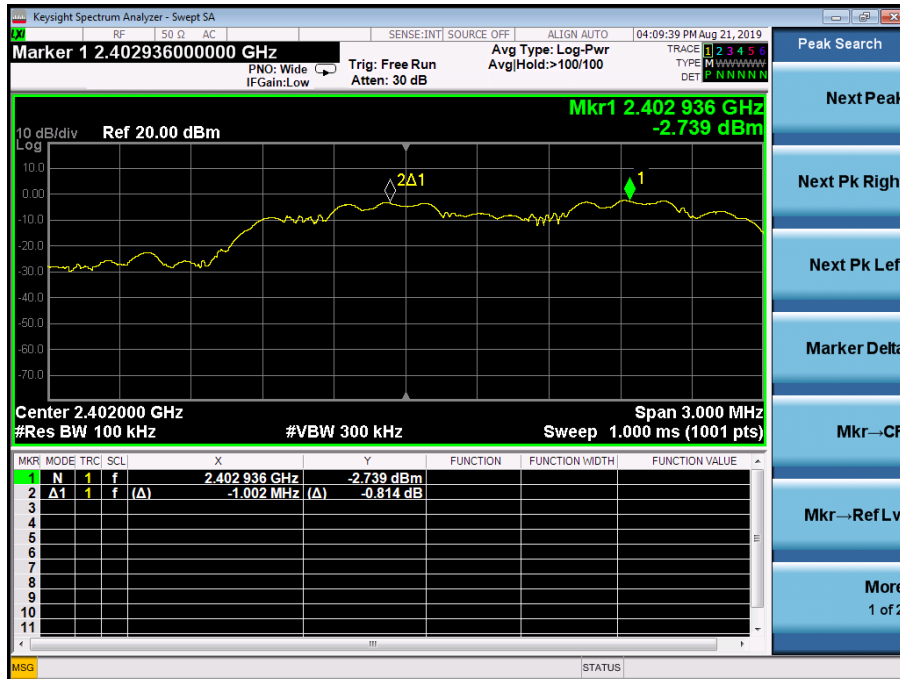

$\pi/4$ -DQPSK Middle Channel

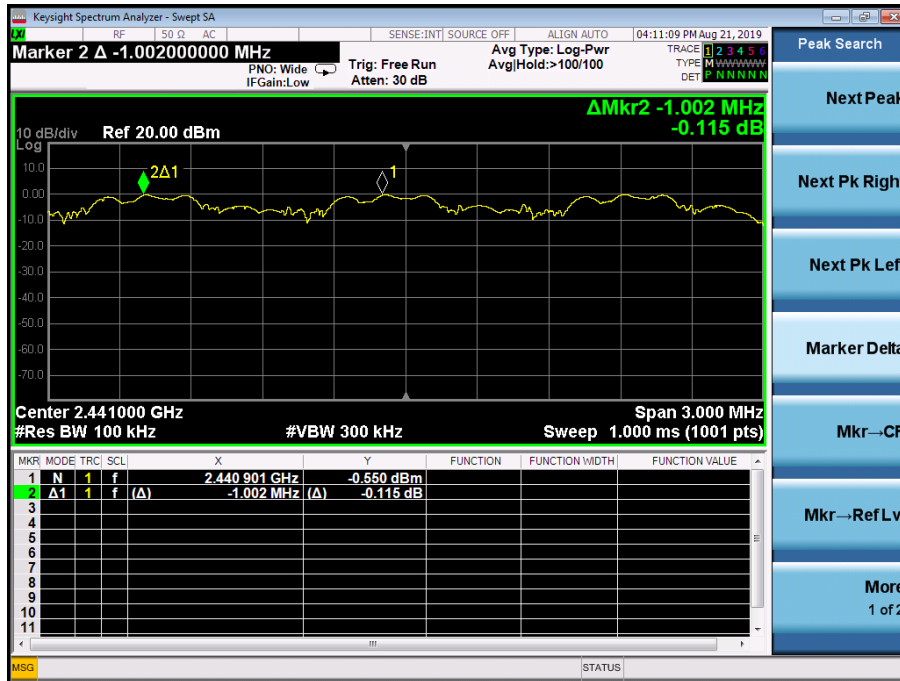

$\pi/4$ -DQPSK Highest Channel

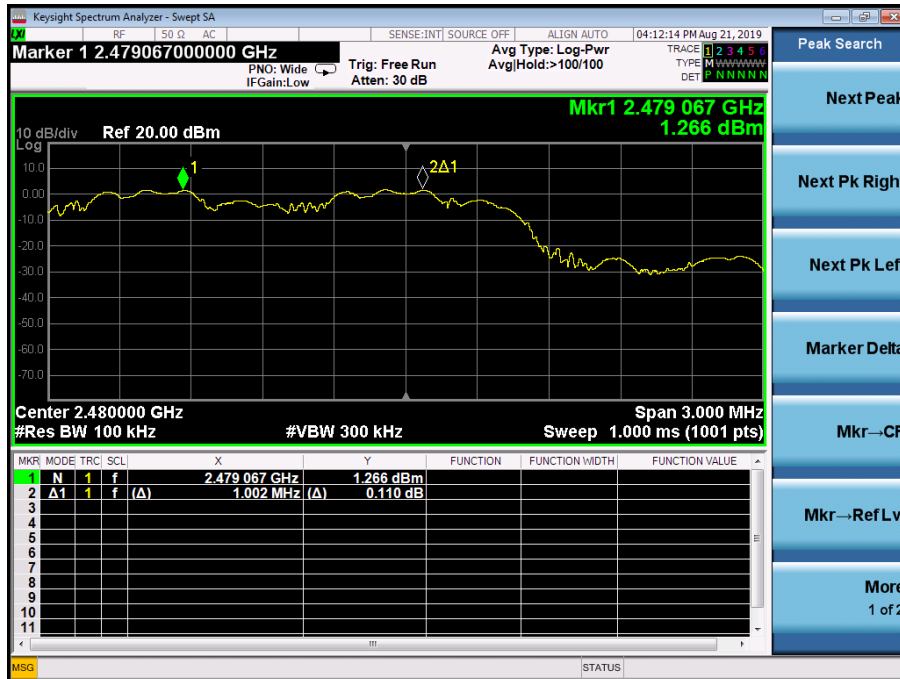

8DPSK Lowest Channel

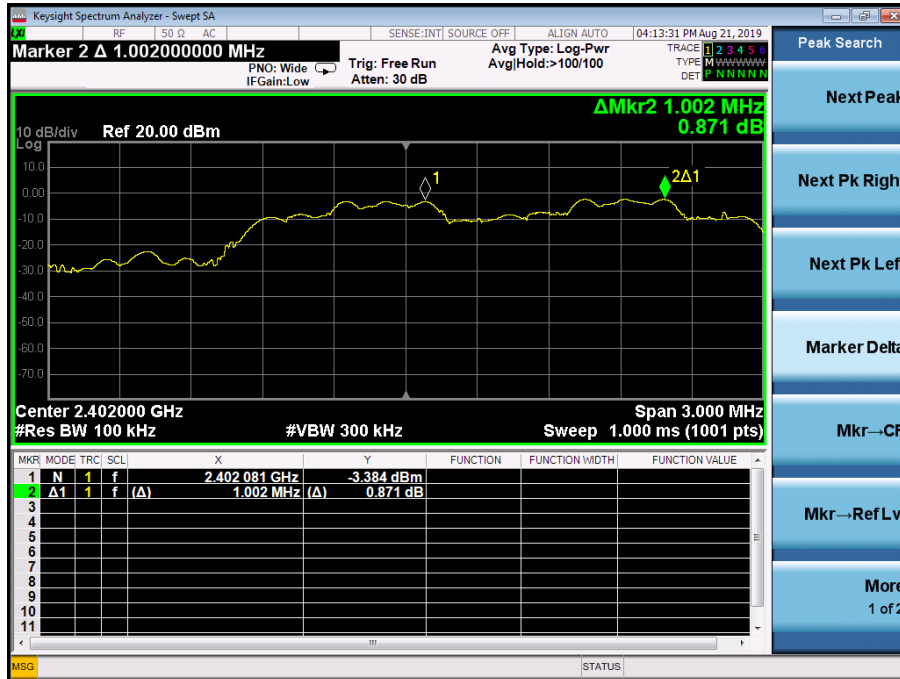

8DPSK Middle Channel

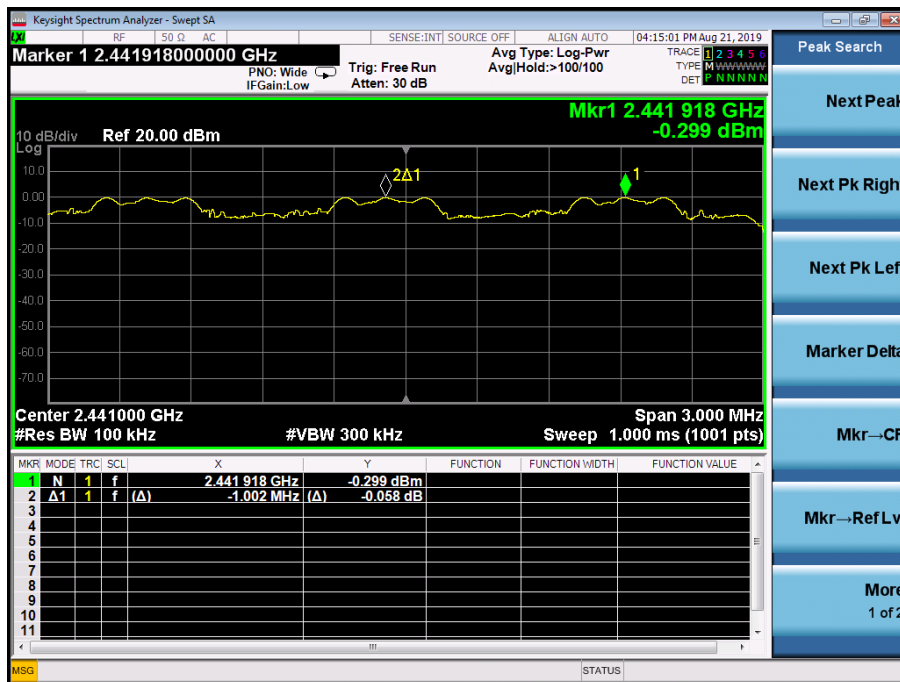

8DPSK Highest Channel

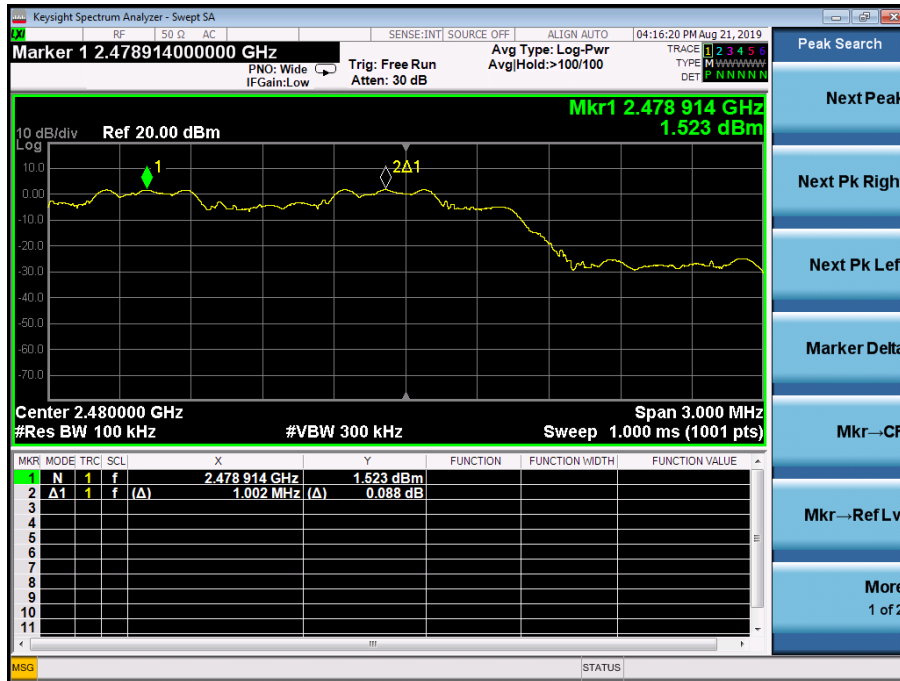

6. 20dB Bandwidth

6.1 Measurement Procedure

Maximum 20dB RF Bandwidth, FCC Rule 15.247(a)(1):

The antenna port of the EUT was connected to the input of a spectrum analyzer. Analyzer RBW was chosen so that the display was a result of the hopping channel modulation. For each RF output channel investigated, the spectrum analyzer center frequency was set to the channel carrier. Use the spectrum 20dB down delta function to measure the bandwidth.

6.2 Test SET-UP (Block Diagram of Configuration)

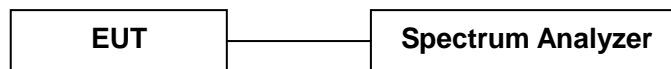

6.3 Measurement Results

Refer to attached data chart.

Modulation:	GFSK, $\pi/4$ -DQPSK, 8DPSK		
RBW:	30KHz	VBW:	100KHz
Packet:	DH5	Spectrum Detector:	PK
Test By:	Lee	Test Date :	August 21, 2019
Temperature :	22 °C	Humidity :	53 %
Test Result:	PASS		

Channel frequency (MHz)	20dB Down BW(kHz)
GFSK	
2402	845.4
2441	807.6
2480	811.4
$\pi/4$-DQPSK	
2402	1183.0
2441	1172.0
2480	1176.0
8DPSK	
2402	1115.0
2441	1120.0
2480	1117.0

GFSK Lowest Channel

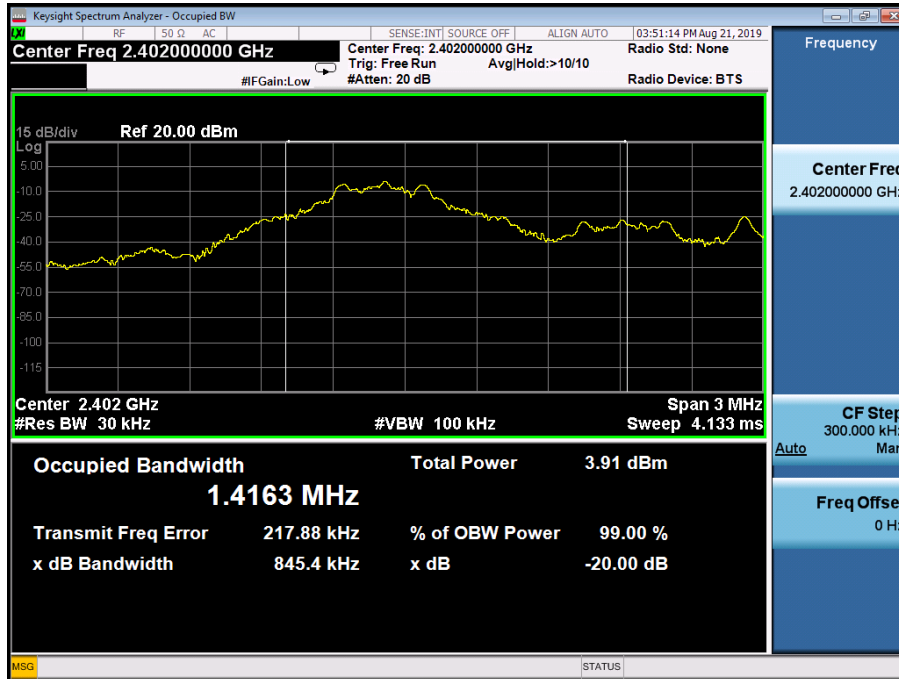

GFSK Middle Channel

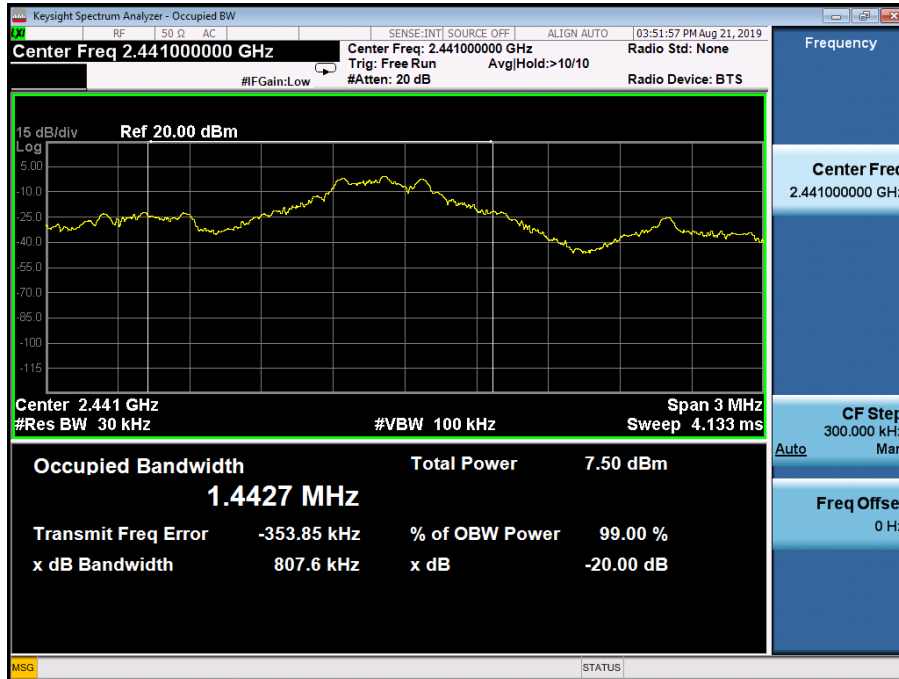

GFSK Highest Channel

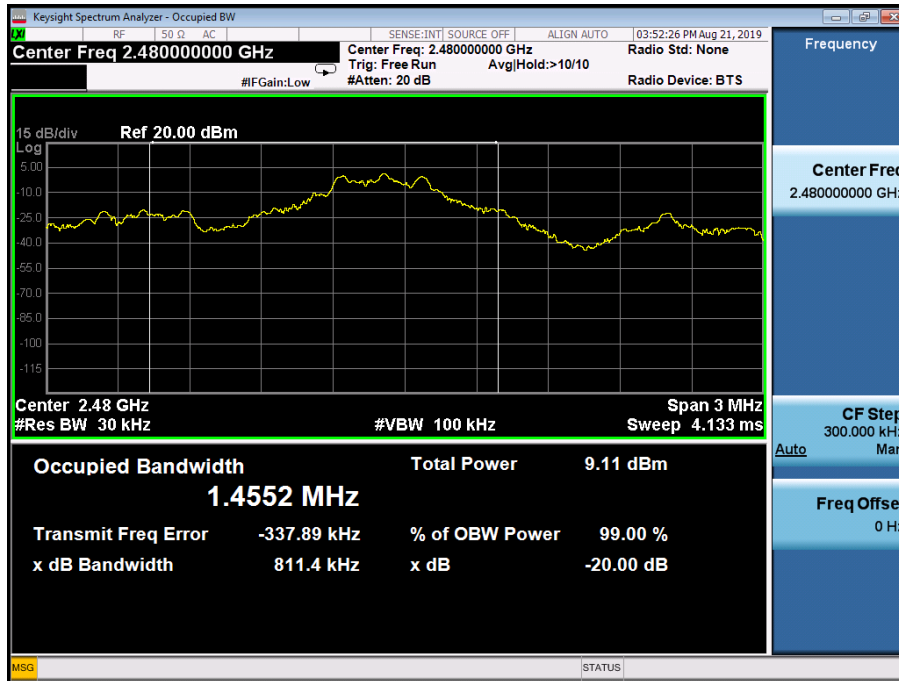

$\pi/4$ -DQPSK Lowest Channel

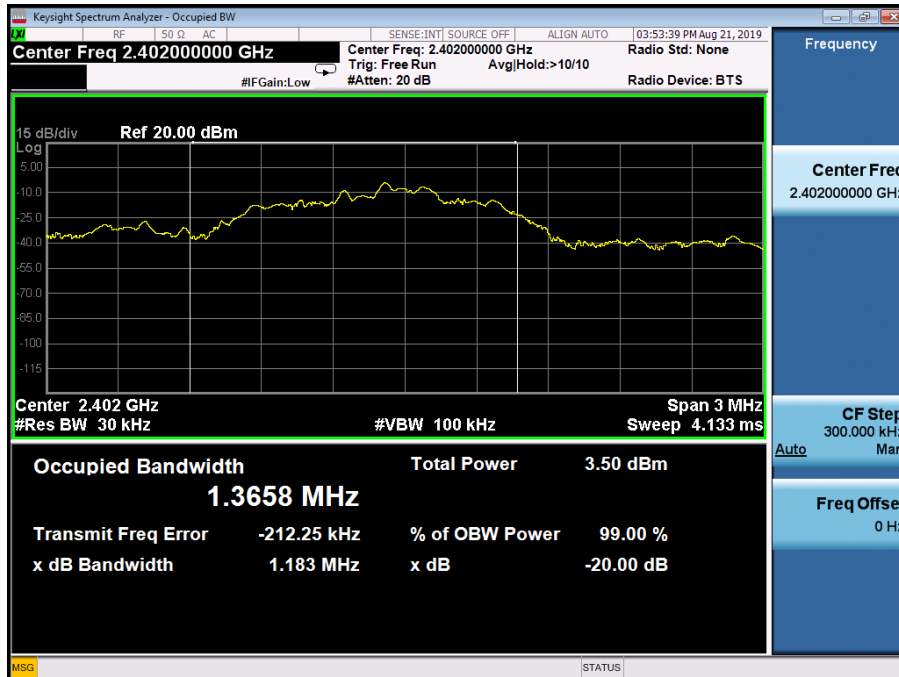

$\pi/4$ -DQPSK Middle Channel

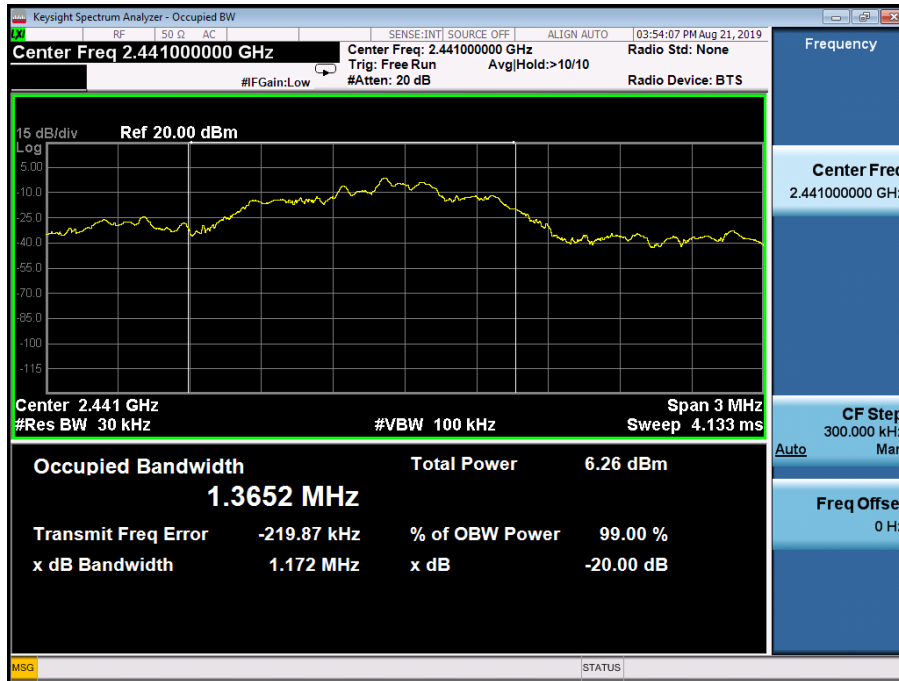

$\pi/4$ -DQPSK Highest Channel

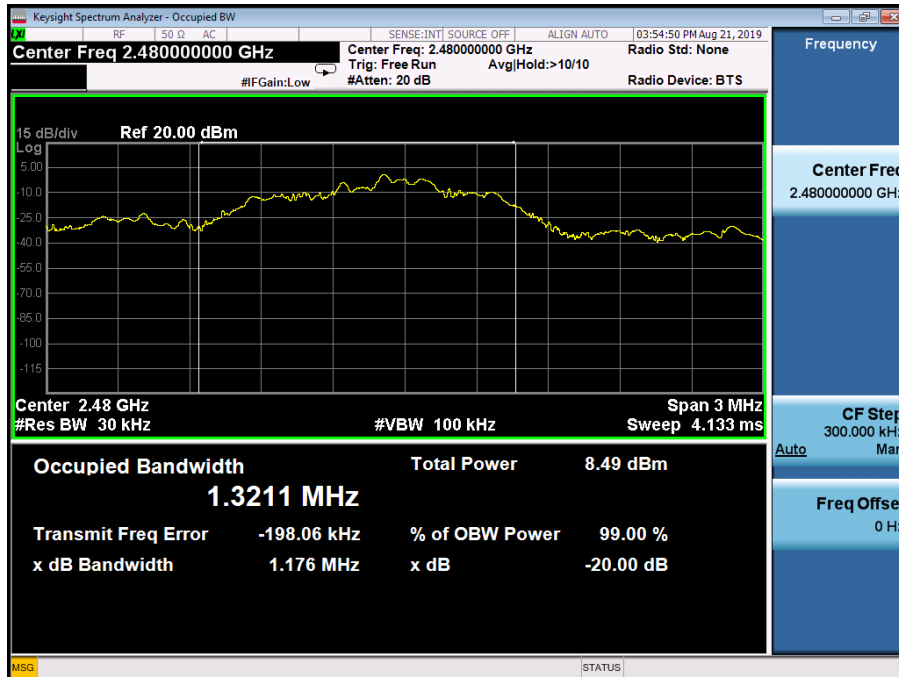

8DPSK Lowest Channel

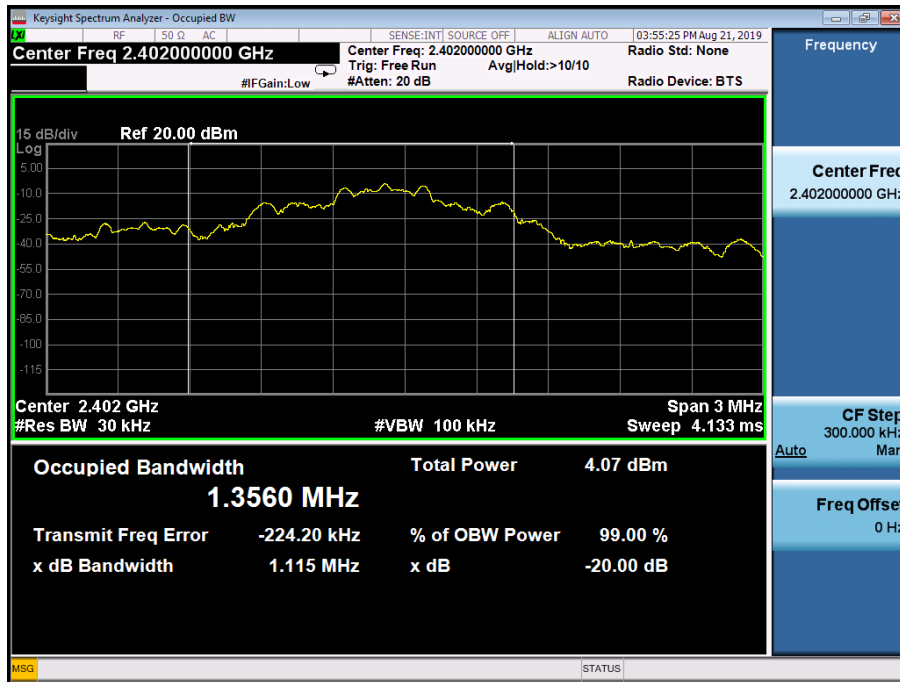

8DPSK Middle Channel

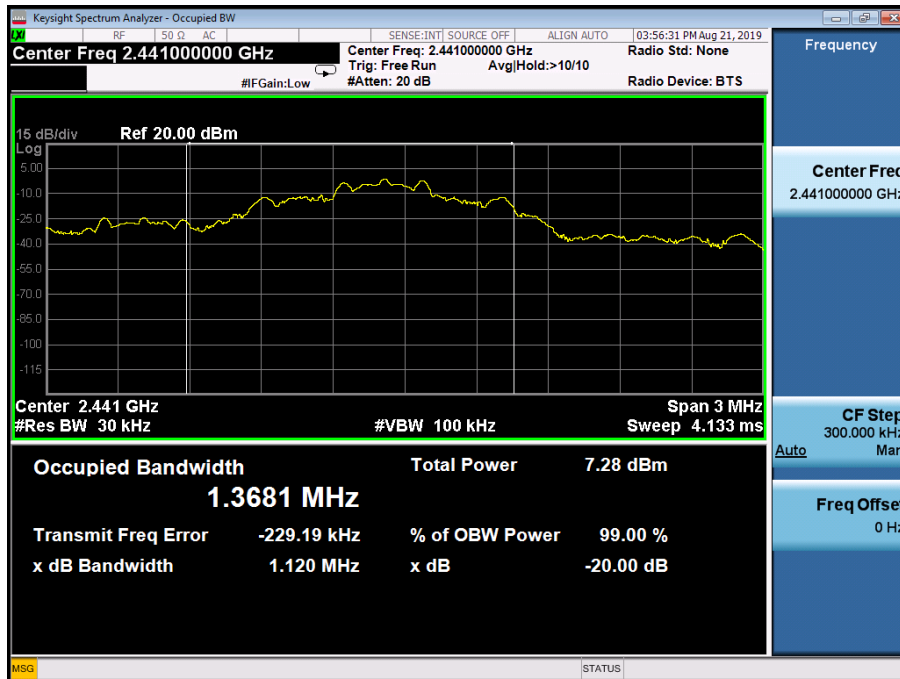

8DPSK Highest Channel

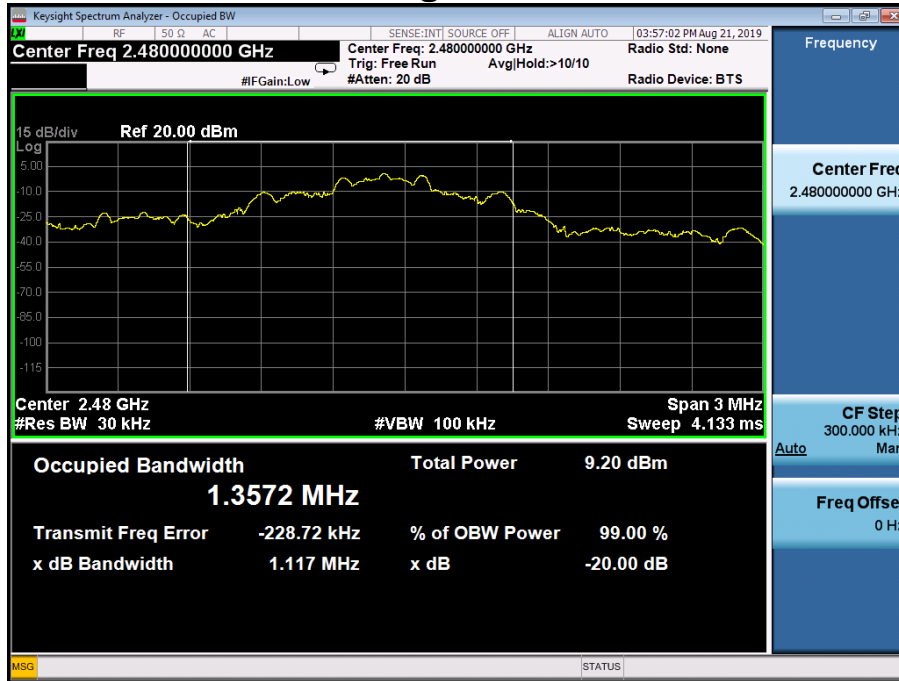

7. Hopping Channel Number

7.1 Measurement Procedure

Minimum Number of Hopping Frequencies, FCC Rule 15.247(a)(1)(iii):

Remove the antenna from the EUT and then connect a low RF cable from the antenna port to the spectrum, and the spectrum analyzer set to MAX HOLD readings were taken for 3-5 minutes. The channel peaks so recorded were added together, and the total number compared to the minimum number of channels required in the regulation.

7.2 Test SET-UP (Block Diagram of Configuration)



7.3 Measurement Results

Modulation	GFSK, $\pi/4$ -DQPSK, 8DPSK		
RBW:	100KHz	VBW:	300KHz
Packet:	3-DH5	Spectrum Detector:	PK
Test By:	Lee	Test Date :	August 21, 2019
Temperature :	22 °C	Humidity :	53 %
Test Result:	PASS		

Hopping Channel Frequency Range	Number of Hopping Channels	Limit
2402-2480	79	≥ 15

GFSK

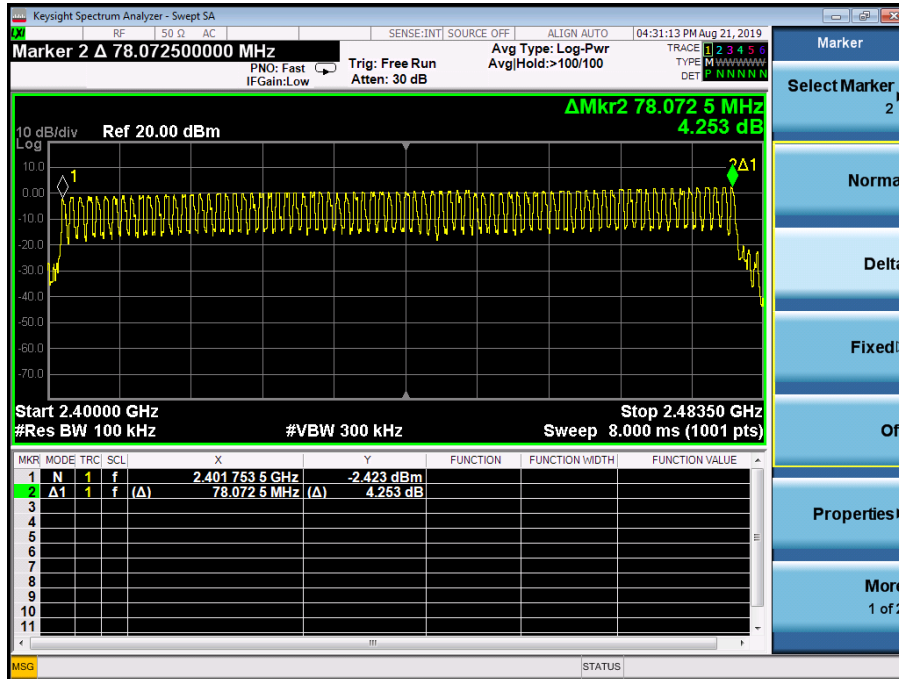

$\pi/4$ -DQPSK

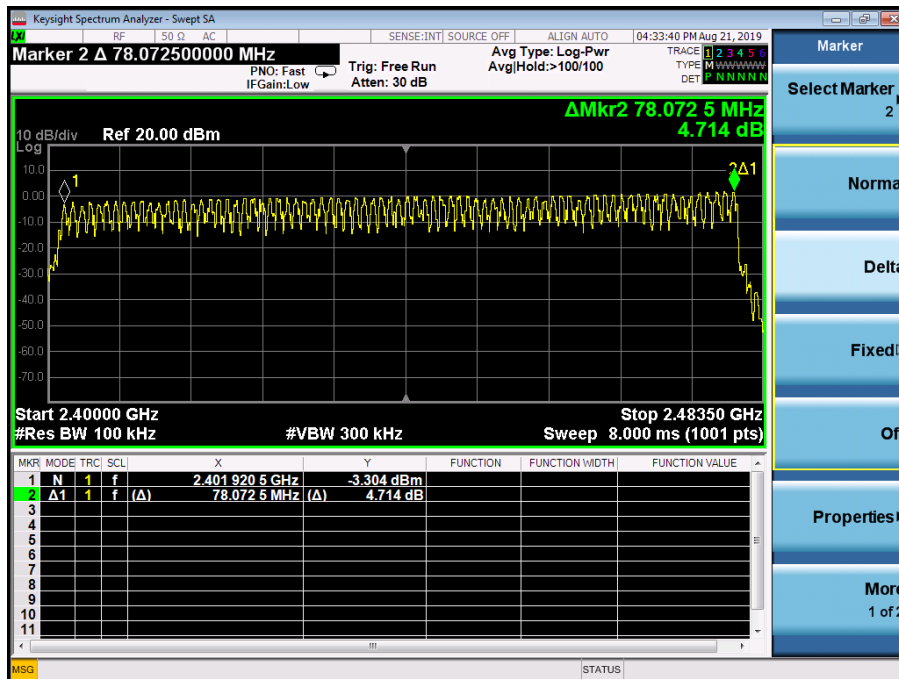

8DPSK

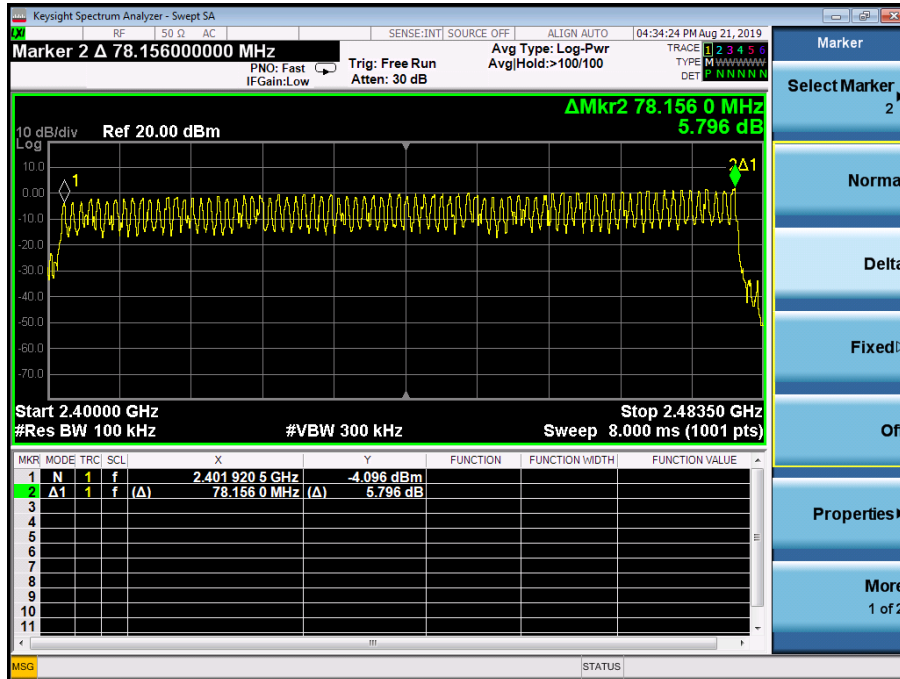

8. Time of Occupancy (Dwell Time)

8.1 Measurement Procedure

Average Channel Occupancy Time, FCC Ref:15.247(a)(1)(iii):

Connect EUT antenna terminal to the spectrum analyzer with a low loss cable. The spectrum analyzer center frequency was set to one of the known hopping channels. The Sweep was set to 10 ms, the SPAN was set to Zero SPAN. The time duration of the transmissions so captured was measured with the Marker Delta function

8.2 Measurement Results

The maximum number of hopping channels in 31.6s (0.4s/Channel x 79 Channel)

Refer to attached data chart.

Modulation :	GFSK, $\pi/4$ -DQPSK, 8DPSK		
RBW :	1MHz	VBW :	1MHz
Spectrum Detector:	PK	Test By:	Lee
Test Date :	August 21, 2019	Temperature :	22°C
Test Result:	PASS	Humidity :	53 %

Packet	Frequency (MHz)	Result (msec)	Limit (msec)
GFSK			
DH1	2441	0.3992 (ms)*(1600/(2*79))*31.6= 127.744	400
DH3	2441	1.6600 (ms)*(1600/(4*79))*31.6= 265.600	400
DH5	2441	2.9030 (ms)*(1600/(6*79))*31.6= 309.653	400
$\pi/4$-DQPSK			
2-DH1	2441	0.3960 (ms)*(1600/(2*79))*31.6= 126.720	400
2-DH3	2441	1.6670 (ms)*(1600/(4*79))*31.6= 266.720	400
2-DH5	2441	2.9180 (ms)*(1600/(6*79))*31.6= 311.253	400
8DPSK			
3-DH1	2441	0.3955 (ms)*(1600/(2*79))*31.6= 126.560	400
3-DH3	2441	1.6660 (ms)*(1600/(4*79))*31.6= 266.560	400
3-DH5	2441	2.9180 (ms)*(1600/(6*79))*31.6= 311.253	400

GFSK DH1

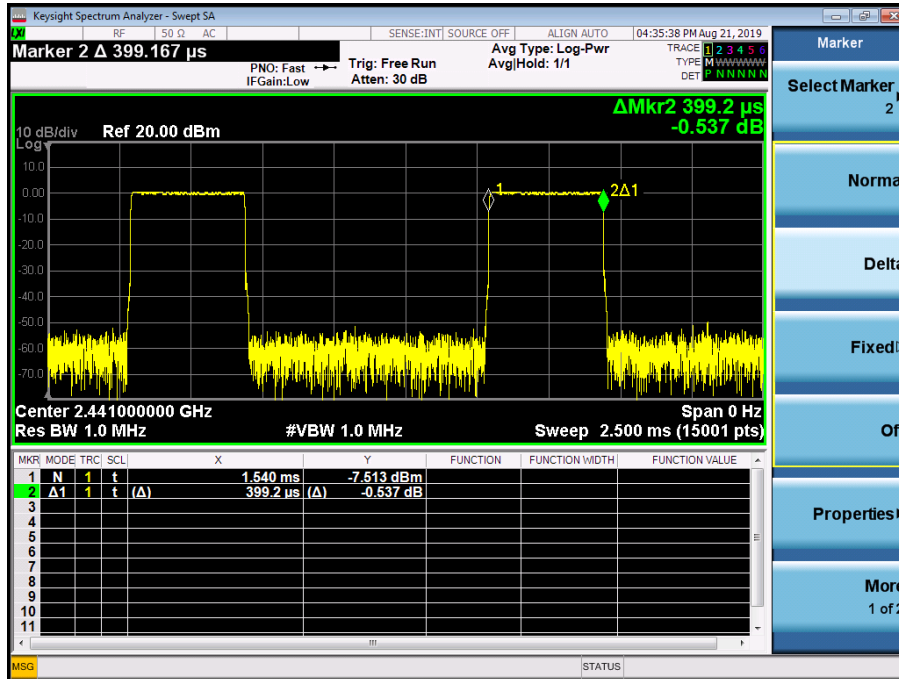

GFSK DH3

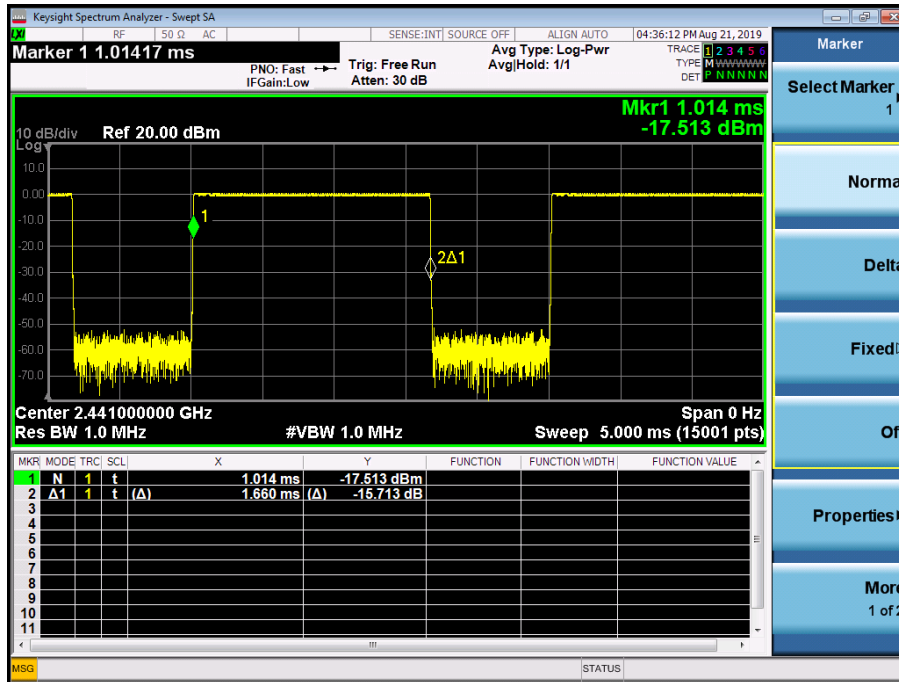

GFSK DH5

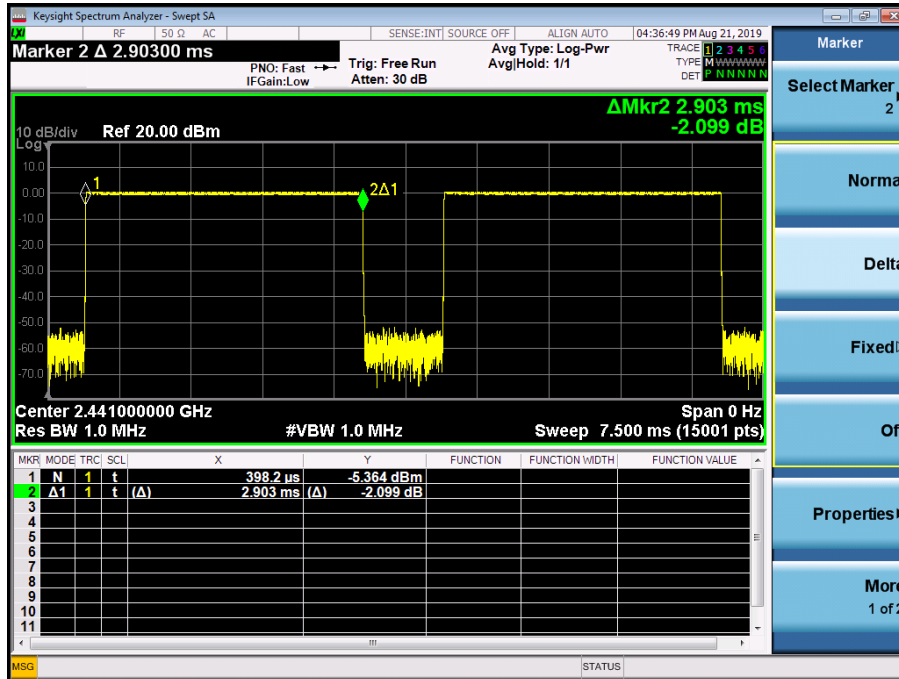

$\pi/4$ -DQPSK 2-DH1

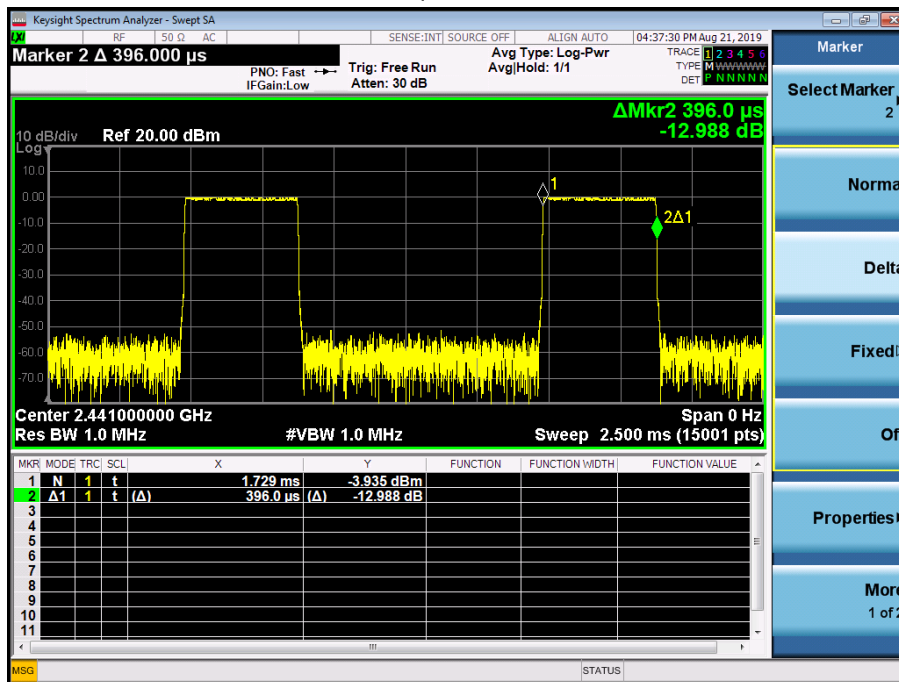

$\pi/4$ -DQPSK 2-DH3

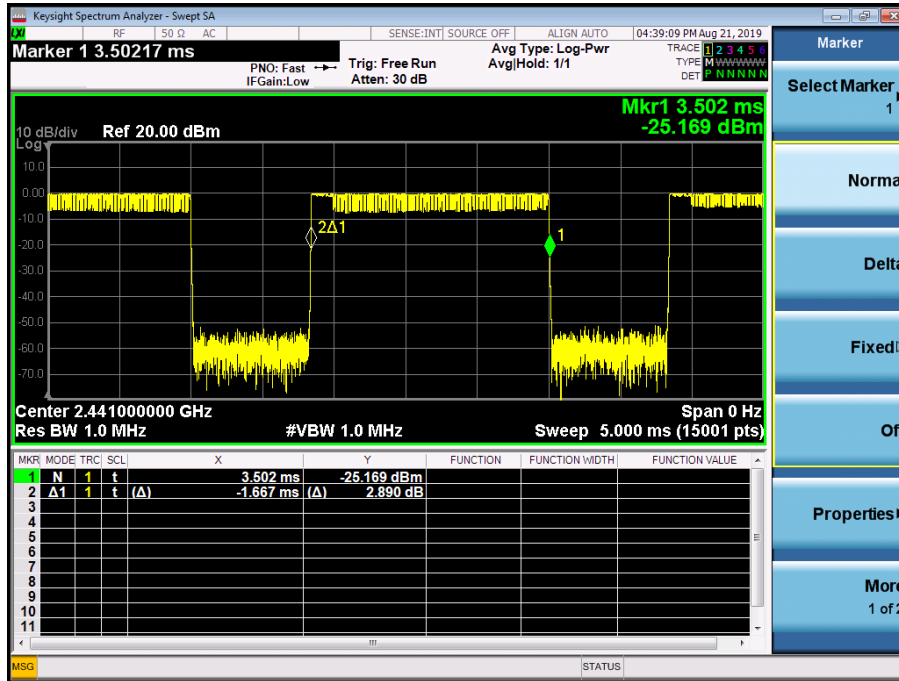

$\pi/4$ -DQPSK 2-DH5

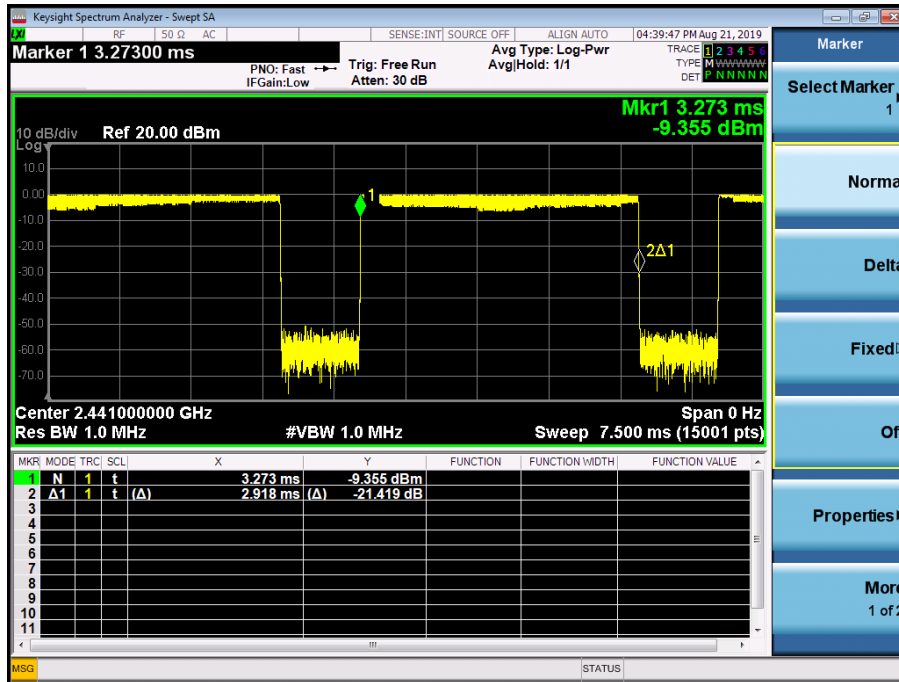

8DPSK 3-DH1

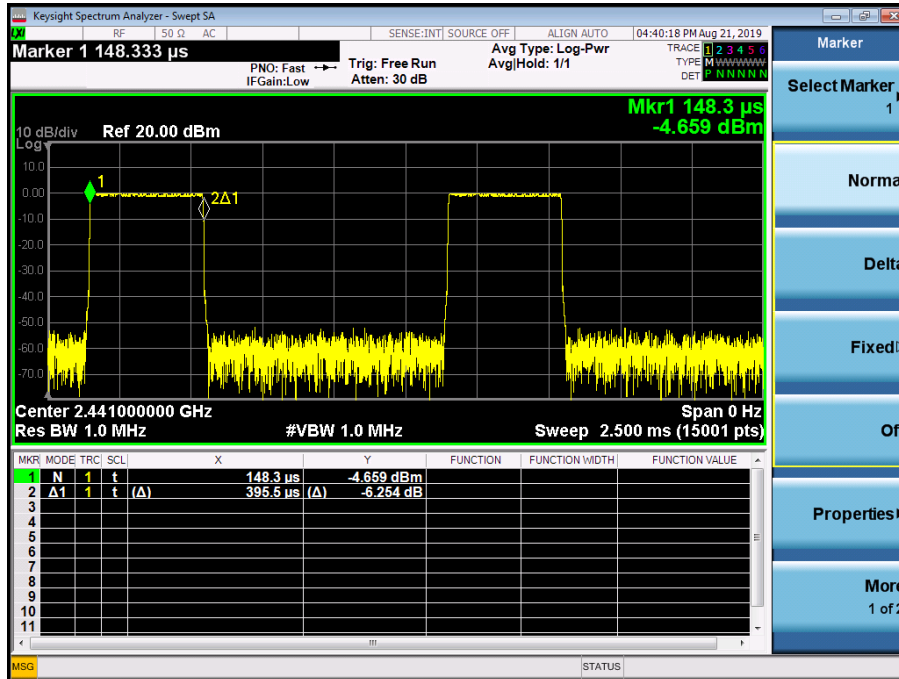

8DPSK 3-DH3

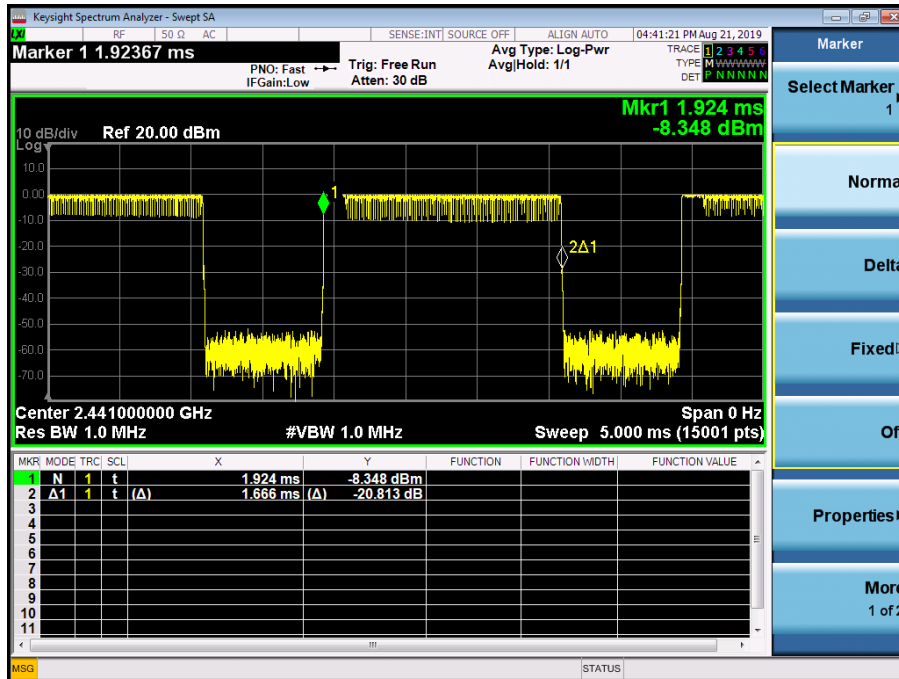

8DPSK 3-DH5

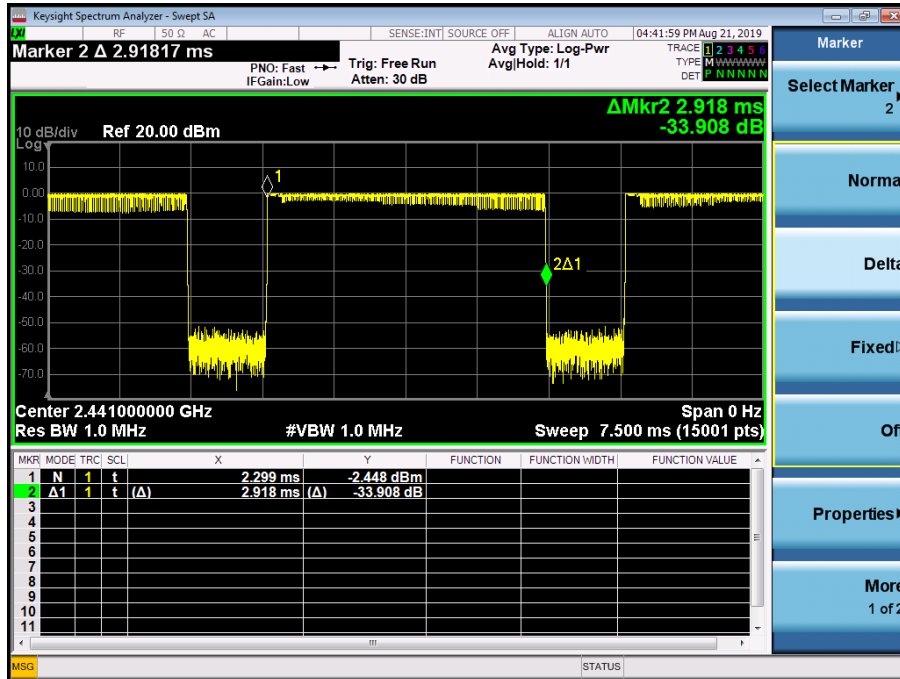

9. MAXIMUM PEAK OUTPUT POWER

9.1 Measurement Procedure

Maximum Conducted Output Power at Antenna Terminals, FCC Rules 15.247(b)(1):

Remove the antenna from the EUT and then connect a low RF cable from the antenna port to the spectrum. The analyzer was set for RBW > 20dB bandwidth and power was read directly in dBm. Cable loss was considered during this measurement.

9.2 Measurement Results

Refer to attached data chart.

Modulation :	GFSK, $\pi/4$ -DQPSK, 8DPSK		
RBW :	3MHz	VBW :	3MHz
Spectrum Detector:	PK	Test Date :	August 21, 2019
Test By:	Lee	Temperature :	22 °C
Test Result:	PASS	Humidity :	53 %

Channel Frequency (MHz)	Cable Loss dB	Peak Power output(dBm)	Peak Power output(mW)	Peak Power Limit(dBm)	Pass/Fail
GFSK					
2402.00	1.5	-2.323	0.586	21	PASS
2441.00	1.5	1.351	1.365	21	PASS
2480.00	1.5	3.087	2.036	21	PASS
$\pi/4$-DQPSK					
2402.00	1.5	-2.180	0.605	21	PASS
2441.00	1.5	0.901	1.231	21	PASS
2480.00	1.5	2.643	1.838	21	PASS
8DPSK					
2402.00	1.5	-2.108	0.615	21	PASS
2441.00	1.5	0.749	1.188	21	PASS
2480.00	1.5	2.607	1.823	21	PASS

GFSK Lowest Channel

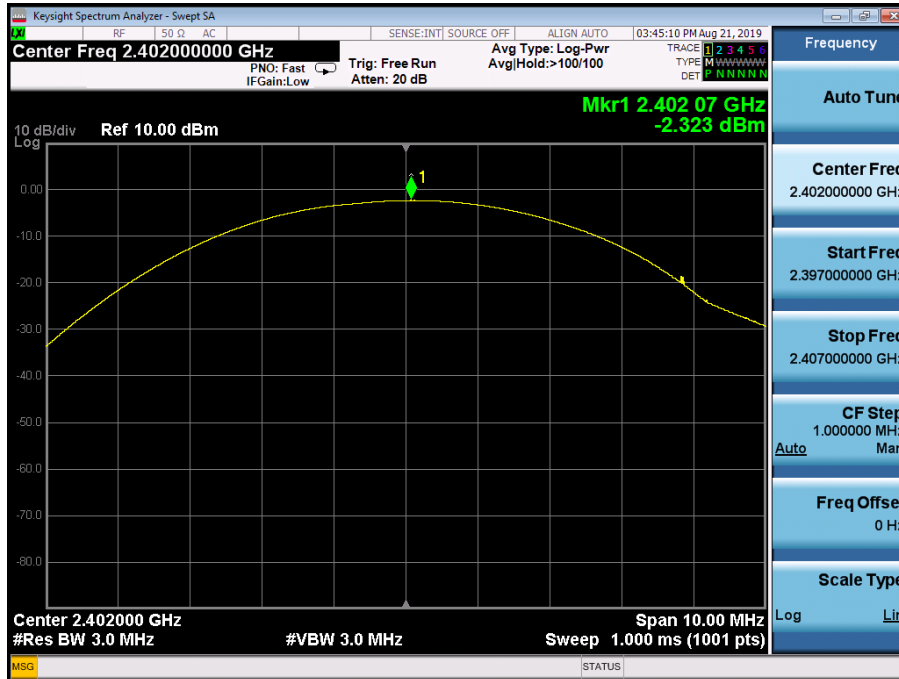

GFSK Middle Channel

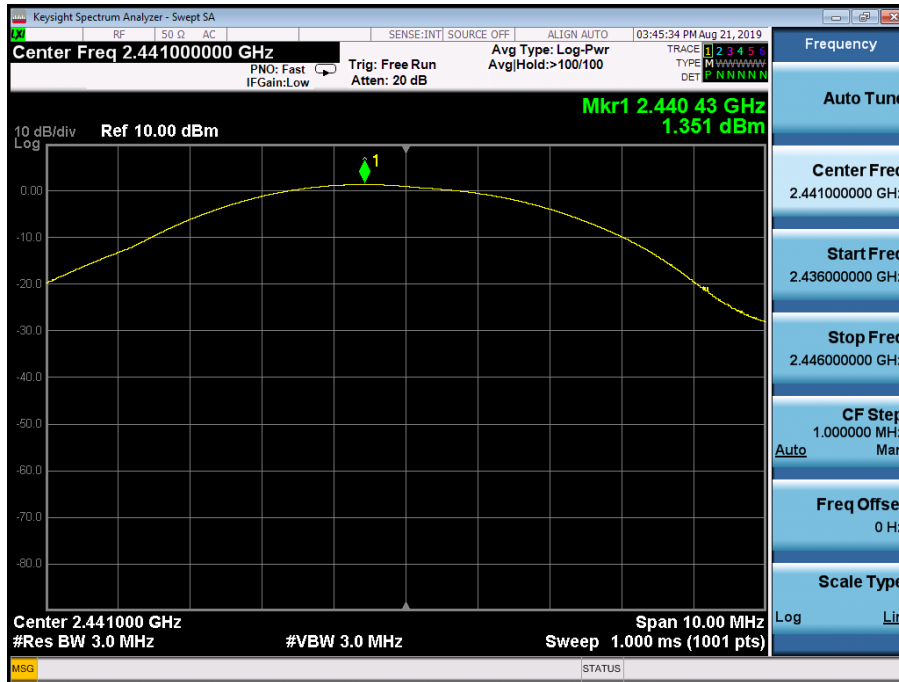

GFSK Highest Channel

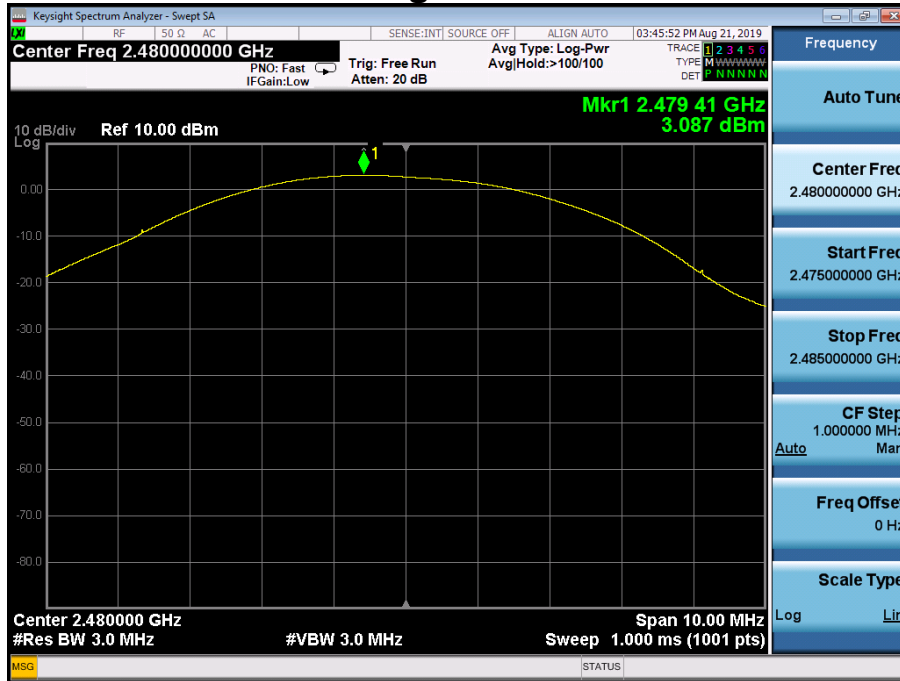

$\pi/4$ -DQPSK Lowest Channel

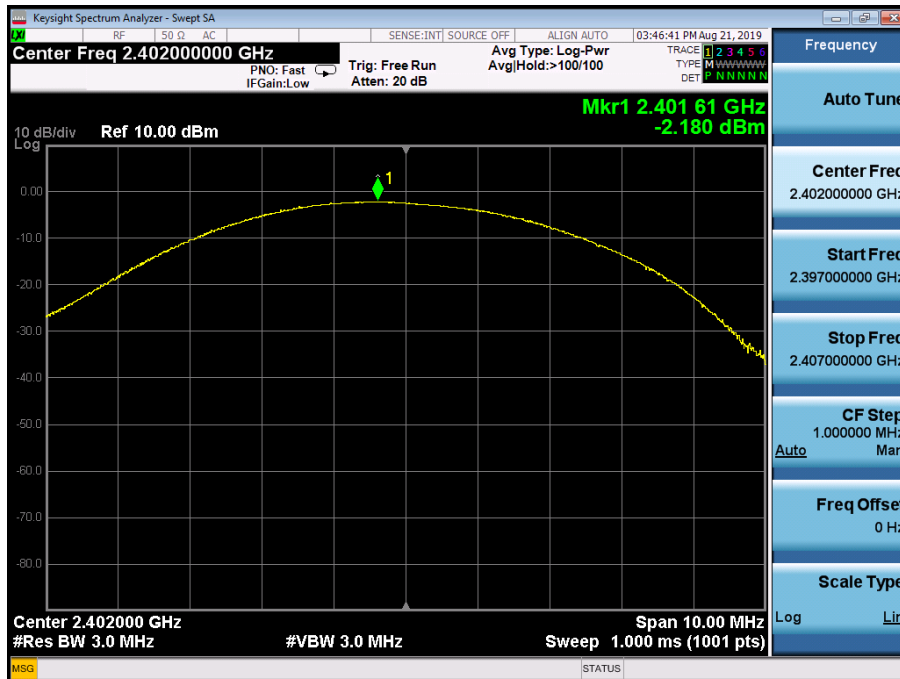

$\pi/4$ -DQPSK Middle Channel

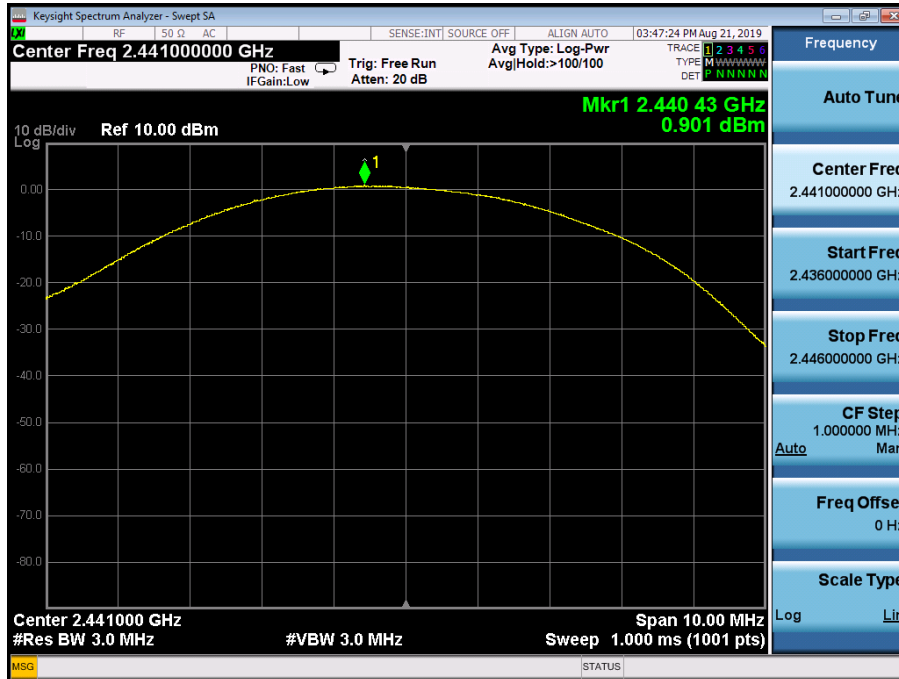

$\pi/4$ -DQPSK Highest Channel

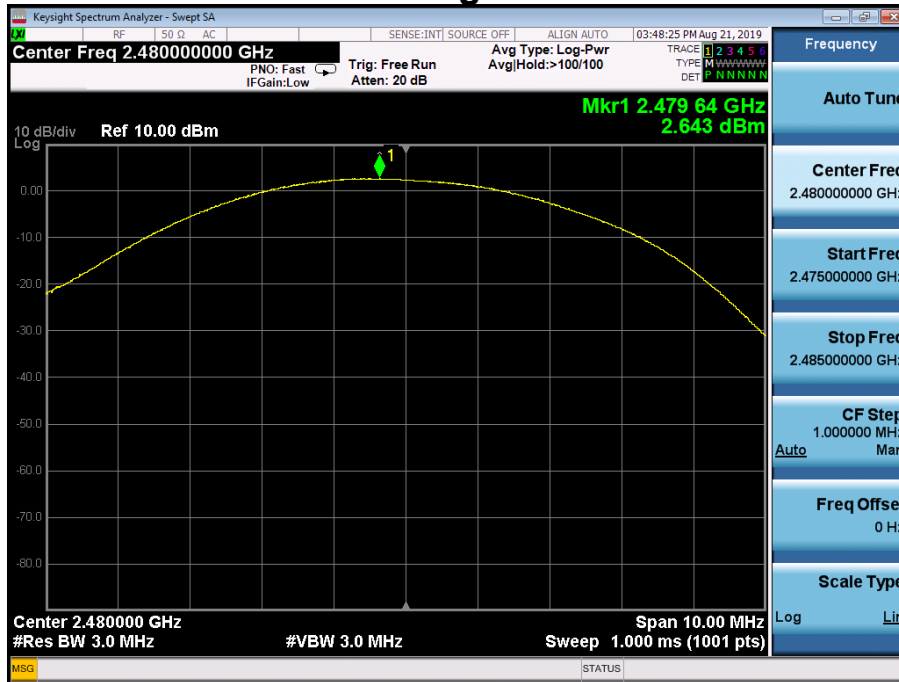

8DPSK Lowest Channel

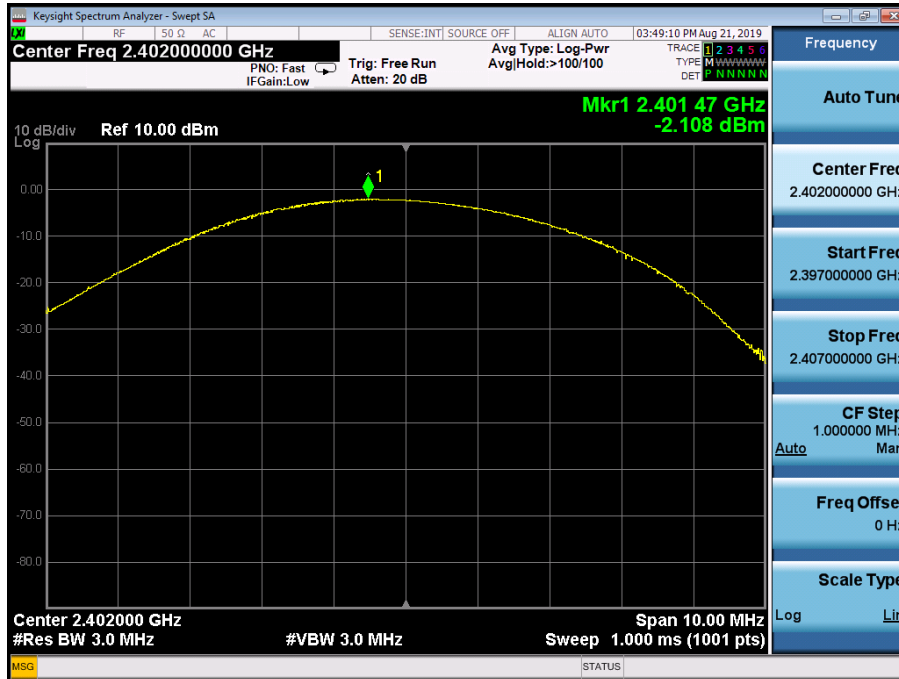

8DPSK Middle Channel

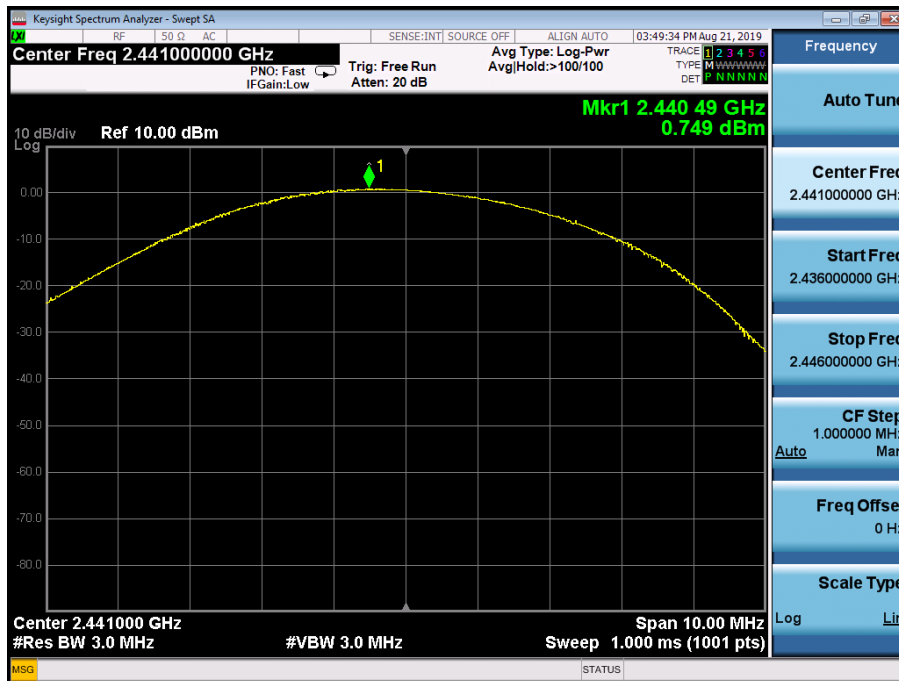

8DPSK Highest Channel

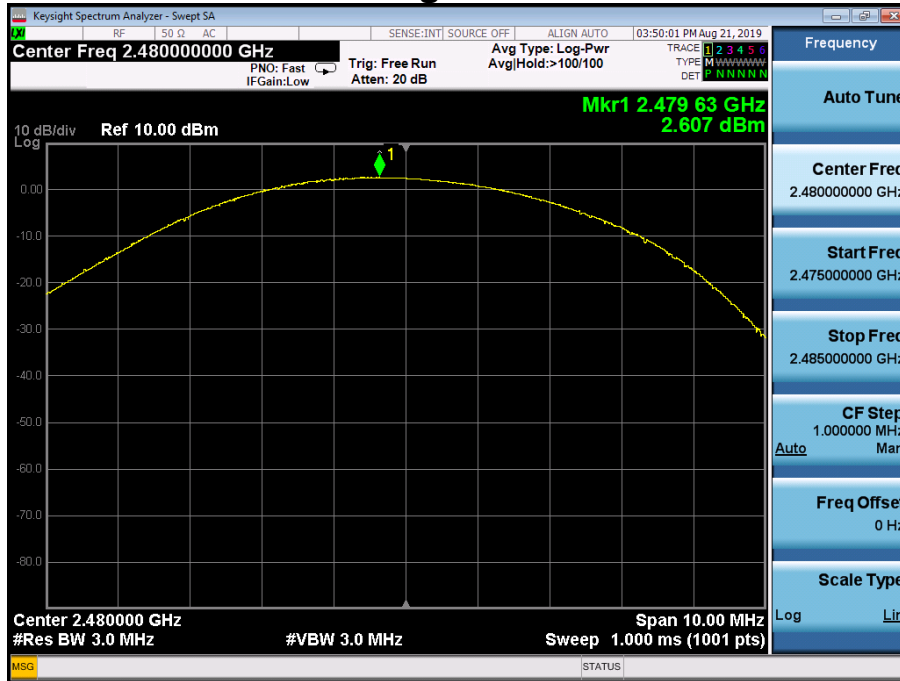

10. Band Edge

10.1 Measurement Procedure

Out of Band Conducted Emissions, FCC Rule 15.247(d):

The transmitter output is connected to spectrum analyzer. The resolution bandwidth is set to 100KHz, and the video bandwidth set to 300KHz.

10.2 Limit

15.247(d) In any 100KHz bandwidth outside the frequency band in which the spread spectrum or digitally modulated intentional radiator is operating, the radio frequency power that is produced by the intentional radiator shall be at least 20dB below that in the 100KHz bandwidth within the band that contains the highest level of the desired power, based on either an RF conducted or a radiated measurement.

10.3 Measurement Results

Please see below test table and plots.

For Radiated Emission

The worst case: GFSK

Hopping-on mode

Freq. (MHz)	Ant. Pol. (H/V)	Reading Level(dBuV)		Factor (dB/m)	Emission Level (dBuV)		Limit 3m (dBuV/m)		Margin (dB)	
		PK	AV		PK	AV	PK	AV	PK	AV
2398.000	H	52.63	42.03	0.13	52.76	42.16	74.00	54.00	-21.24	-11.84
2398.000	V	50.41	38.01	0.13	50.54	38.14	74.00	54.00	-23.46	-15.86
2483.560	H	59.41	40.48	0.35	59.76	40.83	74.00	54.00	-14.24	-13.17
2483.560	V	54.60	37.68	0.35	54.95	38.03	74.00	54.00	-19.05	-15.97

- Note:**
- (1) Emission Level= Reading Level + Factor
 - (2) Factor= Antenna Gain + Cable Loss – Amplifier Gain
 - (3) Horn antenna used for the emission over 1000MHz.

For RF Conducted

GFSK Lowest Channel

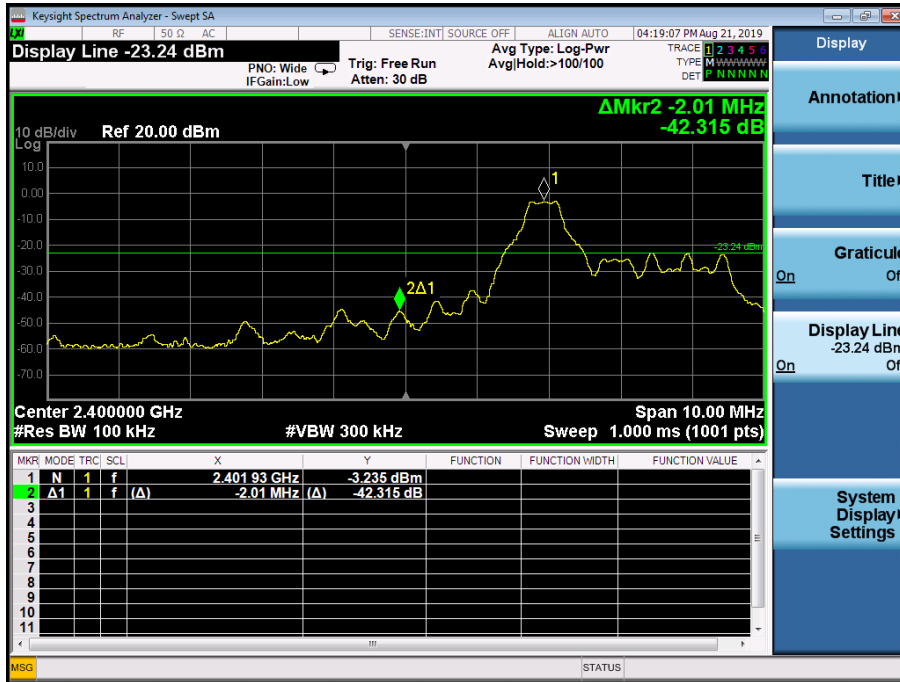

GFSK Highest Channel



$\pi/4$ -DQPSK Lowest Channel



$\pi/4$ -DQPSK Highest Channel



8DPSK Lowest Channel



8DPSK Highest Channel



11. Antenna Application

11.1 Antenna requirement

According to of FCC part 15C section 15.203 and 15.240:

An intentional radiator shall be designed to ensure that no antenna other than that furnished by the responsible party shall be used with the device. The use of a permanently attached antenna or of an antenna that uses a unique coupling to the intentional radiator, the manufacturer may design the unit so that a broken antenna can be replaced by the user, but the use of a standard antenna jack or electrical connector is prohibited.

Systems operating in the 2400-2483.5MHz band that are used exclusively for fixed, point-to-point operations may employ transmitting antennas with directional gain greater than 6dBi provided the maximum peak output power of the intentional radiator is reduced by 1dB for every 3dB that the directional gain of the antenna exceeds 6dBi.

11.2 Measurement Results

The antenna is PCB antenna that no antenna other than furnished by the responsible party shall be used with the device, and the best case gain of the antenna is 0dBi, Therefore, the antenna is consider meet the requirement.

12. Conducted Spurious Emissions

12.1 Measurement Procedure

Out of Band Conducted Spurious Emissions, FCC Rule 15.247(d):

The transmitter output is connected to spectrum analyzer. All spurious emission and up to the tenth harmonic was measured and they were found to be at least 20dB below the highest level of the desired power in the passband.

12.2. Measurement Results

Please refer to following plots, the worst case (GFSK) was shown.

Lowest Channel

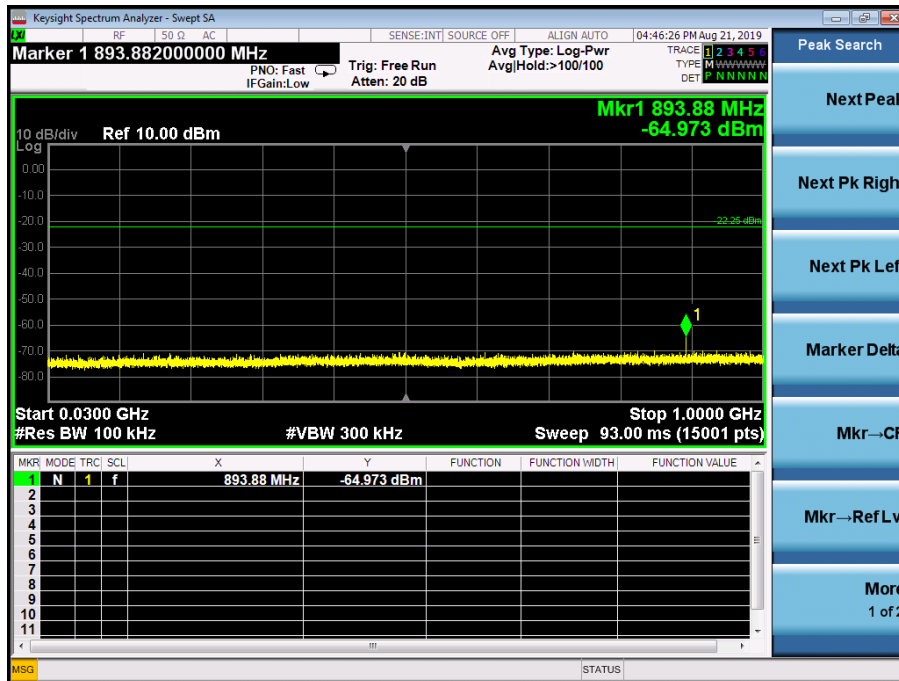
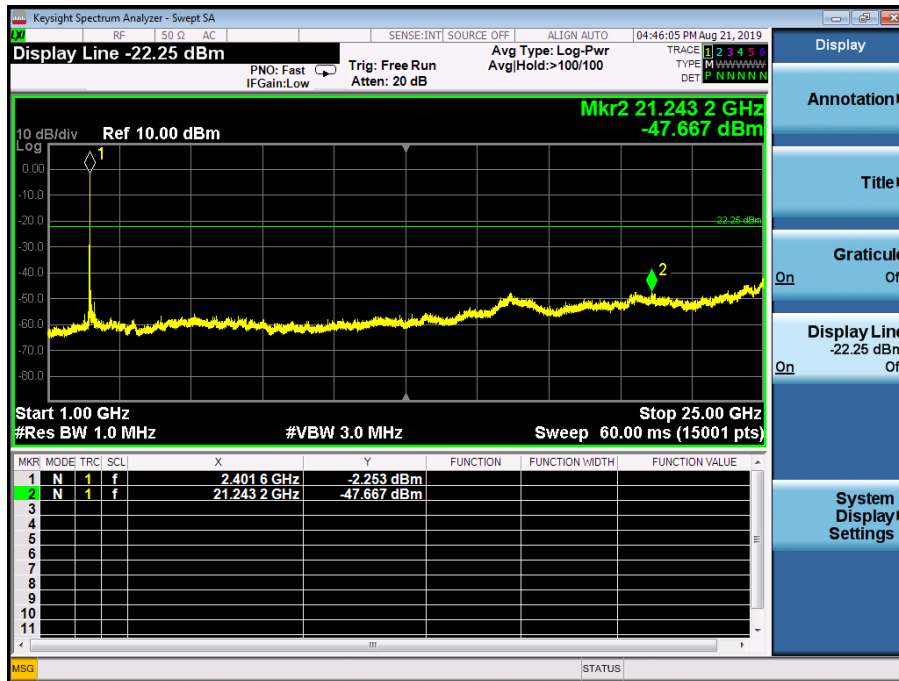

Middle Channel

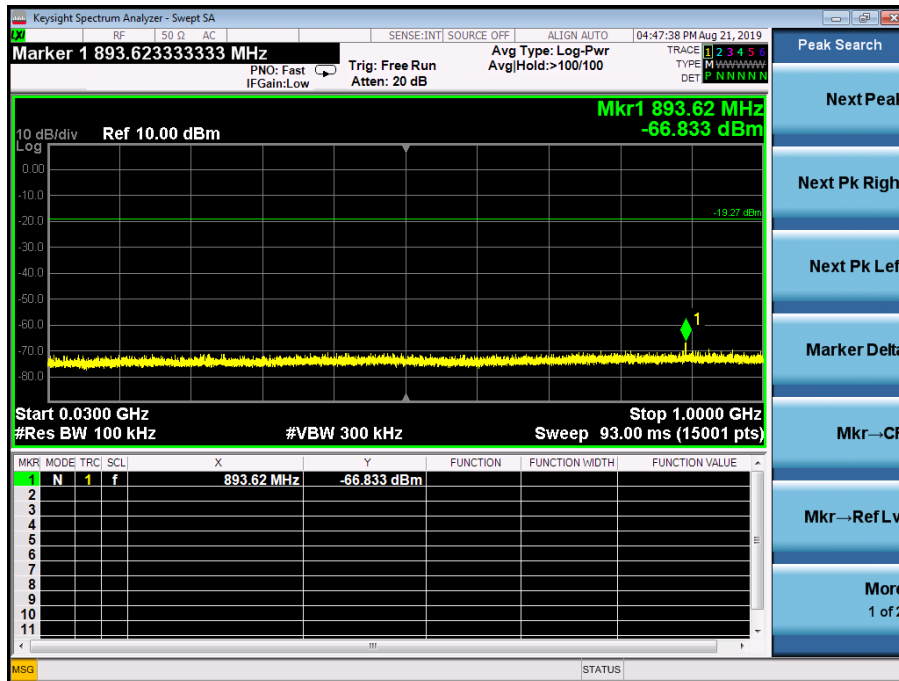

Highest Channel

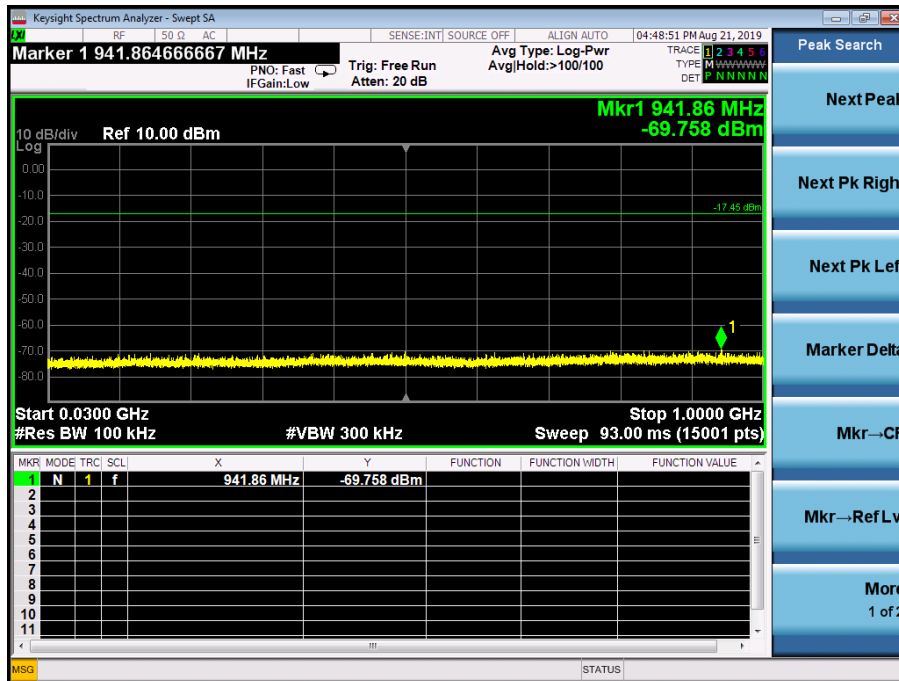
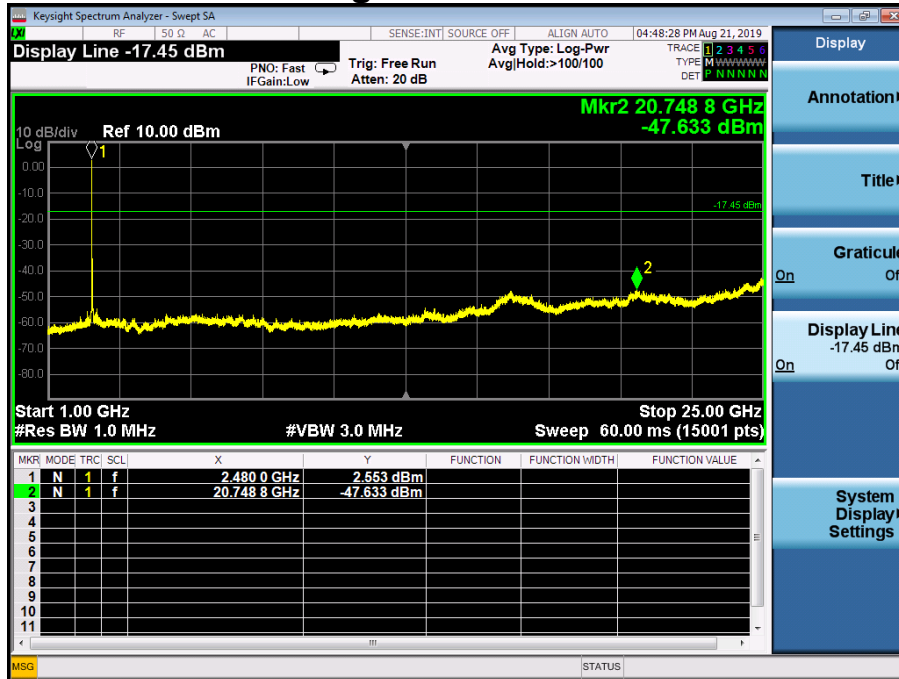

Note: Sweep points=30001 pts

13. Test Equipment List

Description	Manufacturer	Model Number	Serial Number	Characteristics	Calibration Date	Calibration Due Date
Test Receiver	Rohde & Schwarz	ESCI7	100837	9KHz~7GHz	Mar. 14, 2019	1 year
Antenna	Schwarzbeck	VULB9162	9162-010	30MHz~7GHz	Mar. 23, 2019	1 Year
Spectrum Analyzer	Rohde & Schwarz	FSU26	200409/026	20Hz~26.5GHz	Mar. 14, 2019	1 Year
Spectrum Analyzer	Keysight	N9020A	MY54200831	20Hz~26.5GHz	Apr. 24, 2019	1 year
Spectrum Analyzer	Rohde & Schwarz	FSV40	101003	10Hz~40GHz	Apr. 24, 2019	1 Year
Horn Antenna	Schwarzbeck	BBHA9170	9170-372	15GHz~40GHz	Mar. 23, 2019	1 Year
Pre-Amplifier	EMCI	EMC 184045	980102	18GHz~40GHz	Apr. 24, 2019	1 year
Power Sensor	DARE	RPR3006W	15100041SN O64	100MHz~6GHz	Mar. 14, 2019	1 year
Communication Tester	Rohde & Schwarz	CMW500	149004	70MHz~6GHz	Mar. 14, 2019	1 Year
Horn Antenna	COM-Power	AH-118	071078	500MHz~18GHz	Mar. 23, 2019	1 Year
Pre-Amplifier	HP	HP 8449B	3008A00964	1GHz~26.5GHz	Mar. 14, 2019	1 year
Pre-Amplifier	HP	HP 8447D	1145A00203	100KHz~1.3GHz	Mar. 14, 2019	1 Year
Loop Antenna	Schwarzbeck	FMZB 1513	1513-272	9KHz~30MHz	Apr. 24, 2019	1 Year
Temperature & Humidity Chamber	REMAFEE	SYHR225L	N/A	-40~150°C	Apr. 24, 2019	1 year
DC Source	MY	MY8811	N/A	0~30V	N/A	N/A
Temporary antenna connector	TESCOM	SS402	N/A	9KHz~25GHz	N/A	N/A
Power Meter	Anritsu	ML2495A	1139001	100k-65GHz	Apr. 24, 2019	1 year
Power Sensor	Anritsu	MA2411B	100345	300M-40GHz	Apr. 24, 2019	1 Year
Test Receiver	Rohde & Schwarz	ESCI	101152	9KHz-3GHz	Mar. 14, 2019	1 Year
L.I.S.N	Rohde & Schwarz	ENV 216	101317	9KHz-30MHz	Mar. 14, 2019	1 Year
RF Switching Unit	Compliance Direction Systems Inc.	RSU-M2	38311	9KHz-3GHz	Mar. 14, 2019	1 Year
Test Software	EZ	EZ_EMG	N/A	N/A	N/A	N/A

Note: The temporary antenna connector is soldered on the PCB board in order to perform conducted tests and this temporary antenna connector is listed in the equipment list.

---End---