



Spectrum Research & Testing Lab., Inc.
No. 101-10, Ling 8,
Shan-Tong Li, Chung-Li
City, Taoyuan, Taiwan

TEST REPORT

Reference No.:A03012207
Report No.:FCCA03012207
Page:1 of 43
Date:Mar. 06, 2003

Product Name: Wireless 11b Card Bus
Model No.: MS-6802
Applicant: MICRO-STAR INT'L CO., LTD.
No. 69, Li-De St., Jung-He City, Taipei Hsien, Taiwan
Date of Receipt: Jan. 22, 2003
Finished date of Test: Mar. 06, 2003
Applicable Standards: 47 CFR Part 15, Subpart C
ANSI C63.4:1992

We, **Spectrum Research & Testing Laboratory Inc.**, hereby certify that one sample of the above was tested in our laboratory with positive results according to the above-mentioned standards. The records in the report are an accurate account of the results. Details of the results are given in the subsequent pages of this report.

Checked By : Spring Wang , Date: Mar. 06, 2003
(Spring Wang)

Approved By : Johnson Ho , Date: 3/6/2003
(Johnson Ho, Director)



Table of Contents

1.	DOCUMENT POLICY AND TEST STATEMENT	4
1.1	DOCUMENT POLICY	4
1.2	TEST STATEMENT	4
2.	DESCRIPTION OF EUT AND TEST MODE	4
2.1	GENERAL DESCRIPTION OF EUT	4
2.2	DESCRIPTION OF SUPPORT UNIT	5
2.3	DESCRIPTION OF TEST MODE	5
3.	DESCRIPTION OF APPLIED STANDARDS.....	6
4.	TECHNICAL CHARACTERISTICS TEST.....	7
4.1	CONDUCTED EMISSION TEST	7
4.1.1	LIMIT	7
4.1.2	TEST EQUIPMENT	7
4.1.3	TEST SETUP	8
4.1.4	TEST PROCEDURE	8
4.1.5	EUT OPERATING CONDITION	8
4.1.6	TEST RESULT	9
4.2	RADIATED EMISSION TEST	10
4.2.1	LIMIT	10
4.2.2	TEST EQUIPMENT	11
4.2.3	TEST SET-UP	12
4.2.4	TEST PROCEDURE	13
4.2.5	EUT OPERATING CONDITION	13
4.2.6	TEST RESULT	14
4.3	6DBC BANDWIDTH TEST	18
4.3.1	LIMIT	18
4.3.2	TEST EQUIPMENT	18
4.3.3	TEST SET-UP	18
4.3.5	EUT OPERATING CONDITION	18
4.3.6	TEST RESULT	19
4.4	PEAK POWER TEST	22
4.4.1	LIMIT	22
4.4.2	TEST EQUIPMENT	22
4.4.3	TEST SET-UP	23



4.4.5 EUT OPERATING CONDITION	23
4.4.6 TEST RESULT	24
4.5 BAND EDGE TEST	27
4.5.1 LIMIT	27
4.5.2 TEST EQUIPMENT	28
4.5.3 TEST SET-UP	29
4.5.5 EUT OPERATING CONDITION	30
4.5.6 TEST RESULT	31
4.6 POWER DENSITY TEST	34
4.6.1 LIMIT	34
4.6.2 TEST EQUIPMENT	34
4.6.3 TEST SET-UP	34
4.6.5 EUT OPERATING CONDITION	34
4.6.6 TEST RESULT	35
4.7 RF POWER EXPOSURE EVALUATION TEST	38
4.7.1 LIMIT	38
4.7.2 TEST EQUIPMENT	39
4.7.3 TEST SET-UP	39
4.7.5 EUT OPERATING CONDITION	40
4.7.6 RESULT	41
5. ANTENNA APPLICATION	42
5.1 ANTENNA REQUIREMENT	42
5.2 RESULT	42
6. TERMS OF ABRIVATION	43



1. DOCUMENT POLICY AND TEST STATEMENT

1.1 DOCUMENT POLICY

- The report shall not be reproduced except in full, without the written approval of SRT Lab, Inc.

1.2 TEST STATEMENT

- The test results in the report apply only to the unit tested by SRT Lab.
- There was no deviation from the requirements of test standards during the test.
- AC power source, 120 VAC/60 Hz, was used during the test.

2. DESCRIPTION OF EUT AND TEST MODE

2.1 GENERAL DESCRIPTION OF EUT

PRODUCT	Wireless 11b Card Bus
MODEL NO.	MS-6802
POWER SUPPLY	DC 3.3V, 0.4A
CABLE	N/A
I/O PORT	N/A
FREQUENCY BAND	2400 ~ 2483.5MHz
CARRIER FREQUENCY	CH1: 2412MHz ~ CH11: 2462MHz
NUMBER OF CHANNEL	11
CHANNEL SPACING	5MHz
RATED RF OUTPUT POWER	13.5dBm
I.F. & L.O.	I.F.: 0MHz, L.O.: 2412~2484MHz
MODULATION TYPE	BPSK/QPSK/CCK
BIT RATE OF TRANSMISSION	1/2/5.5/11Mbps
ANTENNA TYPE	Chip Antenna

NOTE : The EUT consists of a wireless AP and a signal booster. For more detailed features, please refer to the manufacturer's specification or User's Manual of EUT.



2.2 DESCRIPTION OF SUPPORT UNIT

The transmitter part of EUT was tested with a PC system and configured by the requirement of ANSI C63.4. All interface ports were connected to the appropriate support units via specific cables. The support units and cables are listed below.

NO	DEVICE	BRAND	MODEL #	FCC ID/DOC	CABLE
1	NOTEBOOK	DELL	PP01L	DOC	1.8m unshielded power cord
2	PRINTER	EPSON	STYLUS C20SX	DOC	1.5m unshielded power cord 1.2m shielded data cable
3	MODEM	ACEEX	DM-1414	DOC	1.5m unshielded DC power cable 1.2m shielded data cable
4	ROUTER	RUNTOP	WSB24-1	PKW-WSB24-1	N/A

NOTE: For the actual test configuration, please refer to the photos of testing.

2.3 DESCRIPTION OF TEST MODE

11 channels are provided by EUT. The 3 channels of lower, medium and higher were chosen for test. There are three test mode for each test configuration as below:

Test Mode	Frequency (MHz)
CH 1	2412
CH 6	2437
CH 11	2462

NOTE :

1. Below 1 GHz, the channel 1, 6, and 11 were pre-tested in chamber. The channel 11, worst case one, was chosen for conducted and radiated emission test.
2. Above 1 GHz, the channel 1, 6 and 11 were tested individually



**Spectrum Research &
Testing Lab., Inc.**
No. 101-10, Ling 8,
Shan-Tong Li, Chung-Li
City, Taoyuan, Taiwan

TEST REPORT

Reference No.:A03012207
Report No.:FCCA03012207
Page:6 of 43
Date:Mar. 06, 2003

3. DESCRIPTION OF APPLIED STANDARDS

The EUT is a kind of wireless product and to be connected with a PC system for normal use. According to the specifications provided by the applicant, it must comply with the requirements of the following standards:

47 CFR Part 15, Subpart C
ANSI C63.4:1992

All tests have been performed and recorded as the above standards.



4. TECHNICAL CHARACTERISTICS TEST

4.1 CONDUCTED EMISSION TEST

4.1.1 LIMIT

Frequency (MHz)	Class A (dB μ V)		Class B (dB μ V)	
	Quasi-peak	Average	Quasi-peak	Average
0.15 - 0.5	79	66	66 - 56	56 - 46
0.50 - 5.0	73	60	56	46
5.0 - 30.0	73	60	60	50

NOTE :

1. The lower limit shall apply at the transition frequencies.
2. The limit decreases in line with the logarithm of the frequency in the range of 0.15 to 0.50 MHz.

4.1.2 TEST EQUIPMENT

The following test equipment was used for the test :

EQUIPMENT/ FACILITIES	SPECIFICATIONS	MANUFACTURER	MODEL#/ SERIAL#	DUE DATE OF CAL. & CAL. CENTER
EMI TEST RECEIVER	9 kHz TO 30 MHz	ROHDE & SCHWARZ	ESHS30/ 826003/008	JUL. 2003 R&S
LISN	50 μ H, 50 ohm	SOLAR ELECTRONICS	8012-50-R-24-BNC / 924839	JUN. 2003 ETC
LISN	50 μ H, 50 ohm	SOLAR ELECTRONICS	9252-50-R-24-BNC / 951318	JUN. 2003 ETC

NOTE: The calibration interval of the above test equipment is one year and the calibrations are traceable to NML/ROC and NIST/USA.



4.1.3 TEST SETUP

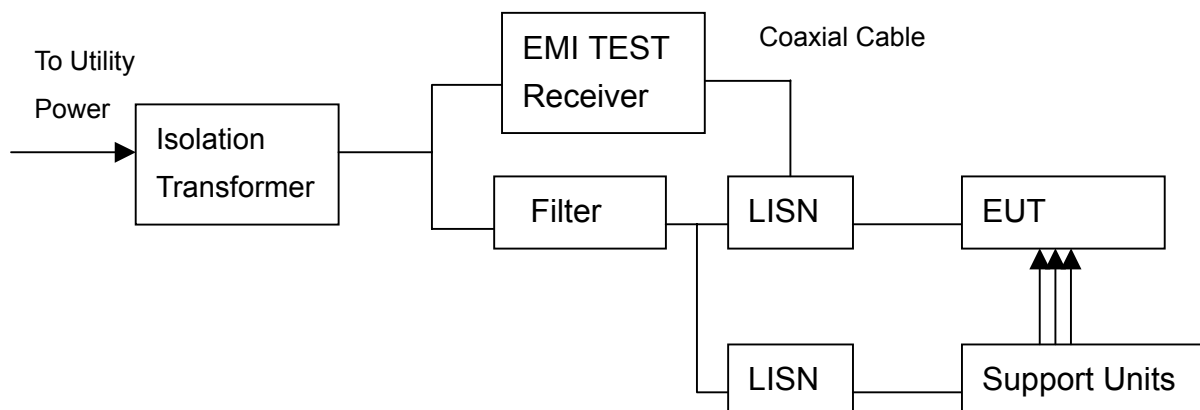

NOTE:

1. The EUT was put on a wooden table with 0.8m height above ground plane, and 0.4m away from reference ground plane (> 2mx2m).
2. For the actual test configuration, please refer to the photos of testing.

4.1.4 TEST PROCEDURE

The EUT was tested according to the requirement of ANSI C63.4 and CISPR 22. The frequency spectrum from 0.15 MHz to 30 MHz was investigated. The LISN used was 50 ohm/50 μ H as specified. All readings were quasi-peak and average values with 10 kHz resolution bandwidth of the test receiver. The EUT system was operated in all typical methods by users. Both lines of the power mains of EUT were measured and the cables connected to EUT and support units were moved to find the maximum emission levels for each frequency.

4.1.5 EUT OPERATING CONDITION

1. Set the EUT under normal condition continuously at the link mode.
2. The EUT used programs to control channels when it was tested for RF power and emission.



4.1.6 TEST RESULT

Temperature:	17 °C	Humidity:	54 %RH
Ferquency Range:	0.15 – 30 MHz	Test Mode	N/A
Receiver Detector:	Q.P. and AV.	Tested By:	Chris Hsien

Power Line Measured : Line

Freq. (MHz)	Correct. Factor (dB)	Reading Value (dB μ V)		Emission Level (dB μ V)		Limit (dB μ V)		Margin (dB)	
		Q.P.	AV.	Q.P.	AV.	Q.P.	AV.	Q.P.	AV.
0.173	0.20	48.5	38.8	48.7	39.0	64.8	54.8	-16.1	-15.8
0.345	0.20	33.5	26.2	33.7	26.4	59.1	49.1	-25.4	-22.7
3.747	0.27	31.2	20.2	31.5	20.5	56.0	46.0	-24.5	-25.5
4.318	0.30	23.5	15.0	23.8	15.3	56.0	46.0	-32.2	-30.7
13.634	0.47	12.6	4.9	13.1	5.4	60.0	50.0	-46.9	-44.6
22.880	0.66	24.2	15.3	24.9	16.0	60.0	50.0	-35.1	-34.0

Power Line Measured : Neutral

Freq. (MHz)	Correct. Factor (dB)	Reading Value (dB μ V)		Emission Level (dB μ V)		Limit (dB μ V)		Margin (dB)	
		Q.P.	AV.	Q.P.	AV.	Q.P.	AV.	Q.P.	AV.
0.173	0.20	48.6	38.5	48.8	38.7	64.8	54.8	-16.0	-16.1
0.345	0.20	35.2	27.1	35.4	27.3	59.1	49.1	-23.7	-21.8
0.576	0.20	21.3	15.0	21.5	15.2	56.0	46.0	-34.5	-30.8
2.076	0.20	16.6	12.2	16.8	12.4	56.0	46.0	-39.2	-33.6
3.748	0.27	28.8	18.2	29.1	18.5	56.0	46.0	-26.9	-27.5
25.881	0.72	23.9	17.2	24.6	17.9	60.0	50.0	-35.4	-32.1

NOTE :

1. Measurement uncertainty is 2dB
2. Emission level = Reading value + Correction factor
3. Correction Factor = Cable loss + Insertion loss of LISN
4. Margin value = Emission level - Limit
5. The emission of other frequencies were very low against the limit.
6. "-": The Quasi-peak reading value also meets average limit and measurement with the average detector is unnecessary.



4.2 RADIATED EMISSION TEST

4.2.1 LIMIT

FCC Part15, Subpart C Section 15.209 limit of radiated emission for frequency below1000MHz. The emissions from an intentional radiator shall not exceed the field strength levels specified in the following table:

FREQUENCY (MHz)	DISTANCE (m)	FIELD STRENGTH (dB μ V/m)
30 - 88	3	40.0
88 - 216	3	43.5
216 - 960	3	46.0
Above 960	3	54.0

NOTE :

1. In the emission tables above , the tighter limit applies at the band edges.
2. Distance refers to the distance between measuring instrument, antenna, and the closest point of any part of the device or system.

FCC Part 15, Section15.35(b) limit of radiated emission for frequency above 1000 MHz

FREQUENCY (MHz)	Class A (dBuV/m) (at 3m)		Class B (dBuV/m) (at 3m)	
	PEAK	AVERAGE	PEAK	AVERAGE
Above 1000	80.0	60.0	74.0	54.0



4.2.2 TEST EQUIPMENT

The following test equipment was used during the radiated emission test :

EQUIPMENT/ FACILITIES	SPECIFICATIONS	MANUFACTURER	MODEL#/ SERIAL#	DUE DATE OF CAL. & CAL. CENTER
EMI TEST RECEIVER	9 kHz TO 2750 MHz	ROHDE & SCHWARZ	ESCS30/ 836858/008	DEC. 2003 R&S
BI-LOG ANTENNA	25 MHz TO 2 GHz	EMCO	3142/ 9701-1124	APR. 2003 ETC
PRE-AMPLIFIER	1GHz-26.5GHz Gain:30dB(typ.)	HP	8449B/ 3008A01019	NOV. 2003 ETC
SPECTRUM	9KHz TO 26.5GHz	HP	8953E/ 3710A03220	MAY 2003 ETC
HORN ANTENNA	1GHz TO 18GHz	EMCO	3115/ 9602-4681	DEC. 2003 ETC
HORN ANTENNA	15GHz TO 40GHz	EMCO	3116/ 2567	JUL. 2003 ETC
OATS	3 – 10 M MEASUREMENT	SRT	SRT-1	MAY 2003 SRT

1. The calibration interval of the above test equipment is one year and the calibrations are traceable to NML/ROC and NIST/USA.
2. The Open Area Test Site (SRT-1) is registered by FCC with No. 90957 and VCCI with No. R-1081.
3. The Open Area Test Site (SRT-2) is registered by FCC with No. 98458 and VCCI with No. R-1168.



4.2.3 TEST SET-UP

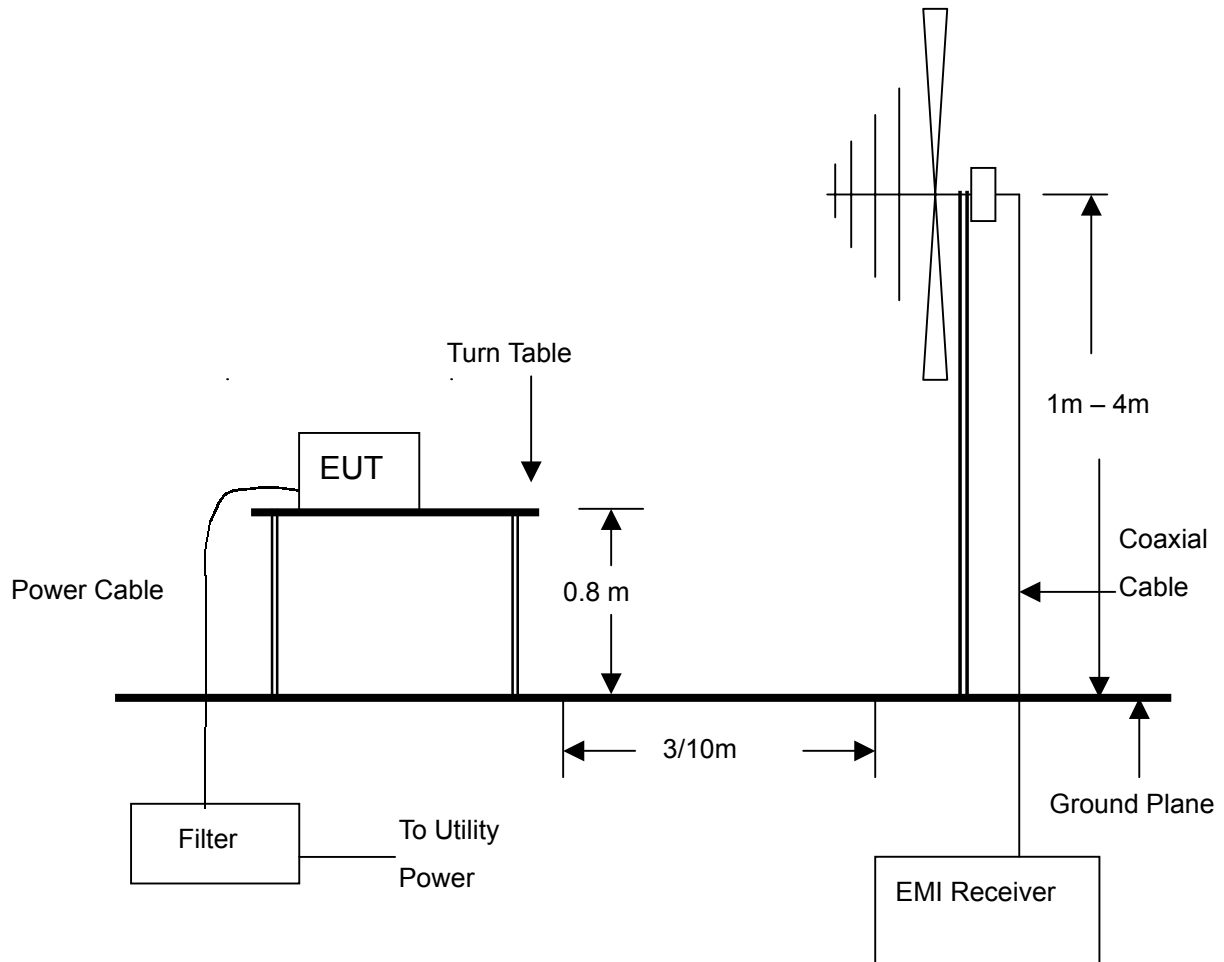

NOTE :

1. The EUT system was put on a wooden table with 0.8m heights above a ground plane.
2. For the actual test configuration, please refer to the photos of testing.



4.2.4 TEST PROCEDURE

The EUT was tested according to the requirement of ANSI C63.4 and CISPR 22. The measurements were made at an open area test site with 10 meter measurement distance under 1 GHz and with 3m distance above 1GHz. The frequency spectrum measured started from 30 MHz. Under 1 GHz. All readings were quasi-peak values with 120 kHz resolution bandwidth of the test receiver. Above 1 GHz, the measurements were made at an open area test site with 3 meter measurement distance and all readings were peak and average values with 1 MHz resolution bandwidth of the test receiver. The EUT system was operated in all typical methods by users. The cables connected to EUT and support units were moved to find the maximum emission levels for each frequency.

4.2.5 EUT OPERATING CONDITION

Same as section 4.1.5 of this report.



4.2.6 TEST RESULT

Temperature:	20 °C	Humidity:	55 %RH
Ferquency Range:	30 – 1000 MHz	Measured Distance:	3m
Receiver Detector:	Q.P.	Tested mode:	N/A
Tested by:	Chris Hsien		

Antenna Polarization:Horizontal

Frequency (MHz)	Cable Loss (dB)	Antenna Factor (dB)	Reading Data (dBµV)	Emission Level (dBµV/m)	Limit (dBµV/m)	Margin (dB)	AZ(°)	EL(m)
267.0860	1.93	13.25	11.2	26.4	46.0	-19.6	246.0	1.0
276.4800	1.91	13.56	9.8	25.3	46.0	-20.7	105.0	1.0
300.5036	2.06	14.90	12.3	29.3	46.0	-16.7	186.0	1.0
330.1964	2.22	15.05	10.1	27.4	46.0	-18.6	224.0	2.7
397.2620	2.61	16.26	11.9	30.8	46.0	-15.2	221.0	3.0
663.2480	2.58	20.98	10.5	34.1	46.0	-11.9	175.0	3.0

Antenna Polarization:Vertical

Frequency (MHz)	Cable Loss (dB)	Antenna Factor (dB)	Reading Data (dBµV)	Emission Level (dBµV/m)	Limit (dBµV/m)	Margin (dB)	AZ(°)	EL(m)
230.4020	1.86	11.80	9.8	23.5	46.0	-22.5	113.0	2.0
663.2520	2.58	20.98	9.0	32.6	46.0	-13.4	134.0	2.5

NOTE :

1. Measurement uncertainty is 4dB.
2. "": Measurement does not apply for this frequency.
3. Emission Level = Reading Value + Ant. Factor + Cable Loss.
4. The field strength of other emission frequencies were very low against the limit.



Temperature: 20 °C Humidity: 55 %RH
 Ferquency Range: 1 – 25 GHz Measured Distance: 3m
 Receiver Detector: PK. or AV. Tested mode: CH 1
 Tested by: Chris Hsien

Antenna Polarization : Horizontal

Frequency (MHz)	Correct Factor (dB)	Ant. Factor (dB/m)	Reading Data (dBµV)		Emission Level (dBµV/m)		Limit (dBµV/m)		Margin (dB)		AZ (°)	EL (m)
			PK.	AV.	PK.	AV.	PK.	AV.	PK.	AV.		
2410.5500(F)	-32.18	28.02	101.2	94.5	97.0	90.3	N/A	N/A	N/A	N/A	356.0	1.8
2400.0000	-32.16	28.00	63.1	51.5	58.9	47.3	74.0	54.0	-15.1	-6.7	56.0	1.5
4812.0000	-30.45	33.65	44.6	*	47.8	*	74.0	54.0	-26.2	N/A	270.0	1.2
7234.7500	-28.98	36.29	45.4	*	52.7	*	74.0	54.0	-21.3	N/A	160.0	1.0

Antenna Polarization : Vertical

Frequency (MHz)	Correct Factor (dB)	Ant. Factor (dB/m)	Reading Data (dBµV)		Emission Level (dBµV/m)		Limit (dBµV/m)		Margin (dB)		AZ (°)	EL (m)
			PK.	AV.	PK.	AV.	PK.	AV.	PK.	AV.		
2413.1300(F)	-32.18	28.03	103.0	95.4	98.8	91.2	N/A	N/A	N/A	N/A	37.0	1.6
2400.0000	-32.16	28.00	64.5	54.0	60.3	49.8	74.0	54.0	-13.7	-4.2	33.0	1.9
2258.7500	-32.51	27.72	49.9	*	45.1	*	74.0	54.0	-28.9	N/A	N/A	N/A
4821.0000	-30.42	36.66	42.8	*	46.0	*	74.0	54.0	-28.0	N/A	N/A	N/A
7255.5000	-29.03	36.30	45.2	*	52.5	*	74.0	54.0	-21.5	N/A	N/A	N/A

NOTE :

1. Measurement uncertainty is 4dB.
2. "****": The Peak reading value also meets average limit and measurement with the average detector is unnecessary.
3. Emission Level = Reading Value + Ant. Factor + Correct Factor (incl.:Cable Loss and Pre-Amplifier Gain)
4. The field strength of other emission frequencies were very low against the limit.
5. (F):The field strength of fundamental frequency.



Temperature: 20 °C Humidity: 55 %RH
 Ferquency Range: 1 – 25 GHz Measured Distance: 3m
 Receiver Detector: PK. or AV. Tested mode: CH 6
 Tested by: Chris Hsien

Antenna Polarization : Horizontal

Frequency (MHz)	Correct Factor (dB)	Ant. Factor (dB/m)	Reading Data (dBµV)		Emission Level (dBµV/m)		Limit (dBµV/m)		Margin (dB)		AZ (°)	EL (m)
			PK.	AV.	PK.	AV.	PK.	AV.	PK.	AV.		
2434.0000(F)	-32.21	28.07	101.3	95.0	97.2	90.9	N/A	N/A	N/A	N/A	250.0	1.3
4874.0000	-30.28	33.70	50.5	*	53.9	*	74.0	54.0	-20.1	N/A	344.0	1.0
7293.2000	-29.08	36.33	44.7	*	52.0	*	74.0	54.0	-22.0	N/A	287.0	1.0

Antenna Polarization : Vertical

Frequency (MHz)	Correct Factor (dB)	Ant. Factor (dB/m)	Reading Data (dBµV)		Emission Level (dBµV/m)		Limit (dBµV/m)		Margin (dB)		AZ (°)	EL (m)
			PK.	AV.	PK.	AV.	PK.	AV.	PK.	AV.		
2434.4000(F)	-32.21	28.07	98.2	90.5	94.0	86.4	N/A	N/A	N/A	N/A	278.0	1.5
4948.0000	-30.25	33.76	44.6	*	48.1	*	74.0	54.0	-25.9	N/A	305.0	1.0
7296.0000	-29.08	36.34	43.2	*	50.5	*	74.0	54.0	-23.5	N/A	285.0	1.1

NOTE :

1. Measurement uncertainty is 4dB.
2. "****": The Peak reading value also meets average limit and measurement with the average detector is unnecessary.
3. Emission Level = Reading Value + Ant. Factor + Correct Factor (incl.:Cable Loss and Pre-Amplifier Gain)
4. The field strength of other emission frequencies were very low against the limit.
5. (F):The field strength of fundamental frequency.



Temperature: 20 °C Humidity: 55 %RH
 Ferquency Range: 1 – 25 GHz Measured Distance: 3m
 Receiver Detector: PK. or AV. Tested mode: CH 11
 Tested by: Chris Hsien

Antenna Polarization : Horizontal

Frequency (MHz)	Correct Factor (dB)	Ant. Factor (dB/m)	Reading Data (dBμV)		Emission Level (dBμV/m)		Limit (dBμV/m)		Margin (dB)		AZ (°)	EL (m)
			PK.	AV.	PK.	AV.	PK.	AV.	PK.	AV.		
2465.0000(F)	-32.22	28.13	99.5	93.6	95.3	89.5	N/A	N/A	N/A	N/A	70.0	1.9
2483.5000	-32.19	28.17	46.5	*	42.5	*	74.0	54.0	-31.5	N/A	70.0	1.9
4960.0000	-30.26	33.77	45.1	*	48.6	*	74.0	54.0	-25.4	N/A	125.0	1.4
7422.1000	-28.94	36.44	43.5	*	21.0	*	74.0	54.0	-23.0	N/A	320.0	1.1

Antenna Polarization : Vertical

Frequency (MHz)	Correct Factor (dB)	Ant. Factor (dB/m)	Reading Data (dBμV)		Emission Level (dBμV/m)		Limit (dBμV/m)		Margin (dB)		AZ (°)	EL (m)
			PK.	AV.	PK.	AV.	PK.	AV.	PK.	AV.		
2465.0000(F)	-32.22	28.13	101.9	94.7	97.8	90.6	N/A	N/A	N/A	N/A	56.0	1.5
2483.5000	-32.19	28.17	46.5	*	42.5	*	74.0	54.0	-31.5	N/A	56.0	1.5
4923.5000	-30.23	33.74	45.9	*	49.4	*	74.0	54.0	-24.6	N/A	103.0	1.3
7424.2000	-28.94	36.44	42.2	*	49.7	*	74.0	54.0	-24.3	N/A	60.0	1.1

NOTE :

1. Measurement uncertainty is 4dB.
2. "****": The Peak reading value also meets average limit and measurement with the average detector is unnecessary.
3. Emission Level = Reading Value + Ant. Factor + Correct Factor (incl.:Cable Loss and Pre-Amplifier Gain)
4. The field strength of other emission frequencies were very low against the limit.
5. (F): The field strength of fundamental frequency.



4.3 6dBc BANDWIDTH TEST

4.3.1 LIMIT

FCC Part15, Subpart C Section 15.247(2). The minimum 6 dB bandwidth shall be at least 500 kHz.

4.3.2 TEST EQUIPMENT

The following test equipment was used during the test:

EQUIPMENT/ FACILITIES	SPECIFICATIONS	MANUFACTURER	MODEL#/ SERIAL#	DUE DATE OF CAL. & CAL. CENTER
SPECTRUM	9kHz-7GHz	ROHDE & SCHWARZ	FSP7/ 839511/010	MAR. 2003 R & S

NOTE: The calibration interval of the above test equipment is one year and the calibrations are traceable to NML/ROC and NIST/USA.

4.3.3 TEST SET-UP

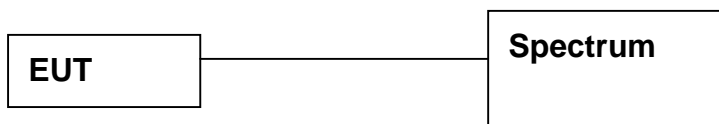

The EUT was connected to a spectrum through a 50Ω RF cable.

4.3.4 TEST PROCEDURE

The EUT was operating in the transmitter mode and could control its channels. The test result was printed by the hard copy function of the spectrum.

4.3.5 EUT OPERATING CONDITION

Same as section 4.1.5 of this report.



4.3.6 TEST RESULT

Temperature: 23°C Humidity: 60%RH
 Spectrum Detector: PK. Tested by: Chris Hsien
 Test Result: Pass

CHANNEL NUMBER	CHANNEL FREQUENCY (MHz)	6dB DOWN BW (MHz)	MINIMUM LIMIT (MHz)
1	2412	11.12	0.5
6	2437	11.16	0.5
11	2462	11.20	0.5

CH1:

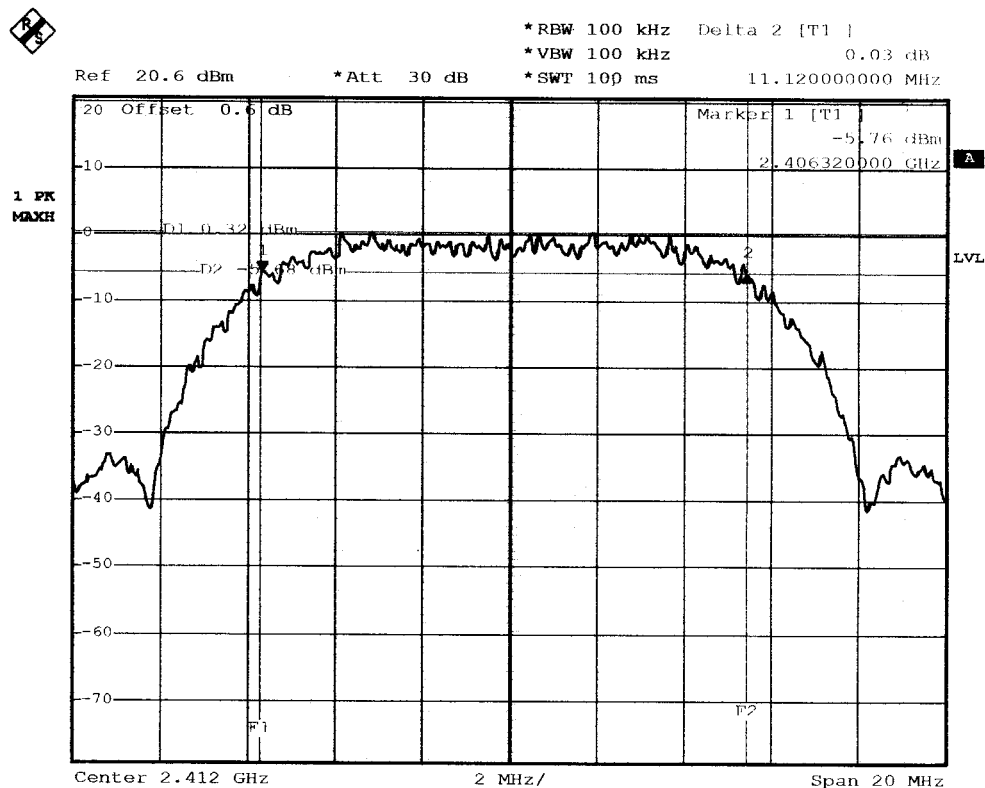



CH 6:

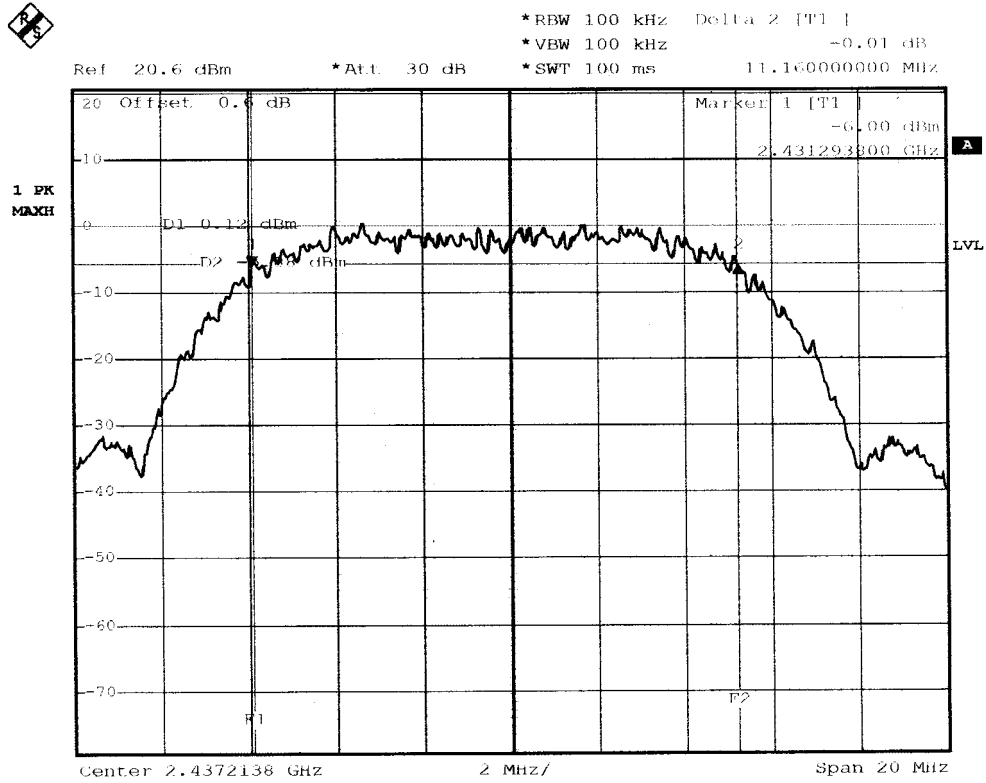



CH 11:

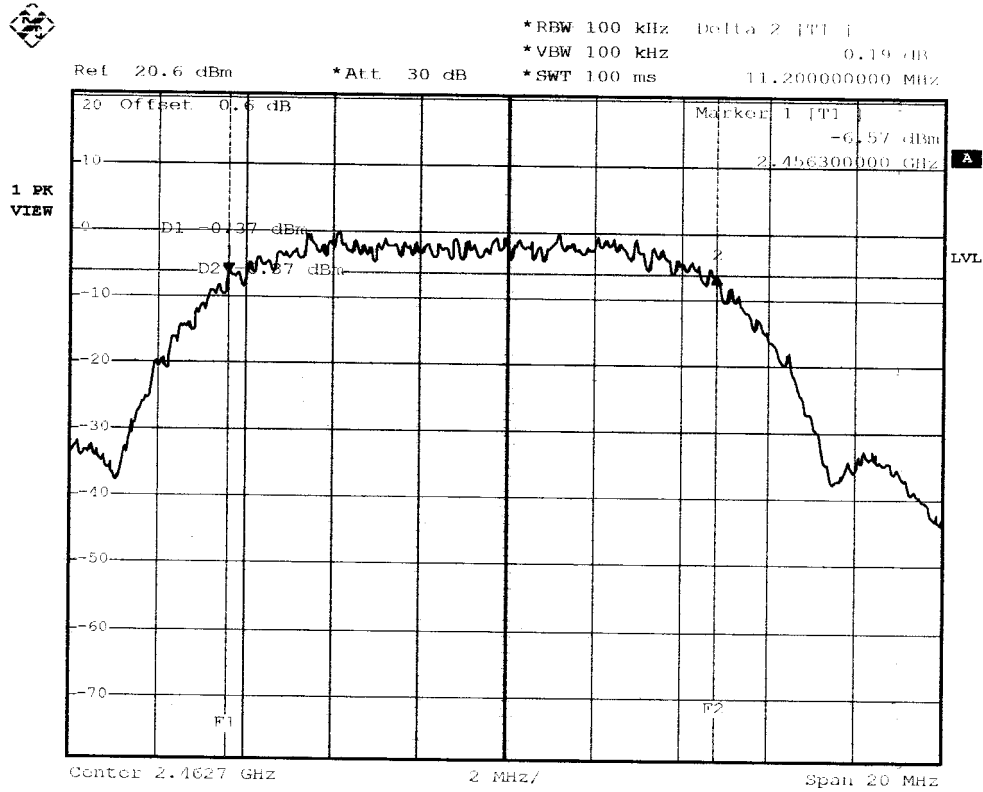



4.4 PEAK POWER TEST

4.4.1 LIMIT

FCC Part15, Subpart C Section 15.247

FREQUENCY RANGE (MHz)	LIMIT (W)
902 - 928	1(30dBm)
2400 - 2483.5	1(30dBm)
5725 - 5850	1(30dBm)

4.4.2 TEST EQUIPMENT

The following test equipment was used during the test:

EQUIPMENT/FACILITIES	SPECIFICATIONS	MANUFACTURER	MODEL#/SERIAL#	DUE DATE OF CAL. & CAL. CENTER
SPECTRUM	9kHz-7GHz	ROHDE & SCHWARZ	FSP7/ 839511/010	MAR. 2003 R & S
POWER METER	N/A	BOONTON	4232A/ 29001	MAY. 2003 ETC
POWER SENSOR	DC-8GHz 50	BOONTON	51011EMC/ 31181	MAY. 2003 ETC

NOTE: The calibration interval of the above test equipment is one year and the calibrations are traceable to NML/ROC and NIST/USA.



4.4.3 TEST SET-UP

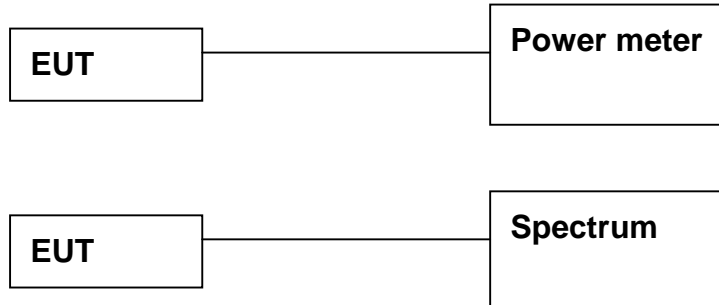

The EUT was connected to a spectrum through a 50Ω RF cable.

4.4.4 TEST PROCEDURE

The EUT was operating in transmitter mode and could be controlled its channel.
Printed out the test result from the spectrum by hard copy function.
Recorded the read value of the power meter.

4.4.5 EUT OPERATING CONDITION

Same as section 4.1.5 of this report.



4.4.6 TEST RESULT

Temperature:	<u>23°C</u>	Humidity:	<u>65%RH</u>
Spectrum Detector:	<u>PK.</u>	Tested by:	<u>Chris Hsien</u>
Test Result:	<u>Pass</u>		

CHANNEL NUMBER	CHANNEL FREQUENCY (MHz)	PEAK POWER OUTPUT (dBm)	PEAK POWER LIMIT (dBm)
1	2414.70	11.77	30
6	2439.81	11.37	30
11	2464.80	10.85	30

CH 1:

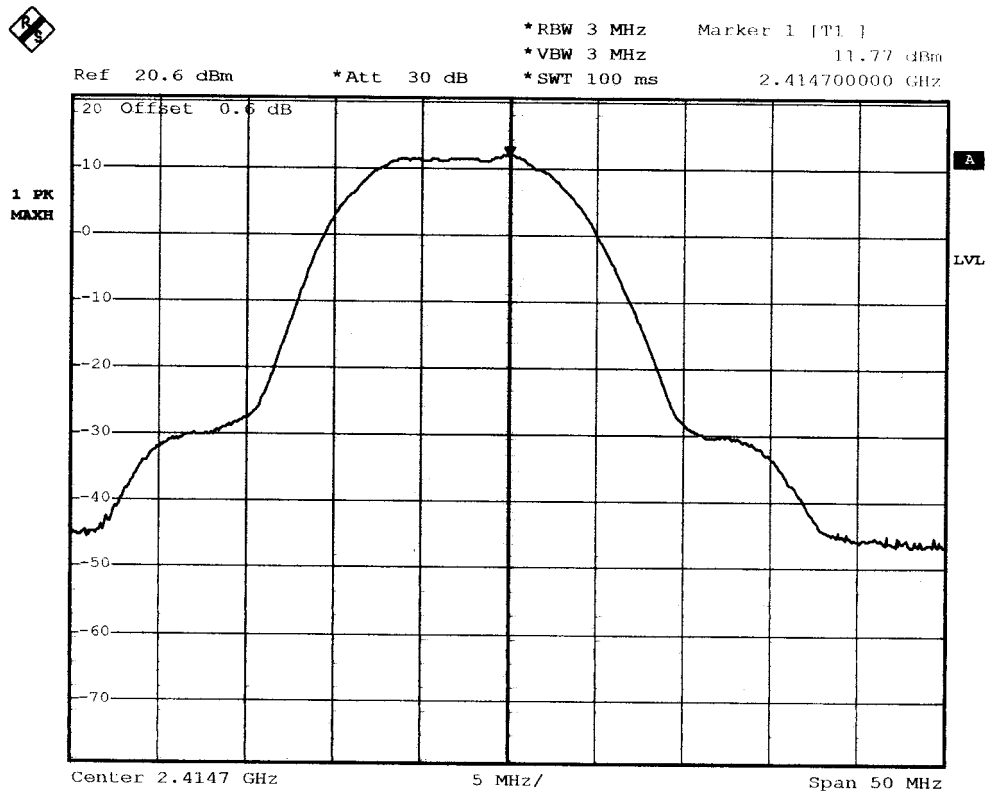



CH 6:

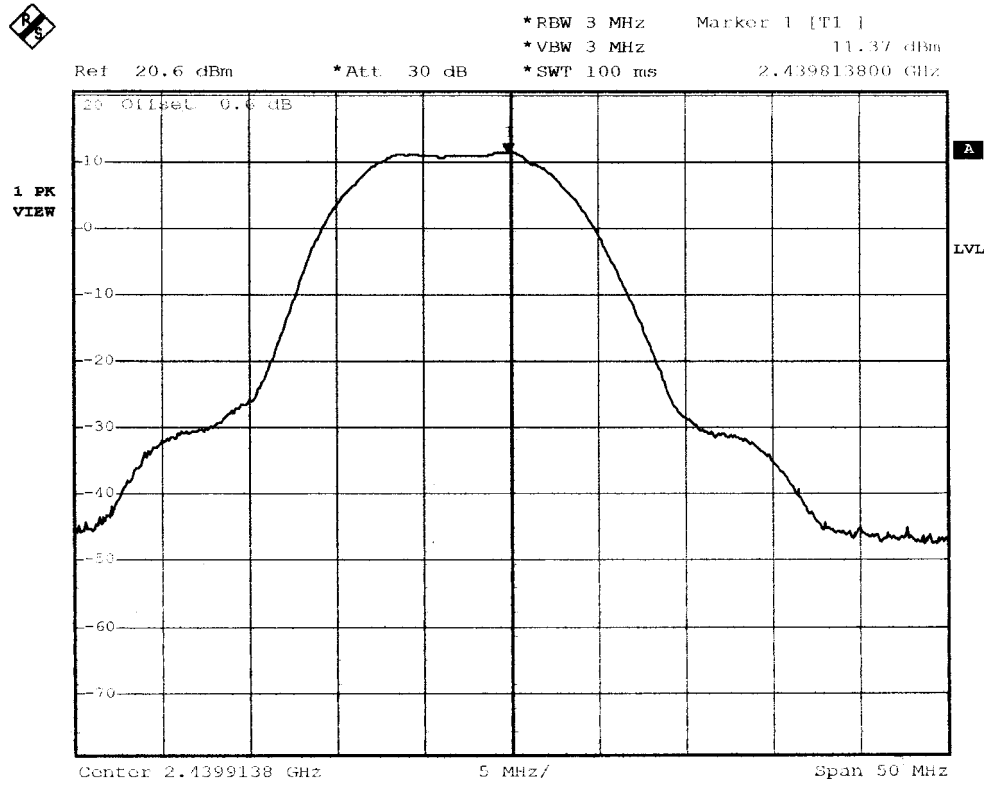



CH 11:

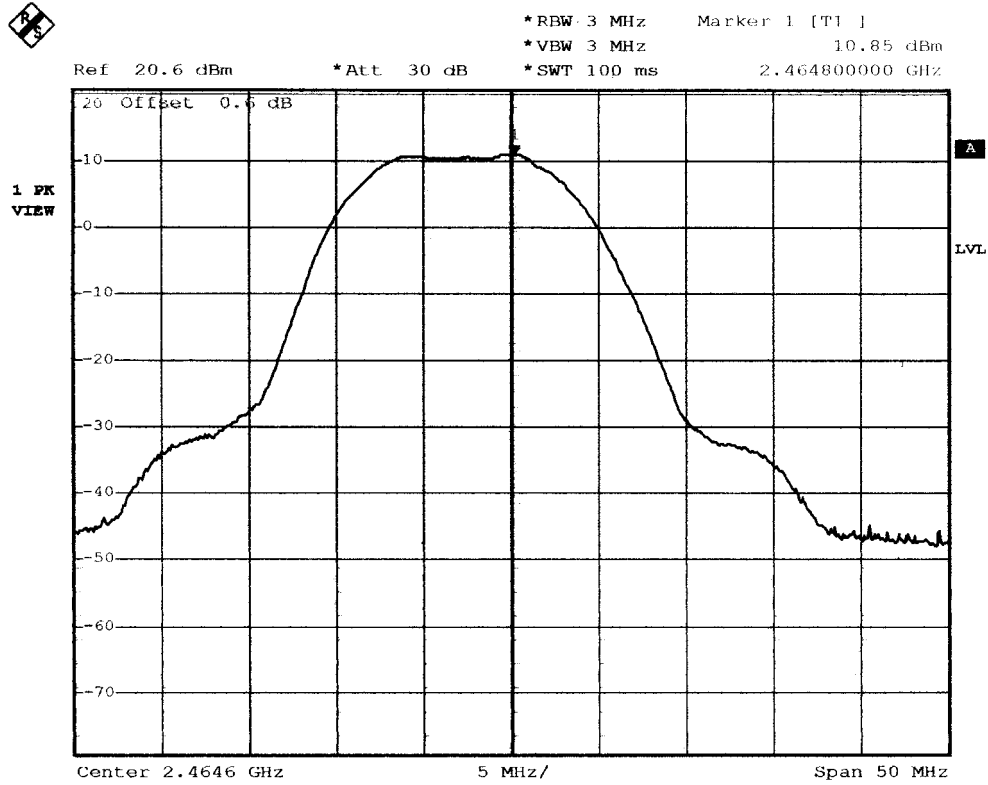



4.5 BAND EDGE TEST

4.5.1 LIMIT

FCC Part15, Subpart C Section 15.247. In any 100 kHz bandwidth outside the frequency band in which the spread spectrum intentional radiator is operating, the radio frequency power that is produced by the intentional radiator shall be at least 20 dB below that in the 100 kHz bandwidth within the band that contains the highest level of the desired power, based on either an RF conducted or a radiated measurement. Attenuation below the general limits specified in Section 15.209(a) is not required. In addition, radiated emissions which fall in the restricted bands, as defined in Section 15.205(a), must also comply with the radiated emission limits specified in Section 15.209(a) (see Section 15.205(c)).

OPERATING FREQUENCY RANGE (MHz)	SPURIOUS EMISSION FREQUENCY (MHz)	LIMIT	
		Peak power ration to emission(dBc)	Emission level(dBuV/m)
902 - 928	<902	>20	NA
	>928	>20	NA
	960-1240	NA	54
2400 - 2483.5	<2400	>20	NA
	>2483.5-2500	NA	54
5725 - 5850	<5350-5460	NA	54
	<5725	>20	NA
	>5850	>20	NA



Spectrum Research & Testing Lab., Inc.
No. 101-10, Ling 8,
Shan-Tong Li, Chung-Li
City, Taoyuan, Taiwan

TEST REPORT

Reference No.:A03012207
Report No.:FCCA03012207
Page:28 of 43
Date:Mar. 06, 2003

4.5.2 TEST EQUIPMENT

The following test equipment was used during the test:

EQUIPMENT/ FACILITIES	SPECIFICATIONS	MANUFACTURER	MODEL#/ SERIAL#	DUE DATE OF CAL. & CAL. CENTER
SPECTRUM	9kHz-7GHz	ROHDE & SCHWARZ	FSP7/ 839511/010	MAR. 2003 R & S
SPECTRUM	9KHz-26.5GHz	HP	8953E/ 3710A03220	MAY 2003 ETC
PRE-AMPLIFIER	1GHz-26.5GHz Gain:30dB(typ.)	HP	8449B/ 3008A01019	NOV. 2003 ETC
HORN ANTENNA	1GHz to 18GHz	EMCO	3115/ 9602-4681	DEC. 2003 ETC
OATS	3 - 10 M measurement	SRT	SRT-1	MAY 2003

NOTE: The calibration interval of the above test equipment is one year and the calibrations are traceable to NML/ROC and NIST/USA.



4.5.3 TEST SET-UP

FOR RF CONDUCTED TEST (dBc)

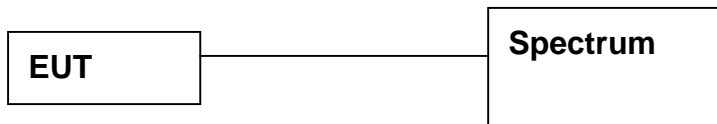

The EUT was connected to a spectrum through a 50Ω RF cable.

FOR RADIATED EMISSION TEST

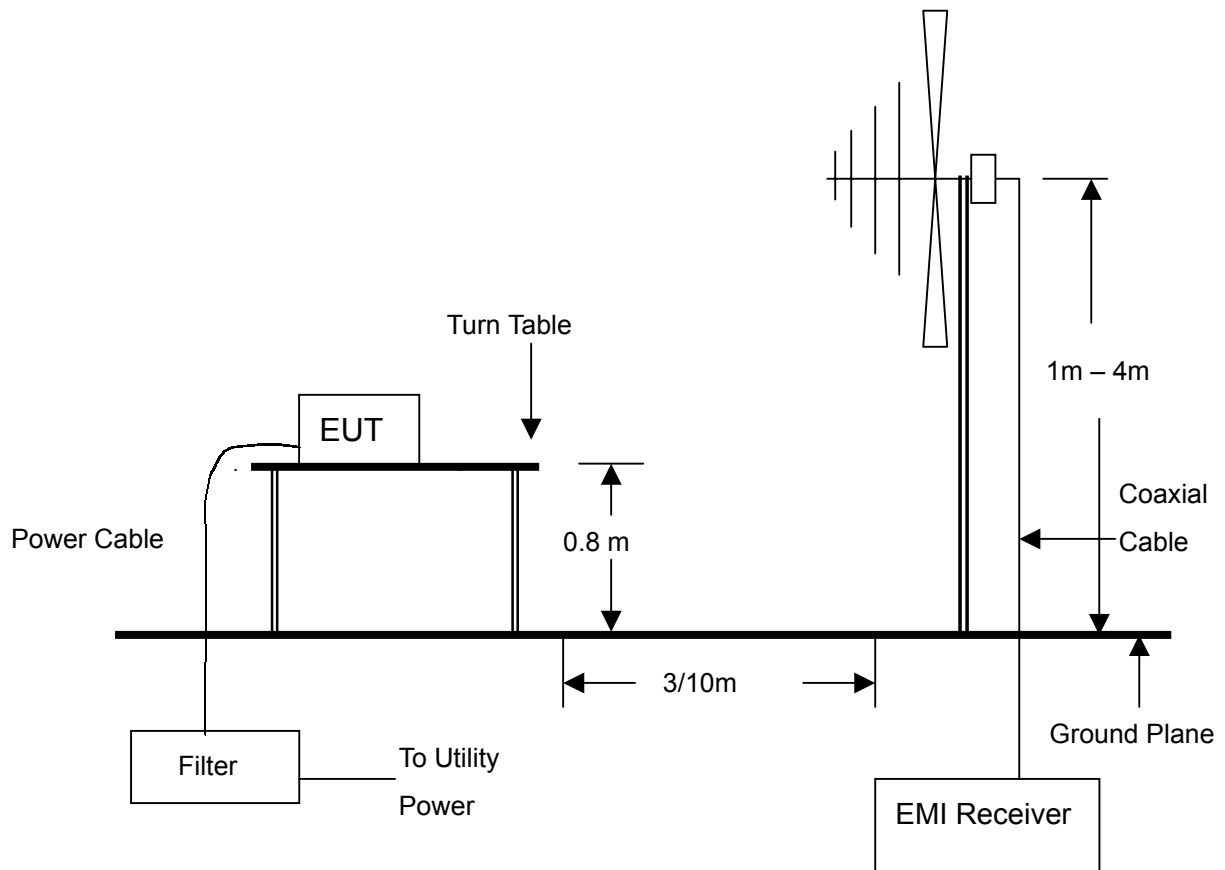

NOTE :

1. The EUT system was put on a wooden table with 0.8m heights above a ground plane.
2. For the actual test configuration, please refer to the photos of testing.



4.5.4 TEST PROCEDURE

1. The EUT was operating in transmitter mode and could be controlled its channel. Printed out the test result from the spectrum by hard copy function.
2. The EUT was tested according to the requirement of ANSI C63.4 and CISPR 22. The measurements were made at an open area test site with 10 meter measurement distance under 1 GHz and with 3m distance above 1GHz. The frequency spectrum measured started from 30 MHz. Under 1 GHz. All readings were quasi-peak values with 120 kHz resolution bandwidth of the test receiver. Above 1 GHz, the measurements were made at an open area test site with 3 meter measurement distance and all readings were peak and average values with 1 MHz resolution bandwidth of the test receiver. The EUT system was operated in all typical methods by users. The cables connected to EUT and support units were moved to find the maximum emission levels for each frequency.

4.5.5 EUT OPERATING CONDITION

Same as section 4.1.5 of this report.



4.5.6 TEST RESULT

Temperature: 23°C Humidity: 65%RH
 Spectrum Detector: PK. & AV. Tested by: Chris Hsien
 Test Result: Pass

1. Conducted test

Frequency (MHz)	PEAK POWER OUTPUT (dBm)	Emission read Value(dBm)	Result of Band edge (dBc)	Band edge LIMIT (dBc)
<2400	0.49	-41.73	42.22	>20dBc
>2483.5	-0.33	-49.64	49.31	>20dBc

2. Radiated emission test

Frequency (MHz)	Antenna polarization (H/V)	PEAK POWER OUTPUT (dBuV/m)	Emission read Value(dBuV/m)	Band edge LIMIT (dBuV/m)
<2400	V	90.9	49.8	54
>2483.5	V	90.6	42.5	54



<2400MHz

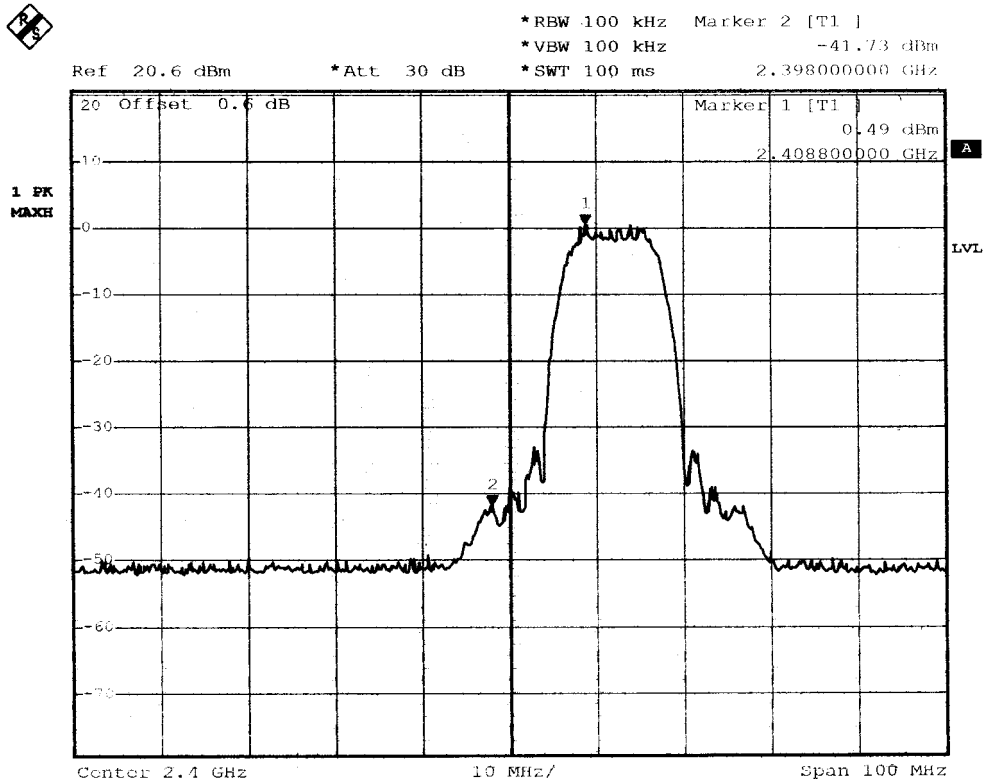



>2483.5MHz

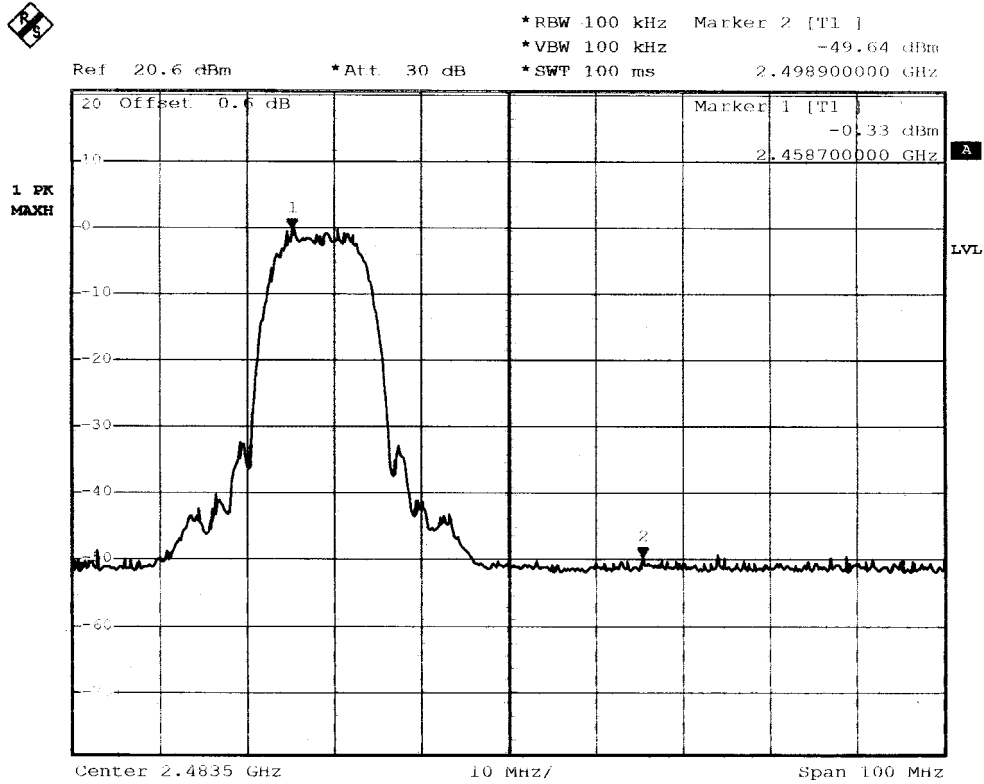



4.6 POWER DENSITY TEST

4.6.1 LIMIT

FCC Part15, Subpart C Section 15.247

FREQUENCY RANGE (MHz)	Limit(dBm/kHz)
902-928	8dBm/3kHz
2400-2483.5	
5725-5850	

4.6.2 TEST EQUIPMENT

The following test equipment was used during the radiated emission test:

EQUIPMENT/FACILITIES	SPECIFICATIONS	MANUFACTURER	MODEL#/SERIAL#	DUE DATE OF CAL. & CAL. CENTER
SPECTRUM	9kHz-7GHz	ROHDE & SCHWARZ	FSP7/ 839511/010	MAR. 2003 R & S

NOTE: The calibration interval of the above test equipment is one year and the calibrations are traceable to NML/ROC and NIST/USA.

4.6.3 TEST SET-UP

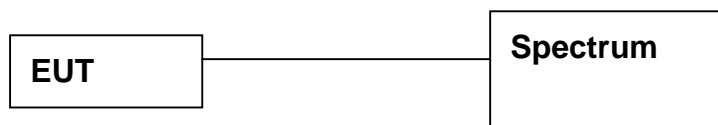

The EUT was connected to a spectrum through a 50Ω RF cable.

4.6.4 TEST PROCEDURE

The EUT was operating in transmitter mode and could be controlled its channel. Printed out the test result from the spectrum by hard copy function.

4.6.5 EUT OPERATING CONDITION

Same as section 4.1.5 of this report.



4.6.6 TEST RESULT

Temperature: 23°C Humidity: 65%RH
 Spectrum Detector: PK. Tested by: Chris Hsien
 Test Result: Pass

CHANNEL NUMBER	CHANNEL FREQUENCY (MHz)	RF POWER LEVEL IN 3kHz BW (dBm/3kHz)	MAXIMUM LIMIT (dBm/3kHz)
1	2408.15	-12.93	8
6	2433.15	-13.36	8
11	2461.97	-13.06	8

CH 1:

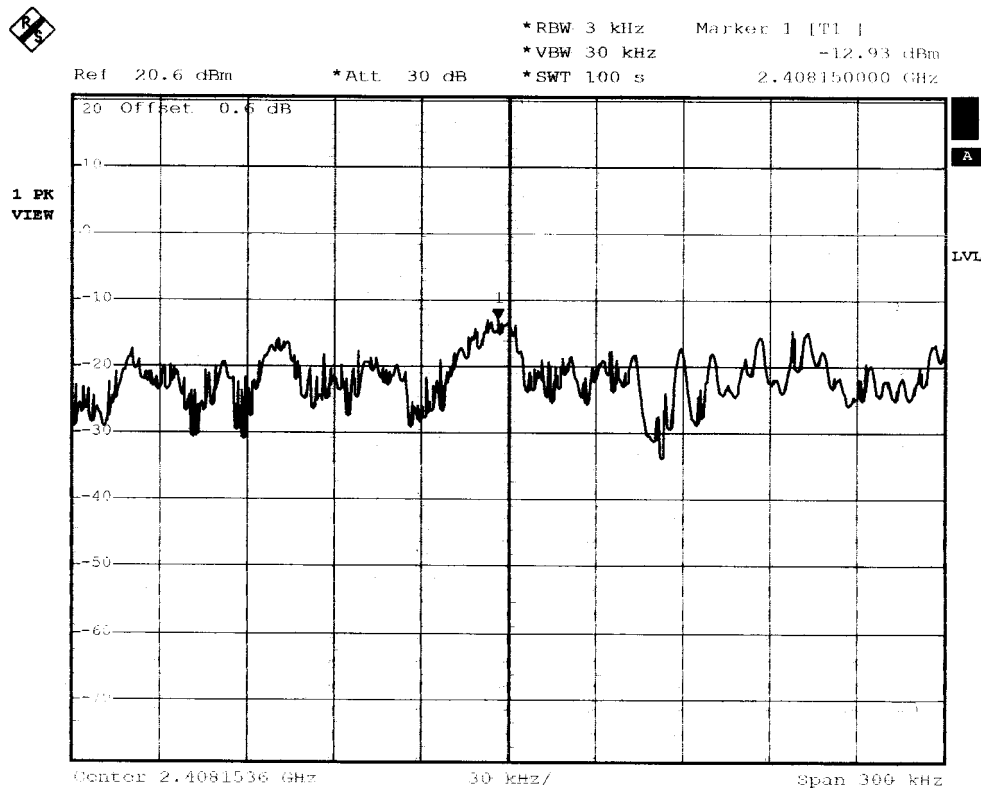



CH 6:

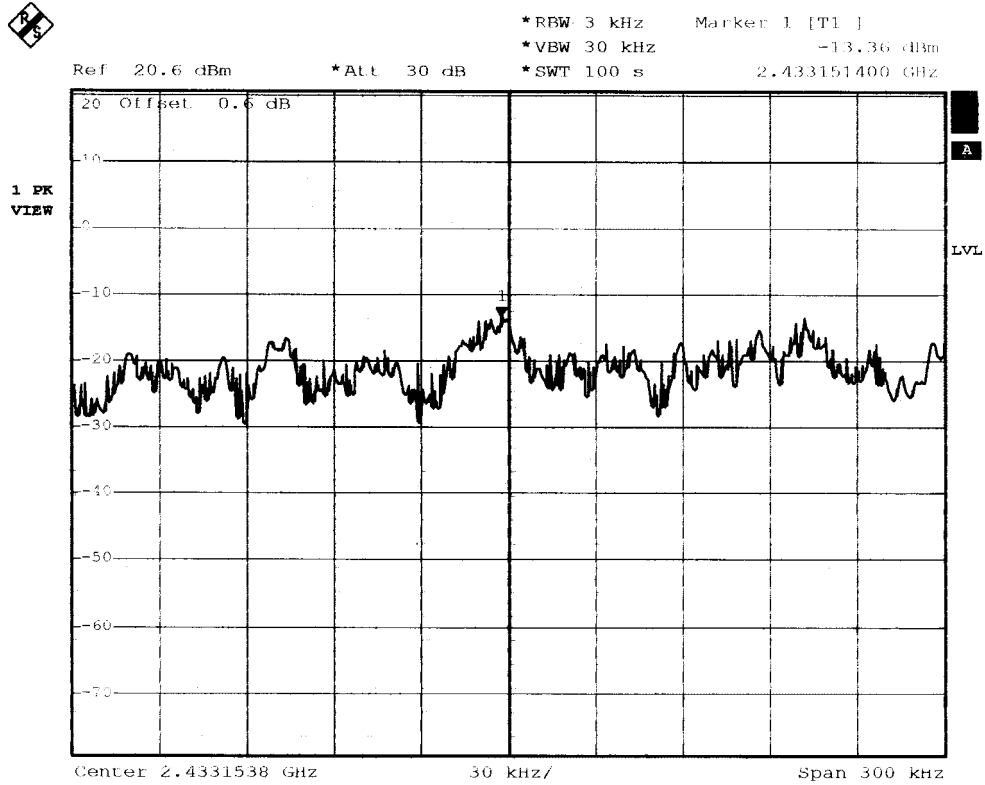



CH 11:

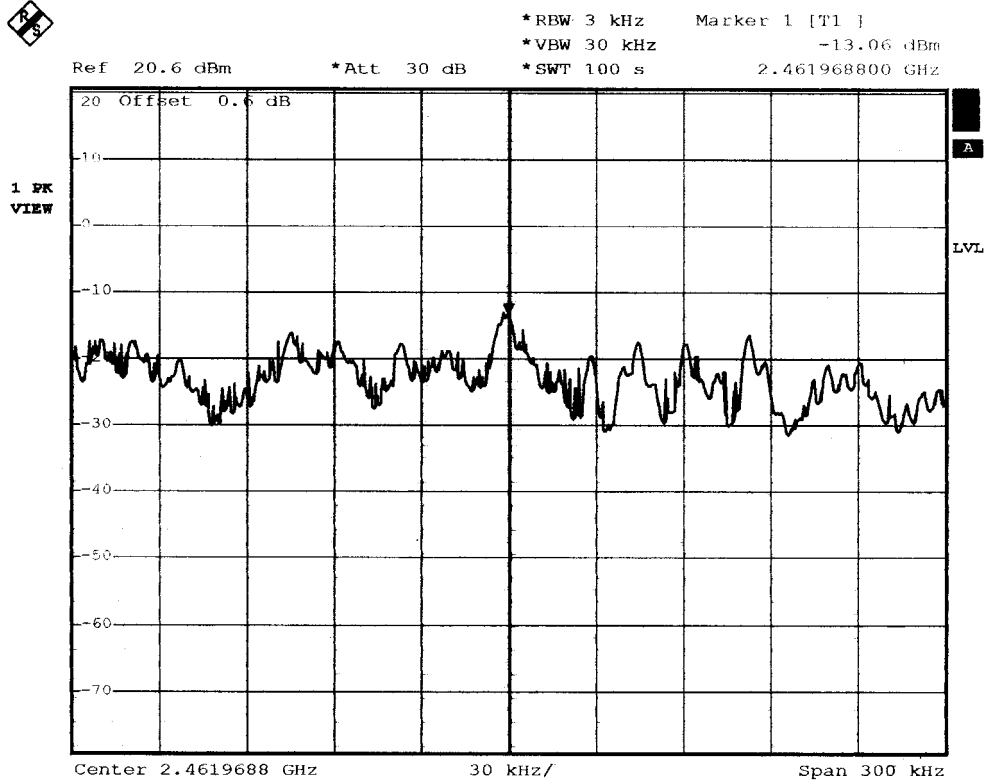



4.7 RF POWER EXPOSURE EVALUATION TEST

4.7.1 LIMIT

According to the requirement of IEEE C95.1 and FCC OET Bulletin 65.

Limits for Occupational/Controlled Exposure

Frequency Range (MHz)	Electric Field Strength(E) (V/m)	Magnetic Field Strength(H) (A/m)	Power density (S) (mW/cm ²)	Averaging Time E ² , H ² or S (minutes)
0.3-3.0	614	1.63	(100)*	6
3.0-30	1842/f	4.89/f	(900/f ²)*	6
30-300	61.4	0.163	1.0	6
300-1500	--	--	f/300	6
1500-100,000	--	--	5	6

Limits for General Population/Uncontrolled Exposure

Frequency Range (MHz)	Electric Field Strength(E) (V/m)	Magnetic Field Strength(H) (A/m)	Power density (S) (mW/cm ²)	Averaging Time E ² , H ² or S (minutes)
0.3-1.34	614	1.63	(100)*	30
1.34-30	824/f	2.19/f	(180/f ²)*	30
30-300	27.5	0.073	0.2	30
300-1500	--	--	f/1500	30
1500-100,000	--	--	1.0	30

f = frequency in MHz *Plane-wave equivalent power density

NOTE 1: Occupational/controlled limits apply in situations in which persons are exposed as a consequence of their employment provided those persons are fully aware of the potential for exposure and can exercise control over their exposure. Limits for occupational/controlled exposure also apply in situations when an individual is transient through a location where occupational/controlled limits apply provided he or she is made aware of the potential for exposure.

NOTE 2: General population/uncontrolled exposures apply in situations in which the general public may be exposed, or in which persons that are exposed as a consequence of their employment may not be fully aware of the potential for exposure or cannot exercise control over their exposure.



4.7.2 TEST EQUIPMENT

The following test equipment was used during the test:

EQUIPMENT/ FACILITIES	SPECIFICATIONS	MANUFACTURER	MODEL#/ SERIAL#	DUE DATE OF CAL. & CAL. CENTER
POWER METER	N/A	BOONTON	4232A/ 29001	MAY. 2003 ETC
POWER SENSOR	DC-8GHz 50	BOONTON	51011EMC/ 31181	MAY. 2003 ETC

NOTE: The calibration interval of the above test equipment is one year and the calibrations are traceable to NML/ROC and NIST/USA.

4.7.3 TEST SET-UP

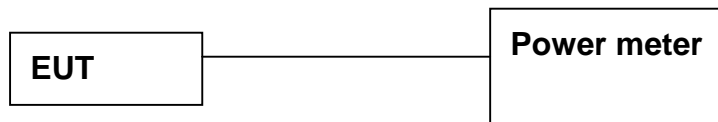

The EUT was connected to a spectrum through a 50Ω RF cable.



4.7.4 TEST PROCEDURE

1. The EUT was operating in transmitter mode and could be controlled its channel. The power meter read power value.
2. The EUT uses an sleeve dipole antenna and the antenna gain is 2dBi declared by manufacturer.
3. As discussed in OET Bulletin 65, calculations can be made to predict RF field strength and power density levels around typical RF sources. For example, in the case of a non-directional antenna, a prediction for power density in the far-field of the antenna can be made by use of the general Equations (1) or (2) below [for conversion to electric or magnetic field strength see Equation (3) above]. These equations are generally accurate in the far-field of an antenna but will over-predict power density in the near field, where it could be used for making a " worst case" or conservative prediction.

$$S=PG/4 R^2 \quad (\text{Eq.1})$$

$$S=EIRP/4 R^2 \quad (\text{Eq. 2})$$

$$S=E^2/3770=37.7H^2 \quad (\text{Eq. 3})$$

where: S = power density (mW/cm²)

E = electric field strength (V/m)

H = magnetic field strength (A/m)

S = power density (in appropriate units, e.g. mW/cm²)

P = power input to the antenna (in appropriate units, e.g., mW)

G = power gain of the antenna in the direction of interest relative to an isotropic radiator (dBi)

R = distance to the center of radiation of the antenna (appropriate units, e.g., cm)

where: EIRP = equivalent (or effective) isotropically radiated power

4.7.5 EUT OPERATING CONDITION

Same as section 4.1.5 of this report.



4.7.6 RESULT

Temperature: 23°C Humidity: 65%RH
Spectrum Detector: PK. Tested by: Chris Hsien
Test Result: Pass

CHANNEL NUMBER	CHANNEL FREQUENCY (MHz)	RF Output Power (mW)	Result calculated when nearby person (cm)	Limit when nearby person (cm)
1	2412	23.44	1.76	20
6	2437	21.37	1.68	20
11	2462	19.50	1.61	20

NOTE : The EUT uses a chip antenna and the antenna gain is 2dBi (1.58 numeric)



5. Antenna application

5.1 Antenna requirement

The EUT's antenna is met the requirement of FCC part15C section15.203 and 15.204.

FCC part15C section15.247 requirement:

Systems operating in the 2400-2483.5 MHz band that are used exclusively for fixed, point-to-point operations may employ transmitting antennas with directional gain greater than 6 dBi provided the maximum peak output power of the intentional radiator is reduced by 1 dB for every 3 dB that the directional gain of the antenna exceeds 6 dBi.

5.2 Result

The EUT's antenna used a chip antenna. The antenna's gain is 2dBi and meets the requirement.



6. TERMS OF ABRIVATION

AV.	Average detection
AZ(°)	Turn table azimuth
Correct.	Correction
EL(m)	Antenna height (meter)
EUT	Equipment Under Test
Horiz.	Horizontal direction
LISN	Line Impedance Stabilization Network
NSA	Normalized Site Attenuation
PK.	Peak detection
Q.P.	Quasi-peak detection
SRT Lab	Spectrum Research & Testing Laboratory, Inc.
Vert.	Vertical direction