

FCC Test Report

Report No.: RF171204C21

FCC ID: I4L-S199N1

Test Model: EGW101

Received Date: Dec. 04, 2017

Test Date: Dec. 08, 2017 ~ Dec. 16, 2017

Issued Date: Dec. 20, 2017

Applicant: Micro-Star International Co., Ltd.

Address: No.69, Lide St., Zhonghe Dist., New Taipei City 235, Taiwan (R.O.C.)

Issued By: Bureau Veritas Consumer Products Services (H.K.) Ltd., Taoyuan Branch

Lab Address: No. 47-2, 14th Ling, Chia Pau Vil., Lin Kou Dist., New Taipei City, Taiwan (R.O.C)

Test Location: No. 19, Hwa Ya 2nd Rd, Wen Hwa Tsuen, Kwei Shan Hsiang, Taoyuan Hsien 333, Taiwan, R.O.C.

**FCC Registration /
Designation Number:** 788550 / TW0003



This report is for your exclusive use. Any copying or replication of this report to or for any other person or entity, or use of our name or trademark, is permitted only with our prior written permission. This report sets forth our findings solely with respect to the test samples identified herein. The results set forth in this report are not indicative or representative of the quality or characteristics of the lot from which a test sample was taken or any similar or identical product unless specifically and expressly noted. Our report includes all of the tests requested by you and the results thereof based upon the information that you provided to us. You have 60 days from date of issuance of this report to notify us of any material error or omission caused by our negligence, provided, however, that such notice shall be in writing and shall specifically address the issue you wish to raise. A failure to raise such issue within the prescribed time shall constitute your unqualified acceptance of the completeness of this report, the tests conducted and the correctness of the report contents. Unless specific mention, the uncertainty of measurement has been explicitly taken into account to declare the compliance or non-compliance to the specification. The report must not be used by the client to claim product certification, approval, or endorsement by TAF or any government agencies.

Table of Contents

| | |
|---|-----------|
| Release Control Record | 3 |
| 1 Certificate of Conformity | 4 |
| 2 Summary of Test Results | 5 |
| 2.1 Measurement Uncertainty..... | 5 |
| 2.2 Modification Record | 5 |
| 3 General Information | 6 |
| 3.1 General Description of EUT | 6 |
| 3.2 Description of Test Modes..... | 7 |
| 3.2.1 Test Mode Applicability and Tested Channel Detail..... | 7 |
| 3.3 Description of Support Units | 9 |
| 3.3.1 Configuration of System under Test | 9 |
| 3.4 General Description of Applied Standards..... | 9 |
| 4 Test Types and Results | 10 |
| 4.1 Radiated Emission Measurement..... | 10 |
| 4.1.1 Limits of Radiated Emission Measurement | 10 |
| 4.1.2 Test Instruments | 11 |
| 4.1.3 Test Procedures..... | 12 |
| 4.1.4 Deviation from Test Standard | 12 |
| 4.1.5 Test Set Up | 13 |
| 4.1.6 EUT Operating Conditions..... | 13 |
| 4.1.7 Test Results | 14 |
| 4.2 Conducted Emission Measurement..... | 21 |
| 4.2.1 Limits of Conducted Emission Measurement | 21 |
| 4.2.2 Test Instruments | 21 |
| 4.2.3 Test Procedures..... | 22 |
| 4.2.4 Deviation from Test Standard | 22 |
| 4.2.5 Test Setup..... | 22 |
| 4.2.6 EUT Operating Conditions..... | 22 |
| 4.2.7 Test Results | 23 |
| 4.3 Frequency Stability | 25 |
| 4.3.1 Limits of Frequency Stability Measurement | 25 |
| 4.3.2 Test Setup..... | 25 |
| 4.3.3 Test Instruments | 25 |
| 4.3.4 Test Procedure | 25 |
| 4.3.5 Deviation from Test Standard | 25 |
| 4.3.6 EUT Operating Conditions..... | 25 |
| 4.3.7 Test Result | 26 |
| 4.4 20 dB Bandwidth..... | 27 |
| 4.4.1 Limits of 20 dB Bandwidth Measurement..... | 27 |
| 4.4.2 Test Setup..... | 27 |
| 4.4.3 Test Instruments | 27 |
| 4.4.4 Test Procedures..... | 27 |
| 4.4.5 Deviation from Test Standard | 27 |
| 4.4.6 EUT Operating Conditions..... | 27 |
| 4.4.7 Test Results | 28 |
| 5 Pictures of Test Arrangements | 29 |
| Appendix – Information on the Testing Laboratories | 30 |

Release Control Record

| Issue No. | Description | Date Issued |
|-------------|------------------|---------------|
| RF171204C21 | Original Release | Dec. 20, 2017 |

1 Certificate of Conformity

Product: NeoFace Access Control

Brand: NEC

Test Model: EGW101

Sample Status: Production Unit

Applicant: Micro-Star International Co., Ltd.

Test Date: Dec. 08, 2017 ~ Dec. 16, 2017

Standards: 47 CFR FCC Part 15, Subpart C (Section 15.225)
47 CFR FCC Part 15, Subpart C (Section 15.215)
ANSI C63.10:2013

The above equipment has been tested by **Bureau Veritas Consumer Products Services (H.K.) Ltd., Taoyuan Branch**, and found compliance with the requirement of the above standards. The test record, data evaluation & Equipment Under Test (EUT) configurations represented herein are true and accurate accounts of the measurements of the sample's EMC characteristics under the conditions specified in this report.

Prepared by : Evonne Liu, **Date:** Dec. 20, 2017
Evonne Liu / Specialist

Approved by : Dylan Chiou, **Date:** Dec. 20, 2017
Dylan Chiou / Project Engineer

2 Summary of Test Results

| 47 CFR FCC Part 15, Subpart C (Section 15.225, 15.215) | | | |
|--|--|--------|--|
| FCC Clause | Test Item | Result | Remarks |
| 15.207 | Conducted emission test | Pass | Meet the requirement of limit. Minimum passing margin is -4.68 dB at 0.56797 MHz. |
| 15.225 (a) | The field strength of any emissions within the band 13.553-13.567 MHz | Pass | Meet the requirement of limit. Minimum passing margin is -56.62 dB at 13.56 MHz. |
| 15.225 (b) | The field strength of any emissions within the bands 13.410-13.553 MHz and 13.567-13.710 MHz | Pass | Meet the requirement of limit. |
| 15.225 (c) | The field strength of any emissions within the bands 13.110-13.410 MHz and 13.710-14.010 MHz | Pass | Meet the requirement of limit. |
| 15.225 (d) | The field strength of any emissions appearing outside of the 13.110-14.010 MHz band | Pass | Meet the requirement of limit. Minimum passing margin is -1.28 dB at 263.77 MHz. |
| 15.225 (e) | The frequency tolerance | Pass | Meet the requirement of limit. |
| 15.215 (c) | 20 dB Bandwidth | Pass | Meet the requirement of limit. |
| 15.203 | Antenna Requirement | Pass | No antenna connector is used. |

2.1 Measurement Uncertainty

Where relevant, the following measurement uncertainty levels have been estimated for tests performed on the EUT as specified in CISPR 16-4-2:

| Measurement | Frequency | Expanded Uncertainty (k=2) (±) |
|------------------------------------|--------------------|--------------------------------|
| Conducted Emissions at mains ports | 150 kHz ~ 30 MHz | 2.44 dB |
| Radiated Emissions up to 1 GHz | 30 MHz ~ 200 MHz | 2.93 dB |
| | 200 MHz ~ 1000 MHz | 2.95 dB |
| Radiated Emissions above 1 GHz | 1 GHz ~ 18 GHz | 2.26 dB |
| | 18 GHz ~ 40 GHz | 1.94 dB |

2.2 Modification Record

There were no modifications required for compliance.

3 General Information

3.1 General Description of EUT

| | |
|----------------------------|-------------------------------------|
| Product | NeoFace Access Control |
| Brand | NEC |
| Test Model | EGW101 |
| Status of EUT | Production Unit |
| Power Supply Rating | 12 Vdc (adapter) 3 Vdc (battery) |
| Modulation Type | ASK |
| Operating Frequency | 13.56 MHz |
| Antenna Type | Loop Antenna |
| Accessory Device | Refer to Note |
| Data Cable Supplied | Refer to Note |

Note:

1. The EUT contains following accessory devices.

| Product | Brand | Model | Description |
|--------------|--------------------------------|-----------------------|--|
| Adapter | Delta | DPS150AB15F | I/P: 100-240 Vac, 50/60 Hz, 2000 mA O/P: 12 Vdc, 12500 mA |
| Battery | FUJI | CR1/ 26L-CN143S | 3 Vdc, 100 mAh |
| LCD Panel | KOE JDI Group | TX18D209VM0BAA | -- |
| Video Camera | Shikino High-Tech Co., Ltd. | KBCR-S03MUNF-4N256 | -- |
| CPU | Intel® Core™ i5-6500TE | i5-6500TE | 1151 Pin |
| ROM | MXIC | MX25L12873FM2I-10G(T) | -- |
| RAM | Innodisk | M4S0-4GSSNCRGA44 | 4G |
| Touch panel | LIYITEC INC. | PCT-070F-84-DIM | -- |

2. The above EUT information is declared by manufacturer and for more detailed features description, please refer to the manufacturer's specifications or user's manual.

3.2 Description of Test Modes

One channel was provided to this EUT:

| Channel | Frequency (MHz) |
|---------|-----------------|
| 1 | 13.56 |

3.2.1 Test Mode Applicability and Tested Channel Detail

| EUT Configure Mode | Applicable To | | | | Description |
|--------------------|---------------|-----|----|----|-------------|
| | RE | PLC | FS | EB | |
| - | √ | √ | √ | √ | - |

Where

RE: Radiated Emission
FS: Frequency Stability

PLC: Power Line Conducted Emission
EB: 20 dB Bandwidth measurement

Radiated Emission Test:

- Pre-Scan has been conducted to determine the worst-case mode from all possible combinations between available modulations, data rates and antenna ports (if EUT with antenna diversity architecture).
- Following channel(s) was (were) selected for the final test as listed below.

| EUT Configure Mode | Available Channel | Tested Channel | Modulation Type | Axis |
|--------------------|-------------------|----------------|-----------------|------|
| - | 1 | 1 | ASK | Z |

Power Line Conducted Emission Test:

- Pre-Scan has been conducted to determine the worst-case mode from all possible combinations between available modulations, data rates and antenna ports (if EUT with antenna diversity architecture).
- Following channel(s) was (were) selected for the final test as listed below.

| EUT Configure Mode | Available Channel | Tested Channel | Modulation Type | Axis |
|--------------------|-------------------|----------------|-----------------|------|
| - | 1 | 1 | ASK | Z |

Frequency Stability:

- This item includes all test value of each mode, but only includes spectrum plot of worst value of each mode.
- Pre-Scan has been conducted to determine the worst-case mode from all possible combinations between available modulations, data rates and antenna ports (if EUT with antenna diversity architecture).
- Following channel(s) was (were) selected for the final test as listed below.

| EUT Configure Mode | Available Channel | Tested Channel | Modulation Type | Axis |
|--------------------|-------------------|----------------|-----------------|------|
| - | 1 | 1 | ASK | Z |

20 dB Bandwidth:

- This item includes all test value of each mode, but only includes spectrum plot of worst value of each mode.
- Pre-Scan has been conducted to determine the worst-case mode from all possible combinations between available modulations, data rates and antenna ports (if EUT with antenna diversity architecture).
- Following channel(s) was (were) selected for the final test as listed below.

| EUT Configure Mode | Available Channel | Tested Channel | Modulation Type | Axis |
|--------------------|-------------------|----------------|-----------------|------|
| - | 1 | 1 | ASK | Z |

Test Condition:

| Applicable To | Environmental Conditions | Input Power | Tested By |
|---------------|--------------------------|----------------|--------------|
| RE | 25 deg. C, 65 % RH | 120 Vac, 60 Hz | Jisyong Wang |
| FS | 25 deg. C, 65 % RH | 120 Vac, 60 Hz | Gavin Wu |
| PLC | 25 deg. C, 65 % RH | 120 Vac, 60 Hz | Getaz Yang |
| EB | 25 deg. C, 68 % RH | 120 Vac, 60 Hz | Gavin Wu |

3.3 Description of Support Units

The EUT has been tested as an independent unit together with other necessary accessories or support units.

3.3.1 Configuration of System under Test

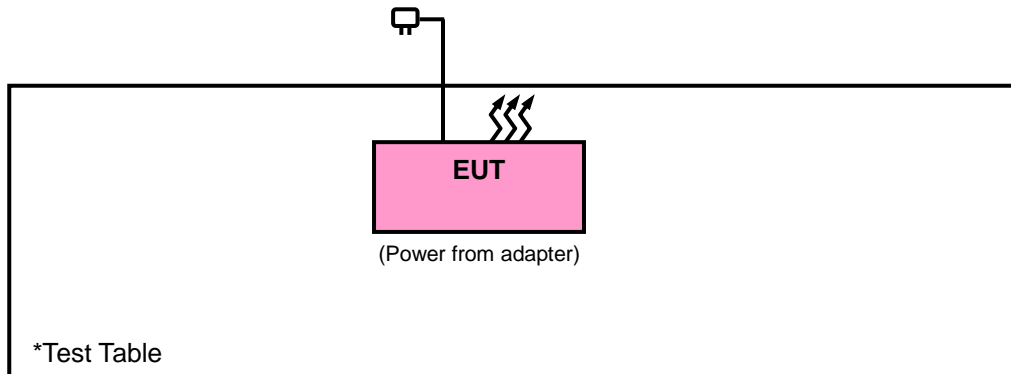

3.4 General Description of Applied Standards

The EUT is a RF Product. According to the specifications of the manufacturer, it must comply with the requirements of the following standards:

FCC Part 15, Subpart C (15.225)

FCC Part 15, Subpart C (15.215)

ANSI C63.10-2013

All test items have been performed and recorded as per the above standards.

4 Test Types and Results

4.1 Radiated Emission Measurement

4.1.1 Limits of Radiated Emission Measurement

The field strength of any emissions within the band 13.553-13.567 MHz shall not exceed 15,848 microvolts/meter at 30 meters.

The field strength of any emissions within the bands 13.410-13.553 MHz and 13.567-13.710 MHz shall not exceed 334 microvolts/meter at 30 meters.

The field strength of any emissions within the bands 13.110-13.410 MHz and 13.710-14.010 MHz shall not exceed 106 microvolts/meter at 30 meters.

The field strength of any emissions appearing outside of the 13.110-14.010 MHz band shall not exceed the general radiated emission limits in § 15.209.

| Frequencies (MHz) | Field Strength (microvolts/meter) | Measurement Distance (meters) |
|-------------------|-----------------------------------|-------------------------------|
| 0.009 ~ 0.490 | 2400/F (kHz) | 300 |
| 0.490 ~ 1.705 | 24000/F (kHz) | 30 |
| 1.705 ~ 30.0 | 30 | 30 |
| 30 ~ 88 | 100 | 3 |
| 88 ~ 216 | 150 | 3 |
| 216 ~ 960 | 200 | 3 |
| Above 960 | 500 | 3 |

NOTE:

1. The lower limit shall apply at the transition frequencies.
2. Emission level (dBuV/m) = 20 log Emission level (uV/m).
3. For frequencies above 1000 MHz, the field strength limits are based on average detector, however, the peak field strength of any emission shall not exceed the maximum permitted average limits, specified above by more than 20 dB under any condition of modulation.

4.1.2 Test Instruments

| Description & Manufacturer | Model No. | Serial No. | Date of Calibration | Due Date of Calibration |
|--|----------------|---------------------|---------------------|-------------------------|
| Test Receiver Agilent | N9038A | MY51210203 | Feb. 17, 2017 | Feb. 16, 2018 |
| Spectrum Analyzer Agilent | N9010A | MY52220314 | Nov. 24, 2017 | Nov. 23, 2018 |
| Spectrum Analyzer ROHDE & SCHWARZ | FSL3 | 104596 | Oct. 11, 2017 | Oct. 10, 2018 |
| BILOG Antenna SCHWARZBECK | VULB9168 | 9168-472 | Dec. 26, 2016 | Dec. 27, 2017 |
| HORN Antenna SCHWARZBECK | BBHA 9120 D | 9120D-969 | Dec. 12, 2017 | Dec. 11, 2018 |
| HORN Antenna SCHWARZBECK | BBHA 9170 | 9170-480 | Dec. 01, 2017 | Nov. 31, 2018 |
| Fixed Attenuator Mini-Circuits | MDCS18N-10 | MDCS18N-10-01 | Apr. 17, 2017 | Apr. 16, 2018 |
| Loop Antenna | HLA 6121 | 45745 | May 19, 2017 | May 18, 2018 |
| Preamplifier EMCI | EMC001340 | 980201 | Nov. 01, 2017 | Oct. 31, 2018 |
| Preamplifier EMCI | EMC 012645 | 980115 | Oct. 20, 2017 | Oct. 19, 2018 |
| Preamplifier EMCI | EMC 184045 | 980116 | Oct. 20, 2017 | Oct. 19, 2018 |
| Preamplifier EMCI | EMC 330H | 980112 | Oct. 13, 2017 | Oct. 12, 2018 |
| Power Meter Anritsu | ML2495A | 1145013 | Mar. 07, 2017 | Mar. 06, 2018 |
| Power Sensor Anritsu | MA2411B | 1315050 | Aug. 15, 2017 | Aug. 14, 2018 |
| RF signal cable HUBER+SUHNNER | SUCOFLEX 104 | 309224/4 1709074 | Sep. 11, 2017 | Sep. 10, 2018 |
| RF signal cable HUBER+SUHNNER | SUCOFLEX 104 | 223653/4 | Aug. 21, 2017 | Aug. 20, 2018 |
| RF Coaxial Cable Worken | 8D-FB | Cable-Ch10-01 | Oct. 20, 2017 | Oct. 19, 2018 |
| Software BV ADT | E3 6.120103 | NA | NA | NA |
| Antenna Tower MF | MFA-440H | NA | NA | NA |
| Turn Table MF | MFT-201SS | NA | NA | NA |
| Antenna Tower & Turn Table Controller MF | MF-7802 | NA | NA | NA |

- Note: 1. The calibration interval of the above test instruments is 12 months and the calibrations are traceable to NML/ROC and NIST/USA.
2. The test was performed in HwaYa Chamber 10.
3. The horn antenna and preamplifier (model: EMC 184045) are used only for the measurement of emission frequency above 1 GHz if tested.
4. The IC Site Registration No. is IC7450F-10.

4.1.3 Test Procedures

- a. The EUT was placed on the top of a rotating table 0.8 meters above the ground at a 3 meters semi-anechoic chamber. The table was rotated 360 degrees to determine the position of the highest radiation.
- b. The EUT was set 3 meters away from the interference-receiving antenna, which was mounted on the top of a variable-height antenna tower.
- c. Height of receiving antenna is varied from one meter to four meters above the ground to determine the maximum value of the field strength. Both horizontal and vertical polarizations of the antenna are set to make the measurement.
- d. For each suspected emission, the EUT was arranged to its worst case and then the antenna was tuned to heights from 1 meter to 4 meters and the rotatable table was turned from 0 degrees to 360 degrees to find the maximum reading.
- e. The test-receiver system was set to Peak Detect Function and Specified Bandwidth with Maximum Hold Mode.
- f. If the emission level of the EUT in peak mode was lower than the limit specified, then testing could be stopped and the peak values of the EUT would be reported. Otherwise the emissions would be re-tested one by one using peak, quasi-peak or average method as specified and then reported in a data sheet.

NOTE:

1. The resolution bandwidth and video bandwidth of test receiver/spectrum analyzer is 120 kHz for Quasi-peak detection at frequency below 1 GHz.
2. The resolution bandwidth of test receiver/spectrum analyzer is 1 MHz and video bandwidth is 3 MHz for Peak detection at frequency above 1 GHz.
3. The resolution bandwidth of test receiver/spectrum analyzer is 1 MHz and the video bandwidth is $\geq 1/T$ (Duty cycle < 98 %) or 10 Hz (Duty cycle > 98 %) for Average detection (AV) at frequency above 1 GHz.
4. All modes of operation were investigated and the worst-case emissions are reported.

4.1.4 Deviation from Test Standard

No deviation.

4.1.5 Test Set Up

Frequency range 9 k ~ 30 MHz:

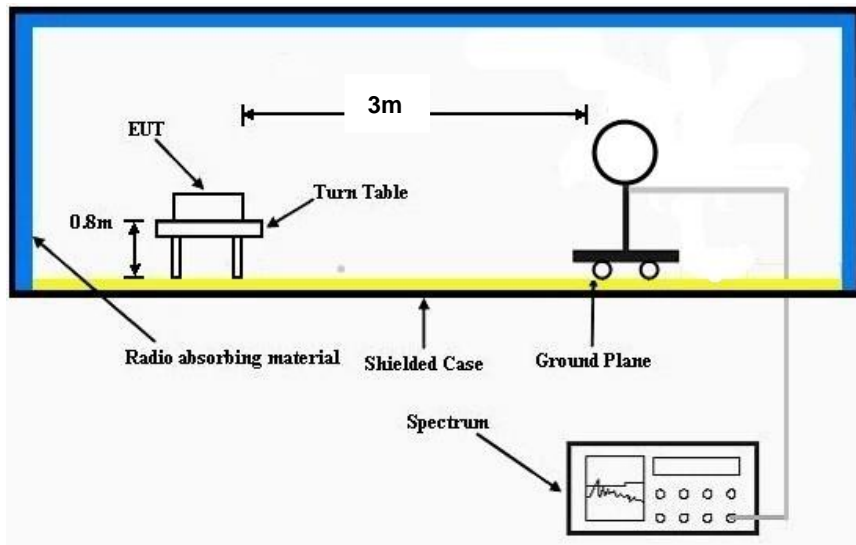

Frequency range 30 ~ 1000 MHz:

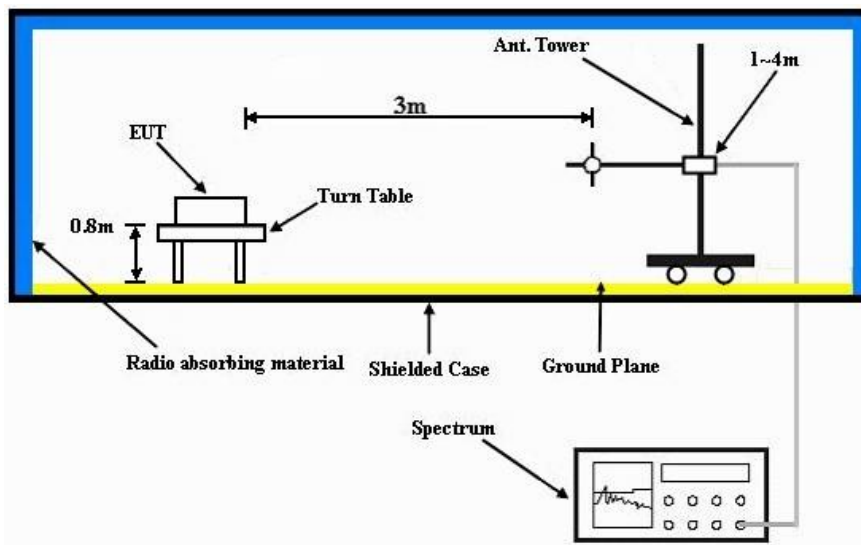

For the actual test configuration, please refer to the attached file (Test Setup Photo).

4.1.6 EUT Operating Conditions

- Placed the EUT on the testing table.
- Set the EUT under transmission condition continuously at specific channel frequency.

4.1.7 Test Results

No non-compliance noted:

KDB 937606 OATS and Chamber Correlation Justification

- Base on FCC 15.31 (f) (2): measurements may be performed at a distance closer than that specified in the regulations; however, an attempt should be made to avoid making measurements in the near field.
- OATs and chamber correlation testing had been performed and chamber measured test result is the worst case test result.

| EUT Test Condition | | Measurement Detail | |
|--------------------------|--------------------|--------------------|---------------------|
| Channel | Channel 1 | Frequency Range | 13.553 ~ 13.567 MHz |
| Input Power | 120 Vac, 60 Hz | Detector Function | Quasi-Peak |
| Environmental Conditions | 25 deg. C, 65 % RH | Tested By | Jisyong Wang |

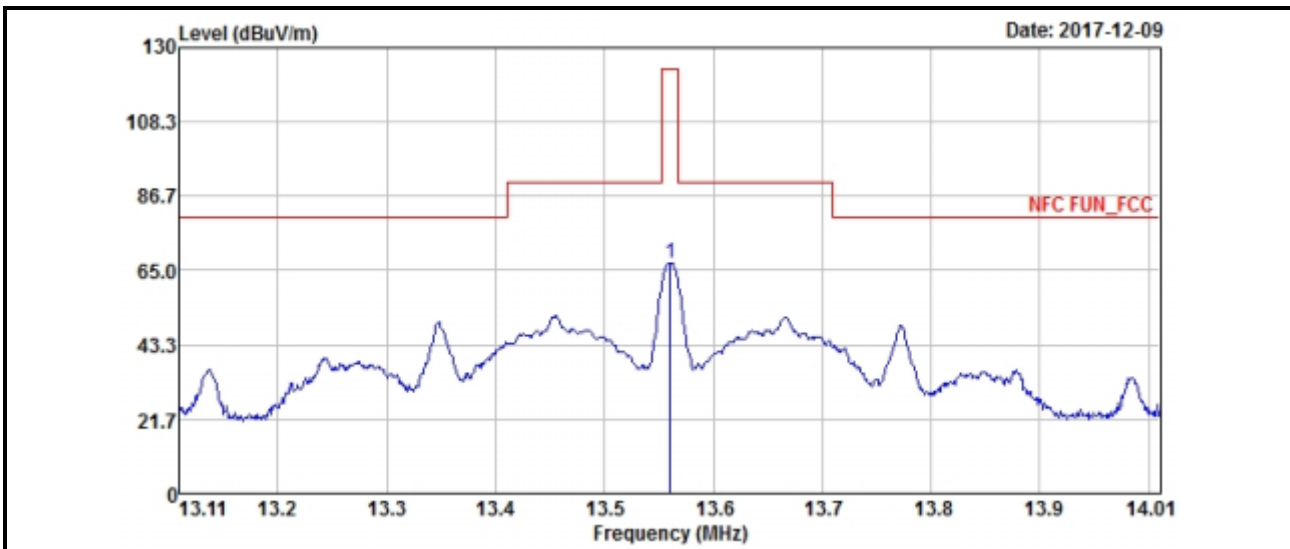

| Antenna Polarity & Test Distance: Loop Antenna Open at 3 m | | | | | | | | | | |
|--|-------------------------|-------------------|----------------|-------------|-----------------------|-----------------|--------------------|---------------------|----------------------|--------|
| Frequency (MHz) | Emission Level (dBuV/m) | Read Level (dBuV) | Limit (dBuV/m) | Margin (dB) | Antenna Factor (dB/m) | Cable Loss (dB) | Preamp Factor (dB) | Antenna Height (cm) | Table Angle (Degree) | Remark |
| 13.56 | 67.38 | 70.76 | 124 | -56.62 | 37.67 | 0.31 | 41.36 | 100 | 0 | QP |

Remarks:

1. Emission level (dBuV/m) = Raw Value (dBuV) + Correction Factor (dB/m)
2. Correction Factor (dB/m) = Antenna Factor (dB/m) + Cable Factor (dB) – Pre-Amplifier Factor (dB)
3. The other emission levels were very low against the limit.
4. Margin value = Emission level – Limit value.
5. Above limits have been translated by the formula

The measured field strength was extrapolated to distance 30 meters, using the formula that the limit of field strength varies as the inverse distance square (40dB per decade of distance)

Example:

$$\begin{aligned}
 13.56 \text{ MHz} &= 15848 \text{ uV/m} && 30\text{m} \\
 &= 84 \text{ dBuV/m} && 30\text{m} \\
 &= 84+20\log(30/3)^2 && 3\text{m} \\
 &= 124 \text{ dBuV/m}
 \end{aligned}$$

| EUT Test Condition | | Measurement Detail | |
|--------------------------|--------------------|--------------------|---------------------|
| Channel | Channel 1 | Frequency Range | 13.553 ~ 13.567 MHz |
| Input Power | 120 Vac, 60 Hz | Detector Function | Quasi-Peak |
| Environmental Conditions | 25 deg. C, 65 % RH | Tested By | Jisyong Wang |

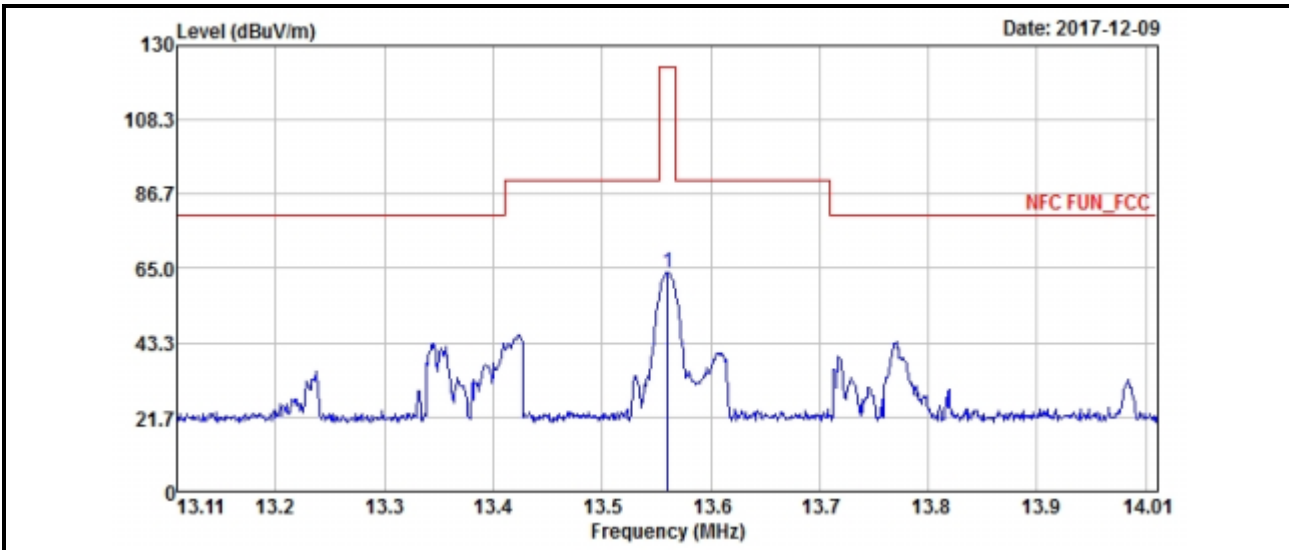

| Antenna Polarity & Test Distance: Loop Antenna Close at 3 m | | | | | | | | | | |
|---|-------------------------|-------------------|----------------|-------------|-----------------------|-----------------|--------------------|---------------------|----------------------|--------|
| Frequency (MHz) | Emission Level (dBuV/m) | Read Level (dBuV) | Limit (dBuV/m) | Margin (dB) | Antenna Factor (dB/m) | Cable Loss (dB) | Preamp Factor (dB) | Antenna Height (cm) | Table Angle (Degree) | Remark |
| 13.56 | 63.75 | 67.13 | 124 | -60.25 | 37.67 | 0.31 | 41.36 | 100 | 360 | QP |

Remarks:

1. Emission level (dBuV/m) = Raw Value (dBuV) + Correction Factor (dB/m)
2. Correction Factor (dB/m) = Antenna Factor (dB/m) + Cable Factor (dB) – Pre-Amplifier Factor (dB)
3. The other emission levels were very low against the limit.
4. Margin value = Emission level – Limit value.
5. Above limits have been translated by the formula

The measured field strength was extrapolated to distance 30 meters, using the formula that the limit of field strength varies as the inverse distance square (40dB per decade of distance)

Example:

$$\begin{aligned}
 13.56 \text{ MHz} &= 15848 \text{ uV/m} && 30\text{m} \\
 &= 84 \text{ dBuV/m} && 30\text{m} \\
 &= 84+20\log(30/3)^2 && 3\text{m} \\
 &= 124 \text{ dBuV/m}
 \end{aligned}$$

| EUT Test Condition | | Measurement Detail | |
|--------------------------|--------------------|--------------------|--------------|
| Channel | Channel 1 | Frequency Range | Below 30 MHz |
| Input Power | 120 Vac, 60 Hz | Detector Function | Quasi-Peak |
| Environmental Conditions | 25 deg. C, 65 % RH | Tested By | Jisyong Wang |

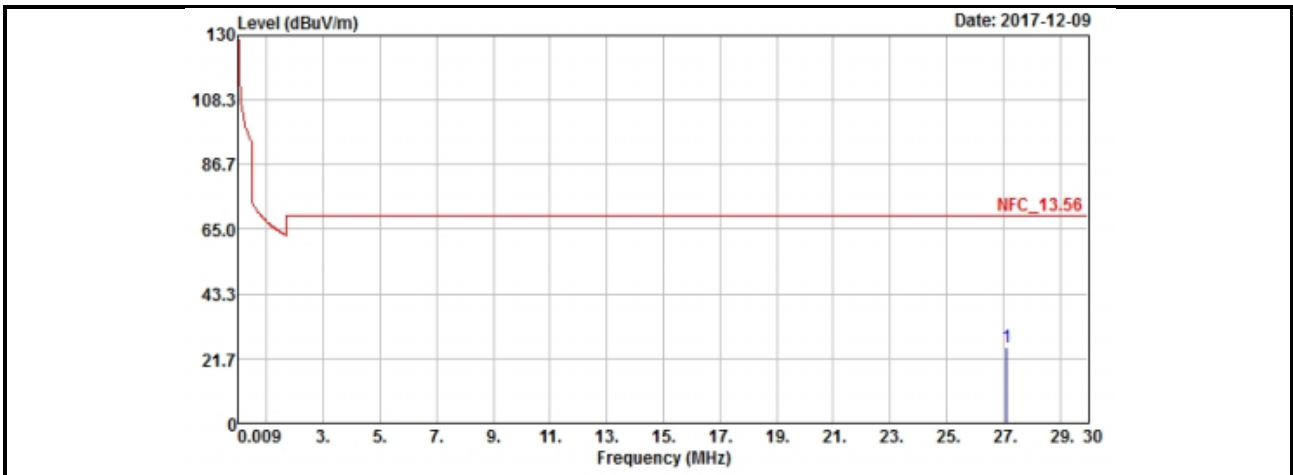

| Antenna Polarity & Test Distance: Loop Antenna Open at 3 m | | | | | | | | | | |
|--|-------------------------|-------------------|----------------|-------------|-----------------------|-----------------|--------------------|---------------------|----------------------|--------|
| Frequency (MHz) | Emission Level (dBuV/m) | Read Level (dBuV) | Limit (dBuV/m) | Margin (dB) | Antenna Factor (dB/m) | Cable Loss (dB) | Preamp Factor (dB) | Antenna Height (cm) | Table Angle (Degree) | Remark |
| 27.12 | 25.41 | 30.81 | 69.54 | -44.13 | 35.55 | 0.38 | 41.33 | 100 | 0 | QP |

Remarks:

1. Emission level (dBuV/m) = Raw Value (dBuV) + Correction Factor (dB/m)
2. Correction Factor (dB/m) = Antenna Factor (dB/m) + Cable Factor (dB) – Pre-Amplifier Factor (dB)
3. The other emission levels were very low against the limit.
4. Margin value = Emission level – Limit value.

| EUT Test Condition | | Measurement Detail | |
|--------------------------|--------------------|--------------------|--------------|
| Channel | Channel 1 | Frequency Range | Below 30 MHz |
| Input Power | 120 Vac, 60 Hz | Detector Function | Quasi-Peak |
| Environmental Conditions | 25 deg. C, 65 % RH | Tested By | Jisyong Wang |

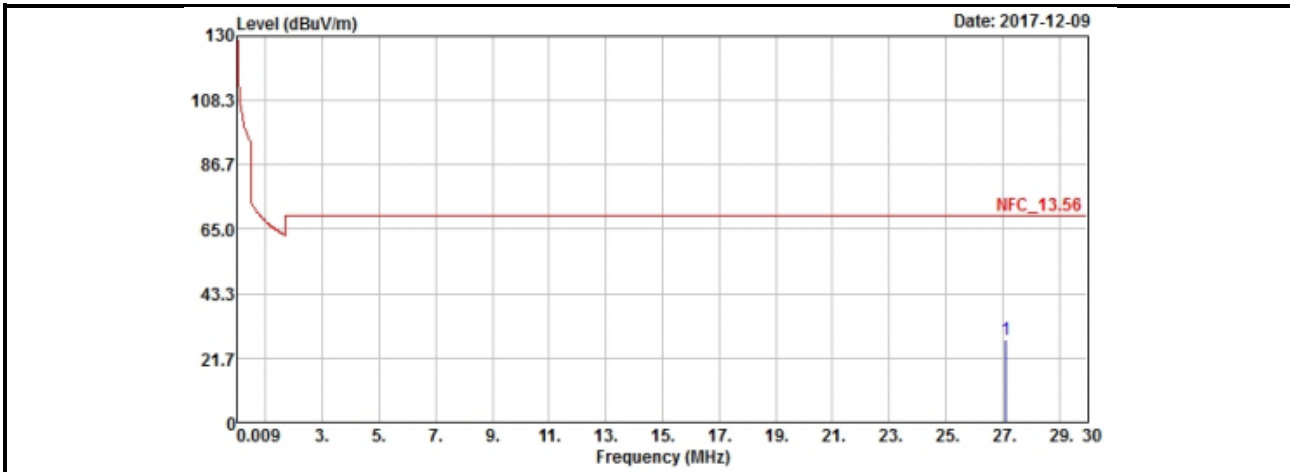

| Antenna Polarity & Test Distance: Loop Antenna Close at 3 m | | | | | | | | | | |
|---|-------------------------|-------------------|----------------|-------------|-----------------------|-----------------|--------------------|---------------------|----------------------|--------|
| Frequency (MHz) | Emission Level (dBuV/m) | Read Level (dBuV) | Limit (dBuV/m) | Margin (dB) | Antenna Factor (dB/m) | Cable Loss (dB) | Preamp Factor (dB) | Antenna Height (cm) | Table Angle (Degree) | Remark |
| 27.12 | 27.65 | 33.05 | 69.54 | -41.89 | 35.55 | 0.38 | 41.33 | 100 | 360 | QP |

Remarks:

1. Emission level (dBuV/m) = Raw Value (dBuV) + Correction Factor (dB/m)
2. Correction Factor (dB/m) = Antenna Factor (dB/m) + Cable Factor (dB) – Pre-Amplifier Factor (dB)
3. The other emission levels were very low against the limit.
4. Margin value = Emission level – Limit value.

| EUT Test Condition | | Measurement Detail | |
|--------------------------|--------------------|--------------------|----------------|
| Channel | Channel 1 | Frequency Range | Below 1000 MHz |
| Input Power | 120 Vac, 60 Hz | Detector Function | Quasi-Peak |
| Environmental Conditions | 25 deg. C, 65 % RH | Tested By | Jisyong Wang |

Horizontal

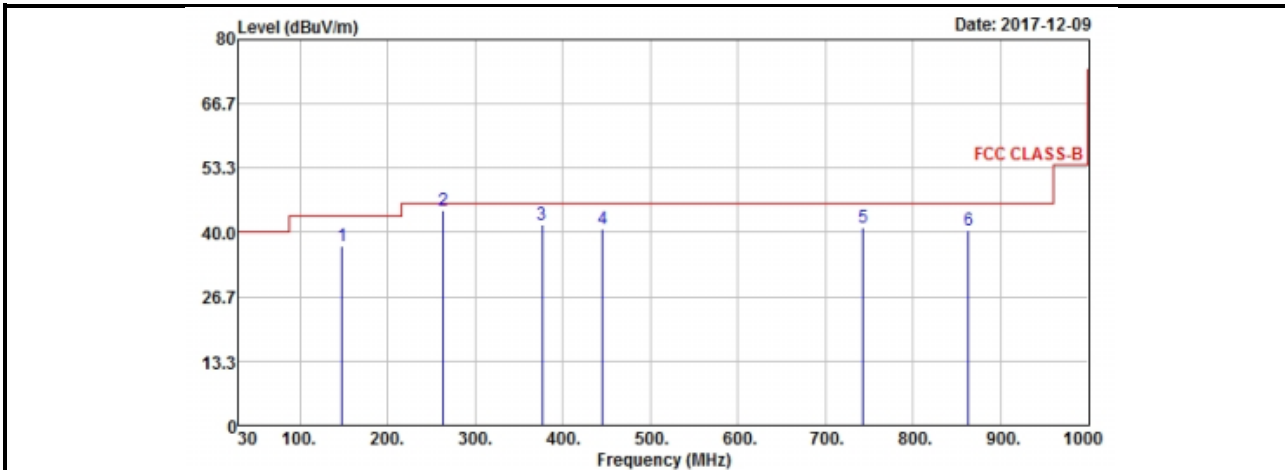

Vertical

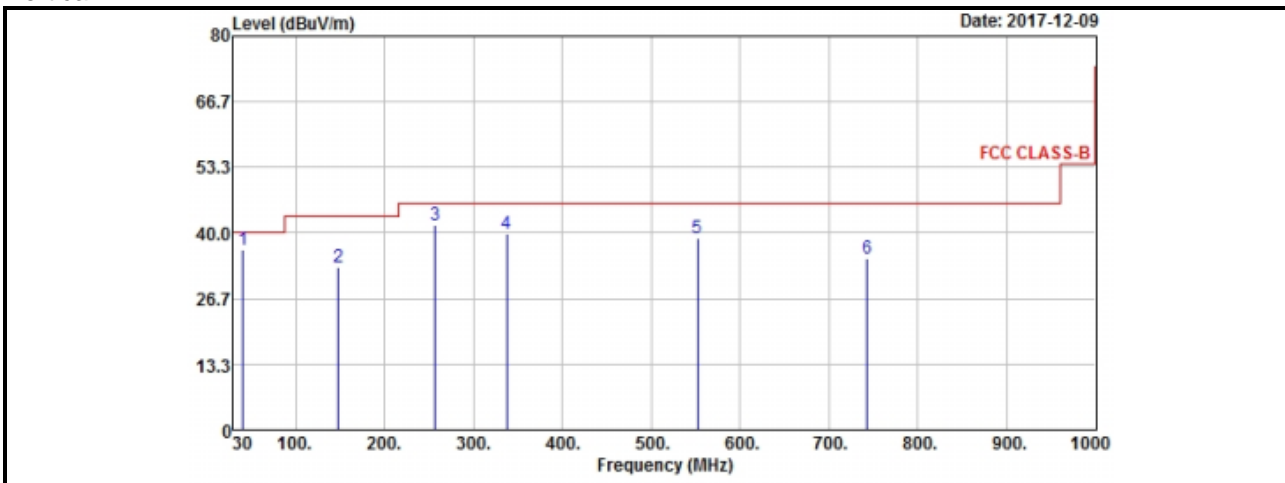

Antenna Polarity & Test Distance: Horizontal at 3 m

| Frequency (MHz) | Emission Level (dBuV/m) | Read Level (dBuV) | Limit (dBuV/m) | Margin (dB) | Antenna Factor (dB/m) | Cable Loss (dB) | Preamp Factor (dB) | Antenna Height (cm) | Table Angle (Degree) | Remark |
|-----------------|-------------------------|-------------------|----------------|-------------|-----------------------|-----------------|--------------------|---------------------|----------------------|--------|
| 148.34 | 37.31 | 55.32 | 43.5 | -6.19 | 12.64 | 0.97 | 31.62 | 131 | 251 | Peak |
| 263.77 | 44.72 | 63.26 | 46 | -1.28 | 11.88 | 1.5 | 31.92 | 152 | 145 | QP |
| 376.29 | 41.67 | 56.85 | 46 | -4.33 | 14.77 | 1.99 | 31.94 | 201 | 145 | Peak |
| 445.16 | 40.71 | 54.21 | 46 | -5.29 | 16.23 | 2.26 | 31.99 | 201 | 254 | Peak |
| 742.95 | 41.1 | 47.63 | 46 | -4.9 | 21.42 | 3.48 | 31.43 | 111 | 147 | Peak |
| 863.23 | 40.54 | 45.53 | 46 | -5.46 | 23.04 | 3.9 | 31.93 | 202 | 145 | Peak |

Antenna Polarity & Test Distance: Vertical at 3 m

| Frequency (MHz) | Emission Level (dBuV/m) | Read Level (dBuV) | Limit (dBuV/m) | Margin (dB) | Antenna Factor (dB/m) | Cable Loss (dB) | Preamp Factor (dB) | Antenna Height (cm) | Table Angle (Degree) | Remark |
|-----------------|-------------------------|-------------------|----------------|-------------|-----------------------|-----------------|--------------------|---------------------|----------------------|--------|
| 40.67 | 36.56 | 53.54 | 40 | -3.44 | 13.55 | 0.49 | 31.02 | 222 | 236 | Peak |
| 148.34 | 32.97 | 50.98 | 43.5 | -10.53 | 12.64 | 0.97 | 31.62 | 201 | 147 | Peak |
| 256.98 | 41.61 | 60.33 | 46 | -4.39 | 11.68 | 1.48 | 31.88 | 203 | 214 | Peak |
| 337.49 | 39.92 | 56.08 | 46 | -6.08 | 13.84 | 1.82 | 31.82 | 131 | 258 | Peak |
| 551.86 | 38.98 | 49.75 | 46 | -7.02 | 18.5 | 2.7 | 31.97 | 232 | 256 | Peak |
| 742.95 | 34.92 | 41.45 | 46 | -11.08 | 21.42 | 3.48 | 31.43 | 222 | 132 | Peak |

Remarks:

1. Emission Level = Read Level + Antenna Factor + Cable Loss - Preamp Factor

Margin value = Emission level – Limit value.

4.2 Conducted Emission Measurement

4.2.1 Limits of Conducted Emission Measurement

| Frequency (MHz) | Conducted Limit (dBuV) | |
|-----------------|------------------------|---------|
| | Quasi-peak | Average |
| 0.15 - 0.5 | 66 - 56 | 56 - 46 |
| 0.50 - 5.0 | 56 | 46 |
| 5.0 - 30.0 | 60 | 50 |

Note:

1. The lower limit shall apply at the transition frequencies.
2. The limit decreases in line with the logarithm of the frequency in the range of 0.15 to 0.50 MHz.
3. All emanations from a class A/B digital device or system, including any network of conductors and apparatus connected thereto, shall not exceed the level of field strengths specified above.

4.2.2 Test Instruments

| Description & Manufacturer | Model No. | Serial No. | Date Of Calibration | Due Date Of Calibration |
|---|--------------------------|----------------|---------------------|-------------------------|
| Test Receiver ROHDE & SCHWARZ | ESCS 30 | 100288 | Aug. 17, 2017 | Aug. 16, 2018 |
| RF signal cable (with 10dB PAD) Woken | 5D-FB | Cable-cond2-01 | Sep. 08, 2017 | Sep. 07, 2018 |
| LISN/AMN ROHDE & SCHWARZ (EUT) | ESH2-Z5 | 100100 | Jan. 17, 2017 | Jan. 16, 2018 |
| LISN/AMN ROHDE & SCHWARZ (Peripheral) | ESH3-Z5 | 100312 | Aug. 02, 2017 | Aug. 01, 2018 |
| Software ADT | BV ADT_Cond_ V7.3.7.3 | NA | NA | NA |

- Note:
1. The calibration interval of the above test instruments is 12 months and the calibrations are traceable to NML/ROC and NIST/USA.
 2. The test was performed in HwaYa Shielded Room 2.
 3. The VCCI Site Registration No. is C-2047.

4.2.3 Test Procedures

- a. The EUT was placed 0.4 meters from the conducting wall of the shielded room with EUT being connected to the power mains through a line impedance stabilization network (LISN). Other support units were connected to the power mains through another LISN. The two LISNs provide 50 ohm/50 uH of coupling impedance for the measuring instrument.
- b. Both lines of the power mains connected to the EUT were checked for maximum conducted interference.
- c. The frequency range from 150 kHz to 30 MHz was searched. Emission levels under (Limit – 20 dB) was not recorded.

NOTE: The resolution bandwidth and video bandwidth of test receiver is 9 kHz for quasi-peak detection (QP) and average detection (AV) at frequency 0.15 MHz - 30 MHz.

4.2.4 Deviation from Test Standard

No deviation.

4.2.5 Test Setup

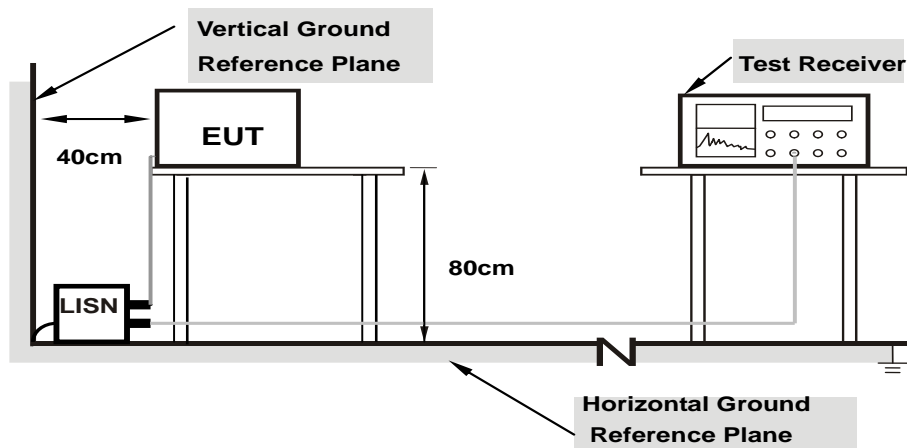

- Note:**
1. Support units were connected to second LISN.
 2. Both of LISNs (AMN) are 80 cm from EUT and at least 80 from other units and other metal planes

For the actual test configuration, please refer to the attached file (Test Setup Photo).

4.2.6 EUT Operating Conditions

- a. Placed the EUT on the testing table.
- b. Set the EUT under transmission condition continuously at specific channel frequency.

4.2.7 Test Results

| | | | |
|-----------------|----------------|--|--------------------------------------|
| Frequency Range | 150kHz ~ 30MHz | Detector Function & Resolution Bandwidth | Quasi-Peak (QP) / Average (AV), 9kHz |
| Input Power | 120Vac, 60Hz | Environmental Conditions | 25°C, 65%RH |
| Tested by | Getaz Yang | Test Date | 2017/12/8 |
| Test Mode | Mode 1 | | |

| Phase Of Power : Line (L) | | | | | | | | | | |
|---------------------------|-----------------|------------------------|----------------------|--------------|-----------------------|--------------|--------------|--------------|---------------|--------------|
| No | Frequency (MHz) | Correction Factor (dB) | Reading Value (dBuV) | | Emission Level (dBuV) | | Limit (dBuV) | | Margin (dB) | |
| | | | Q.P. | AV. | Q.P. | AV. | Q.P. | AV. | Q.P. | AV. |
| 1 | 0.34141 | 10.30 | 34.99 | 32.69 | 45.29 | 42.99 | 59.17 | 49.17 | -13.88 | -6.18 |
| 2 | 0.56797 | 10.33 | 35.09 | 30.99 | 45.42 | 41.32 | 56.00 | 46.00 | -10.58 | -4.68 |
| 3 | 0.79844 | 10.37 | 36.15 | 28.74 | 46.52 | 39.11 | 56.00 | 46.00 | -9.48 | -6.89 |
| 4 | 1.24609 | 10.40 | 34.33 | 25.63 | 44.73 | 36.03 | 56.00 | 46.00 | -11.27 | -9.97 |
| 5 | 1.70703 | 10.38 | 33.24 | 23.73 | 43.62 | 34.11 | 56.00 | 46.00 | -12.38 | -11.89 |
| 6 | 17.45313 | 10.71 | 31.17 | 16.53 | 41.88 | 27.24 | 60.00 | 50.00 | -18.12 | -22.76 |

Remarks:

1. Q.P. and AV. are abbreviations of quasi-peak and average individually.
2. The emission levels of other frequencies were very low against the limit.
3. Margin value = Emission level – Limit value
4. Correction factor = Insertion loss + Cable loss
5. Emission Level = Correction Factor + Reading Value

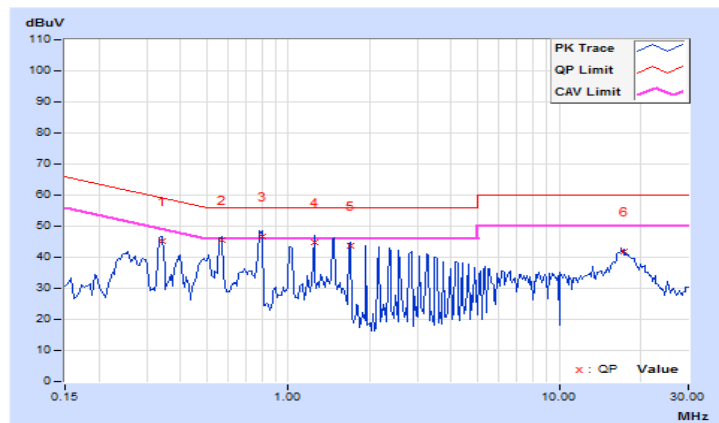

| | | | |
|-----------------|----------------|--|--------------------------------------|
| Frequency Range | 150kHz ~ 30MHz | Detector Function & Resolution Bandwidth | Quasi-Peak (QP) / Average (AV), 9kHz |
| Input Power | 120Vac, 60Hz | Environmental Conditions | 25°C, 65%RH |
| Tested by | Getaz Yang | Test Date | 2017/12/8 |
| Test Mode | Mode 1 | | |

| Phase Of Power : Neutral (N) | | | | | | | | | | |
|------------------------------|-----------------|------------------------|----------------------|-------|-----------------------|-------|--------------|-------|-------------|--------|
| No | Frequency (MHz) | Correction Factor (dB) | Reading Value (dBuV) | | Emission Level (dBuV) | | Limit (dBuV) | | Margin (dB) | |
| | | | Q.P. | AV. | Q.P. | AV. | Q.P. | AV. | Q.P. | AV. |
| 1 | 0.34141 | 10.29 | 33.27 | 20.30 | 43.56 | 30.59 | 59.17 | 49.17 | -15.61 | -18.58 |
| 2 | 0.56797 | 10.33 | 34.96 | 14.21 | 45.29 | 24.54 | 56.00 | 46.00 | -10.71 | -21.46 |
| 3 | 0.79844 | 10.33 | 34.59 | 10.79 | 44.92 | 21.12 | 56.00 | 46.00 | -11.08 | -24.88 |
| 4 | 0.99375 | 10.32 | 34.08 | 25.56 | 44.40 | 35.88 | 56.00 | 46.00 | -11.60 | -10.12 |
| 5 | 1.25781 | 10.35 | 34.74 | 14.41 | 45.09 | 24.76 | 56.00 | 46.00 | -10.91 | -21.24 |
| 6 | 18.62891 | 10.90 | 30.40 | 16.11 | 41.30 | 27.01 | 60.00 | 50.00 | -18.70 | -22.99 |

Remarks:

1. Q.P. and AV. are abbreviations of quasi-peak and average individually.
2. The emission levels of other frequencies were very low against the limit.
3. Margin value = Emission level – Limit value
4. Correction factor = Insertion loss + Cable loss
5. Emission Level = Correction Factor + Reading Value

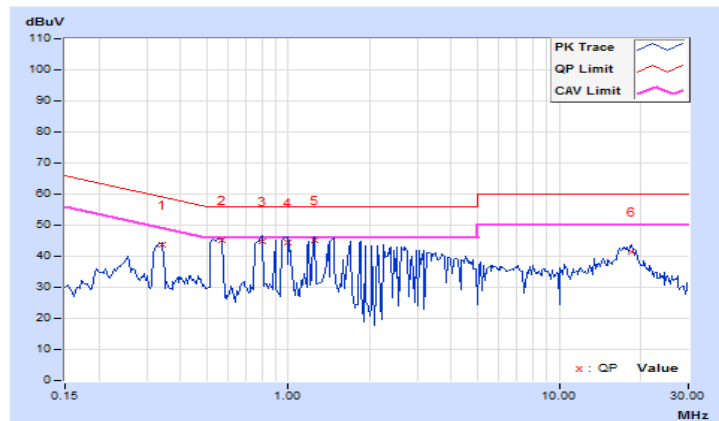

4.3 Frequency Stability

4.3.1 Limits of Frequency Stability Measurement

The frequency tolerance of the carrier signal shall be maintained within +/- 0.01 % of the operating frequency over a temperature variation of -20 degrees to 50 degrees C at normal supply voltage, and for a variation in the primary supply voltage from 85 % to 115% of the rated supply voltage at a temperature of 20 degrees C.

4.3.2 Test Setup

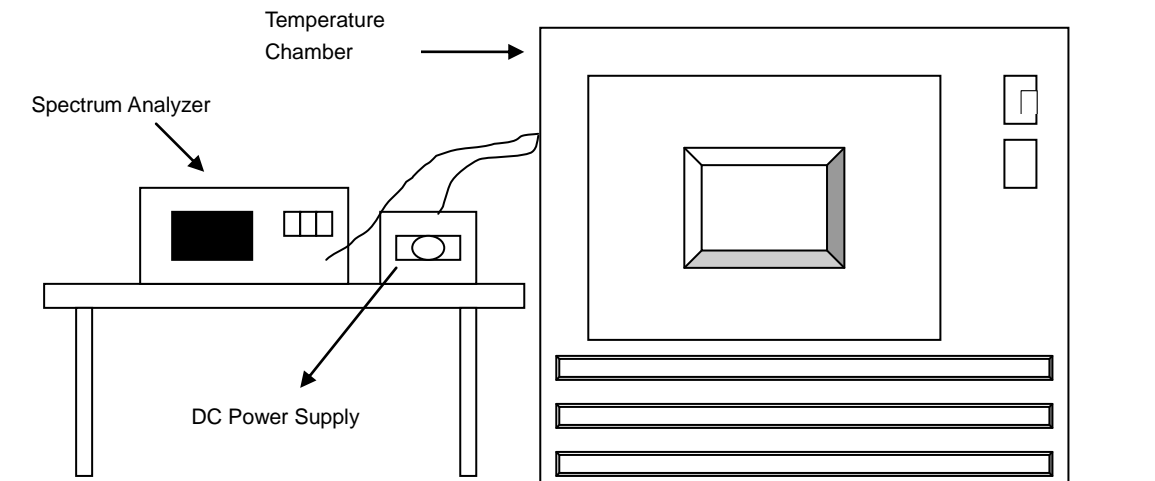

4.3.3 Test Instruments

Refer to section 4.1.2 to get information of above instrument.

4.3.4 Test Procedure

- The EUT was placed inside the environmental test chamber and powered by nominal DC voltage.
- Turned the EUT on and coupled its output to a spectrum analyzer.
- Turned the EUT off and set the chamber to the highest temperature specified.
- Allowed sufficient time (approximately 30 min) for the temperature of the chamber to stabilize then turned the EUT on and measured the operating frequency after 2, 5, and 10 minutes.
- Repeated step 2 and 3 with the temperature chamber set to the lowest temperature.
- The test chamber was allowed to stabilize at +20 degree C for a minimum of 30 minutes. The supply voltage was then adjusted on the EUT from 85 % to 115 % and the frequency record.

4.3.5 Deviation from Test Standard

No deviation.

4.3.6 EUT Operating Conditions

- Placed the EUT on the testing table.
- Set the EUT under transmission condition continuously at specific channel frequency.

4.3.7 Test Result

| Frequency Stability Versus Temperature | | | | | | | | | |
|--|--------------------------|-----------------------|--------------------|-----------------------|--------------------|-----------------------|--------------------|-----------------------|--------------------|
| Temp. (°C) | Power Supply (Vac) | 0 Minute | | 2 Minute | | 5 Minute | | 10 Minute | |
| | | Measured Frequency | Frequency Drift | Measured Frequency | Frequency Drift | Measured Frequency | Frequency Drift | Measured Frequency | Frequency Drift |
| | | (MHz) | % | (MHz) | % | (MHz) | % | (MHz) | % |
| 50 | 9 | 13.559951 | -0.00036 | 13.559954 | -0.00034 | 13.559954 | -0.00034 | 13.559941 | -0.00044 |
| 40 | 9 | 13.560013 | 0.00010 | 13.560013 | 0.00010 | 13.560016 | 0.00012 | 13.560024 | 0.00018 |
| 30 | 9 | 13.560002 | 0.00001 | 13.560001 | 0.00001 | 13.560012 | 0.00009 | 13.559988 | -0.00009 |
| 20 | 9 | 13.559993 | -0.00005 | 13.559985 | -0.00011 | 13.560013 | 0.00010 | 13.56001 | 0.00007 |
| 10 | 9 | 13.560062 | 0.00046 | 13.560042 | 0.00031 | 13.56004 | 0.00029 | 13.560045 | 0.00033 |
| 0 | 9 | 13.560024 | 0.00018 | 13.560027 | 0.00020 | 13.560031 | 0.00023 | 13.560027 | 0.00020 |
| -10 | 9 | 13.559957 | -0.00032 | 13.559954 | -0.00034 | 13.55995 | -0.00037 | 13.559956 | -0.00032 |
| -20 | 9 | 13.560027 | 0.00020 | 13.560027 | 0.00020 | 13.560028 | 0.00021 | 13.560025 | 0.00018 |
| -30 | 9 | 13.559971 | -0.00021 | 13.559972 | -0.00021 | 13.559963 | -0.00027 | 13.559964 | -0.00027 |

| Frequency Stability Versus Voltage | | | | | | | | | |
|------------------------------------|--------------------------|-----------------------|--------------------|-----------------------|--------------------|-----------------------|--------------------|-----------------------|--------------------|
| Temp. (°C) | Power Supply (Vac) | 0 Minute | | 2 Minute | | 5 Minute | | 10 Minute | |
| | | Measured Frequency | Frequency Drift | Measured Frequency | Frequency Drift | Measured Frequency | Frequency Drift | Measured Frequency | Frequency Drift |
| | | (MHz) | % | (MHz) | % | (MHz) | % | (MHz) | % |
| 20 | 12 | 13.559991 | -0.00007 | 13.559988 | -0.00009 | 13.56001 | 0.00007 | 13.560008 | 0.00006 |
| | 9 | 13.559993 | -0.00005 | 13.559985 | -0.00011 | 13.560013 | 0.00010 | 13.56001 | 0.00007 |
| | 5 | 13.559995 | -0.00004 | 13.55999 | -0.00007 | 13.56001 | 0.00007 | 13.560011 | 0.00008 |

4.4 20 dB Bandwidth

4.4.1 Limits of 20 dB Bandwidth Measurement

The 20 dB bandwidth shall be specified in operating frequency band.

4.4.2 Test Setup

Refer to section 4.1.5.

4.4.3 Test Instruments

Refer to section 4.1.2 to get information of above instrument.

4.4.4 Test Procedures

The bandwidth of the fundamental frequency was measured by spectrum analyzer with 1 kHz RBW and 3 kHz VBW. The 20 dB bandwidth is defined as the total spectrum the power of which is higher than peak power minus 20 dB.

4.4.5 Deviation from Test Standard

No deviation.

4.4.6 EUT Operating Conditions

- a. Placed the EUT on the testing table.
- b. Set the EUT under transmission condition continuously at specific channel frequency.

4.4.7 Test Results

| 20 dBc Point (Low) | 20 dBc Point (High) | Operating Frequency Band (MHz) | Pass / Fail |
|--------------------|---------------------|--------------------------------|-------------|
| 13.558974359 MHz | 13.561538462 MHz | 13.553~13.567 | Pass |

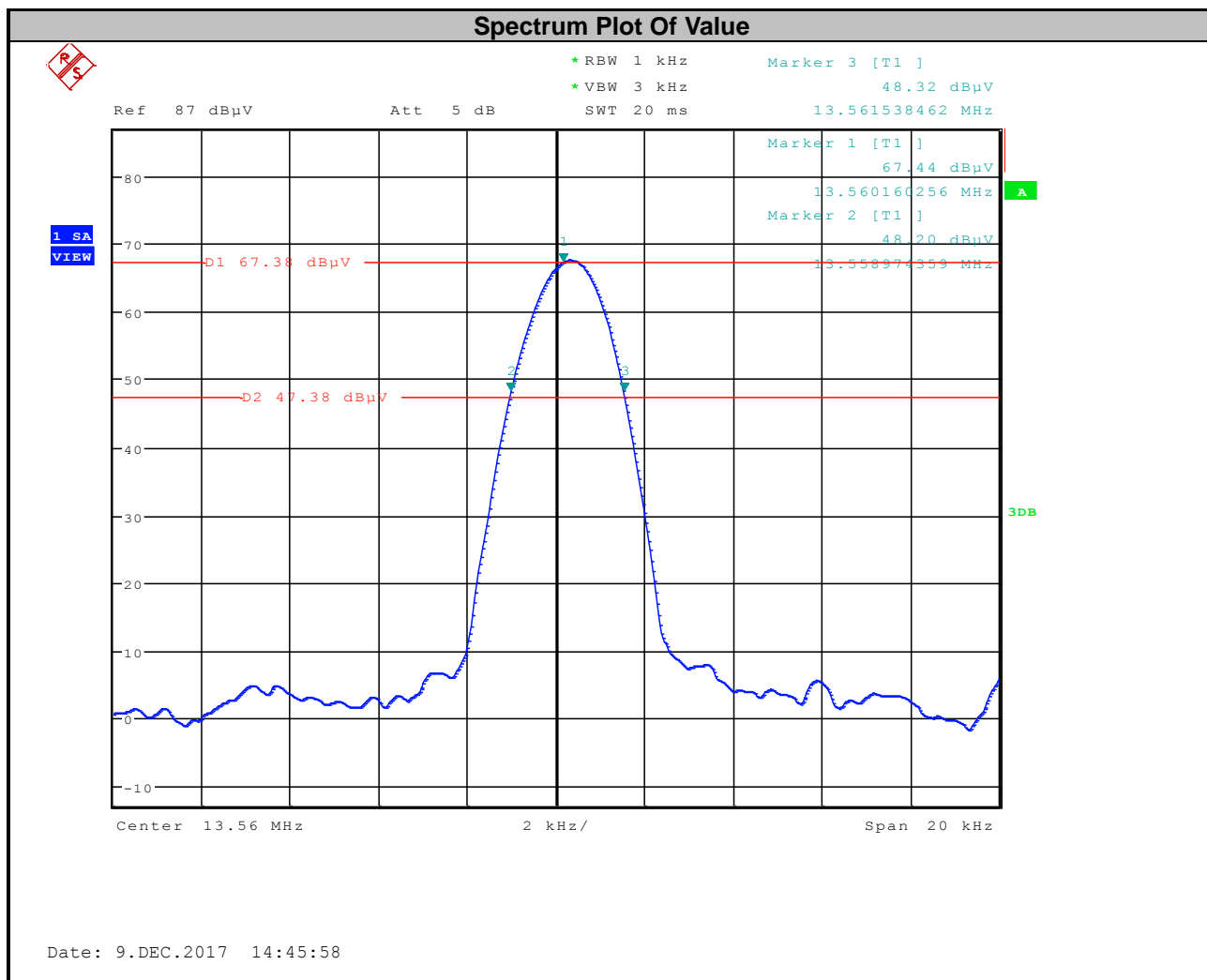

5 Pictures of Test Arrangements

Please refer to the attached file (Test Setup Photo).

Appendix – Information on the Testing Laboratories

We, Bureau Veritas Consumer Products Services (H.K.) Ltd., Taoyuan Branch, were founded in 1988 to provide our best service in EMC, Radio, Telecom and Safety consultation. Our laboratories are FCC recognized accredited test firms and accredited according to ISO/IEC 17025.

If you have any comments, please feel free to contact us at the following:

Linko EMC/RF Lab

Tel: 886-2-26052180

Fax: 886-2-26051924

Hsin Chu EMC/RF/Telecom Lab

Tel: 886-3-6668565

Fax: 886-3-6668323

Hwa Ya EMC/RF/Safety

Tel: 886-3-3183232

Fax: 886-3-3270892

Email: service.adt@tw.bureauveritas.com

Web Site: www.bureauveritas-adt.com

The address and road map of all our labs can be found in our web site also.

--- END ---