

SPECIFICATION

Customer : 寶德科技股份有限公司

Maker's P/N : AN3216-245

Description: LTCC 天線2.45G / 3.2*1.6*0.9mm

Customer's P/N : F28-6500-029001

Date : JUN / 6 / 2022

Approved



虹陞 科 技 有 限 公 司

SURTEK CO., LTD.

302-042新竹縣竹北市福興東路一段293號

TEL: 886-3-667-3999

FAX: 886-3-667-2538

E-Mail : surtek.corp@msa.hinet.net

<http://www.surtek.biz>

AN3216

Multilayer Chip Antenna for 2.4GHz Wireless Communication

AN3216 Multilayer Chip Antenna

◆ Features

- Light weight and low profile
- 3.2mm(L)X1.6mm(W)X0.9mm(H)
- Omni-directional in azimuth
- Lead (Pb) Free

◆ Applications

- 2.4GHz wireless communications
- 2.4GHz Modules
- Bluetooth System
- 802.11b/g Wireless LAN System

Specifications

Center frequency	2.45GHz
Peak gain	0.5dBi (typ.)
Operation temperature	-40 ~ +85 °C
Storage temperature	-40 ~ +85 °C
VSWR	2.5 (Max)
Input Impedance	50 Ohm
Power handling	1W (Max)
Bandwidth	110MHz (typ.)
Azimuth beamwidth	Omni-directional
Polarization	Linear
Soldering pad	Natural tin

Pin configuration

Top view

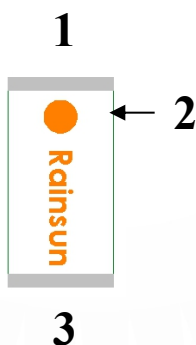

Pin No	Pin assignment
1	Feed termination
2	Feed point mark
3	Solder termination

Dimensions

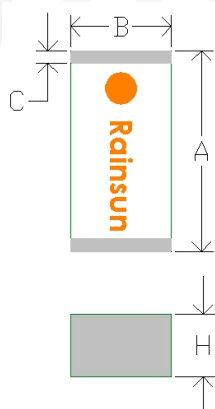

Symbol	Dimensions(mm)
A	3.20 ± 0.10
B	1.60 ± 0.10
C	0.30 ± 0.05
H	0.9 ± 0.20

PCB Foot Print

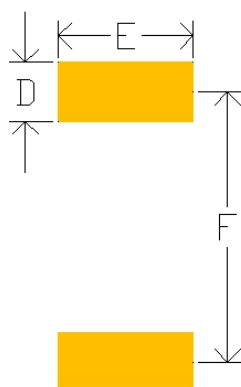

Symbol	Dimensions(mm)
D	0.7
E	1.6
F	3.2

Recommended Test Board Pattern

Top view

Bottom view

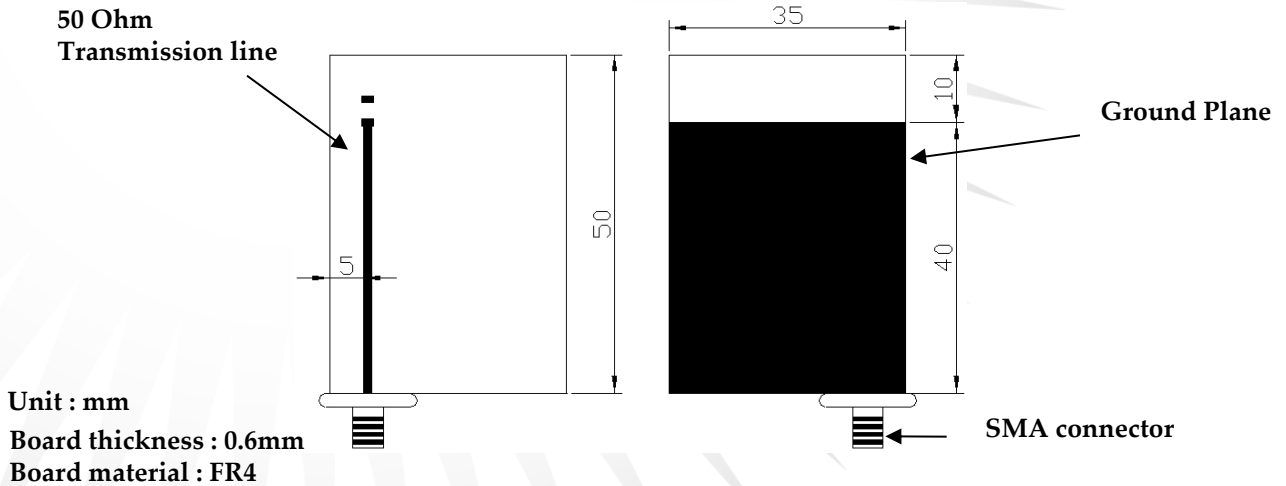
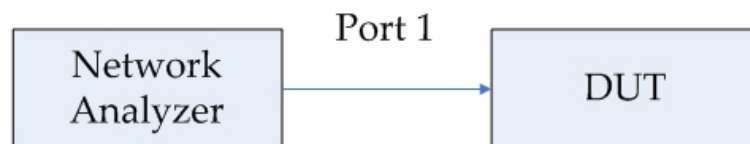

Fig-1

Testing Setup



Measurement



Testing Instrument:

Anritsu 37369C VNA(Vector Network Analyzer)

VNA calibrate with 1 path reflection only calibration sequence on test board feed point.

The test board dimension and it's layout is the same as Fig-1.

Typical Electrical Characteristics

Return loss

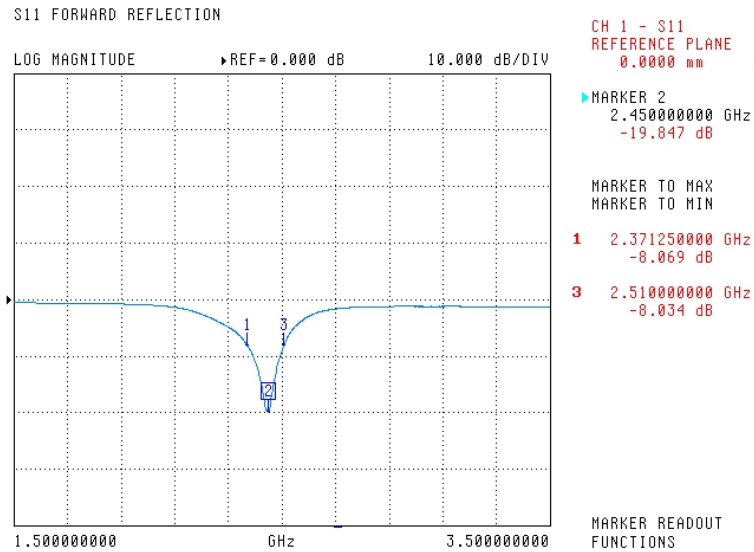

Smith Chart

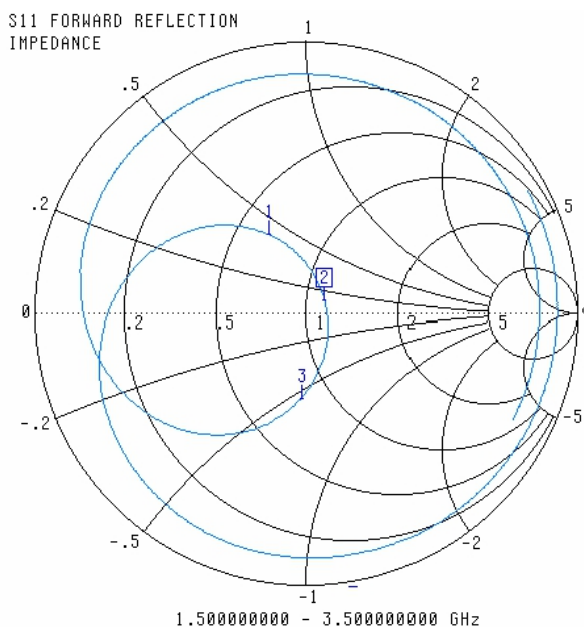

Marker data:

- 1 : f=2.411 GHz
- 2 : f=2.450 GHz
- 3 : f=2.492 GHz

Typical Radiation Patterns

**2.45 GHz H-Plane
vertical**

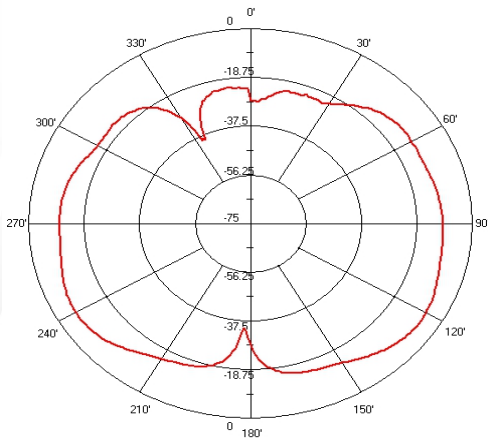

**2.45 GHz H-Plane
horizontal**

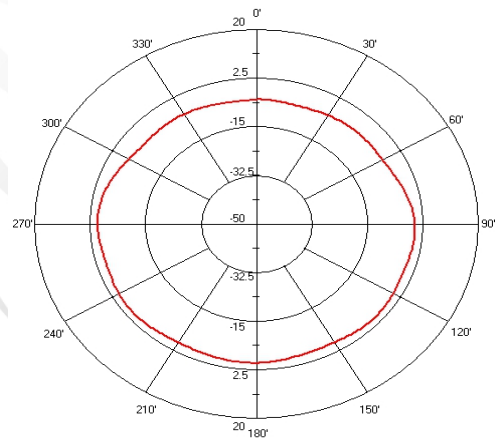

**2.45 GHz E-Plane
vertical**

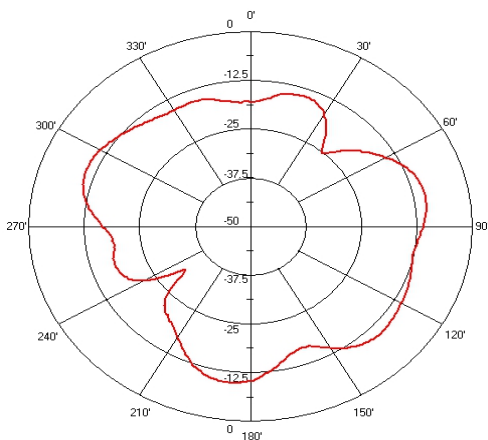

**2.45 GHz E-Plane
horizontal**

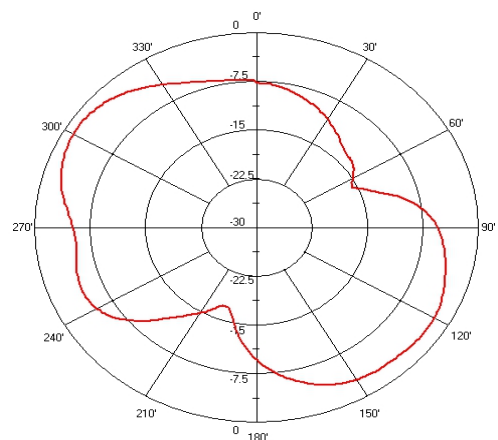

Typical Soldering Profile for Lead-free Process

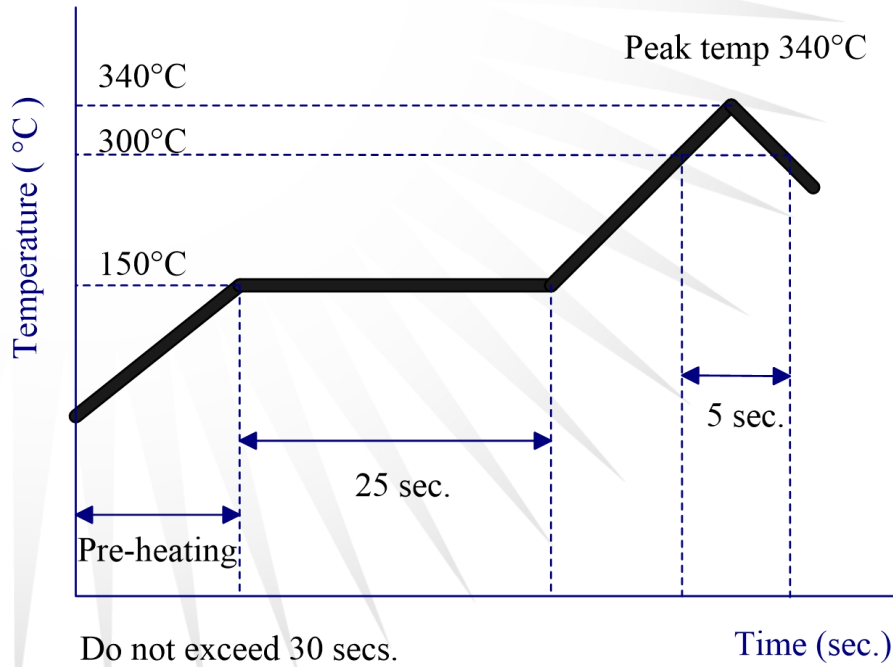

Reflow Soldering

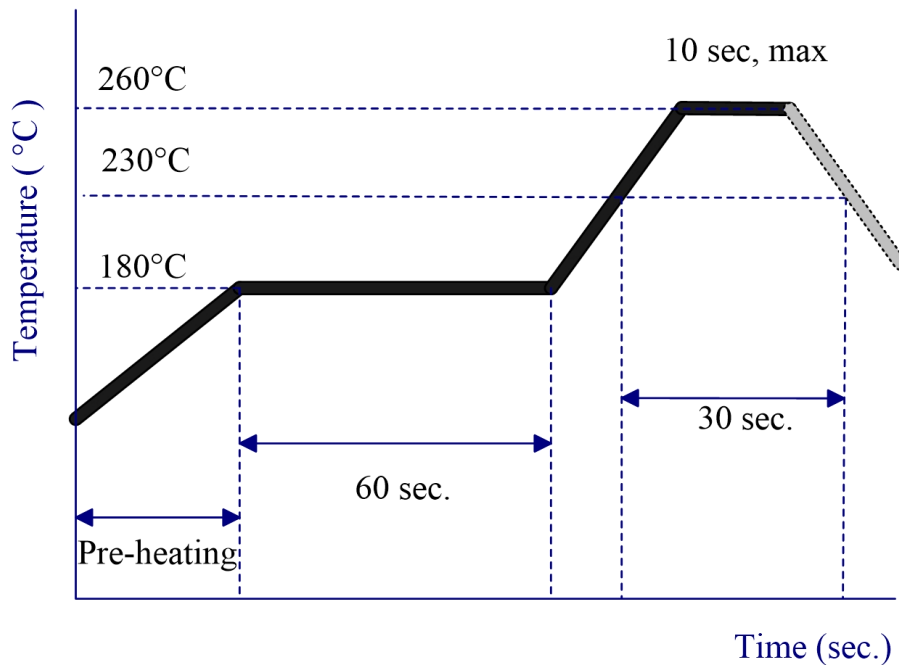

Application example

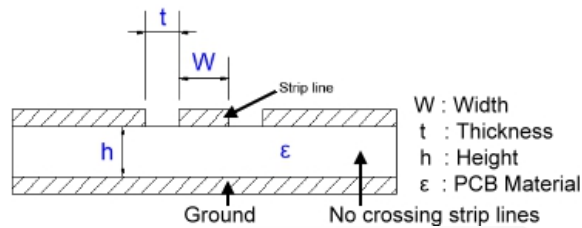
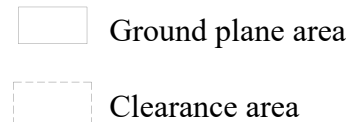
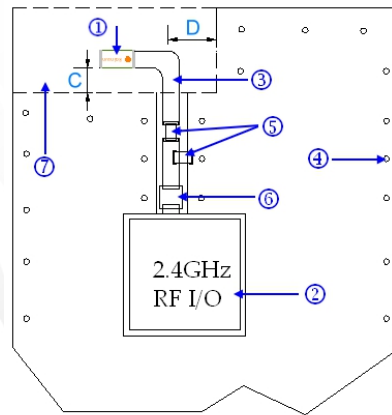
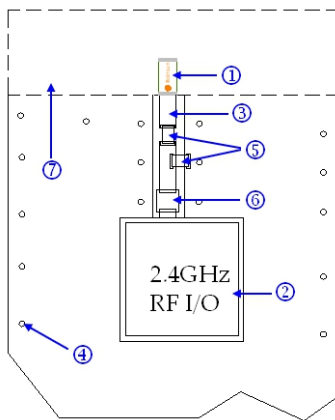

Fig.2

Best Choice

Acceptable



1. Placement of the antenna

The antenna shall be placed on a area without underlying ground plane at the edge of the PCB oriented as above. Ground plane area surrounding the antenna should be with minimum clearance 3mm.

2. Placement of 2.4 GHz module

To avoid losses in the strip line, the module shall be placed as close to the antenna as possible.

3. Strip line

The strip line impedance must be dimensioned according to your specific PCB (see fig.2) to 50 Ohm. No crossing strip lines are allowed between the strip line and its ground plane.

4. Via Connections on PCB

To avoid spurious effects via connections must be made to analogue ground. Via connection depends on PCB layout design. Figure 2 for reference only.

5. Component matching

Component values are depending on antenna placement, PCB dimensions and location of other components. PCB dimension and antenna location will effect the antenna frequency.

6. DC Block

It might be needed depending on RF Module or chip hardware design.

7. Clearance

No components allowed within the clearence area with a minimum distance to other components. The minimum distance is 3mm.

Packing

Blister Tape Specifications

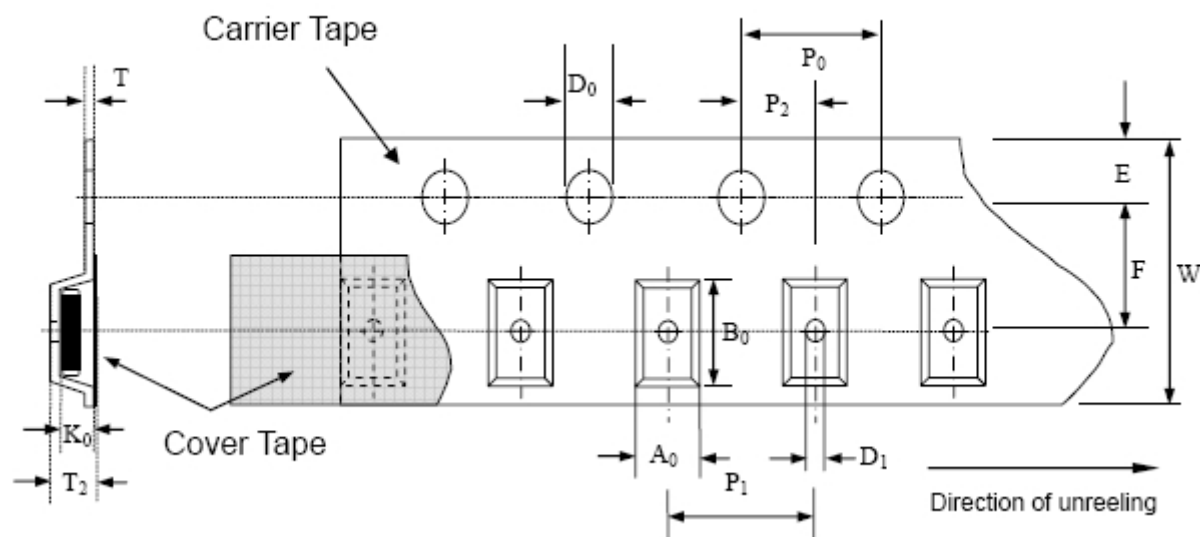

Symbol	Dimension	Tolerance	Unit
W	8.00	± 0.10	mm
E	1.75	± 0.10	mm
F	3.50	± 0.05	mm
D ₀	1.55	± 0.05	mm
D ₁	1.10	± 0.10	mm
P ₀	4.00	± 0.10	mm
P ₁	4.00	± 0.10	mm
P ₂	2.00	± 0.05	mm
A ₀	1.94	± 0.10	mm
B ₀	3.53	± 0.10	mm
K ₀	1.42	± 0.05	mm
T	0.23	± 0.01	mm
T ₂	>0.05	± 0.01	mm
10 × P ₀	40.00	± 0.20	mm

Reel Specifications

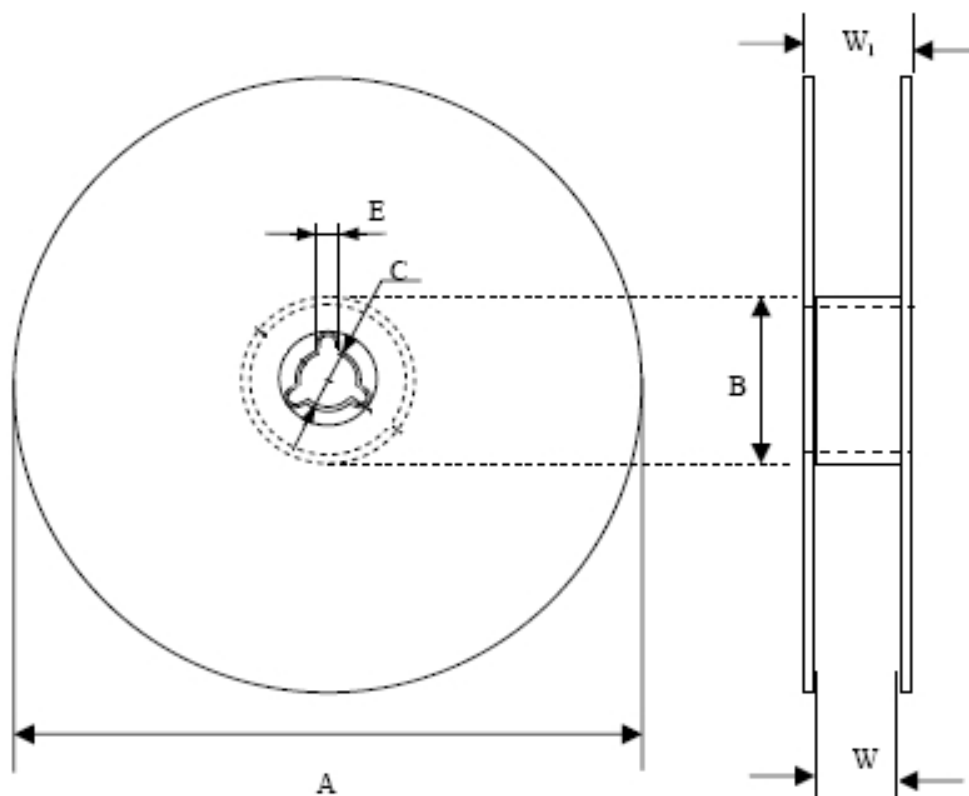

Quantity Per Reel	Tape Width (mm)	A (mm)	C (mm)	B (mm)	E (mm)	W (mm)	W ₁ (mm)
3,000	8	178±1	13±0.2	60±0.5	2.2±0.5	9±0.5	12±0.05

Tape Specifications

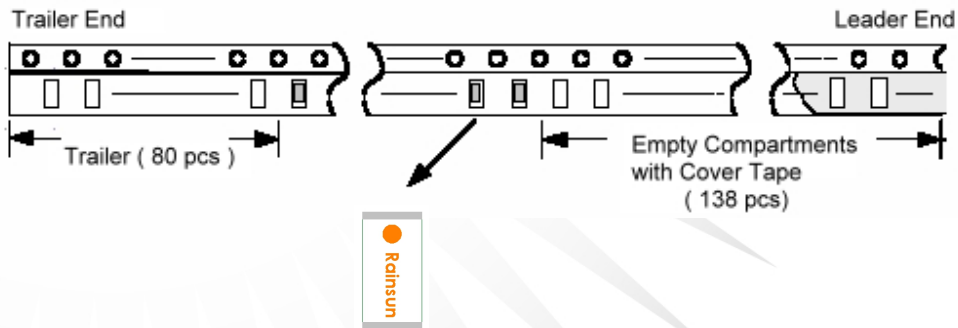

Tape Peel Strength

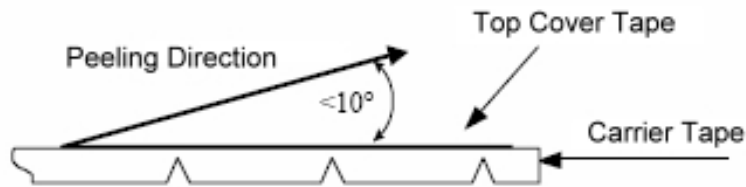

Peel-off force should be in the range of 0.1~0.6 N at a peel-off speed of 300 ± 10 mm/min.

Storage Conditions

- (1) Temperature : 15 to 35°C , Relative Humidity (RH) : 45 to 75%.
- (2) Non-corrosive environment.