

# FCC Test Report

**EQUIPMENT** : Notebook  
**BRAND NAME** : MSI  
**MODEL NAME** : MS-N031, U120H(W/3.5G), U120(W/O3.5G)  
**FCC ID** : I4L-N-NE771  
**STANDARD** : FCC Part 15 Subpart C §15.247  
**CLASSIFICATION** : Digital Transmission System (DTS)  
**APPLICANT** : MICRO-STAR INT'L CO., LTD.

No. 69, Lide St, Jhonghe City, Taipei County 235, Taiwan

The product sample received on Nov. 14, 2008 and completely tested on Nov. 26, 2008. We, SPORTON INTERNATIONAL INC., would like to declare that the tested sample has been evaluated in accordance with the procedures given in ANSI C63.4-2003 and shown the compliance with the applicable technical standards.

The test results in this report apply exclusively to the tested model / sample. Without written approval of SPORTON INTERNATIONAL INC., the test report shall not be reproduced except in full.



Reviewed by: Roy Wu / Manager



**SPORTON INTERNATIONAL INC.**

No. 52, Hwa Ya 1<sup>st</sup> Rd., Hwa Ya Technology Park, Kwei-Shan Hsiang, Tao Yuan Hsien, Taiwan, R.O.C.



## TABLE OF CONTENTS

**SUMMARY OF TEST RESULT ..... 3**

**REVISION HISTORY..... 4**

**1 GENERAL DESCRIPTION ..... 5**

    1.1 Applicant ..... 5

    1.2 Manufacturer..... 5

    1.3 Feature of Equipment Under Test ..... 5

    1.4 Testing Site..... 7

    1.5 Applied Standards ..... 7

    1.6 Ancillary Equipment List ..... 7

**2 TEST CONFIGURATION OF EQUIPMENT UNDER TEST ..... 8**

    2.1 Pre-Scanned RF Power..... 8

    2.2 Test Mode..... 9

    2.3 Connection Diagram of Test System..... 10

    2.4 RF Utility ..... 11

**3 TEST RESULT..... 12**

    3.1 6dB Bandwidth Measurement ..... 12

    3.2 Output Power Measurement..... 21

    3.3 Band Edges Measurement ..... 24

    3.4 Power Spectral Density Measurement ..... 33

    3.5 AC Conducted Emission Measurement..... 42

    3.6 Radiated Emission Measurement..... 46

    3.7 Antenna Requirements..... 80

**4 LIST OF MEASURING EQUIPMENTS ..... 81**

**5 UNCERTAINTY OF EVALUATION ..... 82**

**6 CERTIFICATION OF TAF ACCREDITATION ..... 84**

**APPENDIX A. PHOTOGRAPHS OF EUT**

**APPENDIX B. SETUP PHOTOGRAPHS**



### SUMMARY OF TEST RESULT

Report Section	FCC Rule	IC Rule	Description	Limit	Result	Remark
3.1	15.247(a)(2)	A8.2(a)	6dB Bandwidth	$\geq 0.5\text{MHz}$	Pass	-
3.2	15.247(b)	A8.4	Power Output	$\leq 30\text{dBm}$	Pass	-
3.3	15.247(d)	A8.5	Frequency Band Edges	$\leq 20\text{dBc}$	Pass	-
3.4	15.247(e)	A8.2(b)	Power Spectral Density	$\leq 8\text{dBm}$	Pass	-
3.5	15.207	Gen 7.2.2	AC Conducted Emission	15.207(a)	Pass	Under limit 10.50 dB at 0.334 MHz
3.6	15.247(d)	A8.5	Transmitter Radiated Emission	15.209(a) & 15.247(d)	Pass	Under limit 5.84 dB at 798.40 MHz
3.7	15.203 & 15.247(b)	A8.4	Antenna Requirement	N/A	Pass	-



### REVISION HISTORY

REPORT NO.	VERSION	DESCRIPTION	ISSUED DATE
FR8N1310-01	Rev. 01	Initial issue of report	Dec. 08, 2008

# 1 General Description

## 1.1 Applicant

**MICRO-STAR INT'L CO., LTD.**

No. 69, Lide St, Jhonghe City, Taipei County 235, Taiwan

## 1.2 Manufacturer

**MICRO-STAR INT'L CO., LTD.**

No. 69, Lide St, Jhonghe City, Taipei County 235, Taiwan

## 1.3 Feature of Equipment Under Test

Product Feature & Specification	
<b>Equipment</b>	Notebook
<b>Brand Name</b>	MSI
<b>Model Name</b>	MS-N031, U120H(W/3.5G), U120(W/O3.5G)
<b>WLAN Module</b>	TWINHAN, AW-NE771H
<b>Tx/Rx Frequency Range</b>	2400 MHz ~ 2483.5 MHz
<b>Number of Channels</b>	11
<b>Carrier Frequency of Each Channel</b>	2412+(n-1)*5 MHz; n=1~11
<b>Channel Spacing</b>	5 MHz
<b>Maximum Output Power to Antenna</b>	802.11b : 16.42 dBm 802.11g : 16.96 dBm 802.11n(20M) : 16.32 dBm 802.11n(40M) : 17.15 dBm
<b>Antenna Type</b>	PCB Antenna with gain -4.4 dBi
<b>HW Version</b>	1.3
<b>SW Version</b>	10B
<b>Type of Modulation</b>	802.11b : DSSS (BPSK / QPSK / CCK) ; 802.11g : OFDM (BPSK / QPSK / 16QAM / 64QAM) 802.11n (20M) / 802.11n (40M) : OFDM
<b>EUT Stage</b>	Identical Prototype

Accessories List:

Accessories Specification		
AC Adapter 1	Brand Name	LI SHIN
	Model Name	0225A2040
	Power Rating	I/P:100-240Vac, 1.7A; O/P: 20Vdc, 2A
	AC Power Cord Type	1.82 meter non-shielded cable without ferrite core
AC Adapter 2	Brand Name	DELTA
	Model Name	ADP-40MH BDB
	Power Rating	I/P:100-240Vac, 1.2A; O/P: 20Vdc, 2A
	AC Power Cord Type	1.9 meter shielded cable with ferrite core
Battery 1	Brand Name	MITAC 6cells
	Model Name	BTY-S12
	Power Rating	11.1Vdc, 4400mAh
	Type	Li-ion
Battery 2	Brand Name	STL 6cells
	Model Name	BTY-S12
	Power Rating	11.1Vdc, 5200mAh
	Type	Li-ion
Battery 3	Brand Name	MITAC 3cells
	Model Name	BTY-S11
	Power Rating	11.1Vdc, 2200mAh
	Type	Li-ion
Battery 4	Brand Name	STL 3cells
	Model Name	BTY-S11
	Power Rating	11.1Vdc, 2200mAh
	Type	Li-ion
Battery 5	Brand Name	WellTop 3cell
	Model Name	BTY-S11
	Power Rating	11.1Vdc, 2200mAh
	Type	Li-ion
LCD Panel 1	Brand Name	Hannstar
	Model Name	HSD100IFW1
LCD Panel 2	Brand Name	CPT
	Model Name	CLAA102NA0ACW
Camera 1	Brand Name	Bison
	Model Name	BN29VDG8-000
Camera 2	Brand Name	CHICONY
	Model Name	CNF72312004442L

Remark:

1. The above EUT's information was declared by manufacturer. Please refer to the specifications or user's manual for more detailed description.
2. This test report recorded only product characteristics and test results of Digital Transmission System (DTS).
3. For accessories equipped with this EUT, please refer to the appendix of the external photo.
4. For other wireless features of this EUT, test report will be issued separately.

## 1.4 Testing Site

<b>Test Site</b>	SPORTON INTERNATIONAL INC.		
<b>Test Site Location</b>	No. 52, Hwa Ya 1 <sup>st</sup> Rd., Hwa Ya Technology Park, Kwei-Shan Hsiang, Tao Yuan Hsien, Taiwan, R.O.C TEL: +886-3-3273456 / FAX: +886-3-3284978		
<b>Test Site No.</b>	<b>Sporton Site No.</b>		<b>FCC/IC Registration No.</b>
	CO05-HY	03CH06-HY	TW1022/4086B-1

## 1.5 Applied Standards

According to the specifications of the manufacturer, the EUT must comply with the requirements of the following standards:

- ♦ FCC Part 15 Subpart C §15.247
- ♦ FCC KDB Publication No. 558074 (Measurement Guidelines of DTS)
- ♦ ANSI C63.4-2003
- ♦ IC RSS-210 Issue 7

### Remark:

1. All test items were verified and recorded according to the standards and without any deviation during the test.
2. This EUT has also been tested and complied with the requirements of FCC Part 15, Subpart B (DoC), recorded in a separate test report.

## 1.6 Ancillary Equipment List

Item	Equipment	Trade Name	Model Name	FCC ID	Data Cable	Power Cord
1.	WLAN AP	SMC	SMC-100	HEDWG4005ACC	N/A	Unshielded, 1.8 m
2.	WLAN AP	D-Link	DWL-7100AP	KA22003040018-1	N/A	Unshielded, 1.8 m
3.	Earphone + Mic	Sampo	EK-Y652CS	FCC DoC	Shielded, 1.8 m	N/A
4.	LCD MONITOR	lenovo	6135-AB1	FCC DoC	Shielded, 1.6 m	Unshielded, 1.8 m
5.	i-Pod	Apple	A1199	FCC DoC	Shielded, 1.0 m	N/A

## 2 Test Configuration of Equipment Under Test

### 2.1 Pre-Scanned RF Power

Preliminary tests were performed in different data rate and recorded the RF power output in the following table:

#### 802.11b

Channel	Frequency (MHz)	RF Power (dBm)			
		2.4GHz 802.11b Data Rate			
		1 Mbps	2 Mbps	5.5 Mbps	11 Mbps
CH 01	2412 MHz	14.55	14.69	16.16	16.42
CH 06	2437 MHz	14.40	14.55	16.03	16.21
CH 11	2462 MHz	14.24	14.45	15.95	16.02

#### 802.11g

Channel	Frequency (MHz)	RF Power (dBm)							
		2.4GHz 802.11g Data Rate							
		6 Mbps	9 Mbps	12 Mbps	18 Mbps	24 Mbps	36 Mbps	48 Mbps	54 Mbps
CH 01	2412 MHz	16.42	16.66	16.35	16.01	16.35	16.39	16.37	16.96
CH 06	2437 MHz	15.99	15.93	15.43	15.47	16.19	15.81	16.23	16.23
CH 11	2462 MHz	16.30	16.24	16.30	16.22	16.50	16.00	16.52	16.52

#### 802.11n (20M)

Channel	Frequency (MHz)	RF Power (dBm)							
		2.4GHz 802.11n(20M) Data Rate							
		6.5 Mbps	13 Mbps	19.5 Mbps	26 Mbps	39 Mbps	52 Mbps	58.5 Mbps	65 Mbps
CH 01	2412 MHz	16.32	15.99	15.76	16.20	15.82	16.23	16.15	16.30
CH 06	2437 MHz	15.93	15.71	15.65	16.18	15.94	16.21	15.89	15.82
CH 11	2462 MHz	16.13	16.07	16.07	16.31	16.21	16.07	15.89	15.99





802.11n (40M)

Channel	Frequency (MHz)	RF Power (dBm)							
		2.4GHz 802.11n(40M) Data Rate							
		13.5 Mbps	27 Mbps	40.5 Mbps	54 Mbps	81 Mbps	108 Mbps	121.5 Mbps	135 Mbps
CH 01	2412 MHz	16.62	16.13	16.14	16.50	16.35	16.36	16.45	16.29
CH 06	2437 MHz	17.15	16.64	16.52	16.74	16.75	16.84	16.95	16.90
CH 11	2462 MHz	16.81	16.59	16.39	16.54	16.53	16.64	16.69	16.39

Remark:

1. The 802.11b data rates were set in 11 Mbps, 802.11g data rates were set in 54 Mbps, 802.11n (20M) data rates were set in 6.5 Mbps and 802.11n (40M) data rates were set in 13.5 Mbps for all the test cases, due to the highest RF output power.
2. The EUT is programmed to transmit signal continuously for all testing.

2.2 Test Mode

The EUT has been associated with peripherals pursuant to ANSI C63.4-2003 and configuration operated in a manner tended to maximize its emission characteristics in a typical application. Frequency range investigated: conducted emission (150 kHz to 30 MHz), radiated emission (30 MHz to the 10th harmonic of the highest fundamental frequency or to 40 GHz, whichever is lower). Pre-scanned tests were conducted to determine the final configuration from all possible combinations. The following tables are showing the test modes as the worst cases and recorded in this report.

Test Cases				
Test Item	Modulation			
	802.11b DSSS	802.11g OFDM	802.11n (20M) OFDM	802.11n (40M) OFDM
Conducted TCs	Mode1: CH01_2412 MHz Mode2: CH06_2437 MHz Mode3: CH11_2462 MHz	Mode4: CH01_2412 MHz Mode5: CH06_2437 MHz Mode6: CH11_2462 MHz	Mode7: CH01_2412 MHz Mode8: CH06_2437 MHz Mode9: CH11_2462 MHz	Mode10: CH03_2422 MHz Mode11: CH06_2437 MHz Mode12: CH09_2452 MHz
Radiated TCs	Mode1: CH01_2412 MHz Mode2: CH06_2437 MHz Mode3: CH11_2462 MHz	Mode4: CH01_2412 MHz Mode5: CH11_2462 MHz	Mode6: CH01_2412 MHz Mode7: CH11_2462 MHz	Mode8: CH03_2422 MHz Mode9: CH06_2437 MHz Mode10: CH9_2452 MHz
AC Conducted Emission	Mode 1 : WLAN Link + Adapter			

- Remark: 1 For radiation emission Mode 4, 5, 6, and 7, only band edge was verified.  
 2 From the QuieTek FCC Part 15B Report No. 08A068R-ITUSP01V02, the worst configurations is DUT with Adapter 2, Battery 4, LCD Panel 1 and Camera 1 which were used for above test modes.

### 2.3 Connection Diagram of Test System

<Conducted Emission>

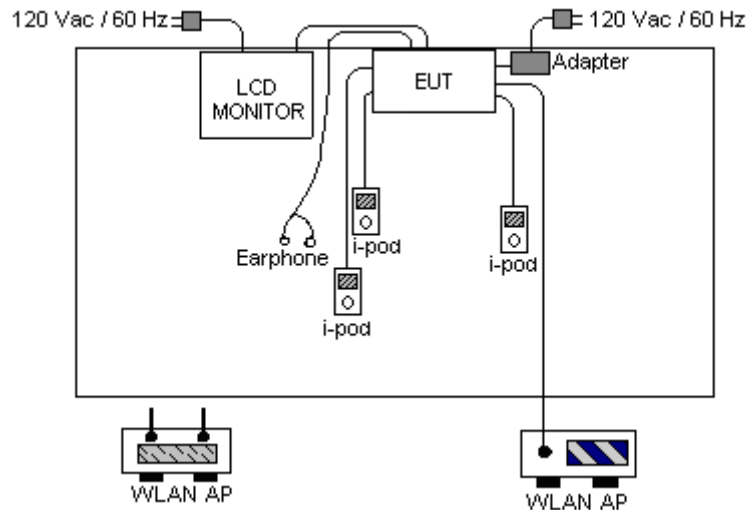

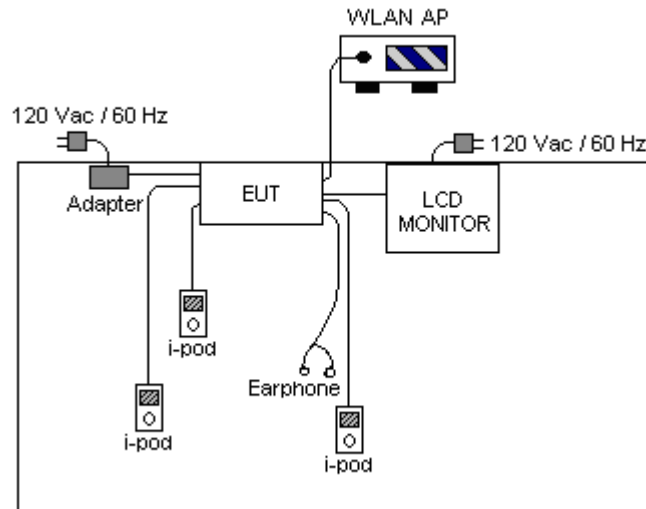
**<Radiated Emission>****2.4 RF Utility**

The programmed RF Utility "art" is installed in EUT to provide channel selection, power level, data rate and the application type. RF Utility can send transmitting signal for all testing. The RF output power selection is for the setting of RF output power expected by the customer and is going to be fixed on the firmware of the final end product.

### 3 Test Result

#### 3.1 6dB Bandwidth Measurement

##### 3.1.1 Limit of 6dB Bandwidth

The minimum 6 dB bandwidth shall be at least 500 kHz.

##### 3.1.2 Measuring Instruments

See list of measuring instruments of this test report.

##### 3.1.3 Test Procedures

1. The testing follows FCC KDB Publication No. 558074 (Measurement Guidelines of DTS).
2. The RF output of EUT was connected to the spectrum analyzer by a low loss cable.
3. Make the measurement with the spectrum analyzer's resolution bandwidth (RBW) = 100 kHz.  
In order to make an accurate measurement, set the span greater than RBW. The 6 dB bandwidth must be greater than 500 kHz.
4. The marker-delta reading at this point is the 6 dB bandwidth of the emission.

##### 3.1.4 Test Setup

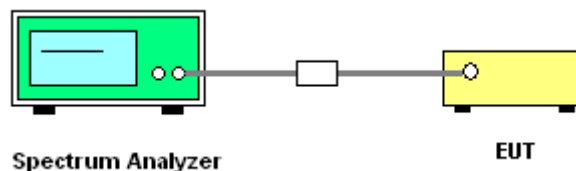



3.1.5 Test Result of 6dB Bandwidth

Test Mode :	Mode 1,2, and 3	Temperature :	24~25
Test Engineer :	Ken Hsu	Relative Humidity :	42~44%

Channel	Frequency (MHz)	6dB Bandwidth (MHz)	6dB Bandwidth Min. Limit (MHz)	Pass/Fail
01	2412	12.20	0.5	Pass
06	2437	12.16	0.5	Pass
11	2462	12.20	0.5	Pass

Test Mode :	Mode 4, 5, and 6	Temperature :	24~25
Test Engineer :	Ken Hsu	Relative Humidity :	42~44%

Channel	Frequency (MHz)	6dB Bandwidth (MHz)	6dB Bandwidth Min. Limit (MHz)	Pass/Fail
01	2412	16.52	0.5	Pass
06	2437	16.52	0.5	Pass
11	2462	16.52	0.5	Pass



<b>Test Mode :</b>	Mode 7, 8, and 9	<b>Temperature :</b>	24~25
<b>Test Engineer :</b>	Ken Hsu	<b>Relative Humidity :</b>	42~44%

Channel	Frequency (MHz)	6dB Bandwidth (MHz)	6dB Bandwidth Min. Limit (MHz)	Pass/Fail
01	2412	17.64	0.5	Pass
06	2437	17.64	0.5	Pass
11	2462	17.60	0.5	Pass

<b>Test Mode :</b>	Mode 10, 11, and 12	<b>Temperature :</b>	24~25
<b>Test Engineer :</b>	Ken Hsu	<b>Relative Humidity :</b>	42~44%

Channel	Frequency (MHz)	6dB Bandwidth (MHz)	6dB Bandwidth Min. Limit (MHz)	Pass/Fail
03	2422	35.76	0.5	Pass
06	2437	36.08	0.5	Pass
09	2452	36.08	0.5	Pass



### 3.1.6 Test Result of 6dB Bandwidth Plots

#### Mode 1 : 6 dB Bandwidth Plot on 802.11b Channel 01

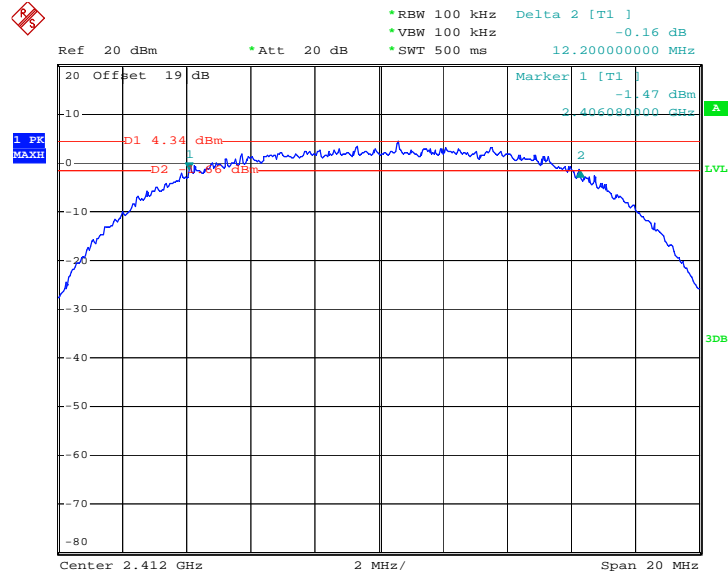

Date: 21.NOV.2008 17:02:13

#### Mode 2 : 6 dB Bandwidth Plot on 802.11b Channel 06

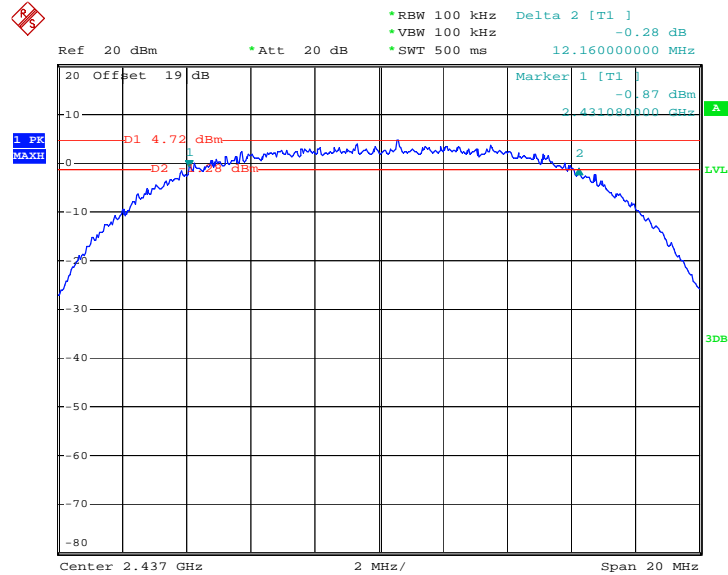

Date: 21.NOV.2008 17:02:59



Mode 3 : 6 dB Bandwidth Plot on 802.11b Channel 11

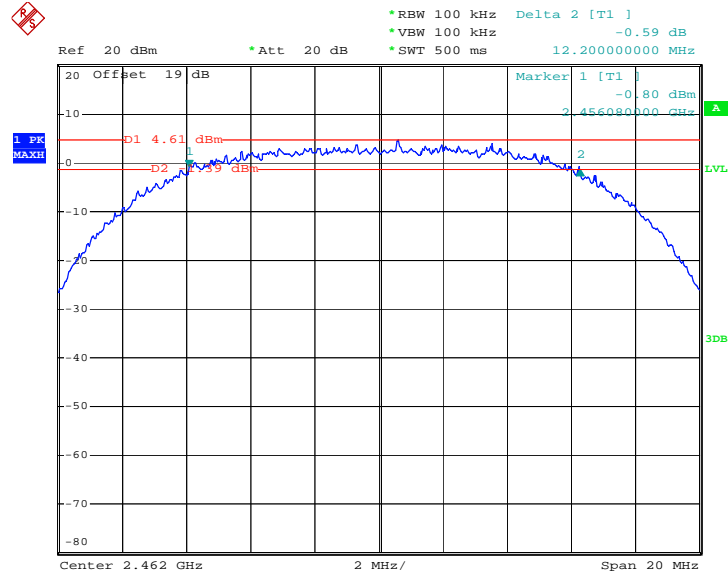

Date: 21.NOV.2008 17:04:29

Mode 4 : 6 dB Bandwidth Plot on 802.11g Channel 01

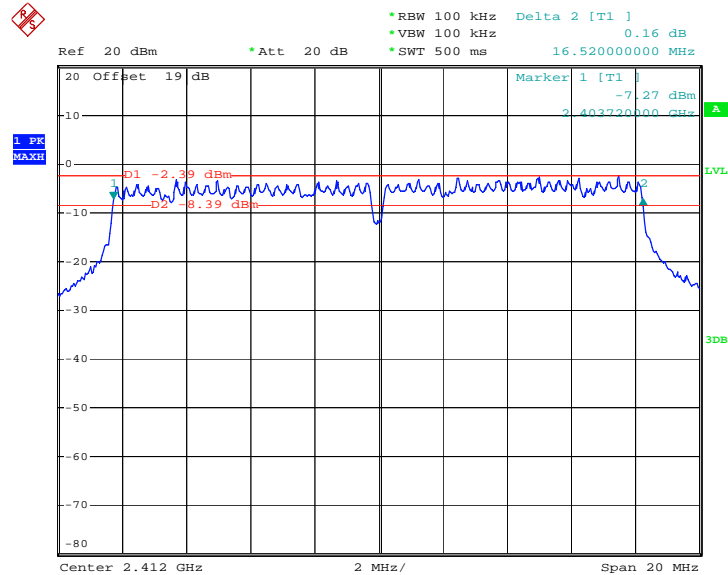

Date: 23.NOV.2008 10:31:52





Mode 5 : 6 dB Bandwidth Plot on 802.11g Channel 06

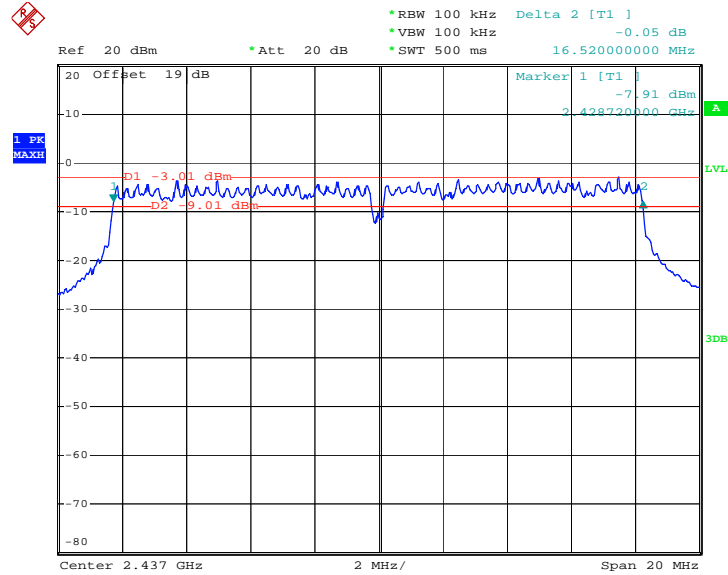

Date: 21.NOV.2008 16:45:02

Mode 6 : 6 dB Bandwidth Plot on 802.11g Channel 11

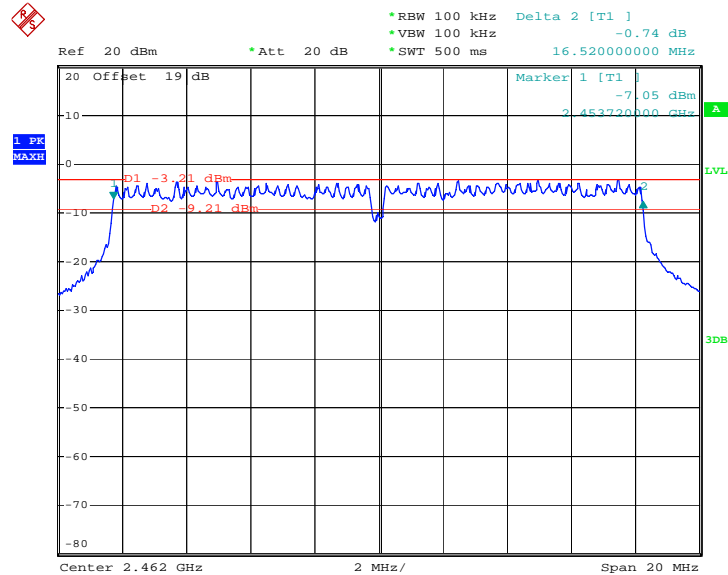

Date: 21.NOV.2008 16:42:04



Mode 7 : 6 dB Bandwidth Plot on 802.11n (20M) Channel 01

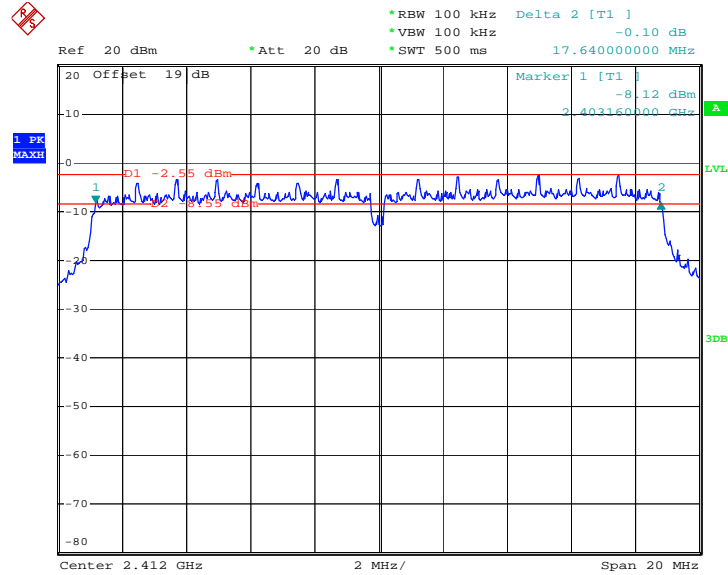

Date: 23.NOV.2008 11:42:49

Mode 8 : 6 dB Bandwidth Plot on 802.11n (20M) Channel 06

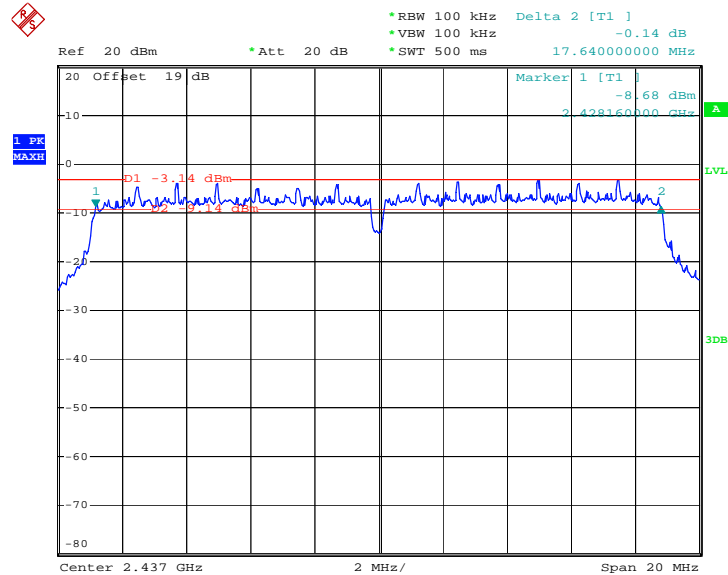

Date: 23.NOV.2008 11:43:48



Mode 9 : 6 dB Bandwidth Plot on 802.11n (20M) Channel 11

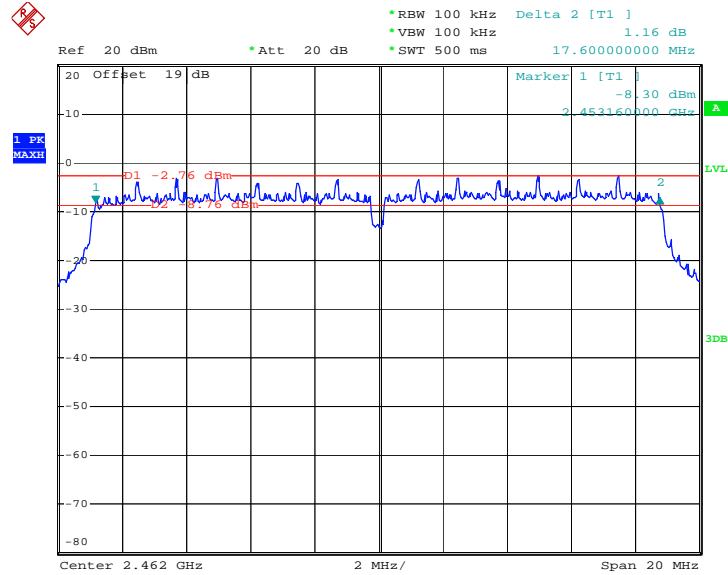

Date: 23.NOV.2008 11:45:22

Mode 10 : 6 dB Bandwidth Plot on 802.11 n (40M) Channel 03

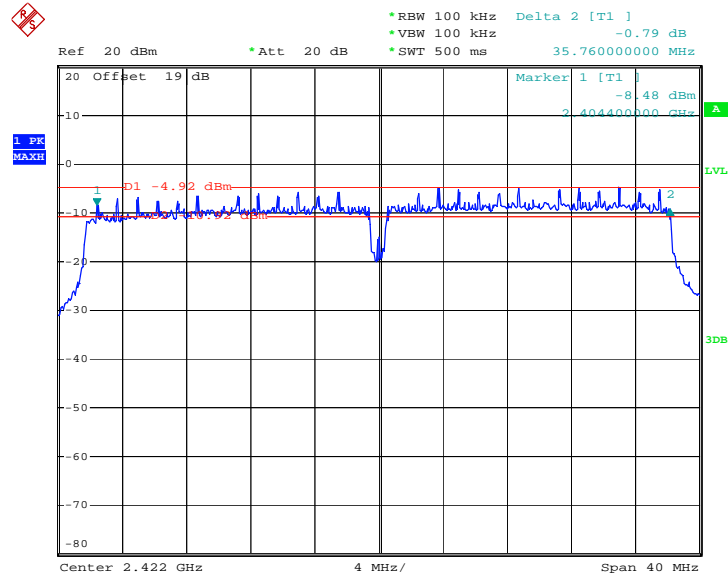

Date: 23.NOV.2008 13:13:06



Mode 11 : 6 dB Bandwidth Plot on 802.11n (40M) Channel 06

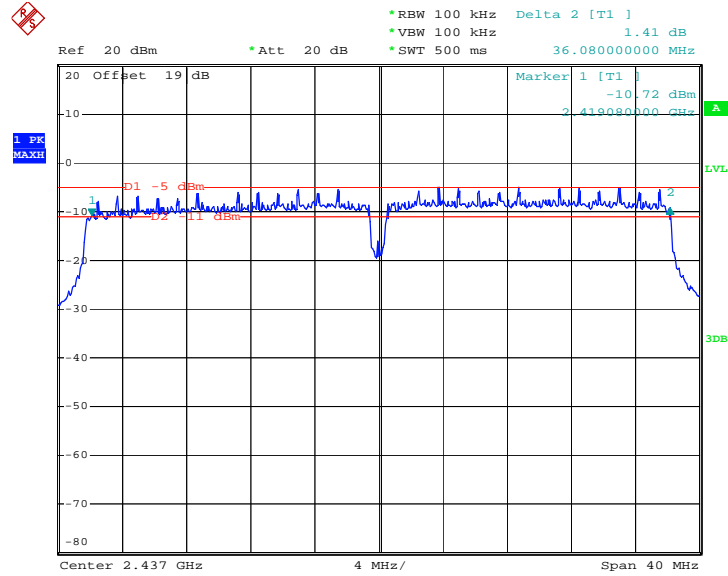

Date: 24.NOV.2008 14:38:40

Mode 12 : 6 dB Bandwidth Plot on 802.11 n (40M) Channel 09

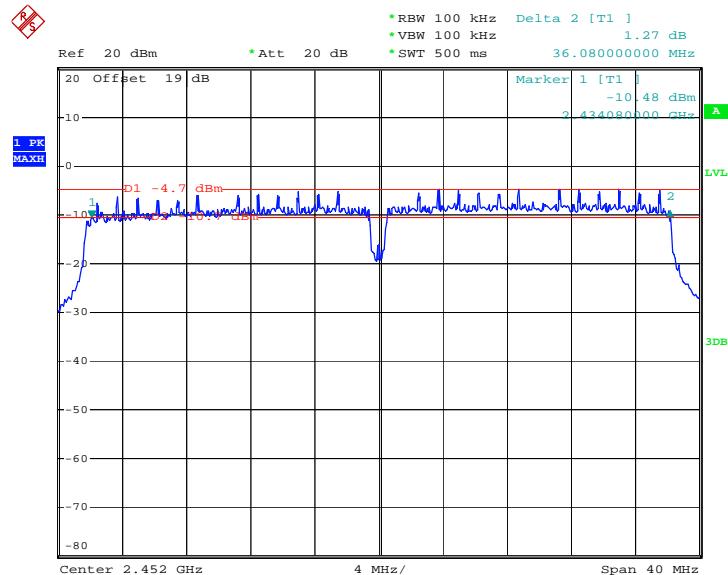

Date: 23.NOV.2008 13:11:43

## 3.2 Output Power Measurement

### 3.2.1 Limit of Output Power

For systems using digital modulation in the 2400-2483.5MHz, the limit for peak output power is 30dBm. If transmitting antenna of directional gain greater than 6dBi are used the peak output power from the intentional radiator shall be reduced below the above stated value by the amount in dB that the directional gain of the antenna exceeds 6 dBi. In case of point-to-point operation, the limit has to be reduced by 1dB for every 3dB that the directional gain of the antenna exceeds 6dBi.

### 3.2.2 Measuring Instruments

See list of measuring instruments of this test report.

### 3.2.3 Test Procedures

1. The testing follows FCC KDB Publication No. 558074 (Measurement Guidelines of DTS).
2. The RF output of EUT was connected to the spectrum analyzer by a low loss cable.
3. Measure the power either by power meter or spectrum analyzer.

### 3.2.4 Test Setup

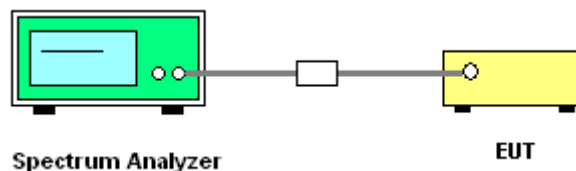



3.2.5 Test Result of Output Power

Test Mode :	Mode 1, 2, and 3	Temperature :	24~25
Test Engineer :	Ken Hsu	Relative Humidity :	42~44%

Channel	Frequency (MHz)	Measured Output Power (dBm)	Max. Limits (dBm)	Pass/Fail
01	2412	16.42	30	Pass
06	2437	16.21	30	Pass
11	2462	16.02	30	Pass

Test Mode :	Mode 4, 5, and 6	Temperature :	24~25
Test Engineer :	Ken Hsu	Relative Humidity :	42~44%

Channel	Frequency (MHz)	Measured Output Power (dBm)	Max. Limits (dBm)	Pass/Fail
01	2412	16.96	30	Pass
06	2437	16.23	30	Pass
11	2462	16.52	30	Pass



<b>Test Mode :</b>	Mode 7, 8, and 9	<b>Temperature :</b>	24~25
<b>Test Engineer :</b>	Ken Hsu	<b>Relative Humidity :</b>	42~44%

Channel	Frequency (MHz)	Measured Output Power (dBm)	Max. Limits (dBm)	Pass/Fail
01	2412	16.32	30	Pass
06	2437	15.93	30	Pass
11	2462	16.13	30	Pass

<b>Test Mode :</b>	Mode 10, 11, and 12	<b>Temperature :</b>	24~25
<b>Test Engineer :</b>	Ken Hsu	<b>Relative Humidity :</b>	42~44%

Channel	Frequency (MHz)	Measured Output Power (dBm)	Max. Limits (dBm)	Pass/Fail
03	2422	16.62	30	Pass
06	2437	17.15	30	Pass
09	2452	16.81	30	Pass

### 3.3 Band Edges Measurement

#### 3.3.1 Limit of Band Edges

In any 100 kHz bandwidth outside the intentional radiation frequency band, the radio frequency power shall be at least 20 dB below the highest level of the radiated power. If the output power of this device was measured by spectrum analyzer, the attenuation under this paragraph shall be 30 dB instead of 20 dB.

#### 3.3.2 Measuring Instruments

See list of measuring instruments of this test report.

#### 3.3.3 Test Procedures

1. The testing follows the guidelines in ANSI C63.4-2003 and FCC KDB Publication No. 558074 (Measurement Guidelines of DTS).
2. Conducted emission test: Set RBW = 100 kHz, Video bandwidth (VBW) > RBW, scan up through 10th harmonic. Band edge emissions must be at least 20 dB below the highest emission level within the authorized band as measured with a 100 kHz RBW. Note: If the output power of this device was measured by power meter, the attenuation under this paragraph shall be 30 dB instead of 20 dB.
3. Radiated emission test: Apply to band edge emissions that fall in the restricted bands listed in FCC Section 15.205. The maximum permitted average field strength is listed in FCC Section 15.209. A pre-amp is necessary for this measurement. For measurements above 1 GHz, set RBW = 1MHz, VBW = 10 Hz, Sweep=Auto. If the emission is pulsed, modify the unit for continuous operation; use the settings shown above, then correct the reading by subtracting the peak-average correction factor, derived from the appropriate duty cycle calculation as in FCC Section 15.35(b) and (c).

#### 3.3.4 Test Setup

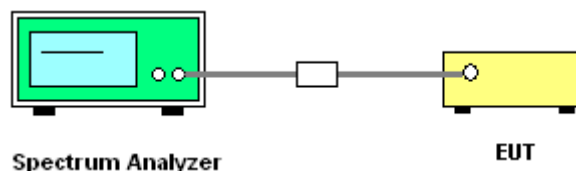





3.3.5 Test Result of Radiated Band Edges

Test Mode :	Mode 1	Temperature :	20~22°C
Test Channel :	01	Relative Humidity :	48~50%
Test Engineer :	Sam Chen		

ANTENNA POLARITY : HORIZONTAL										
Frequency ( MHz )	Level ( dBuV/m )	Over Limit ( dB )	Limit Line ( dBuV/m )	Read Level ( dBuV )	Antenna Factor ( dB )	Cable Loss ( dB )	Preamp Factor ( dB )	Ant Pos ( cm )	Table Pos ( deg )	Remark
2388.85	51.12	-22.88	74.00	51.50	31.98	3.92	36.28	100	0	Peak
2388.85	37.26	-16.74	54.00	37.64	31.98	3.92	36.28	100	314	Average

ANTENNA POLARITY : VERTICAL										
Frequency ( MHz )	Level ( dBuV/m )	Over Limit ( dB )	Limit Line ( dBuV/m )	Read Level ( dBuV )	Antenna Factor ( dB )	Cable Loss ( dB )	Preamp Factor ( dB )	Ant Pos ( cm )	Table Pos ( deg )	Remark
2388.85	48.58	-25.42	74.00	48.96	31.98	3.92	36.28	100	0	Peak
2388.85	35.17	-18.83	54.00	35.55	31.98	3.92	36.28	100	345	Average

Test Mode :	Mode 3	Temperature :	20~22°C
Test Channel :	11	Relative Humidity :	48~50%
Test Engineer :	Sam Chen		

ANTENNA POLARITY : HORIZONTAL										
Frequency ( MHz )	Level ( dBuV/m )	Over Limit ( dB )	Limit Line ( dBuV/m )	Read Level ( dBuV )	Antenna Factor ( dB )	Cable Loss ( dB )	Preamp Factor ( dB )	Ant Pos ( cm )	Table Pos ( deg )	Remark
2483.50	49.20	-24.80	74.00	49.37	32.08	4.05	36.30	100	0	Peak
2483.50	37.23	-16.77	54.00	37.40	32.08	4.05	36.30	100	306	Average

ANTENNA POLARITY : VERTICAL										
Frequency ( MHz )	Level ( dBuV/m )	Over Limit ( dB )	Limit Line ( dBuV/m )	Read Level ( dBuV )	Antenna Factor ( dB )	Cable Loss ( dB )	Preamp Factor ( dB )	Ant Pos ( cm )	Table Pos ( deg )	Remark
2499.05	49.86	-24.14	74.00	50.01	32.10	4.05	36.30	100	0	Peak
2499.05	35.52	-18.48	54.00	35.67	32.10	4.05	36.30	103	79	Average



Test Mode :	Mode 4	Temperature :	20~22°C
Test Channel :	01	Relative Humidity :	48~50%
Test Engineer :	Sam Chen		

ANTENNA POLARITY : HORIZONTAL										
Frequency ( MHz )	Level ( dBuV/m )	Over Limit ( dB )	Limit Line ( dBuV/m )	Read Level ( dBuV )	Antenna Factor ( dB )	Cable Loss ( dB )	Preamp Factor ( dB )	Ant Pos ( cm )	Table Pos ( deg )	Remark
2389.99	56.81	-17.19	74.00	57.19	31.98	3.92	36.28	100	0	Peak
2389.99	38.48	-15.52	54.00	38.86	31.98	3.92	36.28	100	316	Average

ANTENNA POLARITY : VERTICAL										
Frequency ( MHz )	Level ( dBuV/m )	Over Limit ( dB )	Limit Line ( dBuV/m )	Read Level ( dBuV )	Antenna Factor ( dB )	Cable Loss ( dB )	Preamp Factor ( dB )	Ant Pos ( cm )	Table Pos ( deg )	Remark
2389.61	54.07	-19.93	74.00	54.45	31.98	3.92	36.28	100	0	Peak
2389.61	35.87	-18.13	54.00	36.25	31.98	3.92	36.28	100	345	Average

Test Mode :	Mode 5	Temperature :	20~22°C
Test Channel :	11	Relative Humidity :	48~50%
Test Engineer :	Sam Chen		

ANTENNA POLARITY : HORIZONTAL										
Frequency ( MHz )	Level ( dBuV/m )	Over Limit ( dB )	Limit Line ( dBuV/m )	Read Level ( dBuV )	Antenna Factor ( dB )	Cable Loss ( dB )	Preamp Factor ( dB )	Ant Pos ( cm )	Table Pos ( deg )	Remark
2483.50	56.92	-17.08	74.00	57.08	32.08	4.05	36.30	100	0	Peak
2483.50	38.60	-15.40	54.00	38.77	32.08	4.05	36.30	100	306	Average

ANTENNA POLARITY : VERTICAL										
Frequency ( MHz )	Level ( dBuV/m )	Over Limit ( dB )	Limit Line ( dBuV/m )	Read Level ( dBuV )	Antenna Factor ( dB )	Cable Loss ( dB )	Preamp Factor ( dB )	Ant Pos ( cm )	Table Pos ( deg )	Remark
2483.50	53.88	-20.12	74.00	54.05	32.08	4.05	36.30	100	0	Peak
2483.50	36.33	-17.67	54.00	36.50	32.08	4.05	36.30	108	279	Average



Test Mode :	Mode 6	Temperature :	20~22°C
Test Channel :	01	Relative Humidity :	48~50%
Test Engineer :	Sam Chen		

ANTENNA POLARITY : HORIZONTAL										
Frequency ( MHz )	Level ( dBuV/m )	Over Limit ( dB )	Limit Line ( dBuV/m )	Read Level ( dBuV )	Antenna Factor ( dB )	Cable Loss ( dB )	Preamp Factor ( dB )	Ant Pos ( cm )	Table Pos ( deg )	Remark
2389.99	57.21	-16.79	74.00	57.59	31.98	3.92	36.28	100	0	Peak
2389.99	39.04	-14.96	54.00	39.42	31.98	3.92	36.28	100	300	Average

ANTENNA POLARITY : VERTICAL										
Frequency ( MHz )	Level ( dBuV/m )	Over Limit ( dB )	Limit Line ( dBuV/m )	Read Level ( dBuV )	Antenna Factor ( dB )	Cable Loss ( dB )	Preamp Factor ( dB )	Ant Pos ( cm )	Table Pos ( deg )	Remark
2390.00	55.80	-18.20	74.00	56.19	31.98	3.92	36.28	100	0	Peak
2390.00	38.83	-15.17	54.00	39.21	31.98	3.92	36.28	100	349	Average

Test Mode :	Mode 7	Temperature :	20~22°C
Test Channel :	11	Relative Humidity :	48~50%
Test Engineer :	Sam Chen		

ANTENNA POLARITY : HORIZONTAL										
Frequency ( MHz )	Level ( dBuV/m )	Over Limit ( dB )	Limit Line ( dBuV/m )	Read Level ( dBuV )	Antenna Factor ( dB )	Cable Loss ( dB )	Preamp Factor ( dB )	Ant Pos ( cm )	Table Pos ( deg )	Remark
2483.50	57.60	-16.40	74.00	57.77	32.08	4.05	36.30	100	0	Peak
2483.50	40.72	-13.28	54.00	40.89	32.08	4.05	36.30	100	307	Average

ANTENNA POLARITY : VERTICAL										
Frequency ( MHz )	Level ( dBuV/m )	Over Limit ( dB )	Limit Line ( dBuV/m )	Read Level ( dBuV )	Antenna Factor ( dB )	Cable Loss ( dB )	Preamp Factor ( dB )	Ant Pos ( cm )	Table Pos ( deg )	Remark
2483.50	55.34	-18.66	74.00	55.51	32.08	4.05	36.30	100	0	Peak
2483.50	37.96	-16.04	54.00	38.13	32.08	4.05	36.30	111	65	Average



Test Mode :	Mode 8	Temperature :	20~22°C
Test Channel :	03	Relative Humidity :	48~50%
Test Engineer :	Sam Chen		

ANTENNA POLARITY : HORIZONTAL										
Frequency ( MHz )	Level ( dBuV/m )	Over Limit ( dB )	Limit Line ( dBuV/m )	Read Level ( dBuV )	Antenna Factor ( dB )	Cable Loss ( dB )	Preamp Factor ( dB )	Ant Pos ( cm )	Table Pos ( deg )	Remark
2390.00	59.92	-14.08	74.00	60.31	31.98	3.92	36.28	100	0	Peak
2390.00	42.00	-12.00	54.00	42.38	31.98	3.92	36.28	100	312	Average

ANTENNA POLARITY : VERTICAL										
Frequency ( MHz )	Level ( dBuV/m )	Over Limit ( dB )	Limit Line ( dBuV/m )	Read Level ( dBuV )	Antenna Factor ( dB )	Cable Loss ( dB )	Preamp Factor ( dB )	Ant Pos ( cm )	Table Pos ( deg )	Remark
2390.00	62.24	-11.76	74.00	62.63	31.98	3.92	36.28	100	0	Peak
2390.00	43.82	-10.18	54.00	44.20	31.98	3.92	36.28	110	284	Average

Test Mode :	Mode 10	Temperature :	20~22°C
Test Channel :	09	Relative Humidity :	48~50%
Test Engineer :	Sam Chen		

ANTENNA POLARITY : HORIZONTAL										
Frequency ( MHz )	Level ( dBuV/m )	Over Limit ( dB )	Limit Line ( dBuV/m )	Read Level ( dBuV )	Antenna Factor ( dB )	Cable Loss ( dB )	Preamp Factor ( dB )	Ant Pos ( cm )	Table Pos ( deg )	Remark
2483.50	64.31	-9.69	74.00	64.48	32.08	4.05	36.30	100	0	Peak
2483.50	45.55	-8.45	54.00	45.72	32.08	4.05	36.30	100	52	Average

ANTENNA POLARITY : VERTICAL										
Frequency ( MHz )	Level ( dBuV/m )	Over Limit ( dB )	Limit Line ( dBuV/m )	Read Level ( dBuV )	Antenna Factor ( dB )	Cable Loss ( dB )	Preamp Factor ( dB )	Ant Pos ( cm )	Table Pos ( deg )	Remark
2483.50	62.23	-11.77	74.00	62.40	32.08	4.05	36.30	100	0	Peak
2483.50	43.74	-10.26	54.00	43.91	32.08	4.05	36.30	100	78	Average



### 3.3.6 Test Result of Conducted Band Edges

Test Mode :	Mode 1 and 3	Temperature :	24~25
Test Channel :	01 and 11	Relative Humidity :	42~44%
Test Engineer :	Ken Hsu		

Low Band Edge Plot on 802.11b Channel 01

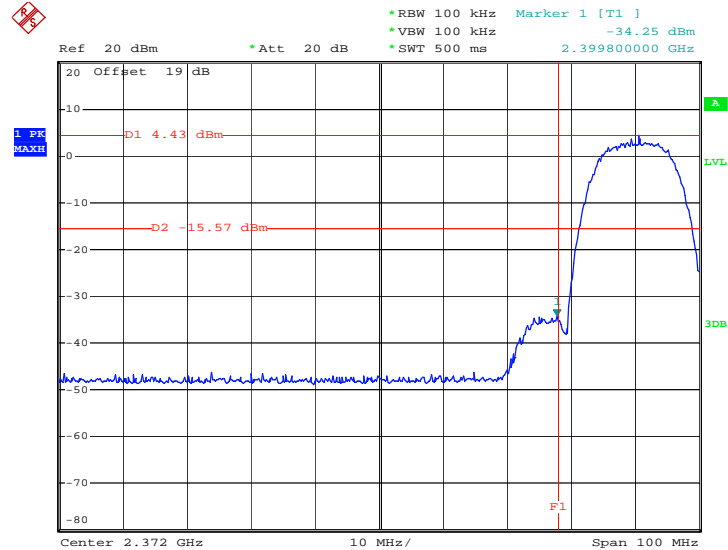

Date: 23.NOV.2008 10:23:42

High Band Edge Plot on 802.11b Channel 11

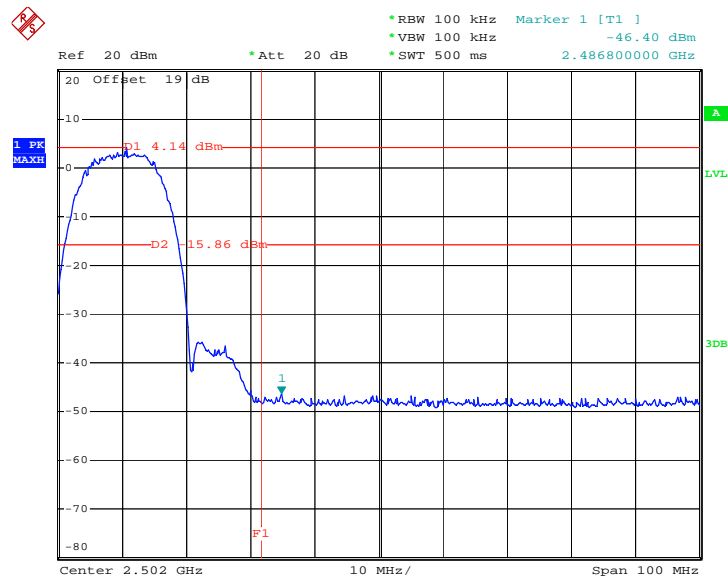

Date: 23.NOV.2008 10:01:28



Test Mode :	Mode 4 and 6	Temperature :	24~25
Test Channel :	01 and 11	Relative Humidity :	42~44%
Test Engineer :	Ken Hsu		

Low Band Edge Plot on 802.11g Channel 01

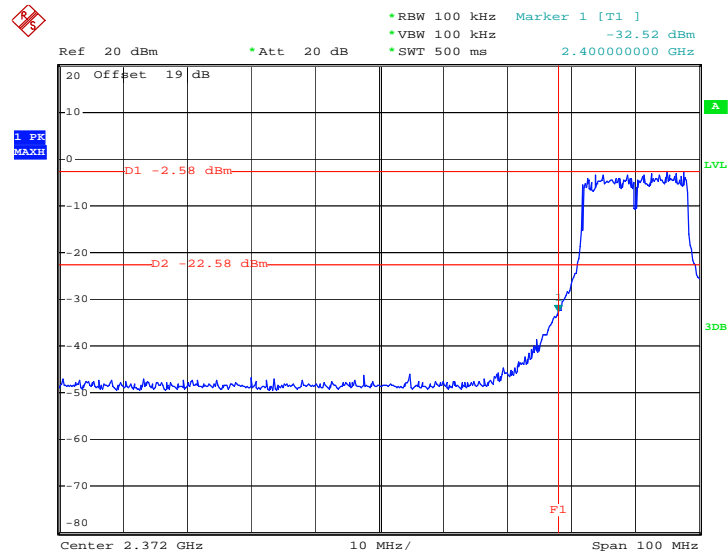

Date: 23.NOV.2008 10:05:12

High Band Edge Plot on 802.11g Channel 11

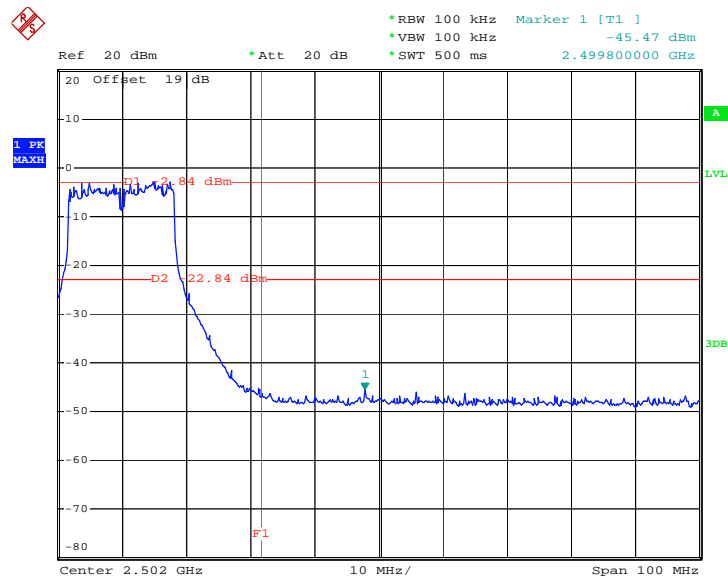

Date: 23.NOV.2008 10:07:33



Test Mode :	Mode 7 and 9	Temperature :	24~25
Test Channel :	01 and 11	Relative Humidity :	42~44%
Test Engineer :	Ken Hsu		

Low Band Edge Plot on 802.11n (20M) Channel 01

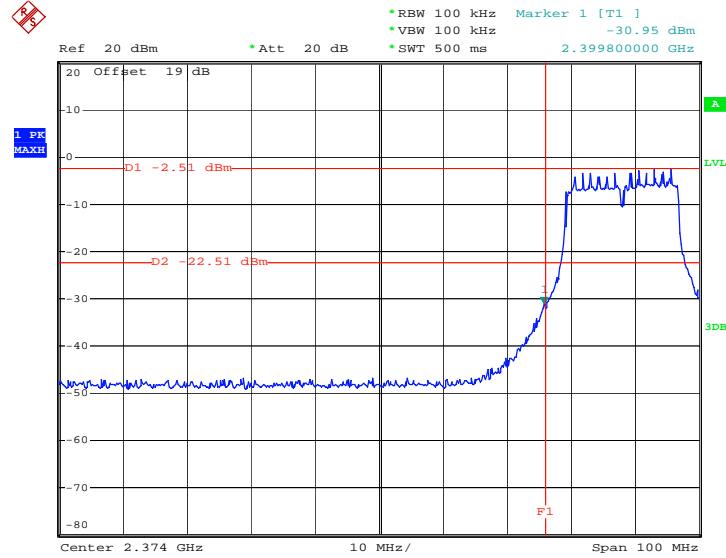

Date: 23.NOV.2008 11:48:35

High Band Edge Plot on 802.11n (20M) Channel 11

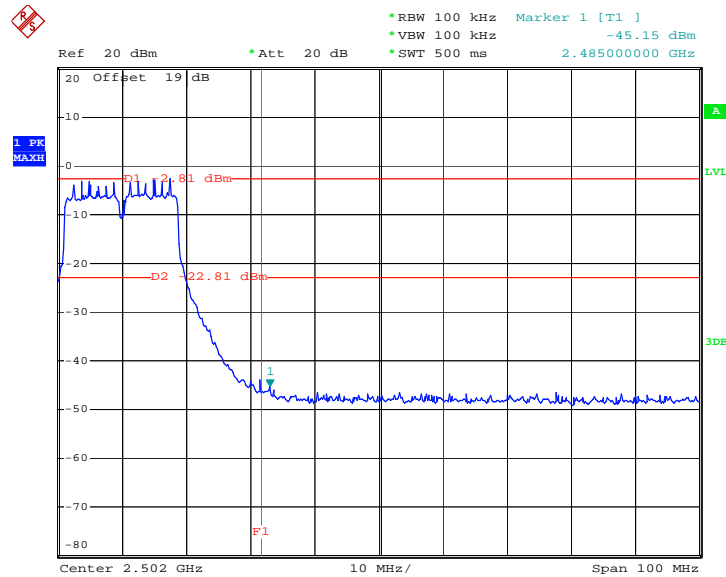

Date: 23.NOV.2008 11:50:35



Test Mode :	Mode 10 and 12	Temperature :	24~25
Test Channel :	03 and 09	Relative Humidity :	42~44%
Test Engineer :	Ken Hsu		

Low Band Edge Plot on 802.11n (40M) Channel 03

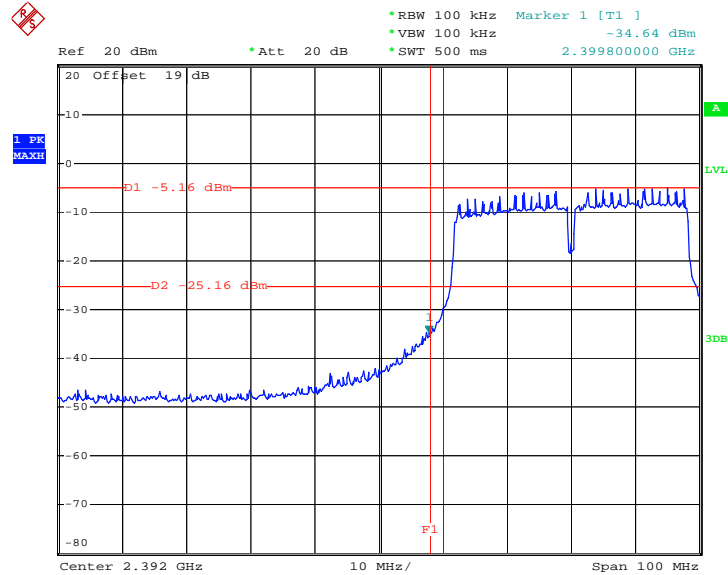

Date: 23.NOV.2008 13:14:33

High Band Edge Plot on 802.11n (40M) Channel 09

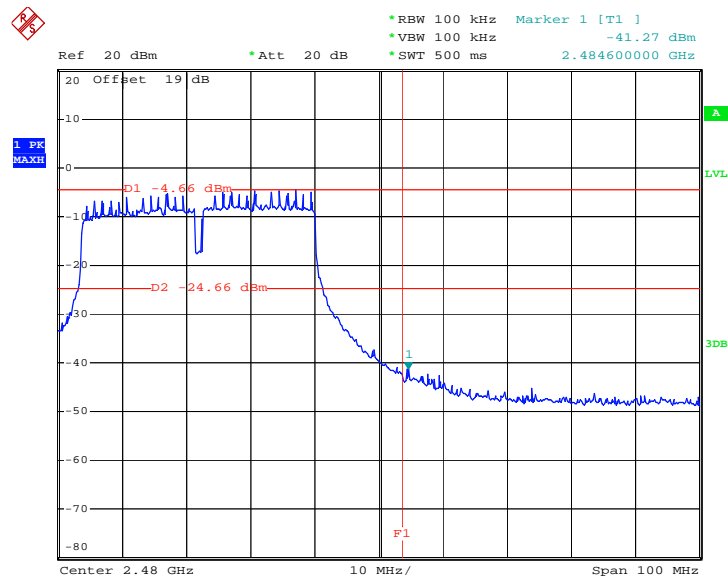

Date: 23.NOV.2008 13:15:51



### 3.4 Power Spectral Density Measurement

#### 3.4.1 Limit of Power Spectral Density

The peak power spectral density shall not be greater than 8dBm in any 3kHz band at any time interval of continuous transmission.

#### 3.4.2 Measuring Instruments

See list of measuring instruments of this test report.

#### 3.4.3 Test Procedures

1. The test follows FCC KDB Publication No. 558074 (Measurement Guidelines of DTS).
2. The RF output of EUT was connected to the spectrum analyzer by a low loss cable.
3. Take the measured data from spectrum analyzer.

#### 3.4.4 Test Setup

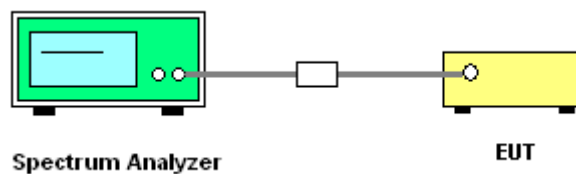



3.4.5 Test Result of Power Spectral Density

Test Mode :	Mode 1, 2, and 3	Temperature :	24~25
Test Engineer :	Ken Hsu	Relative Humidity :	42~44%

Channel	Frequency (MHz)	Measured PSD (dBm)	Max. Limits (dBm)	Pass/Fail
01	2412	-5.81	8	Pass
06	2437	-7.30	8	Pass
11	2462	-5.99	8	Pass

Test Mode :	Mode 4, 5, and 6	Temperature :	24~25
Test Engineer :	Ken Hsu	Relative Humidity :	42~44%

Channel	Frequency (MHz)	Measured PSD (dBm)	Max. Limits (dBm)	Pass/Fail
01	2412	-11.37	8	Pass
06	2437	-16.86	8	Pass
11	2462	-15.71	8	Pass



<b>Test Mode :</b>	Mode 7, 8, and 9	<b>Temperature :</b>	24~25
<b>Test Engineer :</b>	Ken Hsu	<b>Relative Humidity :</b>	42~44%

Channel	Frequency (MHz)	Measured PSD (dBm)	Max. Limits (dBm)	Pass/Fail
01	2412	-16.97	8	Pass
06	2437	-17.21	8	Pass
11	2462	-16.84	8	Pass

<b>Test Mode :</b>	Mode 10, 11, and 12	<b>Temperature :</b>	24~25
<b>Test Engineer :</b>	Ken Hsu	<b>Relative Humidity :</b>	42~44%

Channel	Frequency (MHz)	Measured PSD (dBm)	Max. Limits (dBm)	Pass/Fail
03	2422	-18.95	8	Pass
06	2437	-17.72	8	Pass
09	2452	-18.90	8	Pass



### 3.4.6 Test Result of Power Spectral Density Plots

#### Mode 1 : PSD Plot on 802.11b Channel 01

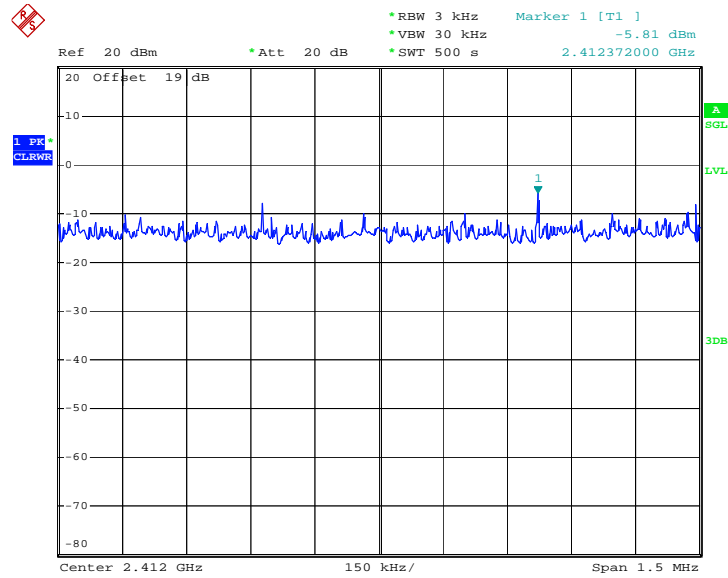

Date: 23.NOV.2008 09:41:14

#### Mode 2 : PSD Plot on 802.11b Channel 06

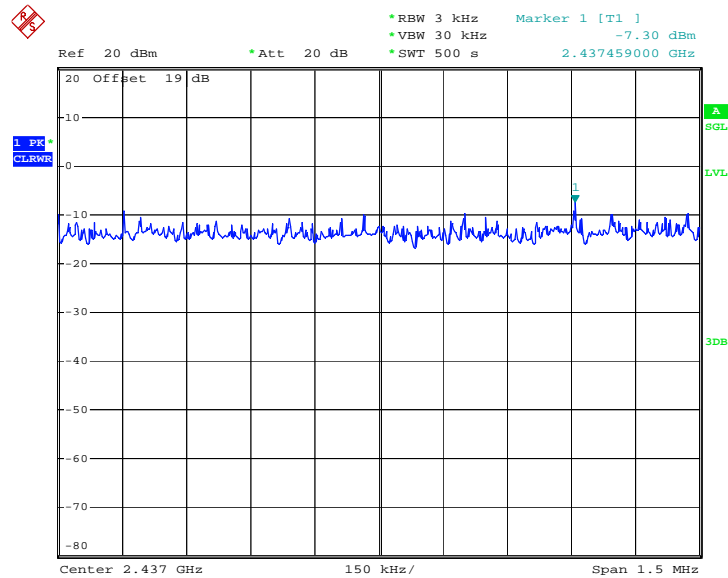

Date: 23.NOV.2008 09:50:03



Mode 3 : PSD Plot on 802.11b Channel 11

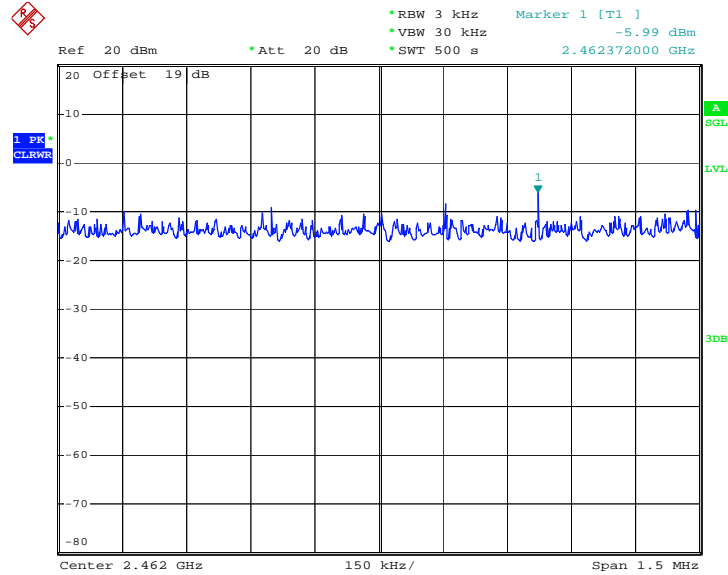

Date: 23.NOV.2008 09:58:53

Mode 4 : PSD Plot on 802.11g Channel 01

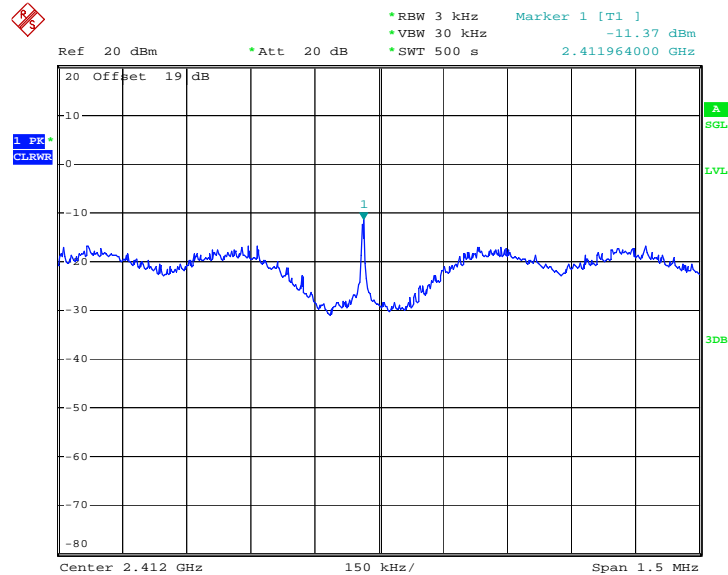

Date: 21.NOV.2008 16:23:04



Mode 5 : PSD Plot on 802.11g Channel 06

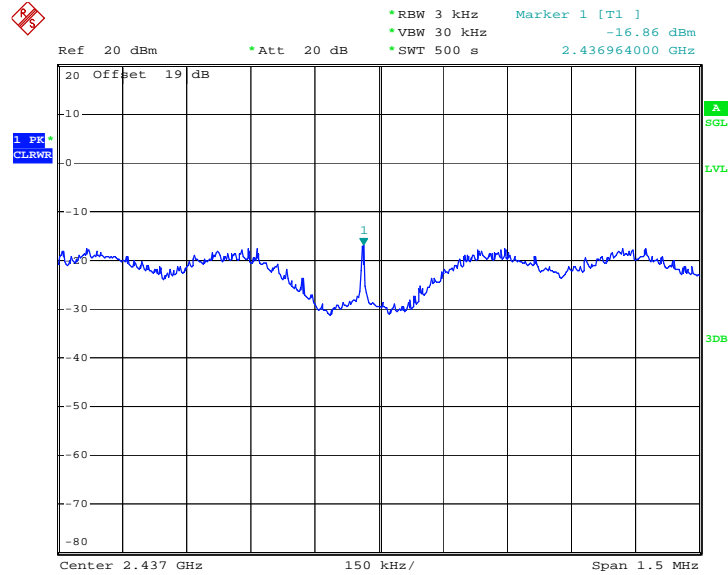

Date: 21.NOV.2008 16:31:54

Mode 6 : PSD Plot on 802.11g Channel 11

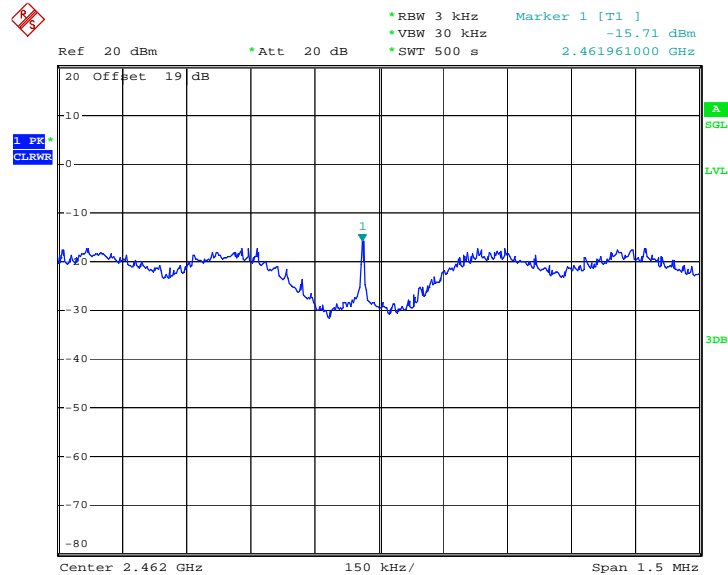

Date: 21.NOV.2008 16:40:37



Mode 7 : PSD Plot on 802.11n (20M) Channel 01

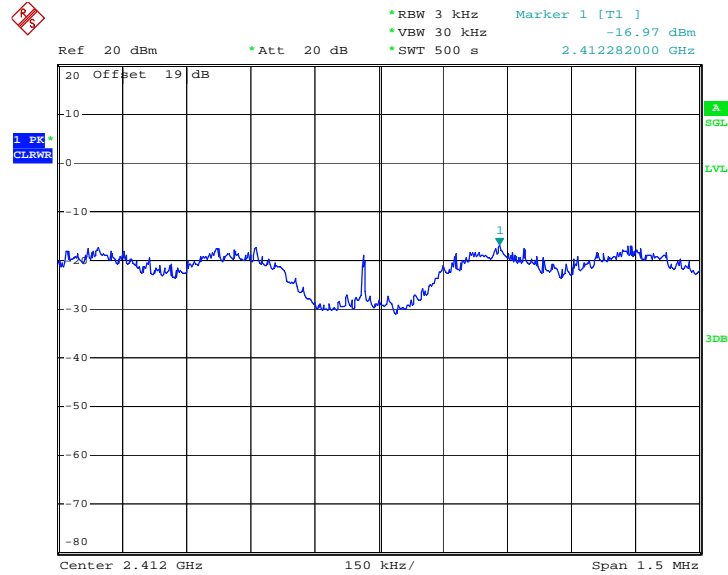

Date: 23.NOV.2008 11:30:52

Mode 8 : PSD Plot on 802.11n (20M) Channel 06

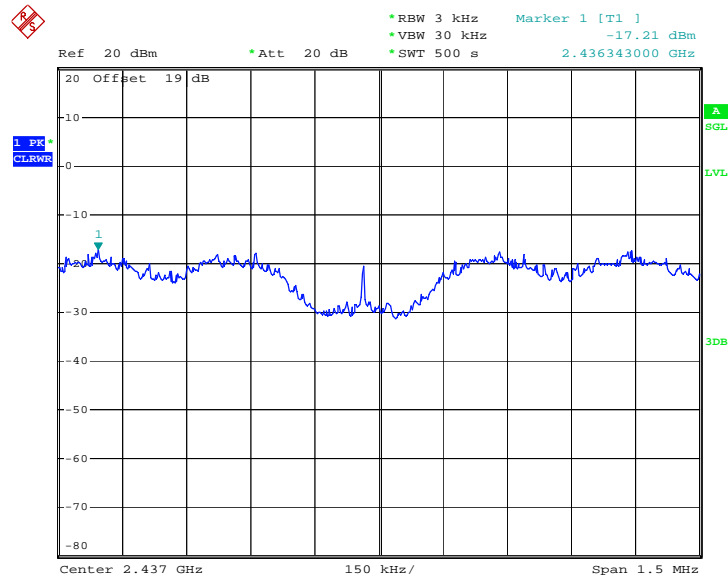

Date: 23.NOV.2008 11:40:49



Mode 9 : PSD Plot on 802.11n (20M) Channel 11

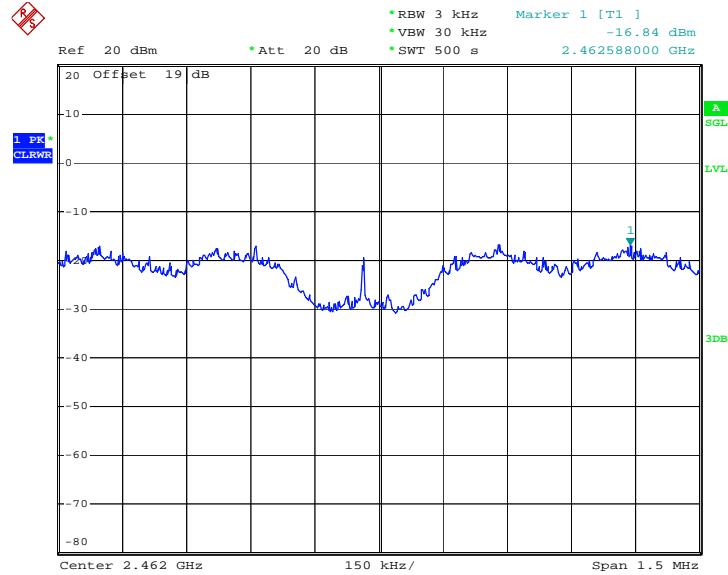

Date: 23.NOV.2008 12:03:59

Mode 10 : PSD Plot on 802.11n (40M) Channel 03

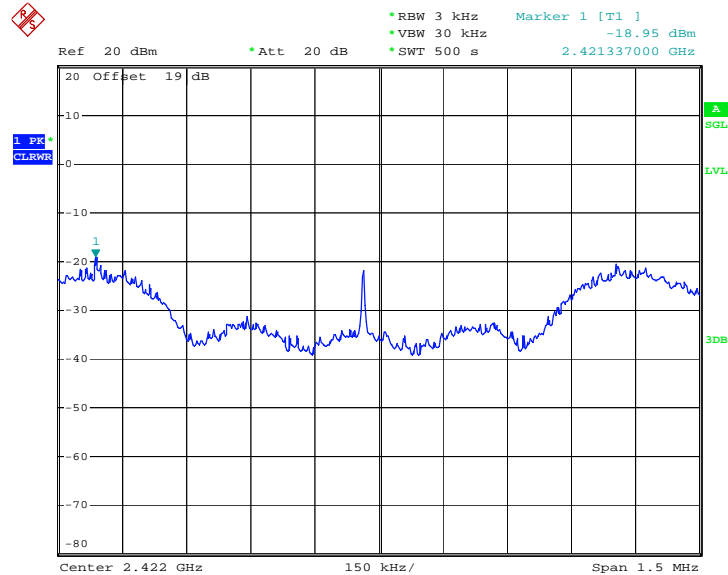

Date: 23.NOV.2008 12:58:46





Mode 11 : PSD Plot on 802.11 n (40M) Channel 06

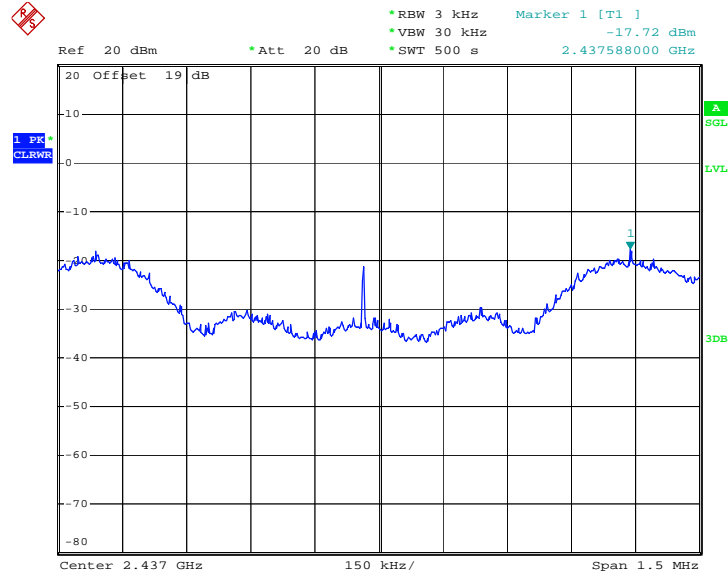

Date: 24.NOV.2008 14:47:38

Mode 12 : PSD Plot on 802.11 n (40M) Channel 09

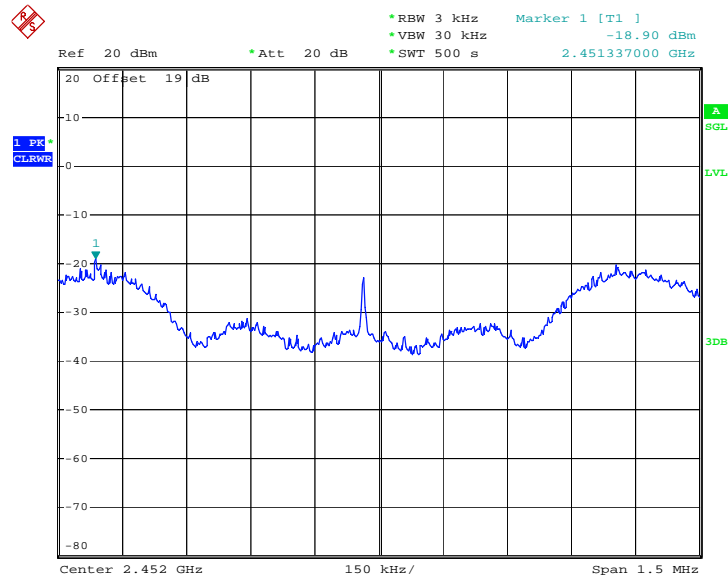

Date: 23.NOV.2008 13:09:22

## 3.5 AC Conducted Emission Measurement

### 3.5.1 Limit of AC Conducted Emission

For equipment that is designed to be connected to the public utility (AC) power line, the radio frequency voltage that is conducted back onto the AC power line on any frequency or frequencies within the band 150 kHz to 30 MHz shall not exceed the limits in the following table.

Frequency of emission (MHz)	Conducted limit (dBuV)	
	Quasi-peak	Average
0.15-0.5	66 to 56*	56 to 46*
0.5-5	56	46
5-30	60	50

\*Decreases with the logarithm of the frequency.

### 3.5.2 Measuring Instruments

See list of measuring instruments of this test report.

### 3.5.3 Test Procedures

1. The testing follows the guidelines in ANSI C63.4-2003.
2. The EUT was placed 0.4 meter from the conducting wall of the shielding room, and it was kept at least 80 centimeters from any other grounded conducting surface.
3. Connect EUT to the power mains through a line impedance stabilization network (LISN).
4. All the support units are connecting to the other LISN.
5. The LISN provides 50 ohm coupling impedance for the measuring instrument.
6. The FCC states that a 50 ohm, 50 microhenry LISN should be used.
7. Both sides of AC line were checked for maximum conducted interference.
8. The frequency range from 150 kHz to 30 MHz was searched.
9. Set the test-receiver system to Peak Detect Function and specified bandwidth with Maximum Hold Mode.

### 3.5.4 Test Setup

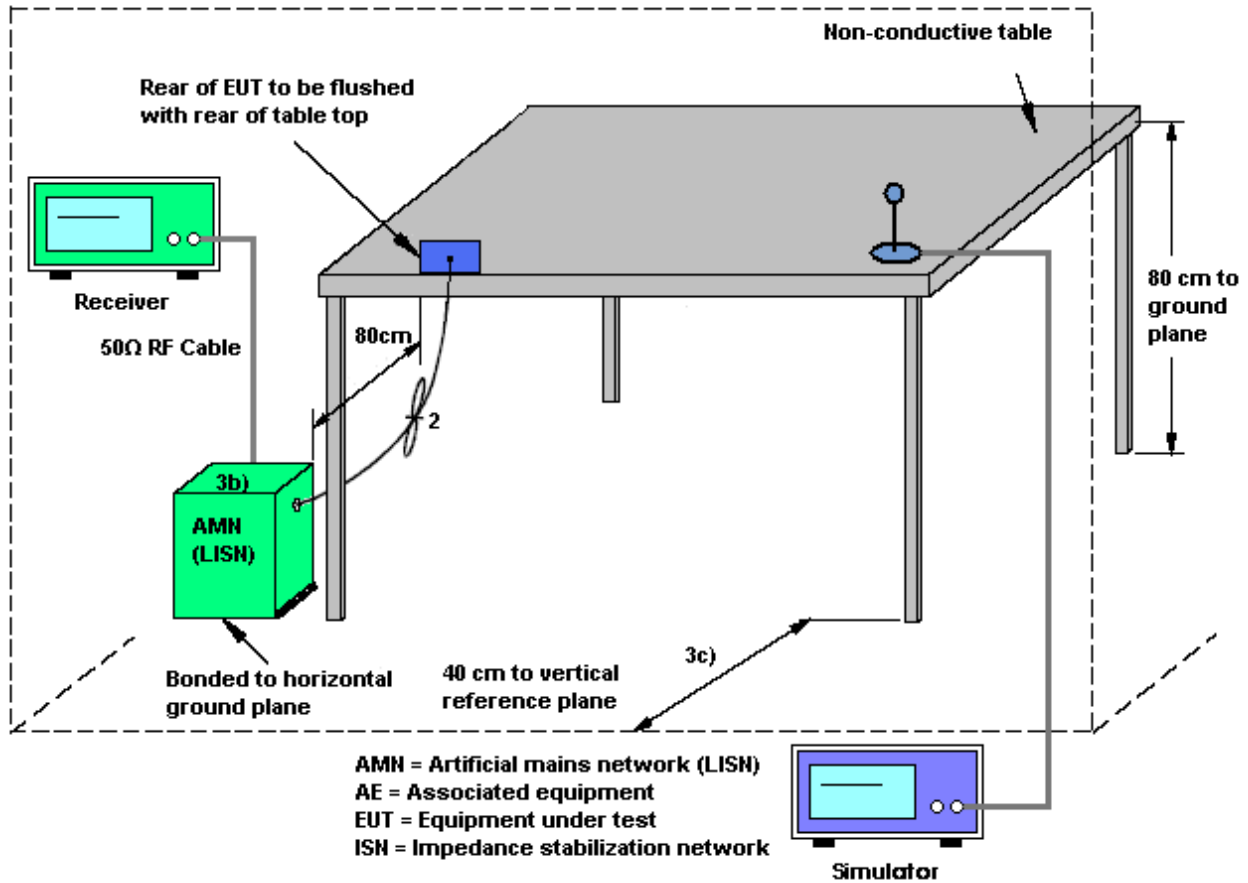

### 3.5.5 Test Result of AC Conducted Emission

Test Mode :	Mode 1	Temperature :	24~25
Test Engineer :	Cona Huang	Relative Humidity :	42~44%
		Phase :	Line
Function Type :	WLAN Link + Adapter		
Remark :	All emissions not reported here are more than 10 dB below the prescribed limit.		

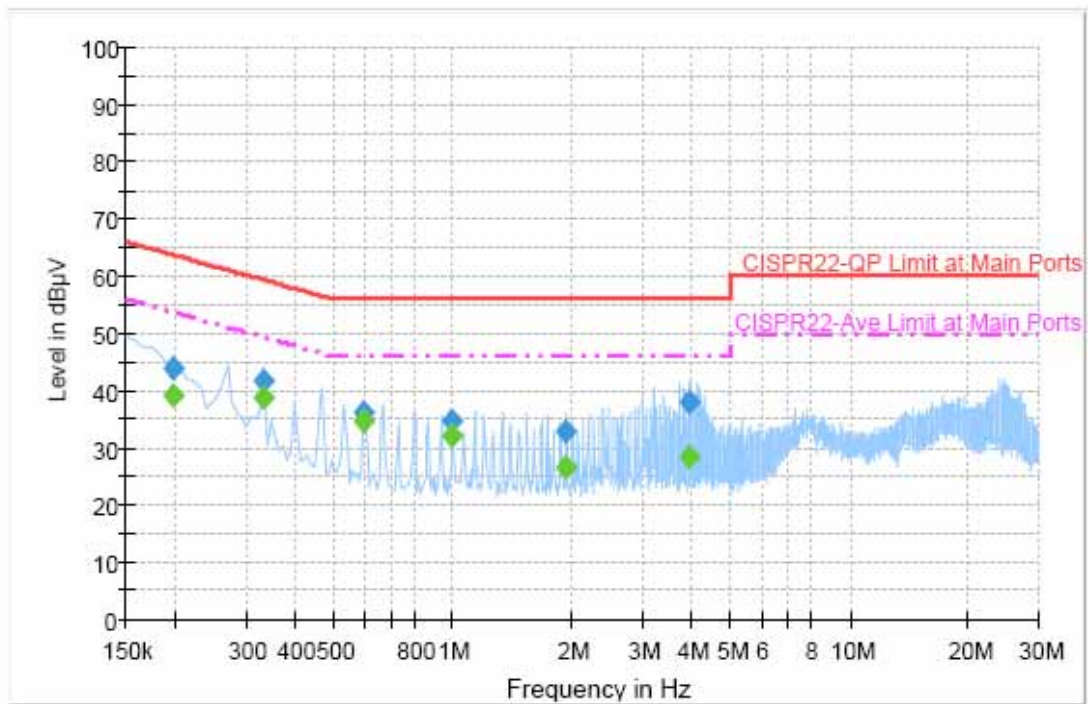

#### Final Result 1

Frequency (MHz)	QuasiPeak (dBµV)	Filter	Line	Corr. (dB)	Margin (dB)	Limit (dBµV)
0.198000	43.7	Off	L1	19.3	20.0	63.7
0.334000	41.6	Off	L1	19.3	17.8	59.4
0.598000	36.2	Off	L1	19.4	19.8	56.0
0.998000	34.6	Off	L1	19.4	21.4	56.0
1.934000	32.9	Off	L1	19.4	23.1	56.0
3.934000	38.2	Off	L1	19.5	17.8	56.0

#### Final Result 2

Frequency (MHz)	Average (dBµV)	Filter	Line	Corr. (dB)	Margin (dB)	Limit (dBµV)
0.198000	39.2	Off	L1	19.3	14.5	53.7
0.334000	38.9	Off	L1	19.3	10.5	49.4
0.598000	34.6	Off	L1	19.4	11.4	46.0
0.998000	32.0	Off	L1	19.4	14.0	46.0
1.934000	26.4	Off	L1	19.4	19.6	46.0
3.934000	28.3	Off	L1	19.5	17.7	46.0



Test Mode :	Mode 1	Temperature :	24~25
Test Engineer :	Cona Huang	Relative Humidity :	42~44%
		Phase :	Neutral
Function Type :	WLAN Link + Adapter		
Remark :	All emissions not reported here are more than 10 dB below the prescribed limit.		

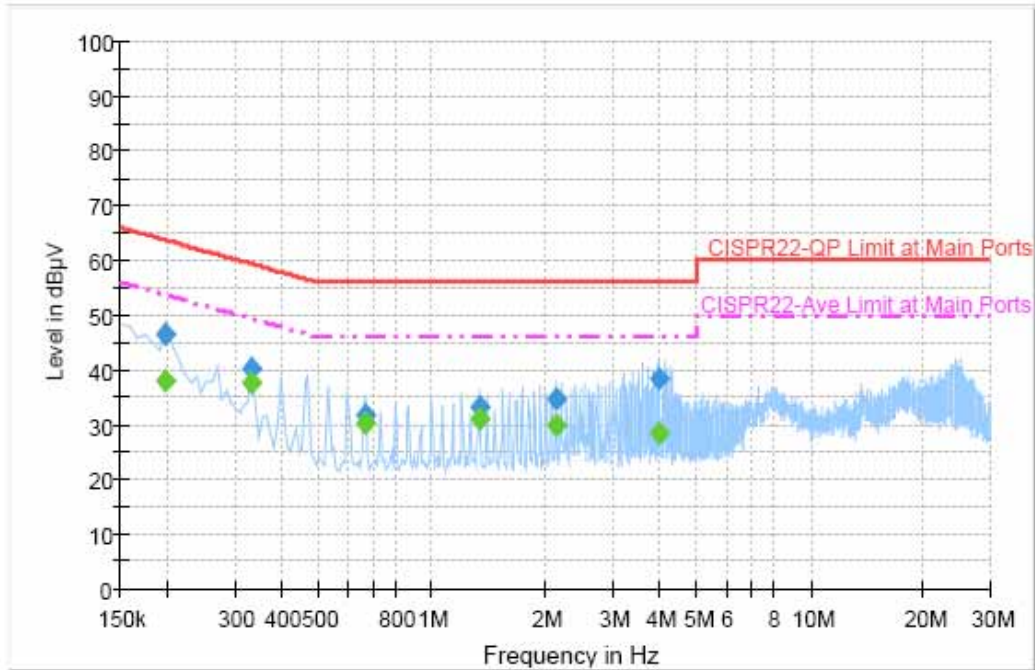

**Final Result 1**

Frequency (MHz)	QuasiPeak (dBµV)	Filter	Line	Corr. (dB)	Margin (dB)	Limit (dBµV)
0.198000	46.4	Off	N	19.3	17.3	63.7
0.334000	40.2	Off	N	19.3	19.2	59.4
0.670000	31.8	Off	N	19.4	24.2	56.0
1.334000	33.2	Off	N	19.4	22.8	56.0
2.134000	34.7	Off	N	19.5	21.3	56.0
3.998000	38.3	Off	N	19.5	17.7	56.0

**Final Result 2**

Frequency (MHz)	Average (dBµV)	Filter	Line	Corr. (dB)	Margin (dB)	Limit (dBµV)
0.198000	38.1	Off	N	19.3	15.6	53.7
0.334000	37.7	Off	N	19.3	11.7	49.4
0.670000	30.4	Off	N	19.4	15.6	46.0
1.334000	31.0	Off	N	19.4	15.0	46.0
2.134000	29.9	Off	N	19.5	16.1	46.0
3.998000	28.5	Off	N	19.5	17.5	46.0

### 3.6 Radiated Emission Measurement

#### 3.6.1 Limit of Radiated Emission

In any 100 kHz bandwidth outside the intentional radiator frequency band, all harmonics/spurious must be at least 20 dB below the highest emission level within the authorized band. If the output power of this device was measured by spectrum analyzer, the attenuation under this paragraph shall be 30 dB instead of 20 dB. In addition, radiated emissions which fall in the restricted bands must also comply with the FCC section 15.209 limits as below.

Frequency (MHz)	Field Strength (microvolts/meter)	Measurement Distance (meters)
0.009 – 0.490	2400/F(kHz)	300
0.490 – 1.705	24000/F(kHz)	30
1.705 – 30.0	30	30
30 – 88	100	3
88 – 216	150	3
216 - 960	200	3
Above 960	500	3

#### 3.6.2 Measuring Instruments

See list of measuring instruments of this test report.

#### 3.6.3 Test Procedures

1. The testing follows the guidelines in FCC KDB Publication No. 558074 (Measurement Guidelines of DTS).
2. Use the following spectrum analyzer settings:  
Span = wide enough to fully capture the emission being measured; RBW = 1 MHz for  $f \geq 1$  GHz, 100 kHz for  $f < 1$  GHz; VBW  $\geq$  RBW; Sweep = auto; Detector function = peak; Trace = max hold.
3. Follow the guidelines in ANSI C63.4-2003 with respect to maximizing the emission by rotating the EUT, measuring the emission for three EUT orthogonal planes, and adjusting the measurement antenna height and polarization. A pre-amp and a high pass filter are used for this test in order to get the good signal level.

### 3.6.4 Test Setup

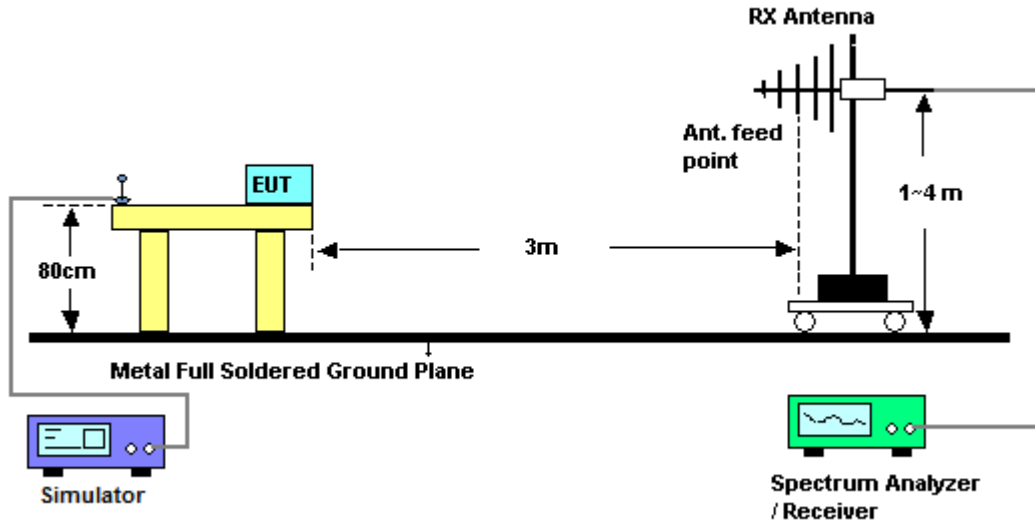



3.6.5 Test Result of Radiated Emission < 1GHz

Test Mode :	Mode 1	Temperature :	20~22°C
Test Channel :	01	Relative Humidity :	48~50%
Test Engineer :	Sam Chen	Polarization :	Horizontal
Remark :			

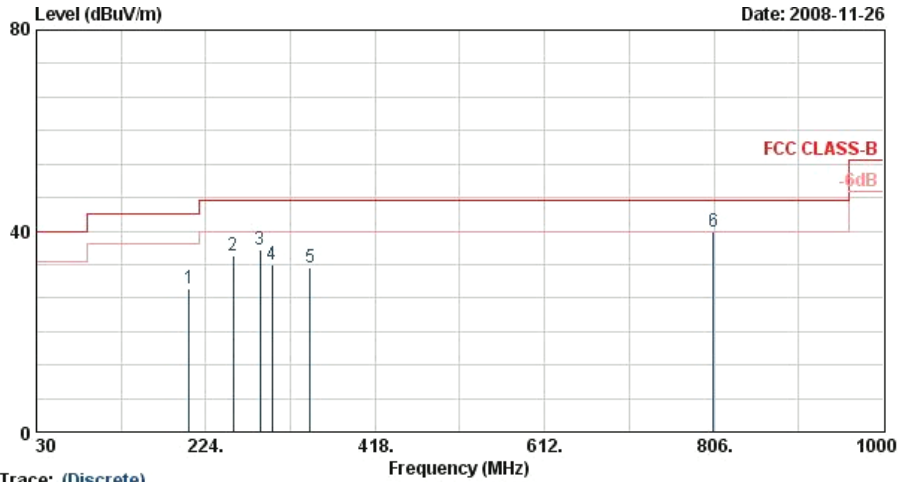

Trace: (Discrete)  
 Site : 03CH06-HY  
 Condition : FCC CLASS-B 3m BTLOC\_081124 HORIZONTAL  
 Model : FR 8N1310-01  
 Mode : Mode 1

	Freq	Level	Over	Limit	Read	Antenna	Cable	Preamp	Ant	Table	Remark
	MHz	dBuV/m	Limit	Line	Level	Factor	Loss	Factor	Pos	Pos	
			dB	dBuV/m	dBuV	dB/m	dB	dB	cm	deg	
1	204.69	28.48	-15.02	43.50	49.56	10.48	0.60	32.16	---	---	Peak
2	255.18	35.07	-10.93	46.00	52.90	13.30	0.70	31.83	---	---	Peak
3	286.23	36.15	-9.85	46.00	53.88	13.62	0.70	32.05	---	---	Peak
4	300.00	33.17	-12.83	46.00	50.72	13.90	0.70	32.15	---	---	Peak
5	343.40	32.75	-13.25	46.00	48.59	15.11	0.80	31.75	---	---	Peak
6 @	805.40	39.98	-6.02	46.00	50.12	20.86	1.20	32.20	100	225	Peak





Test Mode :	Mode 1	Temperature :	20~22°C
Test Channel :	01	Relative Humidity :	48~50%
Test Engineer :	Sam Chen	Polarization :	Vertical
Remark :			

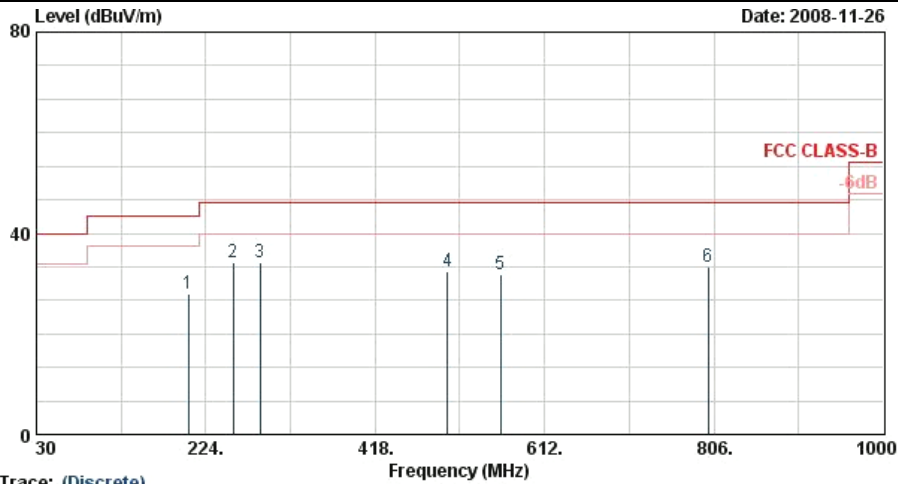

Trace: (Discrete)  
 Site : 03CH06-HY  
 Condition : FCC CLASS-B 3m B1LOG\_081124 VERTICAL  
 Model : FR 8N1310-01  
 Mode : Mode 1

	Freq	Level	Over	Limit	Read	Antenna	Cable	Preamp	Ant	Table	Remark
	MHz	dBuV/m	Limit	Line	Level	Factor	Loss	Factor	Pos	Pos	
			dB	dBuV/m	dBuV	dB/m	dB	dB	cm	deg	
1	203.88	27.92	-15.58	43.50	49.03	10.45	0.60	32.15	---	---	Peak
2	255.18	34.32	-11.68	46.00	52.15	13.30	0.70	31.83	100	332	Peak
3	286.23	34.29	-11.71	46.00	52.02	13.62	0.70	32.05	---	---	Peak
4	500.90	32.32	-13.68	46.00	45.49	17.90	1.00	32.07	---	---	Peak
5	561.80	31.88	-14.12	46.00	44.07	18.95	1.00	32.13	---	---	Peak
6	799.80	33.44	-12.56	46.00	43.62	20.80	1.20	32.18	---	---	Peak



Test Mode :	Mode 2	Temperature :	20~22°C
Test Channel :	06	Relative Humidity :	48~50%
Test Engineer :	Sam Chen	Polarization :	Horizontal
Remark :			

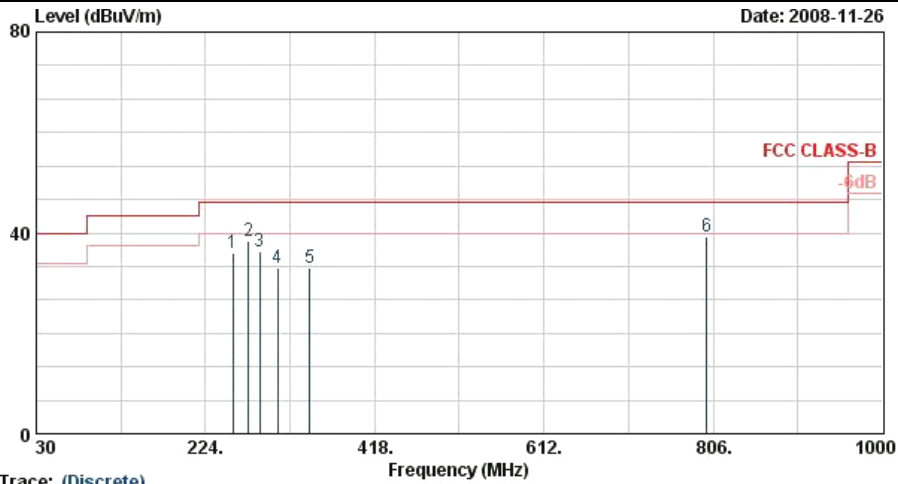

Trace: (Discrete)  
 Site : 03CH06-HV  
 Condition : FCC CLASS-B 3m B1LOG\_081124 HORIZONTAL  
 Model : FR 8N1310-01  
 Mode : Mode 2

	Freq	Level	Over	Limit	Read	Antenna	Cable	Preamp	Ant	Table	Remark
	MHz	dBuV/m	Limit	Line	Level	Factor	Loss	Factor	Pos	Pos	
			dB	dBuV/m	dBuV	dB/m	dB	dB	cm	deg	
1	255.18	35.96	-10.04	46.00	53.79	13.30	0.70	31.83	---	---	Peak
2	273.54	38.23	-7.77	46.00	55.99	13.50	0.70	31.96	---	---	Peak
3	286.23	36.37	-9.63	46.00	54.10	13.62	0.70	32.05	---	---	Peak
4	306.30	33.07	-12.93	46.00	50.30	14.09	0.76	32.09	---	---	Peak
5	343.40	32.92	-13.08	46.00	48.76	15.11	0.80	31.75	---	---	Peak
6	798.40	39.32	-6.68	46.00	49.52	20.78	1.20	32.18	100	332	Peak



Test Mode :	Mode 2	Temperature :	20~22°C
Test Channel :	06	Relative Humidity :	48~50%
Test Engineer :	Sam Chen	Polarization :	Vertical
Remark :			

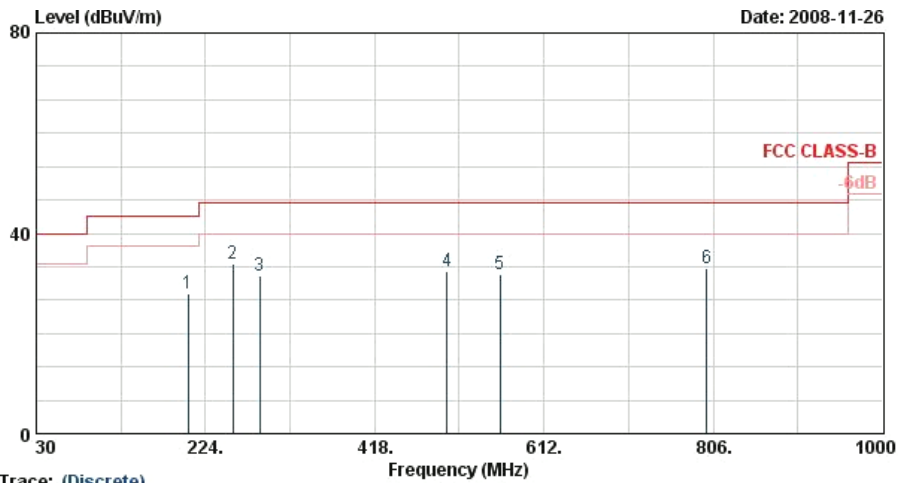

Trace: (Discrete)

Site : 03CH06-HY  
 Condition : FCC CLASS-B 3m BTLOC\_081124 VERTICAL  
 Model : FR 8N1310-01  
 Name : Mode 2

	Freq	Level	Over	Limit	Read	Antenna	Cable	Preamp	Ant	Table	Remark
	MHz	dBuV/m	dB	dBuV/m	dBuV	dB/m	dB	dB	cm	deg	
1	203.88	27.88	-15.62	43.50	48.98	10.45	0.60	32.15	---	---	Peak
2	255.18	33.84	-12.16	46.00	51.66	13.30	0.70	31.83	100	320	Peak
3	286.23	31.53	-14.47	46.00	49.27	13.62	0.70	32.05	---	---	Peak
4	500.90	32.34	-13.66	46.00	45.51	17.90	1.00	32.07	---	---	Peak
5	561.80	31.83	-14.17	46.00	44.02	18.95	1.00	32.13	---	---	Peak
6	798.40	33.10	-12.90	46.00	43.29	20.78	1.20	32.18	---	---	Peak



Test Mode :	Mode 3	Temperature :	20~22°C
Test Channel :	11	Relative Humidity :	48~50%
Test Engineer :	Sam Chen	Polarization :	Horizontal
Remark :			

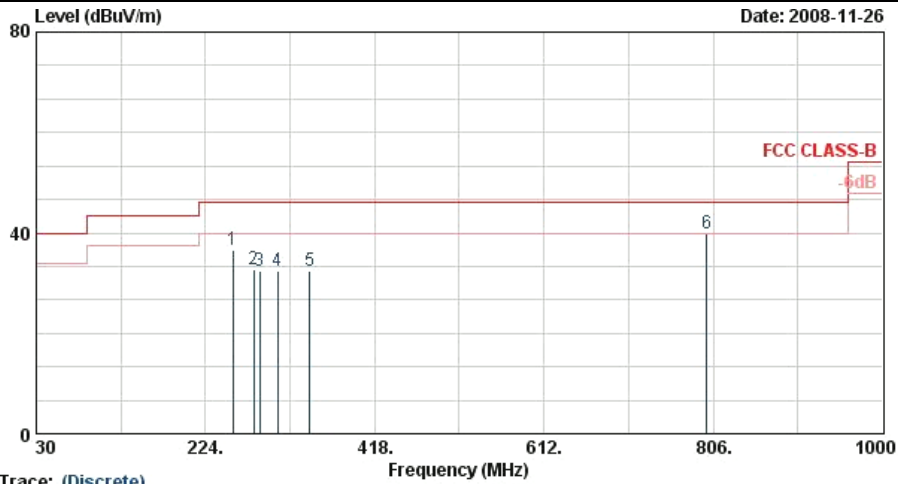

Trace: (Discrete)  
 Site : 03CH06-HV  
 Condition : FCC CLASS-B 3m B1LOG\_081124 HORIZONTAL  
 Model : FR 8N1310-01  
 Mode : Mode 3

	Freq	Level	Over	Limit	Read	Antenna	Cable	Preamp	Ant	Table	Remark
	MHz	dBuV/m	Limit	Line	Level	Factor	Loss	Factor	Pos	Pos	
			dB	dBuV/m	dBuV	dB/m	dB	dB	cm	deg	
1	255.18	36.52	-9.48	46.00	54.34	13.30	0.70	31.83	---	---	Peak
2	279.48	32.66	-13.34	46.00	50.46	13.50	0.70	32.00	---	---	Peak
3	286.23	32.40	-13.60	46.00	50.13	13.62	0.70	32.05	---	---	Peak
4	306.30	32.47	-13.53	46.00	49.71	14.09	0.76	32.09	---	---	Peak
5	343.40	32.28	-13.72	46.00	48.12	15.11	0.80	31.75	---	---	Peak
6 @	798.40	39.84	-6.16	46.00	50.04	20.78	1.20	32.18	100	332	Peak



Test Mode :	Mode 3	Temperature :	20~22°C
Test Channel :	11	Relative Humidity :	48~50%
Test Engineer :	Sam Chen	Polarization :	Vertical
Remark :			

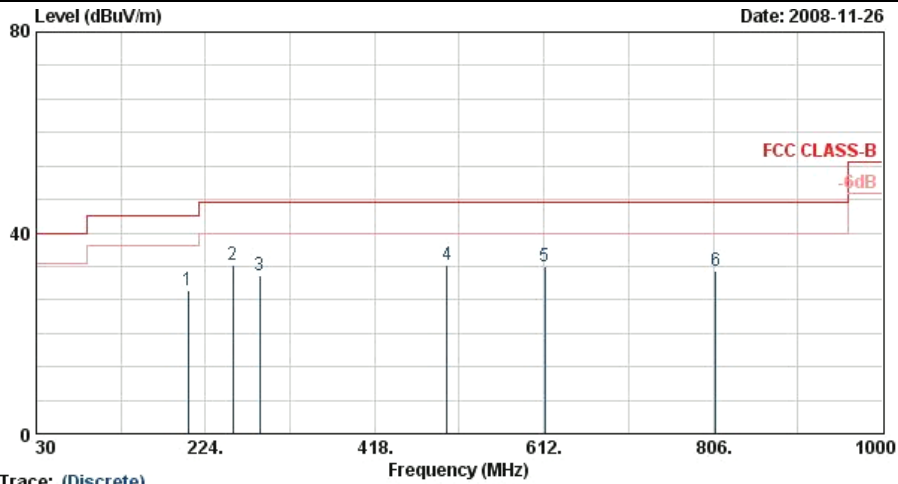

Trace: (Discrete)  
 Site : 03CH06-HV  
 Condition : FCC CLASS-B 3m B10C\_081124 VERTICAL  
 Model : FR 8N1310-01  
 Mode : Mode 3

	Freq	Level	Over	Limit	Read	Antenna	Cable	Preamp	Ant	Table	Remark
	MHz	dBuV/m	Limit	Line	Level	Factor	Loss	Factor	Pos	Pos	
			dB	dBuV/m	dBuV	dB/m	dB	dB	cm	deg	
1	203.88	28.65	-14.85	43.50	49.76	10.45	0.60	32.15	---	---	Peak
2	255.18	33.55	-12.45	46.00	51.38	13.30	0.70	31.83	---	---	Peak
3	286.23	31.59	-14.41	46.00	49.32	13.62	0.70	32.05	---	---	Peak
4	500.90	33.68	-12.32	46.00	46.85	17.90	1.00	32.07	100	335	Peak
5	612.90	33.17	-12.83	46.00	45.04	19.20	1.03	32.10	---	---	Peak
6	808.90	32.31	-13.69	46.00	42.42	20.91	1.20	32.22	---	---	Peak



Test Mode :	Mode 8	Temperature :	20~22°C
Test Channel :	03	Relative Humidity :	48~50%
Test Engineer :	Sam Chen	Polarization :	Horizontal
Remark :			

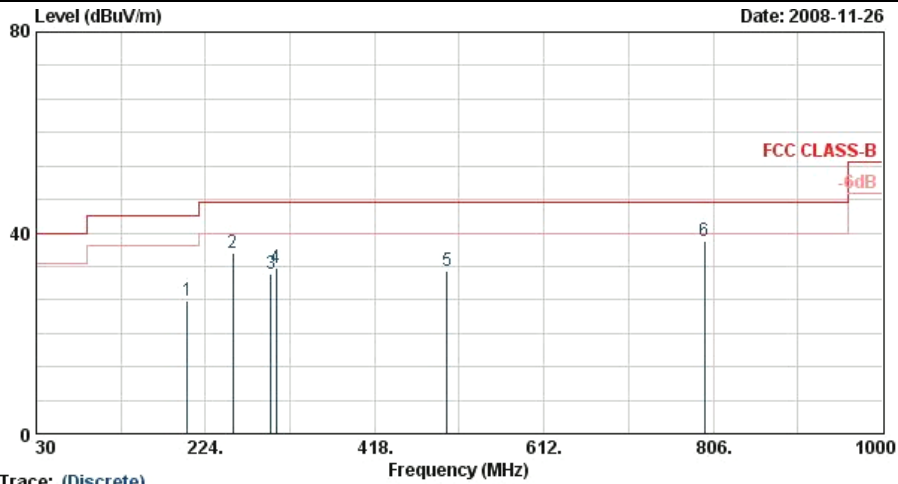

Trace: (Discrete)  
 Site : 03CH06-HV  
 Condition : FCC CLASS-B 3m B10C\_081124 HORIZONTAL  
 Model : FR 8N1310-01  
 Mode : Mode 8

	Freq	Level	Over	Limit	ReadAntenna	Cable	Preamp	Ant	Table	Remark
	MHz	dBuV/m	Limit	Line	Level	Loss	Factor	Pos	Pos	
			dB	dBuV/m	dBuV	dB	dB	cm	deg	
1	203.34	26.53	-16.97	43.50	47.64	10.45	0.60	32.15	---	Peak
2	255.18	35.90	-10.10	46.00	53.72	13.30	0.70	31.83	---	Peak
3	299.19	31.86	-14.14	46.00	49.41	13.90	0.70	32.15	---	Peak
4	304.90	33.06	-12.94	46.00	50.39	14.03	0.75	32.11	---	Peak
5	500.90	32.29	-13.71	46.00	45.46	17.90	1.00	32.07	---	Peak
6 @	796.30	38.45	-7.55	46.00	48.66	20.76	1.20	32.17	100	332 Peak



Test Mode :	Mode 8	Temperature :	20~22°C
Test Channel :	03	Relative Humidity :	48~50%
Test Engineer :	Sam Chen	Polarization :	Vertical
Remark :			

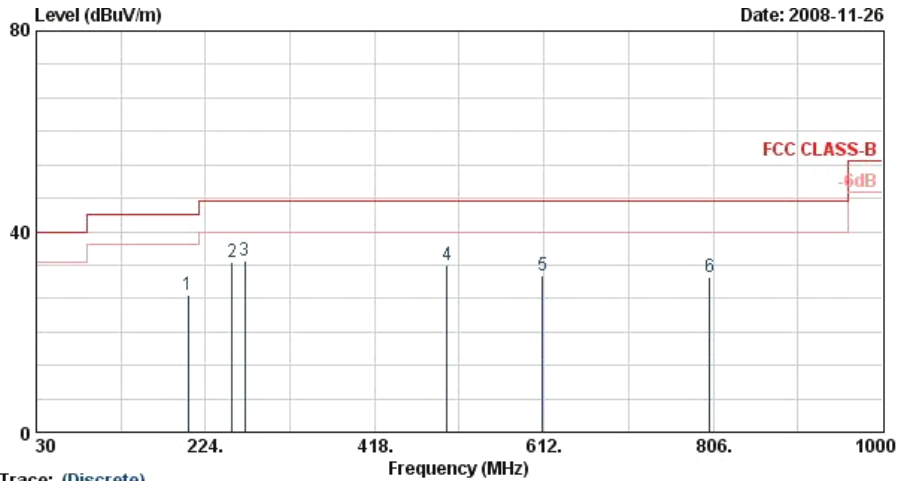

Trace: (Discrete)

Site : 03CH06-HY  
 Condition : FCC CLASS-B 3m BILOG\_081124 VERTICAL  
 Model : FR 8N1310-01  
 Mode : Mode 8

	Freq	Level	Over	Limit	Read	Antenna	Cable	Preamp	Ant	Table	Remark
	MHz	dBuV/m	dB	dBuV/m	dBuV	dB/m	dB	dB	cm	deg	
1	203.88	27.31	-16.19	43.50	48.42	10.45	0.60	32.15	---	---	Peak
2	254.64	33.98	-12.02	46.00	51.80	13.30	0.70	31.83	---	---	Peak
3	269.49	34.24	-11.76	46.00	51.97	13.50	0.70	31.93	100	301	Peak
4	500.90	33.21	-12.79	46.00	46.38	17.90	1.00	32.07	---	---	Peak
5	610.80	31.33	-14.67	46.00	43.24	19.19	1.01	32.12	---	---	Peak
6	801.90	30.92	-15.08	46.00	41.08	20.82	1.20	32.19	---	---	Peak



Test Mode :	Mode 9	Temperature :	20~22°C
Test Channel :	06	Relative Humidity :	48~50%
Test Engineer :	Sam Chen	Polarization :	Horizontal
Remark :			

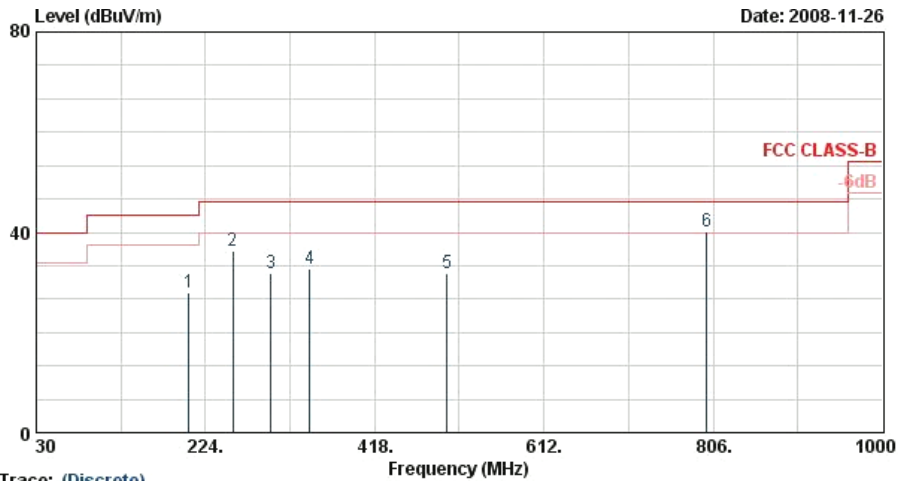

Site :  
Condition :  
Model :  
Name :

Trace: (Discrete)  
: 03CH06-HY  
: FCC CLASS-B 3m B1LOC\_081124 HORIZONTAL  
: FR 8N1310-01  
: Mode 9

	Freq	Level	Over	Limit	Read	Antenna	Cable	Preamp	Ant	Table	Remark
	MHz	dBuV/m	dB	dBuV/m	dBuV	dB/m	dB	dB	cm	deg	
1	204.69	27.94	-15.56	43.50	49.02	10.48	0.60	32.16	---	---	Peak
2	255.18	36.24	-9.76	46.00	54.07	13.30	0.70	31.83	---	---	Peak
3	299.19	31.89	-14.11	46.00	49.44	13.90	0.70	32.15	---	---	Peak
4	343.40	32.60	-13.40	46.00	48.44	15.11	0.80	31.75	---	---	Peak
5	500.90	31.84	-14.16	46.00	45.01	17.90	1.00	32.07	---	---	Peak
6 @	798.40	40.16	-5.84	46.00	50.35	20.78	1.20	32.18	100	352	Peak





Test Mode :	Mode 9	Temperature :	20~22°C
Test Channel :	06	Relative Humidity :	48~50%
Test Engineer :	Sam Chen	Polarization :	Vertical
Remark :			

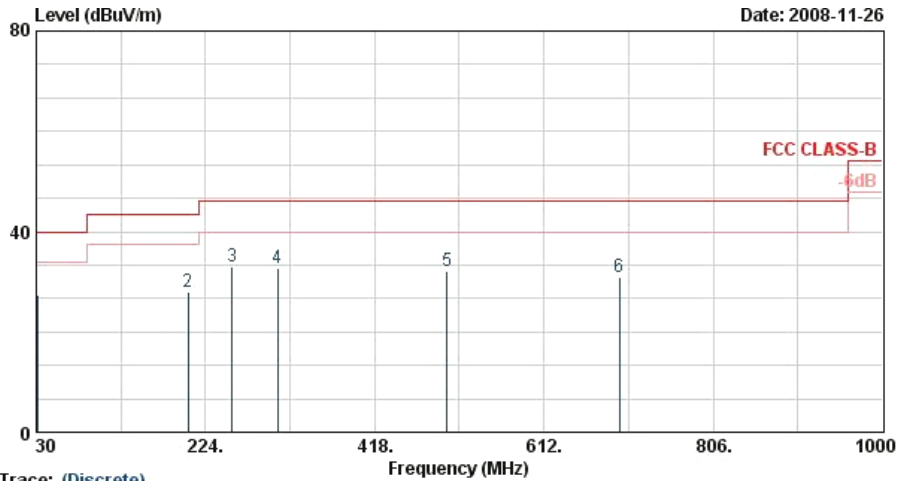

Trace: (Discrete)

Site : 03CH06-HY  
 Condition : FCC CLASS-B 3m BILOG\_081124 VERTICAL  
 Model : FR 8N1310-01  
 Mode : Mode 9

	Freq	Level	Over Limit	Limit Line	Read Level	Antenna Factor	Cable Loss	Preamp Factor	Ant Pos	Table Pos	Remark
	MHz	dBuV/m	dB	dBuV/m	dBuV	dB/m	dB	dB	cm	deg	
1	31.08	27.38	-12.62	40.00	39.39	19.30	0.30	31.61	100	350	Peak
2	203.88	27.95	-15.55	43.50	49.06	10.45	0.60	32.15	---	---	Peak
3	254.64	32.99	-13.01	46.00	50.82	13.30	0.70	31.83	---	---	Peak
4	306.30	32.84	-13.16	46.00	50.07	14.09	0.76	32.09	---	---	Peak
5	500.90	32.27	-13.73	46.00	45.44	17.90	1.00	32.07	---	---	Peak
6	698.30	31.08	-14.92	46.00	42.74	19.69	1.10	32.46	---	---	Peak



Test Mode :	Mode 10	Temperature :	20~22°C
Test Channel :	09	Relative Humidity :	48~50%
Test Engineer :	Sam Chen	Polarization :	Horizontal
Remark :			

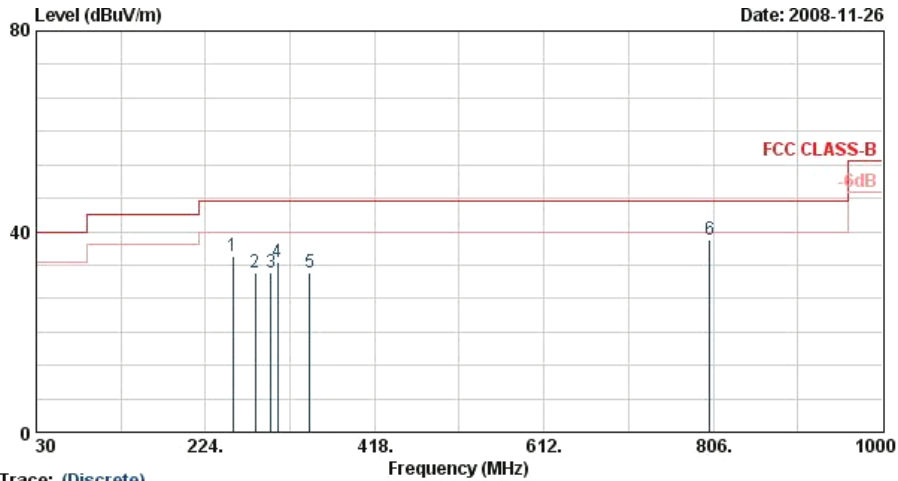

Trace: (Discrete)

Site : 03CH06-HY  
 Condition : FCC CLASS-B 3m BILOG\_081124 HORIZONTAL  
 Model : FR 8N1310-01  
 Mode : Mode 10

	Freq	Level	Over Limit	Limit Line	ReadAntenna Level	Antenna Factor	Cable Loss	Preamp Factor	Ant Pos	Table Pos	Remark
	MHz	dBuV/m	dB	dBuV/m	dBuV	dB/m	dB	dB	cm	deg	
1	255.18	35.09	-10.91	46.00	52.91	13.30	0.70	31.83	---	---	Peak
2	280.83	31.77	-14.23	46.00	49.57	13.52	0.70	32.02	---	---	Peak
3	299.19	31.70	-14.30	46.00	49.25	13.90	0.70	32.15	---	---	Peak
4	306.30	33.99	-12.01	46.00	51.23	14.09	0.76	32.09	---	---	Peak
5	343.40	31.68	-14.32	46.00	47.52	15.11	0.80	31.75	---	---	Peak
6 @	801.90	38.28	-7.72	46.00	48.45	20.82	1.20	32.19	100	332	Peak



Test Mode :	Mode 10	Temperature :	20~22°C
Test Channel :	09	Relative Humidity :	48~50%
Test Engineer :	Sam Chen	Polarization :	Vertical
Remark :			

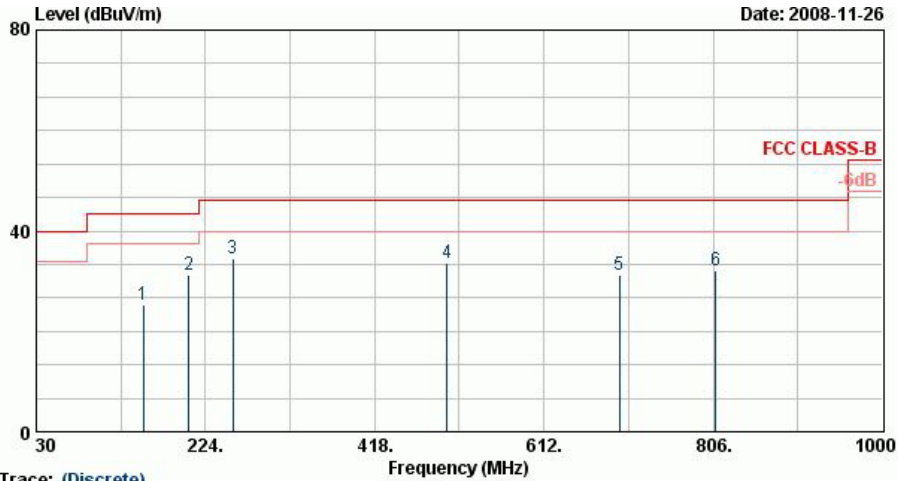

Trace: (Discrete)

Site : 03CH06-HV  
 Condition : FCC CLASS-B 3m BILOG\_081124 VERTICAL  
 Model : FR 8N1310-01  
 Mode : Mode 10

	Freq	Level	Over Limit	Limit Line	Read Level	Antenna Factor	Cable Loss	Preamp Factor	Ant Pos	Table Pos	Remark
	MHz	dBuV/m	dB	dBuV/m	dBuV	dB/m	dB	dB	cm	deg	
1	152.58	25.15	-18.35	43.50	45.18	11.10	0.60	31.73	---	---	Peak
2	204.69	31.28	-12.22	43.50	52.36	10.48	0.60	32.16	---	---	Peak
3	255.18	34.62	-11.38	46.00	52.44	13.30	0.70	31.83	100	356	Peak
4	500.90	33.60	-12.40	46.00	46.77	17.90	1.00	32.07	---	---	Peak
5	698.30	31.30	-14.70	46.00	42.96	19.69	1.10	32.46	---	---	Peak
6	808.90	32.14	-13.86	46.00	42.26	20.91	1.20	32.22	---	---	Peak



3.6.6 Test Result of Radiated Emission ≥ 1GHz

Test Mode :	Mode 1	Temperature :	20~22°C
Test Channel :	01	Relative Humidity :	48~50%
Test Engineer :	Sam Chen	Polarization :	Horizontal
Remark :	#5 and #6 are Fundamental Signals		

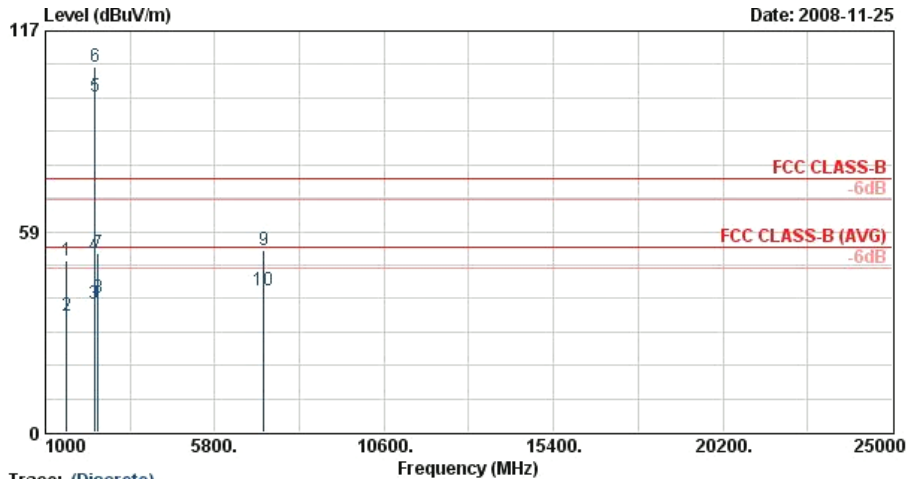

Trace: (Discrete)

Site : 03CH06-HY  
 Condition : FCC CLASS-B 3m SHF-EHF HORN HORIZONTAL  
 Model : FR 8N1310-01  
 Mode : Mode 1

	Freq	Level	Over	Limit	Read	Antenna	Cable	Preamp	Ant	Table	Remark
	MHz	dBuV/m	dB	dBuV/m	dBuV	dB/m	dB	dB	cm	deg	
1	1606.00	50.21	-23.79	74.00	54.90	28.82	2.93	36.44	100	0	Peak
2	1606.00	33.82	-20.18	54.00	38.51	28.82	2.93	36.44	100	279	Average
3	2388.85	37.26	-16.74	54.00	37.64	31.98	3.92	36.28	100	314	Average
4	2388.85	51.12	-22.88	74.00	51.50	31.98	3.92	36.28	100	0	Peak
5 @	2412.00	97.85			98.18	32.00	3.95	36.28	100	314	Average
6 @	2412.00	106.44			106.77	32.00	3.95	36.28	100	0	Peak
7	2494.00	52.00	-22.00	74.00	52.15	32.10	4.05	36.30	100	0	Peak
8	2494.00	38.96	-15.04	54.00	39.11	32.10	4.05	36.30	100	314	Average
9	7182.00	53.25	-20.75	74.00	46.94	35.62	7.16	36.47	100	0	Peak
10	7182.00	41.41	-12.59	54.00	35.10	35.62	7.16	36.47	1001	136	Average



Test Mode :	Mode 1	Temperature :	20~22°C
Test Channel :	01	Relative Humidity :	48~50%
Test Engineer :	Sam Chen	Polarization :	Vertical
Remark :	#7 and #8 are Fundamental Signals		

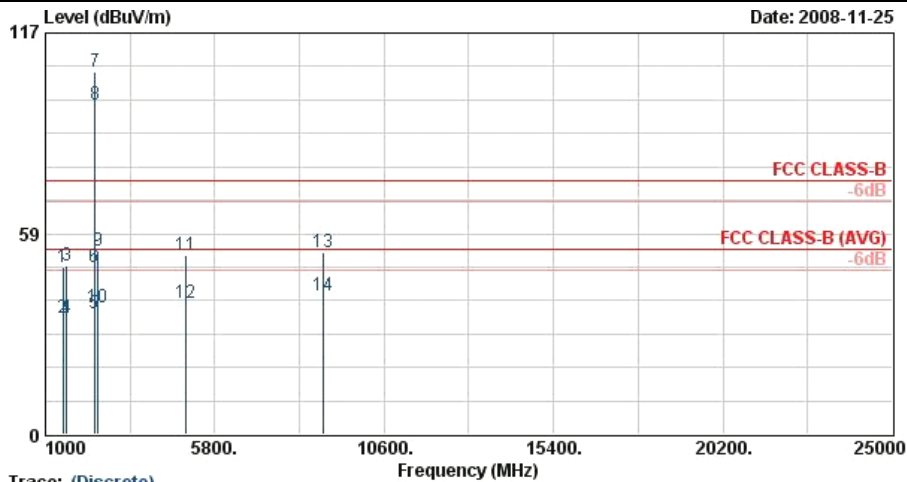

Trace: (Discrete)  
 Site : 03CH06-HY  
 Condition : FCC CLASS-B 3m SHF-EHF HORN VERTICAL  
 Model : FR 8N1310-01  
 Name : Mode 1

	Freq	Level	Over	Limit	Read	Antenna	Cable	Preamp	Ant	Table	Remark
	MHz	dBuV/m	Limit	Line	Level	Factor	Loss	Factor	Pos	Pos	
			dB	dBuV/m	dBuV	dB/m	dB	dB	cm	deg	
1	1500.00	48.81	-25.19	74.00	54.49	28.00	2.82	36.50	100	0	Peak
2	1500.00	33.94	-20.06	54.00	39.62	28.00	2.82	36.50	100	178	Average
3	1606.00	48.93	-25.07	74.00	53.62	28.82	2.93	36.44	100	0	Peak
4	1606.00	34.08	-19.92	54.00	38.77	28.82	2.93	36.44	100	250	Average
5	2388.85	35.17	-18.83	54.00	35.55	31.98	3.92	36.28	100	345	Average
6	2388.85	48.58	-25.42	74.00	48.96	31.98	3.92	36.28	100	0	Peak
7 @	2412.00	105.61			105.94	32.00	3.95	36.28	100	0	Peak
8 @	2412.00	96.07			96.40	32.00	3.95	36.28	100	345	Average
9	2500.00	53.53	-20.47	74.00	53.68	32.10	4.05	36.30	100	0	Peak
10	2500.00	36.89	-17.11	54.00	37.04	32.10	4.05	36.30	100	345	Average
11	4986.00	51.98	-22.02	74.00	47.71	34.49	5.88	36.11	100	0	Peak
12	4986.00	38.27	-15.73	54.00	34.00	34.49	5.88	36.11	100	345	Average
13	8871.00	52.95	-21.05	74.00	46.08	36.07	7.65	36.85	100	0	Peak
14	8871.00	40.36	-13.64	54.00	33.49	36.07	7.65	36.85	100	26	Average



Test Mode :	Mode 2	Temperature :	20~22°C
Test Channel :	06	Relative Humidity :	48~50%
Test Engineer :	Sam Chen	Polarization :	Horizontal
Remark :	#3 and #4 are Fundamental Signals		

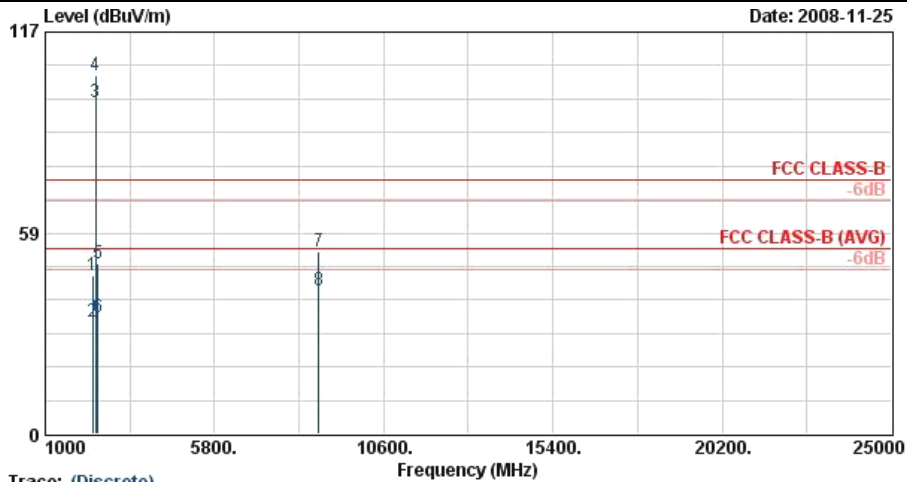

Site :  
Condition :  
Model :  
Name :

Trace: (Discrete)  
: 03CH06-HV  
: FCC CLASS-B 3m SHF-EHF HORN HORIZONTAL  
: FR 8N1310-01  
: Mode 2

	Freq	Level	Over	Limit	Read	Antenna	Cable	Preamp	Ant	Table	
	MHz	dBuV/m	Limit	Line	Level	Factor	Loss	Factor	Pos	Pos	Remark
			dB	dBuV/m	dBuV	dB/m	dB	dB	cm	deg	
1	2350.00	46.13	-27.87	74.00	46.63	31.91	3.86	36.27	100	0	Peak
2	2350.00	32.78	-21.22	54.00	33.28	31.91	3.86	36.27	100	310	Average
3 @	2437.00	96.70			96.96	32.04	3.99	36.29	100	310	Average
4 X	2437.00	104.58			104.84	32.04	3.99	36.29	100	0	Peak
5	2494.00	49.54	-24.46	74.00	49.69	32.10	4.05	36.30	100	0	Peak
6	2494.00	33.93	-20.07	54.00	34.08	32.10	4.05	36.30	100	310	Average
7	8766.00	52.96	-21.04	74.00	46.27	35.97	7.53	36.81	100	0	Peak
8	8766.00	41.81	-12.19	54.00	35.12	35.97	7.53	36.81	100	96	Average



Test Mode :	Mode 2	Temperature :	20~22°C
Test Channel :	06	Relative Humidity :	48~50%
Test Engineer :	Sam Chen	Polarization :	Vertical
Remark :	#5 and #6 are Fundamental Signals		

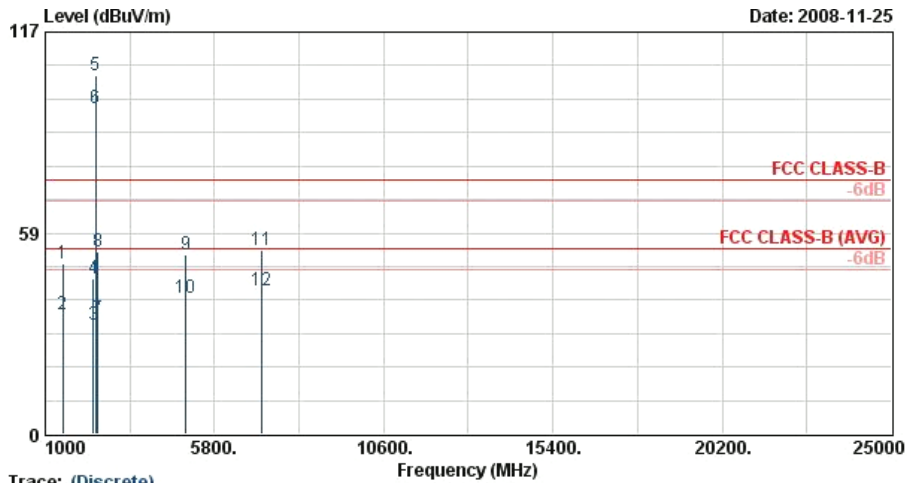

Trace: (Discrete)

Site : 03CH06-HY  
 Condition : FCC CLASS-B 3m SHF-EHF HORN VERTICAL  
 Model : FR 8N1310-01  
 Name : Mode 2

	Freq	Level	Over	Limit	Read	Antenna	Cable	Preamp	Ant	Table	Remark
	MHz	dBuV/m	dB	dBuV/m	dBuV	dB/m	dB	dB	cm	deg	
1	1500.00	49.68	-24.32	74.00	55.36	28.00	2.82	36.50	100	0	Peak
2	1500.00	34.99	-19.01	54.00	40.67	28.00	2.82	36.50	100	181	Average
3	2372.00	31.57	-22.43	54.00	32.00	31.96	3.89	36.28	197	299	Average
4	2372.00	45.29	-28.71	74.00	45.73	31.96	3.89	36.28	100	0	Peak
5 X	2437.00	104.44			104.70	32.04	3.99	36.29	100	0	Peak
6 @	2437.00	94.92			95.18	32.04	3.99	36.29	197	299	Average
7	2494.00	33.46	-20.54	54.00	33.61	32.10	4.05	36.30	197	299	Average
8	2494.00	52.91	-21.09	74.00	53.06	32.10	4.05	36.30	100	0	Peak
9	4992.00	52.25	-21.75	74.00	47.96	34.50	5.88	36.10	100	0	Peak
10	4992.00	39.74	-14.26	54.00	35.46	34.50	5.88	36.10	100	243	Average
11	7131.00	53.39	-20.61	74.00	47.06	35.64	7.13	36.45	100	0	Peak
12	7131.00	41.80	-32.20	74.00	35.47	35.64	7.13	36.45	100	171	Peak



Test Mode :	Mode 3	Temperature :	20~22°C
Test Channel :	11	Relative Humidity :	48~50%
Test Engineer :	Sam Chen	Polarization :	Horizontal
Remark :	#3 and #4 are Fundamental Signals		

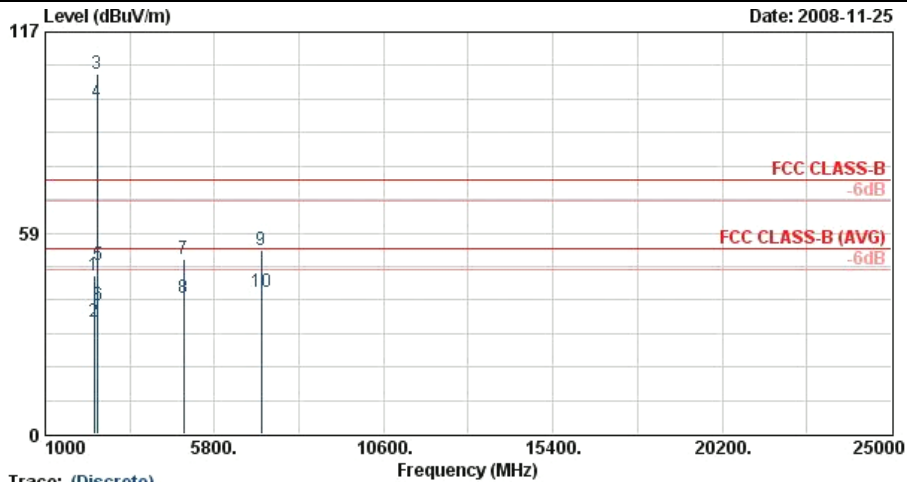

Trace: (Discrete)  
 Site : 03CH06-HV  
 Condition : FCC CLASS-B 3m SHF-EHF HORN HORIZONTAL  
 Model : FR 8N1310-01  
 Mode : Mode 3

	Freq	Level	Over	Limit	Read	Antenna	Cable	Preamp	Ant	Table	
	MHz	dBuV/m	Limit	Line	Level	Factor	Loss	Factor	Pos	Pos	Remark
			dB	dBuV/m	dBuV	dB/m	dB	dB	cm	deg	
1	2380.00	46.30	-27.70	74.00	46.70	31.96	3.92	36.28	100	0	Peak
2	2380.00	32.46	-21.54	54.00	32.67	32.06	4.02	36.29	100	306	Average
3 @	2462.00	104.90			105.11	32.06	4.02	36.29	100	0	Peak
4 @	2462.00	96.44			96.65	32.06	4.02	36.29	100	306	Average
5	2483.50	49.20	-24.80	74.00	49.37	32.08	4.05	36.30	100	0	Peak
6	2483.50	37.23	-16.77	54.00	37.40	32.08	4.05	36.30	100	306	Average
7	4926.00	50.77	-23.23	74.00	46.56	34.47	5.85	36.12	100	0	Peak
8	4926.00	39.57	-14.43	54.00	35.36	34.47	5.85	36.12	100	303	Average
9	7122.00	53.52	-20.48	74.00	47.18	35.65	7.13	36.45	100	0	Peak
10	7122.00	41.21	-12.79	54.00	34.88	35.65	7.13	36.45	100	19	Average





Test Mode :	Mode 3	Temperature :	20~22°C
Test Channel :	11	Relative Humidity :	48~50%
Test Engineer :	Sam Chen	Polarization :	Vertical
Remark :	#5 and #6 are Fundamental Signals		

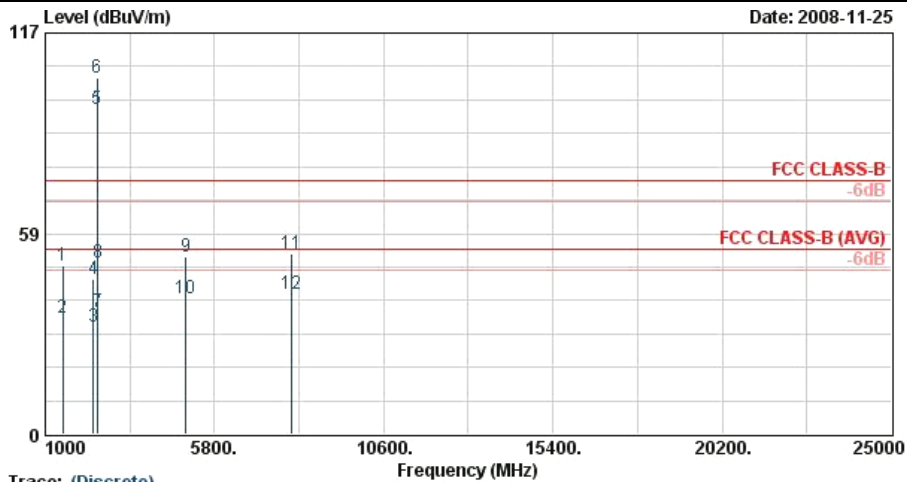

Trace: (Discrete)  
 Site : 03CH06-HY  
 Condition : FCC CLASS-B 3m SHF-EHF HORN VERTICAL  
 Model : FR 8N1310-01  
 Mode : Mode 3

	Freq	Level	Over	Limit	Read	Antenna	Cable	Preamp	Ant	Table	
	MHz	dBuV/m	Limit	Line	Level	Factor	Loss	Factor	Pos	Pos	Remark
			dB	dBuV/m	dBuV	dB/m	dB	dB	cm	deg	
1	1494.00	49.00	-25.00	74.00	54.71	28.00	2.82	36.54	100	0	Peak
2	1494.00	33.82	-20.19	54.00	39.53	28.00	2.82	36.54	100	302	Average
3	2374.00	31.11	-22.89	54.00	31.54	31.96	3.89	36.28	103	79	Average
4	2374.00	45.17	-28.83	74.00	45.61	31.96	3.89	36.28	100	0	Peak
5 @	2462.00	94.83			95.04	32.06	4.02	36.29	103	79	Average
6 @	2462.00	103.91			104.13	32.06	4.02	36.29	100	0	Peak
7	2499.05	35.52	-18.48	54.00	35.67	32.10	4.05	36.30	103	79	Average
8	2499.05	49.86	-24.14	74.00	50.01	32.10	4.05	36.30	100	0	Peak
9	4992.00	51.84	-22.16	74.00	47.55	34.50	5.88	36.10	100	0	Peak
10	4992.00	39.36	-14.64	54.00	35.08	34.50	5.88	36.10	100	19	Average
11	7992.00	52.46	-21.54	74.00	45.96	35.69	7.51	36.70	100	0	Peak
12	7992.00	40.97	-13.03	54.00	34.46	35.69	7.51	36.70	100	149	Average



Test Mode :	Mode 4	Temperature :	20~22°C
Test Channel :	01	Relative Humidity :	48~50%
Test Engineer :	Sam Chen	Polarization :	Horizontal
Remark :	#3 and #4 are Fundamental Signals		

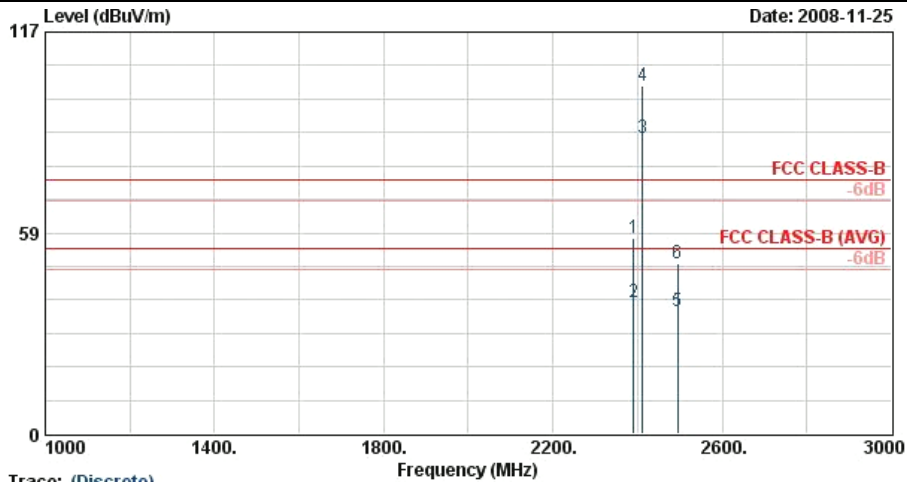

Trace: (Discrete)  
 Site : 03CH06-HV  
 Condition : FCC CLASS-B 3m HF-ANT\_060621 HORIZONTAL  
 Model : FR 8N1310-01  
 Mode : Mode 4

	Freq	Level	Over	Limit	Read	Antenna	Cable	Preamp	Ant	Table	
	MHz	dBuV/m	Limit	Line	Level	Factor	Loss	Factor	Pos	Pos	Remark
			dB	dBuV/m	dBuV	dB/m	dB	dB	cm	deg	
1	2389.99	56.81	-17.19	74.00	57.19	31.98	3.92	36.28	100	0	Peak
2	2389.99	38.48	-15.52	54.00	38.86	31.98	3.92	36.28	100	316	Average
3 @	2412.00	86.08			86.41	32.00	3.95	36.28	100	316	Average
4 X	2412.00	101.31			101.64	32.00	3.95	36.28	100	0	Peak
5	2494.00	35.66	-18.34	54.00	35.81	32.10	4.05	36.30	100	316	Average
6	2494.00	49.40	-24.60	74.00	49.55	32.10	4.05	36.30	100	0	Peak



Test Mode :	Mode 4	Temperature :	20~22°C
Test Channel :	01	Relative Humidity :	48~50%
Test Engineer :	Sam Chen	Polarization :	Vertical
Remark :	#5 and #6 are Fundamental Signals		

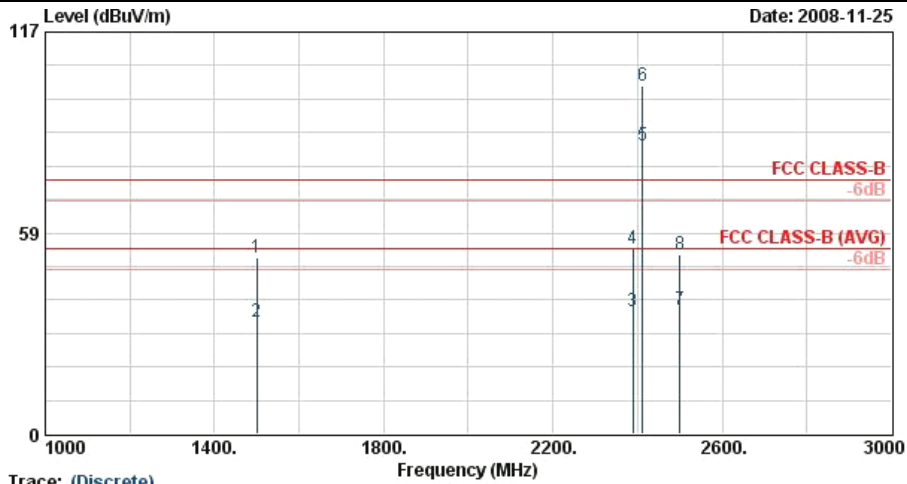

Site : 03CH06-HV  
 Condition : FCC CLASS-B 3m HF-ANT\_060821 VERTICAL  
 Model : FR 8N1310-01  
 Mode : Mode 4

	Freq	Level	Over	Limit	Read	Antenna	Cable	Preamp	Ant	Table	
	MHz	dBuV/m	Limit	Line	Level	Factor	Loss	Factor	Pos	Pos	Remark
			dB	dBuV/m	dBuV	dB/m	dB	dB	cm	deg	
1	1500.00	51.35	-22.65	74.00	57.03	28.00	2.82	36.50	100	0	Peak
2	1500.00	32.81	-21.19	54.00	38.49	28.00	2.82	36.50	168	347	Average
3	2389.61	35.87	-18.13	54.00	36.25	31.98	3.92	36.28	100	345	Average
4	2389.61	54.07	-19.93	74.00	54.45	31.98	3.92	36.28	100	0	Peak
5 X	2412.00	83.80			84.13	32.00	3.95	36.28	100	345	Average
6 X	2412.00	101.26			101.59	32.00	3.95	36.28	100	0	Peak
7	2500.00	35.90	-18.10	54.00	36.05	32.10	4.05	36.30	100	345	Average
8	2500.00	52.38	-21.62	74.00	52.53	32.10	4.05	36.30	100	0	Peak



Test Mode :	Mode 5	Temperature :	20~22°C
Test Channel :	11	Relative Humidity :	48~50%
Test Engineer :	Sam Chen	Polarization :	Horizontal
Remark :	#3 and #4 are Fundamental Signals		

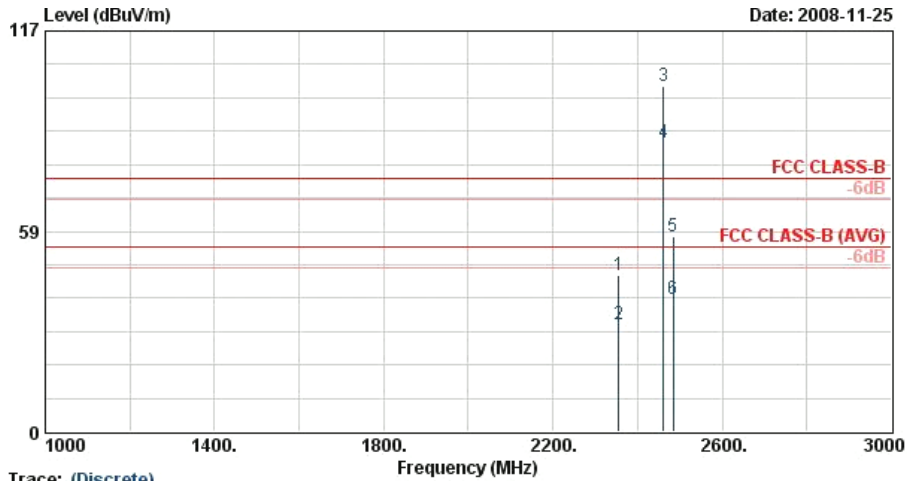

Trace: (Discrete)

Site : 03CH06-HY  
 Condition : FCC CLASS-B 3m HF-ANT\_060621 HORIZONTAL  
 Model : FR 8N1310-01  
 Name : Mode 5

	Freq	Level	Over Limit	Limit Line	ReadAntenna	Cable	Preamp	Ant	Table	Remark
	MHz	dBuV/m	dB	dBuV/m	dBuV	dB/m	dB	dB	cm	deg
1	2356.00	45.67	-28.33	74.00	46.15	31.93	3.86	36.27	100	0 Peak
2	2356.00	31.36	-22.64	54.00	31.84	31.93	3.86	36.27	100	306 Average
3 X	2462.00	100.70			100.91	32.06	4.02	36.29	100	0 Peak
4 @	2462.00	84.32			84.53	32.06	4.02	36.29	100	306 Average
5	2483.50	56.92	-17.08	74.00	57.08	32.08	4.05	36.30	100	0 Peak
6	2483.50	38.60	-15.40	54.00	38.77	32.08	4.05	36.30	100	306 Average



Test Mode :	Mode 5	Temperature :	20~22°C
Test Channel :	11	Relative Humidity :	48~50%
Test Engineer :	Sam Chen	Polarization :	Vertical
Remark :	#5 and #6 are Fundamental Signals		

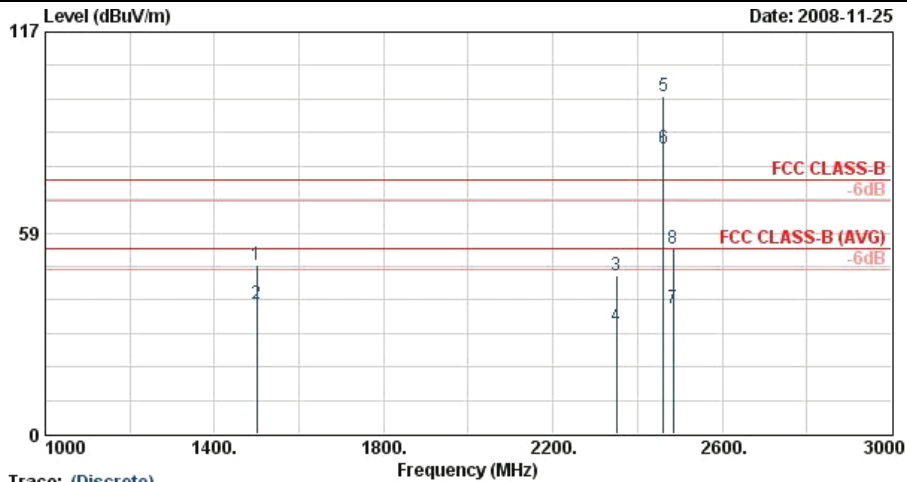

Trace: (Discrete)  
 Site : 03CH06-HV  
 Condition : FCC CLASS-B 3m HF-ANT\_060821 VERTICAL  
 Model : FR 8N1310-01  
 Mode : Mode 5

	Freq	Level	Over	Limit	Read	Antenna	Cable	Preamp	Ant	Table	Remark
	MHz	dBuV/m	dB	dBuV/m	dBuV	dB/m	dB	dB	cm	deg	
1	1500.00	48.95	-25.05	74.00	54.63	28.00	2.82	36.50	100	0	Peak
2	1500.00	37.70	-16.30	54.00	43.38	28.00	2.82	36.50	108	180	Average
3	2350.00	46.22	-27.78	74.00	46.72	31.91	3.86	36.27	100	0	Peak
4	2350.00	31.37	-22.63	54.00	31.87	31.91	3.86	36.27	108	279	Average
5 X	2462.00	98.16			98.37	32.06	4.02	36.29	100	0	Peak
6 X	2462.00	83.18			83.39	32.06	4.02	36.29	108	279	Average
7	2483.50	36.33	-17.67	54.00	36.50	32.08	4.05	36.30	108	279	Average
8	2483.50	53.88	-20.12	74.00	54.05	32.08	4.05	36.30	100	0	Peak



Test Mode :	Mode 6	Temperature :	20~22°C
Test Channel :	01	Relative Humidity :	48~50%
Test Engineer :	Sam Chen	Polarization :	Horizontal
Remark :	#3 and #4 are Fundamental Signals		

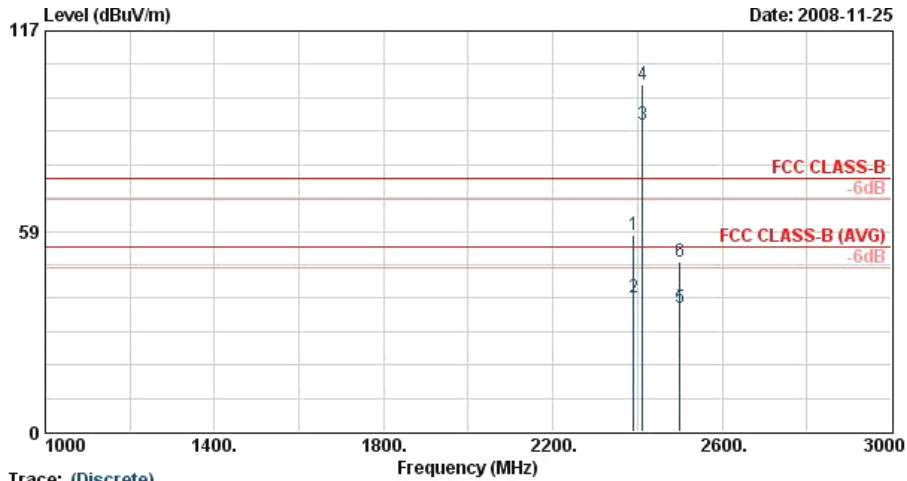

Trace: (Discrete)

Site : 03CH06-HY  
 Condition : FCC CLASS-B 3m HF-ANT\_060621 HORIZONTAL  
 Model : FR 8N1310-01  
 Name : Mode 6

	Freq	Level	Over Limit	Limit Line	Read Level	Antenna Factor	Cable Loss	Preamp Factor	Ant Pos	Table Pos	Remark
	MHz	dBuV/m	dB	dBuV/m	dBuV	dB/m	dB	dB	cm	deg	
1	2389.99	57.21	-16.79	74.00	57.59	31.98	3.92	36.28	100	0	Peak
2	2389.99	39.04	-14.96	54.00	39.42	31.98	3.92	36.28	100	300	Average
3 @	2412.00	89.43			89.76	32.00	3.95	36.28	100	300	Average
4 X	2412.00	101.13			101.46	32.00	3.95	36.28	100	0	Peak
5	2500.00	36.10	-17.90	54.00	36.25	32.10	4.05	36.30	100	300	Average
6	2500.00	49.73	-24.27	74.00	49.88	32.10	4.05	36.30	100	0	Peak



Test Mode :	Mode 6	Temperature :	20~22°C
Test Channel :	01	Relative Humidity :	48~50%
Test Engineer :	Sam Chen	Polarization :	Vertical
Remark :	#5 and #6 are Fundamental Signals		

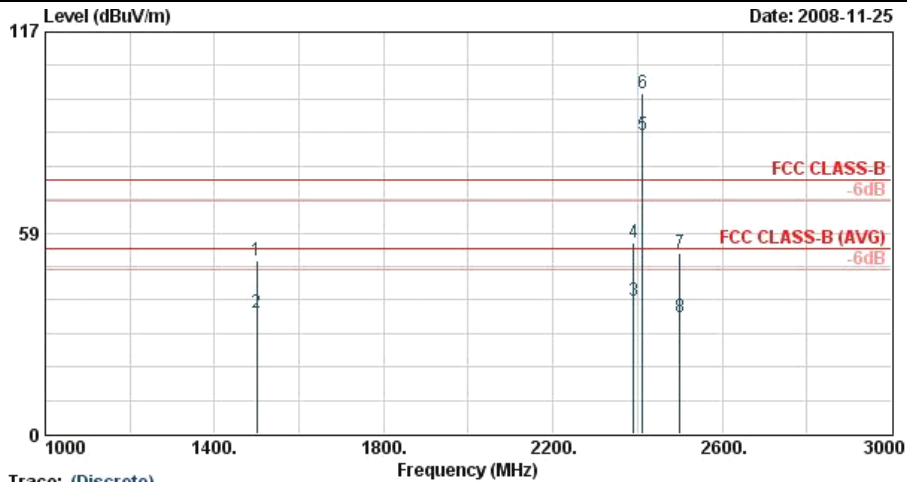

Trace: (Discrete)  
 Site : 03CH06-HV  
 Condition : FCC CLASS-B 3m HF-ANT\_060821 VERTICAL  
 Model : FR 8N1310-01  
 Mode : Mode 6

	Freq	Level	Over	Limit	Read	Antenna	Cable	Preamp	Ant	Table	
	MHz	dBuV/m	Limit	Line	Level	Factor	Loss	Factor	Pos	Pos	Remark
			dB	dBuV/m	dBuV	dB/m	dB	dB	cm	deg	
1	1500.00	50.36	-23.64	74.00	56.04	28.00	2.82	36.50	100	0	Peak
2	1500.00	35.26	-18.74	54.00	40.94	28.00	2.82	36.50	100	184	Average
3	2390.00	38.83	-15.17	54.00	39.21	31.98	3.92	36.28	100	349	Average
4	2390.00	55.80	-18.20	74.00	56.19	31.98	3.92	36.28	100	0	Peak
5 X	2412.00	86.80			87.13	32.00	3.95	36.28	100	349	Average
6 X	2412.00	99.28			99.61	32.00	3.95	36.28	100	0	Peak
7	2500.00	52.52	-21.48	74.00	52.67	32.10	4.05	36.30	100	0	Peak
8	2500.00	33.97	-20.03	54.00	34.12	32.10	4.05	36.30	100	349	Average



Test Mode :	Mode 7	Temperature :	20~22°C
Test Channel :	11	Relative Humidity :	48~50%
Test Engineer :	Sam Chen	Polarization :	Horizontal
Remark :	#3 and #4 are Fundamental Signals		

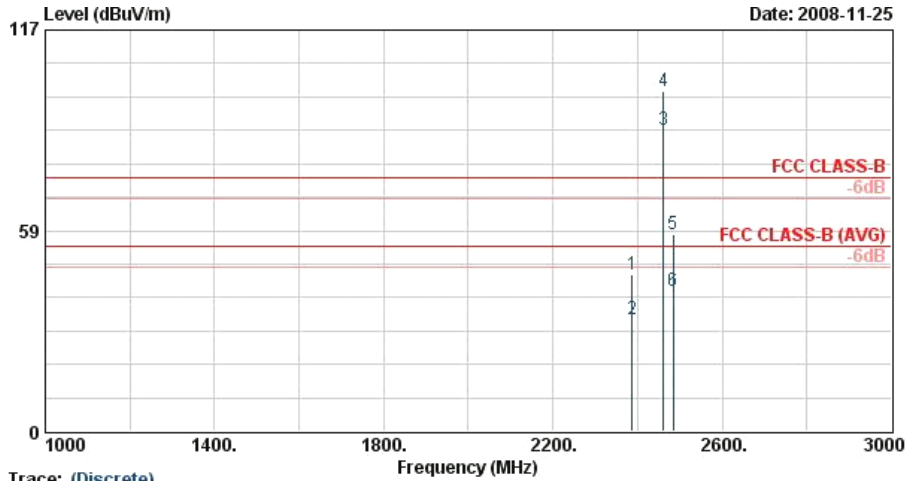

Trace: (Discrete)

Site : 03CH06-HY  
 Condition : FCC CLASS-B 3m HF-ANT\_060821 HORIZONTAL  
 Model : FR 8N1310-01  
 Mode : Mode 7

	Freq	Level	Over	Limit	Read	Antenna	Cable	Preamp	Ant	Table	Remark
	MHz	dBuV/m	dB	dBuV/m	dBuV	dB/m	dB	dB	cm	deg	
1	2388.00	45.88	-28.12	74.00	46.26	31.98	3.92	36.28	100	0	Peak
2	2388.00	32.49	-21.51	54.00	32.87	31.98	3.92	36.28	100	307	Average
3 @	2462.00	88.03			88.24	32.06	4.02	36.29	100	307	Average
4 X	2462.00	98.96			99.18	32.06	4.02	36.30	100	0	Peak
5	2483.50	57.60	-16.40	74.00	57.77	32.08	4.05	36.30	100	0	Peak
6	2483.50	40.72	-13.28	54.00	40.89	32.08	4.05	36.30	100	307	Average





Test Mode :	Mode 7	Temperature :	20~22°C
Test Channel :	11	Relative Humidity :	48~50%
Test Engineer :	Sam Chen	Polarization :	Vertical
Remark :	#5 and #6 are Fundamental Signals		

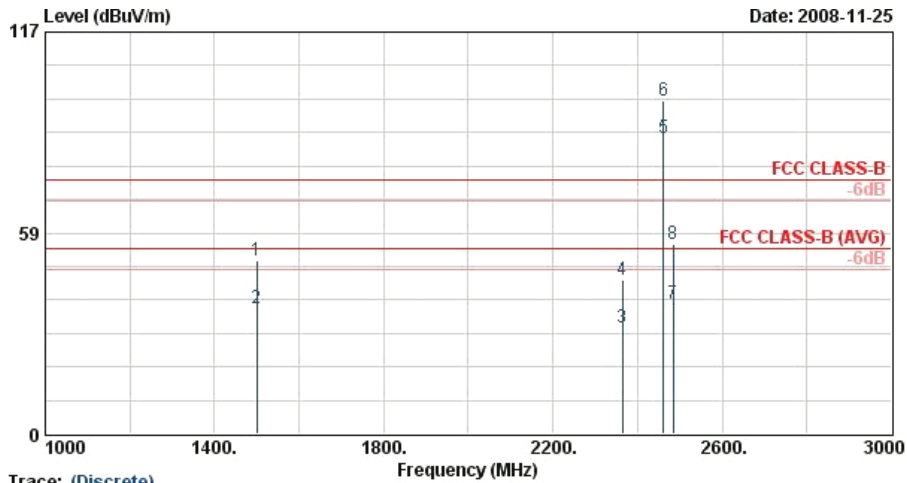

Trace: (Discrete)

Site : 03CH06-HY  
 Condition : FCC CLASS-B 3m HF-ANT\_060621 VERTICAL  
 Model : FR 8N1310-01  
 Name : Mode 7

	Freq	Level	Over	Limit	Read	Antenna	Cable	Preamp	Ant	Table	Remark
	MHz	dBuV/m	dB	dBuV/m	dBuV	dB/m	dB	dB	cm	deg	
1	1500.00	50.27	-23.73	74.00	55.95	28.00	2.82	36.50	100	0	Peak
2	1500.00	36.69	-17.31	54.00	42.37	28.00	2.82	36.50	100	179	Average
3	2364.00	31.02	-22.98	54.00	31.47	31.93	3.89	36.27	111	65	Average
4	2364.00	44.98	-29.02	74.00	45.43	31.93	3.89	36.27	100	0	Peak
5 X	2462.00	86.28			86.49	32.06	4.02	36.29	111	65	Average
6 X	2462.00	96.83			97.05	32.06	4.02	36.30	100	0	Peak
7	2483.50	37.96	-16.04	54.00	38.13	32.08	4.05	36.30	111	65	Average
8	2483.50	55.34	-18.66	74.00	55.51	32.08	4.05	36.30	100	0	Peak



Test Mode :	Mode 8	Temperature :	20~22°C
Test Channel :	03	Relative Humidity :	48~50%
Test Engineer :	Sam Chen	Polarization :	Horizontal
Remark :	#3 and #4 are Fundamental Signals		

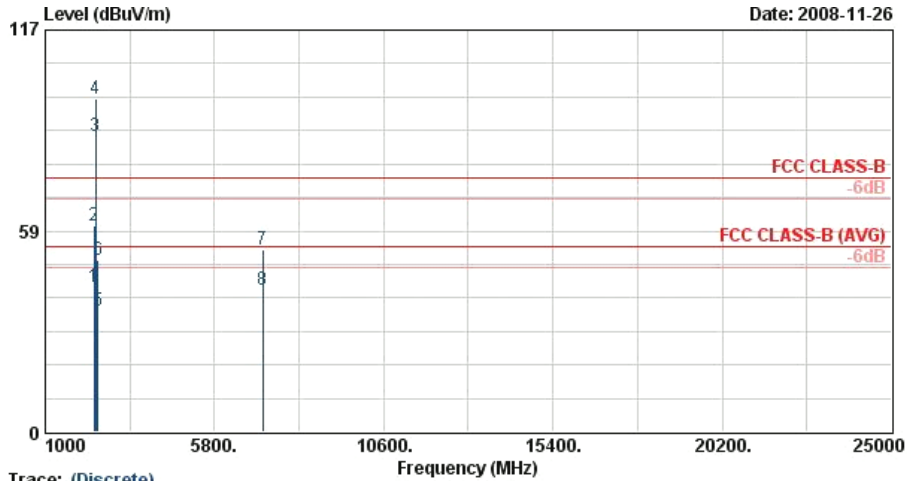

Trace: (Discrete)

Site : 03CH06-HV  
 Condition : FCC CLASS-B 3m SHF-EHF HORN HORIZONTAL  
 Model : FR 8N1310-01  
 Mode : Mode 8

	Freq	Level	Over Limit	Limit Line	ReadAntenna Level	Antenna Factor	Cable Loss	Preamp Factor	Ant Pos	Table Pos	Remark
	MHz	dBuV/m	dB	dBuV/m	dBuV	dB/m	dB	dB	cm	deg	
1	2390.00	42.00	-12.00	54.00	42.38	31.98	3.92	36.28	100	312	Average
2	2390.00	59.92	-14.08	74.00	60.31	31.98	3.92	36.28	100	0	Peak
3 @	2422.00	86.17			86.49	32.02	3.95	36.29	100	312	Average
4 @	2422.00	97.11			97.40	32.02	3.99	36.29	100	0	Peak
5	2492.00	35.21	-18.79	54.00	35.36	32.10	4.05	36.30	100	312	Average
6	2492.00	50.05	-23.95	74.00	50.20	32.10	4.05	36.30	100	0	Peak
7	7161.00	53.23	-20.77	74.00	46.91	35.64	7.15	36.47	100	0	Peak
8	7161.00	41.20	-12.80	54.00	34.88	35.64	7.15	36.47	100	25	Average



Test Mode :	Mode 8	Temperature :	20~22°C
Test Channel :	03	Relative Humidity :	48~50%
Test Engineer :	Sam Chen	Polarization :	Vertical
Remark :	#5 and #6 are Fundamental Signals		

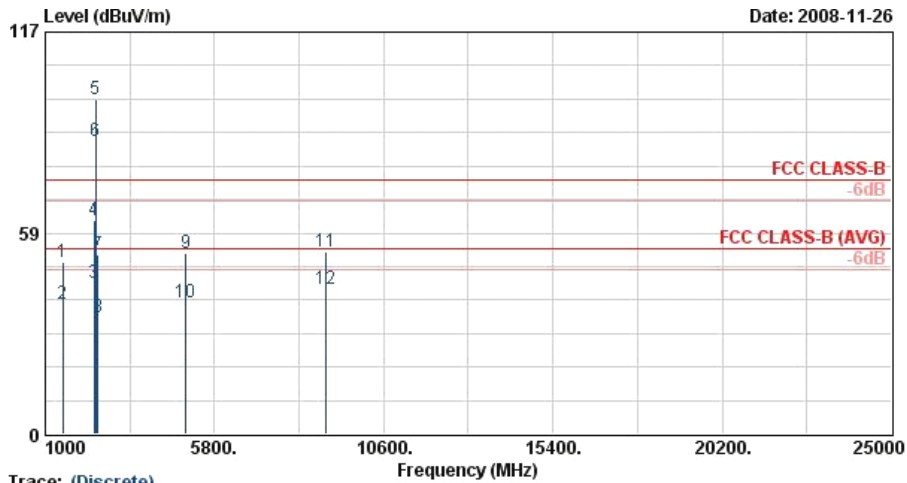

Trace: (Discrete)

Site : 03CH06-HY  
 Condition : FCC CLASS-B 3m SHF-EHF HORN VERTICAL  
 Model : FR 8N1310-01  
 Name : Mode 8

	Freq	Level	Over	Limit	Read	Antenna	Cable	Preamp	Ant	Table	Remark
	MHz	dBuV/m	dB	dBuV/m	dBuV	dB/m	dB	dB	cm	deg	
1	1500.00	49.86	-24.14	74.00	55.54	28.00	2.82	36.50	100	0	Peak
2	1500.00	37.65	-16.35	54.00	43.33	28.00	2.82	36.50	110	147	Average
3	2390.00	43.82	-10.18	54.00	44.20	31.98	3.92	36.28	110	284	Average
4	2390.00	62.24	-11.76	74.00	62.63	31.98	3.92	36.28	100	0	Peak
5 @	2422.00	97.56			97.89	32.00	3.95	36.28	100	0	Peak
6 @	2422.00	85.40			85.72	32.02	3.95	36.29	110	284	Average
7	2494.00	52.04	-21.96	74.00	52.19	32.10	4.05	36.30	100	0	Peak
8	2494.00	33.96	-20.04	54.00	34.11	32.10	4.05	36.30	110	284	Average
9	4986.00	52.54	-21.46	74.00	48.27	34.49	5.88	36.11	100	0	Peak
10	4986.00	38.46	-15.54	54.00	34.19	34.49	5.88	36.11	100	181	Average
11	8976.00	53.10	-20.90	74.00	46.05	36.17	7.77	36.89	100	0	Peak
12	8976.00	42.27	-11.73	54.00	35.22	36.17	7.77	36.89	100	53	Average



Test Mode :	Mode 9	Temperature :	20~22°C
Test Channel :	06	Relative Humidity :	48~50%
Test Engineer :	Sam Chen	Polarization :	Horizontal
Remark :	#3 and #4 are Fundamental Signals		

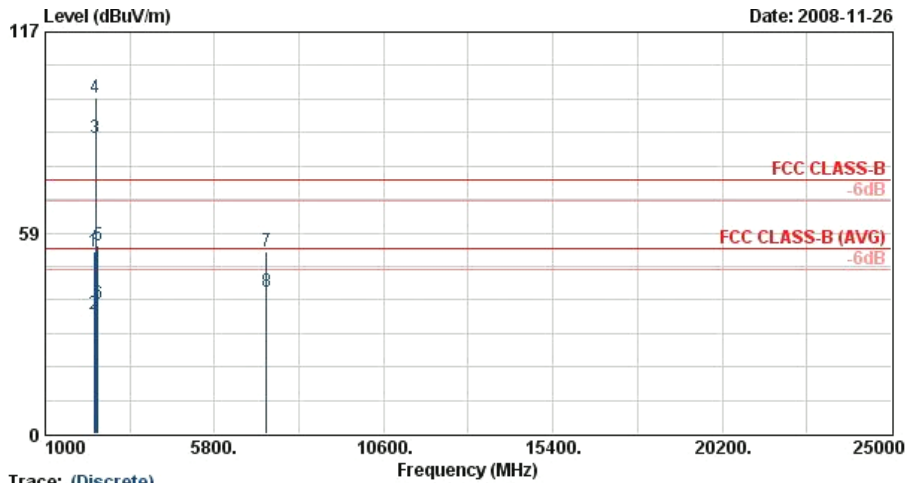

Trace: (Discrete)

Site : 03CH06-HY  
 Condition : FCC CLASS-B 3m SHF-EHF HORN HORIZONTAL  
 Model : FR 8N1310-01  
 Name : Mode 9

	Freq	Level	Over	Limit	Read	Antenna	Cable	Preamp	Ant	Table	Remark
	MHz	dBuV/m	dB	dBuV/m	dBuV	dB/m	dB	dB	cm	deg	
1	2390.00	52.96	-21.04	74.00	53.35	31.98	3.92	36.28	100	0	Peak
2	2390.00	34.97	-19.03	54.00	35.35	31.98	3.92	36.28	100	310	Average
3 @	2437.00	86.12			86.38	32.04	3.99	36.29	100	310	Average
4 @	2437.00	97.72			97.99	32.04	3.99	36.29	100	0	Peak
5	2484.00	55.02	-18.98	74.00	55.19	32.08	4.05	36.30	100	0	Peak
6	2484.00	37.96	-16.04	54.00	38.13	32.08	4.05	36.30	100	310	Average
7	7266.00	53.24	-20.76	74.00	46.98	35.59	7.18	36.51	100	0	Peak
8	7266.00	41.19	-12.81	54.00	34.93	35.59	7.18	36.51	100	178	Average



Test Mode :	Mode 9	Temperature :	20~22°C
Test Channel :	06	Relative Humidity :	48~50%
Test Engineer :	Sam Chen	Polarization :	Vertical
Remark :	#5 and #6 are Fundamental Signals		

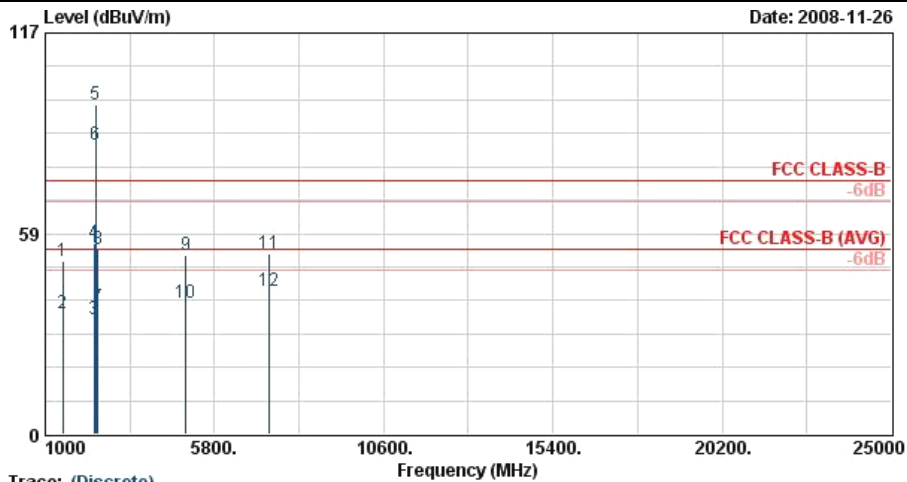

Trace: (Discrete)  
 Site : 03CH06-HY  
 Condition : FCC CLASS-B 3m SHF-EHF HORN VERTICAL  
 Model : FR 8N1310-01  
 Name : Mode 9

	Freq	Level	Over	Limit	Read	Antenna	Cable	Preamp	Ant	Table	
	MHz	dBuV/m	Limit	Line	Level	Factor	Loss	Factor	Pos	Pos	Remark
			dB	dBuV/m	dBuV	dB/m	dB	dB	cm	deg	
1	1500.00	50.45	-23.55	74.00	56.13	28.00	2.82	36.50	100	0	Peak
2	1500.00	35.38	-18.62	54.00	41.06	28.00	2.82	36.50	100	181	Average
3	2390.00	33.67	-20.33	54.00	34.05	31.98	3.92	36.28	100	78	Average
4	2390.00	55.46	-18.54	74.00	55.84	31.98	3.92	36.28	100	0	Peak
5 @	2437.00	96.04			96.32	32.02	3.99	36.29	100	0	Peak
6 @	2437.00	84.33			84.59	32.04	3.99	36.29	100	78	Average
7	2484.00	36.85	-17.15	54.00	37.02	32.08	4.05	36.30	100	78	Average
8	2484.00	53.90	-20.10	74.00	54.06	32.08	4.05	36.30	100	0	Peak
9	4992.00	52.24	-21.76	74.00	47.95	34.50	5.88	36.10	100	0	Peak
10	4992.00	38.48	-15.52	54.00	34.20	34.50	5.88	36.10	100	346	Average
11	7362.00	52.68	-21.32	74.00	46.45	35.56	7.22	36.54	100	0	Peak
12	7362.00	41.71	-12.29	54.00	35.48	35.56	7.22	36.54	100	33	Average



Test Mode :	Mode 10	Temperature :	20~22°C
Test Channel :	09	Relative Humidity :	48~50%
Test Engineer :	Sam Chen	Polarization :	Horizontal
Remark :	#3 and #4 are Fundamental Signals		

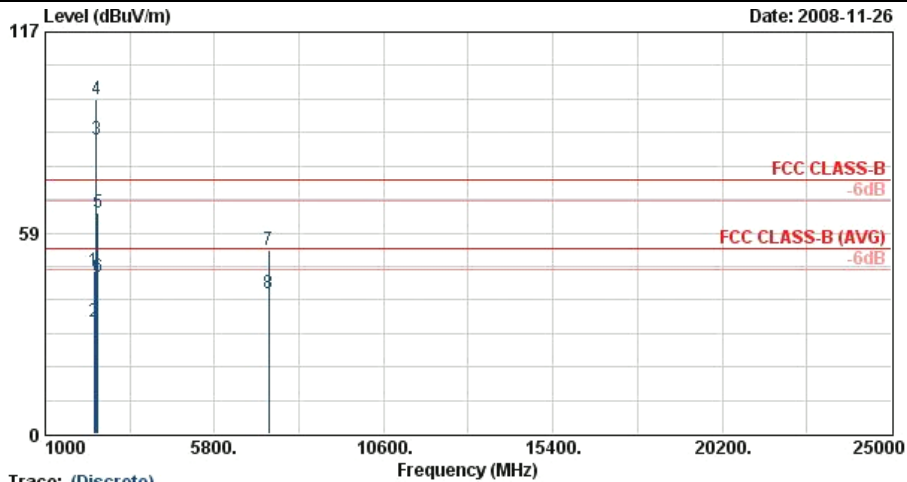

Trace: (Discrete)  
 Site : 03CH06-HV  
 Condition : FCC CLASS-B 3m SHF-EHF HORN HORIZONTAL  
 Model : FR 8N1310-01  
 Mode : Mode 10

	Freq	Level	Over	Limit	Read	Antenna	Cable	Preamp	Ant	Table	
	MHz	dBuV/m	Limit	Line	Level	Factor	Loss	Factor	Pos	Pos	Remark
			dB	dBuV/m	dBuV	dB/m	dB	dB	cm	deg	
1	2390.00	47.42	-26.58	74.00	47.80	31.98	3.92	36.28	100	0	Peak
2	2390.00	32.47	-21.53	54.00	32.85	31.98	3.92	36.28	100	52	Average
3 @	2452.00	85.69			85.96	32.04	3.99	36.29	100	52	Average
4 @	2452.00	97.54			97.76	32.06	4.02	36.30	100	0	Peak
5	2483.50	64.31	-9.69	74.00	64.48	32.08	4.05	36.30	100	0	Peak
6	2483.50	45.55	-8.45	54.00	45.72	32.08	4.05	36.30	100	52	Average
7	7332.00	53.40	-20.60	74.00	47.15	35.57	7.21	36.53	100	0	Peak
8	7332.00	40.71	-13.29	54.00	34.46	35.57	7.21	36.53	100	350	Average



Test Mode :	Mode 10	Temperature :	20~22°C
Test Channel :	09	Relative Humidity :	48~50%
Test Engineer :	Sam Chen	Polarization :	Vertical
Remark :	#5 and #6 are Fundamental Signals		

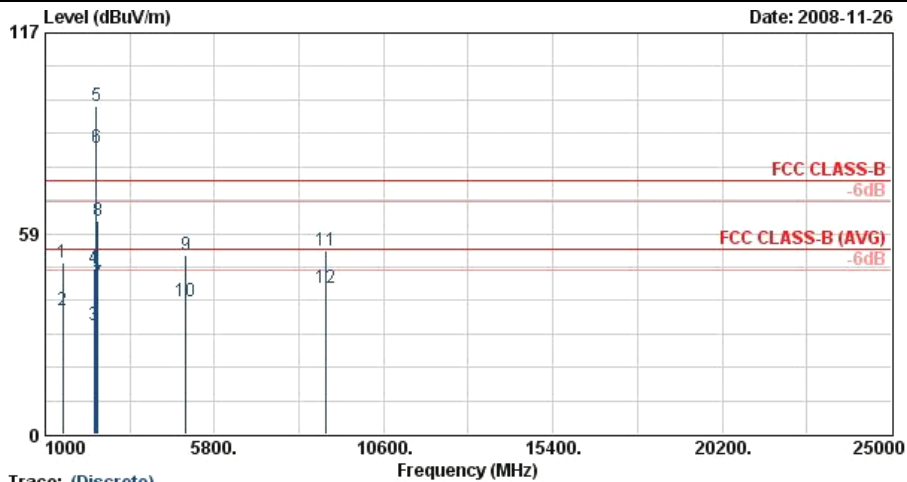

Trace: (Discrete)  
 Site : 03CH06-HY  
 Condition : FCC CLASS-B 3m SHF-EHF HORN VERTICAL  
 Model : FR 8N1310-01  
 Mode : Mode 10

	Freq	Level	Over	Limit	Read	Antenna	Cable	Preamp	Ant	Table	
	MHz	dBuV/m	Limit	Line	Level	Factor	Loss	Factor	Pos	Pos	Remark
			dB	dBuV/m	dBuV	dB/m	dB	dB	cm	deg	
1	1500.00	49.97	-24.03	74.00	55.65	28.00	2.82	36.50	100	0	Peak
2	1500.00	35.93	-18.07	54.00	41.61	28.00	2.82	36.50	100	181	Average
3	2390.00	31.89	-22.11	54.00	32.27	31.98	3.92	36.28	100	78	Average
4	2390.00	48.47	-25.53	74.00	48.86	31.98	3.92	36.28	100	0	Peak
5 @	2452.00	95.57			95.79	32.06	4.02	36.29	100	0	Peak
6 @	2452.00	83.37			83.64	32.04	3.99	36.29	100	78	Average
7	2483.50	43.74	-10.26	54.00	43.91	32.08	4.05	36.30	100	78	Average
8	2483.50	62.23	-11.77	74.00	62.40	32.08	4.05	36.30	100	0	Peak
9	4992.00	52.02	-21.98	74.00	47.74	34.50	5.88	36.10	100	0	Peak
10	4992.00	38.86	-15.14	54.00	34.58	34.50	5.88	36.10	112	348	Average
11	8946.00	53.53	-20.47	74.00	46.53	36.13	7.74	36.88	100	0	Peak
12	8946.00	42.62	-11.38	54.00	35.63	36.13	7.74	36.88	100	256	Average



## **3.7 Antenna Requirements**

### **3.7.1 Standard Applicable**

If directional gain of transmitting antennas is greater than 6dBi, the power shall be reduced by the same level in dB comparing to gain minus 6dBi. For the fixed point-to-point operation, the power shall be reduced by one dB for every 3 dB that the directional gain of the antenna exceeds 6 dBi.

The use of a permanently attached antenna or of an antenna that uses a unique coupling to the intentional radiator shall be considered sufficient to comply with the FCC rule.

### **3.7.2 Antenna Connected Construction**

The antennas type used in this product is PCB Antenna without connector and it is considered to meet antenna requirement.

### **3.7.3 Antenna Gain**

The antenna peak gain of EUT is less than 6 dBi. Therefore, it is not necessary to reduce maximum peak output power limit.





## 4 List of Measuring Equipments

Instrument	Manufacturer	Model No.	Serial No.	Characteristics	Calibration Date	Due Date	Remark
Spectrum Analyzer	R&S	FSP40	100055	9KHz~40GHz	Jun. 26, 2008	Jun. 25, 2009	Conducted (TH02-HY)
Power Meter	Agilent	E4416A	GB41292344	N/A	Feb. 21, 2008	Feb. 20, 2009	Conducted (TH02-HY)
Power Sensor	Agilent	E9327A	US40441548	N/A	Feb. 21, 2008	Feb. 20, 2009	Conducted (TH02-HY)
EMI Receiver	R&S	ESCS 30	100356	9kH~2.75GHz	Aug. 01, 2008	Jul. 31, 2009	Conduction (CO05-HY)
Two-LISN	R&S	ENV216	11-100081	9kH~30MHz	Nov. 26, 2008	Nov. 25, 2009	Conduction (CO05-HY)
Two-LISN	R&S	ENV216	11-100080	9kHz~30MHz	Nov. 26, 2008	Nov. 25, 2009	Conduction (CO05-HY)
AC Power Source	APC	APC-1000W	N/A	N/A	N/A	N/A	Conduction (CO05-HY)
Spectrum Analyzer	Agilent	E4408B	MY44211030	9kHz~26.5GHz	Oct. 24, 2008	Oct. 23, 2009	Radiation (03CH06-HY)
Spectrum Analyzer	R&S	FSP40	100057	9kHz~40GHz	Oct. 16, 2008	Oct. 15, 2009	Radiation (03CH06-HY)
EMI Test Receiver	R&S	ESVS10	834468/003	20MHz~1000M Hz	Apr. 24, 2008	Apr. 23, 2009	Radiation (03CH06-HY)
Bilog Antenna	SCHAFFNER	CBL6112B	2885	30MHz~2GHz	Nov. 12, 2008	Nov. 11, 2009	Radiation (03CH06-HY)
Double Ridge Horn Antenna	EMCO	3117	00066583	1G~18GHz	Aug. 18, 2008	Aug. 17, 2009	Radiation (03CH06-HY)
Double Ridge Horn Antenna	Training Research	AF-0801	95119	8G~18G	Oct. 28, 2008	Oct. 27, 2009	Radiation (03CH06-HY)
SHF-EHF Horn	SCHWARZBECK	BBHA 9170	9170-251	14G~40GHz	Oct. 16, 2008	Oct. 15, 2009	Radiation (03CH06-HY)
Pre Amplifier	Agilent	8449B	3008A01917	1G~26.5GHz	Nov. 11, 2008	Nov. 10, 2009	Radiation (03CH06-HY)
Pre Amplifier	Agilent	310N	186713	9kHz~1GHz	Apr. 21, 2008	Apr. 20, 2009	Radiation (03CH06-HY)

## 5 Uncertainty of Evaluation

### Uncertainty of Conducted Emission Measurement (150kHz ~ 30MHz)

Contribution	Uncertainty of $x_i$		$u(x_i)$
	dB	Probability Distribution	
Receiver reading	0.10	Normal(k=2)	0.05
Cable loss	0.10	Normal(k=2)	0.05
AMN insertion loss	2.50	Rectangular	0.63
Receiver Spec	1.50	Rectangular	0.43
Site imperfection	1.39	Rectangular	0.80
Mismatch	+0.34/-0.35	U-shape	0.24
<b>Combined standard uncertainty Uc(y)</b>	<b>1.13</b>		
<b>Measuring uncertainty for a level of confidence of 95% U=2Uc(y)</b>	<b>2.26</b>		

### Uncertainty of Radiated Emission Measurement (30MHz ~ 1000MHz)

Contribution	Uncertainty of $x_i$		$u(x_i)$
	dB	Probability Distribution	
Receiver reading	0.41	Normal(k=2)	0.21
Antenna factor calibration	0.83	Normal(k=2)	0.42
Cable loss calibration	0.25	Normal(k=2)	0.13
Pre Amplifier Gain calibration	0.27	Normal(k=2)	0.14
RCV/SPA specification	2.50	Rectangular	0.72
Antenna Factor Interpolation for Frequency	1.00	Rectangular	0.29
Site imperfection	1.43	Rectangular	0.83
Mismatch	+0.39/-0.41	U-shaped	0.28
<b>Combined standard uncertainty Uc(y)</b>	<b>1.27</b>		
<b>Measuring uncertainty for a level of confidence of 95% U=2Uc(y)</b>	<b>2.54</b>		



**Uncertainty of Radiated Emission Measurement (1GHz ~ 40GHz)**

Contribution	Uncertainty of $x_i$		$u(x_i)$	$C_i$	$C_i * u(x_i)$
	dB	Probability Distribution			
Receiver reading	±0.10	Normal(k=1)	0.10	1	0.10
Antenna factor calibration	±1.70	Normal(k=2)	0.85	1	0.85
Cable loss calibration	±0.50	Normal(k=2)	0.25	1	0.25
Receiver Correction	±2.00	Rectangular	1.15	1	1.15
Antenna Factor Directional	±1.50	Rectangular	0.87	1	0.87
Site imperfection	±2.80	Triangular	1.14	1	1.14
Mismatch Receiver VSWR $\Gamma_1 = 0.197$ Antenna VSWR $\Gamma_2 = 0.194$ Uncertainty = $20 \log(1 - \Gamma_1 * \Gamma_2)$	+0.34/-0.35	U-shaped	0.244	1	0.244
<b>Combined standard uncertainty <math>U_c(y)</math></b>	<b>2.36</b>				
<b>Measuring uncertainty for a level of confidence of 95% <math>U = 2U_c(y)</math></b>	<b>4.72</b>				

## 6 Certification of TAF Accreditation



Certificate No. : L1180-070110

財團法人全國認證基金會  
Taiwan Accreditation Foundation

### Certificate of Accreditation

This is to certify that

**Sporton International Inc.**  
**EMC & Wireless Communications Laboratory**  
No.52, Hwa Ya 1st Rd., Hwa Ya Technology Park, Kwei-Shan Hsiang, Tao Yuan Hsien,  
Taiwan, R.O.C.

is accredited in respect of laboratory

Accreditation Criteria	: ISO/IEC 17025:2005
Accreditation Number	: 1190
Originally Accredited	: December 15, 2003
Effective Period	: January 10, 2007 to January 09, 2010
Accredited Scope	: Testing Field, see described in the Appendix Accreditation Program for Designated Testing Laboratory
Specific Accreditation Program	: for Commodities Inspection Accreditation Program for Telecommunication Equipment Testing Laboratory



Jay-San Chen  
President, Taiwan Accreditation Foundation  
Date : January 10, 2007



PI, total 9 pages

The Appendix forms an integral part of this Certificate, which shall be invalid when used without the Appendix.



## **Appendix A. Photographs of EUT**

Please refer to Sporton report number EP8N1310-01 as below.