



## Test Report

Product Name : Notebook  
Model No : MS-N033, U123  
FCC ID : I4L-N-EM770MS

Applicant : MICRO-STAR INT'L Co., LTD.  
Address : No. 69, Li-De St., Jung-He City, Taipei  
Hsien, Taiwan, R.O.C.

Date of Receipt : 2009/03/03  
Issued Date : 2009/04/07  
Report No. : 093068R-HPUSP07V01  
Report Version : V1.0

The test results relate only to the samples tested.  
The test report shall not be reproduced except in full without the written approval of Quietek Corporation.  
This report must not be used to claim product endorsement by NVLAP any agency of the U.S. Government

# Test Report Certification

Issued Date : 2009/04/07

Report No.: 093068R-HPUSP07V01



Accredited by NIST (NVLAP)

NVLAP Lab Code: 200533-0

Product Name : Notebook  
Applicant : MICRO-STAR INT'L Co., LTD.  
Address : No. 69, Li-De St., Jung-He City, Taipei Hsien, Taiwan, R.O.C.  
Manufacturer : MICRO-STAR INT'L Co., LTD.  
Trade Name : MSI  
Model No. : MS-N033, U123  
Rated Voltage : AC 120V/60Hz  
EUT Voltage : AC 120V/60Hz  
Measurement Standard : FCC CFR Title 47 Part 2 22 24  
Measurement Reference : TIA/EIA 603-C  
Test Result : Complied

Test results relate only to the samples tested.

The test report shall not be reproduced except in full without the written approval of Quie Tek Corporation.

This report must not be used to claim product endorsement by NVLAP any agency of the U.S. Government

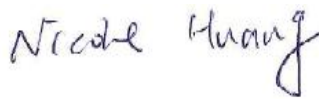
Documented By :   
(Engineering Adm. Assistant /  
Nicole Huang)

Tested By :   
(Engineer / Vorana Chen)

Approved By :   
(Manager / Vincent Lin)

## TABLE OF CONTENTS

Description	Page
1. GENERAL INFORMATION .....	4
1.1. EUT Description .....	4
1.2. Antenna List.....	5
1.3. Operational Description.....	5
1.4. Configuration of tested System .....	6
1.5. EUT Setup Procedures .....	6
1.6. Test Facility .....	7
1.7. Type of Emission .....	8
2. Peak Power Output .....	9
2.1. Test Equipment.....	9
2.2. Test Setup .....	9
2.3. Limits .....	10
2.4. Test Procedure .....	10
2.5. Test Specification .....	10
2.6. Test Result of Peak Power Output .....	11
3. Occupied Bandwidth .....	25
3.1. Test Equipment.....	25
3.2. Test Setup .....	25
3.3. Test Procedure .....	25
3.4. Test Specification .....	26
3.5. Test Result of Occupied Bandwidth .....	27
4. Spurious Emission At Antenna Terminals (+/-1MHz).....	47
4.1. Test Equipment.....	47
4.2. Setup .....	47
4.3. Limits .....	48
4.4. Test Procedure .....	48
4.5. Test Specification .....	48
4.6. Test Result of Spurious Emission At Antenna Terminals (+/-1MHz).....	49
5. Spurious Emission .....	59
5.1. Test Equipment.....	59
5.2. Test Setup .....	60
5.3. Limits .....	60
5.4. Test Procedure .....	61
5.5. Test Specification .....	61
5.6. Test Result of Spurious Emission .....	62
6. Frequency Stability Under Temperature & Voltage Variations .....	102
6.1. Test Equipment .....	102
6.2. Test Setup.....	102
6.3. Limits.....	102
6.4. Test Procedure .....	103
6.5. Test Specification .....	103
6.6. Test Result of Frequency Stability Under Temperature Variations .....	104
7. EMI Reduction Method During Compliance Testing .....	114
Attachment 1: EUT Test Photographs	
Attachment 2: EUT Detailed Photographs	

## 1. GENERAL INFORMATION

### 1.1. EUT Description

Product Name	Notebook
Model No.	MS-N033, U123
Trade Name	MSI
FCC ID.	I4L-N-EM770MS
Antenna Type	PIFA
TX Frequency	824MHz~849MHz(GSM 850/WCDMA Band V) 1850MHz ~ 1910MHz(PCS 1900/WCDMA Band II)
Rx Frequency	869MHz~894MHz(GSM 850/WCDMA Band V) 1930MHz ~ 1990MHz(PCS 1900/WCDMA Band II)
Function	GPRS/EGPRS/WCDMA/HSDPA/HSUPA

Component	
Power Adapter	MFR: LISHIN, M/N: 0225A2040 AC Input: 100V-240V / 50-60Hz, 1.7A DC Output: 20V, 2.0A Cable Out: Non-Shielded 1.9m, 1 ferrite core bonded Cable In: Non-Shielded 1.8m

## 1.2. Antenna List

No.	Antenna Type	Part No.	Peak Gain
1	PIFA	S79-1800F10-J51	-2.33 dBi
2	PIFA	S79-1800M20-J36	-2.53 dBi

Note: 1. Regarding to the operation frequency, the lowest, middle and highest frequency are selected to perform the test.

2. Only the higher gain antenna Ant 1 was tested and recorded in this report.

## 1.3. Operational Description

The information contained within this report is intended to show verification of compliance of the 850/1900MHz Notebook to the requirements of 47CFR2, 22 and 24.

The EUT provide all functions described as above. The EUT is tested with maximum rated TX power via the Base Station simulator.

Quietek has verified the construction and function in typical operation. All the test modes were carried out with the EUT in normal operation, which was shown in this test report and defined as:

Test Mode	GSM 850 GPRS
	GSM 850 EGPRS
	PCS 1900 GPRS
	PCS 1900 EGPRS
	WCDMA BAND V
	WCDMA BAND V HSDPA
	WCDMA BAND V HSUPA
	WCDMA BAND II
	WCDMA BAND II HSDPA
	WCDMA BAND II HSUPA

## 1.4. Configuration of tested System

### (a) Configuration of Radiated measurement

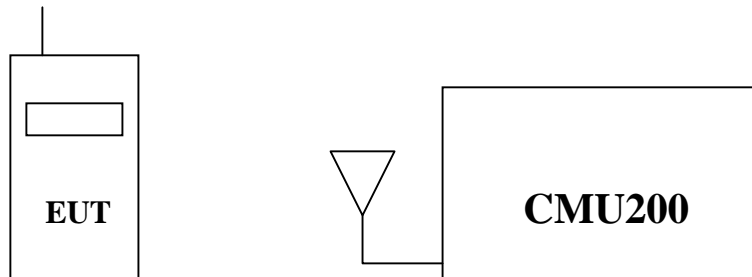

### (b) Configuration of Conducted measurement

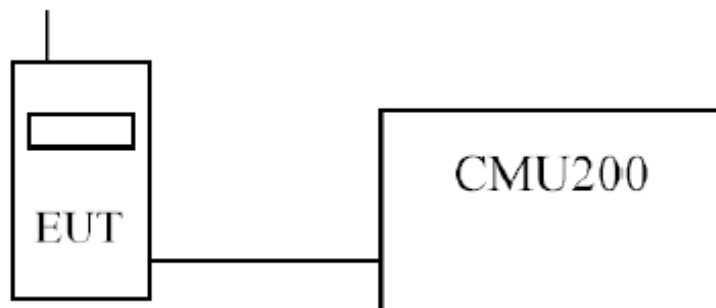

## 1.5. EUT Setup Procedures

- (1) Setup the EUT and simulators as shown on 1.3
- (2) Turn on the power of all equipments.
- (3) The EUT was set to communicate with CMU200.
- (4) Repeat the above procedure (3).

**1.6. Test Facility**

Ambient conditions in the laboratory:

Items	Required (IEC 68-1)	Actual
Temperature (°C)	15-35	23
Humidity (%RH)	25-75	52
Barometric pressure (mbar)	860-1060	982

Site Description: File on

Federal Communications Commission  
 FCC Engineering Laboratory  
 7435 Oakland Mills Road  
 Columbia, MD 21046  
 FCC Registration Number :92195



July 03, 2001 Accreditation on NVLAP  
 NVLAP Lab Code: 200533-0



Site Name: Quietek Corporation

Linkou Testing Laboratory:

No. 5, Ruei-Shu Valley, Ruei-Ping Tsuen,  
 Lin-Kou Shiang, Taipei,  
 Taiwan, R.O.C.  
 TEL : 886-2-8601-3788 / FAX : 886-2-8601-3789  
 E-Mail : [service@quietek.com](mailto:service@quietek.com)

FCC Accreditation Number: TW1014



## 1.7. Type of Emission

GSM/GPRS/EGPRS: 300KG7W  
WCDMA/HSDPA/HSUPA: 4M20F9W



## 2. Peak Power Output

### 2.1. Test Equipment

The following test equipments are used during the radiated emission test:

Test Site	Equipment	Manufacturer	Model No./Serial No.	Last Cal.
☒OATS 3	Test Receiver	R & S	ESCS 30 / 100122	Feb., 2009
	Universal Radio Communication Tester	R & S	CMU200 / 104846	Apr., 2009
	Spectrum Analyzer	Agilent	N9020A/ MY48010570	Apr., 2009
	Pre-Amplifier	QTK	QTK-AMP-03 / 0003	N/A
	Bilog Antenna	SCHAFFNER	CBL6112B / 2697	May., 2009
	Horn Antenna	ETS	3115 / 0005-6160	Jul., 2009
	Pre-Amplifier	QTK	QTK-AMP-01 / 0001	Jul., 2009

Note: All equipments that need to be calibrated are with calibration period of 1 year.

### 2.2. Test Setup

#### Radiated Power Measurement

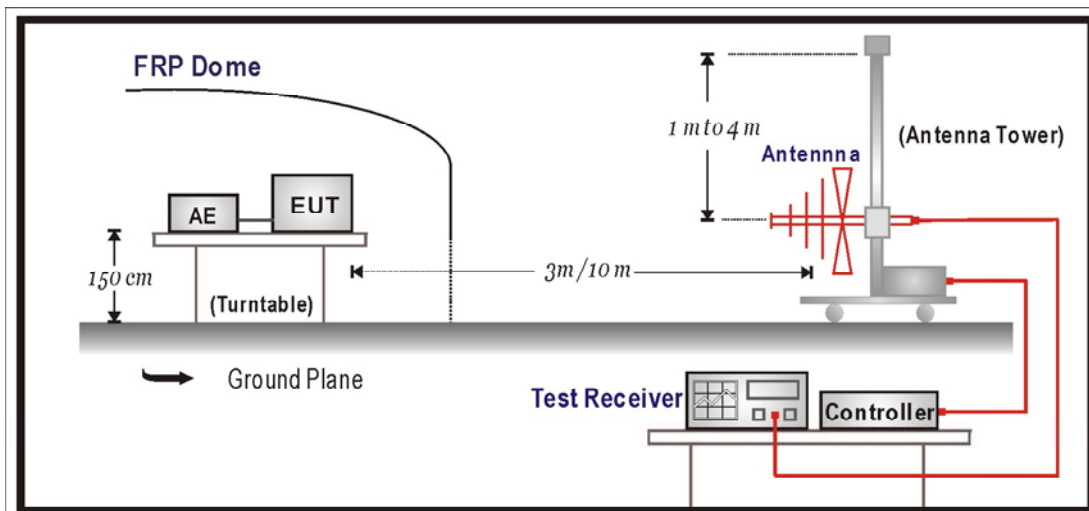

**Conducted Power Measurement**

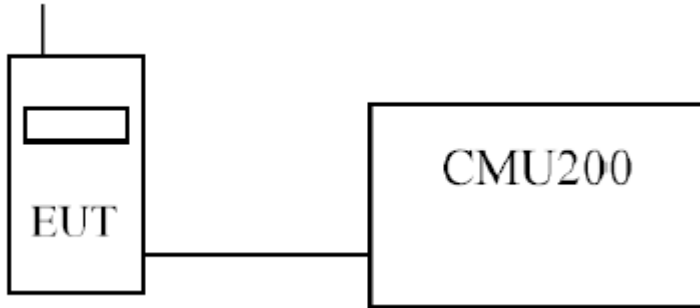

**2.3. Limits**

<b>Cellular Band 850</b>	<b>&lt;7W</b>
<b>PCS Band 1900</b>	<b>&lt;2W or +33dBm</b>

**2.4. Test Procedure**

**➤RF Out Power (Radiated)**

The Spectrum Analyzer was tuned to the test frequency. The device was put into Transmit mode then rotated through 360 degrees until the highest power level was observed in both horizontal and vertical polarization. The device was then replaced with a substitution antenna, which input signal was adjusted until the received level matched that of the previously detected emission.

The EUT is tested with maximum rated TX power via the Base Station simulator.

**➤RF Out Power (Conducted)**

The EUT is tested with maximum rated TX power via the Base Station simulator, and the output power was measured at the antenna terminals of the EUT.

**2.5. Test Specification**

According to Part 2.1046, 22.913,24.232.

## 2.6. Test Result of Peak Power Output

Product	Notebook		
Test Mode	RF Output Power (Conducted)		
Date of Test	2009/04/01	Test Site	CTR

GPRS 850				
Frequency (MHz)	Output Power (dBm)	Path Loss (dB)	Result (dBm)	Result (W)
824.2	31.27	0.4	31.67	1.47
836.4	31.13	0.4	31.53	1.42
848.8	31.03	0.4	31.43	1.39
EGPRS 850				
Frequency (MHz)	Output Power (dBm)	Path Loss (dB)	Result (dBm)	Result (W)
824.2	23.96	0.4	24.36	0.27
836.4	23.92	0.4	24.32	0.27
848.8	23.80	0.4	24.20	0.26

GPRS 1900				
Frequency (MHz)	Output Power (dBm)	Path Loss (dB)	Result (dBm)	Result (W)
1850.2	27.94	0.6	28.54	0.71
1880	27.83	0.6	28.43	0.70
1909.8	27.77	0.6	28.37	0.69
EGPRS 1900				
Frequency (MHz)	Output Power (dBm)	Path Loss (dB)	Result (dBm)	Result (W)
1850.2	23.84	0.6	24.44	0.28
1880	23.32	0.6	23.92	0.25
1909.8	23.77	0.6	24.37	0.27

WCDMA Band V				
Frequency (MHz)	Output Power (dBm)	Path Loss (dB)	Result (dBm)	Result (W)
826.4	21.05	0.4	21.45	0.14
836.6	21.08	0.4	21.48	0.14
846.6	21.17	0.4	21.57	0.14

WCDMA Band V HSDPA								
Frequency (MHz)	Set 1		Set 2		Set 3		Set 4	
	Power (dBm)	Power (Watts)	Power (dBm)	Power (Watts)	Power (dBm)	Power (Watts)	Power (dBm)	Power (Watts)
826.4	21.41	0.14	20.46	0.11	20.33	0.11	19.81	0.10
836.6	21.37	0.14	20.39	0.11	20.31	0.11	19.75	0.09
846.6	21.46	0.14	20.45	0.11	20.43	0.11	19.82	0.10
$\beta_c$	2		12		15		15	
$\beta_d$	15		15		8		4	
$\Delta_{ACK}, \Delta_{NACK} \Delta_{CQI}$	8		8		8		8	

Cable loss: 0.4dB for 850MHz ; 0.6dB for 1900MHz

Note: All HSDPA testing was done in Set1 configuration.

WCDMA Band V HSUPA										
Frequency (MHz)	Set 1		Set 2		Set 3		Set 4		Set 5	
	Power (dBm)	Power (Watts)	Power (dBm)	Power (Watts)	Power (dBm)	Power (Watts)	Power (dBm)	Power (Watts)	Power (dBm)	Power (Watts)
826.4	20.39	0.11	18.82	0.08	19.58	0.09	18.83	0.08	20.58	0.11
836.6	20.46	0.11	18.62	0.07	19.38	0.09	18.77	0.08	20.46	0.11
846.6	20.33	0.11	18.84	0.08	19.56	0.09	18.85	0.08	20.80	0.12
$\beta_c$	11		6		15		2		15	
$\beta_d$	15		15		9		15		15	
$\Delta_{ACK}, \Delta_{NACK} \Delta_{CQI}$	8		8		8		8		8	
AGV	20		12		15		17		21	

Cable loss: 0.4dB for 850MHz ; 0.6dB for 1900MHz

Note: All HSUPA testing was done in Set5 configuration.

WCDMA Band II				
Frequency (MHz)	Output Power (dBm)	Path Loss (dB)	Result (dBm)	Result (W)
1852.4	20.81	0.6	21.41	0.14
1880	20.47	0.6	21.07	0.13
1907.6	20.22	0.6	20.82	0.12

WCDMA Band II HSDPA								
Frequency (MHz)	Set 1		Set 2		Set 3		Set 4	
	Power (dBm)	Power (Watts)	Power (dBm)	Power (Watts)	Power (dBm)	Power (Watts)	Power (dBm)	Power (Watts)
1852.4	21.76	0.15	21.06	0.13	21.04	0.13	20.46	0.11
1880	21.28	0.13	20.53	0.11	20.57	0.11	20.01	0.10
1907.6	20.97	0.13	20.34	0.11	20.10	0.10	19.84	0.10
$\beta_c$	2		12		15		15	
$\beta_d$	15		15		8		4	
$\Delta_{ACK}, \Delta_{NACK} \Delta_{CQI}$	8		8		8		8	

Cable loss: 0.4dB for 850MHz ; 0.6dB for 1900MHz

Note: All HSDPA testing was done in Set1 configuration.

WCDMA Band II HSUPA										
Frequency (MHz)	Set 1		Set 2		Set 3		Set 4		Set 5	
	Power (dBm)	Power (Watts)	Power (dBm)	Power (Watts)	Power (dBm)	Power (Watts)	Power (dBm)	Power (Watts)	Power (dBm)	Power (Watts)
1852.4	20.66	0.12	18.73	0.07	19.70	0.09	18.59	0.07	20.31	0.11
1880	20.77	0.12	18.69	0.07	19.72	0.09	18.74	0.07	20.75	0.12
1907.6	20.75	0.12	18.47	0.07	19.48	0.09	18.94	0.08	20.55	0.11
$\beta_c$	11		6		15		2		15	
$\beta_d$	15		15		9		15		15	
$\Delta_{ACK}, \Delta_{NACK} \Delta_{CQI}$	8		8		8		8		8	
AGV	20		12		15		17		21	

Cable loss: 0.4dB for 850MHz ; 0.6dB for 1900MHz

Note: All HSUPA testing was done in Set1 configuration.

Product	Notebook		
Test Mode	RF Output Power (Radiated)		
Date of Test	2009/04/01	Test Site	OATS 3
Test Condition	GSM 850 GPRS		

**Maximum Power-GSM 850 GPRS**

Frequency (MHz)	Reading Level (dBm)	Substitution Level (dBm)	Substitution Antenna Gain (dBd)	Cable Loss (dB)	Result ERP (dBm)	Result ERP (W)
824.2	16.247	19.090	4.45	0.51	23.03	0.20
836.4	16.128	18.970	4.45	0.51	22.91	0.20
848.8	16.232	19.080	4.45	0.51	23.02	0.20

## Note:

1. The EUT meets the requirements of FCC CFR 47: Part 22, Section 22.913(a) for Effective Radiated Power.
2. Receiver setting (Peak Detector) : RBW:3MHz; VBW:3MHz
3. Result ERP = Substitution Level + Substitution Antenna Gain - Cable Loss

Product	Notebook		
Test Mode	RF Output Power (Radiated)		
Date of Test	2009/04/01	Test Site	OATS 3
Test Condition	GSM 850 EGPRS		

**Maximum Power-GSM 850 EGPRS**

Frequency (MHz)	Reading Level (dBm)	Substitution Level (dBm)	Substitution Antenna Gain (dBd)	Cable Loss (dB)	Result ERP (dBm)	Result ERP (W)
824.2	12.510	15.350	4.45	0.51	19.29	0.08
836.4	12.493	15.330	4.45	0.51	19.27	0.08
848.8	13.272	16.110	4.45	0.51	20.05	0.10

## Note:

1. The EUT meets the requirements of FCC CFR 47: Part 22, Section 22.913(a) for Effective Radiated Power.
2. Receiver setting (Peak Detector) : RBW:3MHz; VBW:3MHz
3. Result ERP = Substitution Level + Substitution Antenna Gain - Cable Loss



Product	Notebook		
Test Mode	RF Output Power (Radiated)		
Date of Test	2009/04/01	Test Site	OATS 3
Test Condition	PCS 1900 GPRS		

**Maximum Power-PCS 1900 GPRS**

Frequency (MHz)	Reading Level (dBm)	Substitution Level (dBm)	Substitution Antenna Gain (dBi)	Cable Loss (dB)	Result EIRP (dBm)	Result EIRP (W)
1850.2	-13.098	17.780	10.4	1.02	27.16	0.52
1880.0	-13.987	17.250	10.4	1.02	26.63	0.46
1909.8	-14.245	17.250	10.4	1.02	26.63	0.46

## Note:

1. The EUT meets the requirements of FCC CFR 47: Part 24, Section 24.232(b) for Effective Isotropically Radiated Power.
2. Receiver setting (Peak Detector) : RBW:3MHz; VBW:3MHz
3. Result EIRP = Substitution Level + Substitution Antenna Gain - Cable Loss

Product	Notebook		
Test Mode	RF Output Power (Radiated)		
Date of Test	2009/04/01	Test Site	OATS 3
Test Condition	PCS 1900 EGPRS		

**Maximum Power-PCS 1900 EGPRS**

Frequency (MHz)	Reading Level (dBm)	Substitution Level (dBm)	Substitution Antenna Gain (dBi)	Cable Loss (dB)	Result EIRP (dBm)	Result EIRP (W)
1850.2	-14.539	16.339	10.4	1.02	25.72	0.37
1880.0	-15.893	15.344	10.4	1.02	24.72	0.30
1909.8	-15.740	15.750	10.4	1.02	25.13	0.33

## Note:

1. The EUT meets the requirements of FCC CFR 47: Part 24, Section 24.232(b) for Effective Isotropically Radiated Power.
2. Receiver setting (Peak Detector) : RBW:3MHz; VBW:3MHz
3. Result EIRP = Substitution Level + Substitution Antenna Gain - Cable Loss

Product	Notebook		
Test Mode	RF Output Power (Radiated)		
Date of Test	2009/04/01	Test Site	OATS 3
Test Condition	WCDMA BAND V		

**Maximum Power- WCDMA BAND V**

Frequency (MHz)	Reading Level (dBm)	Substitution Level (dBm)	Substitution Antenna Gain (dBd)	Cable Loss (dB)	Result ERP (dBm)	Result ERP (W)
826.4	9.693	12.550	4.45	0.51	16.49	0.04
836.6	10.558	13.410	4.45	0.51	17.35	0.05
846.6	10.281	13.140	4.45	0.51	17.08	0.05

## Note:

1. The EUT meets the requirements of FCC CFR 47: Part 22, Section 22.913(a) for Effective Radiated Power.
2. Receiver setting (Peak Detector) : RBW:5MHz; VBW:5MHz
3. Result ERP = Substitution Level + Substitution Antenna Gain - Cable Loss

Product	Notebook		
Test Mode	RF Output Power (Radiated)		
Date of Test	2009/04/01	Test Site	OATS 3
Test Condition	WCDMA BAND V HSDPA		

**Maximum Power- WCDMA BAND V HSDPA**

Frequency (MHz)	Reading Level (dBm)	Substitution Level (dBm)	Substitution Antenna Gain (dBd)	Cable Loss (dB)	Result ERP (dBm)	Result ERP (W)
826.4	9.558	12.420	4.45	0.51	16.36	0.04
836.6	10.395	13.250	4.45	0.51	17.19	0.05
846.6	10.286	13.140	4.45	0.51	17.08	0.05

## Note:

1. The EUT meets the requirements of FCC CFR 47: Part 22, Section 22.913(a) for Effective Radiated Power.
2. Receiver setting (Peak Detector) : RBW:5MHz; VBW:5MHz
3. Result ERP = Substitution Level + Substitution Antenna Gain - Cable Loss

Product	Notebook		
Test Mode	RF Output Power (Radiated)		
Date of Test	2009/04/01	Test Site	OATS 3
Test Condition	WCDMA BAND V HSUPA		

**Maximum Power- WCDMA BAND V HSUPA**

Frequency (MHz)	Reading Level (dBm)	Substitution Level (dBm)	Substitution Antenna Gain (dBd)	Cable Loss (dB)	Result ERP (dBm)	Result ERP (W)
826.4	9.672	12.530	4.45	0.51	16.47	0.04
836.6	10.580	13.430	4.45	0.51	17.37	0.05
846.6	10.216	13.070	4.45	0.51	17.01	0.05

## Note:

1. The EUT meets the requirements of FCC CFR 47: Part 22, Section 22.913(a) for Effective Radiated Power.
2. Receiver setting (Peak Detector) : RBW:5MHz; VBW:5MHz
3. Result ERP = Substitution Level + Substitution Antenna Gain - Cable Loss

Product	Notebook		
Test Mode	RF Output Power (Radiated)		
Date of Test	2009/04/01	Test Site	OATS 3
Test Condition	WCDMA BAND II		

**Maximum Power- WCDMA BAND II**

Frequency (MHz)	Reading Level (dBm)	Substitution Level (dBm)	Substitution Antenna Gain (dBi)	Cable Loss (dB)	Result EIRP (dBm)	Result EIRP (W)
1852.4	-15.659	15.246	10.4	1.02	24.626	0.29
1880	-18.207	13.030	10.4	1.02	22.410	0.17
1907.6	-17.858	13.631	10.4	1.02	23.011	0.20

## Note:

1. The EUT meets the requirements of FCC CFR 47: Part 24, Section 24.232(b) for Effective Isotropically Radiated Power.
2. Receiver setting (Peak Detector) : RBW:5MHz; VBW:5MHz
3. Result EIRP = Substitution Level + Substitution Antenna Gain - Cable Loss

Product	Notebook		
Test Mode	RF Output Power (Radiated)		
Date of Test	2009/04/01	Test Site	OATS 3
Test Condition	WCDMA BAND II HSDPA		

**Maximum Power- WCDMA BAND II HSDPA**

Frequency (MHz)	Reading Level (dBm)	Substitution Level (dBm)	Substitution Antenna Gain (dBi)	Cable Loss (dB)	Result EIRP (dBm)	Result EIRP (W)
1852.4	-15.839	15.066	10.4	1.02	24.446	0.28
1880	-18.049	13.188	10.4	1.02	22.568	0.18
1907.6	-17.678	13.811	10.4	1.02	23.191	0.21

## Note:

1. The EUT meets the requirements of FCC CFR 47: Part 24, Section 24.232(b) for Effective Isotropically Radiated Power.
2. Receiver setting (Peak Detector) : RBW:5MHz; VBW:5MHz
3. Result EIRP = Substitution Level + Substitution Antenna Gain - Cable Loss

Product	Notebook		
Test Mode	RF Output Power (Radiated)		
Date of Test	2009/04/01	Test Site	OATS 3
Test Condition	WCDMA BAND II HSUPA		

**Maximum Power- WCDMA BAND II HSUPA**

Frequency (MHz)	Reading Level (dBm)	Substitution Level (dBm)	Substitution Antenna Gain (dBi)	Cable Loss (dB)	Result EIRP (dBm)	Result EIRP (W)
1852.4	-15.132	15.773	10.4	1.02	25.153	0.33
1880	-18.114	13.123	10.4	1.02	22.503	0.18
1907.6	-17.757	13.732	10.4	1.02	23.112	0.20

## Note:

1. The EUT meets the requirements of FCC CFR 47: Part 24, Section 24.232(b) for Effective Isotropically Radiated Power.
2. Receiver setting (Peak Detector) : RBW:5MHz; VBW:5MHz
3. Result EIRP = Substitution Level + Substitution Antenna Gain - Cable Loss



### 3. Occupied Bandwidth

#### 3.1. Test Equipment

The following test equipments are used during the occupied bandwidth tests:

Equipment	Manufacturer	Model No./Serial No.	Last Cal.
Spectrum Analyzer (9K-26.5GHz)	Agilent	N9020A/MY48010570	Apr., 2009
Universal Radio Communication Tester	R & S	CMU200 / 104846	Apr., 2009
Directional coupler	Agilent	87300C / MY44300353	Aug., 2008
Directional coupler	Agilent	778D-012/ 50550	Aug., 2008

Note: All equipments upon which need to be calibrated are with calibration period of 1 year.

#### 3.2. Test Setup

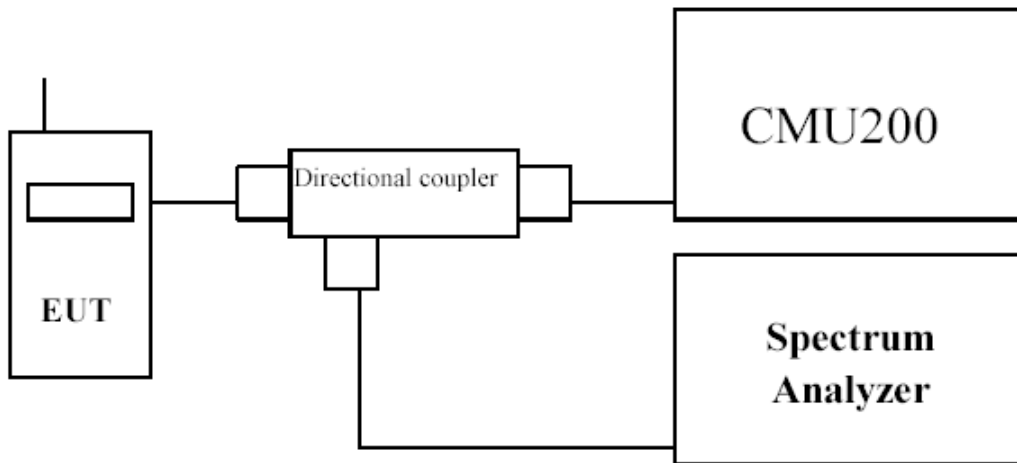

#### 3.3. Test Procedure

The EUT is tested with maximum rated TX power via the Base Station simulator, and the occupied bandwidth was measured at the antenna terminals of the EUT.

The Resolution BW of the analyzer is set to 1 % of the emission bandwidth. The EUT's occupied bandwidth is measured as the width of the signal between two points, one below the carrier center frequency and one above the carrier frequency, outside of which all emissions are attenuated at least 26 dB below the transmitter power.

The plots below show the resultant display from the Spectrum Analyzer.

### **3.4. Test Specification**

According to Part 2.1049, 22.917(b), 24.238(b).

### 3.5. Test Result of Occupied Bandwidth

Product	Notebook		
Test Mode	Occupied Bandwidth		
Date of Test	2009/03/28	Test Site	CTR
Test Condition	GSM 850 GPRS		

GSM 850 GPRS - Packet Switched (GSM Mode CH 128)

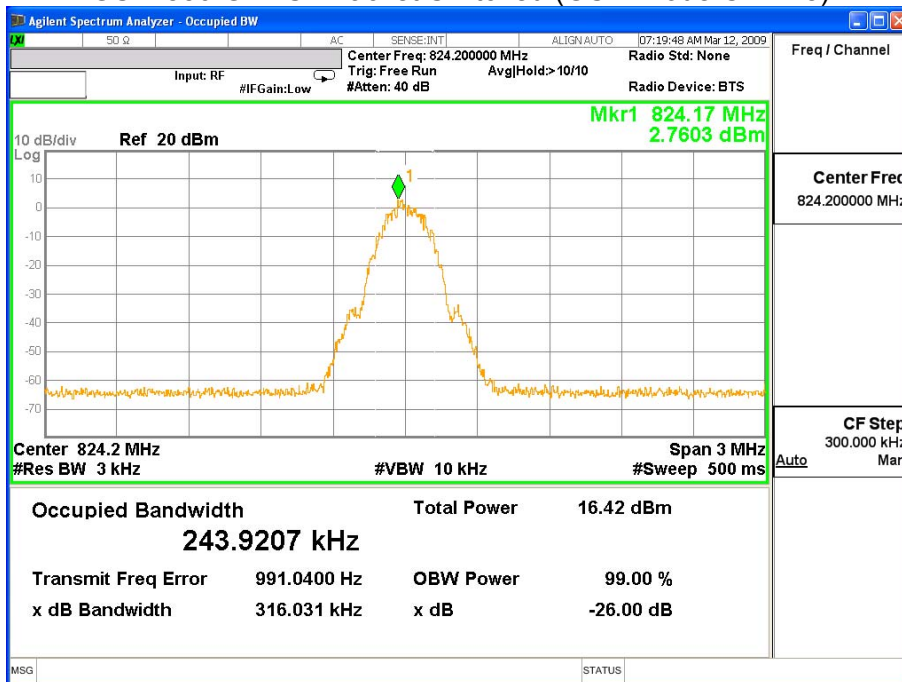

GSM 850 GPRS - Packet Switched (GSM Mode CH189)

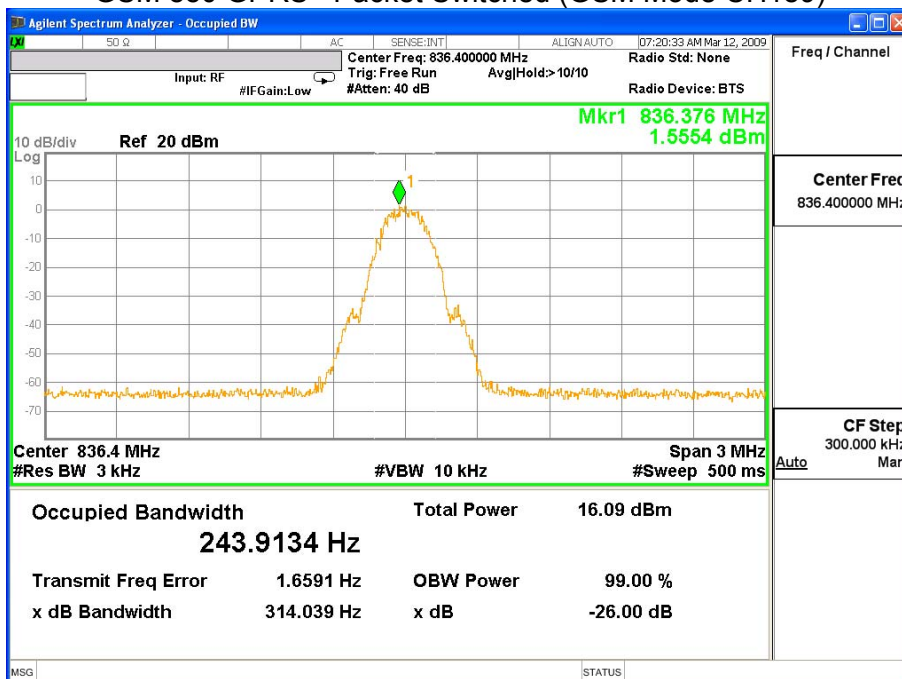

Product	Notebook		
Test Mode	Occupied Bandwidth		
Date of Test	2009/03/28	Test Site	CTR
Test Condition	GSM 850 GPRS		

GSM 850 GPRS - Packet Switched (GSM Mode CH 251)

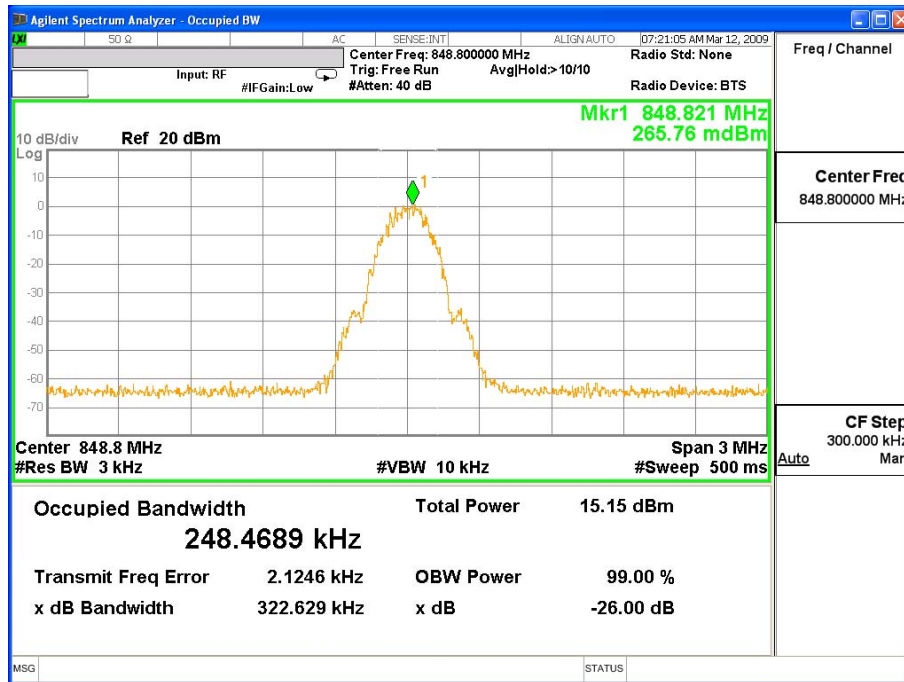

Product	Notebook		
Test Mode	Occupied Bandwidth		
Date of Test	2009/03/28	Test Site	CTR
Test Condition	GSM 850 EGPRS		

GSM 850 EGPRS - Packet Switched (GSM Mode CH 128)

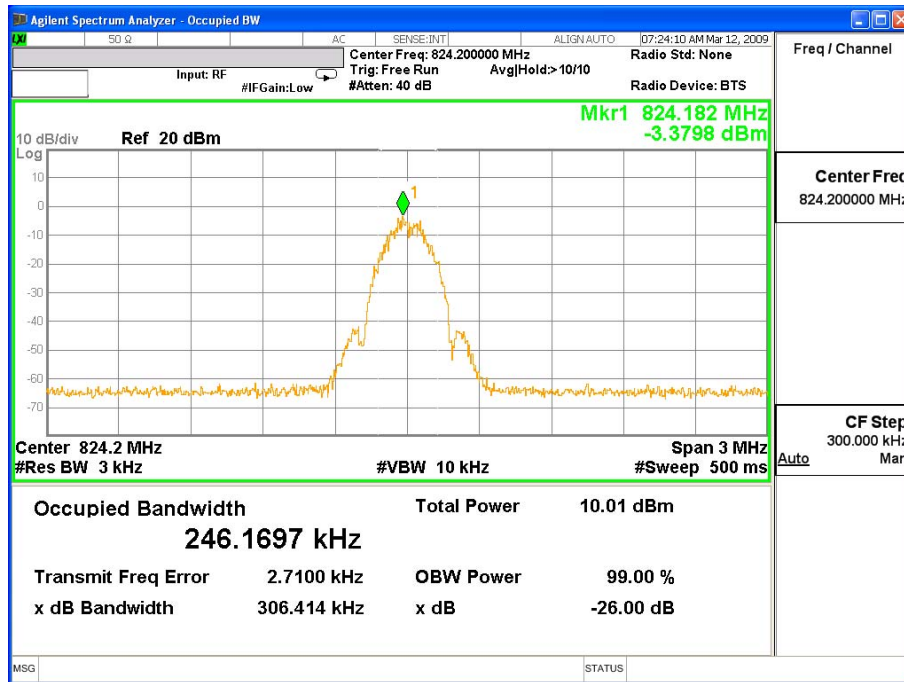

GSM 850 EGPRS - Packet Switched (GSM Mode CH189)

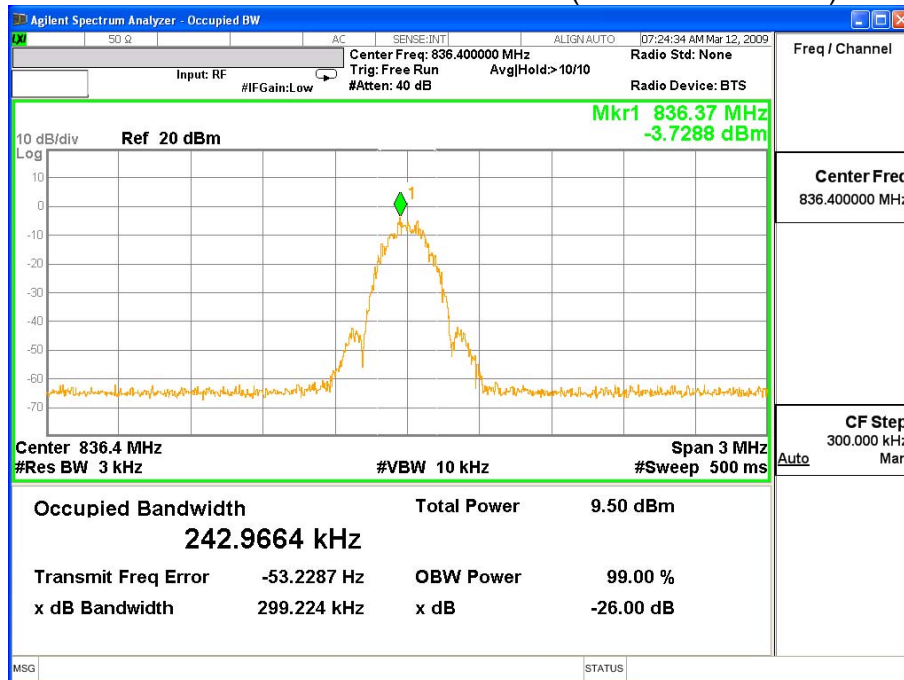

Product	Notebook		
Test Mode	Occupied Bandwidth		
Date of Test	2009/03/28	Test Site	CTR
Test Condition	GSM 850 EGPRS		

GSM 850 EGPRS - Packet Switched (GSM Mode CH 251)

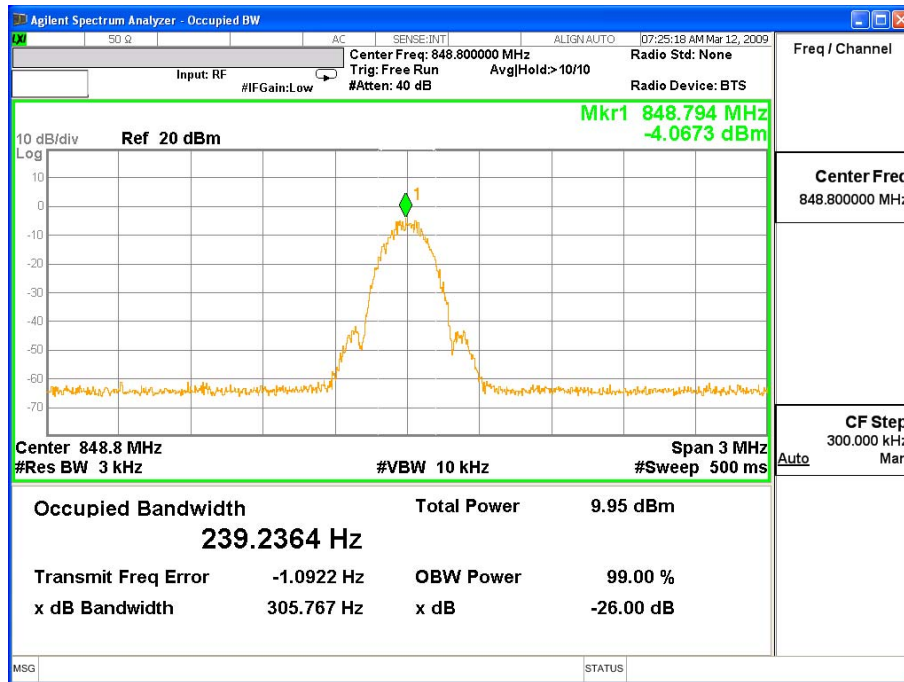

Product	Notebook		
Test Mode	Occupied Bandwidth		
Date of Test	2009/03/28	Test Site	CTR
Test Condition	PCS1900 GPRS		

PCS1900 GPRS - Packet Switched (PCS Mode CH 512)

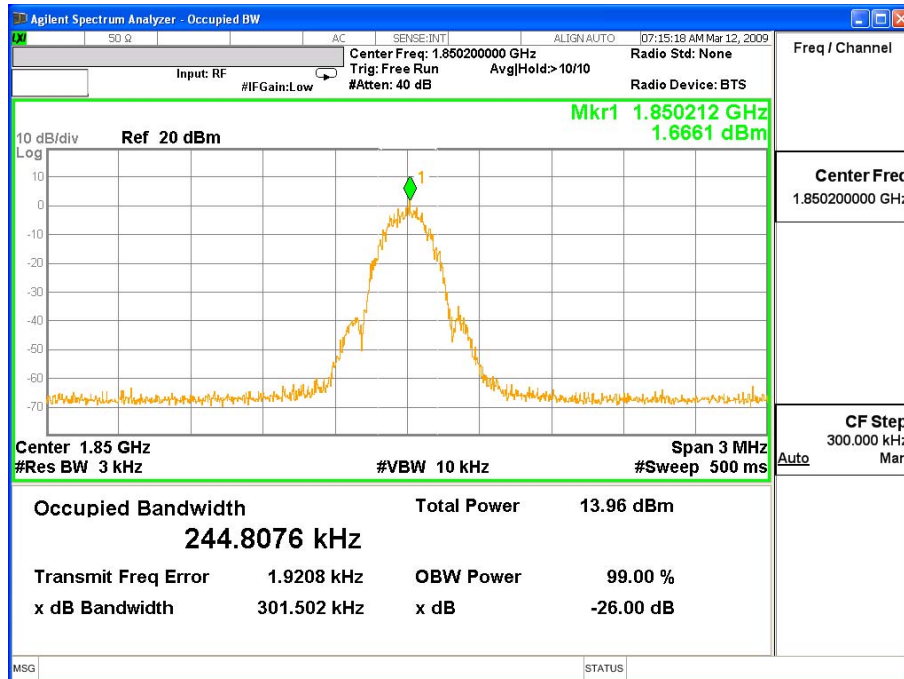

PCS1900 GPRS - Packet Switched (PCS Mode CH661)

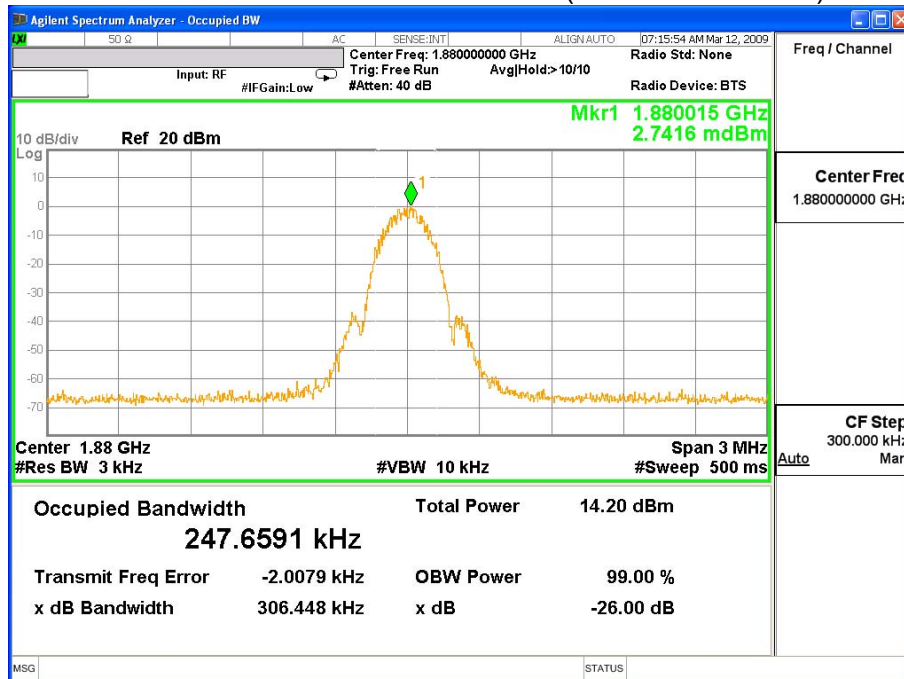

Product	Notebook		
Test Mode	Occupied Bandwidth		
Date of Test	2009/03/28	Test Site	CTR
Test Condition	PCS1900 GPRS		

PCS1900 GPRS - Packet Switched (PCS Mode CH 810)

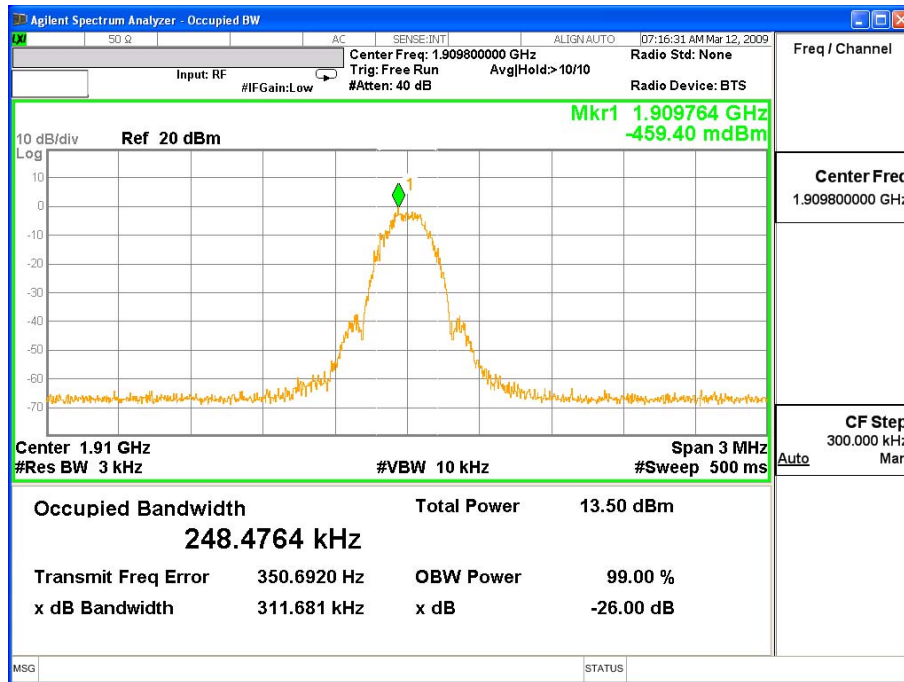



Product	Notebook		
Test Mode	Occupied Bandwidth		
Date of Test	2009/03/28	Test Site	CTR
Test Condition	PCS1900 EGPRS		

PCS1900 EGPRS - Packet Switched (PCS Mode CH 512)

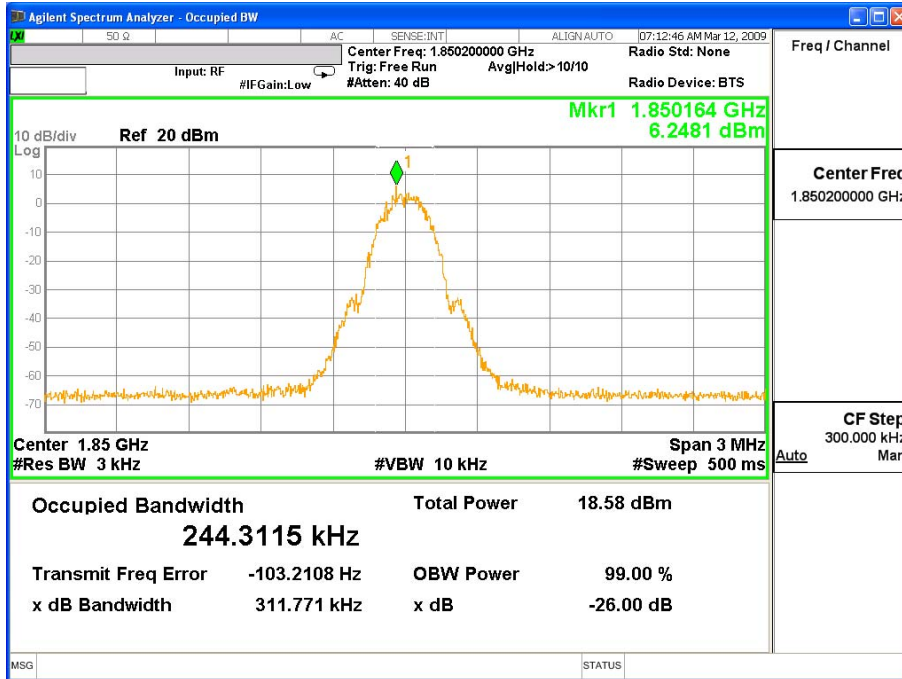

PCS1900 EGPRS - Packet Switched (PCS Mode CH661)

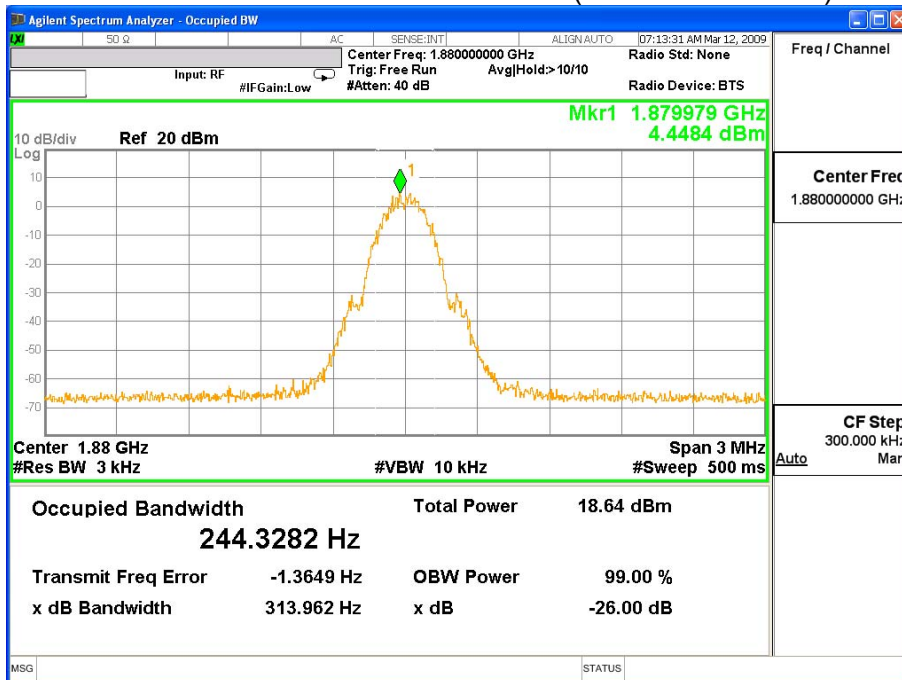

Product	Notebook		
Test Mode	Occupied Bandwidth		
Date of Test	2009/03/28	Test Site	CTR
Test Condition	PCS1900 EGPRS		

PCS1900 EGPRS - Packet Switched (PCS Mode CH 810)

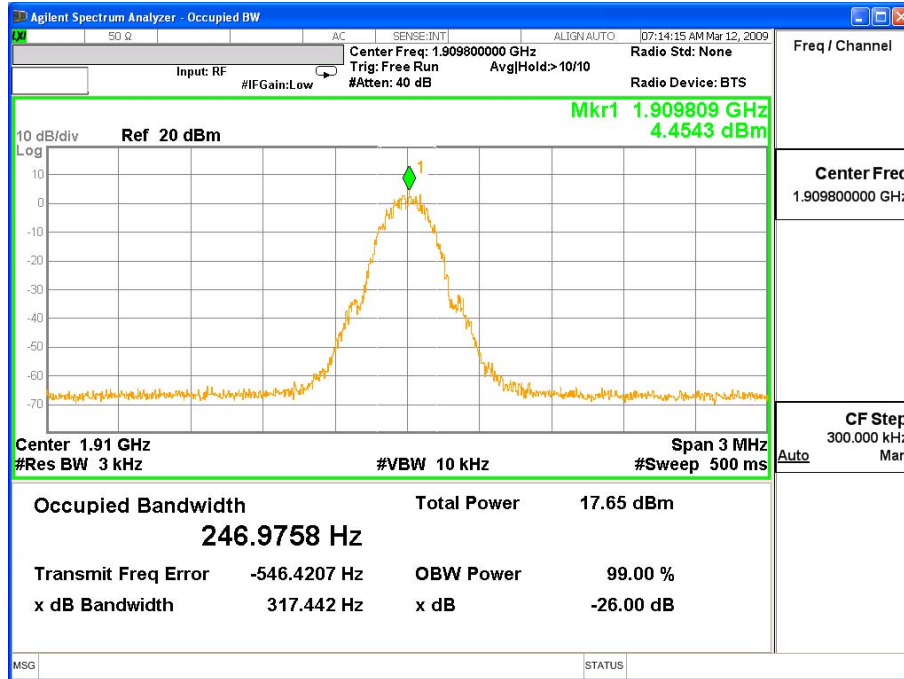

Product	Notebook		
Test Mode	Occupied Bandwidth		
Date of Test	2009/03/28	Test Site	CTR
Test Condition	WCDMA BAND V		

WCDMA BAND V (WCDMA Mode CH 4132)

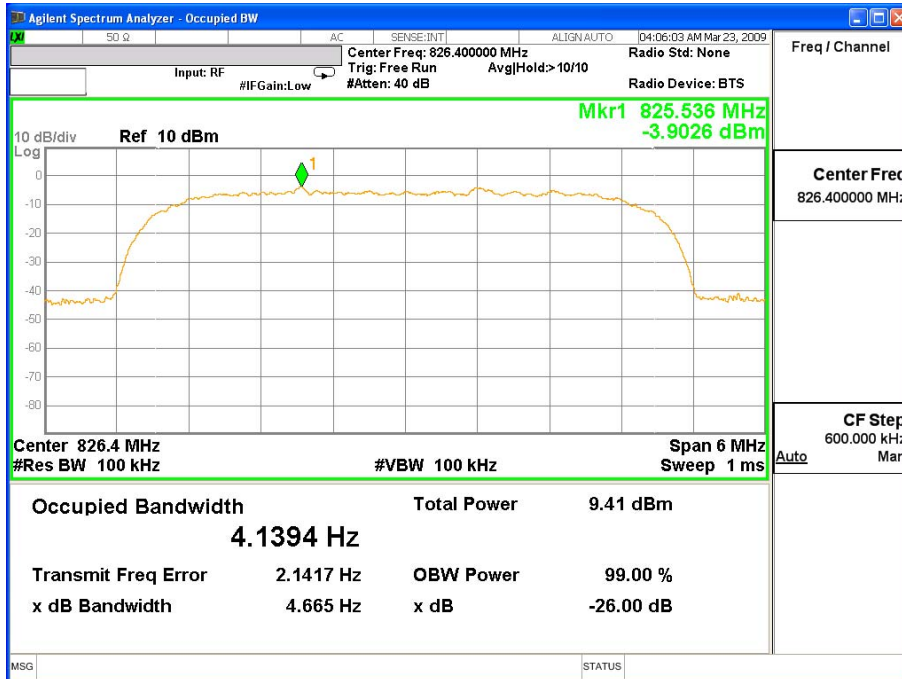

WCDMA BAND V (WCDMA Mode CH 4183)

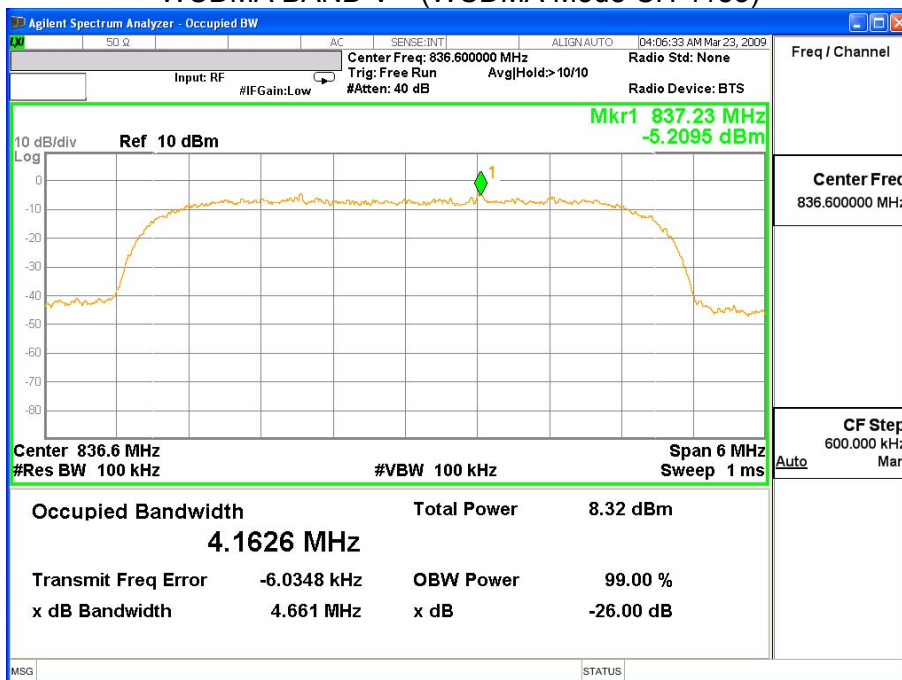

Product	Notebook		
Test Mode	Occupied Bandwidth		
Date of Test	2009/03/28	Test Site	CTR
Test Condition	WCDMA BAND V		

WCDMA BAND V (WCDMA Mode CH 4233)

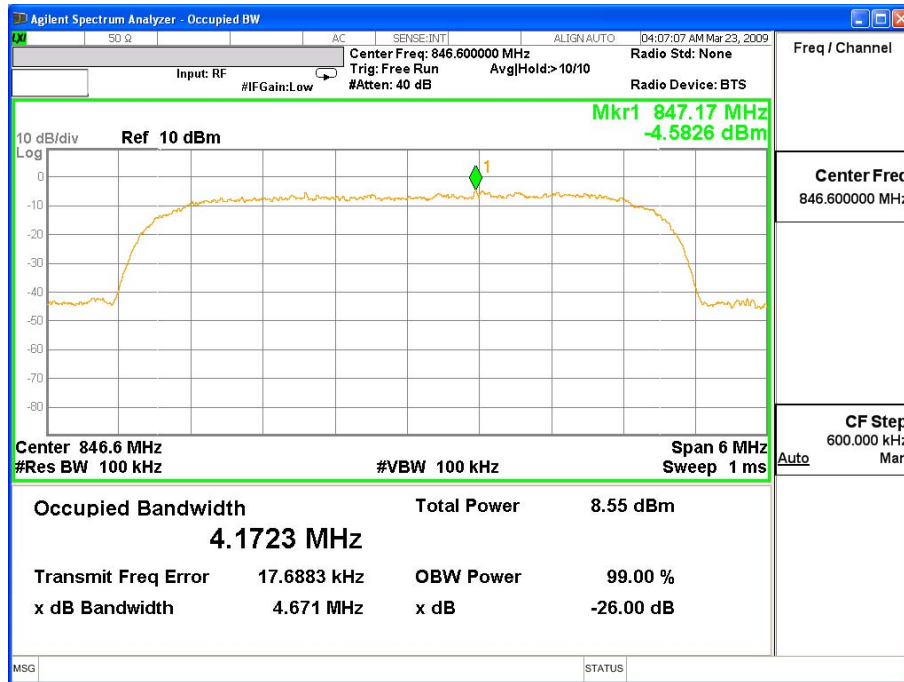

Product	Notebook		
Test Mode	Occupied Bandwidth		
Date of Test	2009/03/28	Test Site	CTR
Test Condition	WCDMA BAND V HSDPA		

WCDMA BAND V HSDPA - Packet Switched (HSDPA Mode CH 4132)

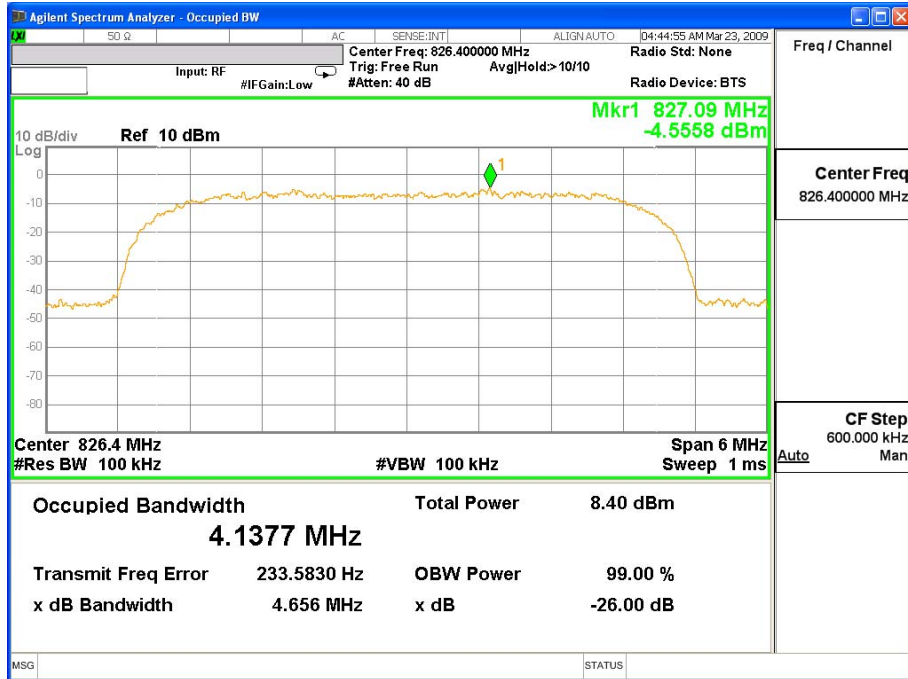

WCDMA BAND V HSDPA - Packet Switched (HSDPA Mode CH 4183)

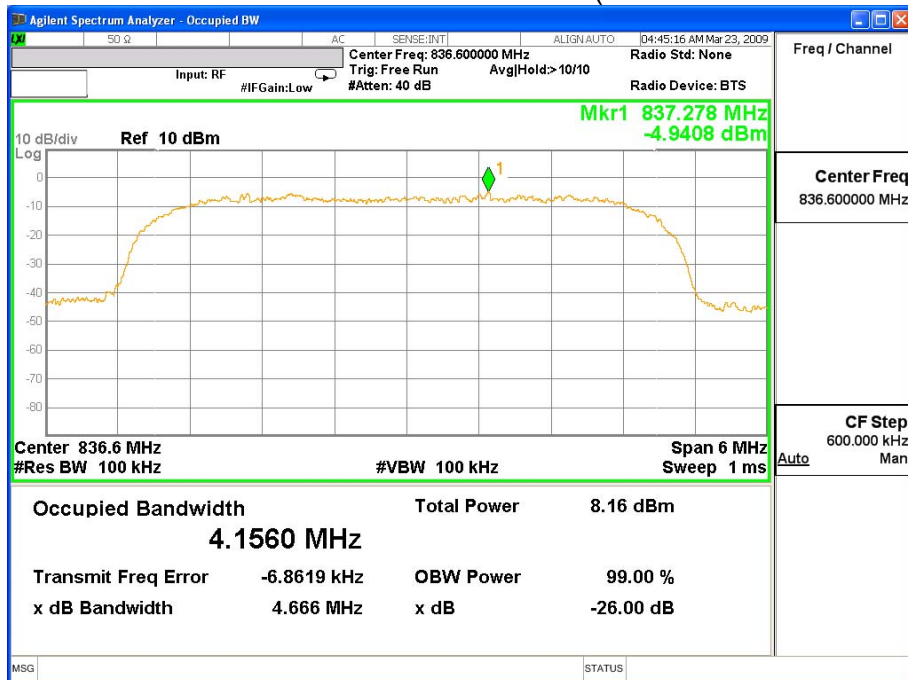

Product	Notebook		
Test Mode	Occupied Bandwidth		
Date of Test	2009/03/28	Test Site	CTR
Test Condition	WCDMA BAND V HSDPA		

WCDMA BAND V HSDPA - Packet Switched (HSDPA Mode CH 4233)

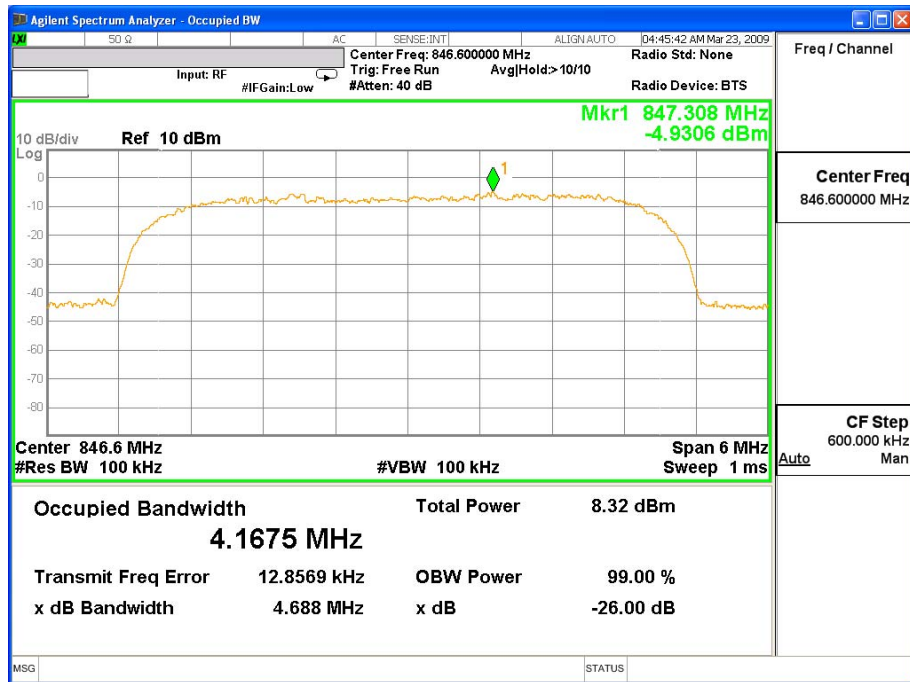

Product	Notebook		
Test Mode	Occupied Bandwidth		
Date of Test	2009/03/28	Test Site	CTR
Test Condition	WCDMA BAND V HSUPA		

WCDMA BAND V HSUPA - Packet Switched (HSUPA Mode CH 4132)

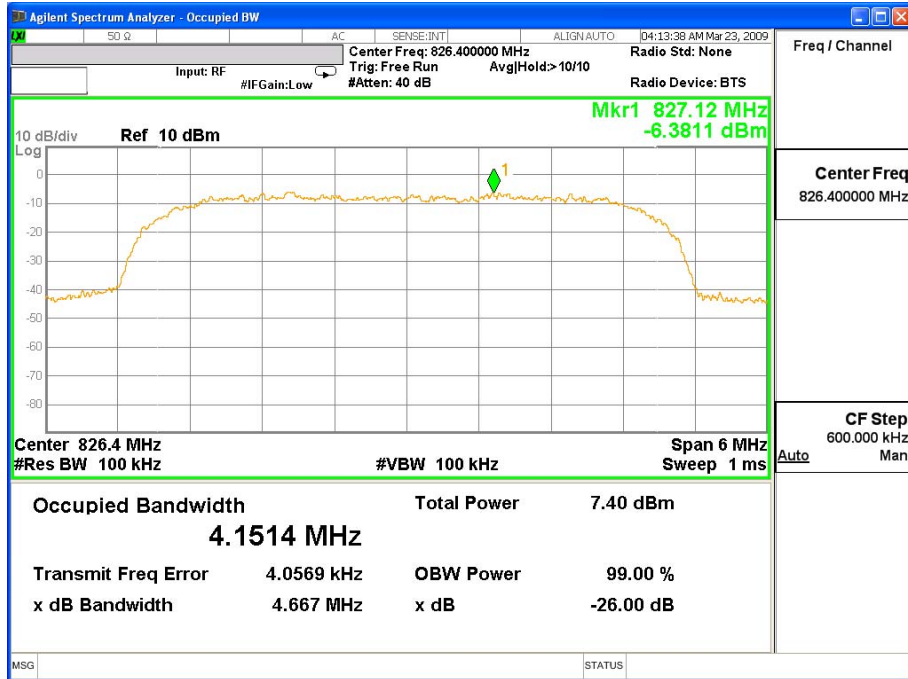

WCDMA BAND V HSUPA - Packet Switched (HSUPA Mode CH 4183)

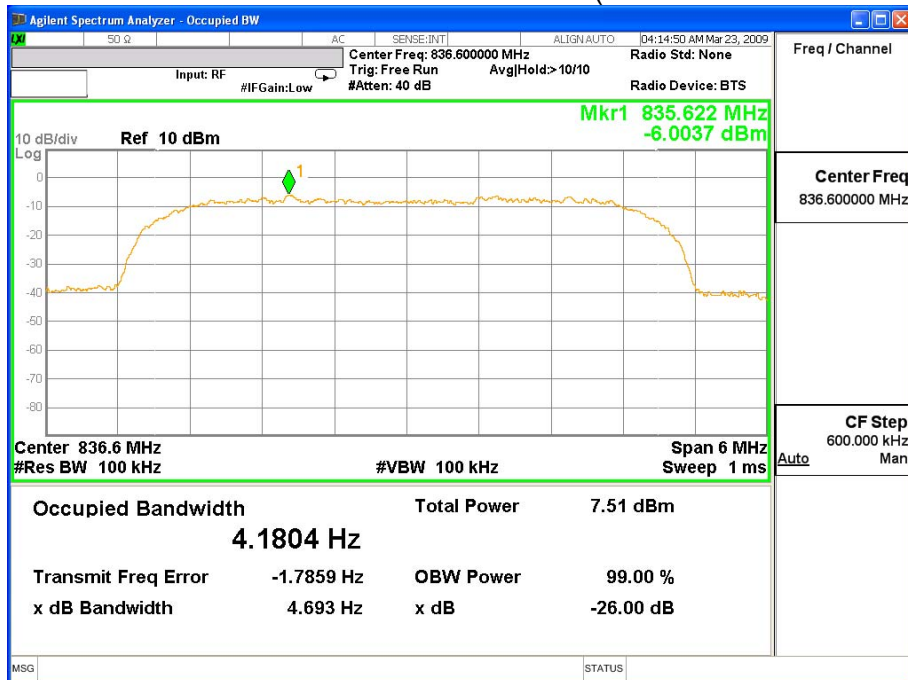

Product	Notebook		
Test Mode	Occupied Bandwidth		
Date of Test	2009/03/28	Test Site	CTR
Test Condition	WCDMA BAND V HSUPA		

WCDMA BAND V HSUPA - Packet Switched (HSUPA Mode CH 4233)

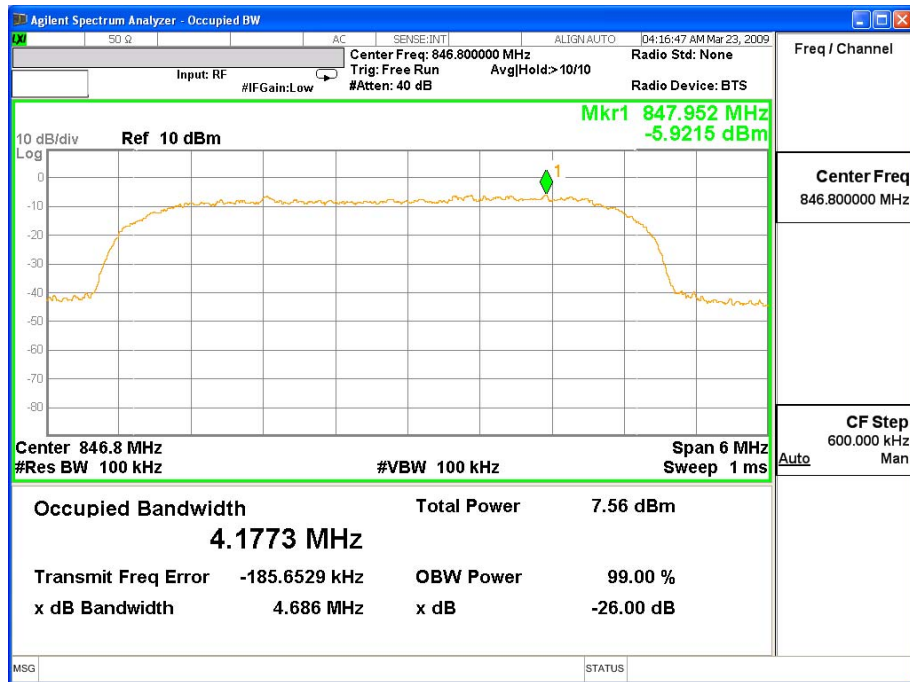



Product	Notebook		
Test Mode	Occupied Bandwidth		
Date of Test	2009/03/28	Test Site	CTR
Test Condition	WCDMA BAND II		

WCDMA BAND II (WCDMA Mode CH 9262)

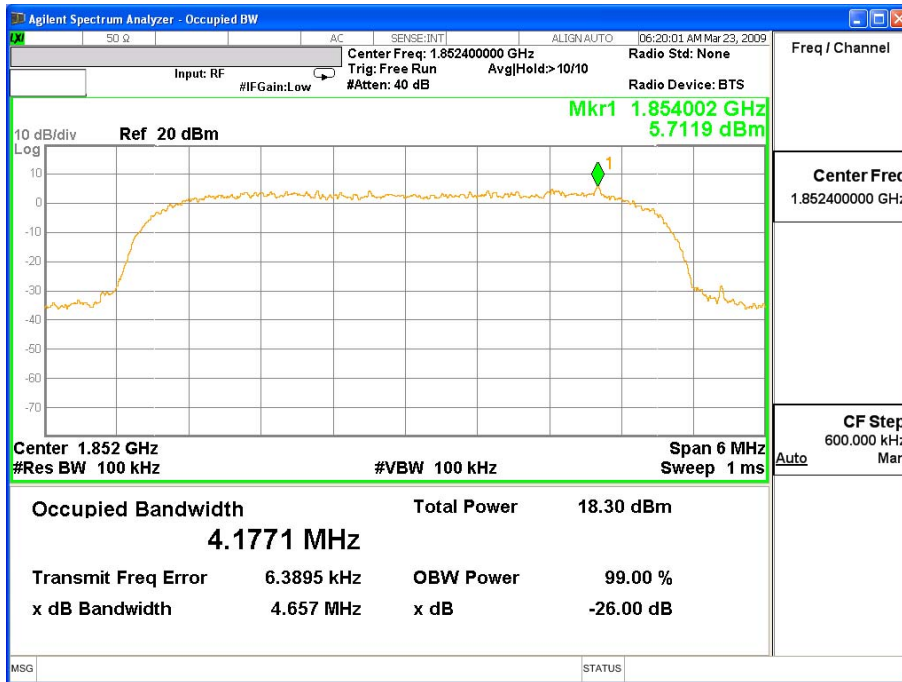

WCDMA BAND II (WCDMA Mode CH 9400)

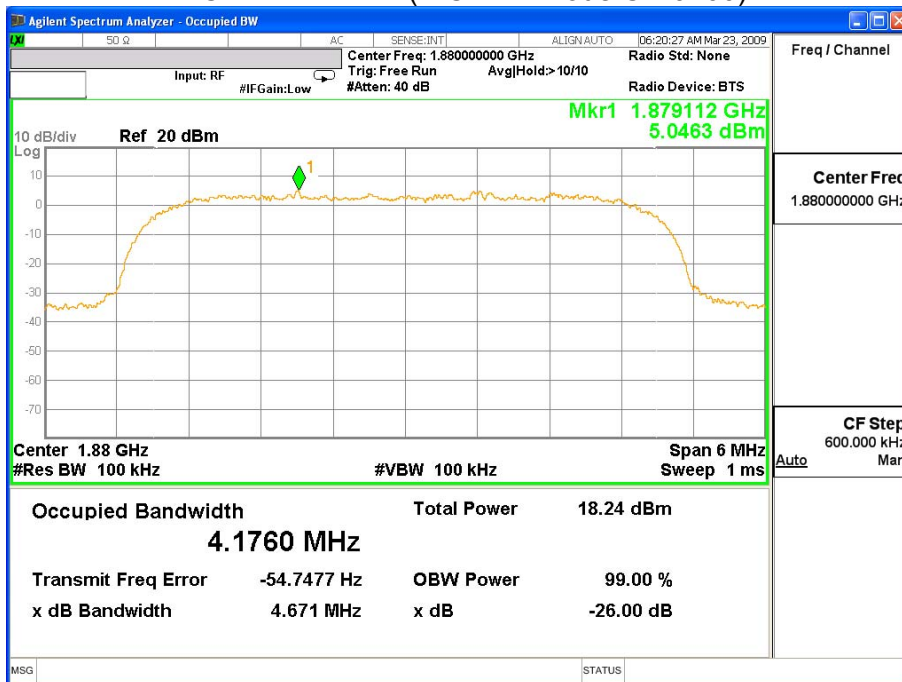

Product	Notebook		
Test Mode	Occupied Bandwidth		
Date of Test	2009/03/28	Test Site	CTR
Test Condition	WCDMA BAND II		

WCDMA BAND II (WCDMA Mode CH 9538)

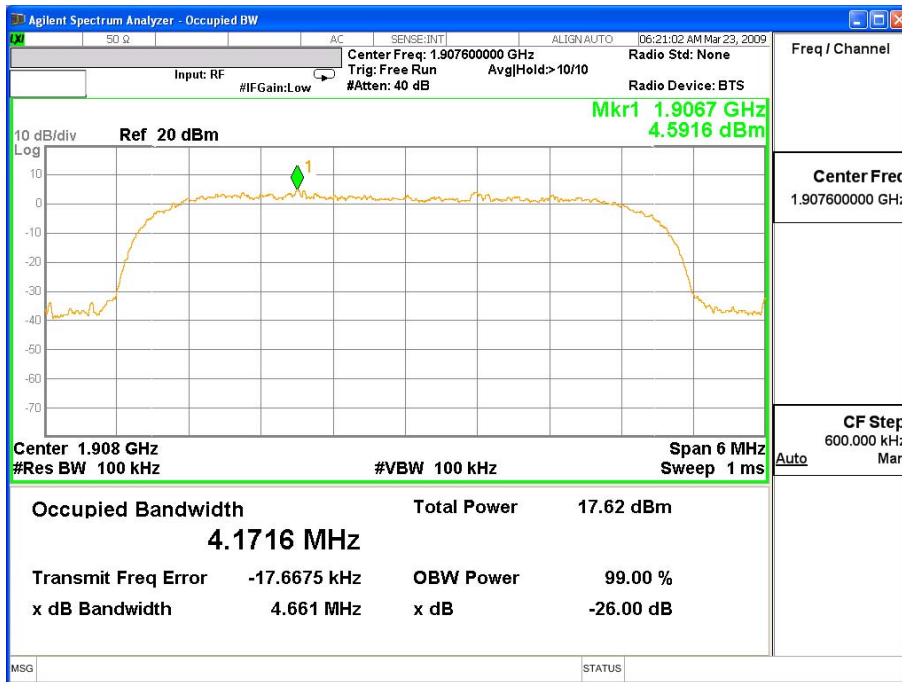

Product	Notebook		
Test Mode	Occupied Bandwidth		
Date of Test	2009/03/28	Test Site	CTR
Test Condition	WCDMA BAND II HSDPA		

WCDMA BAND II HSDPA - Packet Switched (HSDPA Mode CH 9262)

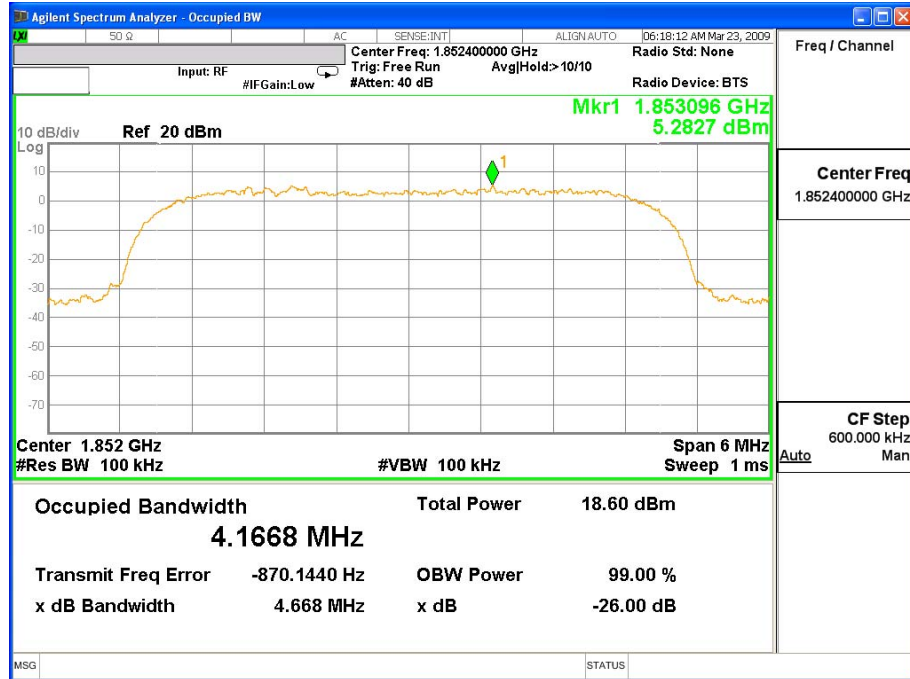

WCDMA BAND II HSDPA - Packet Switched (HSDPA Mode CH 9400)

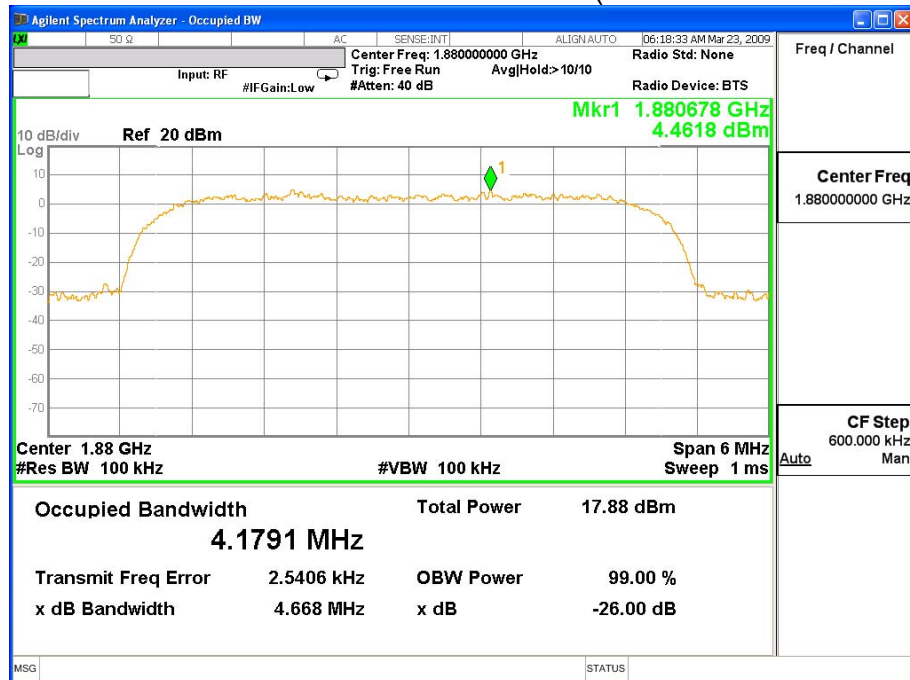

Product	Notebook		
Test Mode	Occupied Bandwidth		
Date of Test	2009/03/28	Test Site	CTR
Test Condition	WCDMA BAND II HSDPA		

WCDMA BAND II HSDPA - Packet Switched (HSDPA Mode CH 9538)

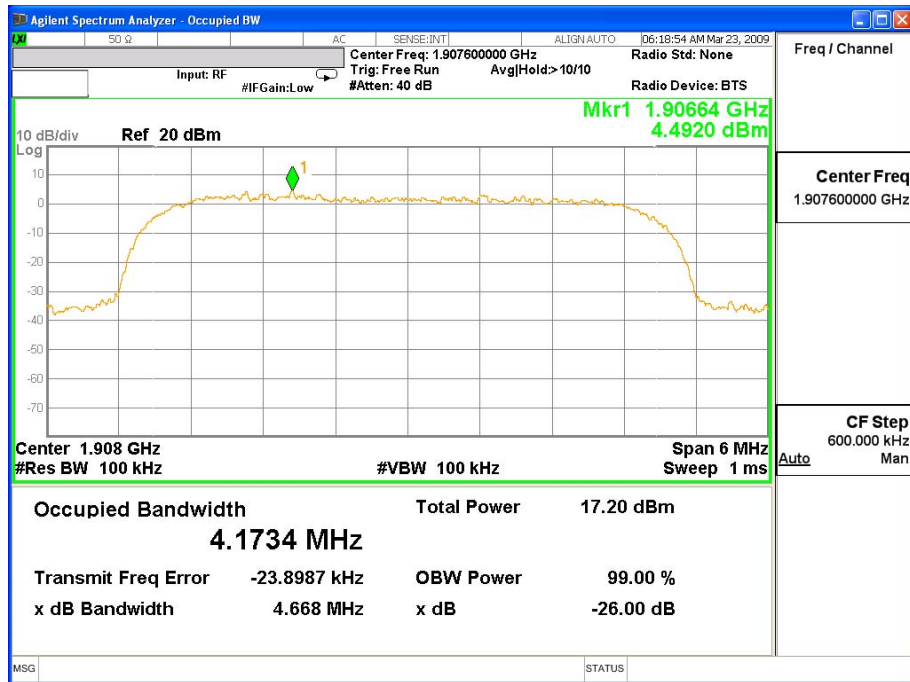

Product	Notebook		
Test Mode	Occupied Bandwidth		
Date of Test	2009/03/28	Test Site	CTR
Test Condition	WCDMA BAND II HSUPA		

WCDMA BAND II HSUPA - Packet Switched (HSUPA Mode CH 9262)

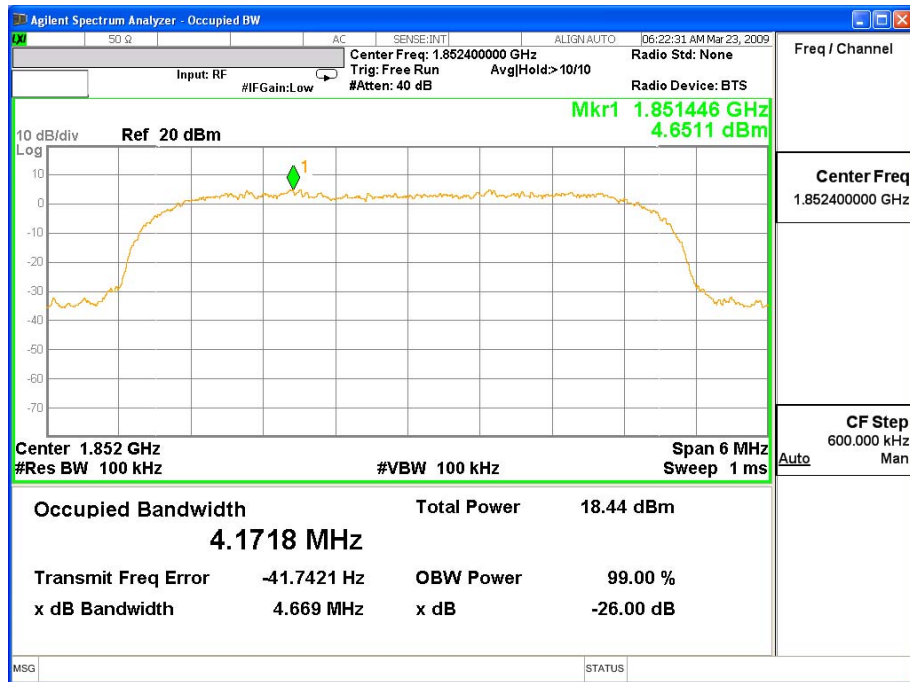

WCDMA BAND II HSUPA - Packet Switched (HSUPA Mode CH 9400)

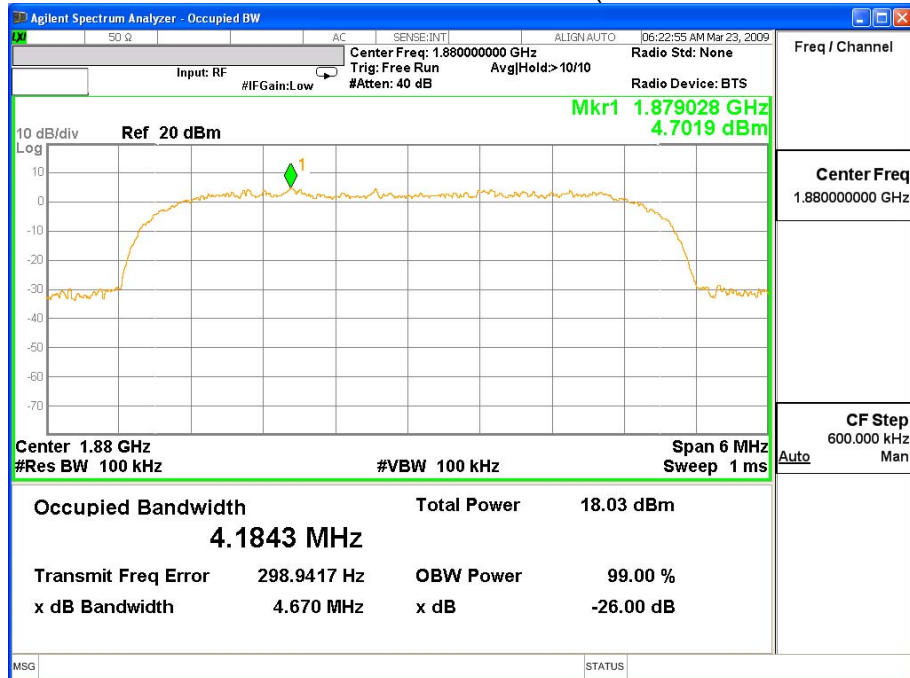

Product	Notebook		
Test Mode	Occupied Bandwidth		
Date of Test	2009/03/28	Test Site	CTR
Test Condition	WCDMA BAND II HSUPA		

WCDMA BAND II HSUPA - Packet Switched (HSUPA Mode CH 9538)

