

4. Spurious Emission At Antenna Terminals (+/-1MHz)

4.1. Test Equipment

The following test equipments are used during the spurious emission test

Equipment	Manufacturer	Model No./Serial No.	Last Cal.
Spectrum Analyzer (9K-26.5GHz)	Agilent	N9020A/MY48010570	Apr., 2009
Universal Radio Communication Tester	R & S	CMU200 / 104846	Apr., 2009
Directional coupler	Agilent	87300C / MY44300353	Aug., 2008
Directional coupler	Agilent	778D-012/ 50550	Aug., 2008

Note: All equipments upon which need to be calibrated are with calibration period of 1 year.

4.2. Setup

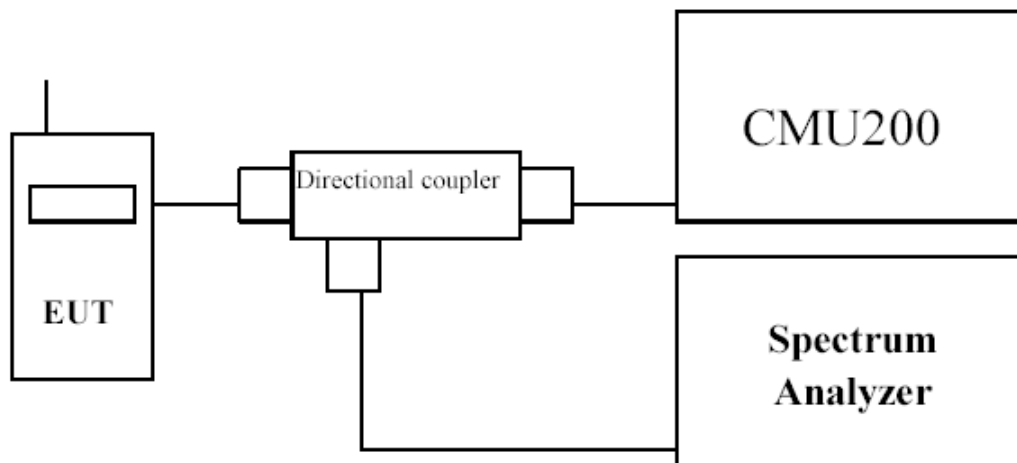

4.3. Limits

Cellular Band Transmitter limits for narrowband spurious emission

Lower Block Edge Test Frequencies	Upper Block Edge Test Frequencies
Block A Channel : 128 Frequency : 824.2 MHz	Block B Channel : 251 Frequency : 848.8 MHz

PCS Band Transmitter limits for narrowband spurious emission

Lower Block Edge Test Channels/Frequencies	Upper Block Edge Test Channels/Frequencies
Block A Channel : 512 Frequency : 1850.2 MHz	Block C Channel : 810 Frequency : 1909.8 MHz

4.4. Test Procedure

In accordance with Part 22.917 and 24.238, at least 1% of the emission bandwidth was used for the resolution and video bandwidths up to 1MHz away from the Block Edge. At greater than 1MHz, the resolution and video bandwidth were increased to 1MHz.

The reference power and path losses of all channels used for testing in each frequency block were measured.

4.5. Test Specification

According to Part 2.1049, 22.917,24.238.

4.6. Test Result of Spurious Emission At Antenna Terminals (+/-1MHz)

Product	Notebook		
Test Mode	Spurious Emission At Antenna Terminals (+/-1MHz)		
Date of Test	2009/03/28	Test Site	CTR
Test Condition	Block Edge Test (GSM 850 GPRS)		

GSM 850 GPRS Lower Channel 128 (824.2MHz)

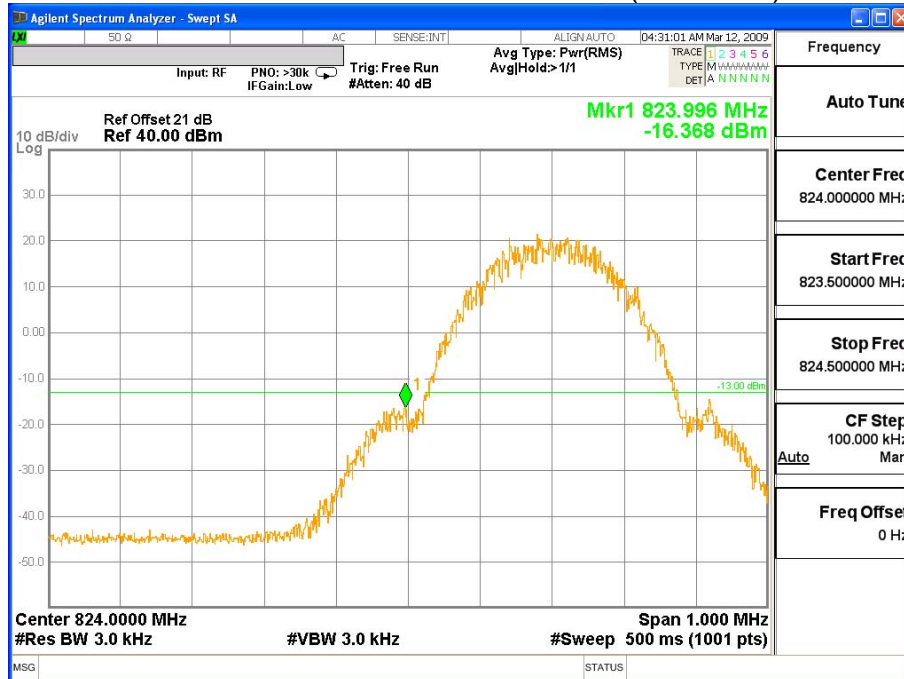

GSM 850 GPRS Upper Channel 251 (848.8MHz)

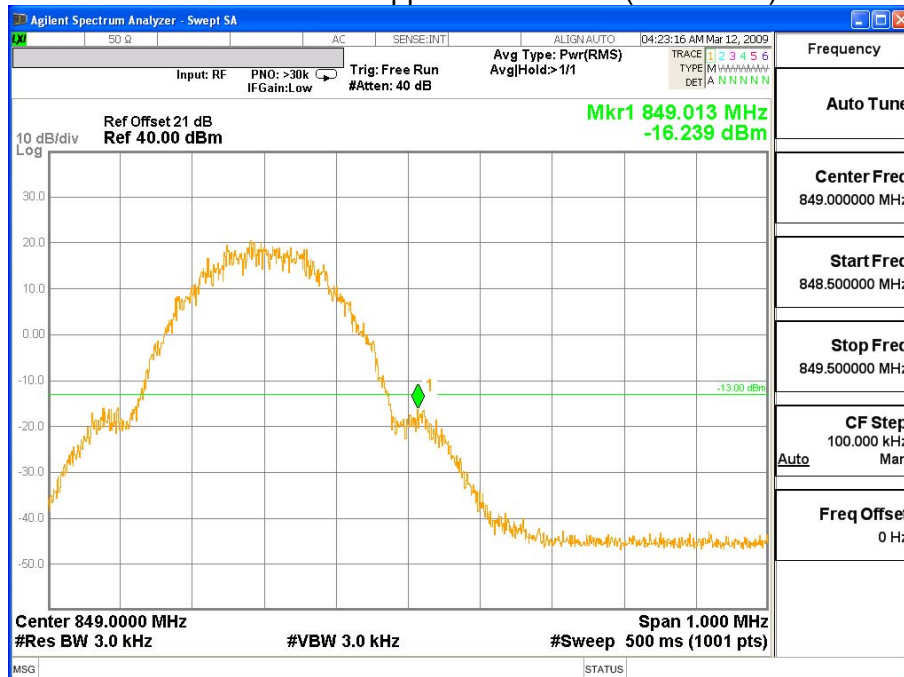

Product	Notebook		
Test Mode	Spurious Emission At Antenna Terminals (+/-1MHz)		
Date of Test	2009/03/28	Test Site	CTR
Test Condition	Block Edge Test (GSM 850 EGPRS)		

GSM 850 EGPRS Lower Channel 128 (824.2MHz)

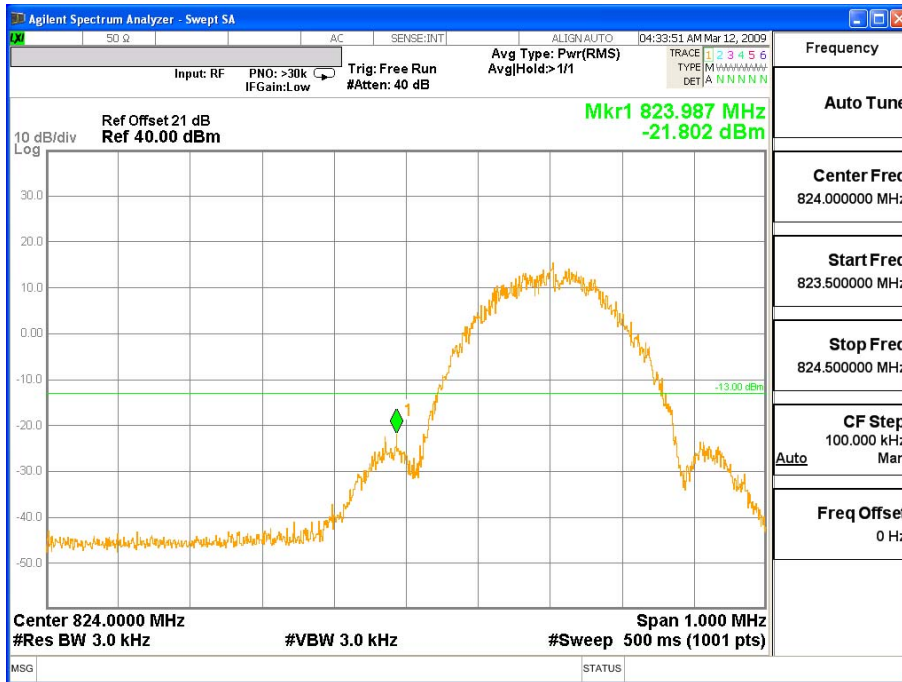

GSM 850 EGPRS Upper Channel 251(848.8MHz)

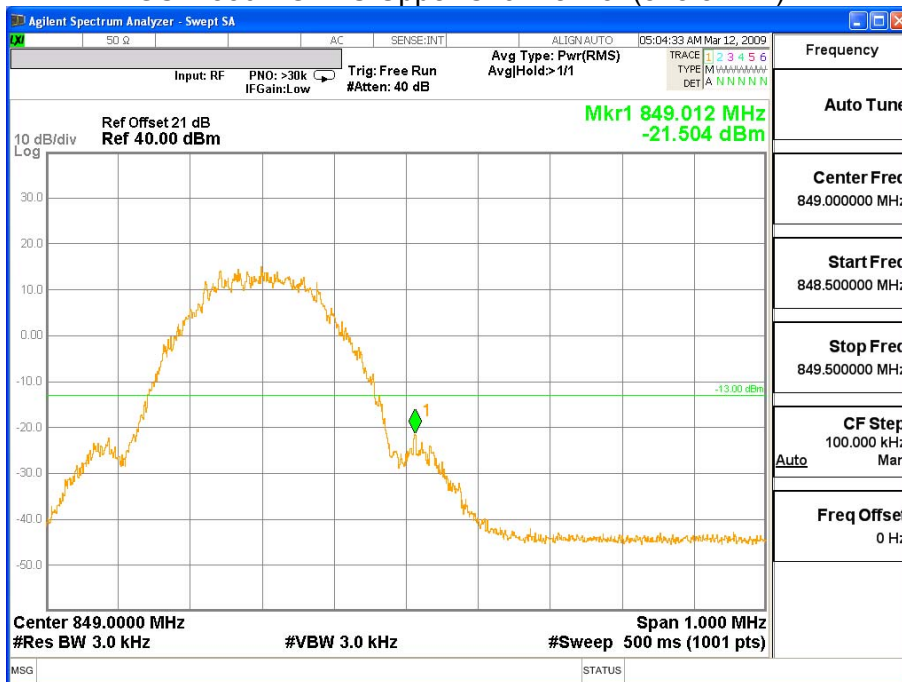

Product	Notebook		
Test Mode	Spurious Emission At Antenna Terminals (+/-1MHz)		
Date of Test	2009/03/28	Test Site	CTR
Test Condition	Block Edge Test (PCS 1900 GPRS)		

PCS 1900 GPRS Lower Channel 512 (1850.2MHz)

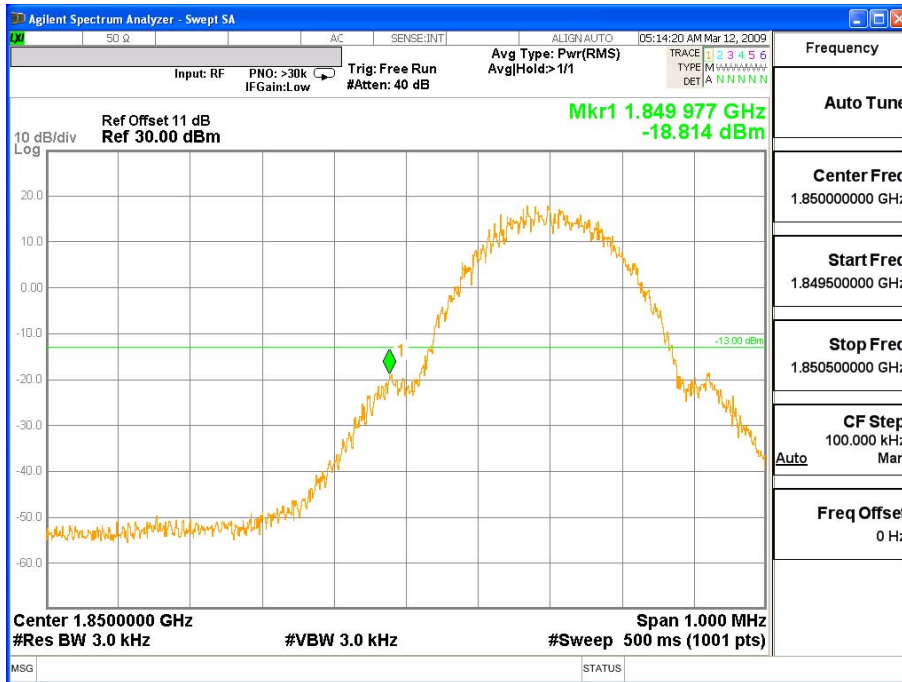

PCS 1900 GPRS Upper Channel 810(1910.0MHz)

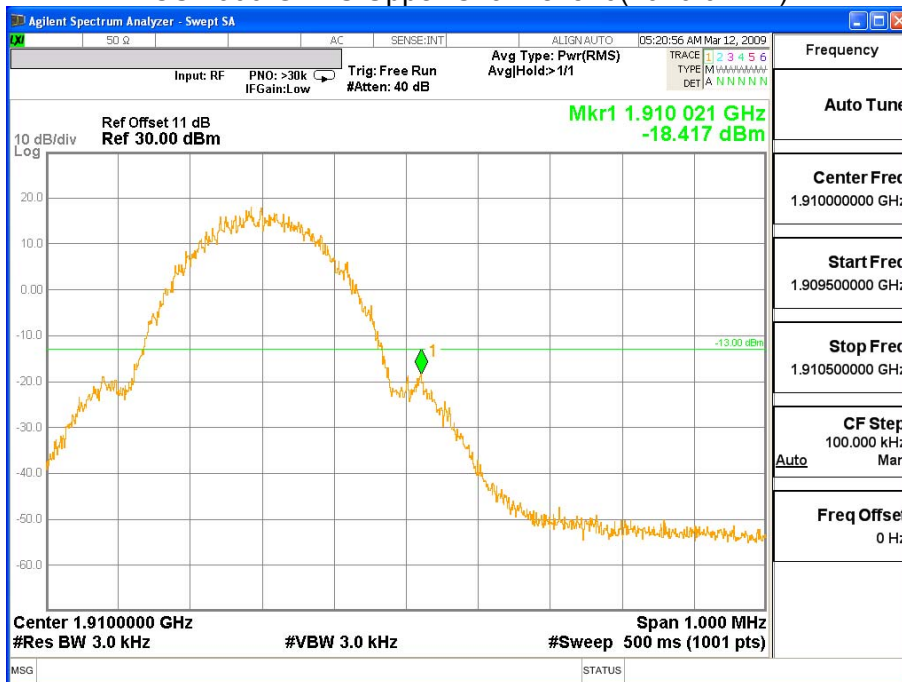

Product	Notebook		
Test Mode	Spurious Emission At Antenna Terminals (+/-1MHz)		
Date of Test	2009/03/28	Test Site	CTR
Test Condition	Block Edge Test (PCS 1900 EGPRS)		

PCS 1900 EGPRS Lower Channel 512 (1850.2MHz)

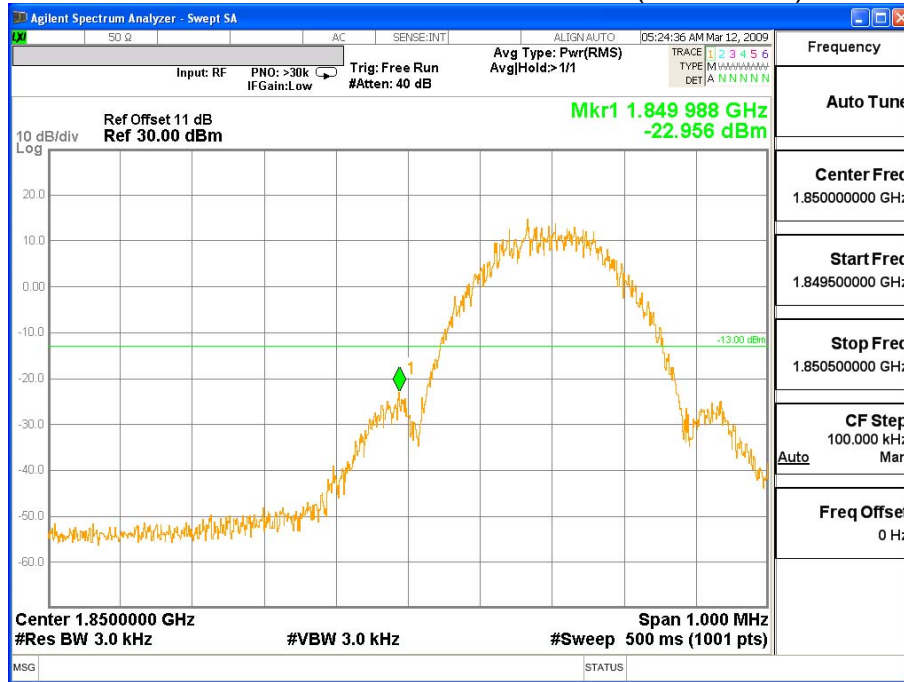

PCS 1900 EGPRS Upper Channel 810(1910.0MHz)

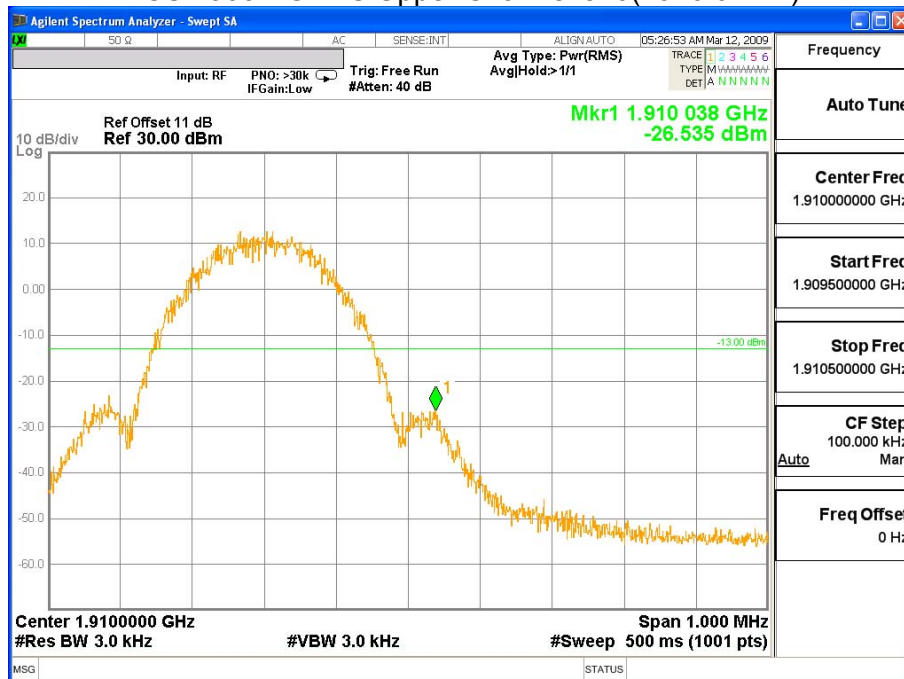

Product	Notebook		
Test Mode	Spurious Emission At Antenna Terminals (+/-1MHz)		
Date of Test	2009/03/28	Test Site	CTR
Test Condition	Block Edge Test (WCDMA BAND V)		

WCDMA BAND V Lower Channel 4132 (826.4MHz)

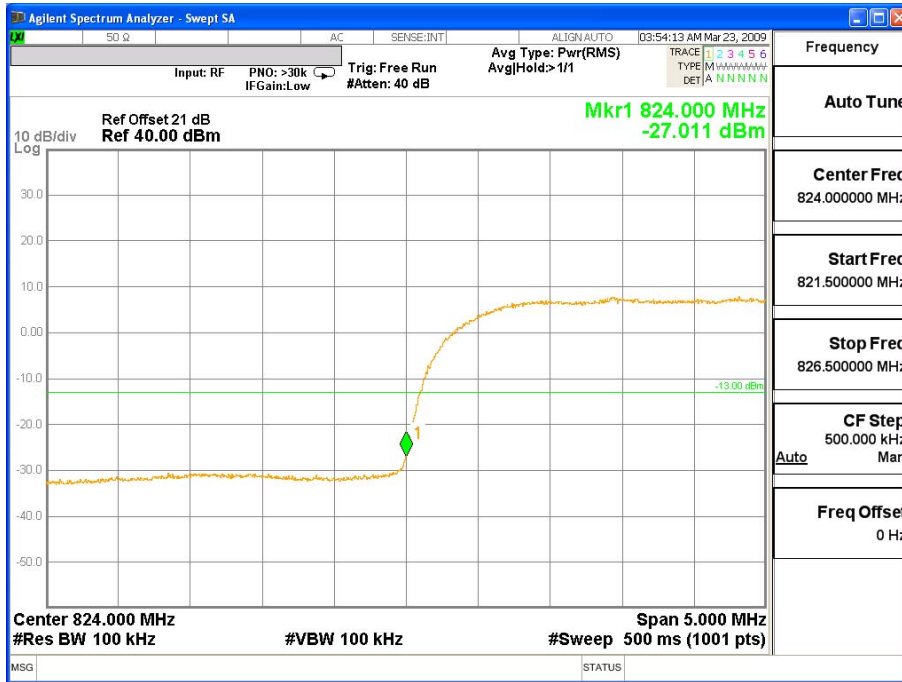

WCDMA BAND V Upper Channel 4233 (846.6MHz)



Product	Notebook		
Test Mode	Spurious Emission At Antenna Terminals (+/-1MHz)		
Date of Test	2009/03/28	Test Site	CTR
Test Condition	Block Edge Test (WCDMA BAND V HSDPA)		

WCDMA BAND V HSDPA Lower Channel 4132 (826.4MHz)

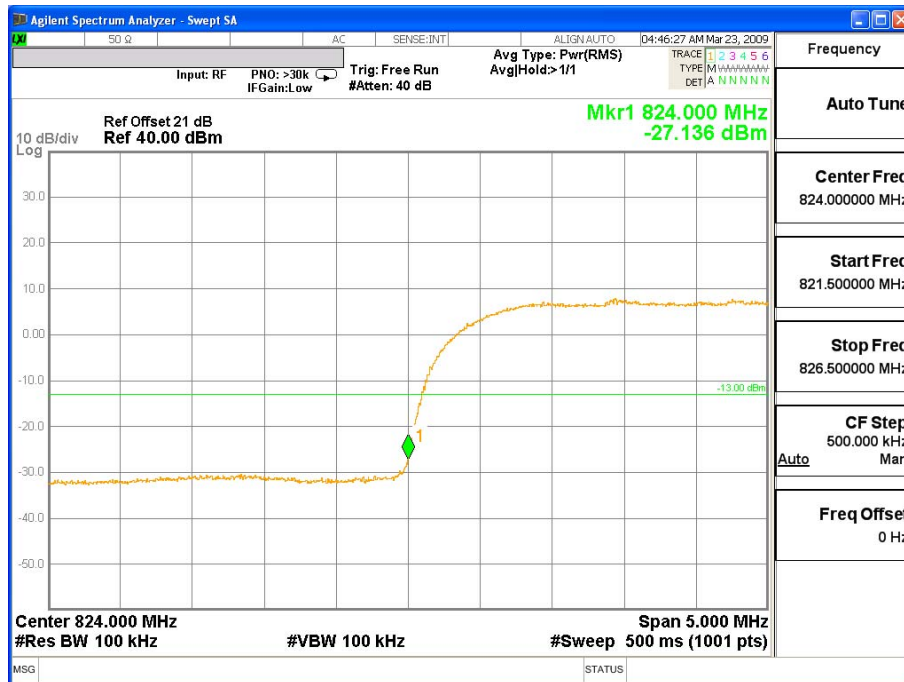

WCDMA BAND V HSDPA Upper Channel 4233 (846.6MHz)



Product	Notebook		
Test Mode	Spurious Emission At Antenna Terminals (+/-1MHz)		
Date of Test	2009/03/28	Test Site	CTR
Test Condition	Block Edge Test (WCDMA BAND V HSUPA)		

WCDMA BAND V HSUPA Lower Channel 4132 (826.4MHz)

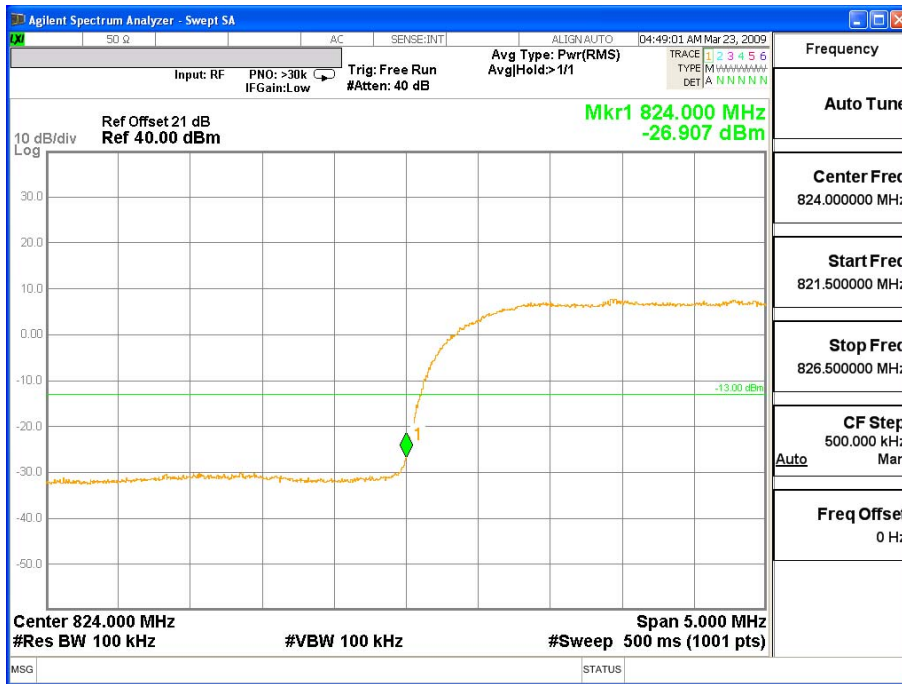

WCDMA BAND V HSUPA Upper Channel 4233 (846.6MHz)



Product	Notebook		
Test Mode	Spurious Emission At Antenna Terminals (+/-1MHz)		
Date of Test	2009/03/28	Test Site	CTR
Test Condition	Block Edge Test (WCDMA BAND II)		

WCDMA BAND II Lower Channel 9262 (1852.4MHz)



WCDMA BAND II Upper Channel 9538 (1907.6 MHz)

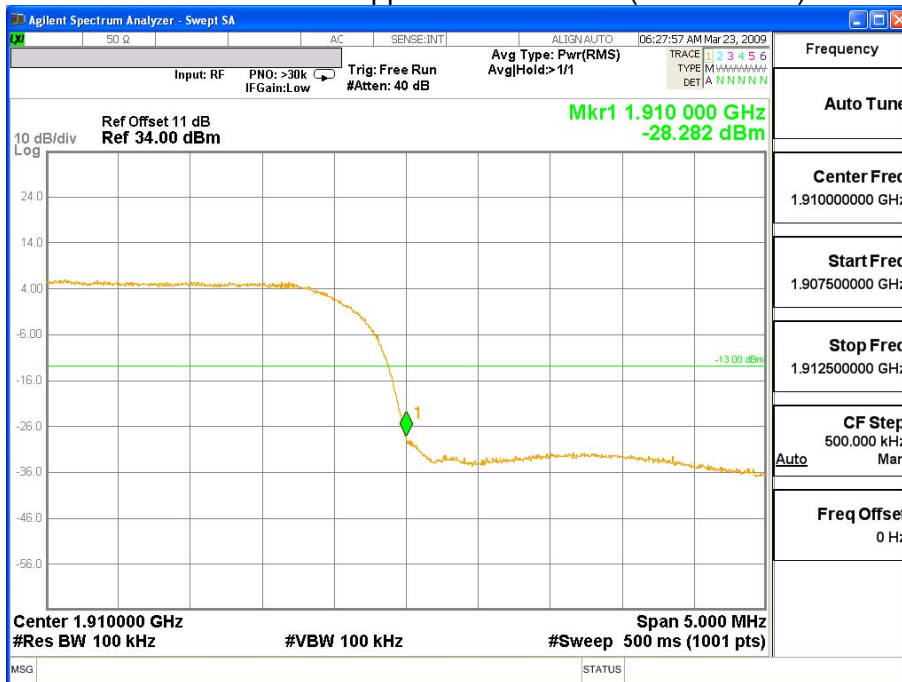

Product	Notebook		
Test Mode	Spurious Emission At Antenna Terminals (+/-1MHz)		
Date of Test	2009/03/28	Test Site	CTR
Test Condition	Block Edge Test (WCDMA BAND II HSDPA)		

WCDMA BAND II HSDPA Lower Channel 9262 (1852.4MHz)

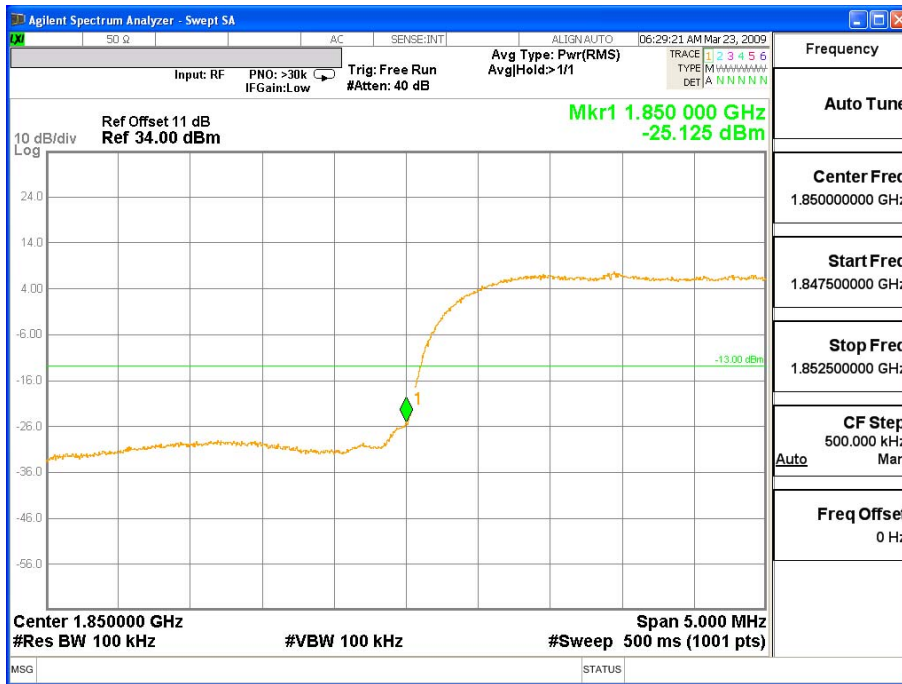

WCDMA BAND II HSDPA Upper Channel 9538 (1907.6 MHz)



Product	Notebook		
Test Mode	Spurious Emission At Antenna Terminals (+/-1MHz)		
Date of Test	2009/03/28	Test Site	CTR
Test Condition	Block Edge Test (WCDMA BAND II HSUPA)		

WCDMA BAND II HSUPA Lower Channel 9262 (1852.4MHz)



WCDMA BAND II HSUPA Upper Channel 9538 (1907.6 MHz)



5. Spurious Emission

5.1. Test Equipment

The following test equipments are used during the radiated emission test:

Test Site	Equipment	Manufacturer	Model No./Serial No.	Last Cal.
☒CTR	Spectrum Analyzer (9K-26.5GHz)	Agilent	N9020A/MY48010570	Apr., 2009
	Dual Directional couple	Agilent	778D-012/50550	Aug , 2008
	Directional coupler	Agilent	87300C/ MY44300353	Aug ., 2008
☒SITE1	Universal Radio Communication Tester	R & S	CMU200 / 104846	Apr ., 2009
	Bilog Antenna	Schaffner Chase	CBL6112B/2921	Aug ., 2008
	Broadband Horn Antenna	Schwarzbeck	BBHA9170/497	Sep ., 2008
	Horn Antenna	Schwarzbeck	BBHA9120D/ 305	Sep ., 2008
	Pre-Amplifier	QTK	N/A	N/A
	Microwave Amplifier (0.5GHZ-26.5GHZ)	Agilent	83017A/ MY39500682	Aug ., 2008
	Spectrum Analyzer	Agilent	N9020A/ MY48010570	Apr., 2009
	Universal Radio Communication Tester	R & S	CMU200 / 104846	Apr ., 2009

Note: 1. All equipments that need to be calibrated are with calibration period of 1 year.

5.2. Test Setup

5.2.1.1 Spurious emissions at antenna terminals.

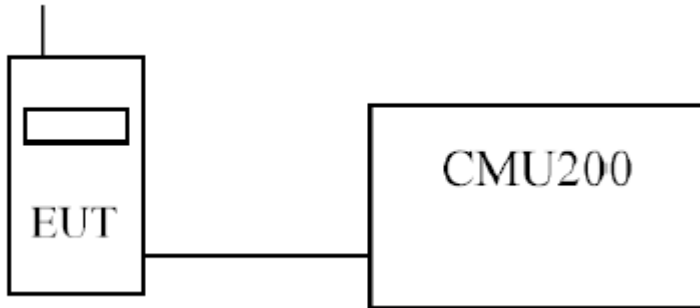

5.2.1.2 Field strength of spurious radiation.

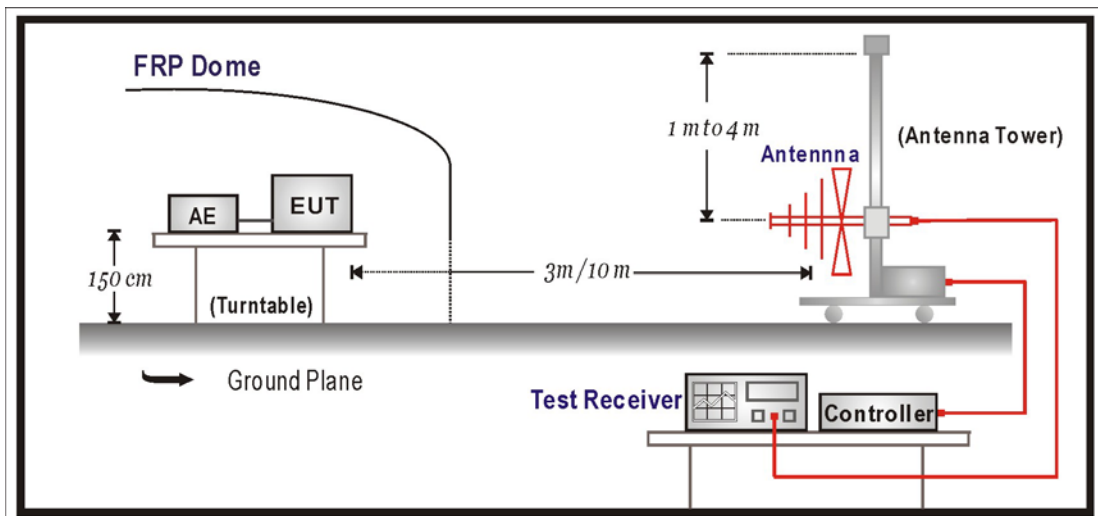

5.3. Limits

Limit	$<-13\text{dBm}$
-------	------------------

$43 + 10\text{Log}(P)$ down on the carrier where P is the power in Watts.

5.4. Test Procedure

In accordance with Part 2.1051, the spurious emissions from the antenna terminal were measured. The transmitter output power was attenuated using a combination of filters and attenuators and the frequency spectrum investigated from 30MHz to 20GHz. The EUT was set to transmit on full power. The EUT was tested on bottom, middle and top channels for both power levels. The resolution and video bandwidth was set to 3MHz in accordance with Part 22.917&24.238. The spectrum analyzer detector was set to Max Hold.

In addition, measurements were made up to the 10th harmonic of the fundamental.

The EUT is placed on a turn table which is 1.5 meter above ground. The turn table can rotate 360 degrees to determine the position of the maximum emission level. The EUT was positioned such that the distance from antenna to the EUT was 3 meters.

The antenna can move up and down between 1 meter and 4 meters to find out the maximum emission level.

Both horizontal and vertical polarization of the antenna are set on measurement. In order to find the maximum emission, all of the interface cables must be manipulated according to TIA/EIA 603-C on radiated measurement.

5.5. Test Specification

According to Part 2.1051, 2.1053, 22.917(a), 24.238(b).

5.6. Test Result of Spurious Emission

Product	Notebook		
Test Mode	Spurious Emission (Conducted)		
Date of Test	2009/03/28	Test Site	CTR
Test Condition	GSM 850 GPRS	Test Range	30MHz~10GHz

GSM 850 GPRS Middle-Channel 189

Frequency (MHz)	Reading Level (dBm)	Path Loss (dB)	Emission Level (dBm)	Limit (dBm)
1672.8	-44.472	0.58	-43.892	-13
2509.2	-52.119	0.7	-51.419	-13
3345.6	-61.102	1.01	-60.092	-13
4182	-62.145	1.18	-60.965	-13
5018.4	-58.931	1.23	-57.701	-13
5854.8	-57.866	1.45	-56.416	-13
6691.2	-53.950	1.56	-52.390	-13
7527.6	-54.670	1.59	-53.080	-13
8364	-58.080	1.82	-56.260	-13

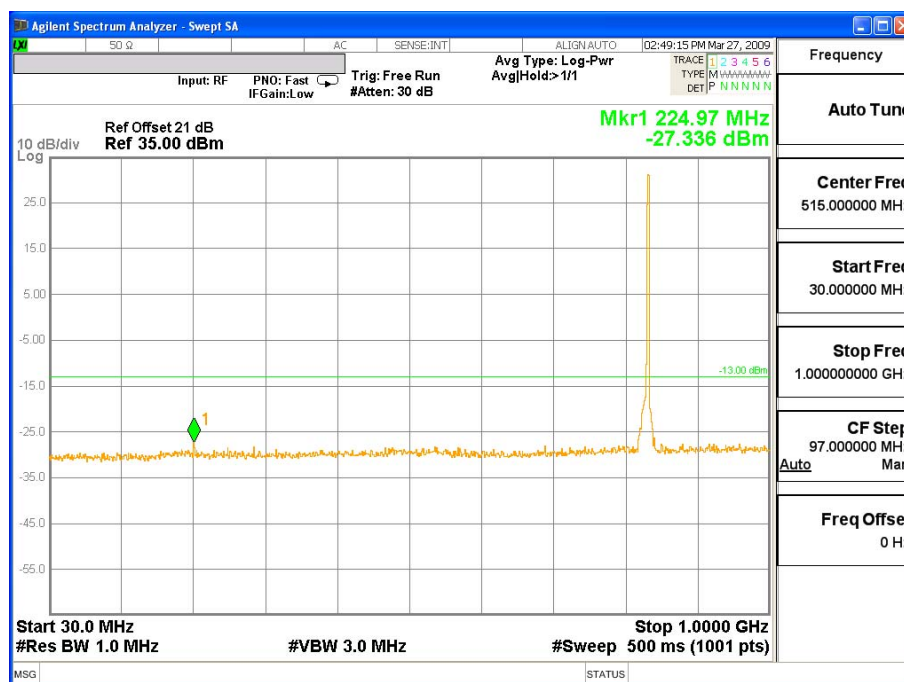

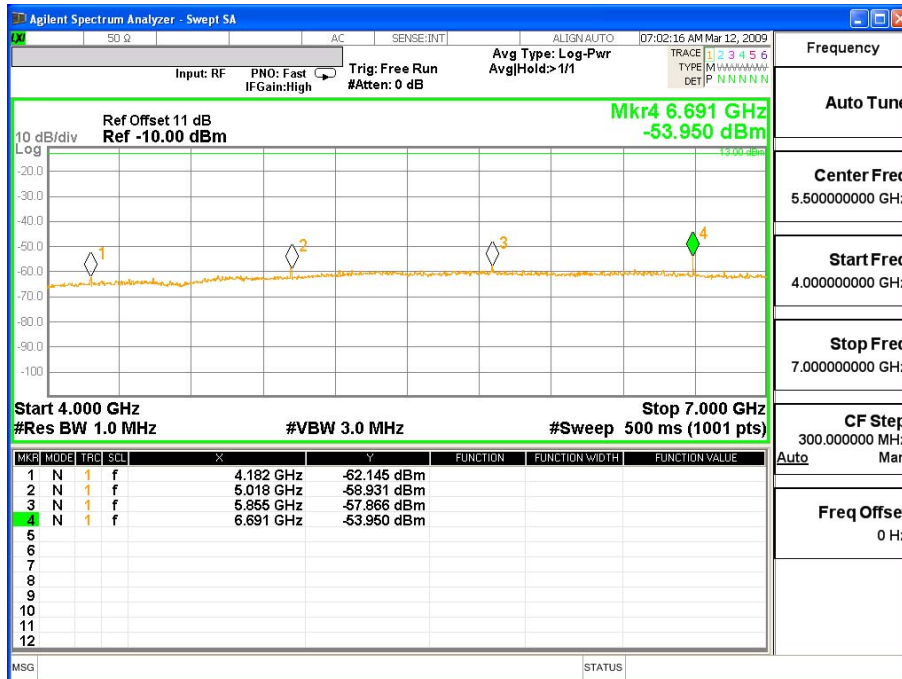
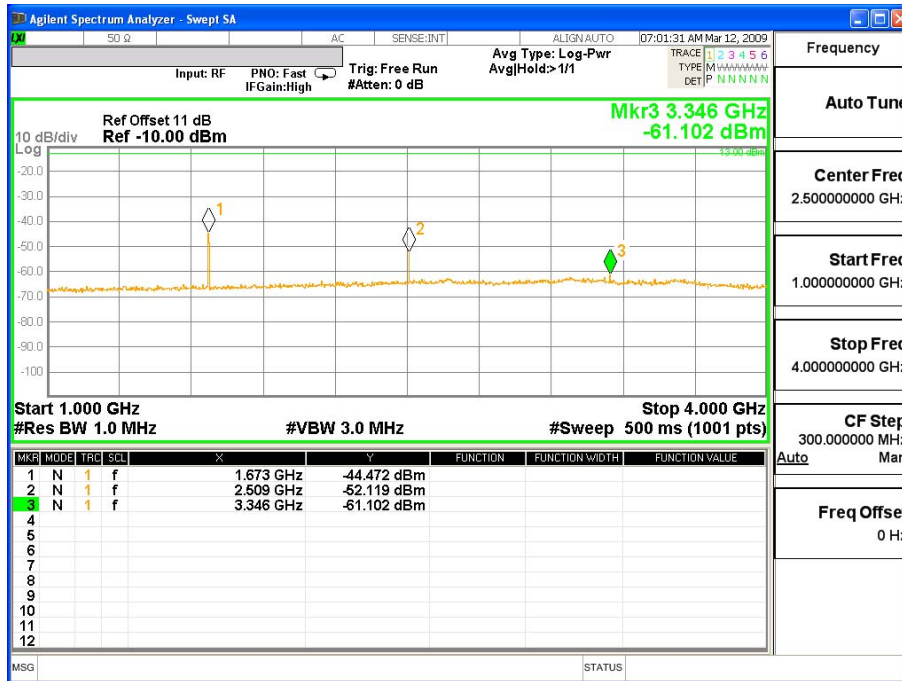

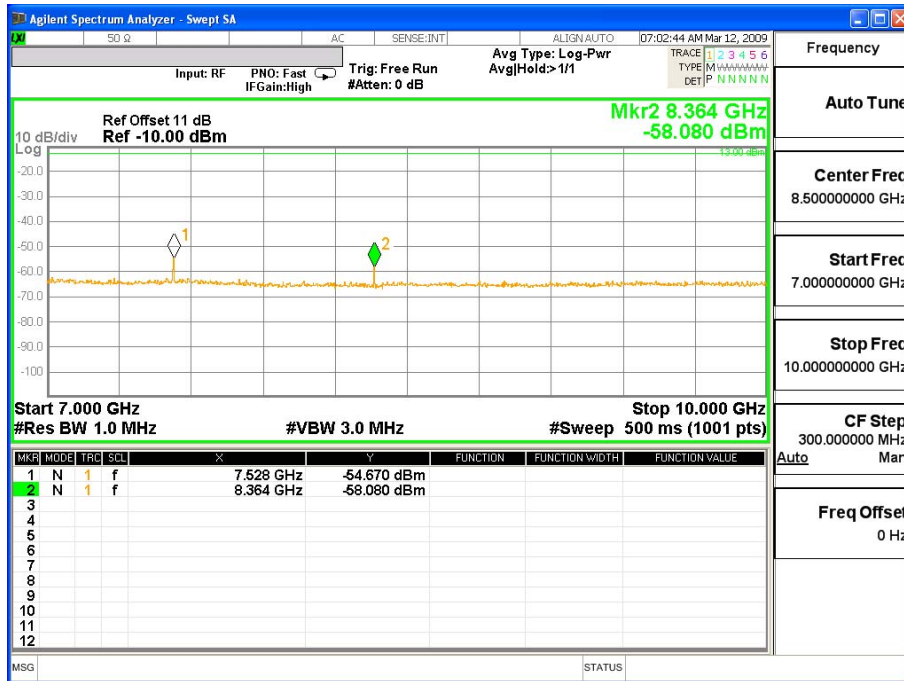

Product	Notebook		
Test Mode	Spurious Emission (Conducted)		
Date of Test	2009/03/28	Test Site	CTR
Test Condition	GSM 850 EGPRS	Test Range	30MHz~10GHz

GSM 850 EGPRS Mid-Channel 189

Frequency (MHz)	Reading Level (dBm)	Path Loss (dB)	Emission Level (dBm)	Limit (dBm)
1672.8	-47.830	0.58	-47.250	-13
2509.2	-51.665	0.7	-50.965	-13
3345.6	-62.501	1.01	-61.491	-13
4182	-65.013	1.18	-63.833	-13
5018.4	-60.184	1.23	-58.954	-13
5854.8	-60.047	1.45	-58.597	-13
6691.2	-57.077	1.56	-55.517	-13
7527.6	-58.146	1.59	-56.556	-13
8364	-60.741	1.82	-58.921	-13

