

FCC 47 CFR PART 15 SUBPART E

CERTIFICATION TEST REPORT

For

Tablet PC

MODEL No.: MS-ND14

FCC ID: I4L-MSND14

Trade Mark: MSI

REPORT NO.: ES160614022E4

ISSUE DATE: July 20, 2016

Prepared for

Micro Star International Co Ltd

No. 69, Lide St., Zhonghe Dist., New Taipei City, Taiwan

Prepared by

EMTEK(SHENZHEN) CO., LTD.

Bldg 69, Majialong Industry Zone, Nanshan District,
Shenzhen, Guangdong, China
TEL: 86-755-26954280
FAX: 86-755-26954282

1 TEST RESULT CERTIFICATION

Applicant:	Micro Star International Co Ltd No. 69, Lide St., Zhonghe Dist., New Taipei City, Taiwan
Manufacturer:	MSI ELECTRONICS(KUNSHAN)CO., LTD. No.88 East Qianjin Road, Kunshan city, Jiangsu province, China
Product Description:	Tablet PC
Model Number:	MS-ND14
File Number:	ES160614022E4
Date of Test:	June 15, 2016 to July 20, 2016

Measurement Procedure Used:

APPLICABLE STANDARDS	
STANDARD	TEST RESULT
FCC 47 CFR Part 2, Subpart J FCC 47 CFR Part 15, Subpart E	PASS

The above equipment was tested by EMTEK(SHENZHEN) CO., LTD.. The test data, data evaluation, test procedures, and equipment configurations shown in this report were made in accordance with the procedures given in ANSI C63.10 (2013) and the energy emitted by the sample EUT tested as described in this report is in compliance with the requirements of FCC Rules Part 2 and Part 15.407

The test results of this report relate only to the tested sample identified in this report.

Date of Test : June 15, 2016 to July 20, 2016

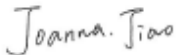
Prepared by : 
Joanna Jiao /Editor

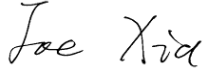
Reviewer : 
Joe Xia/Supervisor

Approve & Authorized Signer : 
Lisa Wang/Manager

TABLE OF CONTENTS

1 TEST RESULT CERTIFICATION.....2

2 EUT TECHNICAL DESCRIPTION4

3 SUMMARY OF TEST RESULT5

4 TEST METHODOLOGY6

4.1 GENERAL DESCRIPTION OF APPLIED STANDARDS6

4.2 MEASUREMENT EQUIPMENT USED6

4.3 DESCRIPTION OF TEST MODES.....7

5 FACILITIES AND ACCREDITATIONS11

5.1 FACILITIES11

5.2 LABORATORY ACCREDITATIONS AND LISTINGS11

6 TEST SYSTEM UNCERTAINTY12

7 SETUP OF EQUIPMENT UNDER TEST13

7.1 RADIO FREQUENCY TEST SETUP.....13

7.2 RADIO FREQUENCY TEST SETUP.....13

7.3 CONDUCTED EMISSION TEST SETUP15

7.4 BLOCK DIAGRAM CONFIGURATION OF TEST SYSTEM16

7.5 SUPPORT EQUIPMENT.....16

8 TEST REQUIREMENTS.....17

8.1 BANDWIDTH MEASUREMENT17

8.2 MAXIMUM CONDUCTED OUTPUT POWER.....44

8.3 MAXIMUM PEAK POWER DENSITY49

8.4 FREQUENCY STABILITY77

8.5 UNDESIRABLE RADIATED SPURIOUS EMISSION.....87

8.6 POWER LINE CONDUCTED EMISSIONS121

8.7 ANTENNA APPLICATION124

2 EUT TECHNICAL DESCRIPTION

Characteristics	Description																									
Device Type	Wifi 5G Device																									
IEEE 802.11 WLAN Mode Supported	<input checked="" type="checkbox"/> 802.11a(20MHz channel bandwidth) <input checked="" type="checkbox"/> 802.11n(20MHz channel bandwidth) <input checked="" type="checkbox"/> 802.11n(40MHz channel bandwidth)																									
Data Rate	<input checked="" type="checkbox"/> 802.11a:6, 9, 12, 18, 24, 36, 48, 54Mbps; <input checked="" type="checkbox"/> 802.11n(HT20): MCS0-MCS8; <input checked="" type="checkbox"/> 802.11n(HT40): MCS0-MCS8;																									
SISO Mode	1TX1RX																									
Modulation	<input checked="" type="checkbox"/> OFDM with BPSK/QPSK/16QAM/64QAM for 802.11a/g/n;																									
Operating Frequency Range	<table border="1"> <thead> <tr> <th>Band</th> <th>Mode</th> <th>Frequency Range(MHz)</th> <th>Number of channels</th> </tr> </thead> <tbody> <tr> <td rowspan="2">UNII Band I</td> <td>802.11a/n(HT20)</td> <td>5180-5240</td> <td>4</td> </tr> <tr> <td>802.11n(HT40)</td> <td>5190-5230</td> <td>2</td> </tr> <tr> <td rowspan="2">UNII Band II-A</td> <td>802.11a/n(HT20)</td> <td>5260-5320</td> <td>4</td> </tr> <tr> <td>802.11n(HT40)</td> <td>5270-5310</td> <td>2</td> </tr> <tr> <td rowspan="2">UNII Band II-C</td> <td>802.11a/n(HT20)</td> <td>5500-5700</td> <td>11</td> </tr> <tr> <td>802.11n(HT40)</td> <td>5510-5670</td> <td>5</td> </tr> </tbody> </table>	Band	Mode	Frequency Range(MHz)	Number of channels	UNII Band I	802.11a/n(HT20)	5180-5240	4	802.11n(HT40)	5190-5230	2	UNII Band II-A	802.11a/n(HT20)	5260-5320	4	802.11n(HT40)	5270-5310	2	UNII Band II-C	802.11a/n(HT20)	5500-5700	11	802.11n(HT40)	5510-5670	5
	Band	Mode	Frequency Range(MHz)	Number of channels																						
	UNII Band I	802.11a/n(HT20)	5180-5240	4																						
		802.11n(HT40)	5190-5230	2																						
	UNII Band II-A	802.11a/n(HT20)	5260-5320	4																						
		802.11n(HT40)	5270-5310	2																						
UNII Band II-C	802.11a/n(HT20)	5500-5700	11																							
	802.11n(HT40)	5510-5670	5																							
Transmit Power Max	15.40dBm																									
Antenna Type	PCB Antenna																									
Smart system	<input checked="" type="checkbox"/> SISO for 802.11a/n <input type="checkbox"/> MIMO for 802.11n/ac																									
Antenna Gain	-2.55 dBi																									
Power supply	<input checked="" type="checkbox"/> DC supply: DC 7.6V from Li-on battery																									
	<input checked="" type="checkbox"/> Adapter: Model:ADP-18TB C AC INPUT:100-240V,50-60Hz,0.6A DC OUTPUT:12v,1.5A																									

Note: for more details, please refer to the User's manual of the EUT.

3 SUMMARY OF TEST RESULT

FCC Part Clause	Test Parameter	Verdict	Remark
15.407 (a) 15.407 (e)	99% , 6dB and 26dB Bandwidth	PASS	
15.407 (a)	Maximum Conducted Output Power	PASS	
15.407 (a)	Peak Power Spectral Density	PASS	
15.407 (b)	Radiated Spurious Emission	PASS	
15.407(g)	Frequency Stability	PASS	
15.407 (b)(6) 15.207	Power Line Conducted Emission	PASS	
15.407(a) 15.203	Antenna Application	PASS	
NOTE1: N/A (Not Applicable) NOTE2: According to FCC OET KDB 789003 D2 General UNII Test Procedures New Rules v01r02, In addition, the radiated test is also performed to ensure the emissions emanating from the device cabinet also comply with the applicable limits.			

RELATED SUBMITTAL(S) / GRANT(S):

This submittal(s) (test report) is intended for FCC ID: I4L-MSND14 filing to comply with Section 15.247 of the FCC Part 15, Subpart E Rules.

4 TEST METHODOLOGY

4.1 GENERAL DESCRIPTION OF APPLIED STANDARDS

According to its specifications, the EUT must comply with the requirements of the following standards:

FCC 47 CFR Part 2, Subpart J

FCC 47 CFR Part 15, Subpart E

FCC KDB 789003 D2 General UNII Test Procedures New Rules v01r02

FCC KDB 662911 D01 Multiple Transmitter Output v02r01

FCC KDB 662911 D02 MIMO With Cross Polarized Antenna V01

4.2 MEASUREMENT EQUIPMENT USED

4.2.1 Conducted Emission Test Equipment

EQUIPMENT TYPE	MFR	MODEL NUMBER	SERIAL NUMBER	LAST CAL.
Test Receiver	Rohde & Schwarz	ESCS30	828985/018	05/16/2016
L.I.S.N.	Schwarzbeck	NNLK8129	8129203	05/16/2016
50Ω Coaxial Switch	Anritsu	MP59B	M20531	N/A
Pulse Limiter	Rohde & Schwarz	ESH3-Z2	100006	05/16/2016
Voltage Probe	Rohde & Schwarz	TK9416	N/A	05/16/2016
I.S.N	Rohde & Schwarz	ENY22	1109.9508.02	05/16/2016

4.2.2 Radiated Emission Test Equipment

EQUIPMENT TYPE	MFR	MODEL NUMBER	SERIAL NUMBER	LAST CAL.
EMI Test Receiver	Rohde & Schwarz	ESU	1302.6005.26	05/16/2016
Pre-Amplifier	HP	8447D	2944A07999	05/16/2016
Bilog Antenna	Schwarzbeck	VULB9163	142	05/16/2016
Loop Antenna	ARA	PLA-1030/B	1029	05/16/2016
Horn Antenna	Schwarzbeck	BBHA 9170	BBHA9170399	05/16/2016
Horn Antenna	Schwarzbeck	BBHA 9120	D143	05/16/2016
Cable	Schwarzbeck	AK9513	ACRX1	05/16/2016
Cable	Rosenberger	N/A	FP2RX2	05/16/2016
Cable	Schwarzbeck	AK9513	CRPX1	05/16/2016
Cable	Schwarzbeck	AK9513	CRRX2	05/16/2016

4.2.3 Radio Frequency Test Equipment

EQUIPMENT TYPE	MFR	MODEL NUMBER	SERIAL NUMBER	LAST CAL.
Spectrum Analyzer	Agilent	E4407B	88156318	05/16/2016
Signal Analyzer	Agilent	N9010A	My53470879	05/16/2016
Power meter	Anritsu	ML2495A	0824006	05/16/2016
Power sensor	Anritsu	MA2411B	0738172	05/16/2016

Remark: Each piece of equipment is scheduled for calibration once a year.

4.3 DESCRIPTION OF TEST MODES

The EUT has been tested under its typical operating condition.

The EUT configuration for testing is installed on RF field strength measurement to meet the Commissions requirement and operating in a manner which intends to maximize its emission characteristics in a continuous normal application.

The Transmitter was operated in the normal operating mode. The TX frequency was fixed which was for the purpose of the measurements.

Test of channel included the lowest and middle and highest frequency to perform the test, then record on this report.

Those data rates (802.11a: 6 Mbps; 802.11n (HT20): MCS0; 802.11n (HT40): MCS0;) were used for all test.

Pre-defined engineering program for regulatory testing used to control the EUT for staying in continuous transmitting and receiving mode is programmed.

Wifi 5G with UNII Band I

Frequency and Channel list for 802.11a/n(HT20):

Channel	Frequency (MHz)	Channel	Frequency (MHz)	Channel	Frequency (MHz)
36	5180	44	5220		
40	5200	48	5240		

Frequency and Channel list for 802.11n(HT40):

Channel	Frequency (MHz)	Channel	Frequency (MHz)	Channel	Frequency (MHz)
38	5190				
46	5230				

Test Frequency and Channel for 802.11a/n(HT20):

Lowest Frequency		Middle Frequency		Highest Frequency	
Channel	Frequency (MHz)	Channel	Frequency (MHz)	Channel	Frequency (MHz)
36	5180	40	5200	48	5240

Test Frequency and channel for 802.11n(VHT40):

Lowest Frequency		Middle Frequency		Highest Frequency	
Channel	Frequency (MHz)	Channel	Frequency (MHz)	Channel	Frequency (MHz)
38	5190	N/A	N/A	46	5230

Wifi 5G with UNII Band II-A

Frequency and Channel list for 802.11a/n(HT20):

Channel	Frequency (MHz)	Channel	Frequency (MHz)	Channel	Frequency (MHz)
52	5260	60	5300		
56	5280	64	5320		

Frequency and Channel list for 802.11n(VHT40):

Channel	Frequency (MHz)	Channel	Frequency (MHz)	Channel	Frequency (MHz)
54	5270				
62	5310				

Test Frequency and Channel for 802.11a/n(HT20):

Lowest Frequency		Middle Frequency		Highest Frequency	
Channel	Frequency (MHz)	Channel	Frequency (MHz)	Channel	Frequency (MHz)
52	5260	56	5280	64	5320

Test Frequency and channel for 802.11n(HT40):

Lowest Frequency		Middle Frequency		Highest Frequency	
Channel	Frequency (MHz)	Channel	Frequency (MHz)	Channel	Frequency (MHz)
54	5270	N/A	N/A	62	5310

Wifi 5G with UNII Band II-C

Frequency and Channel list for 802.11a/n(HT20):

Channel	Frequency (MHz)	Channel	Frequency (MHz)	Channel	Frequency (MHz)
100	5500	116	5580	132	5660
104	5520	120	5600	136	5680
108	5540	124	5620	140	5700
112	5560	128	5640		

Frequency and Channel list for 802.11n(VHT40):

Channel	Frequency (MHz)	Channel	Frequency (MHz)	Channel	Frequency (MHz)
102	5510	126	5630		
110	5550	134	5670		
118	5590				

Test Frequency and Channel for 802.11a/n(HT20):

Lowest Frequency		Middle Frequency		Highest Frequency	
Channel	Frequency (MHz)	Channel	Frequency (MHz)	Channel	Frequency (MHz)
100	5500	120	5600	140	5700

Test Frequency and channel for 802.11n(VHT40):

Lowest Frequency		Middle Frequency		Highest Frequency	
Channel	Frequency (MHz)	Channel	Frequency (MHz)	Channel	Frequency (MHz)
102	5510	118	5590	134	5670

5 FACILITIES AND ACCREDITATIONS

5.1 FACILITIES

All measurement facilities used to collect the measurement data are located at

Bldg 69, Majialong Industry Zone District, Nanshan District, Shenzhen, China

The sites are constructed in conformance with the requirements of ANSI C63.7, ANSI C63.10 and CISPR Publication 22.

5.2 LABORATORY ACCREDITATIONS AND LISTINGS

Site Description

EMC Lab.

: Accredited by CNAS, 2013.10.29

The certificate is valid until 2016.10.28

The Laboratory has been assessed and proved to be in compliance with CNAS-CL01:2006 (identical to ISO/IEC 17025:2005)

The Certificate Registration Number is L2291.

Accredited by TUV Rheinland Shenzhen 2015.4

The Laboratory has been assessed according to the requirements ISO/IEC 17025.

Accredited by FCC, April 17, 2013

The Certificate Registration Number is 709623.

Accredited by FCC, July 24, 2013

The Certificate Registration Number is 406365.

Accredited by Industry Canada, November 29, 2012

The Certificate Registration Number is 4480A.

Name of Firm

: EMTEK(SHENZHEN) CO., LTD..

Site Location

: Bldg 69, Majialong Industry Zone,
Nanshan District, Shenzhen, Guangdong, China

6 TEST SYSTEM UNCERTAINTY

The following measurement uncertainty levels have been estimated for tests performed on the apparatus:

Parameter	Uncertainty
Radio Frequency	$\pm 1 \times 10^{-5}$
Maximum Peak Output Power Test	$\pm 1.0\text{dB}$
Conducted Emissions Test	$\pm 2.0\text{dB}$
Radiated Emission Test	$\pm 2.0\text{dB}$
Power Density	$\pm 2.0\text{dB}$
Occupied Bandwidth Test	$\pm 1.0\text{dB}$
Band Edge Test	$\pm 3\text{dB}$
All emission, radiated	$\pm 3\text{dB}$
Antenna Port Emission	$\pm 3\text{dB}$
Temperature	$\pm 0.5^\circ\text{C}$
Humidity	$\pm 3\%$

Measurement Uncertainty for a level of Confidence of 95%

7 SETUP OF EQUIPMENT UNDER TEST

7.1 RADIO FREQUENCY TEST SETUP

The WLAN component's antenna ports(s) of the EUT are connected to the measurement instrument per an appropriate attenuator. The EUT is controlled by PC/software to emit the specified signals for the purpose of measurements.

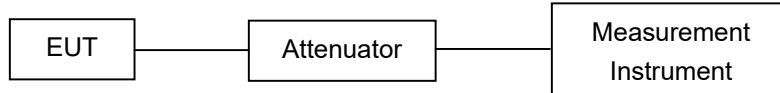

7.2 RADIO FREQUENCY TEST SETUP

The test site semi-anechoic chamber has met the requirement of NSA tolerance 4 dB according to the standards: ANSI C63.10. The test distance is 3m. The setup is according to the requirements in Section 13.1.4.1 of ANSI C63.10-2013 and CAN/CSA-CEI/IEC CISPR 22.

Below 30MHz:

The EUT is placed on a turntable 0.8 meters above the ground in the chamber, 3 meter away from the antenna (loop antenna). The Antenna should be positioned with its plane vertical at the specified distance from the EUT and rotated about its vertical axis for maximum response at each azimuth about the EUT. The center of the loop shall be 1 m above the ground. For certain applications, the loop antenna plane may also need to be positioned horizontally at the specified distance from the EUT.

Above 30MHz:

The EUT is placed on a turntable 0.8 meters above the ground in the chamber, 3 meter away from the antenna. The maximal emission value is acquired by adjusting the antenna height, polarisation and turntable azimuth. Normally, the height range of antenna is 1 m to 4 m, the azimuth range of turntable is 0° to 360°, and the receive antenna has two polarizations Vertical (V) and Horizontal (H).

Above 1GHz:

(Note: the FCC's permission to use 1.5m as an alternative per TCBC Conf call of Dec. 2, 2014.)

The EUT is placed on a turntable 1.5 meters above the ground in the chamber, 3 meter away from the antenna. The maximal emission value is acquired by adjusting the antenna height, polarisation and turntable azimuth. Normally, the height range of antenna is 1 m to 4 m, the azimuth range of turntable is 0° to 360°, and the receive antenna has two polarizations Vertical (V) and Horizontal (H).

(a) Radiated Emission Test Set-Up, Frequency Below 30MHz

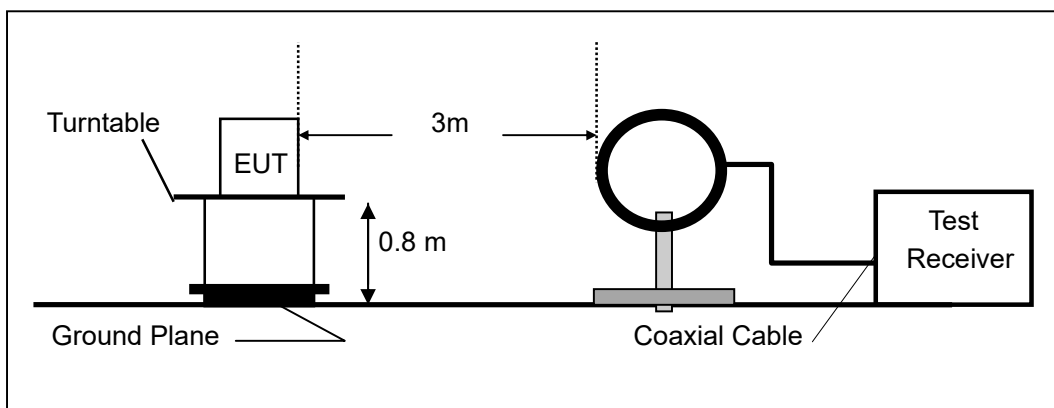

(b) Radiated Emission Test Set-Up, Frequency Below 1000MHz

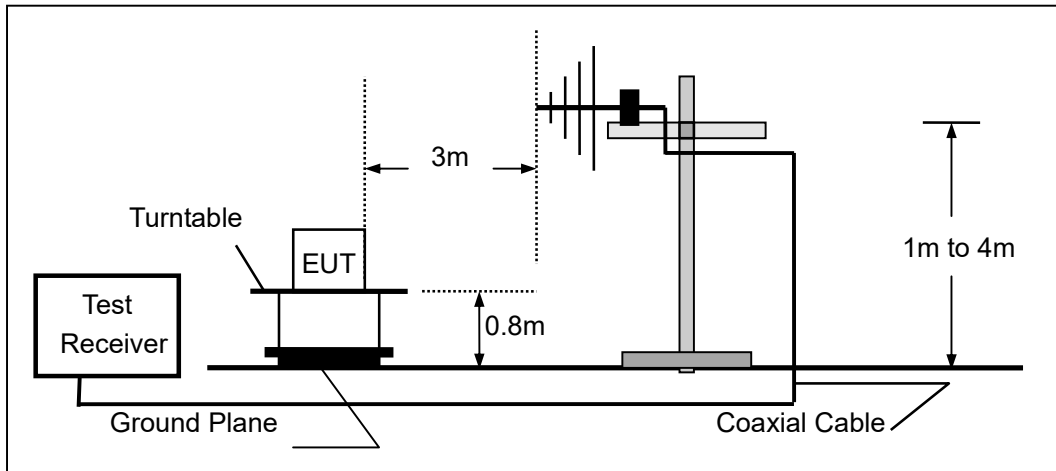

(c) Radiated Emission Test Set-Up, Frequency above 1000MHz

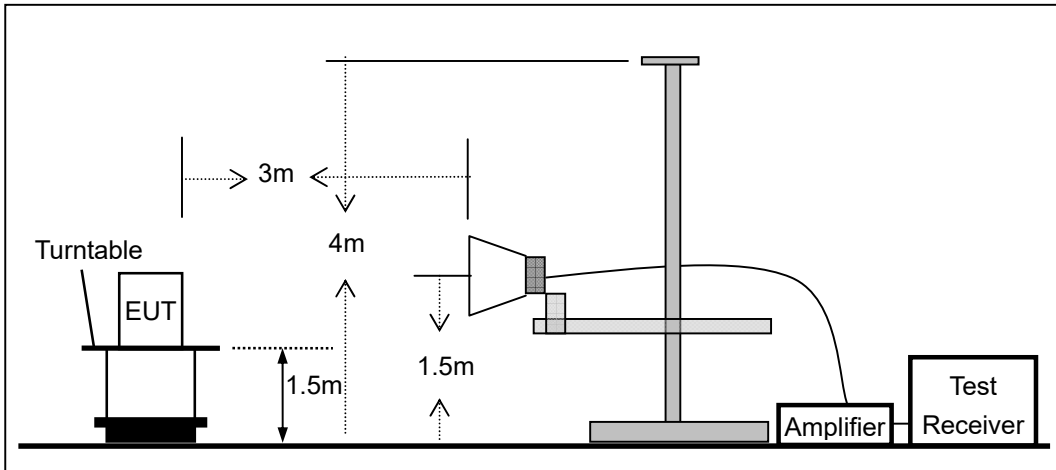

7.3 CONDUCTED EMISSION TEST SETUP

The mains cable of the EUT (maybe per AC/DC Adapter) must be connected to LISN. The LISN shall be placed 0.8 m from the boundary of EUT and bonded to a ground reference plane for LISN mounted on top of the ground reference plane. This distance is between the closest points of the LISN and the EUT. All other units of the EUT and associated equipment shall be at least 0.8m from the LISN.

Ground connections, where required for safety purposes, shall be connected to the reference ground point of the LISN and, where not otherwise provided or specified by the manufacturer, shall be of same length as the mains cable and run parallel to the mains connection at a separation distance of not more than 0.1 m.

According to the requirements in Section 13.1.4.1 of ANSI C63.10-2013 Conducted emissions from the EUT measured in the frequency range between 0.15 MHz and 30 MHz using CISPR Quasi-Peak and average detector mode.

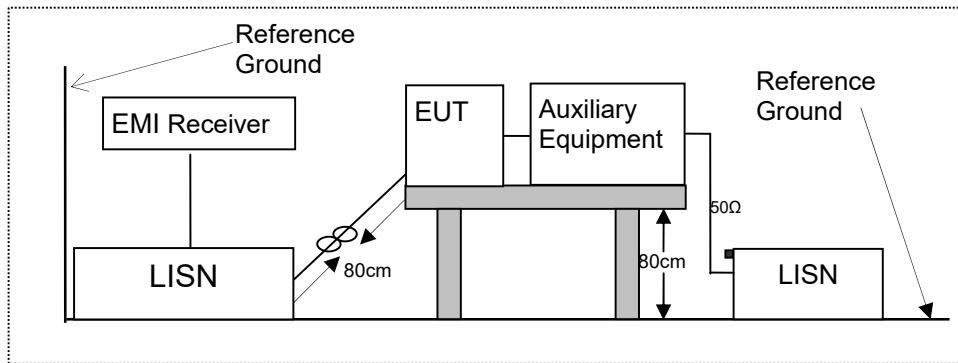

7.4 BLOCK DIAGRAM CONFIGURATION OF TEST SYSTEM

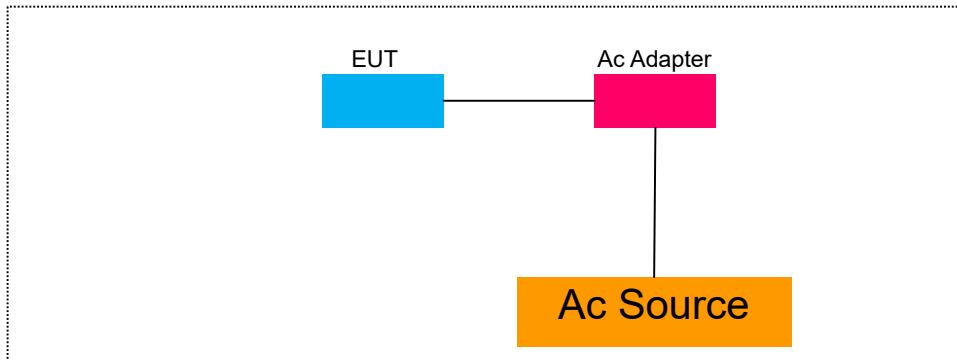

7.5 SUPPORT EQUIPMENT

Item	Equipment	Mfr/Brand	Model/Type No.	FCC ID	Series No.	Note
1.	N/A	N/A	N/A	N/A	N/A	

Notes:

1. All the equipment/cables were placed in the worst-case configuration to maximize the emission during the test.
2. Grounding was established in accordance with the manufacturer's requirements and conditions for the intended use.

8 TEST REQUIREMENTS

8.1 BANDWIDTH MEASUREMENT

8.1.1 Applicable Standard

According to FCC Part 15.407(a)(1) for UNII Band I
According to FCC Part 15.407(a)(2) for UNII Band II-A and UNII Band II-C
According to FCC Part 15.407(a)(3) for UNII Band III
According to FCC Part 15.407(e) for UNII Band III
According to 789033 D02 Section II(C)
According to 789033 D02 Section II(D)

8.1.2 Conformance Limit

No limit requirement.
The minimum 6 dB emission bandwidth of at least 500 KHz for the UNII Band III.

8.1.3 Test Configuration

Test according to clause 6.1 radio frequency test setup

8.1.4 Test Procedure

Connect the antenna port(s) to the spectrum analyzer input. Using the spectrum analyzer Channel Bandwidth mode, configure the spectrum analyzer as shown below

■ The following procedure shall be used for measuring (26 dB) power bandwidth:

Center Frequency: test Frequency

Set RBW = approximately 1% of the emission bandwidth.

Set the VBW > RBW.

Detector = Peak.

Trace mode = max hold.

X dB Bandwidth: 26 dB

Measure the maximum width of the emission that is 26 dB down from the maximum of the emission.

Compare this with the RBW setting of the analyzer. Readjust RBW and repeat measurement as needed until the RBW/EBW ratio is approximately 1%.

■ Minimum Emission Bandwidth for the UNII Band III

Center Frequency: test Frequency

Set RBW = 100 kHz

Set VBW $\geq 3 \cdot$ RBW

Detector = Peak

Trace mode = max hold

Sweep = auto couple

X dB Bandwidth: 6 dB

Note: The automatic bandwidth measurement capability of a spectrum analyzer or EMI receiver may be employed if it implements the functionality described above.

■ The following procedure shall be used for measuring (99 %) power bandwidth:

Set center frequency to the nominal EUT channel center frequency.

Set span = 1.5 times to 5.0 times the OBW.

Set RBW = 1 % to 5 % of the OBW

Set VBW $\geq 3 \cdot$ RBW

Video averaging is not permitted. Where practical, a sample detection and single sweep mode shall be used. Otherwise, peak detection and max hold mode (until the trace stabilizes) shall be used.

Use the 99 % power bandwidth function of the instrument (if available).

If the instrument does not have a 99 % power bandwidth function, the trace data points are recovered and directly summed in power units. The recovered amplitude data points, beginning at the lowest frequency, are placed in a running sum until 0.5 % of the total is reached; that frequency is recorded as the lower frequency. The process is repeated until 99.5 % of the total is reached; that frequency is recorded as the upper frequency. The 99% occupied bandwidth is the difference between these two frequencies.

8.1.5 Test Results

<input checked="" type="checkbox"/> 802.11a mode						
Temperature :		28 °C	Test Date :		July 18, 2016	
Humidity :		65 %	Test By:		King Kong	
Band	Channel Number	Channel Freq. (MHz)	26dB EBW	99% OBW	Limit (MHz)	Verdict
UNII Band I	CH36	5180	21.52	16.670	N/A	N/A
	CH40	5200	19.04	16.559	N/A	N/A
	CH48	5240	19.11	16.595	N/A	N/A
UNII Band II-A	CH52	5260	19.14	16.539	N/A	N/A
	CH56	5280	19.17	16.573	N/A	N/A
	CH64	5320	18.92	16.534	N/A	N/A
UNII Band II-C	CH100	5500	19.12	16.590	N/A	N/A
	CH120	5600	19.03	16.563	N/A	N/A
	CH140	5700	18.83	16.583	N/A	N/A
Note: N/A (Not Applicable)						

<input checked="" type="checkbox"/> 802.11n(VHT20) mode						
Temperature :		28 °C	Test Date :		July 18, 2016	
Humidity :		65 %	Test By:		King Kong	
Band	Channel Number	Channel Freq. (MHz)	26dB EBW	99% OBW	Limit (MHz)	Verdict
UNII Band I	CH36	5180	20.89	17.556	N/A	N/A
	CH40	5200	19.54	17.559	N/A	N/A
	CH48	5240	19.40	17.551	N/A	N/A
UNII Band II-A	CH52	5260	19.30	17.549	N/A	N/A
	CH56	5280	19.34	17.536	N/A	N/A
	CH64	5320	19.31	17.537	N/A	N/A
UNII Band II-C	CH100	5500	19.25	17.528	N/A	N/A
	CH120	5600	19.36	17.538	N/A	N/A
	CH140	5700	19.33	17.576	N/A	N/A
Note: N/A (Not Applicable)						

<input checked="" type="checkbox"/> 802.11n(VHT40) mode						
Temperature :		28 °C	Test Date :		July 18, 2016	
Humidity :		65 %	Test By:		King Kong	
Band	Channel Number	Channel Freq. (MHz)	26dB EBW	99% OBW	Limit (MHz)	Verdict
UNII Band I	CH38	5190	40.54	36.367	N/A	N/A
	CH46	5230	40.50	36.308	N/A	N/A
UNII Band II-A	CH54	5270	40.44	36.290	N/A	N/A
	CH62	5310	40.15	36.186	N/A	N/A
UNII Band II-C	CH102	5510	39.88	36.180	N/A	N/A
	CH118	5590	40.41	36.239	N/A	N/A
	CH134	5670	49.16	36.375	N/A	N/A
Note: N/A (Not Applicable)						

Emission Bandwidth&99% Occupied Bandwidth		UNII Band I	
Test Model	802.11a	Frequency(MHz)	5180
Ant0			

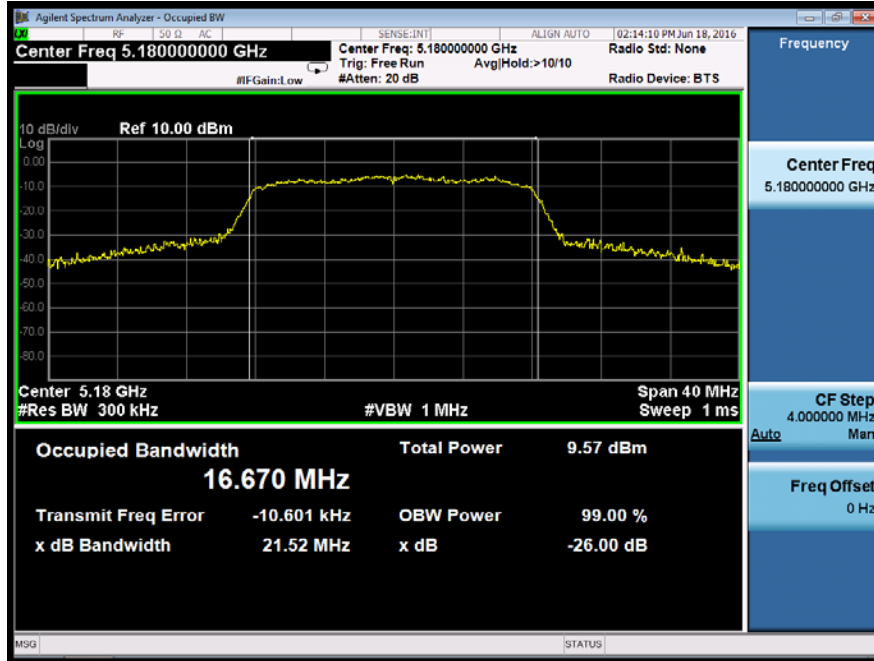

Emission Bandwidth&99% Occupied Bandwidth		UNII Band I	
Test Model	802.11a	Frequency(MHz)	5200
Ant0			

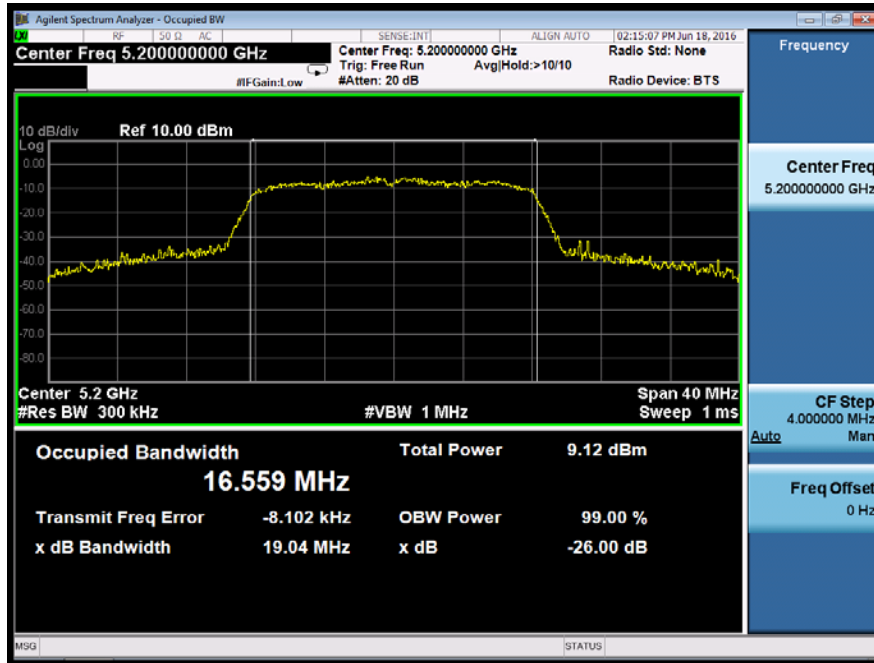

Emission Bandwidth&99% Occupied Bandwidth		UNII Band I	
Test Model	802.11a	Frequency(MHz)	5240
Ant0			



Emission Bandwidth&99% Occupied Bandwidth		UNII Band II-A	
Test Model	802.11a	Frequency(MHz)	5260
Ant0			

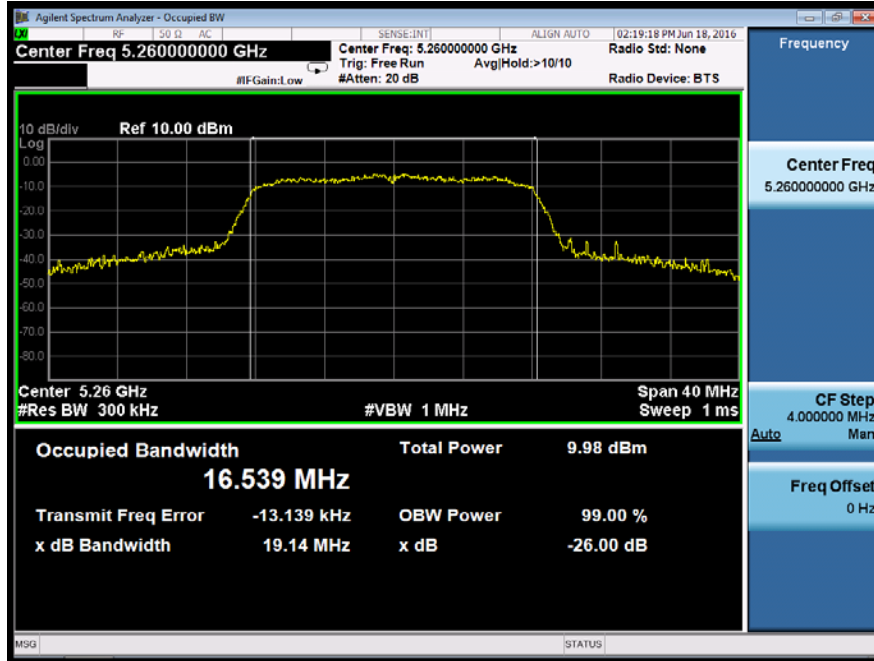

Emission Bandwidth&99% Occupied Bandwidth		UNII Band II-A	
Test Model	802.11a	Frequency(MHz)	5280
Ant0			

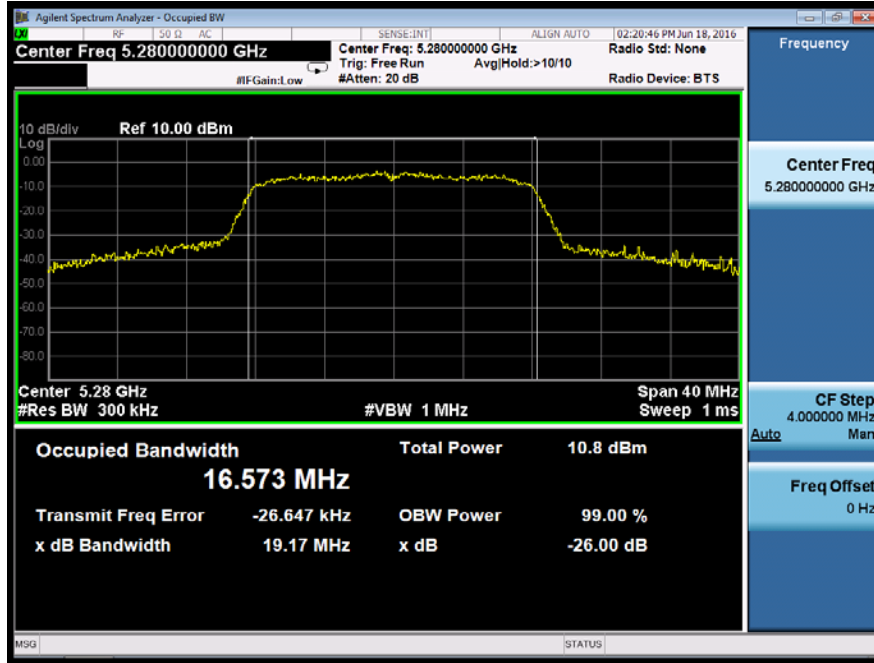

Emission Bandwidth&99% Occupied Bandwidth	UNII Band II-A
Test Model 802.11a	Frequency(MHz) 5320
Ant0	

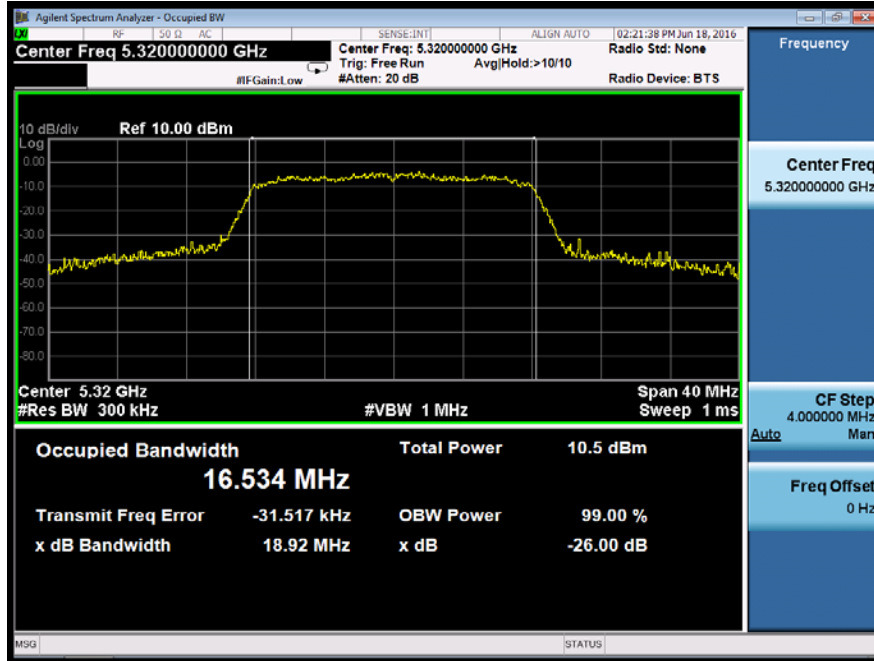

Emission Bandwidth&99% Occupied Bandwidth		UNII Band II-C	
Test Model	802.11a	Frequency(MHz)	5500
Ant0			

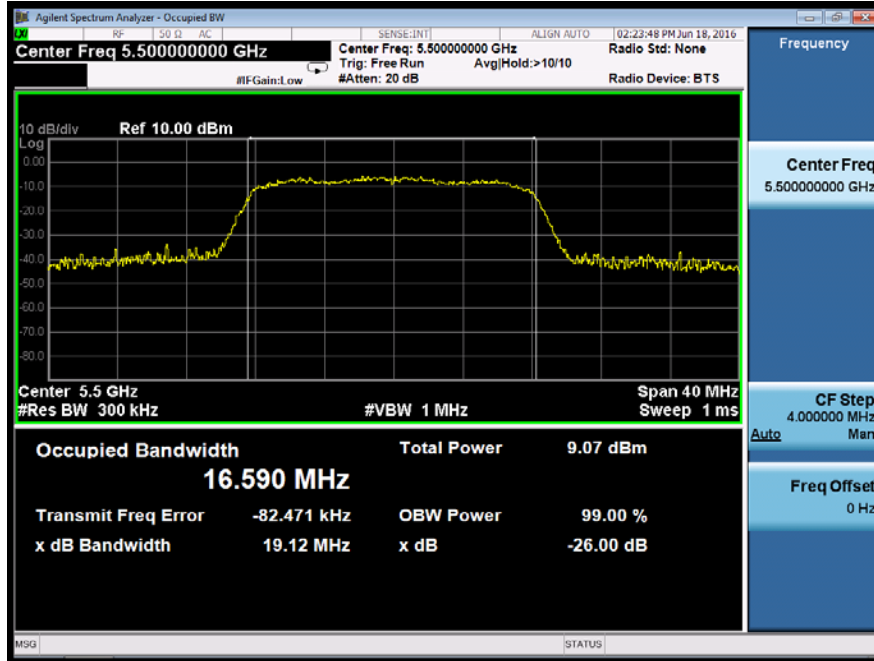

Emission Bandwidth&99% Occupied Bandwidth		UNII Band II-C	
Test Model	802.11a	Frequency(MHz)	5600
Ant0			

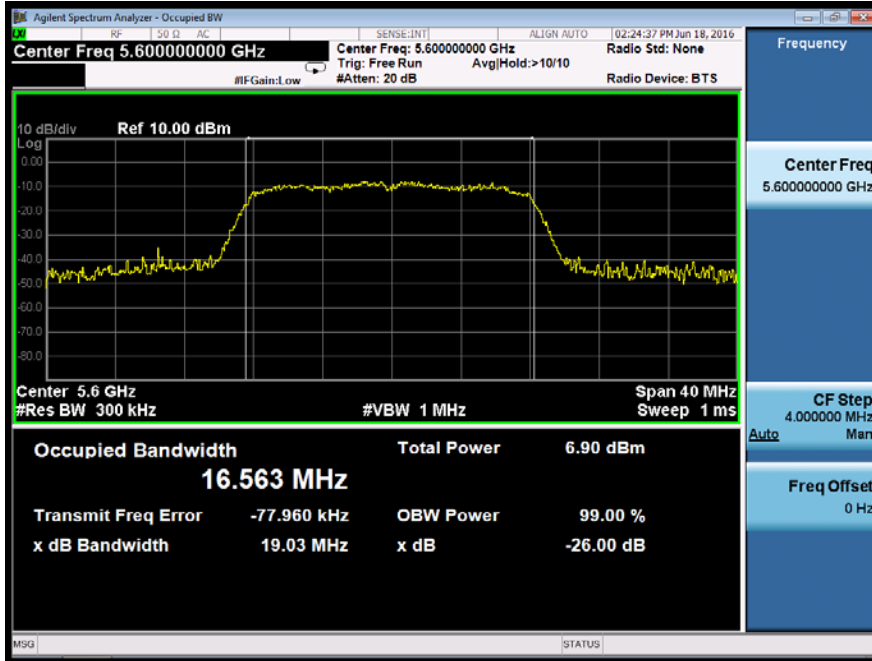

Emission Bandwidth&99% Occupied Bandwidth		UNII Band II-C	
Test Model	802.11a	Frequency(MHz)	5700
Ant0			

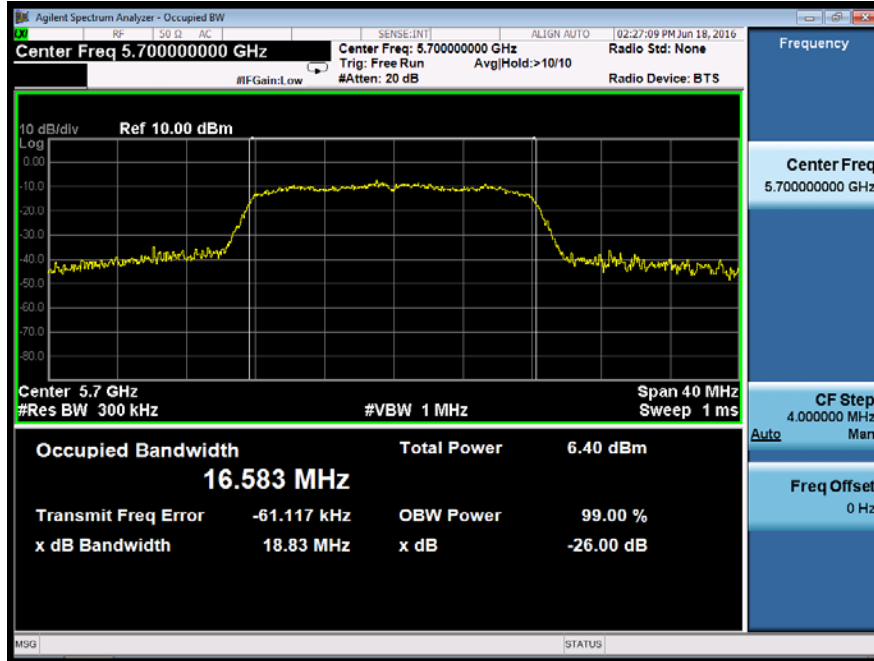

Emission Bandwidth&99% Occupied Bandwidth	UNII Band I	
Test Model	802.11n(VHT20) mode	Frequency(MHz)
Ant0		5180

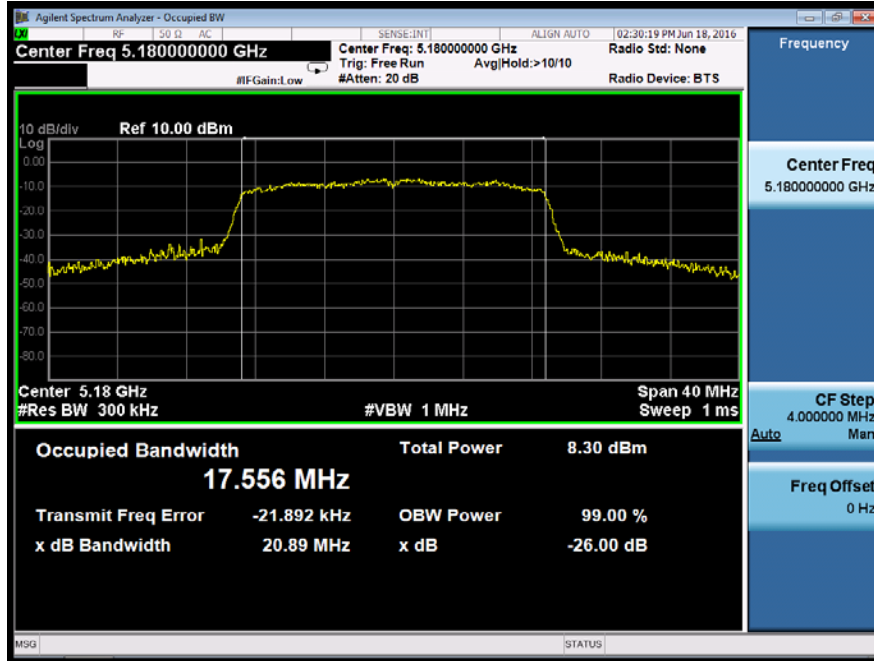

Emission Bandwidth&99% Occupied Bandwidth	UNII Band I	
Test Model	802.11n(VHT20) mode	Frequency(MHz)
Ant0		5200

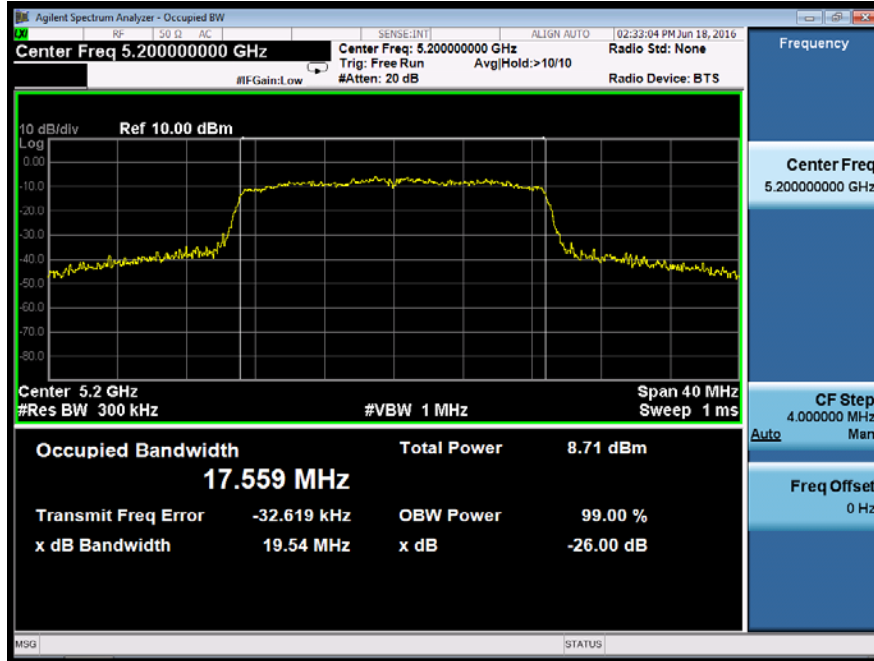

Emission Bandwidth&99% Occupied Bandwidth	UNII Band I	
Test Model	802.11n(VHT20) mode	Frequency(MHz)
Ant0		5240

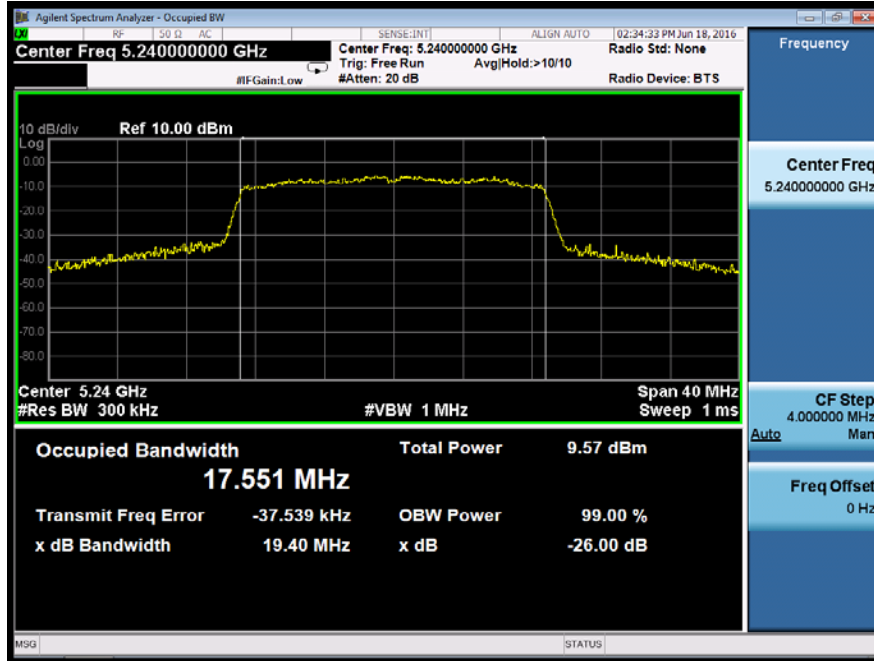

Emission Bandwidth&99% Occupied Bandwidth	UNII Band II-A	
Test Model	802.11n(VHT20) mode	Frequency(MHz)
Ant0		5260



Emission Bandwidth&99% Occupied Bandwidth	UNII Band II-A	
Test Model	802.11n(VHT20) mode	Frequency(MHz)
Ant0		5280

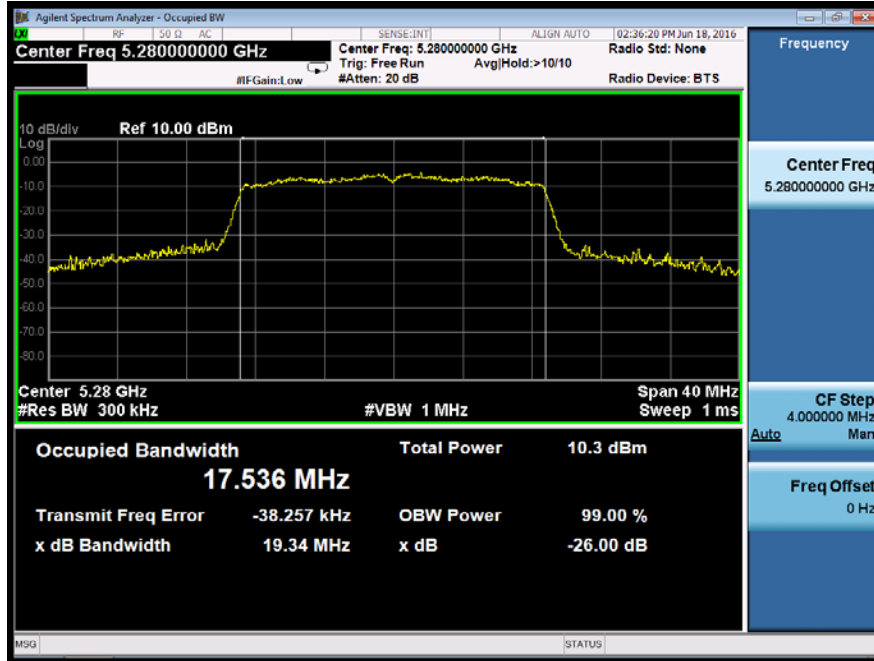

Emission Bandwidth&99% Occupied Bandwidth	UNII Band II-A	
Test Model	802.11n(VHT20) mode	Frequency(MHz)
Ant0		5320

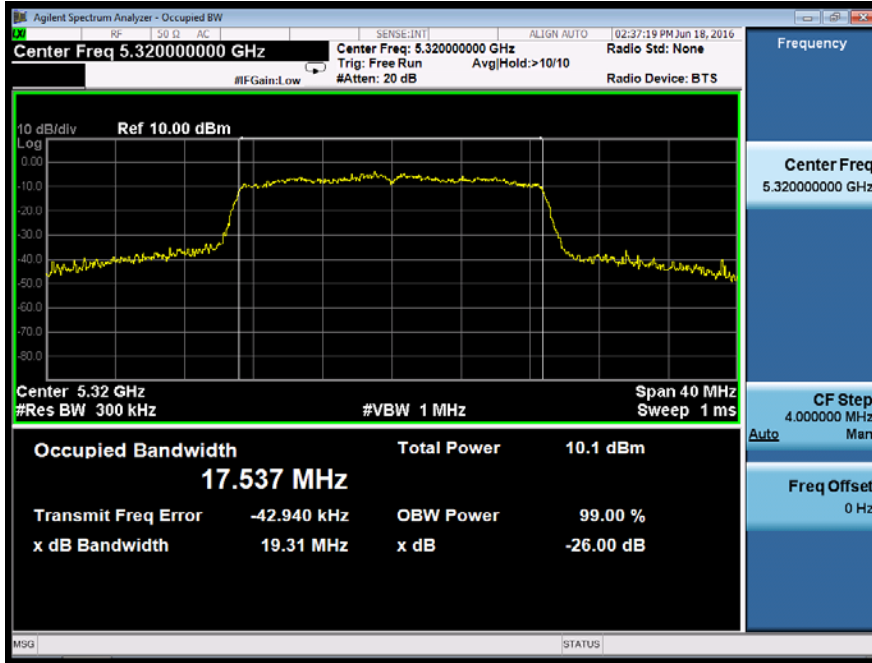

Emission Bandwidth&99% Occupied Bandwidth	UNII Band II-C	
Test Model	802.11n(VHT20) mode	Frequency(MHz)
Ant0		5500

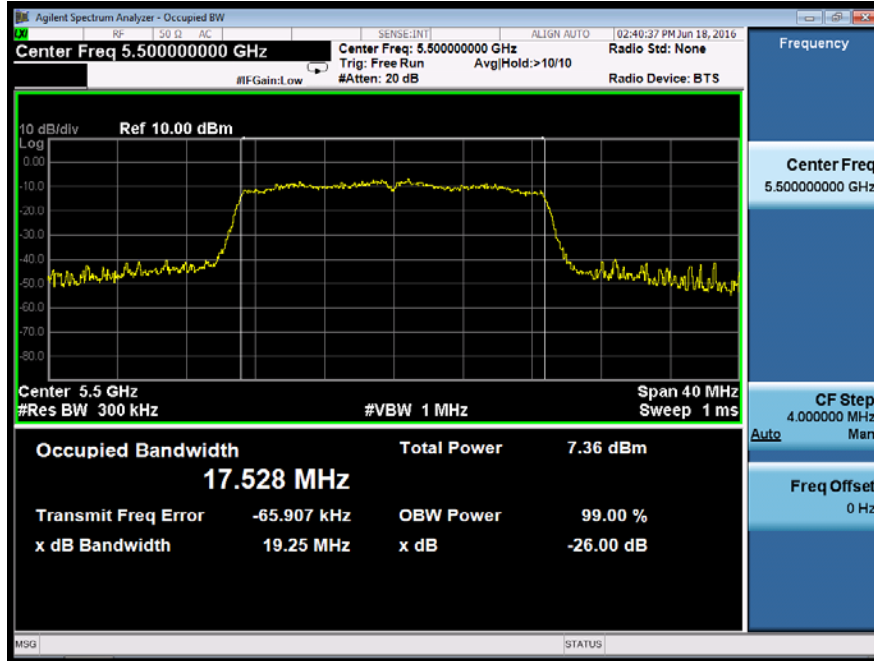

Emission Bandwidth&99% Occupied Bandwidth	UNII Band II-C	
Test Model	802.11n(VHT20) mode	Frequency(MHz)
Ant0		5600

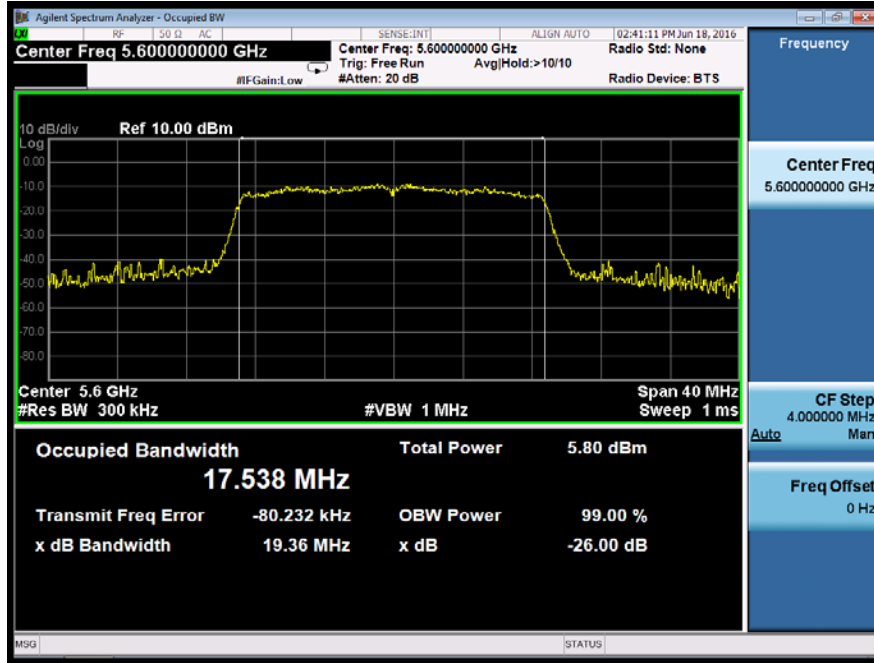

Emission Bandwidth&99% Occupied Bandwidth	UNII Band II-C	
Test Model	802.11n(VHT20) mode	Frequency(MHz)
Ant0		5700

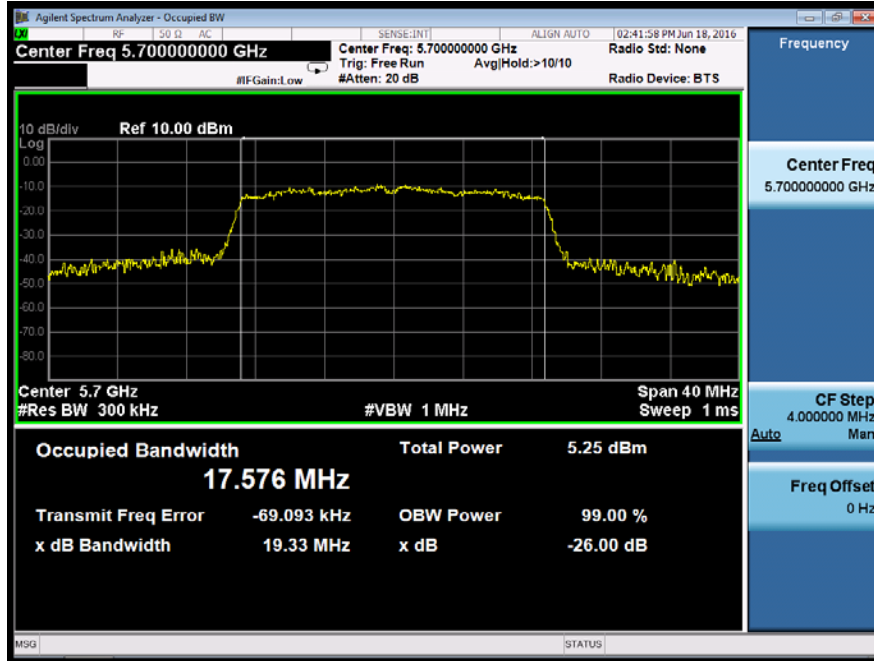

Emission Bandwidth&99% Occupied Bandwidth	UNII Band I	
Test Model	802.11n(VHT40) mode	Frequency(MHz)
Ant0		5190

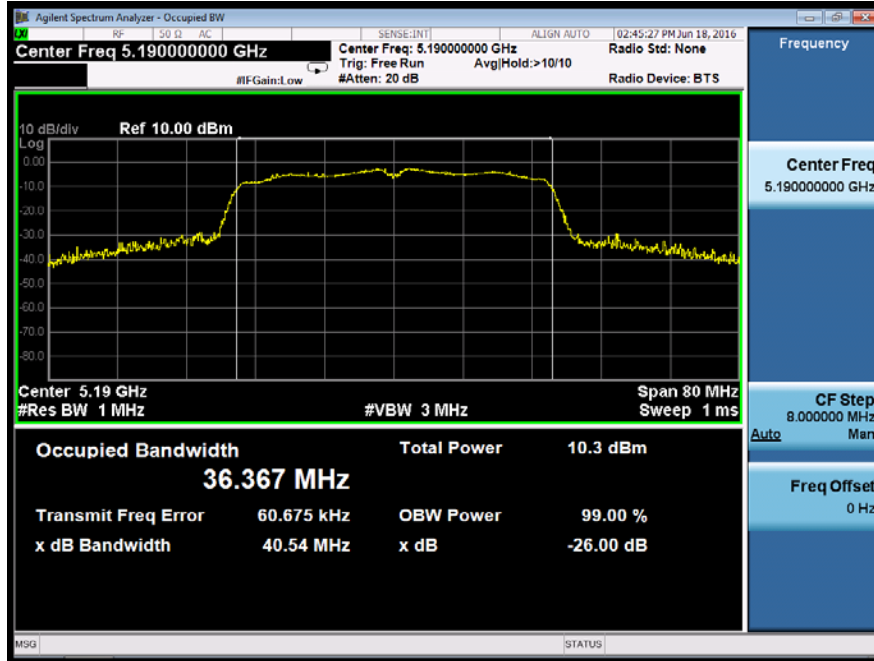

Emission Bandwidth&99% Occupied Bandwidth	UNII Band I
Test Model 802.11n(VHT40) mode	Frequency(MHz) 5230
Ant0	

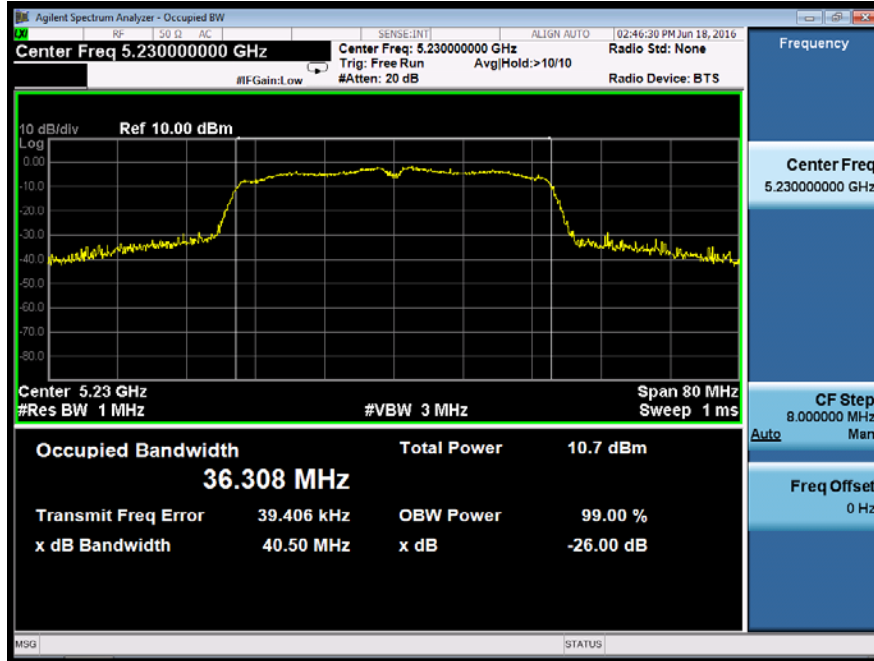

Emission Bandwidth&99% Occupied Bandwidth	UNII Band II-A	
Test Model	802.11n(VHT40) mode	Frequency(MHz)
Ant0		5270

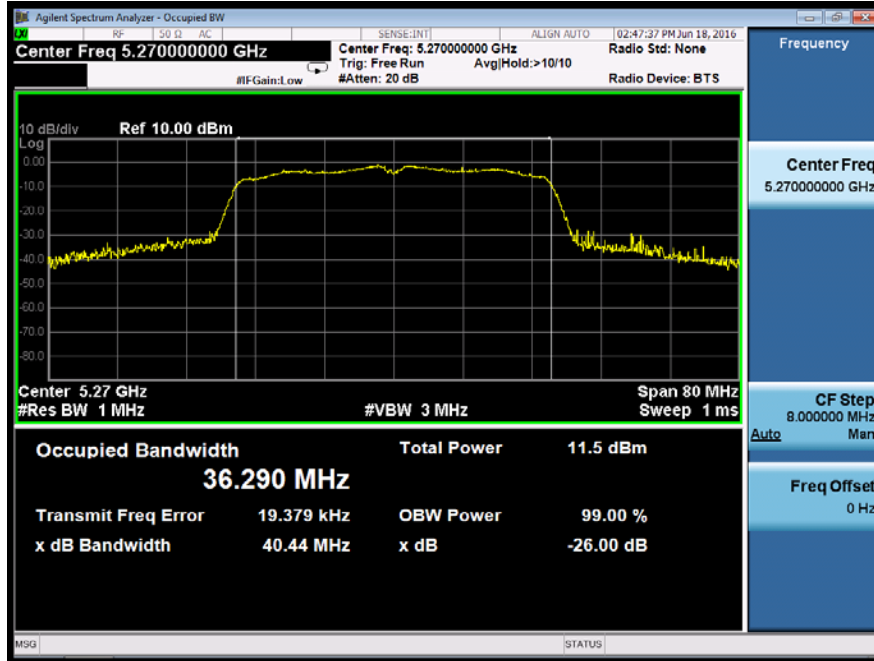

Emission Bandwidth&99% Occupied Bandwidth	UNII Band II-A	
Test Model	802.11n(VHT40) mode	Frequency(MHz)
Ant0		5310

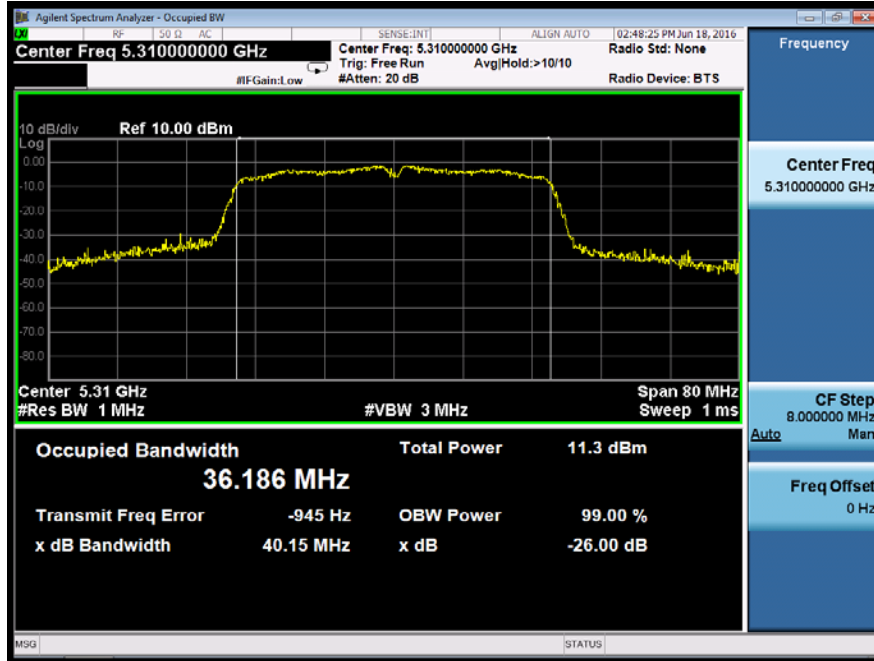

Emission Bandwidth&99% Occupied Bandwidth	UNII Band II-C	
Test Model	802.11n(VHT40) mode	Frequency(MHz)
Ant0		5510

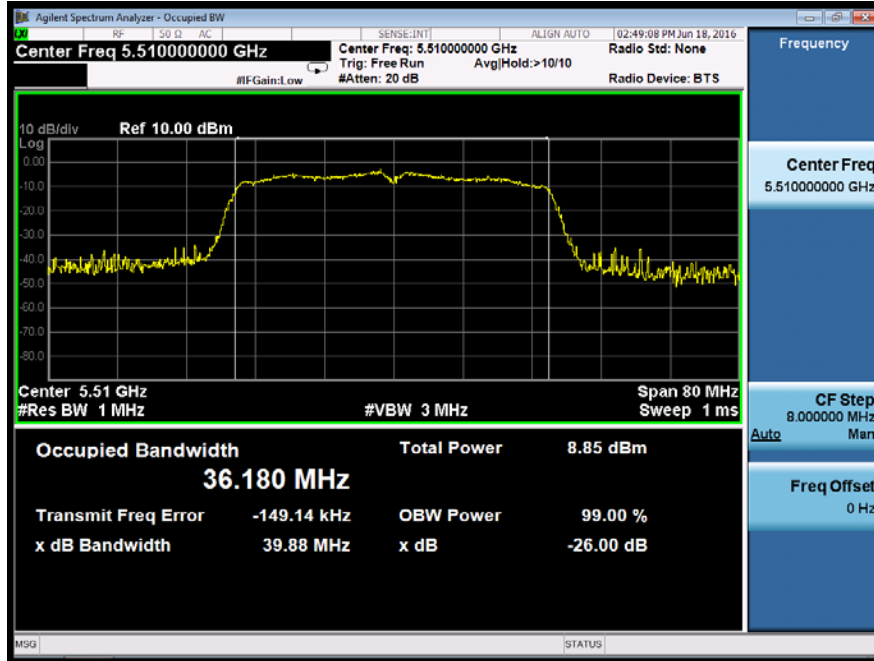

Emission Bandwidth&99% Occupied Bandwidth		UNII Band II-C	
Test Model	802.11n(VHT40) mode	Frequency(MHz)	5590
Ant0			

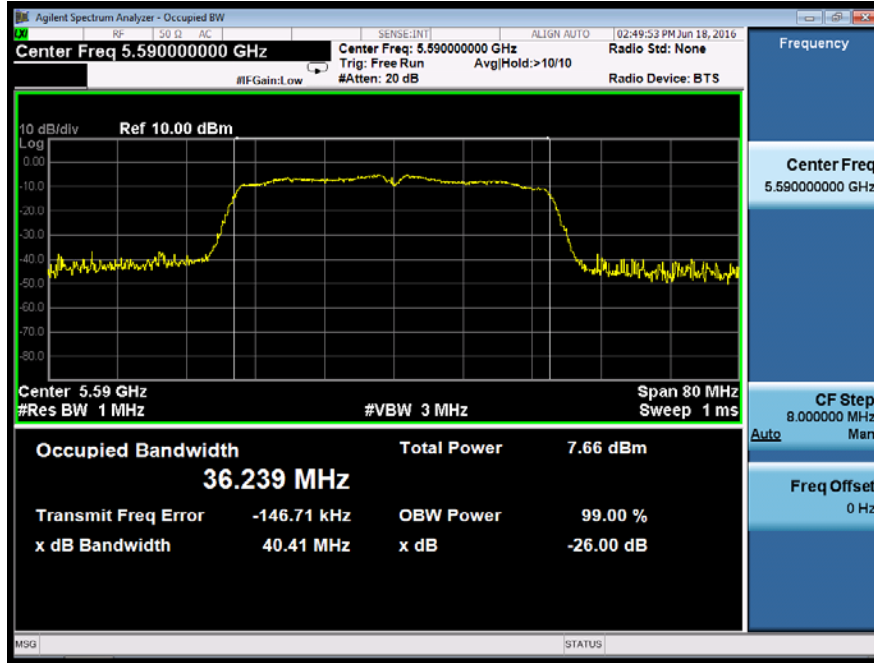

Emission Bandwidth&99% Occupied Bandwidth		UNII Band II-C	
Test Model	802.11n(VHT40) mode	Frequency(MHz)	5670
Ant0			

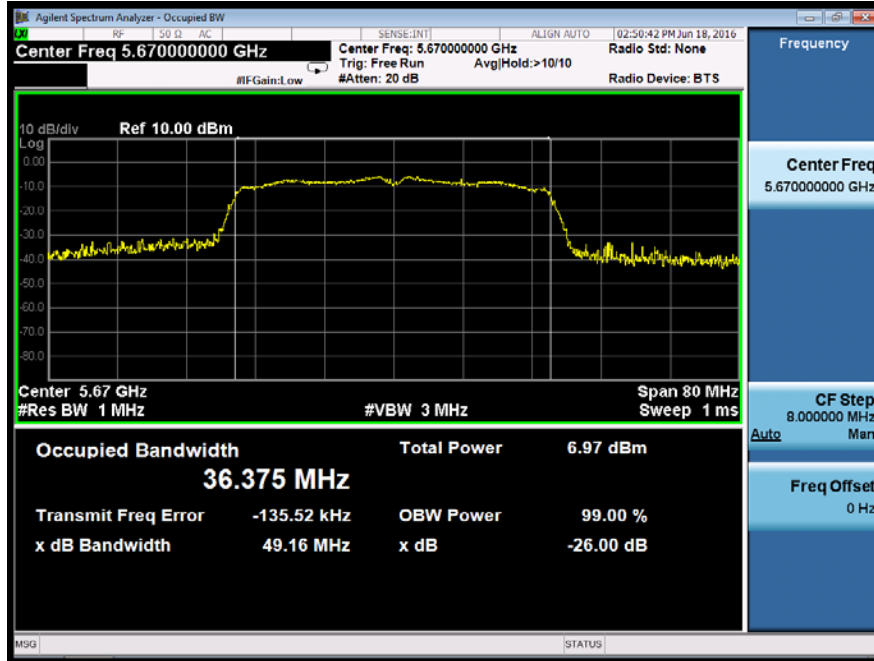

8.2 MAXIMUM CONDUCTED OUTPUT POWER

8.2.1 Applicable Standard

According to FCC Part 15.407(a)(1) for UNII Band I

According to FCC Part 15.407(a)(2) for UNII Band II-A and UNII Band II-C

According to FCC Part 15.407(a)(3) for UNII Band III

According to 789033 D02 Section II(E)

8.2.2 Conformance Limit

■ For the band 5.15-5.25 GHz,

(a) (1) (i) For an outdoor access point operating in the band 5.15-5.25 GHz, the maximum conducted output power over the frequency band of operation shall not exceed 1 W provided the maximum antenna gain does not exceed 6 dBi. If transmitting antennas of directional gain greater than 6 dBi are used, both the maximum conducted output power and the maximum power spectral density shall be reduced by the amount in dB that the directional gain of the antenna exceeds 6 dBi. The maximum e.i.r.p. at any elevation angle above 30 degrees as measured from the horizon must not exceed 125 mW (21 dBm).

(a) (1) (ii) For an indoor access point operating in the band 5.15-5.25 GHz, the maximum conducted output power over the frequency band of operation shall not exceed 1 W provided the maximum antenna gain does not exceed 6 dBi. If transmitting antennas of directional gain greater than 6 dBi are used, both the maximum conducted output power and the maximum power spectral density shall be reduced by the amount in dB that the directional gain of the antenna exceeds 6 dBi.

(a) (1) (iii) For fixed point-to-point access points operating in the band 5.15-5.25 GHz, the maximum conducted output power over the frequency band of operation shall not exceed 1 W. Fixed point-to-point U-NII devices may employ antennas with directional gain up to 23 dBi without any corresponding reduction in the maximum conducted output power or maximum power spectral density. For fixed point-to-point transmitters that employ a directional antenna gain greater than 23 dBi, a 1 dB reduction in maximum conducted output power and maximum power spectral density is required for each 1 dB of antenna gain in excess of 23 dBi. Fixed, point-to-point operations exclude the use of point-to-multipoint systems, omnidirectional applications, and multiple collocated transmitters transmitting the same information. The operator of the U-NII device, or if the equipment is professionally installed, the installer, is responsible for ensuring that systems employing high gain directional antennas are used exclusively for fixed, point-to-point operations.

(a) (1) (iv) For mobile and portable client devices in the 5.15-5.25 GHz band, the maximum conducted output power over the frequency band of operation shall not exceed 250 mW provided the maximum antenna gain does not exceed 6 dBi. If transmitting antennas of directional gain greater than 6 dBi are used, both the maximum conducted output power and the maximum power spectral density shall be reduced by the amount in dB that the directional gain of the antenna exceeds 6 dBi.

■ For the 5.25-5.35 GHz and 5.47-5.725 GHz bands

(a) (2) the maximum conducted output power over the frequency bands of operation shall not exceed the lesser of 250 mW or $11 \text{ dBm} + 10 \log B$, where B is the 26 dB emission bandwidth in megahertz. In addition, the maximum power spectral density shall not exceed 11 dBm in any 1 megahertz band. If transmitting antennas of directional gain greater than 6 dBi are used, both the maximum conducted output power and the maximum power spectral density shall be reduced by the amount in dB that the directional gain of the antenna exceeds 6 dBi.

■ For the band 5.725-5.85 GHz

(a) (3) For the band 5.725-5.85 GHz, the maximum conducted output power over the frequency band of operation shall not exceed 1 W. In addition, the maximum power spectral density shall not exceed 30 dBm in any 500-kHz band. If transmitting antennas of directional gain greater than 6 dBi are used, both the maximum conducted output power and the maximum power spectral density shall be reduced by the amount in dB that the directional gain of the antenna exceeds 6 dBi.

8.2.3 Test Configuration

Test according to clause 6.1 radio frequency test setup

8.2.4 Test Procedure

The maximum average conducted output power can be measured using Method PM-G (Measurement using

a gated RF average power meter):

Measurements may be performed using a wideband gated RF power meter provided that the gate parameters are adjusted such that the power is measured only when the EUT is transmitting at its maximum power control level. Since the measurement is made only during the ON time of the transmitter, no duty cycle correction factor is required.

- a. The Transmitter output (antenna port) was connected to the power meter.
- b. Turn on the EUT and power meter and then record the power value.
- c. Repeat above procedures on all channels needed to be tested.

8.2.5 Test Results

<input checked="" type="checkbox"/> 802.11a mode					
Temperature :	28°C	Test Date :	April 20, 2016		
Humidity :	65 %	Test By:	King Kong		
Band	Channel Number	Channel Freq. (MHz)	Conducted Output Power(dBm)	Limit (dBm)	Verdict
UNII Band I	CH36	5180	14.58	24	Pass
	CH40	5200	14.20	24	Pass
	CH48	5240	14.57	24	Pass
UNII Band II-A	CH52	5260	14.85	24	Pass
	CH56	5280	15.40	24	Pass
	CH64	5320	15.30	24	Pass
UNII Band II-C	CH100	5500	13.25	24	Pass
	CH120	5600	13.40	24	Pass
	CH140	5700	13.48	24	Pass
Note: N/A (Not Applicable)					

<input checked="" type="checkbox"/> 802.11n(VHT20) mode					
Temperature :	28°C	Test Date :	April 20, 2016		
Humidity :	65 %	Test By:	King Kong		
Band	Channel Number	Channel Freq. (MHz)	Conducted Output Power(dBm)	Limit (dBm)	Verdict
UNII Band I	CH36	5180	13.32	24	Pass
	CH40	5200	13.45	24	Pass
	CH48	5240	13.47	24	Pass
UNII Band II-A	CH52	5260	14.38	24	Pass
	CH56	5280	14.57	24	Pass
	CH64	5320	14.65	24	Pass
UNII Band II-C	CH100	5500	12.54	24	Pass
	CH120	5600	12.42	24	Pass
	CH140	5700	12.75	24	Pass
Note: N/A (Not Applicable)					

Duty Cycle

802.11a

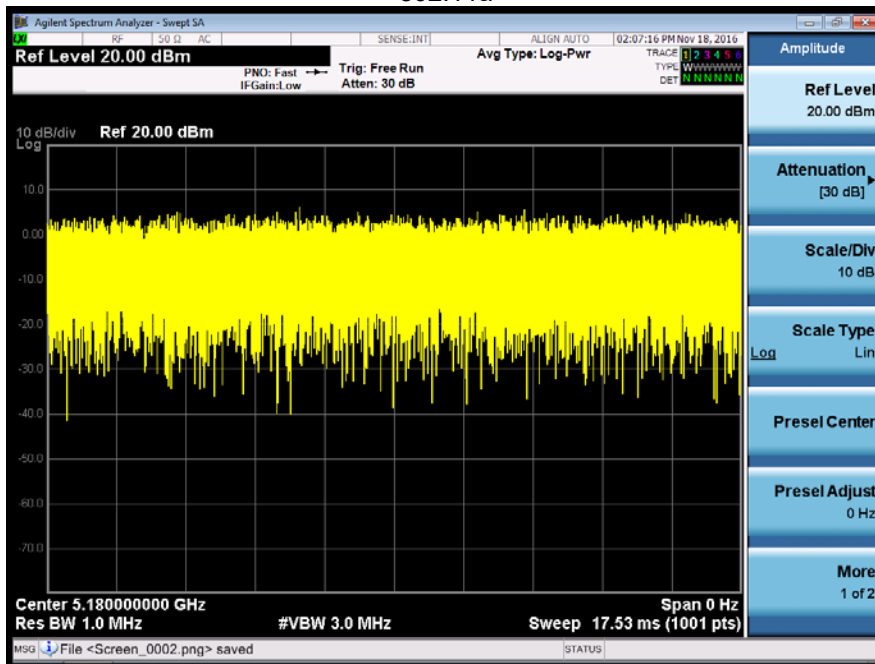

802.11n(HT20)

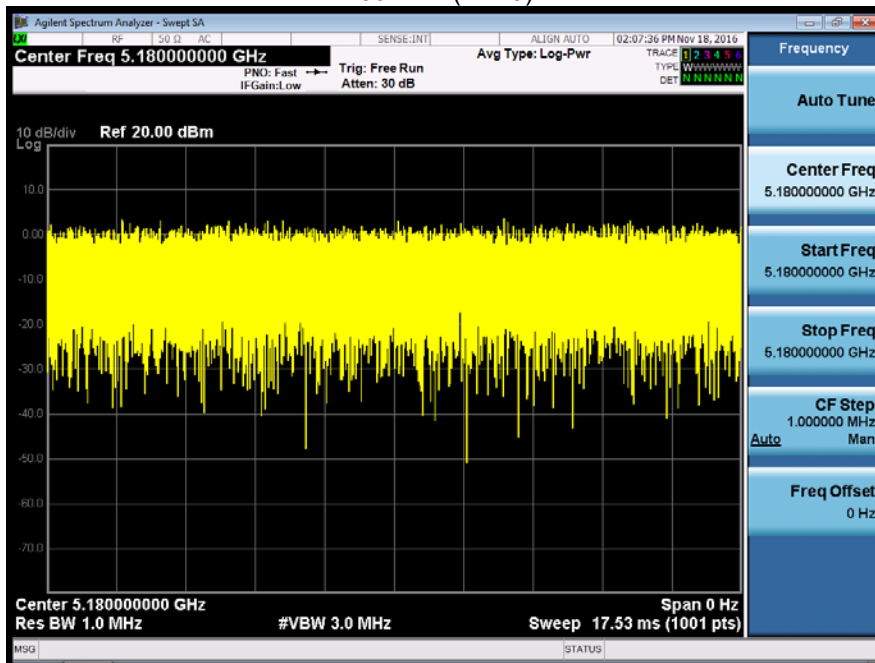

802.11n(HT40)

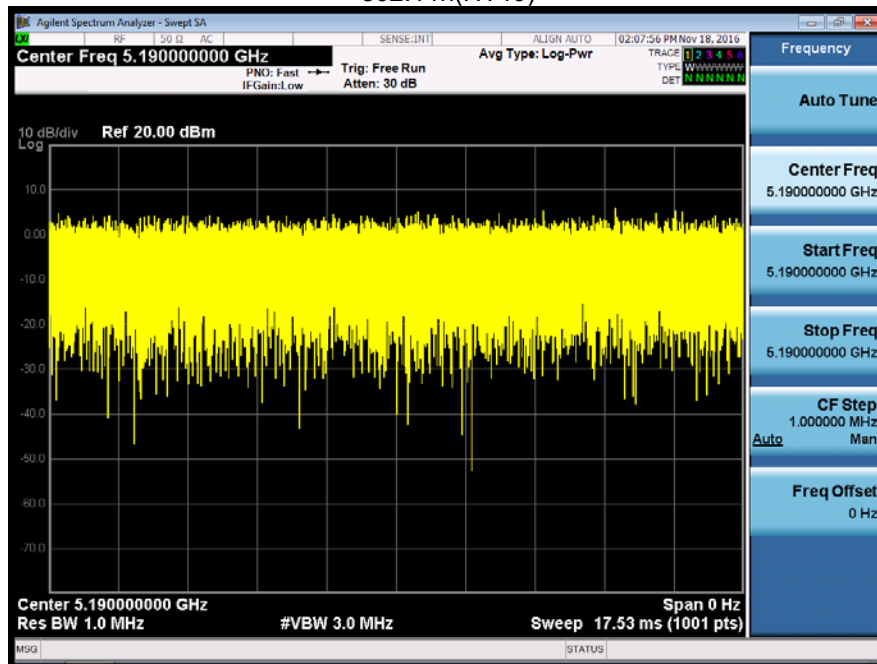

8.3 MAXIMUM PEAK POWER DENSITY

8.3.1 Applicable Standard

According to FCC Part 15.407(a)(1) for UNII Band I

According to FCC Part 15.407(a)(2) for UNII Band II-A and UNII Band II-C

According to FCC Part 15.407(a)(3) for UNII Band III

According to 789033 D02 Section II(F)

8.3.2 Conformance Limit

■ For the band 5.15-5.25 GHz,

(a) (1) (i) For an outdoor access point operating in the band 5.15-5.25 GHz, the maximum conducted output power over the frequency band of operation shall not exceed 1 W provided the maximum antenna gain does not exceed 6 dBi. If transmitting antennas of directional gain greater than 6 dBi are used, both the maximum conducted output power and the maximum power spectral density shall be reduced by the amount in dB that the directional gain of the antenna exceeds 6 dBi. The maximum e.i.r.p. at any elevation angle above 30 degrees as measured from the horizon must not exceed 125 mW (21 dBm).

(a) (1) (ii) For an indoor access point operating in the band 5.15-5.25 GHz, the maximum conducted output power over the frequency band of operation shall not exceed 1 W provided the maximum antenna gain does not exceed 6 dBi. If transmitting antennas of directional gain greater than 6 dBi are used, both the maximum conducted output power and the maximum power spectral density shall be reduced by the amount in dB that the directional gain of the antenna exceeds 6 dBi.

(a) (1) (iii) For fixed point-to-point access points operating in the band 5.15-5.25 GHz, the maximum conducted output power over the frequency band of operation shall not exceed 1 W. Fixed point-to-point U-NII devices may employ antennas with directional gain up to 23 dBi without any corresponding reduction in the maximum conducted output power or maximum power spectral density. For fixed point-to-point transmitters that employ a directional antenna gain greater than 23 dBi, a 1 dB reduction in maximum conducted output power and maximum power spectral density is required for each 1 dB of antenna gain in excess of 23 dBi. Fixed, point-to-point operations exclude the use of point-to-multipoint systems, omnidirectional applications, and multiple collocated transmitters transmitting the same information. The operator of the U-NII device, or if the equipment is professionally installed, the installer, is responsible for ensuring that systems employing high gain directional antennas are used exclusively for fixed, point-to-point operations.

(a) (1) (iv) For mobile and portable client devices in the 5.15-5.25 GHz band, the maximum conducted output power over the frequency band of operation shall not exceed 250 mW provided the maximum antenna gain does not exceed 6 dBi. If transmitting antennas of directional gain greater than 6 dBi are used, both the maximum conducted output power and the maximum power spectral density shall be reduced by the amount in dB that the directional gain of the antenna exceeds 6 dBi.

■ For the 5.25-5.35 GHz and 5.47-5.725 GHz bands

(b) (2) the maximum conducted output power over the frequency bands of operation shall not exceed the lesser of 250 mW or $11 \text{ dBm} + 10 \log B$, where B is the 26 dB emission bandwidth in megahertz. In addition, the maximum power spectral density shall not exceed 11 dBm in any 1 megahertz band. If transmitting antennas of directional gain greater than 6 dBi are used, both the maximum conducted output power and the maximum power spectral density shall be reduced by the amount in dB that the directional gain of the antenna exceeds 6 dBi.

■ For the band 5.725-5.85 GHz

(a) (3) For the band 5.725-5.85 GHz, the maximum conducted output power over the frequency band of operation shall not exceed 1 W. In addition, the maximum power spectral density shall not exceed 30 dBm in any 500-kHz band. If transmitting antennas of directional gain greater than 6 dBi are used, both the maximum conducted output power and the maximum power spectral density shall be reduced by the amount in dB that the directional gain of the antenna exceeds 6 dBi.

8.3.3 Test Configuration

Test according to clause 6.1 radio frequency test setup

8.3.4 Test Procedure

Methods refer to FCC KDB 789033

1) Create an average power spectrum for the EUT operating mode being tested by following the instructions in section E)2) for measuring maximum conducted output power using a spectrum analyzer or EMI receiver: select the appropriate test method (SA-3, or alternatives to each) and apply it up to, but not including, the step labeled, "Compute power...".

2) Use the peak search function on the instrument to find the peak of the spectrum.

3) The result is the PPSD.

4) The above procedures make use of 500kHz resolution bandwidth to satisfy the 500kHz measurement bandwidth specified in the 15.407(a)(5). That rule section also permits use of resolution bandwidths less than 1 MHz "provided that the measured power is integrated to show the total power over the measurement bandwidth" (i.e., 1 MHz). If measurements are performed using a reduced resolution bandwidth and integrated over 500kHz bandwidth

Note: As a practical matter, it is recommended to use reduced RBW of 500 kHz for the sections 5.c) and 5.d) above, since RBW=500 kHz is available on nearly all spectrum analyzers.

8.3.5 Test Results

<input checked="" type="checkbox"/> 802.11a mode					
Temperature :		28 °C	Test Date :		July 18, 2016
Humidity :		65 %	Test By:		King Kong
Band	Channel Number	Channel Freq. (MHz)	Power Spectral Density	Limit	Verdict
UNII Band I	CH36	5180	-13.265	≤11dBm/1MHz	Pass
	CH40	5200	-13.650	≤11dBm/1MHz	Pass
	CH48	5240	-13.853	≤11dBm/1MHz	Pass
UNII Band II-A	CH52	5260	-14.229	≤11dBm/1MHz	Pass
	CH56	5280	-14.195	≤11dBm/1MHz	Pass
	CH64	5320	-14.962	≤11dBm/1MHz	Pass
UNII Band II-C	CH100	5500	-10.447	≤11dBm/1MHz	Pass
	CH120	5600	-9.671	≤11dBm/1MHz	Pass
	CH140	5700	-9.751	≤11dBm/1MHz	Pass
Note: N/A (Not Applicable)					

<input checked="" type="checkbox"/> 802.11n(VHT20) mode					
Temperature :		28 °C	Test Date :		July 18, 2016
Humidity :		65 %	Test By:		King Kong
Band	Channel Number	Channel Freq. (MHz)	Power Spectral Density	Limit	Verdict
UNII Band I	CH36	5180	-13.093	≤11dBm/1MHz	Pass
	CH40	5200	-13.901	≤11dBm/1MHz	Pass
	CH48	5240	-14.351	≤11dBm/1MHz	Pass
UNII Band II-A	CH52	5260	-14.433	≤11dBm/1MHz	Pass
	CH56	5280	-13.393	≤11dBm/1MHz	Pass
	CH64	5320	-15.076	≤11dBm/1MHz	Pass
UNII Band II-C	CH100	5500	-9.464	≤11dBm/1MHz	Pass
	CH120	5600	-9.562	≤11dBm/1MHz	Pass
	CH140	5700	-9.650	≤11dBm/1MHz	Pass
Note: N/A (Not Applicable)					

<input checked="" type="checkbox"/> 802.11n(VHT40) mode					
Temperature :		28 °C	Test Date :		July 06, 2016
Humidity :		65 %	Test By:		King Kong
Band	Channel Number	Channel Freq. (MHz)	Power Spectral Density	Limit	Verdict
UNII Band I	CH38	5190	-15.326	≤11dBm/1MHz	Pass
	CH46	5230	-14.914	≤11dBm/1MHz	Pass
UNII Band II-A	CH54	5270	-15.066	≤11dBm/1MHz	Pass
	CH62	5310	-15.924	≤11dBm/1MHz	Pass
UNII Band II-C	CH102	5510	-14.312	≤11dBm/1MHz	Pass
	CH118	5590	-14.250	≤11dBm/1MHz	Pass
	CH134	5670	-14.581	≤11dBm/1MHz	Pass
Note: N/A (Not Applicable)					

Power Spectral Density	UNII Band I
Test Model 802.11a	Frequency(MHz) 5180
Ant0	

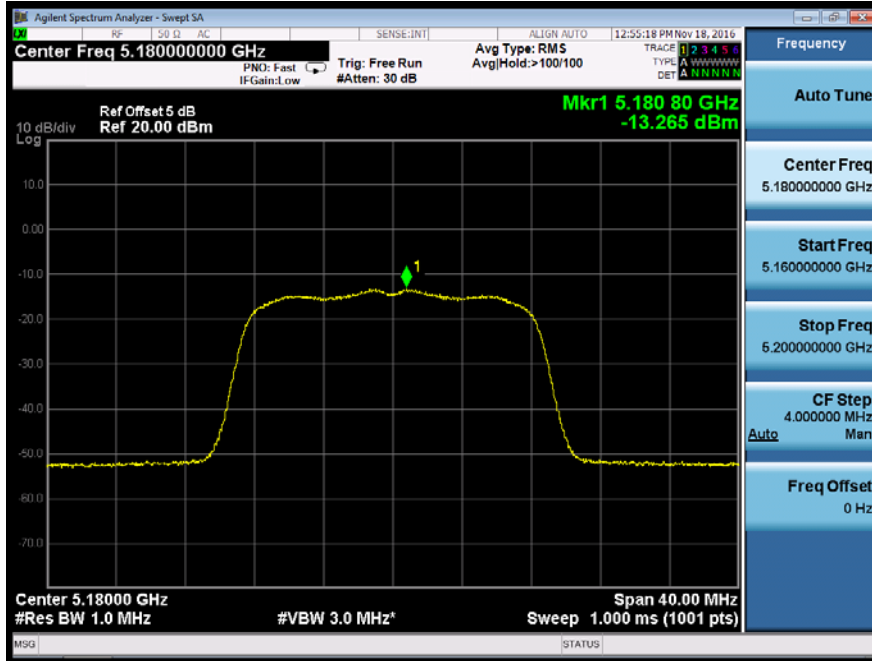

Power Spectral Density	UNII Band I
Test Model 802.11a	Frequency(MHz) 5200
Ant0	

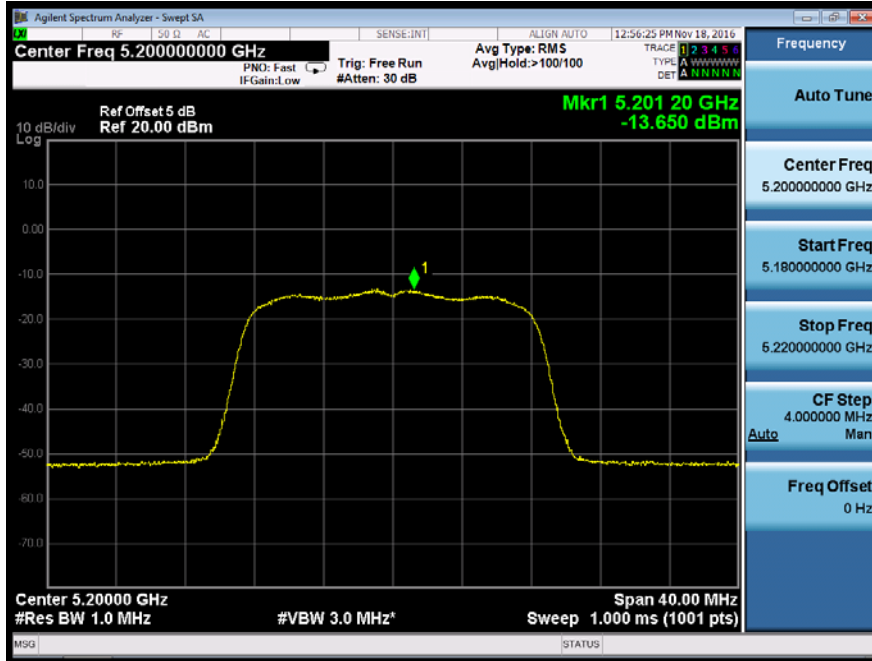

Power Spectral Density	UNII Band I
Test Model 802.11a	Frequency(MHz) 5240
Ant0	

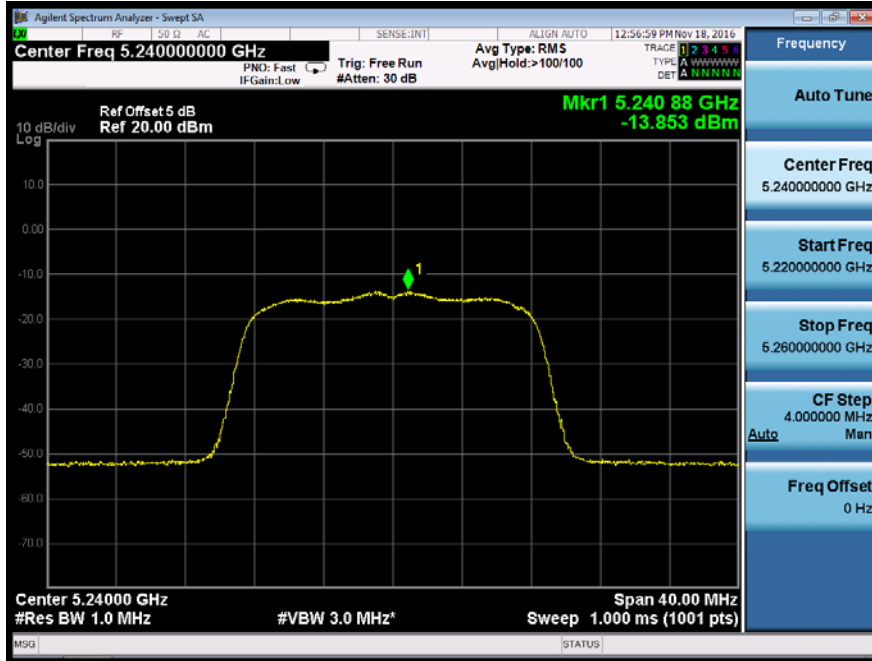

Power Spectral Density	UNII Band II-A
Test Model 802.11a	Frequency(MHz) 5260
Ant0	

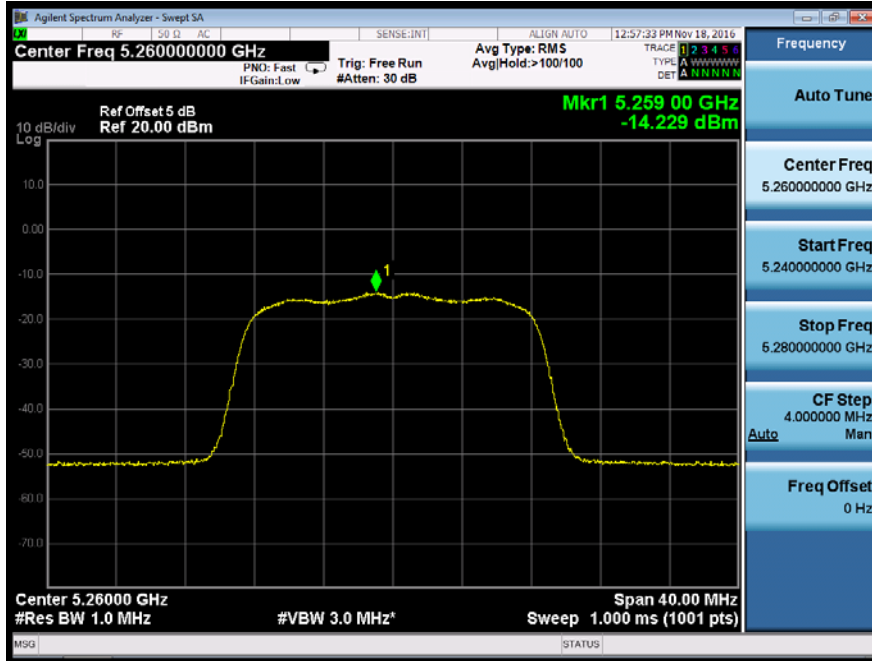

Power Spectral Density	UNII Band II-A
Test Model 802.11a	Frequency(MHz) 5280
Ant0	

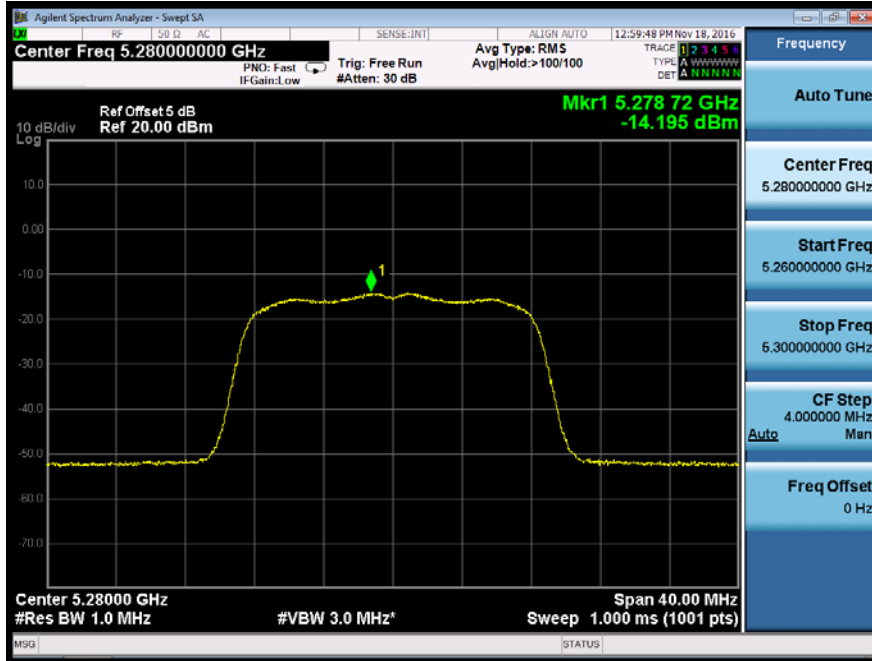

Power Spectral Density	UNII Band II-A
Test Model 802.11a	Frequency(MHz) 5320
Ant0	

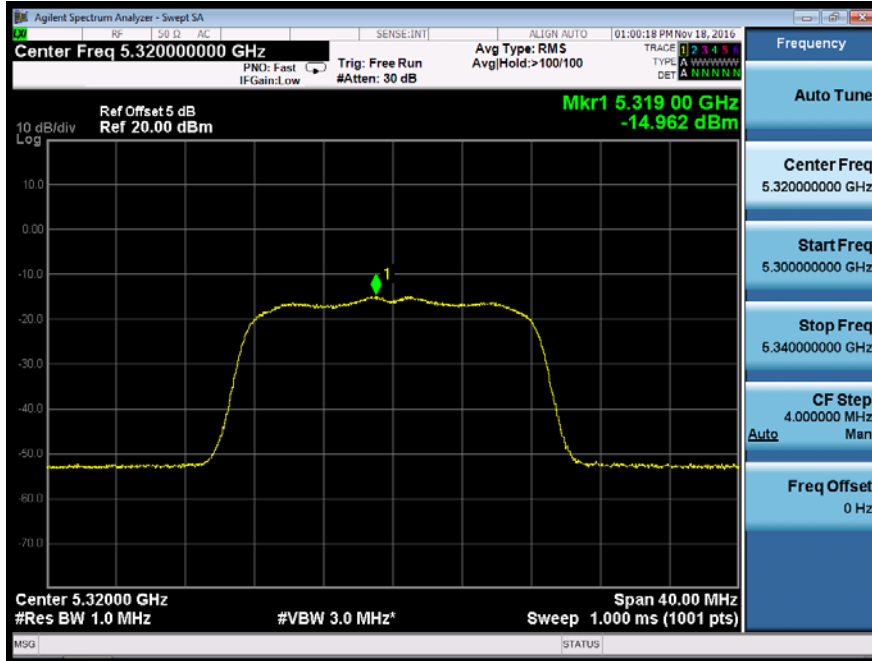

Power Spectral Density	UNII Band II-C
Test Model 802.11a	Frequency(MHz) 5500
Ant0	

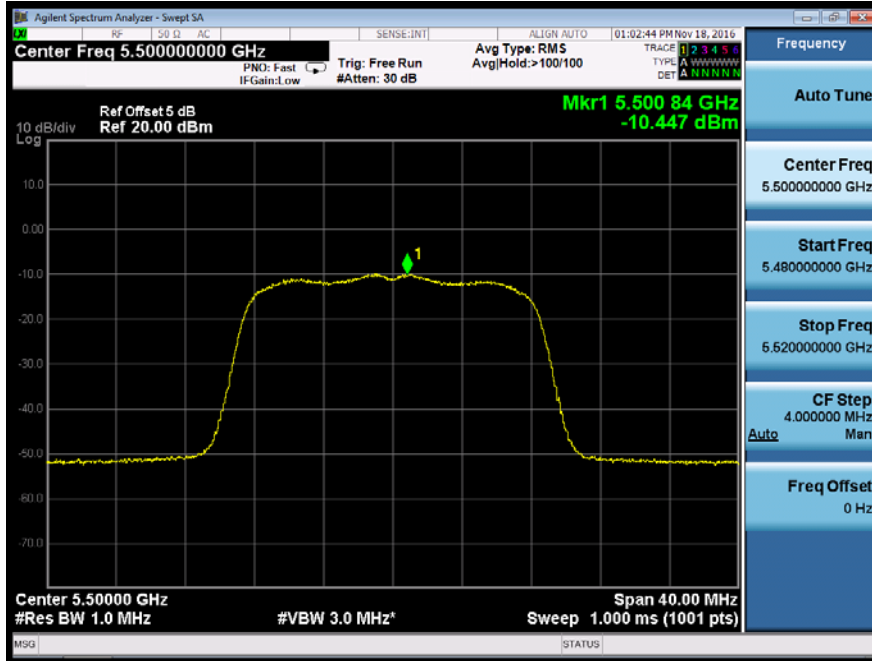

Power Spectral Density	UNII Band II-C
Test Model 802.11a	Frequency(MHz) 5600
Ant0	

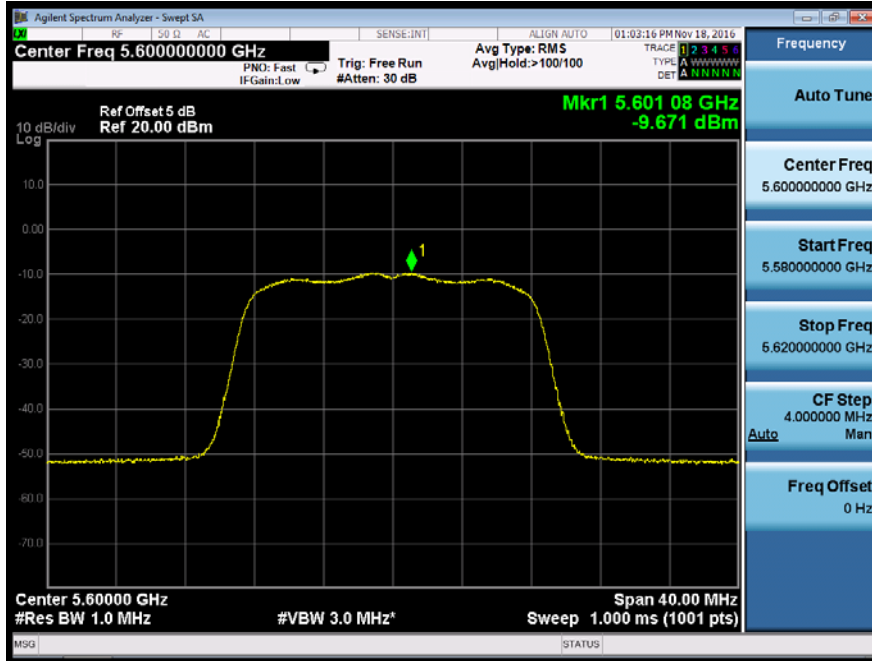

Power Spectral Density	UNII Band II-C
Test Model 802.11a	Frequency(MHz) 5700
Ant0	

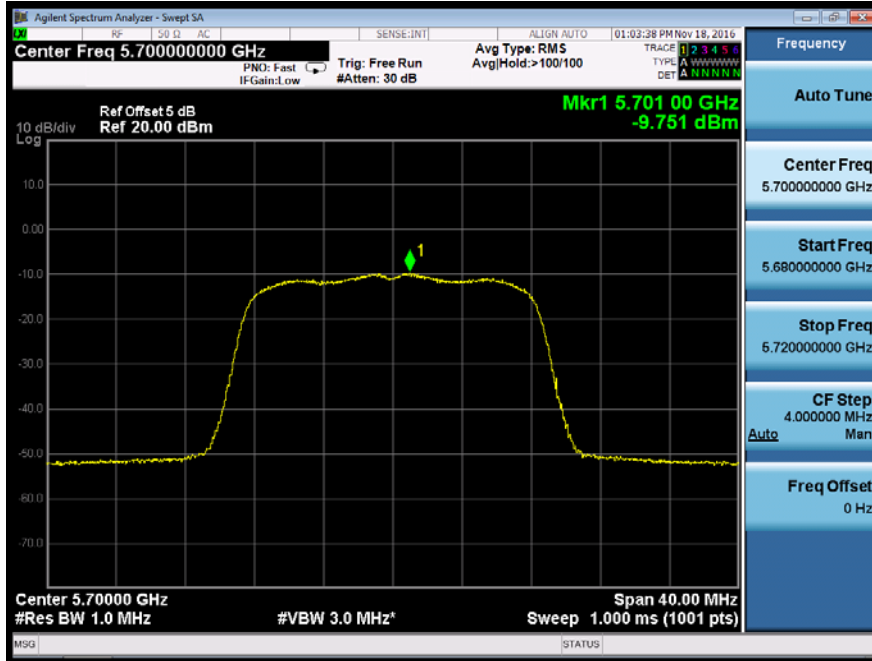

Power Spectral Density	UNII Band I	
Test Model	802.11n(VHT20) mode	Frequency(MHz)
Ant0		5180

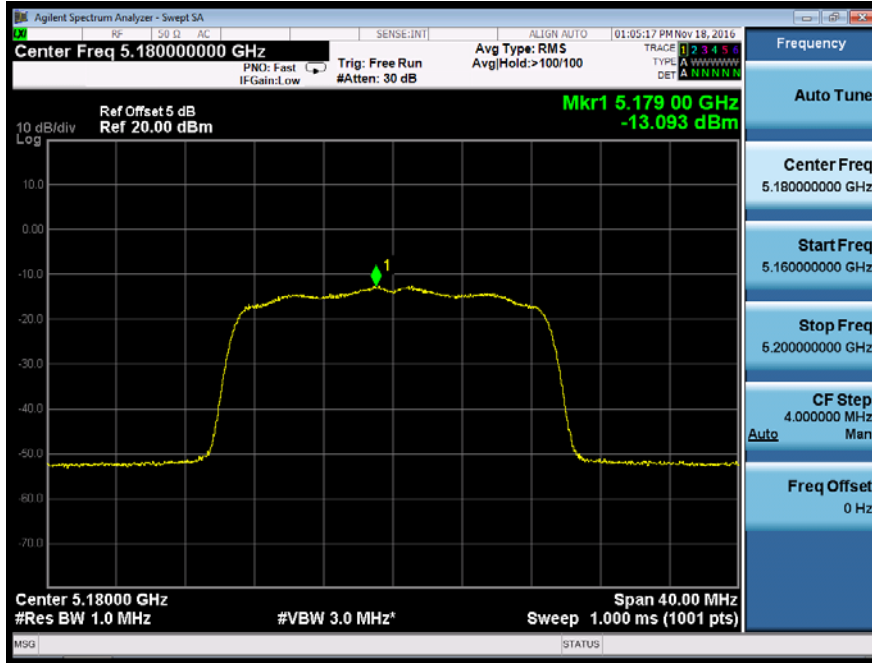

Power Spectral Density	UNII Band I	
Test Model	802.11n(VHT20) mode	Frequency(MHz)
Ant0		5200

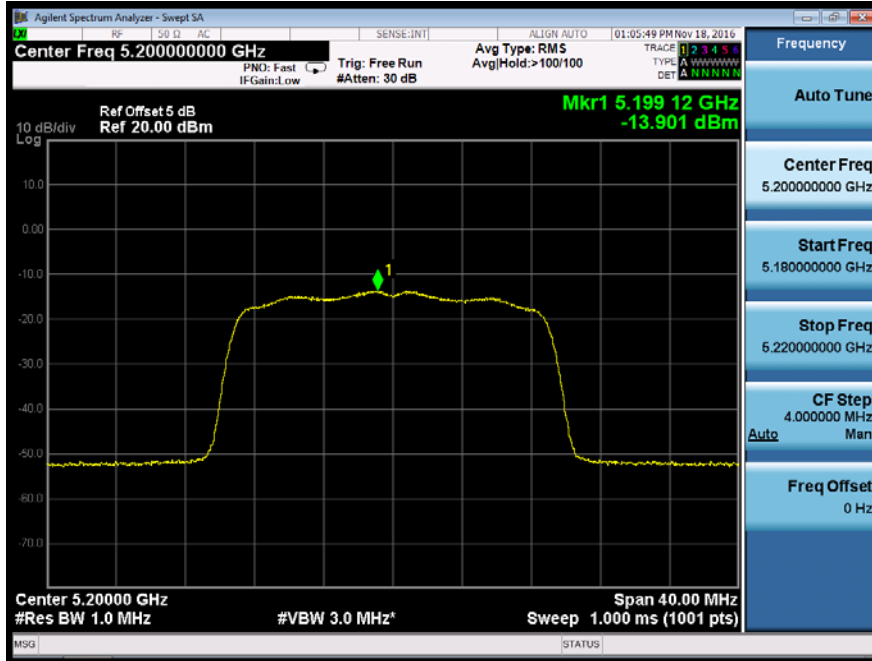

Power Spectral Density	UNII Band I	
Test Model	802.11n(VHT20) mode	Frequency(MHz) 5240
Ant0		

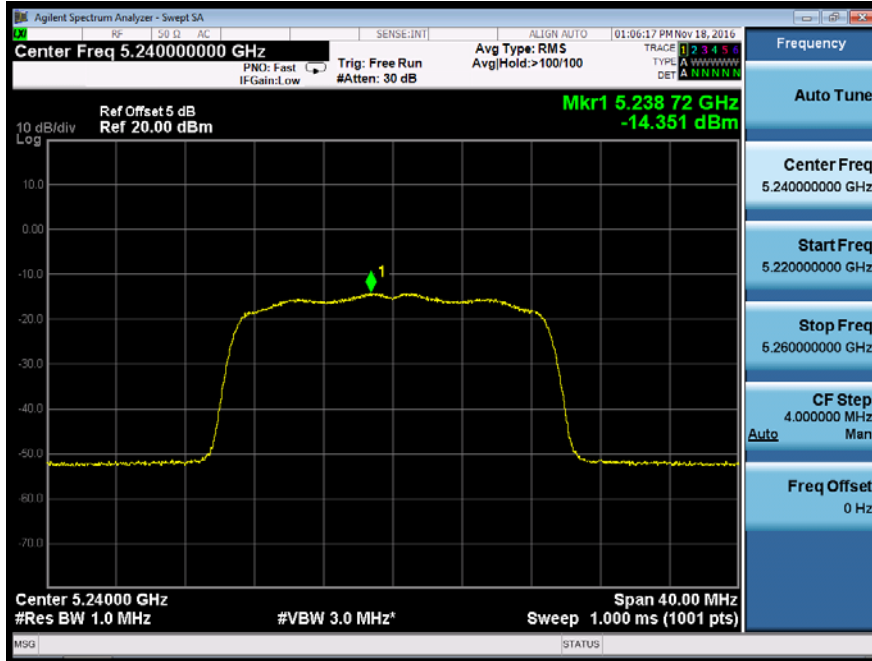

Power Spectral Density	UNII Band II-A	
Test Model	802.11n(VHT20) mode	Frequency(MHz)
Ant0		5260

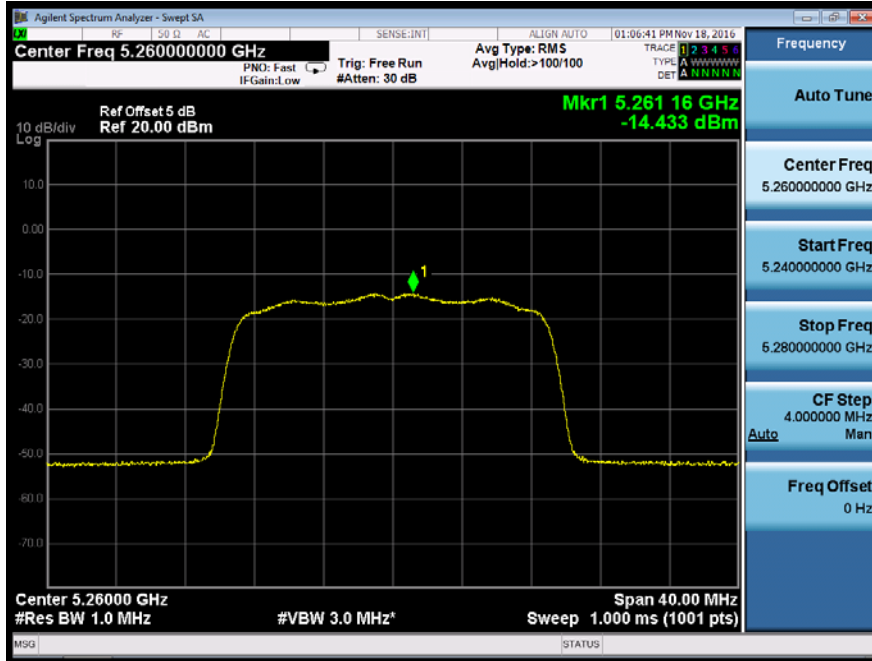

Power Spectral Density	UNII Band II-A	
Test Model	802.11n(VHT20) mode	Frequency(MHz)
Ant0		5280

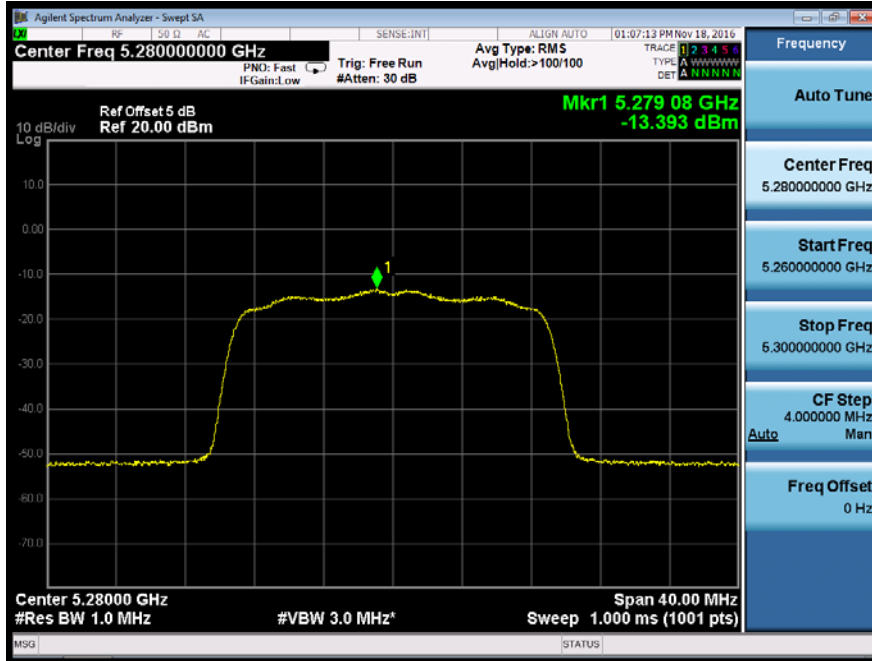

Power Spectral Density	UNII Band II-A	
Test Model	802.11n(VHT20) mode	Frequency(MHz)
Ant0		5320

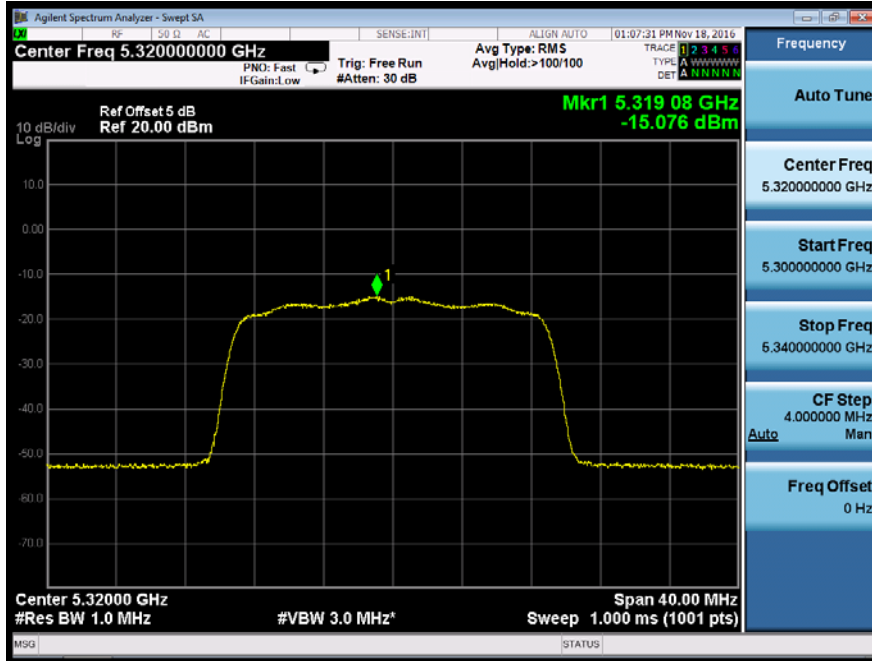

Power Spectral Density	UNII Band II-C	
Test Model	802.11n(VHT20) mode	Frequency(MHz)
Ant0		5500

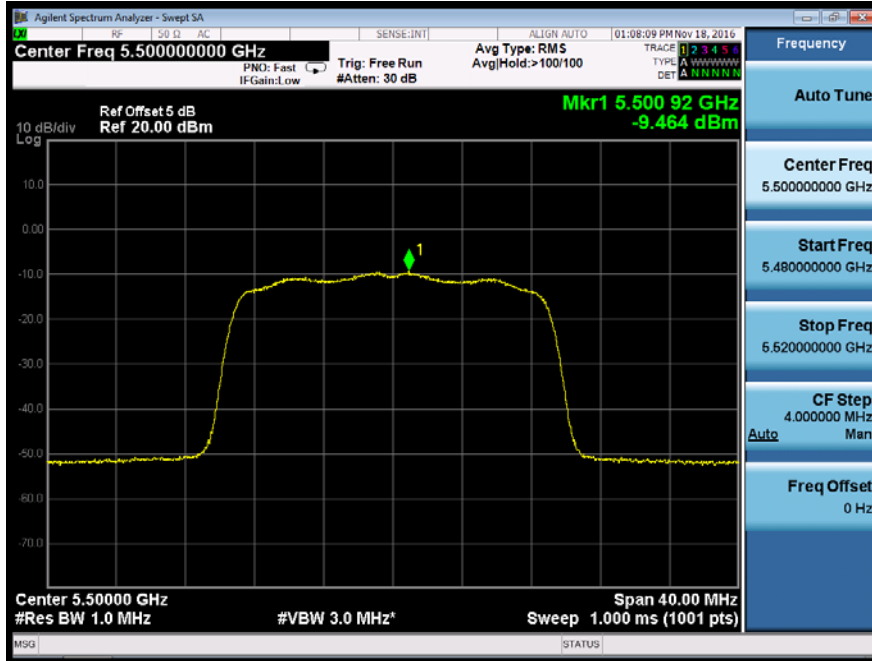

Power Spectral Density	UNII Band II-C	
Test Model	802.11n(VHT20) mode	Frequency(MHz)
Ant0		5600

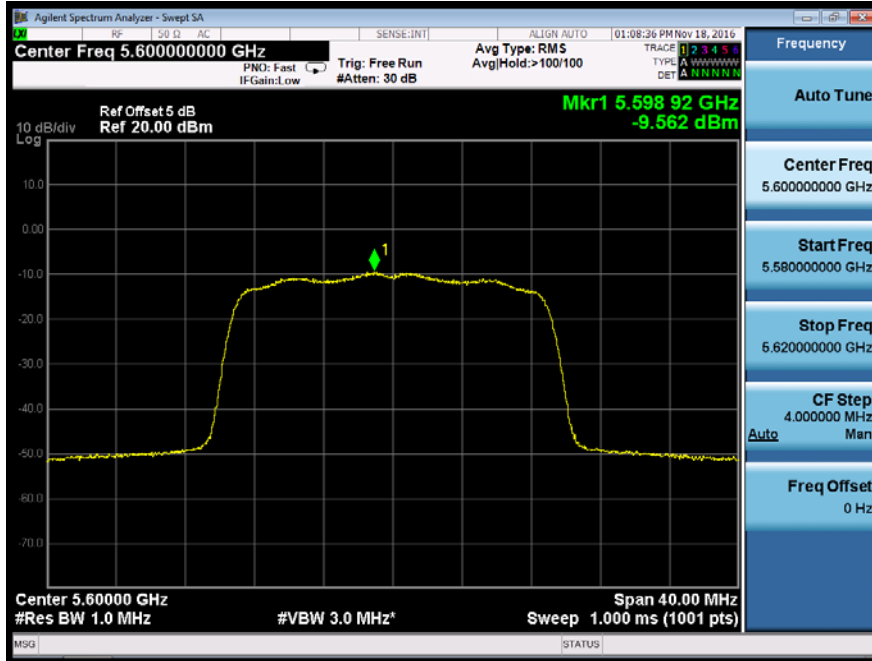

Power Spectral Density	UNII Band II-C	
Test Model	802.11n(VHT20) mode	Frequency(MHz)
Ant0		5700

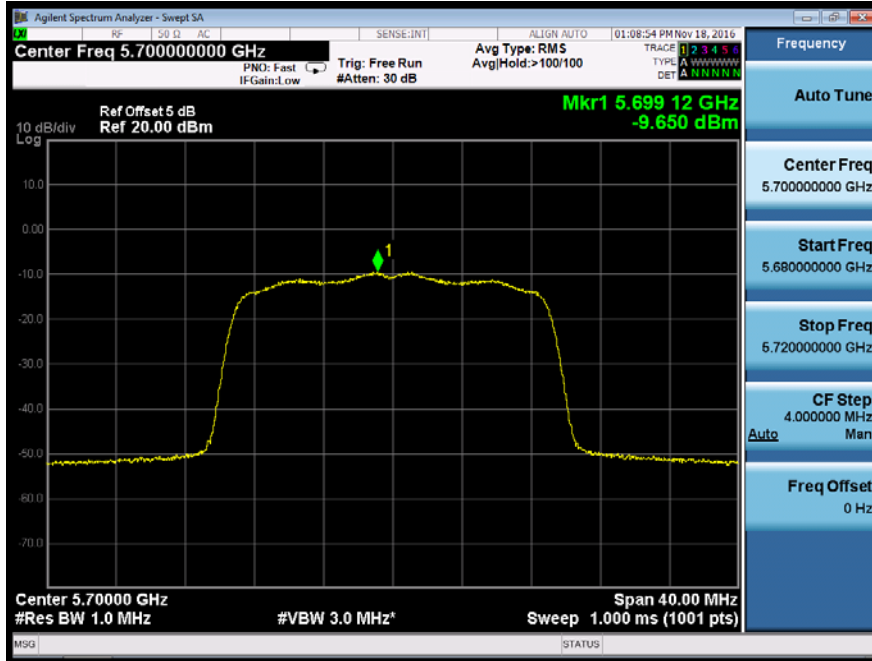

Power Spectral Density	UNII Band I	
Test Model	802.11n(VHT40) mode	Frequency(MHz) 5190
Ant0		

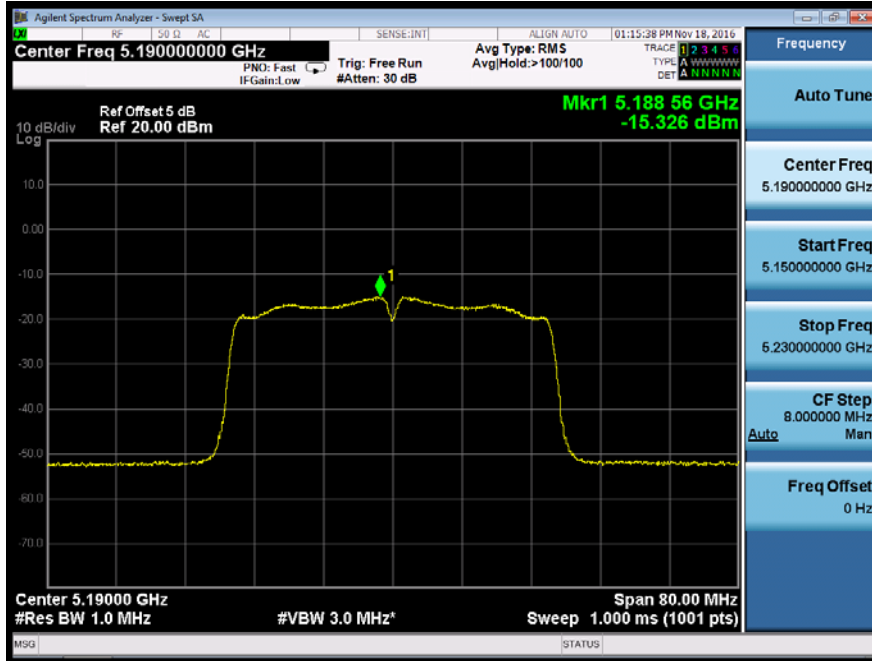

Power Spectral Density	UNII Band I	
Test Model	802.11n(VHT40) mode	Frequency(MHz)
Ant0		5230

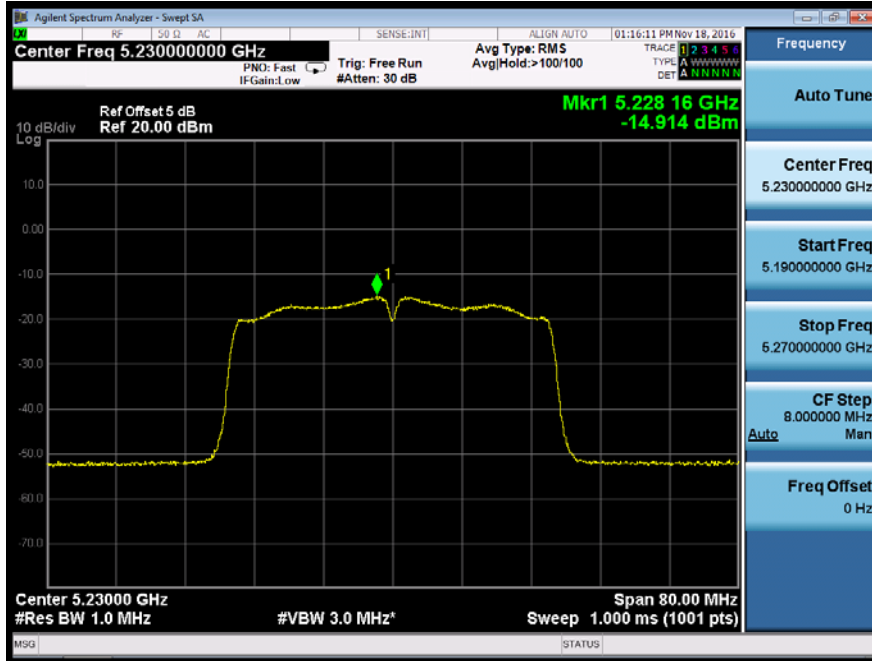

Power Spectral Density	UNII Band II-A	
Test Model	802.11n(VHT40) mode	Frequency(MHz)
Ant0		5270

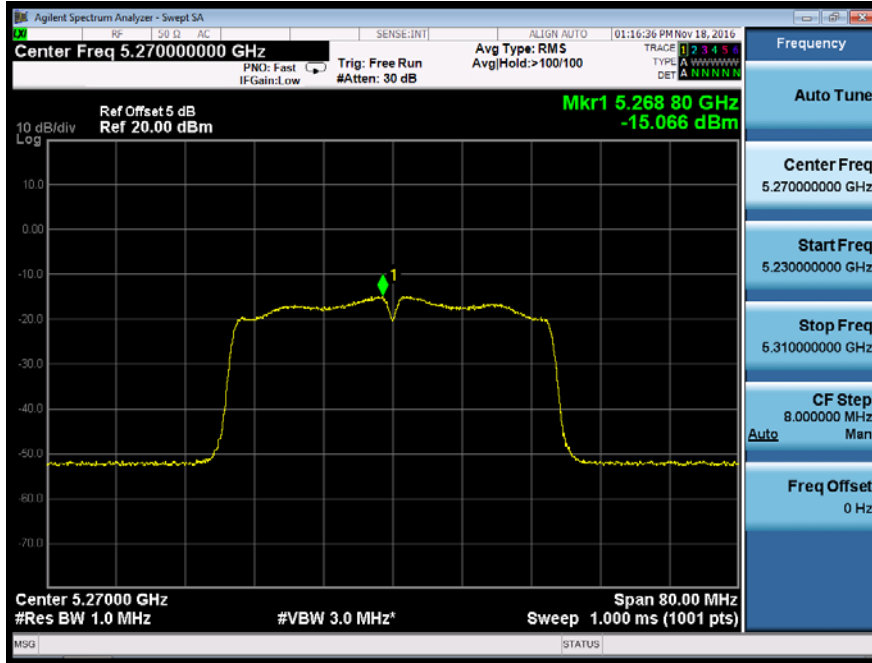

Power Spectral Density	UNII Band II-A	
Test Model	802.11n(VHT40) mode	Frequency(MHz)
Ant0		5310

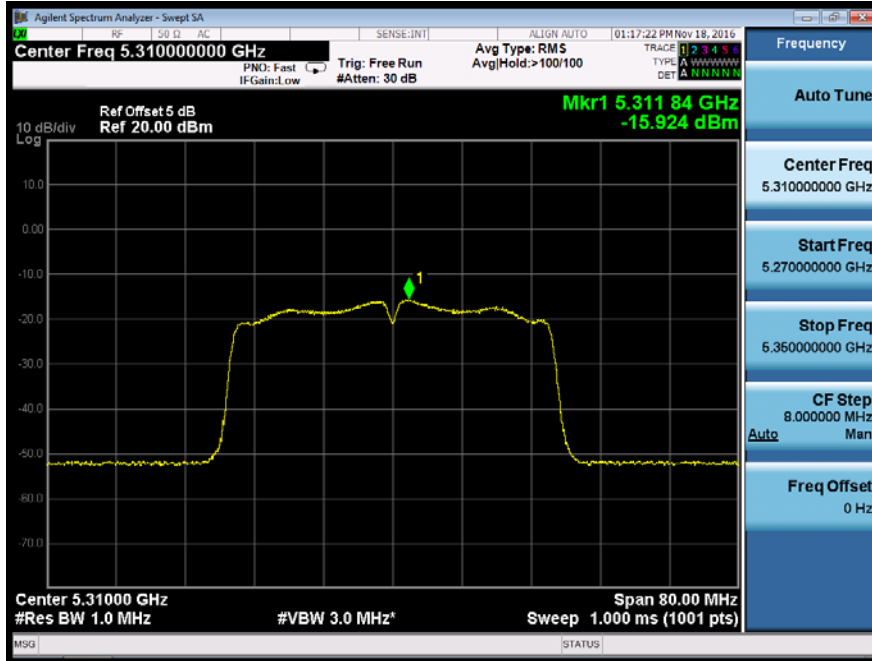

Power Spectral Density	UNII Band II-C	
Test Model	802.11n(VHT40) mode	Frequency(MHz)
Ant0		5510

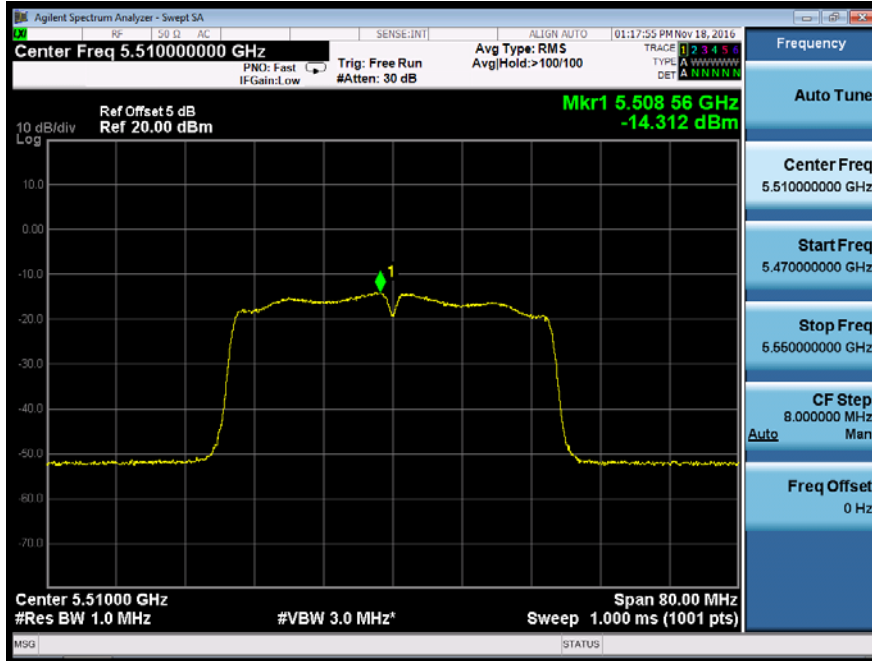

Power Spectral Density	UNII Band II-C	
Test Model	802.11n(VHT40) mode	Frequency(MHz)
Ant0		5590

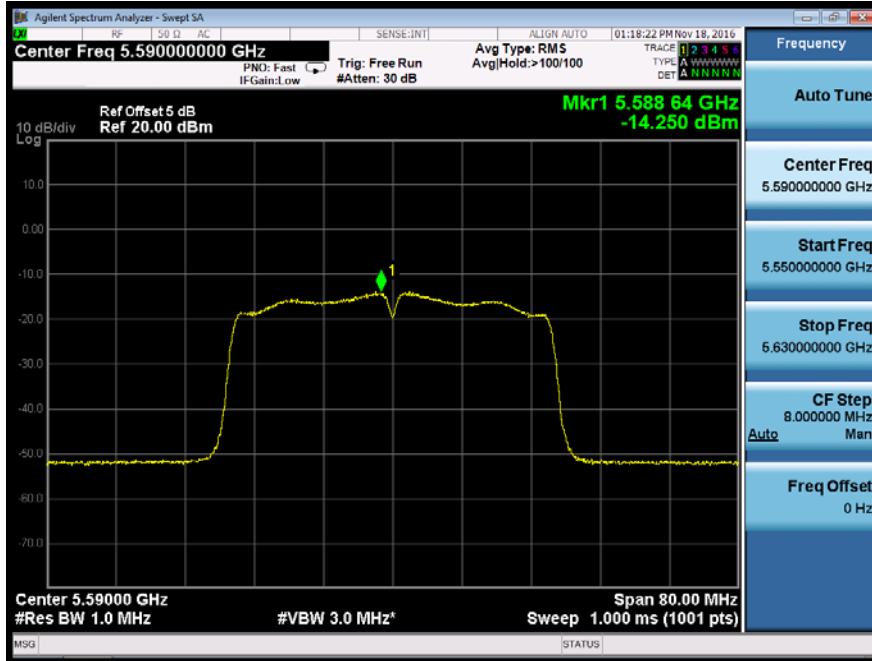

Power Spectral Density	UNII Band II-C	
Test Model	802.11n(VHT40) mode	Frequency(MHz)
Ant0		5670

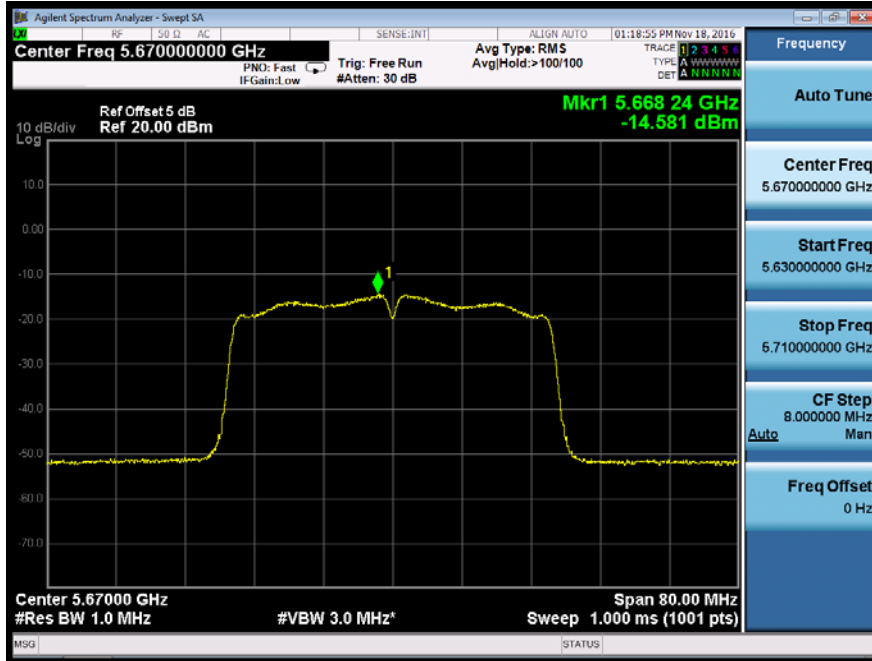

8.4 FREQUENCY STABILITY

8.4.1 Applicable Standard

According to FCC Part 15.407(g)
ANSI C63.10 Section 6.8

8.4.2 Conformance Limit

Manufacturers of U-NII devices are responsible for ensuring frequency stability such that an emission is maintained within the band of operation under all conditions of normal operation as specified in the users manual.

8.4.3 Test Configuration

Test according to clause 6.1 radio frequency test setup

8.4.4 Test Procedure

The RF output of EUT was connected to the spectrum analyzer by RF cable and attenuator. The path loss was compensated to the results for each measurement.

Set to the maximum power setting and enable the EUT transmit continuously

Set RBW = 10 kHz.

Set the video bandwidth (VBW) =30 kHz.

Set Span= Entire absence of modulation emissions bandwidth

Set Detector = Peak.

Set Trace mode = max hold.

Set Sweep = auto couple.

Allow the trace to stabilize.

The test extreme voltage is to change the primary supply voltage from 85 to 115 percent of the nominal value.

Beginning at each temperature level specified in user manual , the frequency shall be measured within one minute after application of primary power to the transmitter and at intervals of no more than one minute thereafter until ten minutes have elapsed or until sufficient measurements are obtained to indicate clearly that the frequency has stabilized within the applicable tolerance, whichever time period is greater. During each test, the ambient temperature shall not be allowed to rise more than 10° centigrade above the respective beginning ambient temperature level

Measure and record the results in the test report.

8.4.5 Test Results

802.11a mode	5180
Temperature : --	Test Date : April 20, 2016
Humidity : 65 %	Test By: King Kong

Voltage(V)	Temp(°C)	Test Frequency (MHz)	Max. Deviation (KHz)	Verdict
Vnom	-20	5179.969164	-30.836	Pass
	-10	5179.969174	-30.826	Pass
	0	5179.969418	-30.582	Pass
	10	5179.969522	-30.478	Pass
	20	5179.969514	-30.486	Pass
	30	5179.969275	-30.725	Pass
	40	5179.969975	-30.025	Pass
	50	5179.969564	-30.436	Pass
85% Vnom	20	5179.969513	-30.487	Pass
115% Vnom	20	5179.969275	-30.725	Pass

802.11a mode	5200
Temperature : --	Test Date : April 20, 2016
Humidity : 65 %	Test By: King Kong

Voltage(V)	Temp(°C)	Test Frequency (MHz)	Max. Deviation (KHz)	Verdict
Vnom	-20	5199.961050	-38.950	Pass
	-10	5199.961410	-38.590	Pass
	0	5199.961571	-38.429	Pass
	10	5199.961528	-38.472	Pass
	20	5200.038725	38.725	Pass
	30	5199.961513	-38.487	Pass
	40	5199.961842	-38.158	Pass
	50	5199.961704	-38.296	Pass
85% Vnom	20	5199.961075	-38.925	Pass
115% Vnom	20	5199.961037	-38.963	Pass

802.11a mode	5240
Temperature : --	Test Date : April 20, 2016
Humidity : 65 %	Test By: King Kong

Voltage(V)	Temp(°C)	Test Frequency (MHz)	Max. Deviation (KHz)	Verdict
Vnom	-20	5239.977897	-22.103	Pass
	-10	5239.977892	-22.108	Pass
	0	5239.977595	-22.405	Pass
	10	5239.977841	-22.159	Pass
	20	5239.977635	-22.365	Pass
	30	5239.977585	-22.415	Pass
	40	5239.977275	-22.725	Pass
	50	5239.977975	-22.025	Pass
85% Vnom	20	5239.977699	-22.301	Pass
115% Vnom	20	5239.977595	-22.405	Pass

802.11a mode	5260
Temperature : --	Test Date : April 20, 2016
Humidity : 65 %	Test By: King Kong

Voltage(V)	Temp(°C)	Test Frequency (MHz)	Max. Deviation (KHz)	Verdict
Vnom	-20	5259.973929	-26.071	Pass
	-10	5259.973646	-26.354	Pass
	0	5259.973595	-26.405	Pass
	10	5259.973855	-26.145	Pass
	20	5259.973695	-26.305	Pass
	30	5259.973498	-26.502	Pass
	40	5259.973149	-26.851	Pass
	50	5259.973646	-26.354	Pass
85% Vnom	20	5259.973590	-26.410	Pass
115% Vnom	20	5259.973842	-26.158	Pass

802.11a mode	5280
Temperature : --	Test Date : April 20, 2016
Humidity : 65 %	Test By: King Kong

Voltage(V)	Temp(°C)	Test Frequency (MHz)	Max. Deviation (KHz)	Verdict
Vnom	-20	5279.993934	-6.066	Pass
	-10	5279.993942	-6.058	Pass
	0	5279.993988	-6.012	Pass
	10	5279.993598	-6.402	Pass
	20	5279.993895	-6.105	Pass
	30	5279.993480	-6.520	Pass
	40	5279.993797	-6.203	Pass
	50	5279.993956	-6.044	Pass
85% Vnom	20	5279.993599	-6.401	Pass
115% Vnom	20	5279.993742	-6.258	Pass

802.11a mode	5320
Temperature : --	Test Date : April 20, 2016
Humidity : 65 %	Test By: King Kong

Voltage(V)	Temp(°C)	Test Frequency (MHz)	Max. Deviation (KHz)	Verdict
Vnom	-20	5319.949702	-50.298	Pass
	-10	5319.949751	-50.249	Pass
	0	5319.949836	-50.164	Pass
	10	5319.949655	-50.345	Pass
	20	5319.949631	-50.369	Pass
	30	5319.949513	-50.487	Pass
	40	5319.949358	-50.642	Pass
	50	5319.949836	-50.164	Pass
85% Vnom	20	5319.949532	-50.468	Pass
115% Vnom	20	5319.949531	-50.469	Pass

802.11a mode	5500
Temperature : --	Test Date : April 20, 2016
Humidity : 65 %	Test By: King Kong

Voltage(V)	Temp(°C)	Test Frequency (MHz)	Max. Deviation (KHz)	Verdict
Vnom	-20	5499.964939	-35.061	Pass
	-10	5499.964855	-35.145	Pass
	0	5499.964831	-35.169	Pass
	10	5499.964896	-35.104	Pass
	20	5499.964802	-35.198	Pass
	30	5499.964850	-35.150	Pass
	40	5499.964599	-35.401	Pass
	50	5499.964258	-35.742	Pass
85% Vnom	20	5499.964831	-35.169	Pass
115% Vnom	20	5499.964744	-35.256	Pass

802.11a mode	5600
Temperature : --	Test Date : April 20, 2016
Humidity : 65 %	Test By: King Kong

Voltage(V)	Temp(°C)	Test Frequency (MHz)	Max. Deviation (KHz)	Verdict
Vnom	-20	5600.021035	21.035	Pass
	-10	5600.021064	21.064	Pass
	0	5600.021358	21.358	Pass
	10	5600.021421	21.421	Pass
	20	5600.021520	21.520	Pass
	30	5600.021365	21.365	Pass
	40	5600.021360	21.360	Pass
	50	5600.021259	21.259	Pass
85% Vnom	20	5600.021402	21.402	Pass
115% Vnom	20	5600.021600	21.600	Pass

802.11a mode	5700
Temperature : --	Test Date : April 20, 2016
Humidity : 65 %	Test By: King Kong

Voltage(V)	Temp(°C)	Test Frequency (MHz)	Max. Deviation (KHz)	Verdict
Vnom	-20	5699.956226	-43.774	Pass
	-10	5699.956746	-43.254	Pass
	0	5699.956831	-43.169	Pass
	10	5699.956811	-43.189	Pass
	20	5699.956517	-43.483	Pass
	30	5699.956577	-43.423	Pass
	40	5699.956544	-43.456	Pass
	50	5699.956238	-43.762	Pass
85% Vnom	20	5699.956458	-43.542	Pass
115% Vnom	20	5699.956048	-43.952	Pass

802.11n(VHT20) mode 5180
 Temperature : -- Test Date : April 20, 2016
 Humidity : 65 % Test By: King Kong

Voltage(V)	Temp(°C)	Test Frequency (MHz)	Max. Deviation (KHz)	Verdict
Vnom	-20	5180.001119	1.119	Pass
	-10	5180.001119	1.119	Pass
	0	5180.001125	1.125	Pass
	10	5180.001147	1.147	Pass
	20	5180.001156	1.156	Pass
	30	5180.001526	1.526	Pass
	40	5180.001565	1.565	Pass
50	5180.001526	1.526	Pass	
85% Vnom	20	5180.001525	1.525	Pass
115% Vnom	20	5180.001582	1.582	Pass

802.11n(VHT20) mode 5200
 Temperature : -- Test Date : April 20, 2016
 Humidity : 65 % Test By: King Kong

Voltage(V)	Temp(°C)	Test Frequency (MHz)	Max. Deviation (KHz)	Verdict
Vnom	-20	5199.975972	-24.028	Pass
	-10	5199.975636	-24.364	Pass
	0	5199.975451	-24.549	Pass
	10	5199.975818	-24.182	Pass
	20	5199.975279	-24.721	Pass
	30	5199.975458	-24.542	Pass
	40	5199.975180	-24.820	Pass
50	5199.975840	-24.160	Pass	
85% Vnom	20	5199.975148	-24.852	Pass
115% Vnom	20	5199.975985	-24.015	Pass

802.11n(VHT20) mode 5240
 Temperature : -- Test Date : April 20, 2016
 Humidity : 65 % Test By: King Kong

Voltage(V)	Temp(°C)	Test Frequency (MHz)	Max. Deviation (KHz)	Verdict
Vnom	-20	5239.981944	-18.056	Pass
	-10	5239.981544	-18.456	Pass
	0	5239.981550	-18.450	Pass
	10	5239.981548	-18.452	Pass
	20	5239.981779	-18.221	Pass
	30	5239.981490	-18.510	Pass
	40	5239.981452	-18.548	Pass
50	5239.981548	-18.452	Pass	
85% Vnom	20	5239.981855	-18.145	Pass
115% Vnom	20	5239.981459	-18.541	Pass

802.11n(VHT20) mode	5260
Temperature : --	Test Date : April 20, 2016
Humidity : 65 %	Test By: King Kong

Voltage(V)	Temp(°C)	Test Frequency (MHz)	Max. Deviation (KHz)	Verdict
Vnom	-20	5259.998000	-2.000	Pass
	-10	5259.997842	-2.158	Pass
	0	5259.997411	-2.589	Pass
	10	5259.997518	-2.482	Pass
	20	5259.997402	-2.598	Pass
	30	5259.997511	-2.489	Pass
	40	5259.997831	-2.169	Pass
	50	5259.997985	-2.015	Pass
85% Vnom	20	5259.997931	-2.069	Pass
115% Vnom	20	5259.997310	-2.690	Pass

802.11n(VHT20) mode	5280
Temperature : --	Test Date : April 20, 2016
Humidity : 65 %	Test By: King Kong

Voltage(V)	Temp(°C)	Test Frequency (MHz)	Max. Deviation (KHz)	Verdict
Vnom	-20	5279.980370	-19.630	Pass
	-10	5279.980148	-19.852	Pass
	0	5279.980580	-19.420	Pass
	10	5279.980508	-19.492	Pass
	20	5279.980518	-19.482	Pass
	30	5279.980572	-19.428	Pass
	40	5279.980242	-19.758	Pass
	50	5279.980140	-19.860	Pass
85% Vnom	20	5279.980631	-19.369	Pass
115% Vnom	20	5279.980518	-19.482	Pass

802.11n(VHT20) mode	5320
Temperature : --	Test Date : April 20, 2016
Humidity : 65 %	Test By: King Kong

Voltage(V)	Temp(°C)	Test Frequency (MHz)	Max. Deviation (KHz)	Verdict
Vnom	-20	5319.981431	-18.569	Pass
	-10	5319.981518	-18.482	Pass
	0	5319.981308	-18.692	Pass
	10	5319.981580	-18.420	Pass
	20	5319.981365	-18.635	Pass
	30	5319.981418	-18.582	Pass
	40	5319.981753	-18.247	Pass
	50	5319.981464	-18.536	Pass
85% Vnom	20	5319.981449	-18.551	Pass
115% Vnom	20	5319.981735	-18.265	Pass

802.11n(VHT20) mode	5500
Temperature : --	Test Date : April 20, 2016
Humidity : 65 %	Test By: King Kong

Voltage(V)	Temp(°C)	Test Frequency (MHz)	Max. Deviation (KHz)	Verdict
Vnom	-20	5499.990260	-9.740	Pass
	-10	5499.990480	-9.520	Pass
	0	5499.990631	-9.369	Pass
	10	5499.990842	-9.158	Pass
	20	5499.990864	-9.136	Pass
	30	5499.990842	-9.158	Pass
	40	5499.990635	-9.365	Pass
	50	5499.990850	-9.150	Pass
85% Vnom	20	5499.990880	-9.120	Pass
115% Vnom	20	5499.990742	-9.258	Pass

802.11n(VHT20) mode	5600
Temperature : --	Test Date : April 20, 2016
Humidity : 65 %	Test By: King Kong

Voltage(V)	Temp(°C)	Test Frequency (MHz)	Max. Deviation (KHz)	Verdict
Vnom	-20	5599.993025	-6.975	Pass
	-10	5599.993742	-6.258	Pass
	0	5599.993641	-6.359	Pass
	10	5599.993848	-6.152	Pass
	20	5599.993642	-6.358	Pass
	30	5599.993977	-6.023	Pass
	40	5599.993472	-6.528	Pass
	50	5599.993925	-6.075	Pass
85% Vnom	20	5599.993648	-6.352	Pass
115% Vnom	20	5599.993858	-6.142	Pass

802.11n(VHT20) mode	5700
Temperature : --	Test Date : April 20, 2016
Humidity : 65 %	Test By: King Kong

Voltage(V)	Temp(°C)	Test Frequency (MHz)	Max. Deviation (KHz)	Verdict
Vnom	-20	5699.982700	-17.300	Pass
	-10	5699.982742	-17.258	Pass
	0	5699.982595	-17.405	Pass
	10	5699.982458	-17.542	Pass
	20	5699.982479	-17.521	Pass
	30	5699.982855	-17.145	Pass
	40	5699.982946	-17.054	Pass
	50	5699.982946	-17.054	Pass
85% Vnom	20	5699.982582	-17.418	Pass
115% Vnom	20	5699.982946	-17.054	Pass

802.11n(VHT40) mode	5190
Temperature : --	Test Date : April 20, 2016
Humidity : 65 %	Test By: King Kong

Voltage(V)	Temp(°C)	Test Frequency (MHz)	Max. Deviation (KHz)	Verdict
Vnom	-20	5189.975094	-24.906	Pass
	-10	5189.975977	-24.023	Pass
	0	5189.975969	-24.031	Pass
	10	5189.975931	-24.069	Pass
	20	5189.975360	-24.640	Pass
	30	5189.975640	-24.360	Pass
	40	5189.975685	-24.315	Pass
50	5189.975635	-24.365	Pass	
85% Vnom	20	5189.975838	-24.162	Pass
115% Vnom	20	5189.975508	-24.492	Pass

802.11n(VHT40) mode	5230
Temperature : --	Test Date : April 20, 2016
Humidity : 65 %	Test By: King Kong

Voltage(V)	Temp(°C)	Test Frequency (MHz)	Max. Deviation (KHz)	Verdict
Vnom	-20	5229.972351	-27.649	Pass
	-10	5229.972694	-27.306	Pass
	0	5229.972599	-27.401	Pass
	10	5229.972594	-27.406	Pass
	20	5229.972764	-27.236	Pass
	30	5229.972880	-27.120	Pass
	40	5229.972375	-27.625	Pass
50	5229.972437	-27.563	Pass	
85% Vnom	20	5229.972855	-27.145	Pass
115% Vnom	20	5229.972841	-27.159	Pass

802.11n(VHT40) mode	5270
Temperature : --	Test Date : April 20, 2016
Humidity : 65 %	Test By: King Kong

Voltage(V)	Temp(°C)	Test Frequency (MHz)	Max. Deviation (KHz)	Verdict
Vnom	-20	5270.025713	25.713	Pass
	-10	5270.025716	25.716	Pass
	0	5270.025316	25.316	Pass
	10	5270.025169	25.169	Pass
	20	5270.025348	25.348	Pass
	30	5270.025369	25.369	Pass
	40	5270.025452	25.452	Pass
50	5270.025013	25.013	Pass	
85% Vnom	20	5270.025403	25.403	Pass
115% Vnom	20	5270.025156	25.156	Pass

802.11n(VHT40) mode	5310
Temperature : --	Test Date : April 20, 2016
Humidity : 65 %	Test By: King Kong

Voltage(V)	Temp(°C)	Test Frequency (MHz)	Max. Deviation (KHz)	Verdict
Vnom	-20	5309.982542	-17.458	Pass
	-10	5309.982455	-17.545	Pass
	0	5309.982749	-17.251	Pass
	10	5309.982371	-17.629	Pass
	20	5309.982944	-17.056	Pass
	30	5309.982515	-17.485	Pass
	40	5309.982048	-17.952	Pass
50	5309.982420	-17.580	Pass	
85% Vnom	20	5309.982949	-17.051	Pass
115% Vnom	20	5309.982308	-17.692	Pass

802.11n(VHT40) mode 5510
 Temperature : -- Test Date : April 20, 2016
 Humidity : 65 % Test By: King Kong

Voltage(V)	Temp(°C)	Test Frequency (MHz)	Max. Deviation (KHz)	Verdict
Vnom	-20	5510.009964	9.964	Pass
	-10	5510.009625	9.625	Pass
	0	5510.009369	9.369	Pass
	10	5510.009592	9.592	Pass
	20	5510.009548	9.548	Pass
	30	5510.009712	9.712	Pass
	40	5510.009625	9.625	Pass
50	5510.009153	9.153	Pass	
85% Vnom	20	5510.009360	9.360	Pass
115% Vnom	20	5510.009546	9.546	Pass

802.11n(VHT40) mode 5590
 Temperature : -- Test Date : April 20, 2016
 Humidity : 65 % Test By: King Kong

Voltage(V)	Temp(°C)	Test Frequency (MHz)	Max. Deviation (KHz)	Verdict
Vnom	-20	5590.003459	3.459	Pass
	-10	5590.003265	3.265	Pass
	0	5590.003153	3.153	Pass
	10	5590.003025	3.025	Pass
	20	5590.003256	3.256	Pass
	30	5590.003156	3.156	Pass
	40	5590.003189	3.189	Pass
50	5590.003419	3.419	Pass	
85% Vnom	20	5590.003156	3.156	Pass
115% Vnom	20	5590.003156	3.156	Pass

802.11n(VHT40) mode 5670
 Temperature : -- Test Date : April 20, 2016
 Humidity : 65 % Test By: King Kong

Voltage(V)	Temp(°C)	Test Frequency (MHz)	Max. Deviation (KHz)	Verdict
Vnom	-20	5669.980735	-19.265	Pass
	-10	5669.980810	-19.190	Pass
	0	5669.980811	-19.189	Pass
	10	5669.980842	-19.158	Pass
	20	5669.980850	-19.150	Pass
	30	5669.980845	-19.155	Pass
	40	5669.980860	-19.140	Pass
50	5669.980844	-19.156	Pass	
85% Vnom	20	5669.980247	-19.753	Pass
115% Vnom	20	5669.980616	-19.384	Pass

8.5 UNDESIRABLE RADIATED SPURIOUS EMISSION

8.5.1 Applicable Standard

According to FCC Part 15.407 (b)

According to 789033 D02 Section II(G)

8.5.2 Conformance Limit

For transmitters operating in the 5.15-5.25 GHz band: All emissions outside of the 5.15-5.35 GHz band shall not exceed an e.i.r.p. of -27 dBm/MHz.

For transmitters operating in the 5.25-5.35 GHz band: All emissions outside of the 5.15-5.35 GHz band shall not exceed an e.i.r.p. of -27 dBm/MHz.

For transmitters operating in the 5.47-5.725 GHz band: All emissions outside of the 5.47-5.725 GHz band shall not exceed an e.i.r.p. of -27 dBm/MHz.

For transmitters operating in the 5.725-5.85 GHz band: All emissions within the frequency range from the band edge to 10 MHz above or below the band edge shall not exceed an e.i.r.p. of -17 dBm/MHz; for frequencies 10 MHz or greater above or below the band edge, emissions shall not exceed an e.i.r.p. of -27 dBm/MHz.

The emission measurements shall be performed using a minimum resolution bandwidth of 1 MHz. A lower resolution bandwidth may be employed near the band edge, when necessary, provided the measured energy is integrated to show the total power over 1 MHz.

Unwanted emissions below 1 GHz must comply with the general field strength limits set forth in §15.209

The emissions from an intentional radiator shall not exceed the field strength levels specified in the following table 15.209(a):

Restricted Frequency(MHz)	Field Strength (μV/m)	Field Strength (dBμV/m)	Measurement Distance
0.009-0.490	2400/F(KHz)	20 log (uV/m)	300
0.490-1.705	2400/F(KHz)	20 log (uV/m)	30
1.705-30	30	29.5	30
30-88	100	40	3
88-216	150	43.5	3
216-960	200	46	3
Above 960	500	54	3

The provisions of §15.205 apply to intentional radiators operating under this section, 15.205 Restricted bands of operation

MHz	MHz	MHz	GHz
0.090-0.110	16.42-16.423	399.9-410	4.5-5.15
10.495-0.505	16.69475-16.69525	608-614	5.35-5.46
2.1735-2.1905	16.80425-16.80475	960-1240	7.25-7.75
4.125-4.128	25.5-25.67	1300-1427	8.025-8.5
4.17725-4.17775	37.5-38.25	1435-1626.5	9.0-9.2
4.20725-4.20775	73-74.6	1645.5-1646.5	9.3-9.5
6.215-6.218	74.8-75.2	1660-1710	10.6-12.7
6.26775-6.26825	123-138	2200-2300	14.47-14.5
8.291-8.294	149.9-150.05	2310-2390	15.35-16.2
8.362-8.366	156.52475-156.52525	2483.5-2500	17.7-21.4
8.37625-8.38675	156.7-156.9	2690-2900	22.01-23.12
8.41425-8.41475	162.0125-167.17	3260-3267	23.6-24.0
12.29-12.293	167.72-173.2	3332-3339	31.2-31.8
12.51975-12.52025	240-285	3345.8-3358	36.43-36.5
12.57675-12.57725	322-335.4	3600-4400	(2)
13.36-13.41			

- Remark:
1. Emission level in dBuV/m=20 log (uV/m)
 2. Measurement was performed at an antenna to the closed point of EUT distance of meters.
 3. Only spurious frequency is permitted to locate within the Restricted Bands specified in provision of § 15.205, and the emissions located in restricted bands also comply with 15.209 limit.

8.5.3 Test Configuration

Test according to clause 6.2 radio frequency test setup

8.5.4 Test Procedure

■ Unwanted Emissions Measurements below 1000 MHz

Compliance shall be demonstrated using CISPR quasi-peak detection; however, peak detection is permitted as an alternative to quasi-peak detection.

The EUT was placed on a turn table which is 0.8m above ground plane.

And also, each emission was to be maximized by changing the polarization of receiving antenna both horizontal and vertical.

Repeat above procedures until all frequency measured was complete.

We use software control the EUT, Let EUT hopping on and transmit with highest power, All the modes have been tested and the worst result was reported.

Use the following spectrum analyzer settings:

Set RBW=120kHz for $f < 1$ GHz(30MHz to 1GHz), 200Hz for $f < 150$ KHz(9KHz to 150KHz), 9KHz for < 30 MHz (150KHz to 30KHz).

Set the VBW > RBW.

Detector = Peak.

Trace mode = max hold.

Follow the guidelines in ANSI C63.10-2013 with respect to maximizing the emission by rotating the EUT, measuring the emission while the EUT is situated in three orthogonal planes (if appropriate), adjusting the measurement antenna height and polarization, etc. A pre-amp and a high pass filter are required for this test, in order to provide the measuring system with sufficient sensitivity. Allow the trace to stabilize. The peak reading of the emission, after being corrected by the antenna factor, cable loss, pre-amp gain, etc., is the peak field strength, which must comply with the limit specified in Section 15.35(b). Submit this data.

Repeat above procedures until all frequency measured was complete.

■ Unwanted Maximum peak Emissions Measurements above 1000 MHz

Maximum emission levels are measured by setting the analyzer as follows:

RBW = 1 MHz.

VBW \geq 3 MHz.

Detector = Peak.

Sweep time = auto.

Trace mode = max hold.

Allow sweeps to continue until the trace stabilizes. Note that if the transmission is not continuous, the time required for the trace to stabilize will increase by a factor of approximately $1/x$, where x is the duty cycle. For example, at 50 percent duty cycle, the measurement time will increase by a factor of two relative to measurement time for continuous transmission.

■ Unwanted Average Emissions Measurements above 1000 MHz

Method VB (Averaging using reduced video bandwidth): Alternative method.

RBW = 1 MHz.

Video bandwidth. • If the EUT is configured to transmit with duty cycle \geq 98 percent, set VBW \leq RBW/100 (i.e., 10 kHz) but not less than 10 Hz.

• If the EUT duty cycle is $<$ 98 percent, set VBW \geq $1/T$, where T is defined in section II.B.1.a).

Video bandwidth mode or display mode • The instrument shall be set to ensure that video filtering is applied in the power domain. Typically, this requires setting the detector mode to RMS and setting the Average-VBW Type to Power (RMS).

• As an alternative, the analyzer may be set to linear detector mode. Ensure that video filtering is applied in linear voltage domain (rather than in a log or dB domain). Some analyzers require linear display mode in order to accomplish this. Others have a setting for Average-VBW Type, which can be set to "Voltage" regardless of the display mode.

Detector = Peak.

Sweep time = auto.

Trace mode = max hold.

Allow max hold to run for at least 50 traces if the transmitted signal is continuous or has at least 98 percent duty cycle. For lower duty cycles, increase the minimum number of traces by a factor of $1/x$, where x is the duty cycle. For example, use at least 200 traces if the duty cycle is 25 percent. (If a specific emission is demonstrated to be continuous—i.e., 100 percent duty cycle—rather than turning on and off with the transmit cycle, at least 50 traces shall be averaged.)

■ Band edge measurements.

Unwanted band-edge emissions may be measured using either of the special band-edge measurement techniques (the marker-delta or integration methods) described below. Note that the marker-delta method is primarily a radiated measurement technique that requires the 99% occupied bandwidth edge to be within 2 MHz of the authorized band edge, whereas the integration method can be used in either a radiated or conducted measurement without any special requirement with regards to the displacement of the unwanted emission(s) relative to the authorized bandwidth.

Marker-Delta Method.

The marker-delta method, as described in ANSI C63.10, can be used to perform measurements of the radiated unwanted emissions level of emissions provided that the 99% occupied bandwidth of the fundamental is within 2 MHz of the authorized band-edge.

8.5.5 Test Results

■ For Undesirable radiated Spurious Emission in UNII Band I

All the modes 802.11a/n/ac has been tested and the worst result 802.11a recorded as below: