

FCC 47 CFR PART 15 SUBPART C

CERTIFICATION TEST REPORT

For

Tablet PC

Model No.: MS-ND13

FCC ID: I4L-MSND13

Trademark: MSI

REPORT NO.: ES150714157E3

ISSUE DATE: July 31, 2015

Prepared for

Micro Star International Co Ltd

No. 69, Li-De Street, Zhonghe Dist., New Taipei, Taiwan

Prepared by

SHENZHEN EMTEK CO., LTD.

Bldg 69, Majialong Industry Zone, Nanshan District, Shenzhen,
Guangdong, China

TEL: 86-755-26954280

FAX: 86-755-26954282

TABLE OF CONTENTS

1 TEST RESULT CERTIFICATION3

2 EUT TECHNICAL DESCRIPTION4

3 SUMMARY OF TEST RESULT6

4 TEST METHODOLOGY7

4.1 GENERAL DESCRIPTION OF APPLIED STANDARDS7

4.2 MEASUREMENT EQUIPMENT USED7

4.3 DESCRIPTION OF TEST MODES8

5 FACILITIES AND ACCREDITATIONS9

5.1 FACILITIES9

5.2 LABORATORY ACCREDITATIONS AND LISTINGS9

6 TEST SYSTEM UNCERTAINTY10

7 SETUP OF EQUIPMENT UNDER TEST11

7.1 RADIO FREQUENCY TEST SETUP 111

7.2 RADIO FREQUENCY TEST SETUP 211

7.3 CONDUCTED EMISSION TEST SETUP12

7.4 SUPPORT EQUIPMENT12

8 TEST REQUIREMENTS13

8.1 DTS (6DB) BANDWIDTH13

8.2 MAXIMUM PEAK CONDUCTED OUTPUT POWER20

8.3 MAXIMUM POWER SPECTRAL DENSITY21

8.4 UNWANTED EMISSIONS INTO NON-RESTRICTED FREQUENCY BANDS28

8.5 RADIATED SPURIOUS EMISSION33

8.6 CONDUCTED EMISSION TEST74

8.7 ANTENNA APPLICATION79

1 TEST RESULT CERTIFICATION

Applicant:	Micro Star International Co Ltd No. 69, Li-De Street, Zhonghe Dist., New Taipei, Taiwan
Manufacturer:	MSI ELECTRONICS (KUNSHAN) CO LTD No. 88 E QUANJIN RD KUNSHAN JIANGSU, CHINA
Product Description:	Tablet PC
Model Number:	MS-ND13
File Number:	ES150714157E3
Date of Test:	July 14, 2015 to July 31, 2015

Measurement Procedure Used:

APPLICABLE STANDARDS	
STANDARD	TEST RESULT
FCC 47 CFR Part 2, Subpart J:2014 FCC 47 CFR Part 15, Subpart C:2014	PASS

The above equipment was tested by SHENZHEN EMTEK CO., LTD. The test data, data evaluation, test procedures, and equipment configurations shown in this report were made in accordance with the procedures given in ANSI C63.10 (2013) and the energy emitted by the sample EUT tested as described in this report is in compliance with the requirements of FCC Rules Part 2 and Part 15.247

The test results of this report relate only to the tested sample identified in this report.

Date of Test : July 14, 2015 to July 31, 2015

Prepared by : 
Jie Yang/Editor

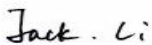
Reviewer : 
Jack Li/Supervisor

Approve & Authorized Signer : 
Lisa Wang/Manager

2 EUT TECHNICAL DESCRIPTION

Characteristics	Description
IEEE 802.11 WLAN Mode Supported:	<input checked="" type="checkbox"/> 802.11b(20MHz channel bandwidth) <input checked="" type="checkbox"/> 802.11g(20MHz channel bandwidth) <input checked="" type="checkbox"/> 802.11n(20MHz channel bandwidth) <input checked="" type="checkbox"/> 802.11n(40MHz channel bandwidth)
Data Rate:	802.11b:1,2,5.5,11Mbps; 802.11g:6,9,12,18,24,36,48,54Mbps; 802.11n(HT20):MCS0-MCS7; 802.11n(HT40):MCS0-MCS7;
Modulation:	DSSS with DBPSK/DQPSK/CCK for 802.11b; OFDM with BPSK/QPSK/16QAM/64QAM for 802.11g/n;
Operating Frequency Range:	2412-2462MHz for 802.11b/g; 2412-2462MHz for 802.11n(HT20); 2422-2452MHz for 802.11n(HT40);
Number of Channels:	11 channels for 802.11b/g; 11 channels for 802.11n(HT20); 7 channels for 802.11n(HT40);
Transmit Power Max:	13.80dBm for 802.11b; 17.17dBm for 802.11g; 17.47dBm for 802.11n(HT20); 18.03dBm for 802.11n(HT40);
Antenna Type:	PIFA Antenna
Antenna Gain:	1.89dBi
Power supply:	<input checked="" type="checkbox"/> DC supply: DC 3.7V internal rechargeable lithium battery or DC 12V from AC Adapter
	<input checked="" type="checkbox"/> Adapter supply: Model: ADP-18TB A INPUT: 100-240V~ 50/60Hz 0.6A OUTPUT: DC 12V 1.5A
Temperature Range:	0°C ~ +40°C
Product Software Version:	Windows 8.1
Product Hardware Version:	ND12_Z3735F_V1_2_MVT
Radio Software Version:	802.11b/g/n, Bluetooth
Radio Hardware Version:	RTL8723BS
RF power setting in TEST SW:	Software's default

Note: for more details, please refer to the User's manual of the EUT.

3 SUMMARY OF TEST RESULT

FCC Part Clause	Test Parameter	Verdict	Remark
15.247(a)(2)	DTS (6dB) Bandwidth	PASS	
15.247(b)(3)	Maximum Peak Conducted Output Power	PASS	
15.247(e)	Maximum Power Spectral Density Level	PASS	
15.247(d)	Unwanted Emission Into Non-Restricted Frequency Bands	PASS	
15.247(d) 15.209	Unwanted Emission Into Restricted Frequency Bands	PASS	
15.247(d) 15.209	Radiated Spurious Emission	PASS	
15.207	Conducted Emission Test	PASS	
15.247(b)	Antenna Application	PASS	
NOTE1: N/A (Not Applicable) NOTE2: According to FCC OET KDB 558074, the report use radiated measurements in the restricted frequency bands. In addition, the radiated test is also performed to ensure the emissions emanating from the device cabinet also comply with the applicable limits.			

4 TEST METHODOLOGY

4.1 GENERAL DESCRIPTION OF APPLIED STANDARDS

According to its specifications, the EUT must comply with the requirements of the following standards:

FCC 47 CFR Part 2, Subpart J

FCC 47 CFR Part 15, Subpart C

FCC KDB 558074 D01 DTS Meas Guidance v03r02

FCC KDB 662911 D01 Multiple Transmitter Output v01

FCC KDB 662911 D02 MIMO With Cross Polarized Antenna V01

4.2 MEASUREMENT EQUIPMENT USED

4.2.1 Conducted Emission Test Equipment

EQUIPMENT TYPE	MFR	MODEL NUMBER	SERIAL NUMBER	LAST CAL.
Test Receiver	Rohde & Schwarz	ESCS30	828985/018	05/16/2015
L.I.S.N.	Schwarzbeck	NNLK8129	8129203	05/16/2015
50Ω Coaxial Switch	Anritsu	MP59B	M20531	N/A
Pulse Limiter	Rohde & Schwarz	ESH3-Z2	100006	05/16/2015
Voltage Probe	Rohde & Schwarz	TK9416	N/A	05/16/2015
I.S.N	Rohde & Schwarz	ENY22	1109.9508.02	05/16/2015

4.2.2 Radiated Emission Test Equipment

EQUIPMENT TYPE	MFR	MODEL NUMBER	SERIAL NUMBER	LAST CAL.
EMI Test Receiver	Rohde & Schwarz	ESU	1302.6005.26	05/16/2015
Pre-Amplifier	HP	8447D	2944A07999	05/16/2015
Bilog Antenna	Schwarzbeck	VULB9163	142	05/16/2015
Loop Antenna	ARA	PLA-1030/B	1029	05/16/2015
Horn Antenna	Schwarzbeck	BBHA 9170	BBHA9170399	05/16/2015
Horn Antenna	Schwarzbeck	BBHA 9120	D143	05/16/2015
Cable	Schwarzbeck	AK9513	ACRX1	05/16/2015
Cable	Rosenberger	N/A	FP2RX2	05/16/2015
Cable	Schwarzbeck	AK9513	CRPX1	05/16/2015
Cable	Schwarzbeck	AK9513	CRRX2	05/16/2015

4.2.3 Radio Frequency Test Equipment

EQUIPMENT TYPE	MFR	MODEL NUMBER	SERIAL NUMBER	LAST CAL.
Spectrum Analyzer	Agilent	E4407B	88156318	05/16/2015
EMI Test Receiver	Rohde & Schwarz	FSV30	103040	05/16/2015
Signal Analyzer	Agilent	N9010A	My53470879	05/16/2015
Power meter	Anritsu	ML2495A	0824006	05/16/2015
Power sensor	Anritsu	MA2411B	0738172	05/16/2015

Remark: Each piece of equipment is scheduled for calibration once a year.

4.3 DESCRIPTION OF TEST MODES

The EUT has been tested under its typical operating condition.

The EUT configuration for testing is installed on RF field strength measurement to meet the Commissions requirement and operating in a manner which intends to maximize its emission characteristics in a continuous normal application.

The Transmitter was operated in the normal operating mode. The TX frequency was fixed which was for the purpose of the measurements.

Test of channel included the lowest and middle and highest frequency to perform the test, then record on this report.

Those data rates (802.11b: 1 Mbps; 802.11g: 6 Mbps; 802.11n (HT20): MCS0; 802.11n (HT40): MCS0) were used for all test.

Pre-defined engineering program for regulatory testing used to control the EUT for staying in continuous transmitting and receiving mode is programmed.

The EUT was pretested with 3 orientations placed on the table for the radiated emission measurement –X, Y, and Z-plane. The Y-plane results were found as the worst case and were shown in this report.

Frequency and Channel list for 802.11b/g/n (HT20):

Channel	Frequency (MHz)	Channel	Frequency (MHz)	Channel	Frequency (MHz)
1	2412	5	2432	9	2452
2	2417	6	2437	10	2457
3	2422	7	2442	11	2462
4	2427	8	2447		

Frequency and Channel list for 802.11n (HT40):

Channel	Frequency (MHz)	Channel	Frequency (MHz)	Channel	Frequency (MHz)
3	2422	5	2432	8	2447
4	2427	6	2437	9	2452
		7	2442		

Test Frequency and Channel for 802.11b/g/n (HT20):

Lowest Frequency		Middle Frequency		Highest Frequency	
Channel	Frequency (MHz)	Channel	Frequency (MHz)	Channel	Frequency (MHz)
1	2412	6	2437	11	2462

Test Frequency and channel for 802.11n (HT40):

Lowest Frequency		Middle Frequency		Highest Frequency	
Channel	Frequency (MHz)	Channel	Frequency (MHz)	Channel	Frequency (MHz)
3	2422	6	2437	9	2452

5 FACILITIES AND ACCREDITATIONS

5.1 FACILITIES

All measurement facilities used to collect the measurement data are located at

Bldg 69, Majialong Industry Zone District, Nanshan District, Shenzhen, China

The sites are constructed in conformance with the requirements of ANSI C63.7, ANSI C63.10 and CISPR Publication 22.

5.2 LABORATORY ACCREDITATIONS AND LISTINGS

Site Description

- EMC Lab.
- : Accredited by CNAS, 2013.10.29
The certificate is valid until 2016.10.28
The Laboratory has been assessed and proved to be in compliance with CNAS-CL01: 2006(identical to ISO/IEC17025: 2005)
The Certificate Registration Number is L2291
 - : Accredited by TUV Rheinland Shenzhen, 2010.5.25
The Laboratory has been assessed according to the requirements ISO/IEC 17025.
 - : Accredited by FCC, October 28, 2010
The Certificate Registration Number is 406365.
 - : Accredited by FCC, February 28, 2013
The Certificate Registration Number is 709623.
 - : Accredited by Industry Canada, May 24, 2008
The Certificate Registration Number is 4480A-2

6 TEST SYSTEM UNCERTAINTY

The following measurement uncertainty levels have been estimated for tests performed on the apparatus:

Parameter	Uncertainty
Radio Frequency	$\pm 1 \times 10^{-5}$
Maximum Peak Output Power Test	$\pm 1.0\text{dB}$
Conducted Emissions Test	$\pm 2.0\text{dB}$
Radiated Emission Test	$\pm 2.0\text{dB}$
Power Density	$\pm 2.0\text{dB}$
Occupied Bandwidth Test	$\pm 1.0\text{dB}$
Band Edge Test	$\pm 3\text{dB}$
All emission, radiated	$\pm 3\text{dB}$
Antenna Port Emission	$\pm 3\text{dB}$
Temperature	$\pm 0.5^\circ\text{C}$
Humidity	$\pm 3\%$

Measurement Uncertainty for a level of Confidence of 95%

7 SETUP OF EQUIPMENT UNDER TEST

7.1 RADIO FREQUENCY TEST SETUP 1

The WLAN component's antenna ports(s) of the EUT are connected to the measurement instrument per an appropriate attenuator. The EUT is controlled by PC/software to emit the specified signals for the purpose of measurements.

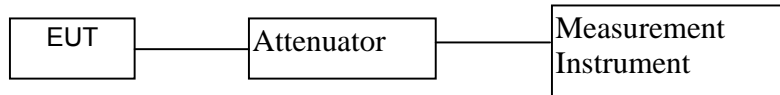

7.2 RADIO FREQUENCY TEST SETUP 2

The test site semi-anechoic chamber has met the requirement of NSA tolerance 4 dB according to the standards: ANSI C63.10. The test distance is 3m. The setup is according to the requirements in Section 13.1.4.1 of ANSI C63.10-2013 and CAN/CSA-CEI/IEC CISPR 22.

The maximal emission value is acquired by adjusting the antenna height, polarisation and turntable azimuth. Normally, the height range of antenna is 1 m to 4 m, the azimuth range of turntable is 0° to 360°, and the receive antenna has two polarizations Vertical (V) and Horizontal (H).

(a) Radiated Emission Test Set-Up, Frequency Below 30MHz

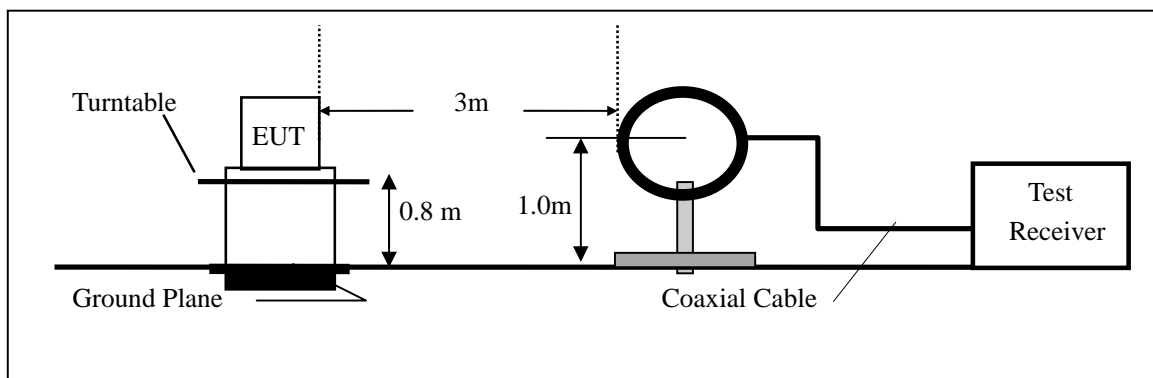

(b) Radiated Emission Test Set-Up, Frequency Below 1000MHz

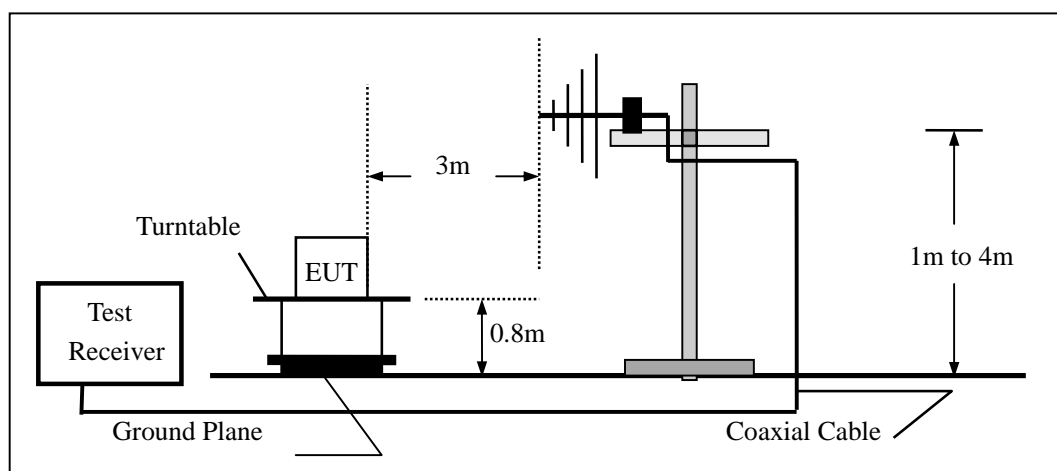

(c) Radiated Emission Test Set-Up, Frequency above 1000MHz

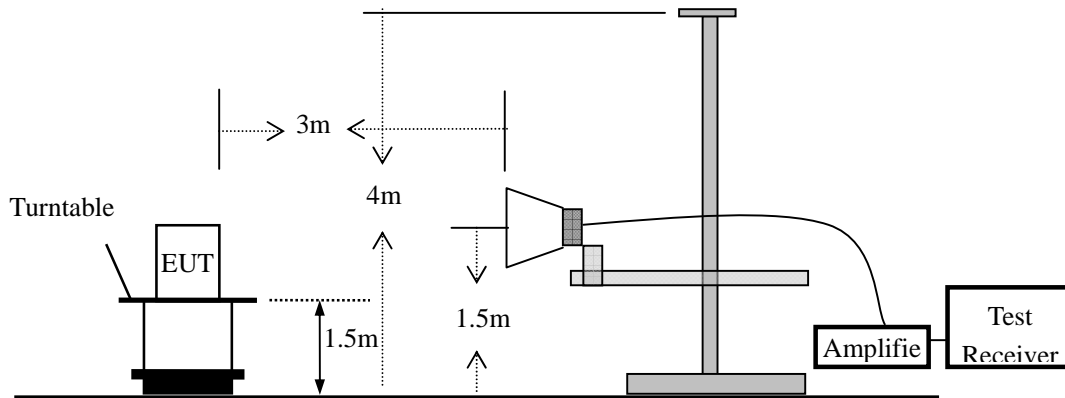

7.3 CONDUCTED EMISSION TEST SETUP

The mains cable of the EUT (Tablet PC) must be connected to LISN. The LISN shall be placed 0.8 m from the boundary of EUT and bonded to a ground reference plane for LISN mounted on top of the ground reference plane. This distance is between the closest points of the LISN and the EUT. All other units of the EUT and associated equipment shall be at least 0.8m from the LISN.

Ground connections, where required for safety purposes, shall be connected to the reference ground point of the LISN and, where not otherwise provided or specified by the manufacturer, shall be of same length as the mains cable and run parallel to the mains connection at a separation distance of not more than 0.1 m.

According to the requirements in Section 13.1.4.1 of ANSI C63.10-2013 Conducted emissions from the EUT measured in the frequency range between 0.15 MHz and 30 MHz using CISPR Quasi-Peak and average detector mode.

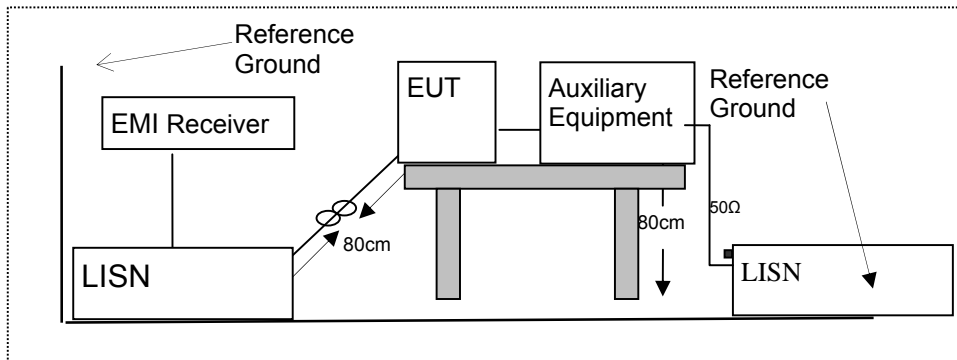

7.4 SUPPORT EQUIPMENT

Item	Equipment	Mfr/Brand	Model/Type No.	Series No.	Note

Notes:

1. All the equipment/cables were placed in the worst-case configuration to maximize the emission during the test.
2. Grounding was established in accordance with the manufacturer's requirements and conditions for the intended use.

8 TEST REQUIREMENTS

8.1 DTS (6DB) BANDWIDTH

8.1.1 Applicable Standard

According to FCC Part 15.247(a)(2) and KDB 558074 DTS 01 Meas. Guidance v03r02

8.1.2 Conformance Limit

The minimum -6 dB bandwidth shall be at least 500 kHz.

8.1.3 Test Configuration

Test according to clause 7.1 radio frequency test setup 1

8.1.4 Test Procedure

The EUT was operating in IEEE 802.11b/g/n mode and controlled its channel. Printed out the test result from the spectrum by hard copy function.

The RF output of EUT was connected to the spectrum analyzer by RF cable and attenuator. The path loss was compensated to the results for each measurement.

Set to the maximum power setting and enable the EUT transmit continuously

Set RBW = 100 kHz.

Set the video bandwidth (VBW) =300 kHz.

Set Span=2 times OBW

Set Detector = Peak.

Set Trace mode = max hold.

Set Sweep = auto couple.

Allow the trace to stabilize.

Measure the maximum width of the emission that is constrained by the frequencies associated with the two outermost amplitude points (upper and lower frequencies) that are attenuated by 6 dB relative to the maximum level measured in the fundamental emission.

Measure and record the results in the test report.

8.1.5 Test Results

Temperature: 24°C
Humidity: 53 %

Test Date: July 21, 2015
Test By: KING KONG

Operation Mode	Channel Number	Channel Frequency (MHz)	Measurement Bandwidth (MHz)	Limit (kHz)	Verdict
802.11b	1	2412	10.08	>500	PASS
	6	2437	10.10	>500	PASS
	11	2462	10.09	>500	PASS
802.11g	1	2412	16.48	>500	PASS
	6	2437	16.49	>500	PASS
	11	2462	16.50	>500	PASS
802.11n (HT20)	1	2412	17.72	>500	PASS
	6	2437	17.75	>500	PASS
	11	2462	17.71	>500	PASS
802.11n (HT40)	3	2422	36.32	>500	PASS
	6	2437	36.39	>500	PASS
	9	2452	36.32	>500	PASS

Test Model	DTS (6dB) Bandwidth
	802.11b
	Channel 1: 2412MHz

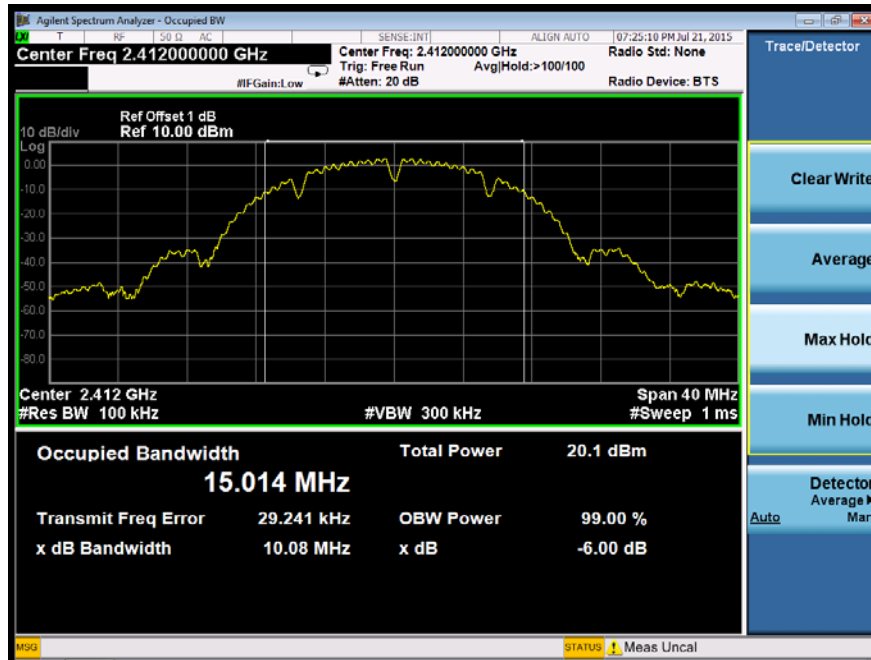

Test Model	DTS (6dB) Bandwidth
	802.11b
	Channel 6: 2437MHz



Test Model	DTS (6dB) Bandwidth
	802.11b
	Channel 11: 2462MHz

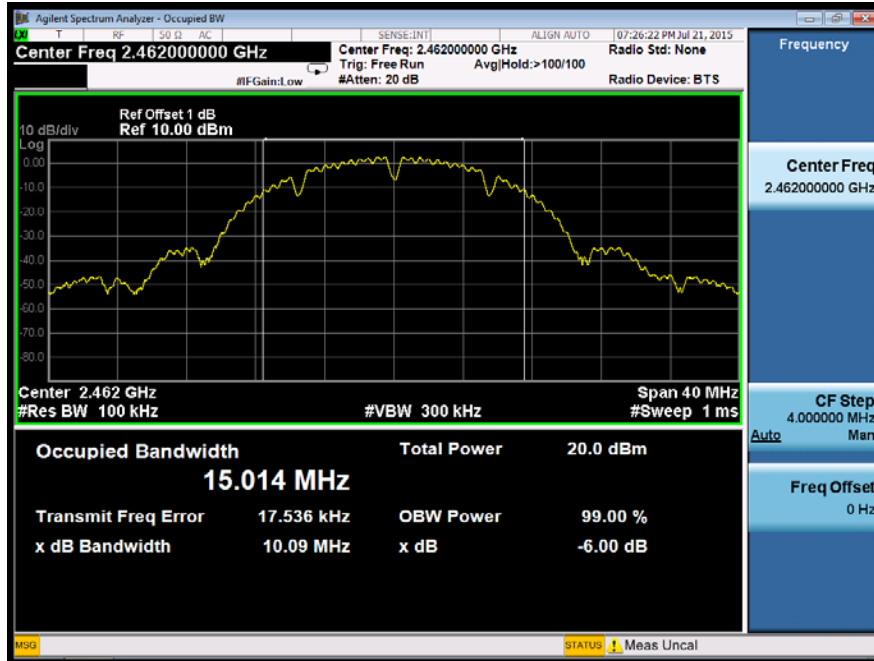

Test Model	DTS (6dB) Bandwidth
	802.11g
	Channel 1: 2412MHz

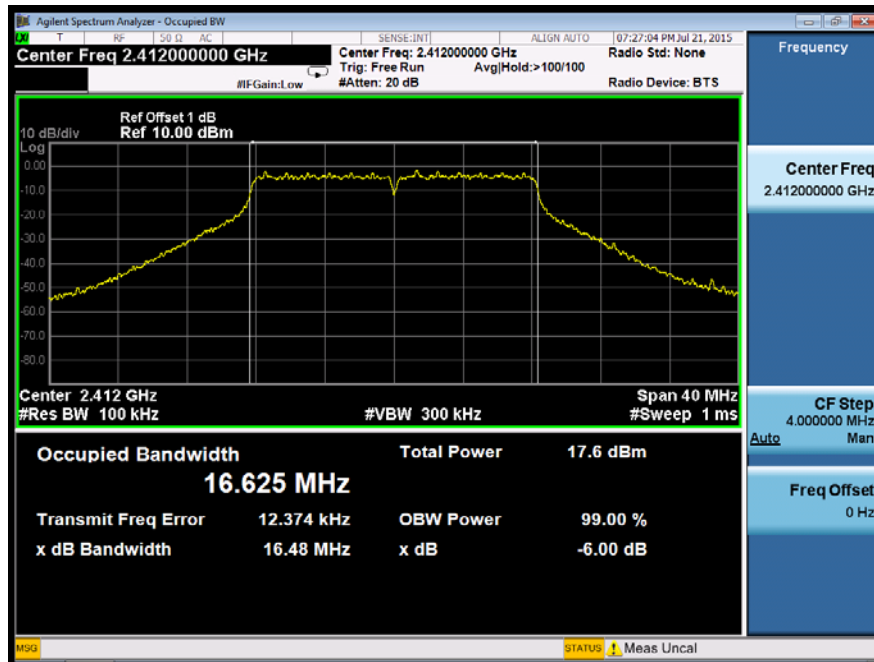

Test Model	DTS (6dB) Bandwidth
	802.11g
	Channel 6: 2437MHz

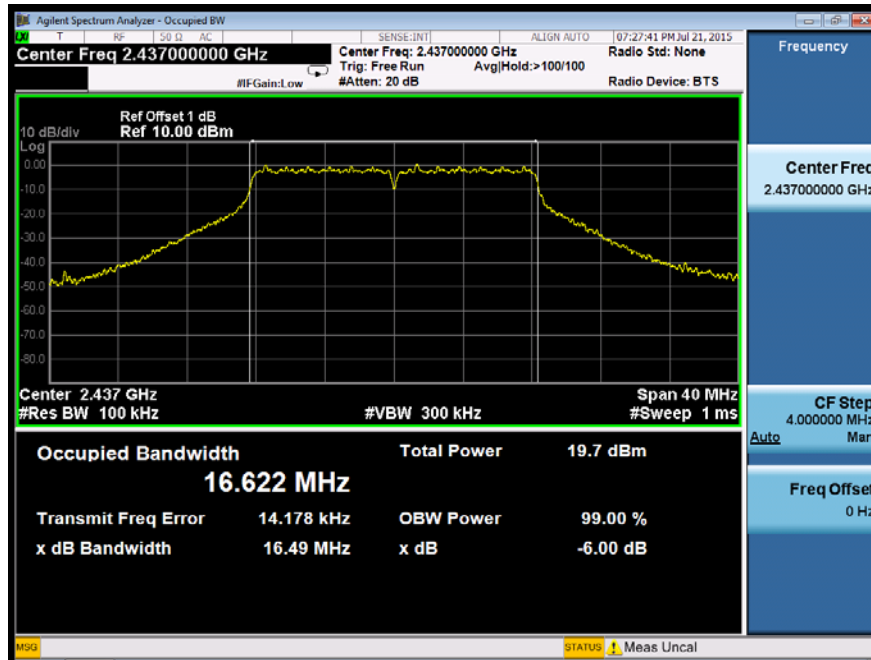

Test Model	DTS (6dB) Bandwidth
	802.11g
	Channel 11: 2462MHz

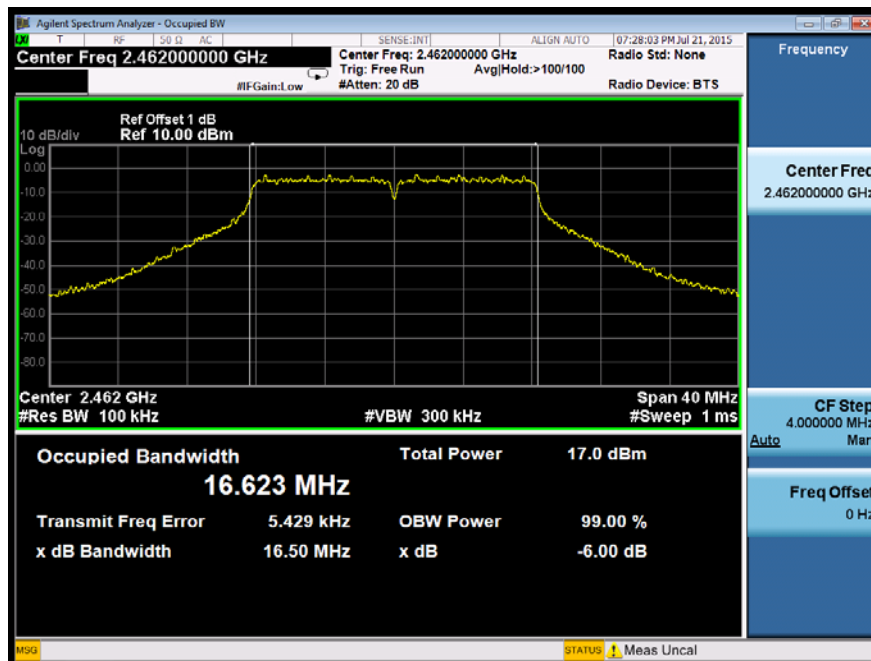

Test Model	DTS (6dB) Bandwidth
	802.11n (HT20)
	Channel 1: 2412MHz



Test Model	DTS (6dB) Bandwidth
	802.11n (HT20)
	Channel 6: 2437MHz

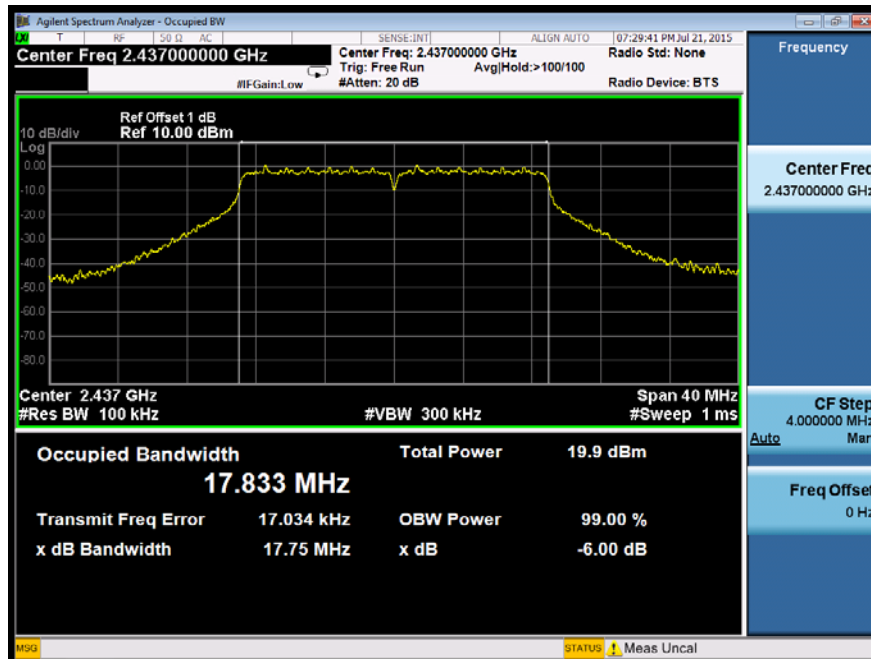

Test Model	DTS (6dB) Bandwidth
	802.11n (HT20)
	Channel 11: 2462MHz

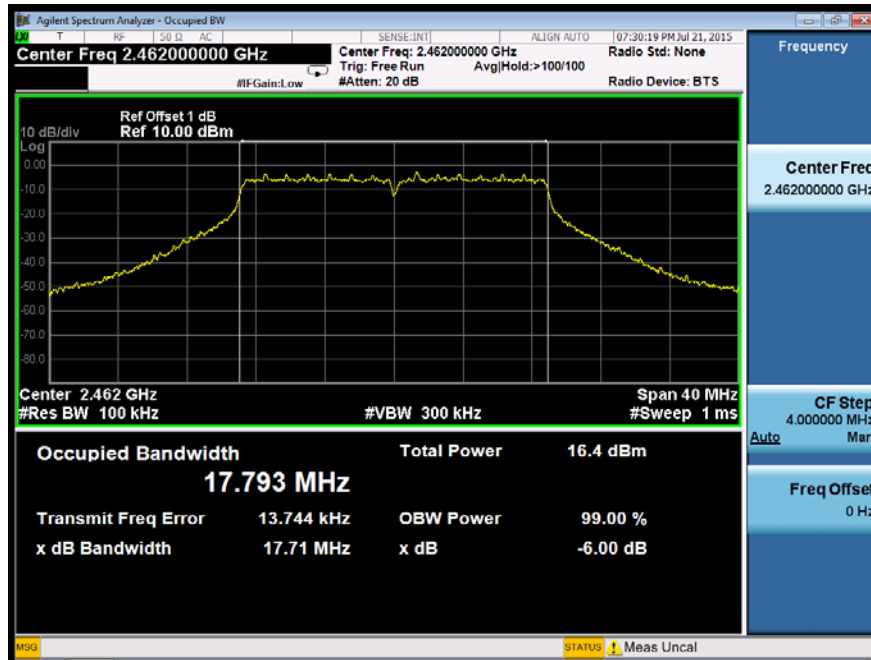

Test Model	DTS (6dB) Bandwidth
	802.11n (HT40)
	Channel 3: 2422MHz

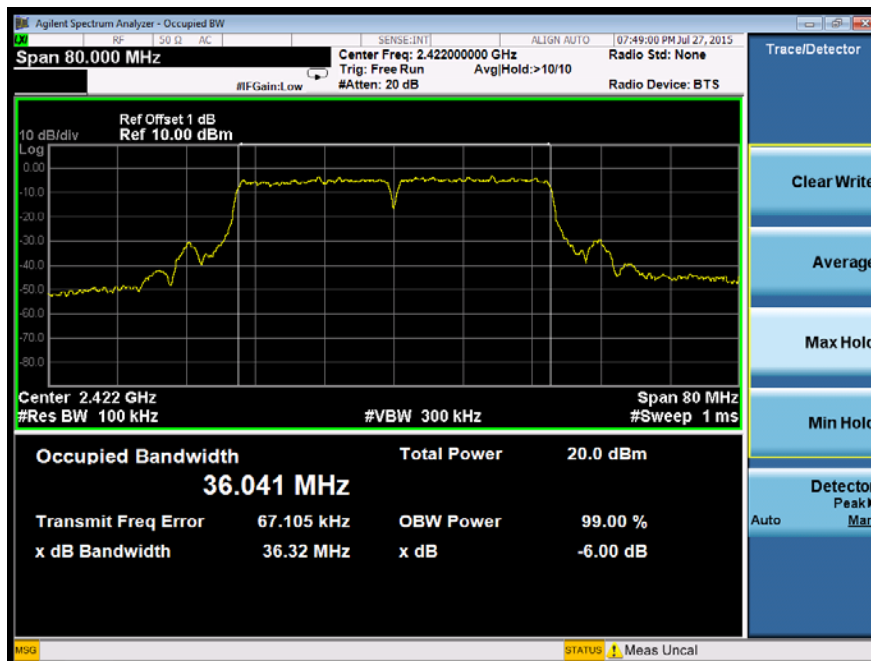

Test Model	DTS (6dB) Bandwidth
	802.11n (HT40)
	Channel 6: 2437MHz

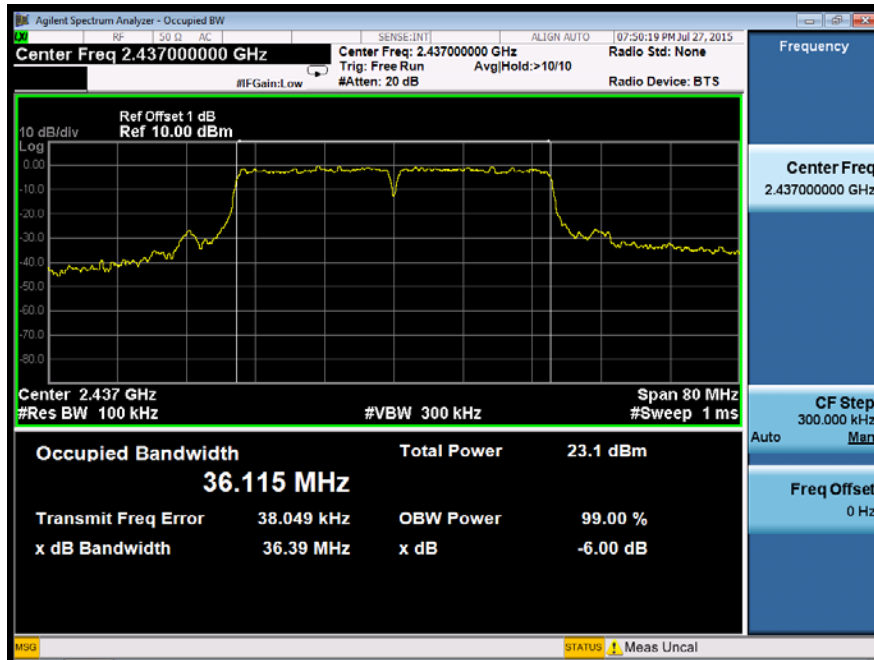

Test Model	DTS (6dB) Bandwidth
	802.11n (HT40)
	Channel 9: 2452MHz

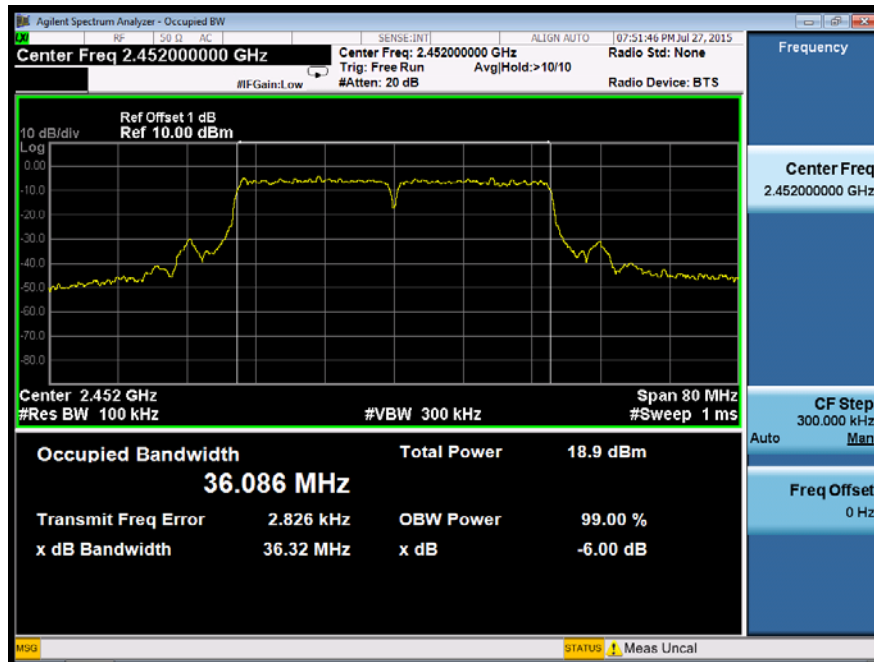

8.3 MAXIMUM POWER SPECTRAL DENSITY

8.3.1 Applicable Standard

According to FCC Part 15.247(e) and KDB 558074 DTS 01 Meas. Guidance v03r02

8.3.2 Conformance Limit

The transmitter power spectral density conducted from the transmitter to the antenna shall not be greater than 8 dBm in any 3 kHz band during any time interval of continuous transmission.

8.3.3 Test Configuration

Test according to clause 7.1 radio frequency test setup 1

8.3.4 Test Procedure

This procedure shall be used if maximum peak conducted output power was used to demonstrate compliance

The transmitter output (antenna port) was connected to the spectrum analyzer

Set analyzer center frequency to DTS channel center frequency.

Set the span to 1.5 times the DTS bandwidth.

Set the RBW to: 3 kHz

Set the VBW to: 10 kHz.

Set Detector = peak.

Set Sweep time = auto couple.

Set Trace mode = max hold.

Allow trace to fully stabilize.

Use the peak marker function to determine the maximum amplitude level within the RBW.

8.3.5 Test Results

Temperature: 24°C
Humidity: 53 %

Test Date: July 21, 2015
Test By: KING KONG

Operation Mode	Channel Number	Channel Frequency (MHz)	Measurement Level (dBm/3kHz)	Limit (dBm/3kHz)	Verdict
802.11b	1	2412	-18.753	8	PASS
	6	2437	-18.950	8	PASS
	11	2462	-19.067	8	PASS
802.11g	1	2412	-19.067	8	PASS
	6	2437	-18.340	8	PASS
	11	2462	-19.203	8	PASS
802.11n (HT20)	1	2412	-19.433	8	PASS
	6	2437	-18.343	8	PASS
	11	2462	-19.477	8	PASS
802.11n (HT40)	3	2422	-19.512	8	PASS
	6	2437	-16.409	8	PASS
	9	2452	-20.218	8	PASS
Note: N/A					

Test Model	Power Spectral Density
	802.11b
	Channel 1: 2412MHz



Test Model	Power Spectral Density
	802.11b
	Channel 6: 2437MHz



Test Model	Power Spectral Density
	802.11b
	Channel 11: 2462MHz



Test Model	Power Spectral Density
	802.11g
	Channel 1: 2412MHz

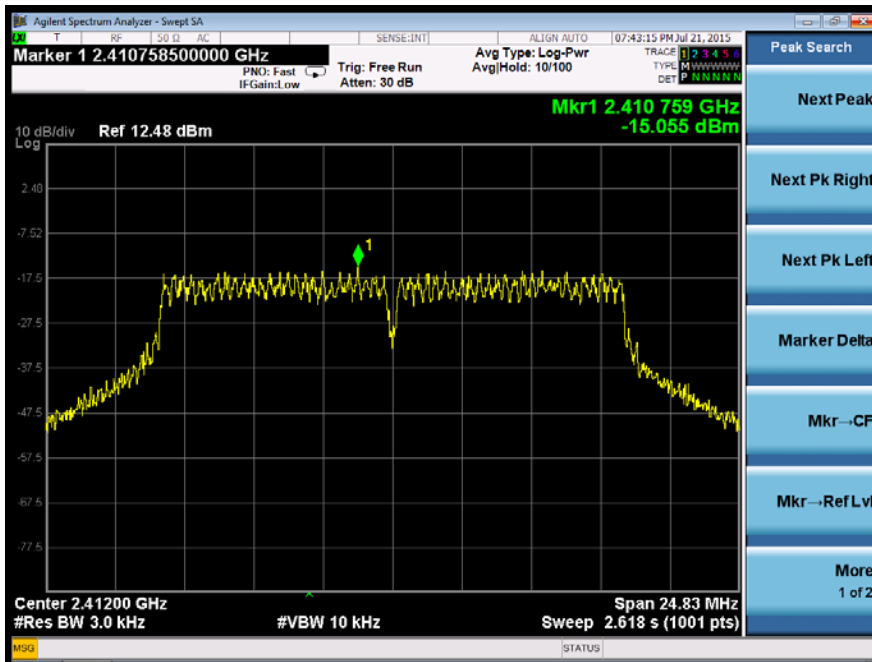

Test Model	Power Spectral Density
	802.11g
	Channel 6: 2437MHz

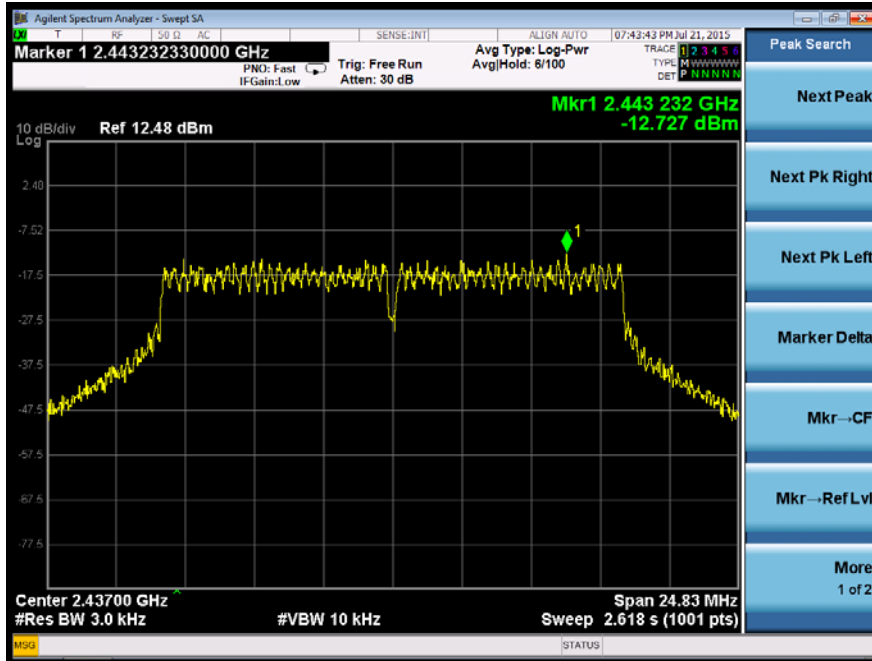

Test Model	Power Spectral Density
	802.11g
	Channel 11: 2462MHz

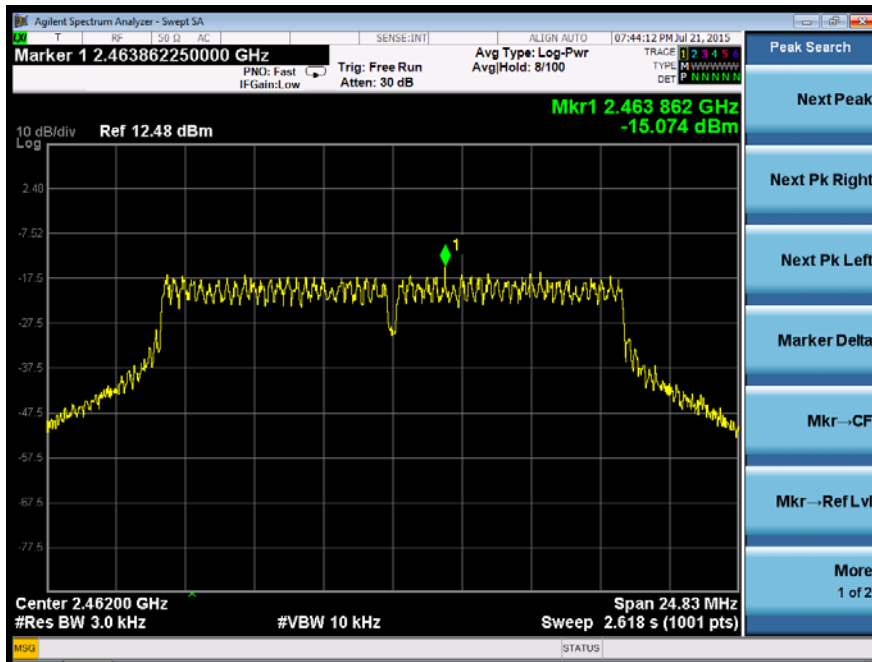

Test Model	Power Spectral Density
	802.11n (HT20)
	Channel 1: 2412MHz

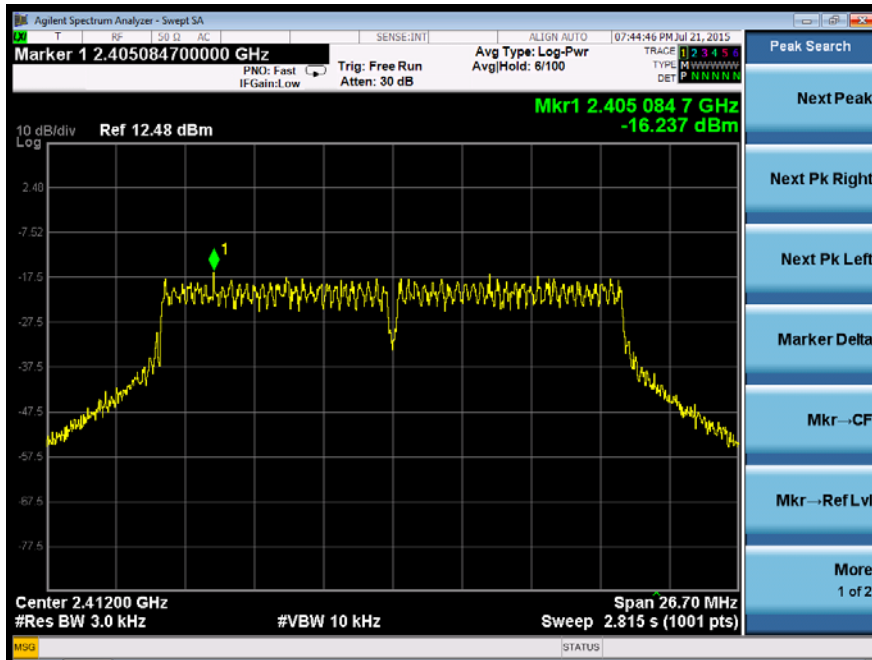

Test Model	Power Spectral Density
	802.11n (HT20)
	Channel 6: 2437MHz

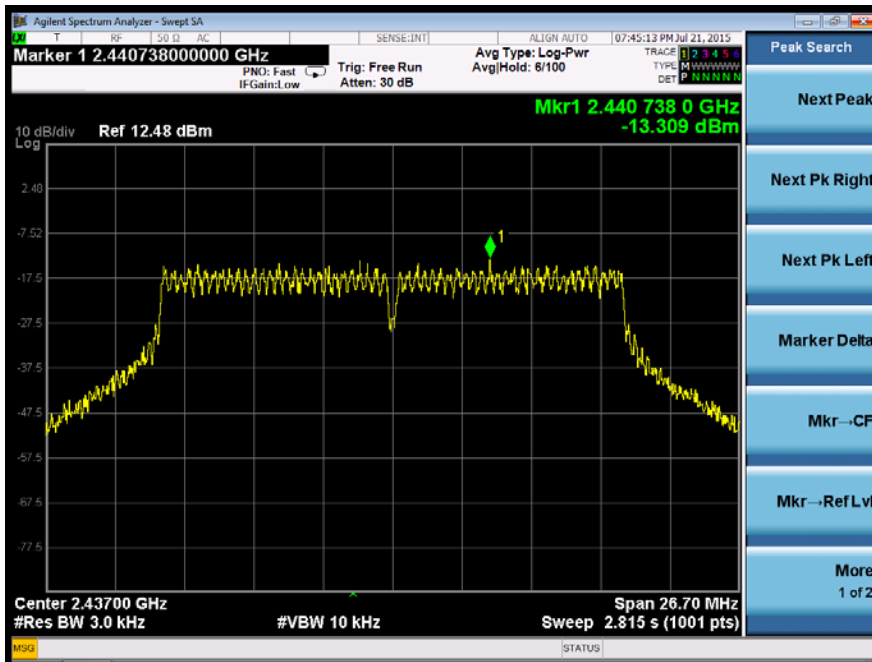

Test Model	Power Spectral Density
	802.11n (HT20)
	Channel 11: 2462MHz

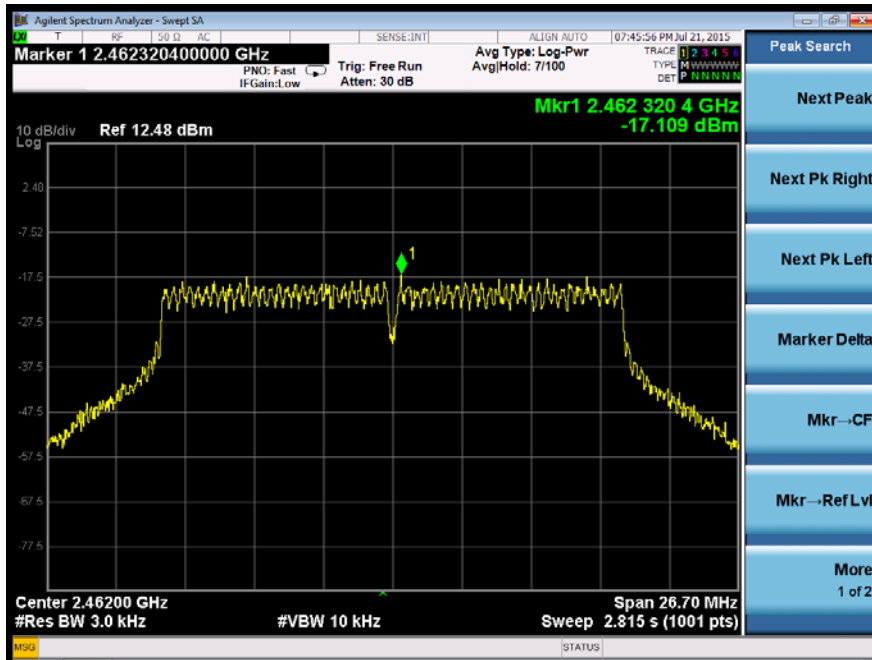

Test Model	Power Spectral Density
	802.11n (HT40)
	Channel 3: 2422MHz

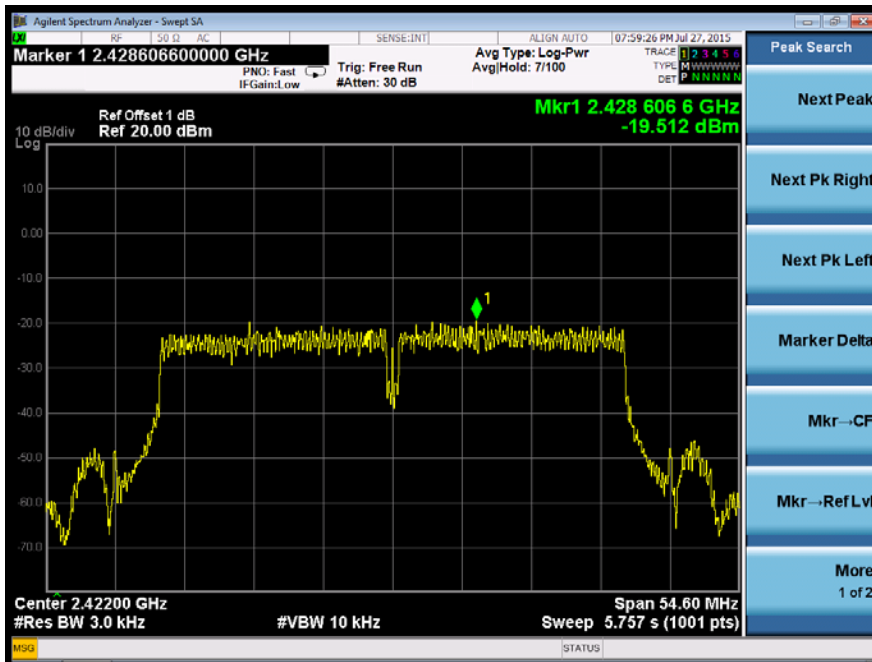

Test Model	Power Spectral Density
	802.11n (HT40)
	Channel 6: 2437MHz

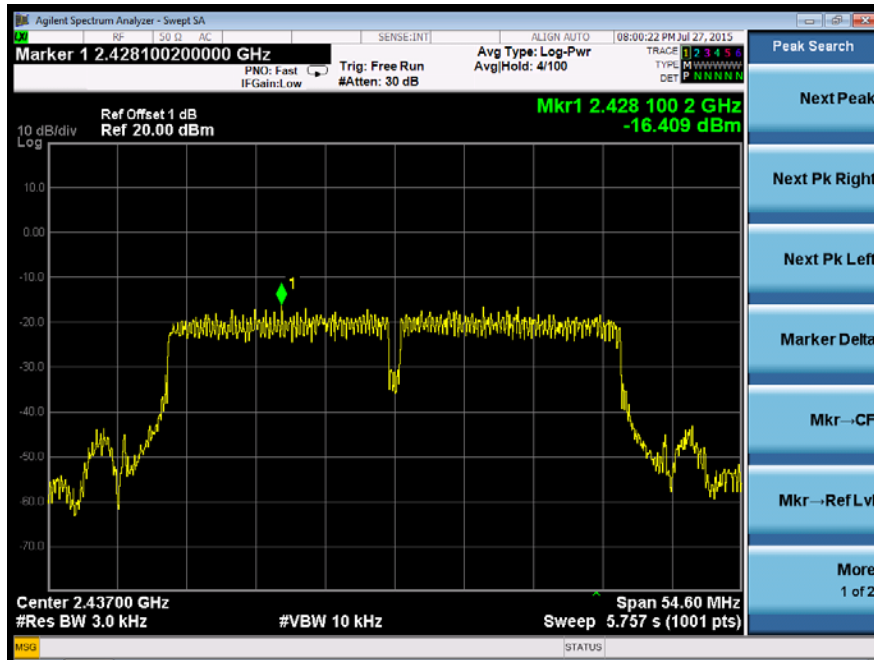

Test Model	Power Spectral Density
	802.11n (HT40)
	Channel 9: 2452MHz

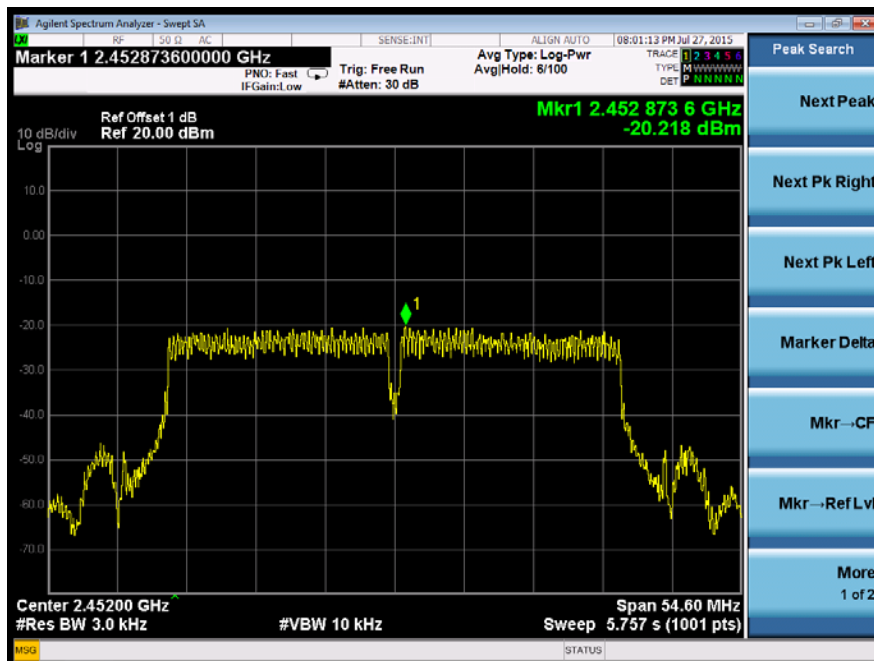

8.4 UNWANTED EMISSIONS INTO NON-RESTRICTED FREQUENCY BANDS

8.4.1 Applicable Standard

According to FCC Part 15.247(d) and KDB 558074 DTS 01 Meas. Guidance v03r02

8.4.2 Conformance Limit

According to FCC Part 15.247(d):

In any 100 kHz bandwidth outside the frequency band in which the spread spectrum or digitally modulated intentional radiator is operating, the radio frequency power that is produced by the intentional radiator shall be at least 20 dB below that in the 100 kHz bandwidth within the band that contains the highest level of the desired power, based on either an RF conducted or a radiated measurement, provided the transmitter demonstrates compliance with the peak conducted power limits. If the transmitter complies with the conducted power limits based on the use of RMS averaging over a time interval, as permitted under paragraph (b)(3) of this section, the attenuation required under this paragraph shall be 30 dB instead of 20 dB.

8.4.3 Test Configuration

Test according to clause 7.1 radio frequency test setup 1

8.4.4 Test Procedure

The transmitter output (antenna port) was connected to the spectrum analyzer

■ Reference level measurement

Establish a reference level by using the following procedure:

Set instrument center frequency to DTS channel center frequency.

Set the span to ≥ 1.5 times the DTS bandwidth.

Set the RBW = 100 kHz.

Set the VBW $\geq 3 \times$ RBW.

Set Detector = peak.

Set Sweep time = auto couple.

Set Trace mode = max hold.

Allow trace to fully stabilize.

Use the peak marker function to determine the maximum PSD level.

Note that the channel found to contain the maximum PSD level can be used to establish the reference level.

■ Emission level measurement

Set the center frequency and span to encompass frequency range to be measured.

Set the RBW = 100 kHz.

Set the VBW = 300 kHz.

Set Detector = peak

Sweep time = auto couple.

Trace mode = max hold.

Allow trace to fully stabilize.

Use the peak marker function to determine the maximum amplitude level.

Ensure that the amplitude of all unwanted emissions outside of the authorized frequency band (excluding restricted frequency bands) are attenuated by at least the minimum requirements. Report the three highest emissions relative to the limit.

8.4.5 Test Results

All the modulation modes were tested, the data of the worst mode(802.11b) are described in the following table

Test Model	Unwanted Emissions in non-restricted frequency bands
	802.11b
	Channel 1: 2412MHz

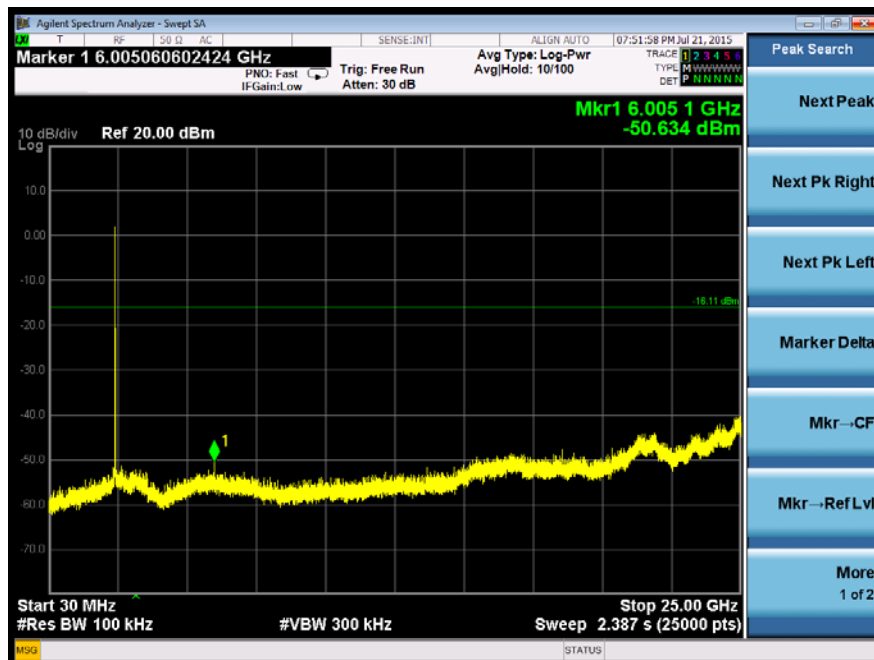
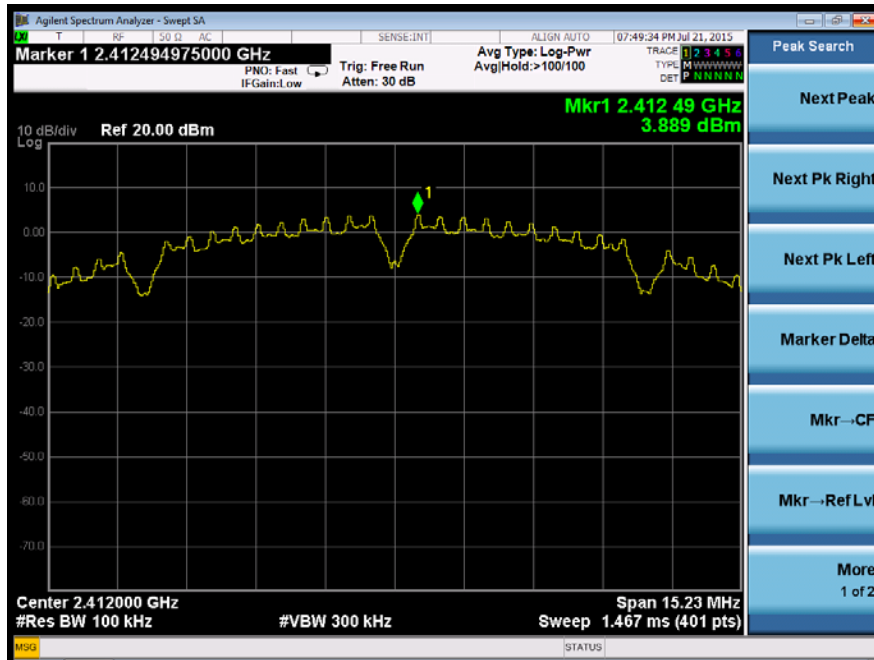

Test Model	Unwanted Emissions in non-restricted frequency bands
	802.11b
	Channel 6: 2437MHz

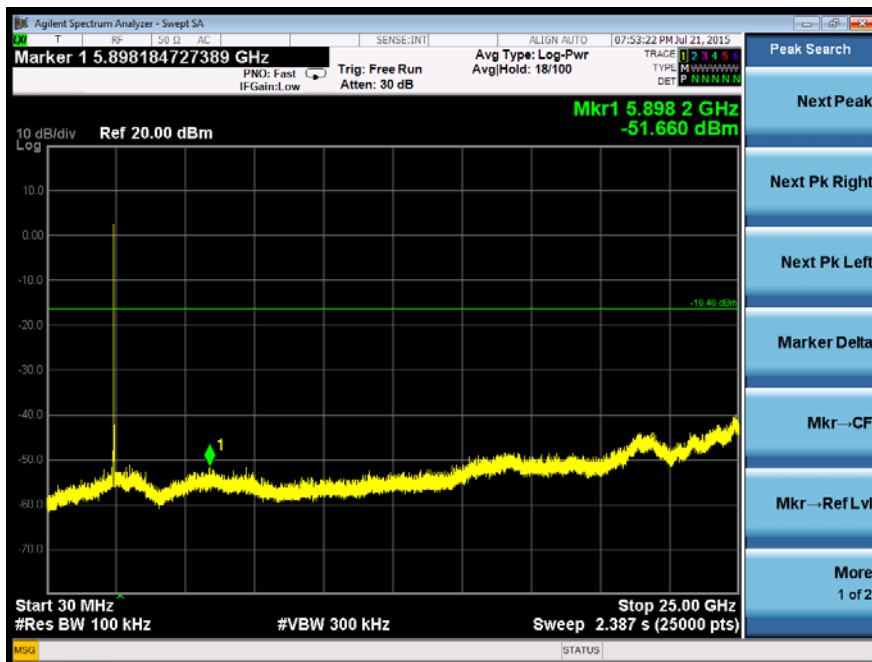
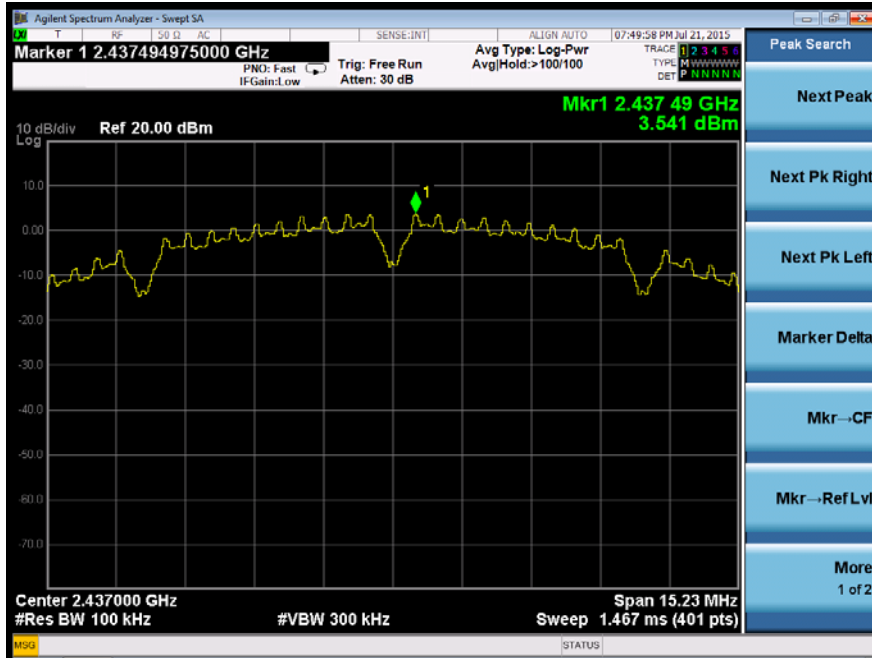

Test Model	Unwanted Emissions in non-restricted frequency bands
	802.11b
	Channel 9: 2462MHz

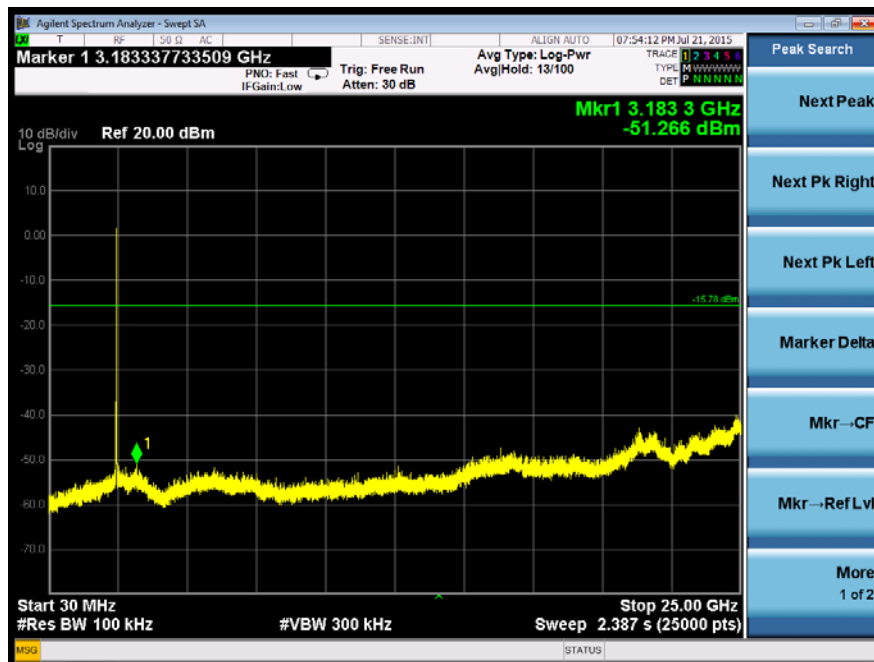

Test Model	Band edge
	802.11b
	Channel 1: 2412MHz



Test Model	Band edge
	802.11b
	Channel 11: 2462MHz

