

DASY5 Validation Report for Head TSL

Date: 19.06.2018

Test Laboratory: SPEAG, Zurich, Switzerland

DUT: Dipole 2600 MHz; Type: D2600V2; Serial: D2600V2 - SN:1058

Communication System: UID 0 - CW; Frequency: 2600 MHz

Medium parameters used: $f = 2600$ MHz; $\sigma = 2.03$ S/m; $\epsilon_r = 37.4$; $\rho = 1000$ kg/m³

Phantom section: Flat Section

Measurement Standard: DASY5 (IEEE/IEC/ANSI C63.19-2011)

DASY52 Configuration:

- Probe: EX3DV4 - SN7349; ConvF(7.7, 7.7, 7.7) @ 2600 MHz; Calibrated: 30.12.2017
- Sensor-Surface: 1.4mm (Mechanical Surface Detection)
- Electronics: DAE4 Sn601; Calibrated: 26.10.2017
- Phantom: Flat Phantom 5.0 (front); Type: QD 000 P50 AA; Serial: 1001
- DASY52 52.10.1(1476); SEMCAD X 14.6.11(7439)

Dipole Calibration for Head Tissue/Pin=250 mW, d=10mm/Zoom Scan (7x7x7)/Cube 0:

Measurement grid: dx=5mm, dy=5mm, dz=5mm

Reference Value = 117.8 V/m; Power Drift = -0.05 dB

Peak SAR (extrapolated) = 28.5 W/kg

SAR(1 g) = 14.3 W/kg; SAR(10 g) = 6.38 W/kg

Maximum value of SAR (measured) = 23.8 W/kg

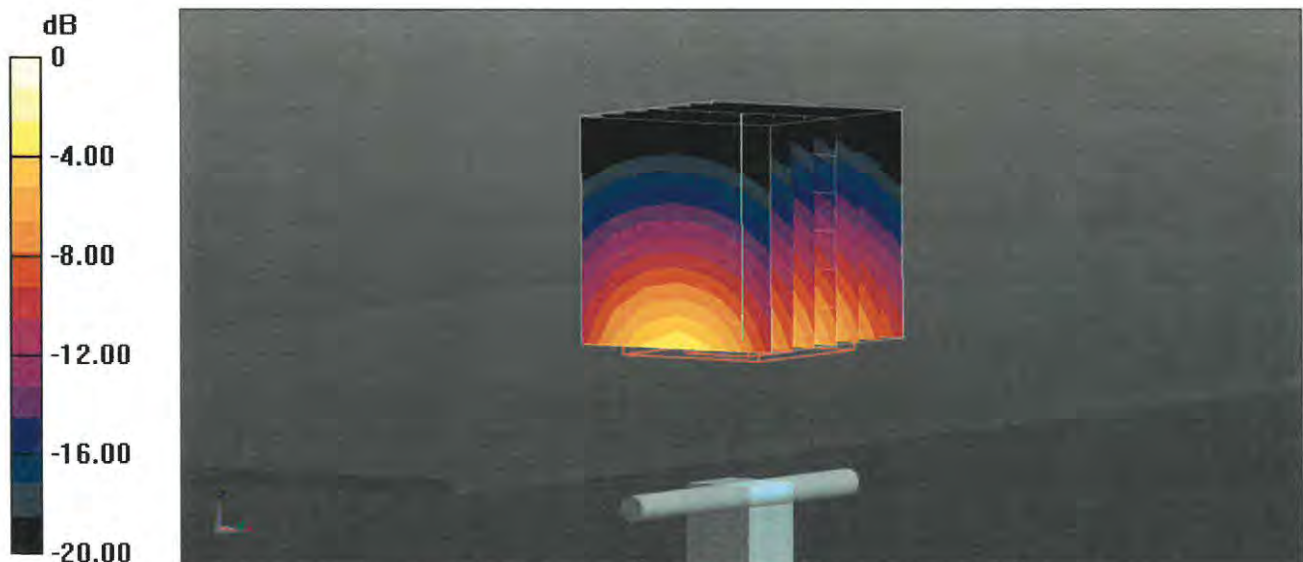

Impedance Measurement Plot for Head TSL

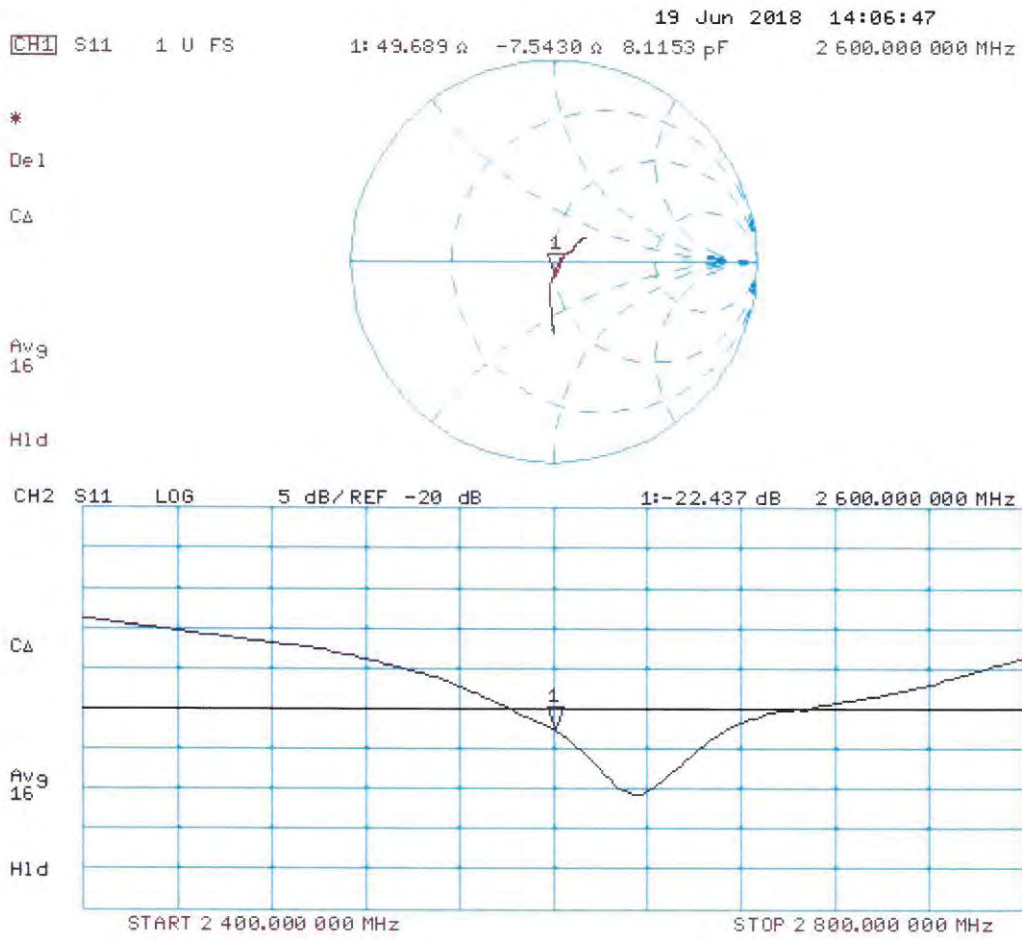

DASY5 Validation Report for Body TSL

Date: 19.06.2018

Test Laboratory: SPEAG, Zurich, Switzerland

DUT: Dipole 2600 MHz; Type: D2600V2; Serial: D2600V2 - SN:1058

Communication System: UID 0 - CW; Frequency: 2600 MHz

Medium parameters used: $f = 2600$ MHz; $\sigma = 2.22$ S/m; $\epsilon_r = 51.8$; $\rho = 1000$ kg/m³

Phantom section: Flat Section

Measurement Standard: DASY5 (IEEE/IEC/ANSI C63.19-2011)

DASY52 Configuration:

- Probe: EX3DV4 - SN7349; ConvF(7.81, 7.81, 7.81) @ 2600 MHz; Calibrated: 30.12.2017
- Sensor-Surface: 1.4mm (Mechanical Surface Detection)
- Electronics: DAE4 Sn601; Calibrated: 26.10.2017
- Phantom: Flat Phantom 5.0 (back); Type: QD 000 P50 AA; Serial: 1002
- DASY52 52.10.1(1476); SEMCAD X 14.6.11(7439)

Dipole Calibration for Body Tissue/Pin=250 mW, d=10mm/Zoom Scan (7x7x7)/Cube 0:

Measurement grid: dx=5mm, dy=5mm, dz=5mm

Reference Value = 107.8 V/m; Power Drift = -0.02 dB

Peak SAR (extrapolated) = 28.0 W/kg

SAR(1 g) = 13.8 W/kg; SAR(10 g) = 6.15 W/kg

Maximum value of SAR (measured) = 23.1 W/kg

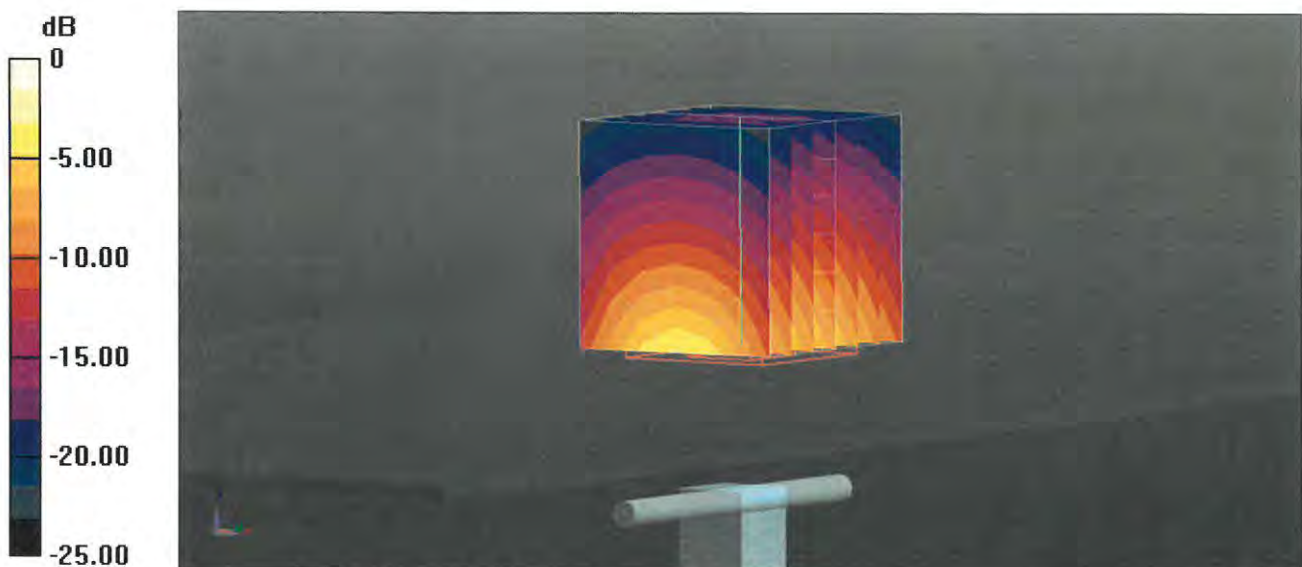

0 dB = 23.1 W/kg = 13.64 dBW/kg

Impedance Measurement Plot for Body TSL

19 Jun 2018 10:09:42
[CH1] S11 1 U FS 1: 45.258 Ω -6.9160 Ω 8.8510 pF 2 600.000 000 MHz

*
De1

CA

Avg
16

H1d

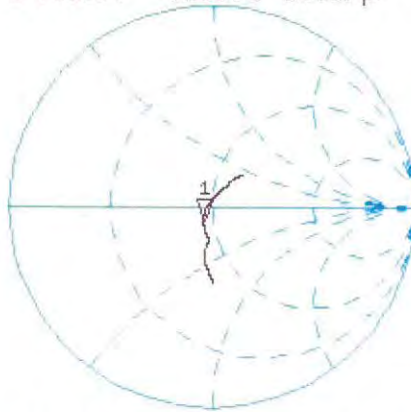

CH2 S11 LOG 5 dB/REF -20 dB 1:-21.129 dB 2 600.000 000 MHz

CA

Avg
16

H1d

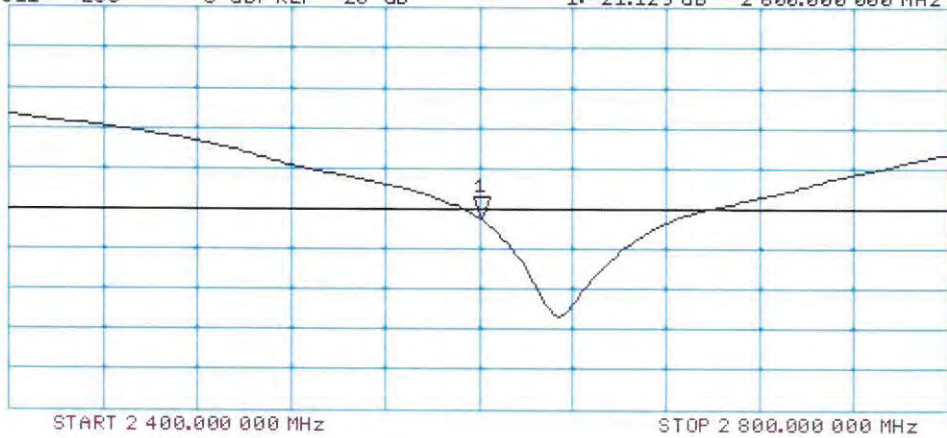



In Collaboration with
s p e a g
CALIBRATION LABORATORY



中国认可
国际互认
校准
CALIBRATION
CNAS L0570

Add: No.51 Xueyuan Road, Haidian District, Beijing, 100191, China
Tel: +86-10-62304633-2218 Fax: +86-10-62304633-2209
E-mail: cttl@chinattl.com [Http://www.chinattl.cn](http://www.chinattl.cn)

Client : **Emtek(Shenzhen)**

Certificate No: **Z17-97194**

CALIBRATION CERTIFICATE

Object **DAE4 - SN: 1418**

Calibration Procedure(s) **FF-Z11-002-01**
Calibration Procedure for the Data Acquisition Electronics (DAEx)

Calibration date: **October 09, 2017**

This calibration Certificate documents the traceability to national standards, which realize the physical units of measurements(SI). The measurements and the uncertainties with confidence probability are given on the following pages and are part of the certificate.

All calibrations have been conducted in the closed laboratory facility: environment temperature(22±3)°C and humidity<70%.

Calibration Equipment used (M&TE critical for calibration)

Primary Standards	ID #	Cal Date(Calibrated by, Certificate No.)	Scheduled Calibration
Process Calibrator 753	1971018	27-Jun-17 (CTTL, No.J17X05859)	June-18

	Name	Function	Signature
Calibrated by:	Yu Zongying	SAR Test Engineer	
Reviewed by:	Lin Hao	SAR Test Engineer	
Approved by:	Qi Dianyuan	SAR Project Leader	

Issued: October 09, 2017

This calibration certificate shall not be reproduced except in full without written approval of the laboratory.



In Collaboration with

s p e a g

CALIBRATION LABORATORY

Add: No.51 Xueyuan Road, Haidian District, Beijing, 100191, China

Tel: +86-10-62304633-2218

Fax: +86-10-62304633-2209

E-mail: cttl@chinattl.com

[Http://www.chinattl.cn](http://www.chinattl.cn)

Glossary:

DAE data acquisition electronics
Connector angle information used in DASY system to align probe sensor X
to the robot coordinate system.

Methods Applied and Interpretation of Parameters:

- *DC Voltage Measurement:* Calibration Factor assessed for use in DASY system by comparison with a calibrated instrument traceable to national standards. The figure given corresponds to the full scale range of the voltmeter in the respective range.
- *Connector angle:* The angle of the connector is assessed measuring the angle mechanically by a tool inserted. Uncertainty is not required.
- The report provide only calibration results for DAE, it does not contain other performance test results.



Add: No.51 Xueyuan Road, Haidian District, Beijing, 100191, China
 Tel: +86-10-62304633-2218 Fax: +86-10-62304633-2209
 E-mail: cttl@chinattl.com Http://www.chinattl.cn

DC Voltage Measurement

A/D - Converter Resolution nominal

High Range: 1LSB = 6.1μV, full range = -100...+300 mV
 Low Range: 1LSB = 61nV, full range = -1.....+3mV

DASY measurement parameters: Auto Zero Time: 3 sec; Measuring time: 3 sec

Calibration Factors	X	Y	Z
High Range	404.125 ± 0.15% (k=2)	404.667 ± 0.15% (k=2)	404.348 ± 0.15% (k=2)
Low Range	3.98970 ± 0.7% (k=2)	4.00074 ± 0.7% (k=2)	3.97649 ± 0.7% (k=2)

Connector Angle

Connector Angle to be used in DASY system	153° ± 1 °
---	------------



In Collaboration with
s p e a g
CALIBRATION LABORATORY



中国认可
国际互认
校准
CALIBRATION
CNAS L0570

Add: No.51 Xueyuan Road, Haidian District, Beijing, 100191, China
Tel: +86-10-62304633-2218 Fax: +86-10-62304633-2209
E-mail: cttl@chinattl.com [Http://www.chinattl.cn](http://www.chinattl.cn)

Client **Emtek(Shenzhen)**

Certificate No: **Z17-97195**

CALIBRATION CERTIFICATE

Object **EX3DV4 - SN:3970**

Calibration Procedure(s) **FF-Z11-004-01**
Calibration Procedures for Dosimetric E-field Probes

Calibration date: **November 02, 2017**

This calibration Certificate documents the traceability to national standards, which realize the physical units of measurements(SI). The measurements and the uncertainties with confidence probability are given on the following pages and are part of the certificate.

All calibrations have been conducted in the closed laboratory facility: environment temperature(22±3)°C and humidity<70%.

Calibration Equipment used (M&TE critical for calibration)

Primary Standards	ID #	Cal Date(Calibrated by, Certificate No.)	Scheduled Calibration
Power Meter NRP2	101919	27-Jun-17 (CTTL, No.J17X05857)	Jun-18
Power sensor NRP-Z91	101547	27-Jun-17 (CTTL, No.J17X05857)	Jun-18
Power sensor NRP-Z91	101548	27-Jun-17 (CTTL, No.J17X05857)	Jun-18
Reference10dBAttenuator	18N50W-10dB	13-Mar-16(CTTL,No.J16X01547)	Mar-18
Reference20dBAttenuator	18N50W-20dB	13-Mar-16(CTTL, No.J16X01548)	Mar-18
Reference Probe EX3DV4	SN 3617	23-Jan-17(SPEAG,No.EX3-3617_Jan17)	Jan-18
DAE4	SN 549	13-Dec-16(SPEAG, No.DAE4-549_Dec16)	Dec -17
Secondary Standards	ID #	Cal Date(Calibrated by, Certificate No.)	Scheduled Calibration
SignalGeneratorMG3700A	6201052605	27-Jun-17 (CTTL, No.J17X05858)	Jun-18
Network Analyzer E5071C	MY46110673	13-Jan-17 (CTTL, No.J17X00285)	Jan -18

	Name	Function	Signature
Calibrated by:	Yu Zongying	SAR Test Engineer	
Reviewed by:	Lin Hao	SAR Test Engineer	
Approved by:	Qi Dianyuan	SAR Project Leader	

Issued: November 03, 2017

This calibration certificate shall not be reproduced except in full without written approval of the laboratory.



Glossary:

TSL	tissue simulating liquid
NORM _{x,y,z}	sensitivity in free space
ConvF	sensitivity in TSL / NORM _{x,y,z}
DCP	diode compression point
CF	crest factor (1/duty_cycle) of the RF signal
A,B,C,D	modulation dependent linearization parameters
Polarization Φ	Φ rotation around probe axis
Polarization θ	θ rotation around an axis that is in the plane normal to probe axis (at measurement center), $\theta=0$ is normal to probe axis
Connector Angle	information used in DASY system to align probe sensor X to the robot coordinate system

Calibration is Performed According to the Following Standards:

- IEEE Std 1528-2013, "IEEE Recommended Practice for Determining the Peak Spatial-Averaged Specific Absorption Rate (SAR) in the Human Head from Wireless Communications Devices: Measurement Techniques", June 2013
- IEC 62209-1, "Measurement procedure for the assessment of Specific Absorption Rate (SAR) from hand-held and body-mounted devices used next to the ear (frequency range of 300 MHz to 6 GHz)", July 2016
- IEC 62209-2, "Procedure to determine the Specific Absorption Rate (SAR) for wireless communication devices used in close proximity to the human body (frequency range of 30 MHz to 6 GHz)", March 2010
- KDB 865664, "SAR Measurement Requirements for 100 MHz to 6 GHz"

Methods Applied and Interpretation of Parameters:

- NORM_{x,y,z}**: Assessed for E-field polarization $\theta=0$ ($f \leq 900$ MHz in TEM-cell; $f > 1800$ MHz: waveguide). NORM_{x,y,z} are only intermediate values, i.e., the uncertainties of NORM_{x,y,z} does not effect the E^2 -field uncertainty inside TSL (see below ConvF).
- NORM(f)_{x,y,z}** = NORM_{x,y,z} * frequency_response (see Frequency Response Chart). This linearization is implemented in DASY4 software versions later than 4.2. The uncertainty of the frequency response is included in the stated uncertainty of ConvF.
- DCP_{x,y,z}**: DCP are numerical linearization parameters assessed based on the data of power sweep (no uncertainty required). DCP does not depend on frequency nor media.
- PAR**: PAR is the Peak to Average Ratio that is not calibrated but determined based on the signal characteristics.
- A_{x,y,z}; B_{x,y,z}; C_{x,y,z}; VR_{x,y,z}; A,B,C** are numerical linearization parameters assessed based on the data of power sweep for specific modulation signal. The parameters do not depend on frequency nor media. VR is the maximum calibration range expressed in RMS voltage across the diode.
- ConvF and Boundary Effect Parameters**: Assessed in flat phantom using E-field (or Temperature Transfer Standard for $f \leq 800$ MHz) and inside waveguide using analytical field distributions based on power measurements for $f > 800$ MHz. The same setups are used for assessment of the parameters applied for boundary compensation (alpha, depth) of which typical uncertainty valued are given. These parameters are used in DASY4 software to improve probe accuracy close to the boundary. The sensitivity in TSL corresponds to NORM_{x,y,z} * ConvF whereby the uncertainty corresponds to that given for ConvF. A frequency dependent ConvF is used in DASY version 4.4 and higher which allows extending the validity from ± 50 MHz to ± 100 MHz.
- Spherical isotropy (3D deviation from isotropy)**: in a field of low gradients realized using a flat phantom exposed by a patch antenna.
- Sensor Offset**: The sensor offset corresponds to the offset of virtual measurement center from the probe tip (on probe axis). No tolerance required.
- Connector Angle**: The angle is assessed using the information gained by determining the NORM_x (no uncertainty required).



In Collaboration with
s p e a g
CALIBRATION LABORATORY

Add: No.51 Xueyuan Road, Haidian District, Beijing, 100191, China
Tel: +86-10-62304633-2218 Fax: +86-10-62304633-2209
E-mail: cttl@chinattl.com [Http://www.chinattl.cn](http://www.chinattl.cn)

Probe EX3DV4

SN: 3970

Calibrated: November 02, 2017

Calibrated for DASY/EASY Systems

(Note: non-compatible with DASY2 system!)



DASY/EASY – Parameters of Probe: EX3DV4 – SN: 3970

Basic Calibration Parameters

	Sensor X	Sensor Y	Sensor Z	Unc (k=2)
Norm($\mu\text{V}/(\text{V}/\text{m})^2$) ^A	0.49	0.64	0.26	±10.0%
DCP(mV) ^B	102.2	105.1	96.2	

Modulation Calibration Parameters

UID	Communication System Name		A dB	B dB $\sqrt{\mu\text{V}}$	C	D dB	VR mV	Unc ^E (k=2)
0	CW	X	0.0	0.0	1.0	0.00	176.2	±2.3%
		Y	0.0	0.0	1.0		211.5	
		Z	0.0	0.0	1.0		115.6	

The reported uncertainty of measurement is stated as the standard uncertainty of Measurement multiplied by the coverage factor k=2, which for a normal distribution Corresponds to a coverage probability of approximately 95%.

^A The uncertainties of Norm X, Y, Z do not affect the E²-field uncertainty inside TSL (see Page 5 and Page 6).

^B Numerical linearization parameter: uncertainty not required.

^E Uncertainty is determined using the max. deviation from linear response applying rectangular distribution and is expressed for the square of the field value.



DASY/EASY – Parameters of Probe: EX3DV4 – SN: 3970

Calibration Parameter Determined in Head Tissue Simulating Media

f [MHz] ^C	Relative Permittivity ^F	Conductivity (S/m) ^F	ConvF X	ConvF Y	ConvF Z	Alpha ^G	Depth ^G (mm)	Unct. (k=2)
750	41.9	0.89	10.41	10.41	10.41	0.30	0.80	±12.1%
835	41.5	0.90	10.03	10.03	10.03	0.16	1.26	±12.1%
900	41.5	0.97	10.05	10.05	10.05	0.14	1.46	±12.1%
1750	40.1	1.37	8.68	8.68	8.68	0.21	1.11	±12.1%
1900	40.0	1.40	8.25	8.25	8.25	0.24	1.00	±12.1%
2300	39.5	1.67	8.08	8.08	8.08	0.56	0.70	±12.1%
2450	39.2	1.80	7.91	7.91	7.91	0.55	0.73	±12.1%
2600	39.0	1.96	7.59	7.59	7.59	0.51	0.79	±12.1%
5200	36.0	4.66	5.92	5.92	5.92	0.35	1.50	±13.3%
5300	35.9	4.76	5.67	5.67	5.67	0.35	1.40	±13.3%
5500	35.6	4.96	5.22	5.22	5.22	0.35	1.45	±13.3%
5600	35.5	5.07	5.12	5.12	5.12	0.35	1.65	±13.3%
5800	35.3	5.27	5.21	5.21	5.21	0.40	1.35	±13.3%

^C Frequency validity above 300 MHz of ±100MHz only applies for DASY v4.4 and higher (Page 2), else it is restricted to ±50MHz. The uncertainty is the RSS of ConvF uncertainty at calibration frequency and the uncertainty for the indicated frequency band. Frequency validity below 300 MHz is ± 10, 25, 40, 50 and 70 MHz for ConvF assessments at 30, 64, 128, 150 and 220 MHz respectively. Above 5 GHz frequency validity can be extended to ± 110 MHz.

^F At frequency below 3 GHz, the validity of tissue parameters (ϵ and σ) can be relaxed to ±10% if liquid compensation formula is applied to measured SAR values. At frequencies above 3 GHz, the validity of tissue parameters (ϵ and σ) is restricted to ±5%. The uncertainty is the RSS of the ConvF uncertainty for indicated target tissue parameters.

^G Alpha/Depth are determined during calibration. SPEAG warrants that the remaining deviation due to the boundary effect after compensation is always less than ± 1% for frequencies below 3 GHz and below ± 2% for the frequencies between 3-6 GHz at any distance larger than half the probe tip diameter from the boundary.



DASY/EASY – Parameters of Probe: EX3DV4 – SN: 3970

Calibration Parameter Determined in Body Tissue Simulating Media

f [MHz] ^C	Relative Permittivity ^F	Conductivity (S/m) ^F	ConvF X	ConvF Y	ConvF Z	Alpha ^G	Depth ^G (mm)	Unct. (k=2)
750	55.5	0.96	10.35	10.35	10.35	0.40	0.85	±12.1%
835	55.2	0.97	10.16	10.16	10.16	0.19	1.33	±12.1%
900	55.0	1.05	10.12	10.12	10.12	0.23	1.21	±12.1%
1750	53.4	1.49	8.32	8.32	8.32	0.25	1.04	±12.1%
1900	53.3	1.52	8.10	8.10	8.10	0.20	1.15	±12.1%
2300	52.9	1.81	7.80	7.80	7.80	0.54	0.79	±12.1%
2450	52.7	1.95	7.83	7.83	7.83	0.66	0.70	±12.1%
2600	52.5	2.16	7.49	7.49	7.49	0.54	0.78	±12.1%
5200	49.0	5.30	5.19	5.19	5.19	0.50	1.30	±13.3%
5300	48.9	5.42	4.73	4.73	4.73	0.50	1.36	±13.3%
5500	48.6	5.65	4.42	4.42	4.42	0.50	1.40	±13.3%
5600	48.5	5.77	4.31	4.31	4.31	0.50	1.60	±13.3%
5800	48.2	6.00	4.40	4.40	4.40	0.50	1.72	±13.3%

^C Frequency validity above 300 MHz of ±100MHz only applies for DASY v4.4 and higher (Page 2), else it is restricted to ±50MHz. The uncertainty is the RSS of ConvF uncertainty at calibration frequency and the uncertainty for the indicated frequency band. Frequency validity below 300 MHz is ± 10, 25, 40, 50 and 70 MHz for ConvF assessments at 30, 64, 128, 150 and 220 MHz respectively. Above 5 GHz frequency validity can be extended to ± 110 MHz.

^F At frequency below 3 GHz, the validity of tissue parameters (ϵ and σ) can be relaxed to ±10% if liquid compensation formula is applied to measured SAR values. At frequencies above 3 GHz, the validity of tissue parameters (ϵ and σ) is restricted to ±5%. The uncertainty is the RSS of the ConvF uncertainty for indicated target tissue parameters.

^G Alpha/Depth are determined during calibration. SPEAG warrants that the remaining deviation due to the boundary effect after compensation is always less than ± 1% for frequencies below 3 GHz and below ± 2% for the frequencies between 3-6 GHz at any distance larger than half the probe tip diameter from the boundary.



Add: No.51 Xueyuan Road, Haidian District, Beijing, 100191, China
Tel: +86-10-62304633-2218 Fax: +86-10-62304633-2209
E-mail: cttl@chinattl.com [Http://www.chinattl.cn](http://www.chinattl.cn)

Frequency Response of E-Field (TEM-Cell: ifi110 EXX, Waveguide: R22)

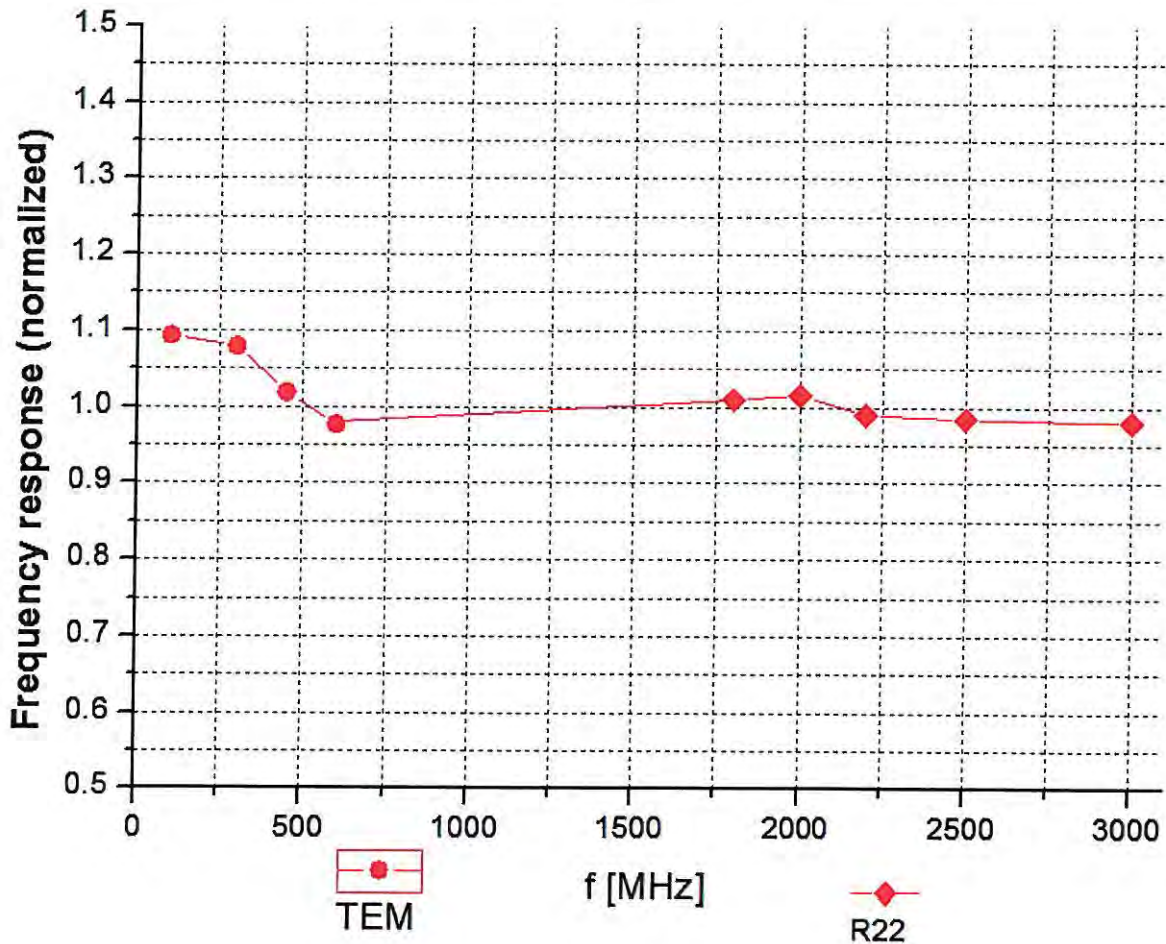

Uncertainty of Frequency Response of E-field: $\pm 7.4\%$ (k=2)



Add: No.51 Xueyuan Road, Haidian District, Beijing, 100191, China
Tel: +86-10-62304633-2218 Fax: +86-10-62304633-2209
E-mail: cttl@chinattl.com [Http://www.chinattl.cn](http://www.chinattl.cn)

Receiving Pattern (Φ), $\theta=0^\circ$

f=600 MHz, TEM

f=1800 MHz, R22

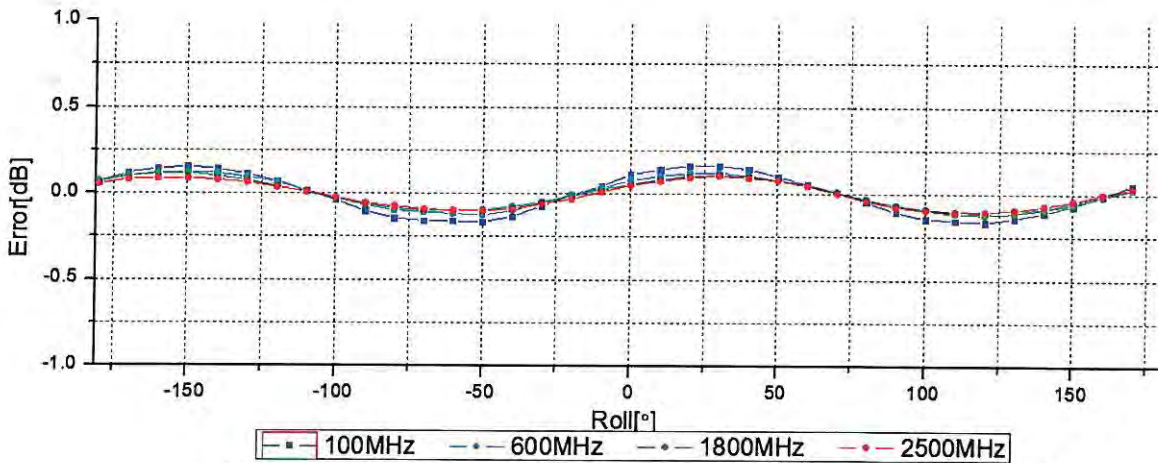
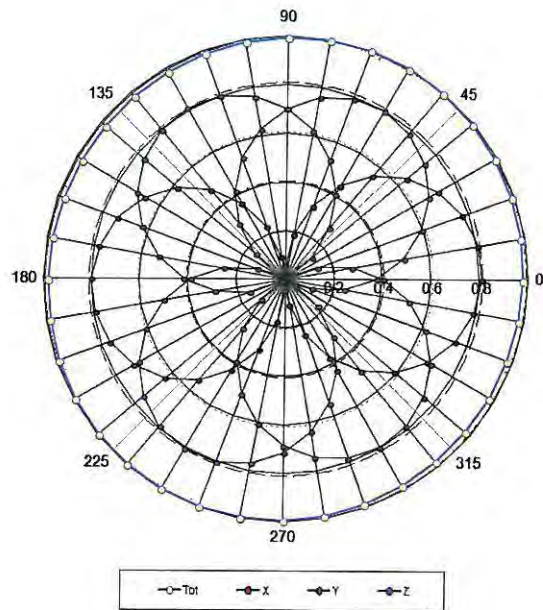
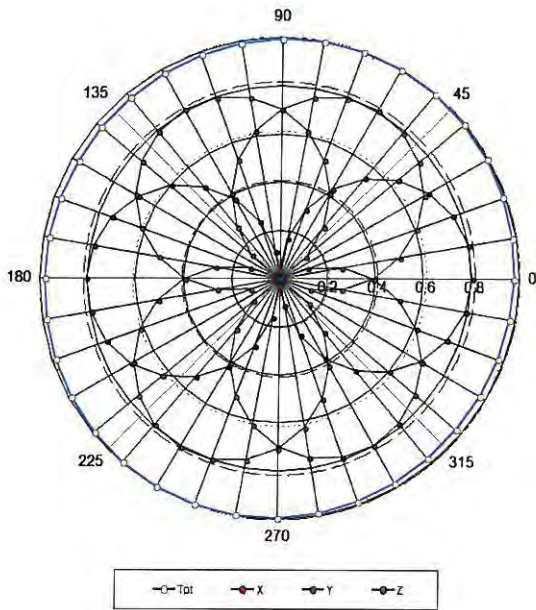

Uncertainty of Axial Isotropy Assessment: $\pm 1.2\%$ (k=2)



Dynamic Range f(SAR_{head}) (TEM cell, f = 900 MHz)

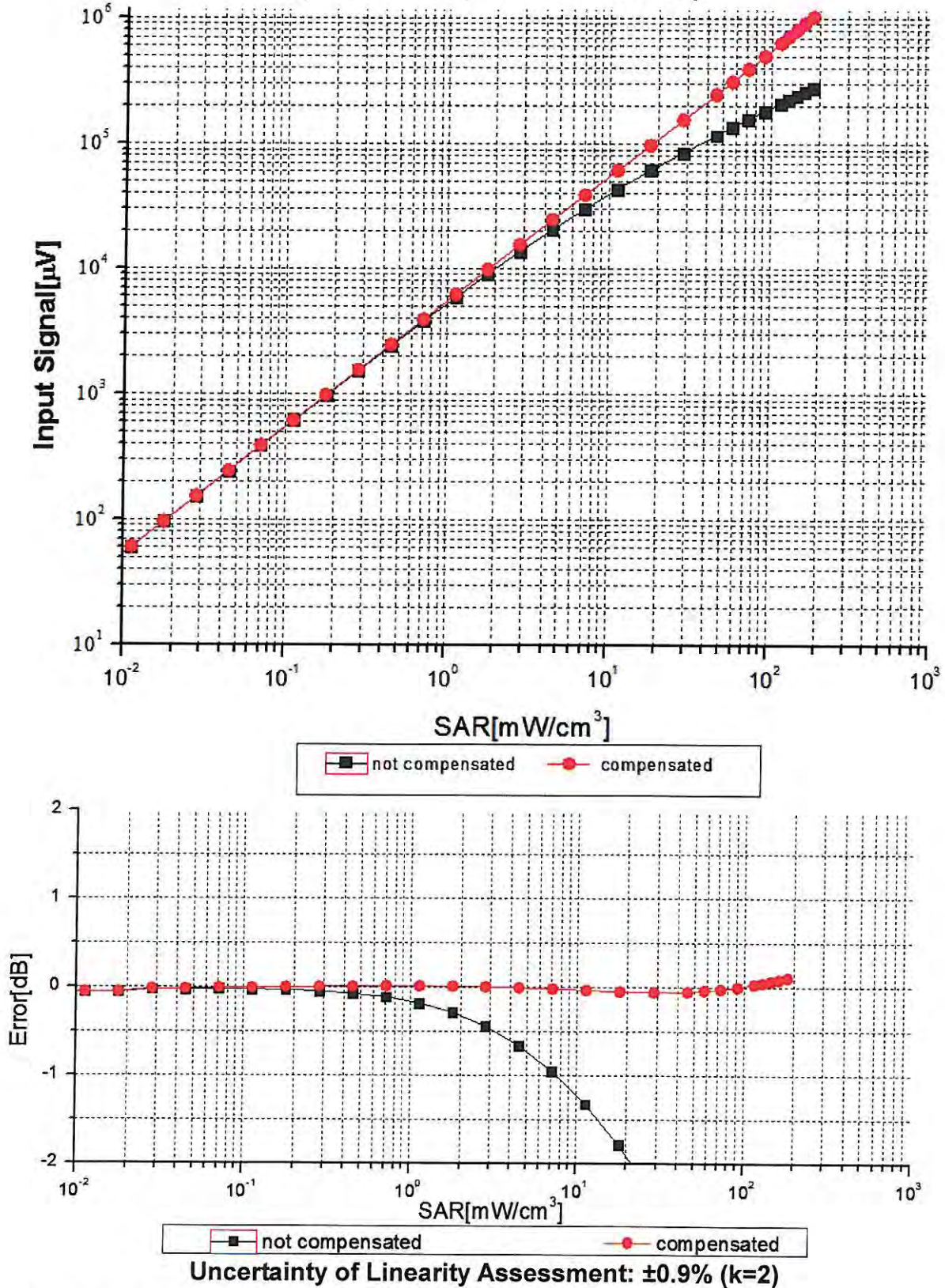

Conversion Factor Assessment

f=750 MHz, WGLS R9(H_convF)

f=1750 MHz, WGLS R22(H_convF)

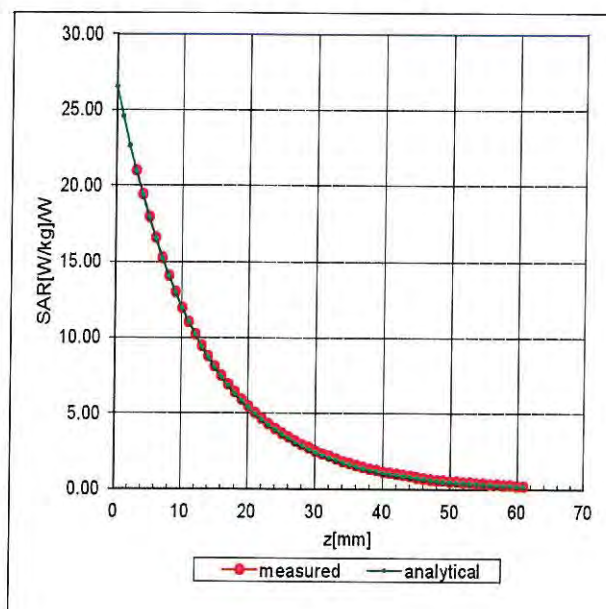
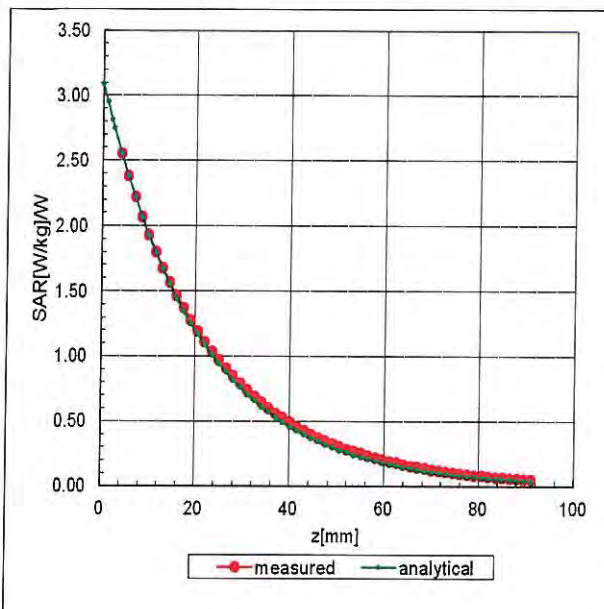

Deviation from Isotropy in Liquid

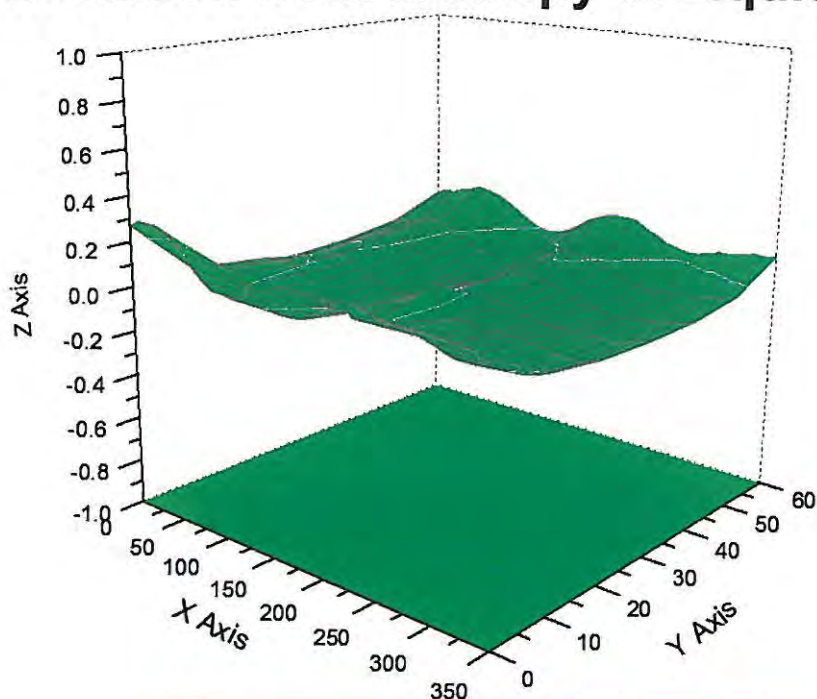

Uncertainty of Spherical Isotropy Assessment: $\pm 3.2\%$ (K=2)

DASY/EASY – Parameters of Probe: EX3DV4 – SN: 3970

Other Probe Parameters

Sensor Arrangement	Triangular
Connector Angle (°)	160.2
Mechanical Surface Detection Mode	enabled
Optical Surface Detection Mode	disable
Probe Overall Length	337mm
Probe Body Diameter	10mm
Tip Length	9mm
Tip Diameter	2.5mm
Probe Tip to Sensor X Calibration Point	1mm
Probe Tip to Sensor Y Calibration Point	1mm
Probe Tip to Sensor Z Calibration Point	1mm
Recommended Measurement Distance from Surface	1.4mm

Appendix D. Photographs of EUT and Setup

FCC SAR Test Report

<Photographs of EUT>

Laptop PC Mode

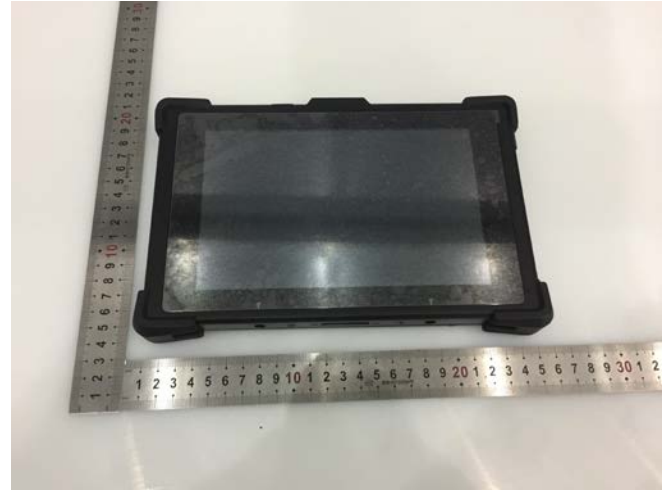

FCC SAR Test Report

<Antenna Location>

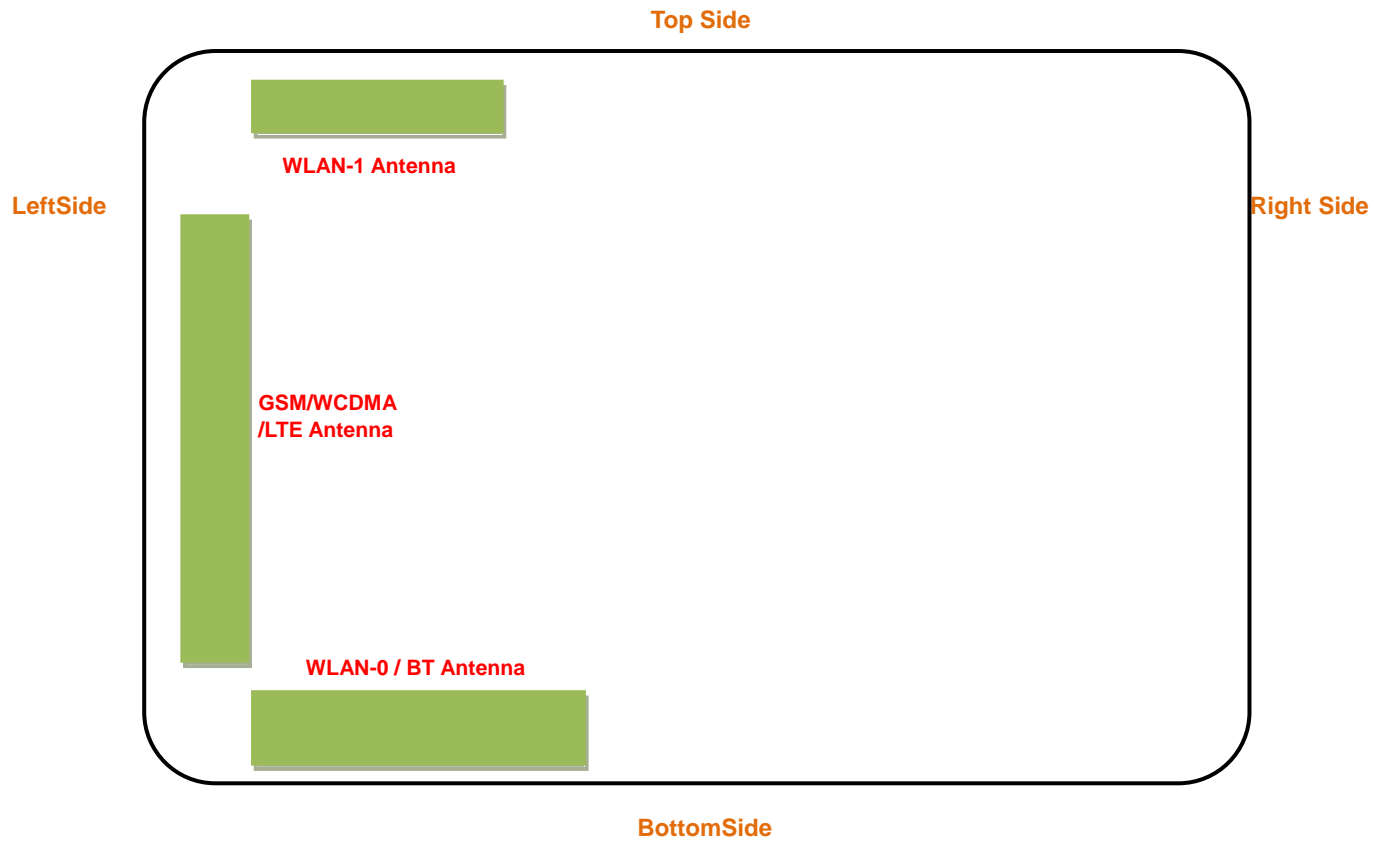

<Display Front Rear View>

The separation distance for antenna to edge:

Antenna	To Left Side (mm)	To Right Side (mm)	To Top Side (mm)	To Bottom Side (mm)
WLAN-1	32	178	5	145
WLAN-0 / BT	52	158	130	10
Main	5	190	65	20

FCC SAR Test Report

<Photographs of SAR Setup>



Rear Face 0 cm Gap



Rear Face-1 0 cm Gap



Left Side 0 cm Gap



Bottom 0 cm Gap



Top 0 cm Gap

