

FCC 47 CFR PART 15 SUBPART E

CERTIFICATION TEST REPORT

For

Tablet PC

MODEL No.: MS-NB31

FCC ID: I4L-MSNB31

Trade Mark: MSI

REPORT NO.: ES170719052E4

ISSUE DATE: October 22, 2017

Prepared for

Micro-star International Co., Ltd.

No., 69, Lide St., Zhonghe Dist., New Taipei City, Taiwan

Prepared by

EMTEK(SHENZHEN) CO., LTD.

Bldg 69, Majialong Industry Zone, Nanshan District,
Shenzhen, Guangdong, China

TEL: 86-755-26954280

FAX: 86-755-26954282

1 TEST RESULT CERTIFICATION

Applicant:	Micro-star International Co., Ltd. No., 69, Lide St., Zhonghe Dist., New Taipei City, Taiwan
Manufacturer:	MSI Electronics (Kunshan) Co.,Ltd. No.88 East Qianjin Road, Kunshan city, Jiangsu province, China
Product Description:	Tablet PC
Model Number:	MS-NB31
Trade Mark:	MSI
File Number:	ES170719052E4

Measurement Procedure Used:

APPLICABLE STANDARDS	
STANDARD	TEST RESULT
FCC 47 CFR Part 2, Subpart J FCC 47 CFR Part 15, Subpart E	PASS

The above equipment was tested by EMTEK(SHENZHEN) CO., LTD.. The test data, data evaluation, test procedures, and equipment configurations shown in this report were made in accordance with the procedures given in ANSI C63.10 (2013) and the energy emitted by the sample EUT tested as described in this report is in compliance with the requirements of FCC Rules Part 2 and Part 15.407

The test results of this report relate only to the tested sample identified in this report.

Date of Test : July 10, 2017 to October 20, 2017

Prepared by : *Sevin Li*
Sevin Li /Editor

Reviewer : *Joe Xia*
Joe Xia /Editor /Supervisor

Approve & Authorized Signer : *[Signature]*
Lisa Wang/Manager



TABLE OF CONTENTS

1 TEST RESULT CERTIFICATION 2

2 EUT TECHNICAL DESCRIPTION 4

3 SUMMARY OF TEST RESULT 6

4 TEST METHODOLOGY 7

4.1 GENERAL DESCRIPTION OF APPLIED STANDARDS 7

4.2 MEASUREMENT EQUIPMENT USED 7

4.3 DESCRIPTION OF TEST MODES 8

5 FACILITIES AND ACCREDITATIONS 13

5.1 FACILITIES 13

5.2 LABORATORY ACCREDITATIONS AND LISTINGS 13

6 TEST SYSTEM UNCERTAINTY 14

7 SETUP OF EQUIPMENT UNDER TEST 15

7.1 RADIO FREQUENCY TEST SETUP 15

7.2 RADIO FREQUENCY TEST SETUP 15

7.3 CONDUCTED EMISSION TEST SETUP 17

7.4 BLOCK DIAGRAM CONFIGURATION OF TEST SYSTEM 18

7.5 SUPPORT EQUIPMENT 18

8 TEST REQUIREMENTS 19

8.1 BANDWIDTH MEASUREMENT 19

8.2 MAXIMUM CONDUCTED OUTPUT POWER 96

8.3 MAXIMUM PEAK POWER DENSITY 101

8.4 FREQUENCY STABILITY 165

8.5 UNDESIRABLE RADIATED SPURIOUS EMISSION 186

8.6 POWER LINE CONDUCTED EMISSIONS 211

8.7 ANTENNA APPLICATION 214

2 EUT TECHNICAL DESCRIPTION

Characteristics	Description			
IEEE 802.11 WLAN Mode Supported	<input checked="" type="checkbox"/> 802.11a(20MHz channel bandwidth) <input checked="" type="checkbox"/> 802.11b(20MHz channel bandwidth) <input checked="" type="checkbox"/> 802.11g(20MHz channel bandwidth) <input checked="" type="checkbox"/> 802.11n(20MHz channel bandwidth) <input checked="" type="checkbox"/> 802.11n(40MHz channel bandwidth) <input checked="" type="checkbox"/> 802.11ac(20MHz channel bandwidth) <input checked="" type="checkbox"/> 802.11ac(40MHz channel bandwidth) <input checked="" type="checkbox"/> 802.11ac(80MHz channel bandwidth)			
Data Rate	802.11 b:1,2,5.5,11Mbps; 802.11 g/a:6,9,12,18,24,36,48,54Mbps; 802.11n(HT20)/ac(HT20): MCS0-MCS7; 802.11n(HT40): MCS0-MCS7; 802.11ac(HT40):MCS0-MCS8; 802.11ac(VHT80):MCS0-MCS8;			
Modulation	OFDM with BPSK/QPSK/16QAM/64QAM for 802.11a/g/n; DSSS with DBPSK/DQPSK/CCK for 802.11b;			
Operating Frequency Range	WIFI 5G Band	Mode	Frequency Range(MHz)	Number of channels
	UNII Band I	802.11a/n(HT20)/ac(VHT20)	5180-5240	4
		802.11n(HT40)/ac(VHT40)	5190-5230	2
		802.11 ac(VHT80)	5210	1
	UNII Band II-A	802.11a/n(HT20)/ac(VHT20)	5260-5320	4
		802.11n(HT40)/ac(VHT40)	5270-5310	2
		802.11 ac(VHT80)	5290	1
	UNII Band II-C	802.11a/n(HT20)/ac(VHT20)	5500-5700	11
		802.11n(HT40)/ac(VHT40)	5510-5670	5
		802.11 ac(VHT80)	5530-5610	2
	UNII Band III	802.11a/n(HT20)/ac(VHT20)	5745-5825	5
		802.11n(HT40)/ac(VHT40)	5755-5795	2
802.11 ac(VHT80)		5775	1	
Transmit Power Max	15.431 dBm for UNII Band I 15.361 dBm for UNII Band II-A 15.365 dBm for UNII Band II-C 14.943 dBm for UNII Band III			
Antenna Type	Antenna 0: FPC antenna Antenna 1: FPC antenna			
Smart system	<input checked="" type="checkbox"/> SISO		<input checked="" type="checkbox"/> MIMO	
Antenna Gain	Antenna 1: 5.86 dBi Antenna 2: 2.60 dBi			

Direction Gain	7.54 dBi
Power supply	<input checked="" type="checkbox"/> DC 3.7V internal rechargeable lithium battery <input checked="" type="checkbox"/> DC 19V from Adapter
	<input checked="" type="checkbox"/> Adapter: Model: ADP-65JH HB INPUT: 100-240V~ 1.5A 50-60Hz OUTPUT: DC 19V 3.42A
Battery information	Model: 4661140 Rating: DC 3.7V, 10800mAh, 39.96Wh

Note: for more details, please refer to the User's manual of the EUT.

3 SUMMARY OF TEST RESULT

FCC Part Clause	Test Parameter	Verdict	Remark
15.407 (a) 15.407 (e)	99% , 6dB and 26dB Bandwidth	PASS	
15.407 (a)	Maximum Conducted Output Power	PASS	
15.407 (a)	Peak Power Spectral Density	PASS	
15.407 (b)	Radiated Spurious Emission	PASS	
15.407(g)	Frequency Stability	PASS	
15.407 (b)(6) 15.207	Power Line Conducted Emission	PASS	
15.407(a) 15.203	Antenna Application	PASS	
NOTE1: N/A (Not Applicable) NOTE2: According to FCC OET KDB 789033 D2 General UNII Test Procedures New Rules v01r02, In addition, the radiated test is also performed to ensure the emissions emanating from the device cabinet also comply with the applicable limits.			

RELATED SUBMITTAL(S) / GRANT(S):

This submittal(s) (test report) is intended for FCC ID: I4L-MSNB31 filing to comply with Section 15.247 of the FCC Part 15, Subpart E Rules.

4 TEST METHODOLOGY

4.1 GENERAL DESCRIPTION OF APPLIED STANDARDS

According to its specifications, the EUT must comply with the requirements of the following standards:

FCC 47 CFR Part 2, Subpart J

FCC 47 CFR Part 15, Subpart E

FCC KDB 789033 D2 General UNII Test Procedures New Rules v01r04

FCC KDB 662911 D01 Multiple Transmitter Output v02r01

FCC KDB 662911 D02 MIMO With Cross Polarized Antenna V01

4.2 MEASUREMENT EQUIPMENT USED

4.2.1 Conducted Emission Test Equipment

EQUIPMENT TYPE	MFR	MODEL NUMBER	SERIAL NUMBER	LAST CAL.	DUE CAL.
Test Receiver	Rohde & Schwarz	ESCI	26115-010-0027	May 20, 2017	May 19, 2018
L.I.S.N.	Rohde & Schwarz	ENV216	101161	May 20, 2017	May 19, 2018
50Ω Coaxial Switch	Anritsu	MP59B	6100175589	May 21, 2017	May 20, 2018
Voltage Probe	Rohde & Schwarz	ESH2-Z3	100122	May 21, 2017	May 20, 2018
Pulse Limiter	Rohde & Schwarz	ESH3-Z2	100006	May 20, 2017	May 19, 2018
I.S.N	Teseq GmbH	ISN T800	30327	May 21, 2017	May 20, 2018

4.2.2 Radiated Emission Test Equipment

EQUIPMENT TYPE	MFR	MODEL NUMBER	SERIAL NUMBER	LAST CAL.	DUE CAL.
EMI Test Receiver	Rohde & Schwarz	ESU	1302.6005.26	May 21, 2017	May 20, 2018
Pre-Amplifier	HP	8447F	2944A07999	May 20, 2017	May 19, 2018
Bilog Antenna	Schwarzbeck	VULB9163	142	May 20, 2017	May 19, 2018
Loop Antenna	ARA	PLA-1030/B	1029	May 20, 2017	May 19, 2018
Horn Antenna	Schwarzbeck	BBHA 9170	BBHA9170399	May 21, 2017	May 20, 2018
Horn Antenna	Schwarzbeck	BBHA 9120	D143	May 20, 2017	May 19, 2018
Cable	Schwarzbeck	AK9513	ACRX1	May 21, 2017	May 20, 2018
Cable	Rosenberger	N/A	FP2RX2	May 21, 2017	May 20, 2018
Cable	Schwarzbeck	AK9513	CRPX1	May 21, 2017	May 20, 2018
Cable	Schwarzbeck	AK9513	CRRX2	May 21, 2017	May 20, 2018

4.2.3 Radio Frequency Test Equipment

EQUIPMENT TYPE	MFR	MODEL NUMBER	SERIAL NUMBER	LAST CAL.	DUE CAL.
Spectrum Analyzer	Agilent	E4407B	88156318	May 21, 2017	May 20, 2018
Signal Analyzer	Agilent	N9010A	My53470879	May 21, 2017	May 20, 2018
Power meter	Anritsu	ML2495A	0824006	May 21, 2017	May 20, 2018
Power sensor	Anritsu	MA2411B	0738172	May 21, 2017	May 20, 2018
Spectrum Analyzer	Agilent	E4407B	88156318	May 21, 2017	May 20, 2018

Remark: Each piece of equipment is scheduled for calibration once a year.

4.3 DESCRIPTION OF TEST MODES

The EUT has been tested under its typical operating condition.

The EUT configuration for testing is installed on RF field strength measurement to meet the Commissions requirement and operating in a manner which intends to maximize its emission characteristics in a continuous normal application.

The Transmitter was operated in the normal operating mode. The TX frequency was fixed which was for the purpose of the measurements.

Test of channel included the lowest and middle and highest frequency to perform the test, then record on this report.

Those data rates (☒802.11a: 6 Mbps; ☒802.11n (HT20): MCS0; ☒802.11n (HT20): MCS15; ☒802.11n (HT40): MCS0; ☒802.11n (HT40): MCS15; ☒802.11ac (HT20): MCS0; ☒802.11ac (HT20): MCS15; ☒802.11ac (HT40): MCS0; ☒802.11ac (HT40): MCS19; ☒802.11ac (HT80): MCS0; ☒802.11ac (HT80): MCS19;) were used for all test.

Pre-defined engineering program for regulatory testing used to control the EUT for staying in continuous transmitting and receiving mode is programmed.

Wifi 5G with UNII Band I

Frequency and Channel list for 802.11a/n(HT20)/ac(VHT20):

Channel	Frequency (MHz)	Channel	Frequency (MHz)	Channel	Frequency (MHz)
36	5180	44	5220		
40	5200	48	5240		

Frequency and Channel list for 802.11n(HT40)/ac(VHT40):

Channel	Frequency (MHz)	Channel	Frequency (MHz)	Channel	Frequency (MHz)
38	5190				
46	5230				

Frequency and Channel list for 802.11ac(VHT80):

Channel	Frequency (MHz)	Channel	Frequency (MHz)	Channel	Frequency (MHz)
42	5210				

Test Frequency and Channel for 802.11a/n(HT20)/ac(VHT20):

Lowest Frequency		Middle Frequency		Highest Frequency	
Channel	Frequency (MHz)	Channel	Frequency (MHz)	Channel	Frequency (MHz)
36	5180	40	5200	48	5240

Test Frequency and channel for 802.11n(VHT40)/ac(VHT40):

Lowest Frequency		Middle Frequency		Highest Frequency	
Channel	Frequency (MHz)	Channel	Frequency (MHz)	Channel	Frequency (MHz)
38	5190	N/A	N/A	46	5230

Test Frequency and channel for 802.11ac(HT80):

Lowest Frequency		Middle Frequency		Highest Frequency	
Channel	Frequency (MHz)	Channel	Frequency (MHz)	Channel	Frequency (MHz)
42	5210	N/A	N/A	N/A	N/A

Wifi 5G with UNII Band II-A

Frequency and Channel list for 802.11a/n(HT20)/ac(VHT20):

Channel	Frequency (MHz)	Channel	Frequency (MHz)	Channel	Frequency (MHz)
52	5260	60	5300		
56	5280	64	5320		

Frequency and Channel list for 802.11n(VHT40)/ac(VHT40):

Channel	Frequency (MHz)	Channel	Frequency (MHz)	Channel	Frequency (MHz)
54	5270				
62	5310				

Frequency and Channel list for 802.11ac(VHT80):

Channel	Frequency (MHz)	Channel	Frequency (MHz)	Channel	Frequency (MHz)
58	5290				

Test Frequency and Channel for 802.11a/n(HT20)/ac(VHT20):

Lowest Frequency		Middle Frequency		Highest Frequency	
Channel	Frequency (MHz)	Channel	Frequency (MHz)	Channel	Frequency (MHz)
52	5260	56	5280	64	5320

Test Frequency and channel for 802.11n(HT40)/ac(VHT40):

Lowest Frequency		Middle Frequency		Highest Frequency	
Channel	Frequency (MHz)	Channel	Frequency (MHz)	Channel	Frequency (MHz)
54	5270	N/A	N/A	62	5310

Test Frequency and channel for 802.11ac(VHT80):

Lowest Frequency		Middle Frequency		Highest Frequency	
Channel	Frequency (MHz)	Channel	Frequency (MHz)	Channel	Frequency (MHz)
58	5290	N/A	N/A	N/A	N/A

Wifi 5G with UNII Band II-C

Frequency and Channel list for 802.11a/n(HT20)/ac(VHT20):

Channel	Frequency (MHz)	Channel	Frequency (MHz)	Channel	Frequency (MHz)
100	5500	116	5580	132	5660
104	5520	120	5600	136	5680
108	5540	124	5620	140	5700
112	5560	128	5640		

Frequency and Channel list for 802.11n(VHT40)/ac(VHT40):

Channel	Frequency (MHz)	Channel	Frequency (MHz)	Channel	Frequency (MHz)
102	5510	126	5630		
110	5550	134	5670		
118	5590				

Frequency and Channel list for 802.11ac(VHT80):

Channel	Frequency (MHz)	Channel	Frequency (MHz)	Channel	Frequency (MHz)
106	5530				
122	5610				

Test Frequency and Channel for 802.11a/n(HT20)/ac(VHT20):

Lowest Frequency		Middle Frequency		Highest Frequency	
Channel	Frequency (MHz)	Channel	Frequency (MHz)	Channel	Frequency (MHz)
100	5500	120	5600	140	5700

Test Frequency and channel for 802.11n(VHT40)/ac(VHT40):

Lowest Frequency		Middle Frequency		Highest Frequency	
Channel	Frequency (MHz)	Channel	Frequency (MHz)	Channel	Frequency (MHz)
102	5510	118	5590	134	5670

Test Frequency and channel for 802.11ac(VHT80):

Lowest Frequency		Middle Frequency		Highest Frequency	
Channel	Frequency (MHz)	Channel	Frequency (MHz)	Channel	Frequency (MHz)
106	5530	N/A	N/A	122	5610

Wifi 5G with UNII Band III

Frequency and Channel list for 802.11a/n(HT20)/ac(VHT20):

Channel	Frequency (MHz)	Channel	Frequency (MHz)	Channel	Frequency (MHz)
149	5745	157	5785	165	5825
153	5765	161	5805		

Frequency and Channel list for 802.11n(HT40)/ac(VHT40):

Channel	Frequency (MHz)	Channel	Frequency (MHz)	Channel	Frequency (MHz)
151	5755				
159	5795				

Frequency and Channel list for 802.11ac(VHT80):

Channel	Frequency (MHz)	Channel	Frequency (MHz)	Channel	Frequency (MHz)
155	5775				

Test Frequency and Channel for 802.11a/n(HT20)/ac(VHT20):

Lowest Frequency		Middle Frequency		Highest Frequency	
Channel	Frequency (MHz)	Channel	Frequency (MHz)	Channel	Frequency (MHz)
149	5745	157	5785	165	5825

Test Frequency and channel for 802.11n(HT40)/ac(VHT40):

Lowest Frequency		Middle Frequency		Highest Frequency	
Channel	Frequency (MHz)	Channel	Frequency (MHz)	Channel	Frequency (MHz)
151	5755	N/A	N/A	159	5795

Test Frequency and channel for 802.11ac(VHT80):

Lowest Frequency		Middle Frequency		Highest Frequency	
Channel	Frequency (MHz)	Channel	Frequency (MHz)	Channel	Frequency (MHz)
155	5775				

5 FACILITIES AND ACCREDITATIONS

5.1 FACILITIES

All measurement facilities used to collect the measurement data are located at

Bldg 69, Majialong Industry Zone District, Nanshan District, Shenzhen, China

The sites are constructed in conformance with the requirements of ANSI C63.7, ANSI C63.10 and CISPR Publication 22.

5.2 LABORATORY ACCREDITATIONS AND LISTINGS

Site Description

EMC Lab.

: Accredited by CNAS,2016.10.24

The certificate is valid until 2022.10.28

The Laboratory has been assessed and proved to be in compliance with CNAS-CL01:2006 (identical to ISO/IEC 17025:2005)

The Certificate Registration Number is L2291.

Accredited by TUV Rheinland Shenzhen 2016.5.19

The Laboratory has been assessed according to the requirements ISO/IEC 17025.

Accredited by FCC, August 03, 2017

Designation Number: CN1204

Test Firm Registration Number: 882943

Accredited by A2LA, July 31, 2017

The Certificate Registration Number is 4321.01.

Accredited by Industry Canada, November 29, 2012

The Certificate Registration Number is 4480A.

Name of Firm

: EMTEK(SHENZHEN) CO., LTD.

Site Location

: Bldg 69, Majialong Industry Zone,
Nanshan District, Shenzhen, Guangdong, China

6 TEST SYSTEM UNCERTAINTY

The following measurement uncertainty levels have been estimated for tests performed on the apparatus:

Parameter	Uncertainty
Radio Frequency	$\pm 1 \times 10^{-5}$
Maximum Peak Output Power Test	$\pm 1.0\text{dB}$
Conducted Emissions Test	$\pm 2.0\text{dB}$
Radiated Emission Test	$\pm 2.0\text{dB}$
Power Density	$\pm 2.0\text{dB}$
Occupied Bandwidth Test	$\pm 1.0\text{dB}$
Band Edge Test	$\pm 3\text{dB}$
All emission, radiated	$\pm 3\text{dB}$
Antenna Port Emission	$\pm 3\text{dB}$
Temperature	$\pm 0.5^{\circ}\text{C}$
Humidity	$\pm 3\%$

Measurement Uncertainty for a level of Confidence of 95%

7 SETUP OF EQUIPMENT UNDER TEST

7.1 RADIO FREQUENCY TEST SETUP

The WLAN component's antenna ports(s) of the EUT are connected to the measurement instrument per an appropriate attenuator. The EUT is controlled by PC/software to emit the specified signals for the purpose of measurements.

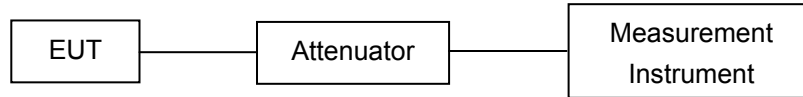

7.2 RADIO FREQUENCY TEST SETUP

The test site semi-anechoic chamber has met the requirement of NSA tolerance 4 dB according to the standards: ANSI C63.10. The test distance is 3m. The setup is according to the requirements in Section 13.1.4.1 of ANSI C63.10-2013 and CAN/CSA-CEI/IEC CISPR 22.

Below 30MHz:

The EUT is placed on a turntable 0.8 meters above the ground in the chamber, 3 meter away from the antenna (loop antenna). The Antenna should be positioned with its plane vertical at the specified distance from the EUT and rotated about its vertical axis for maximum response at each azimuth about the EUT. The center of the loop shall be 1 m above the ground. For certain applications, the loop antenna plane may also need to be positioned horizontally at the specified distance from the EUT.

Above 30MHz:

The EUT is placed on a turntable 0.8 meters above the ground in the chamber, 3 meter away from the antenna. The maximal emission value is acquired by adjusting the antenna height, polarisation and turntable azimuth. Normally, the height range of antenna is 1 m to 4 m, the azimuth range of turntable is 0° to 360°, and the receive antenna has two polarizations Vertical (V) and Horizontal (H).

Above 1GHz:

(Note: the FCC's permission to use 1.5m as an alternative per TCBC Conf call of Dec. 2, 2014.)

The EUT is placed on a turntable 1.5 meters above the ground in the chamber, 3 meter away from the antenna. The maximal emission value is acquired by adjusting the antenna height, polarisation and turntable azimuth. Normally, the height range of antenna is 1 m to 4 m, the azimuth range of turntable is 0° to 360°, and the receive antenna has two polarizations Vertical (V) and Horizontal (H).

(a) Radiated Emission Test Set-Up, Frequency Below 30MHz

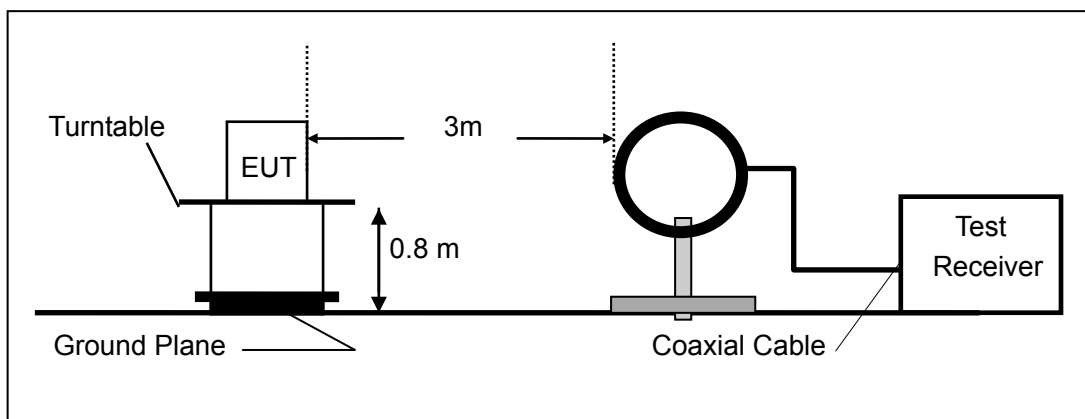

(b) Radiated Emission Test Set-Up, Frequency Below 1000MHz

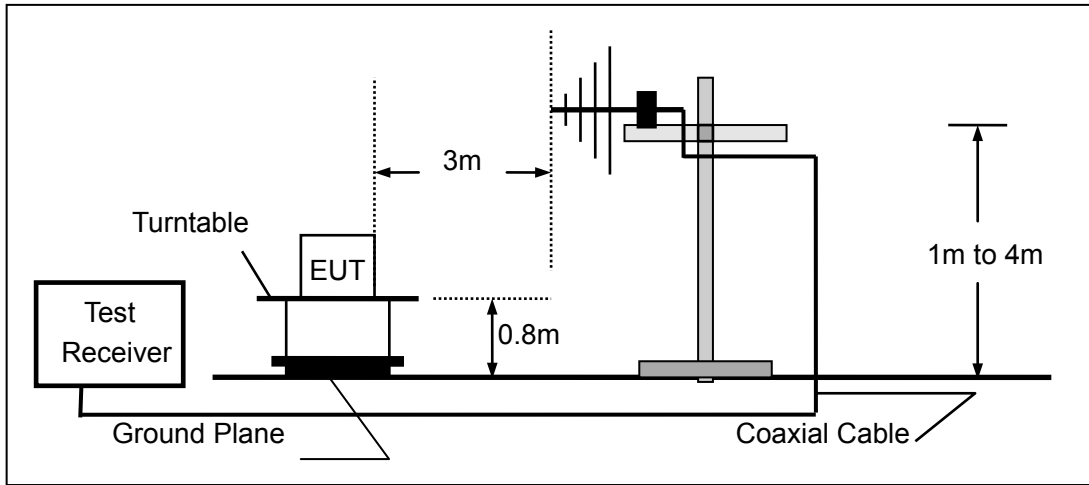

(c) Radiated Emission Test Set-Up, Frequency above 1000MHz

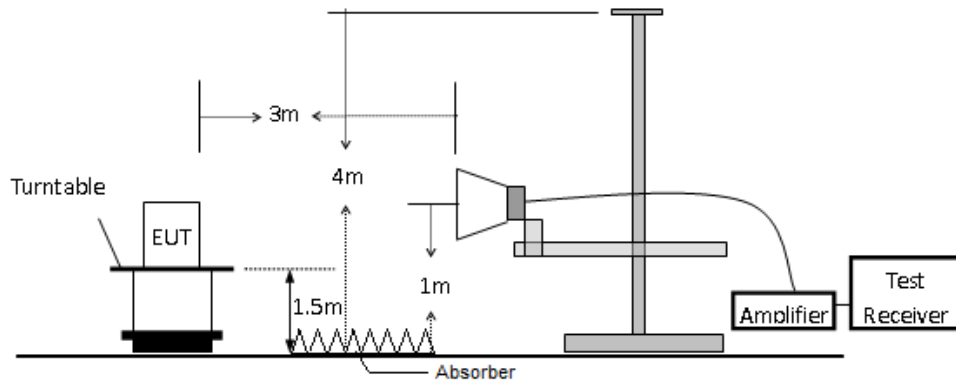

7.3 CONDUCTED EMISSION TEST SETUP

The mains cable of the EUT (maybe per AC/DC Adapter) must be connected to LISN. The LISN shall be placed 0.8 m from the boundary of EUT and bonded to a ground reference plane for LISN mounted on top of the ground reference plane. This distance is between the closest points of the LISN and the EUT. All other units of the EUT and associated equipment shall be at least 0.8m from the LISN.

Ground connections, where required for safety purposes, shall be connected to the reference ground point of the LISN and, where not otherwise provided or specified by the manufacturer, shall be of same length as the mains cable and run parallel to the mains connection at a separation distance of not more than 0.1 m.

According to the requirements in Section 13.1.4.1 of ANSI C63.10-2013 Conducted emissions from the EUT measured in the frequency range between 0.15 MHz and 30 MHz using CISPR Quasi-Peak and average detector mode.

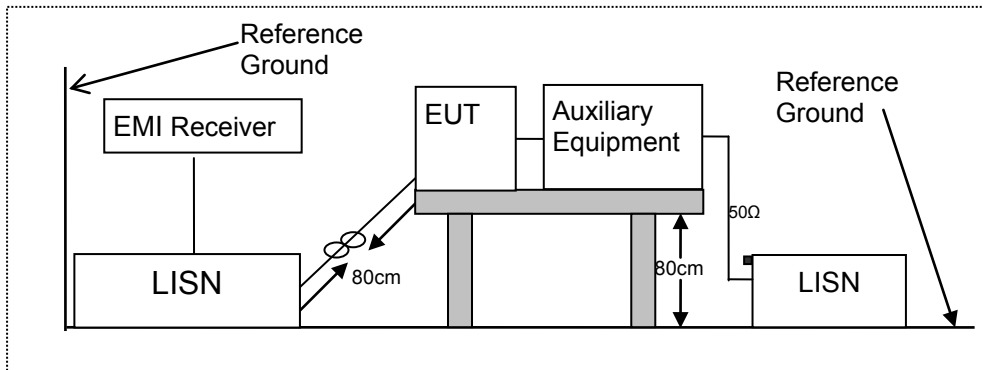

7.4 BLOCK DIAGRAM CONFIGURATION OF TEST SYSTEM

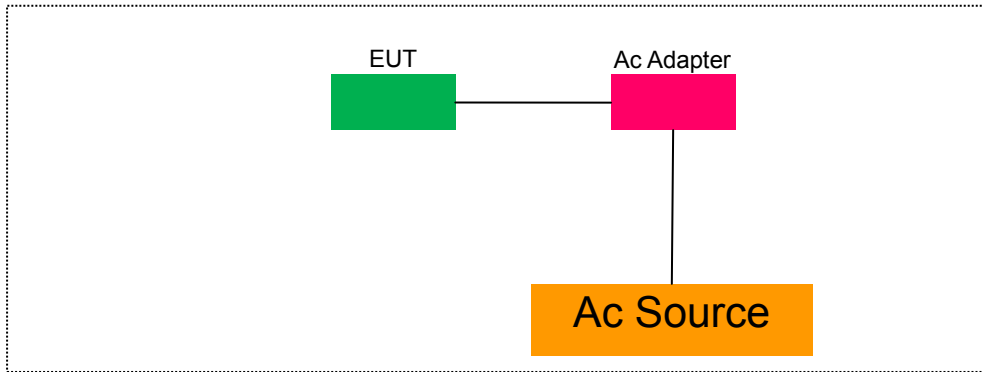

7.5 SUPPORT EQUIPMENT

Item	Equipment	Mfr/Brand	Model/Type No.	FCC ID	Series No.	Note
N/A	N/A	N/A	N/A	N/A	N/A	N/A

Notes:

1. All the equipment/cables were placed in the worst-case configuration to maximize the emission during the test.
2. Grounding was established in accordance with the manufacturer's requirements and conditions for the intended use.

8 TEST REQUIREMENTS

8.1 BANDWIDTH MEASUREMENT

8.1.1 Applicable Standard

According to FCC Part 15.407(a)(1) for UNII Band I
According to FCC Part 15.407(a)(2) for UNII Band II-A and UNII Band II-C
According to FCC Part 15.407(a)(3) for UNII Band III
According to FCC Part 15.407(e) for UNII Band III
According to 789033 D02 Section II(C)
According to 789033 D02 Section II(D)

8.1.2 Conformance Limit

No limit requirement.
The minimum 6 dB emission bandwidth of at least 500 KHz for the UNII Band III.

8.1.3 Test Configuration

Test according to clause 6.1 radio frequency test setup

8.1.4 Test Procedure

Connect the antenna port(s) to the spectrum analyzer input. Using the spectrum analyzer Channel Bandwidth mode, configure the spectrum analyzer as shown below

■ The following procedure shall be used for measuring (26 dB) power bandwidth:

Center Frequency: test Frequency

Set RBW = approximately 1% of the emission bandwidth.

Set the VBW > RBW.

Detector = Peak.

Trace mode = max hold.

X dB Bandwidth: 26 dB

Measure the maximum width of the emission that is 26 dB down from the maximum of the emission.

Compare this with the RBW setting of the analyzer. Readjust RBW and repeat measurement as needed until the RBW/EBW ratio is approximately 1%.

■ Minimum Emission Bandwidth for the UNII Band III

Center Frequency: test Frequency

Set RBW = 100 kHz

Set VBW $\geq 3 \cdot$ RBW

Detector = Peak

Trace mode = max hold

Sweep = auto couple

X dB Bandwidth: 6 dB

Note: The automatic bandwidth measurement capability of a spectrum analyzer or EMI receiver may be employed if it implements the functionality described above.

■ The following procedure shall be used for measuring (99 %) power bandwidth:

Set center frequency to the nominal EUT channel center frequency.

Set span = 1.5 times to 5.0 times the OBW.

Set RBW = 1 % to 5 % of the OBW

Set VBW $\geq 3 \cdot$ RBW

Video averaging is not permitted. Where practical, a sample detection and single sweep mode shall be used. Otherwise, peak detection and max hold mode (until the trace stabilizes) shall be used.

Use the 99 % power bandwidth function of the instrument (if available).

If the instrument does not have a 99 % power bandwidth function, the trace data points are recovered and directly summed in power units. The recovered amplitude data points, beginning at the lowest frequency, are placed in a running sum until 0.5 % of the total is reached; that frequency is recorded as the lower frequency.

The process is repeated until 99.5 % of the total is reached; that frequency is recorded as the upper frequency. The 99% occupied bandwidth is the difference between these two frequencies.

8.1.5 Test Results

Temperature : 28°C Humidity : 65 %		<input checked="" type="checkbox"/> 802.11a mode Test Date : September 29, 2017 Test By: King Kong
---------------------------------------	--	--

Band	Channel Number	Channel Freq. (MHz)	26dB EBW		99% OBW		Limit (MHz)	Verdict
			Ant0	Ant1	Ant0	Ant1		
UNII Band I	CH36	5180	21.3	21.37	16.805	16.757	N/A	N/A
	CH40	5200	21.55	21.5	16.915	16.915	N/A	N/A
	CH48	5240	21.38	21.39	16.859	16.929	N/A	N/A
UNII Band II-A	CH52	5260	21.32	21.45	16.749	16.756	N/A	N/A
	CH56	5280	21.31	21.04	16.769	16.753	N/A	N/A
	CH64	5320	21.19	21	16.726	16.743	N/A	N/A
UNII Band II-C	CH100	5500	21.17	21.1	16.751	16.714	N/A	N/A
	CH120	5600	21.21	21.36	16.805	16.775	N/A	N/A
	CH140	5700	21.04	21.28	16.739	16.657	N/A	N/A
UNII Band III	CH149	5745	18.57	18.52	16.567	16.549	N/A	N/A
	CH157	5785	21.33	21.33	16.784	16.829	N/A	N/A
	CH165	5825	21.25	21.1	16.746	16.802	N/A	N/A
Note: N/A (Not Applicable)								

Temperature : 28°C Humidity : 65 %		<input checked="" type="checkbox"/> 802.11n(VHT20) mode Test Date : September 29, 2017 Test By: King Kong
---------------------------------------	--	---

Band	Channel Number	Channel Freq. (MHz)	26dB EBW		99% OBW		Limit (MHz)	Verdict
			Ant0	Ant1	Ant0	Ant1		
UNII Band I	CH36	5180	21.28	21.32	17.853	17.852	N/A	N/A
	CH40	5200	21.31	21.21	17.844	17.9	N/A	N/A
	CH48	5240	21.29	21.32	17.847	17.846	N/A	N/A
UNII Band II-A	CH52	5260	21.52	21.44	17.744	17.826	N/A	N/A
	CH56	5280	21.23	21.42	17.834	17.842	N/A	N/A
	CH64	5320	21.59	21.49	17.839	17.789	N/A	N/A
UNII Band II-C	CH100	5500	21.16	21.41	17.777	17.828	N/A	N/A
	CH120	5600	21.19	21.21	17.798	17.852	N/A	N/A
	CH140	5700	21.25	21.42	17.813	17.811	N/A	N/A
UNII Band III	CH149	5745	18.75	18.77	17.78	17.456	N/A	N/A
	CH157	5785	21.38	21.76	17.833	17.393	N/A	N/A
	CH165	5825	21.38	21.55	17.821	17.821	N/A	N/A
Note: N/A (Not Applicable)								

802.11ac(VHT20) mode

Temperature : 28°C Test Date : September 29, 2017
 Humidity : 65 % Test By: King Kong

Band	Channel Number	Channel Freq. (MHz)	26dB EBW		99% OBW		Limit (MHz)	Verdict
			Ant0	Ant1	Ant0	Ant1		
UNII Band I	CH36	5180	21.38	21.6	17.91	17.947	N/A	N/A
	CH40	5200	21.32	21.53	17.891	17.941	N/A	N/A
	CH48	5240	21.31	21.34	17.889	17.954	N/A	N/A
UNII Band II-A	CH52	5260	21.63	21.71	17.894	17.924	N/A	N/A
	CH56	5280	21.42	21.73	17.902	17.908	N/A	N/A
	CH64	5320	21.27	21.22	17.845	17.877	N/A	N/A
UNII Band II-C	CH100	5500	21.3	21.77	17.896	17.893	N/A	N/A
	CH120	5600	21.28	21.5	17.875	17.958	N/A	N/A
	CH140	5700	21.29	21.25	17.833	17.89	N/A	N/A
UNII Band III	CH149	5745	18.84	18.82	17.42	17.463	N/A	N/A
	CH157	5785	21.41	21.34	18	17.824	N/A	N/A
	CH165	5825	21.24	21.77	17.918	17.95	N/A	N/A

Note:
N/A (Not Applicable)

802.11n(VHT40) mode

Temperature : 28°C Test Date : September 29, 2017
 Humidity : 65 % Test By: King Kong

Band	Channel Number	Channel Freq. (MHz)	26dB EBW		99% OBW		Limit (MHz)	Verdict
			Ant0	Ant1	Ant0	Ant1		
UNII Band I	CH38	5190	39.92	39.97	36.396	36.468	N/A	N/A
	CH46	5230	39.77	40.21	36.328	36.404	N/A	N/A
UNII Band II-A	CH54	5270	40.09	39.71	36.34	36.339	N/A	N/A
	CH62	5310	40.31	40.04	36.323	36.312	N/A	N/A
UNII Band II-C	CH102	5510	40.04	40.23	36.297	36.361	N/A	N/A
	CH118	5590	40.14	40	36.36	36.368	N/A	N/A
	CH134	5670	39.86	39.92	36.381	36.407	N/A	N/A
UNII Band III	CH151	5755	39.95	39.82	36.454	36.496	N/A	N/A
	CH159	5795	40.52	39.73	36.387	36.372	N/A	N/A

Note:
N/A (Not Applicable)

802.11ac(VHT40) mode

Temperature : 28°C Test Date : September 29, 2017
 Humidity : 65 % Test By: King Kong

Band	Channel Number	Channel Freq. (MHz)	26dB EBW		99% OBW		Limit (MHz)	Verdict
			Ant0	Ant1	Ant0	Ant1		
UNII Band I	CH38	5190	40.02	40.17	36.372	36.405	N/A	N/A
	CH46	5230	39.64	39.59	36.309	36.311	N/A	N/A
UNII Band II-A	CH54	5270	40.05	40.08	36.366	36.322	N/A	N/A
	CH62	5310	39.77	38.89	36.256	36.303	N/A	N/A
UNII Band II-C	CH102	5510	39.66	40.11	36.415	36.392	N/A	N/A
	CH118	5590	39.89	39.9	36.376	36.385	N/A	N/A
	CH134	5670	39.66	39.87	36.377	36.366	N/A	N/A
UNII Band III	CH151	5755	39.78	40.06	36.415	36.452	N/A	N/A
	CH159	5795	40.31	39.91	36.447	36.39	N/A	N/A

Note:
N/A (Not Applicable)

802.11ac(VHT80) mode

Temperature : 28°C Test Date : September 29, 2017
Humidity : 65 % Test By: King Kong

Band	Channel Number	Channel Freq. (MHz)	26dB EBW		99% OBW		Limit (MHz)	Verdict
			Ant0	Ant1	Ant0	Ant1		
UNII Band I	CH42	5210	81.77	81.71	75.739	75.852	N/A	N/A
UNII Band II-A	CH58	5290	81.3	81.13	75.778	75.846	N/A	N/A
UNII Band II-C	CH106	5530	81.2	81.07	75.737	75.563	N/A	N/A
	CH122	5610	82.33	81.31	75.903	75.938	N/A	N/A
UNII Band III	CH155	5775	81.32	81.31	75.875	75.046	N/A	N/A

Note:
N/A (Not Applicable)

UNII Band III

Temperature : 28°C Test Date : September 29, 2017
Humidity : 65 % Test By: King Kong

Operation Mode	Channel Number	Channel Freq. (MHz)	6dB EBW		Limit (MHz)	Verdict
			Ant0	Ant1		
802.11a	CH149	5745	16.35	16.12	500	PASS
	CH157	5785	16.37	16.38	500	PASS
	CH165	5825	16.38	16.39	500	PASS
802.11n (VHT20)	CH149	5745	16.88	16.64	500	PASS
	CH157	5785	17.31	17.51	500	PASS
	CH165	5825	17.59	17.67	500	PASS
802.11ac (VHT20)	CH149	5745	16.69	16.77	500	PASS
	CH157	5785	17.41	17.6	500	PASS
	CH165	5825	17.61	17.62	500	PASS
802.11n (VHT40)	CH151	5755	35.75	35.77	500	PASS
	CH159	5795	36.05	36.29	500	PASS
802.11ac (VHT40)	CH151	5755	35.79	35.8	500	PASS
	CH159	5795	36.33	36.32	500	PASS
802.11ac (VHT80)	CH155	5775	75.86	75.81	500	PASS

Note:
N/A (Not Applicable)

Emission Bandwidth & 99% Occupied Bandwidth UNII Band I
 Test Model 802.11a Frequency (MHz) 5180
 Ant0

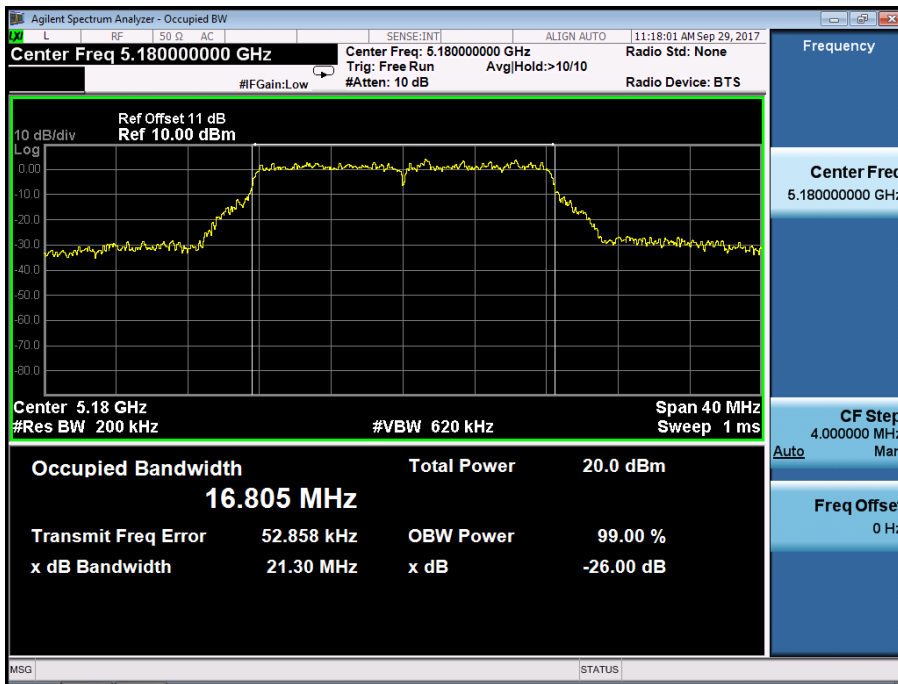

Ant1

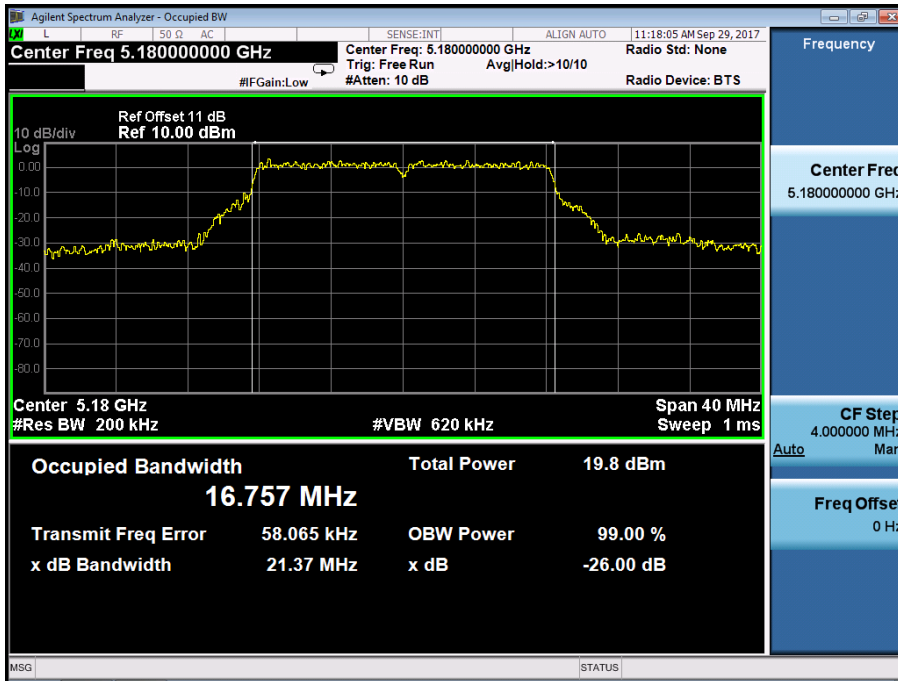

Emission Bandwidth & 99% Occupied Bandwidth UNII Band I
 Test Model 802.11a Frequency (MHz) 5200
Ant0

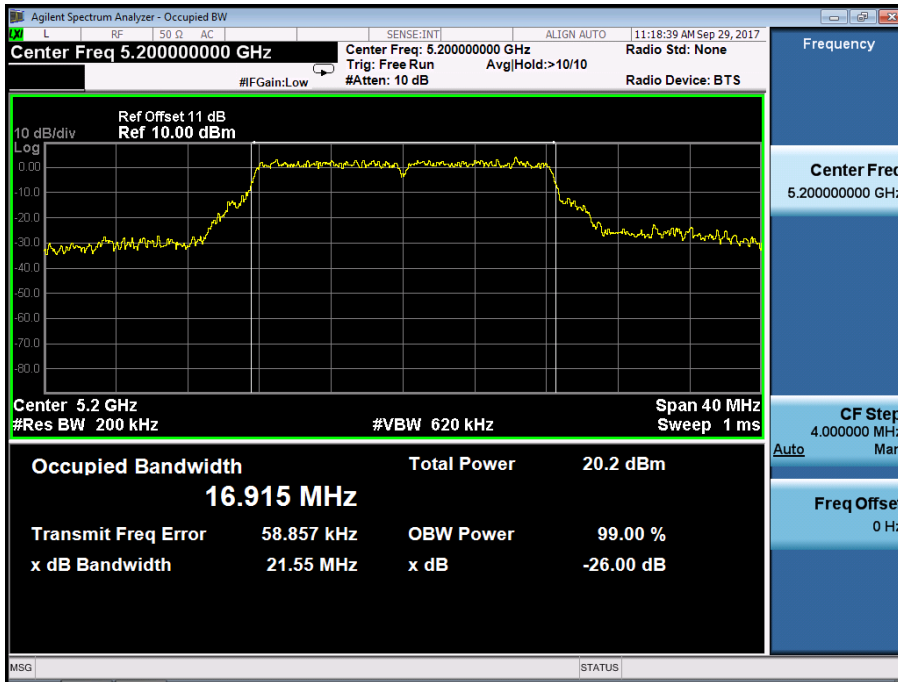

Ant1

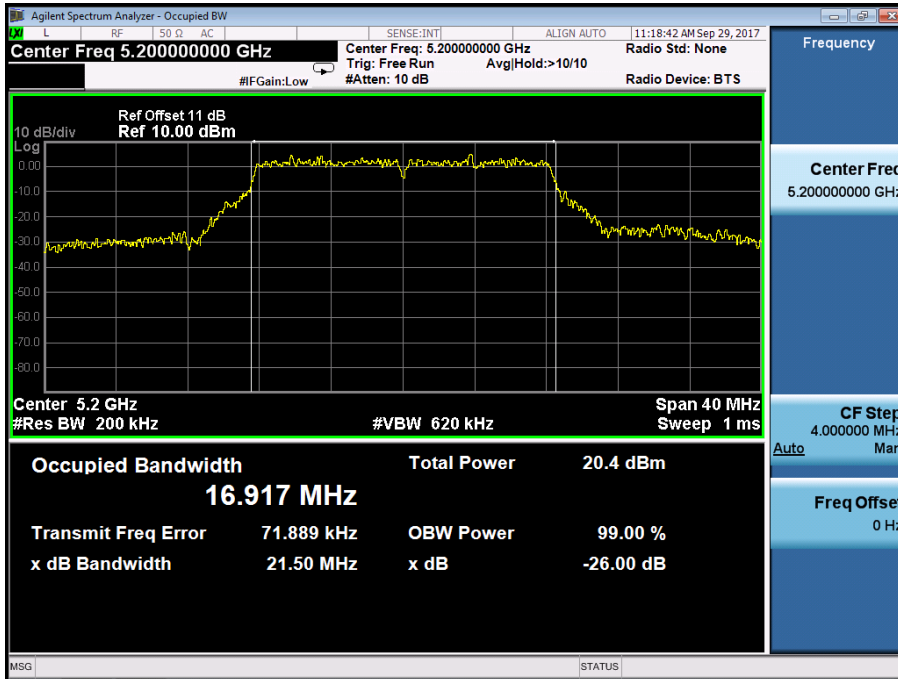

Emission Bandwidth & 99% Occupied Bandwidth UNII Band I
 Test Model 802.11a Frequency (MHz) 5240
 Ant0

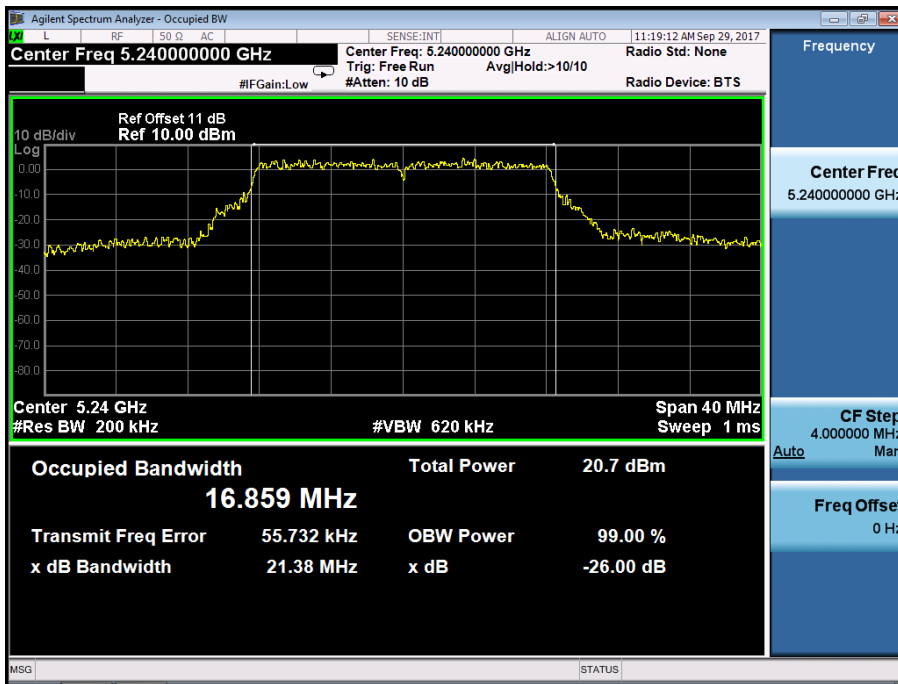

Ant1

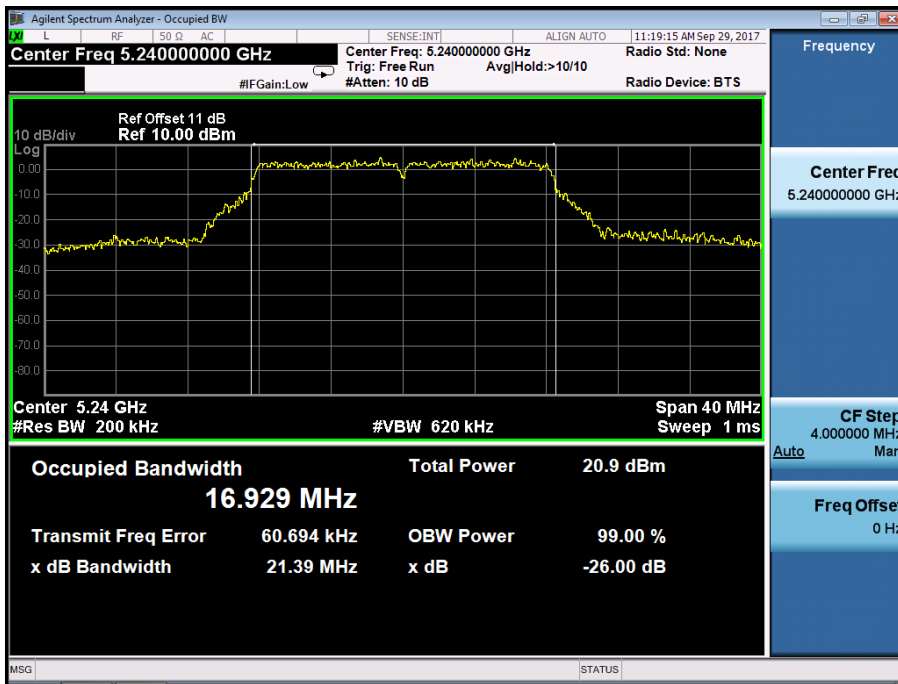

Emission Bandwidth&99% Occupied Bandwidth UNII Band II-A
 Test Model 802.11a Frequency(MHz) 5260
Ant0

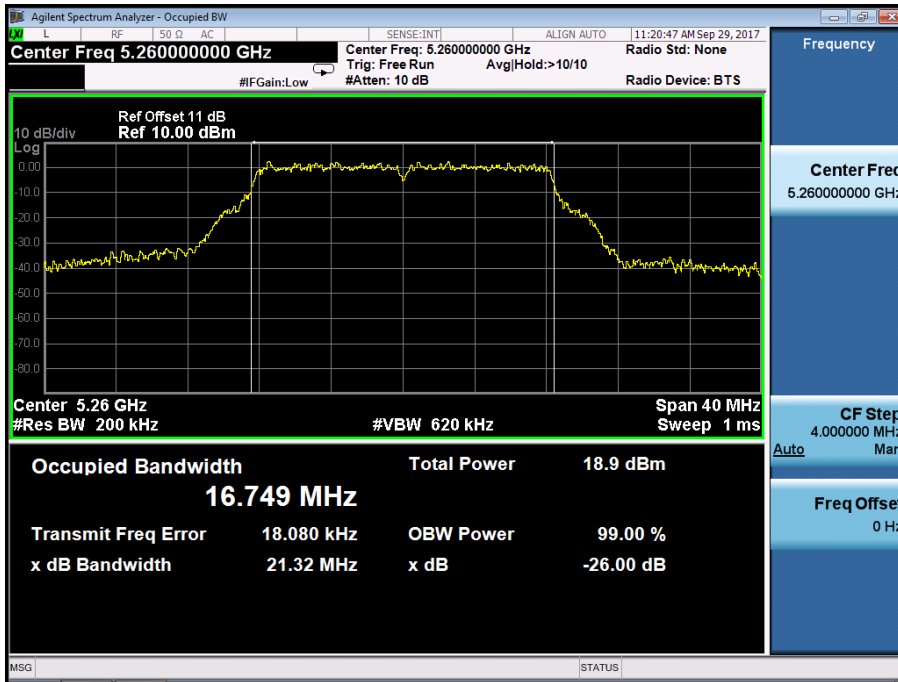

Ant1

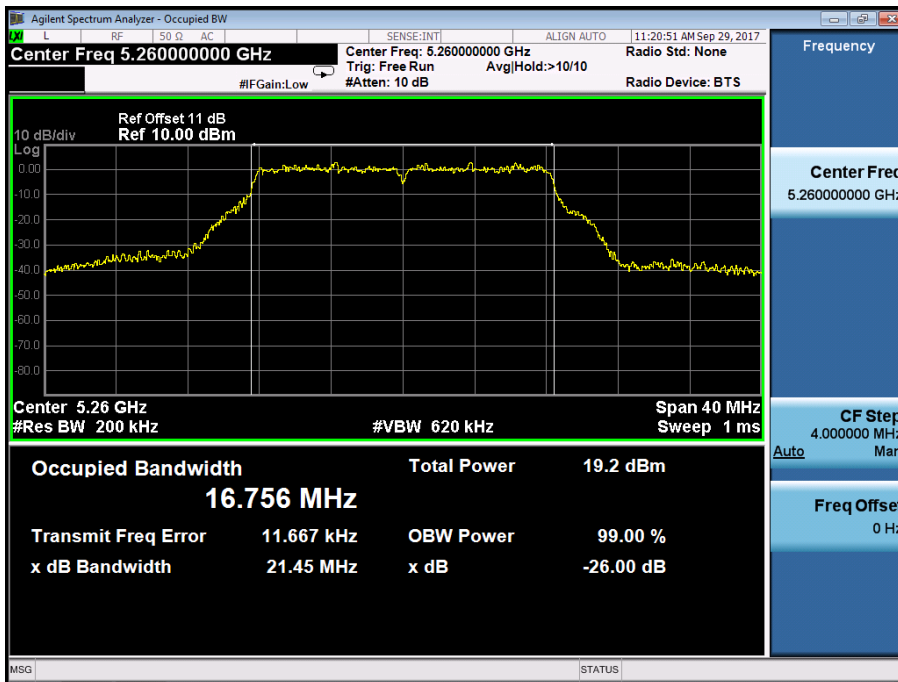

Emission Bandwidth&99% Occupied Bandwidth UNII Band II-A
 Test Model 802.11a Frequency(MHz) 5280
Ant0

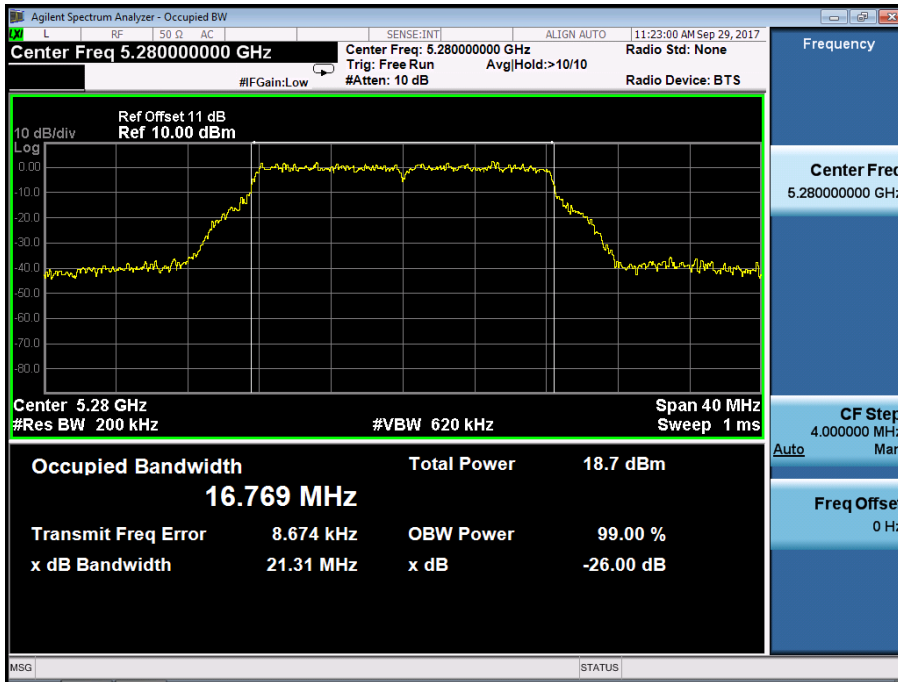

Ant1

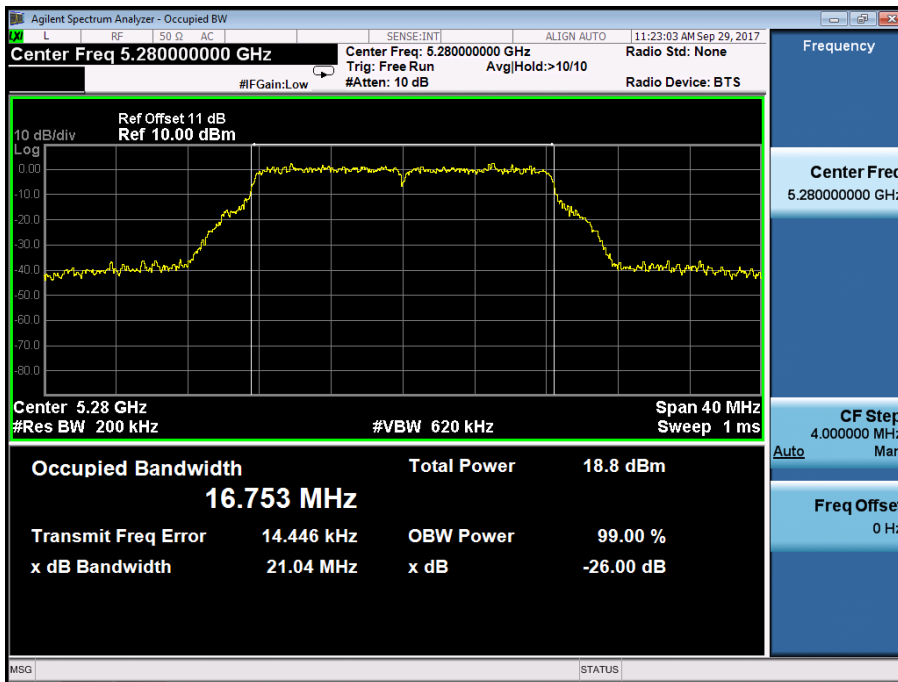

Emission Bandwidth & 99% Occupied Bandwidth UNII Band II-A
 Test Model 802.11a Frequency (MHz) 5320
Ant0

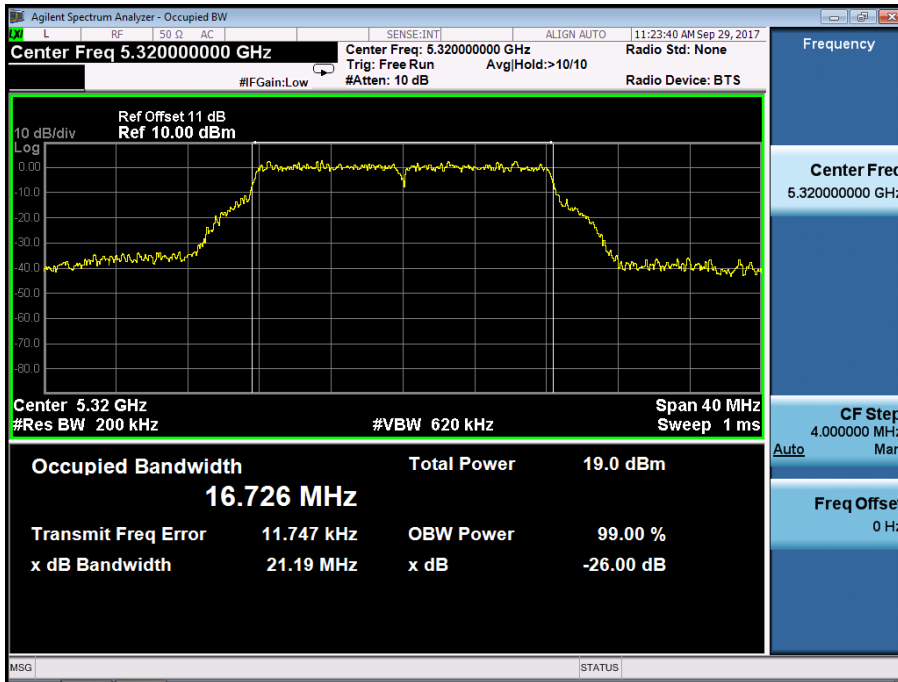

Ant1

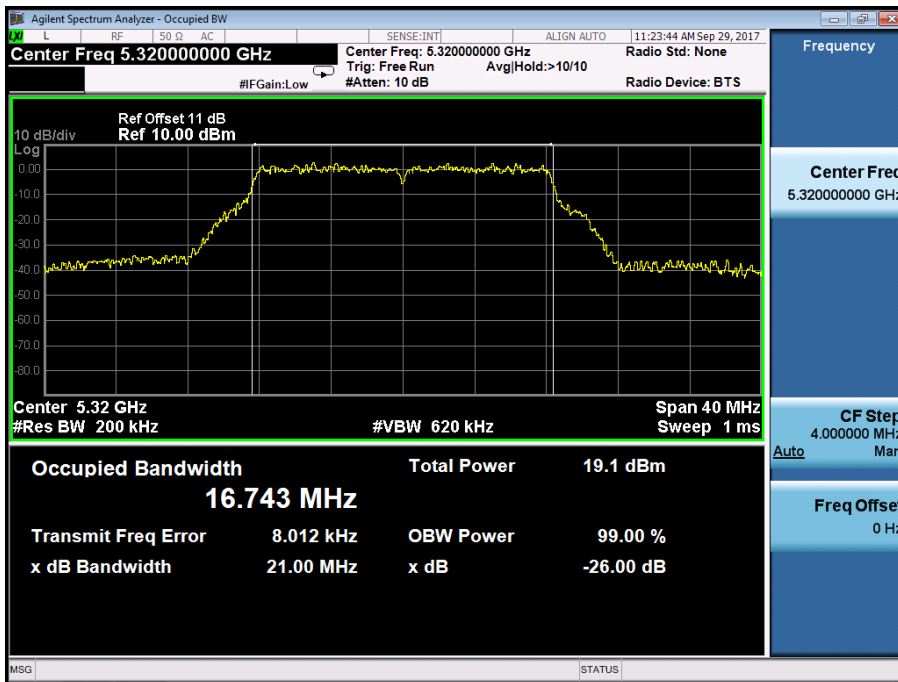

Emission Bandwidth&99% Occupied Bandwidth UNII Band II-C
 Test Model 802.11a Frequency(MHz) 5500
Ant0

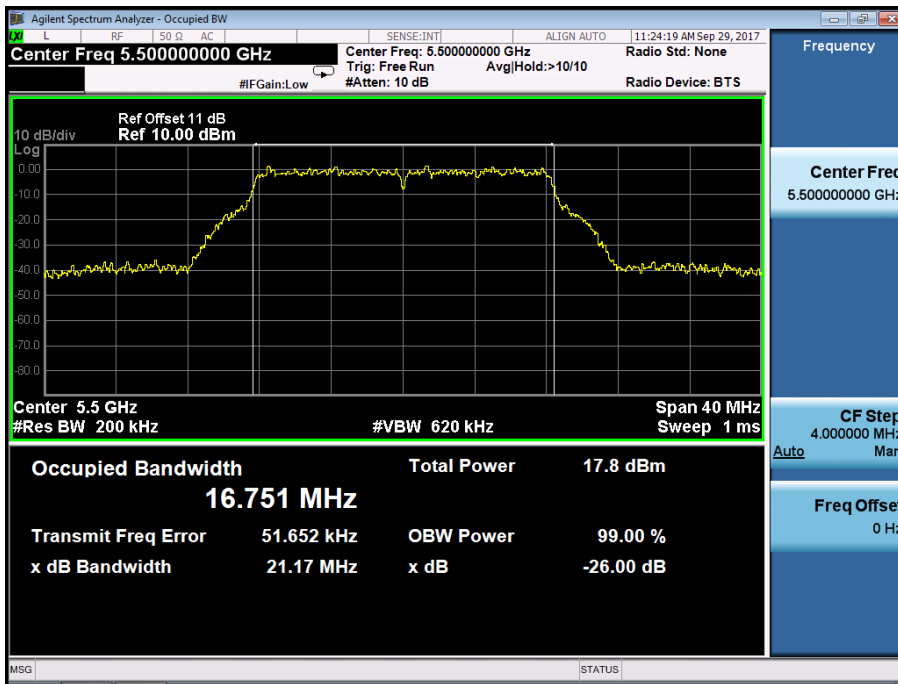

Ant1

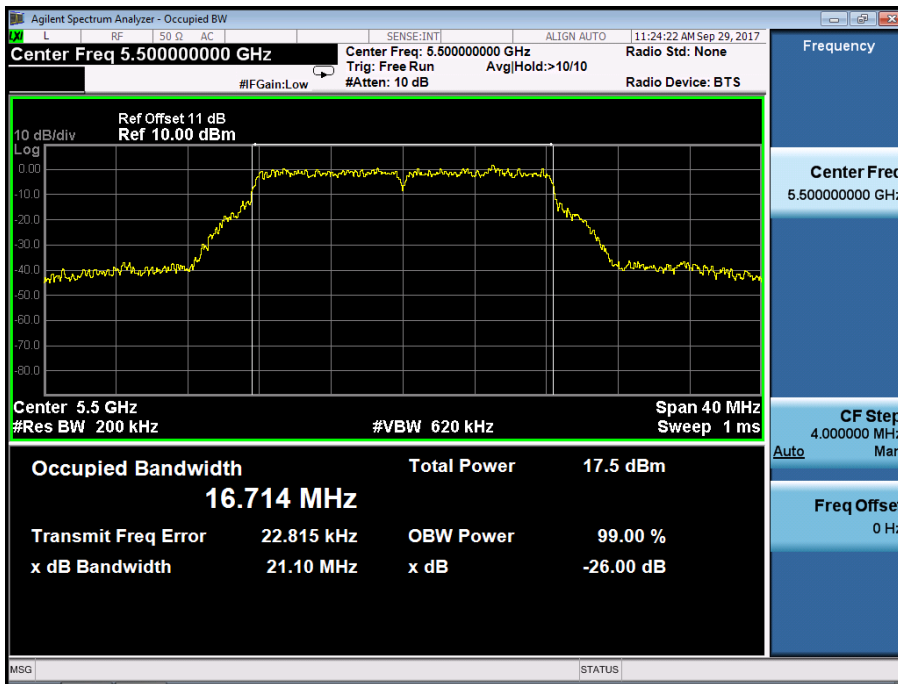

Emission Bandwidth & 99% Occupied Bandwidth UNII Band II-C
 Test Model 802.11a Frequency (MHz) 5600
Ant0

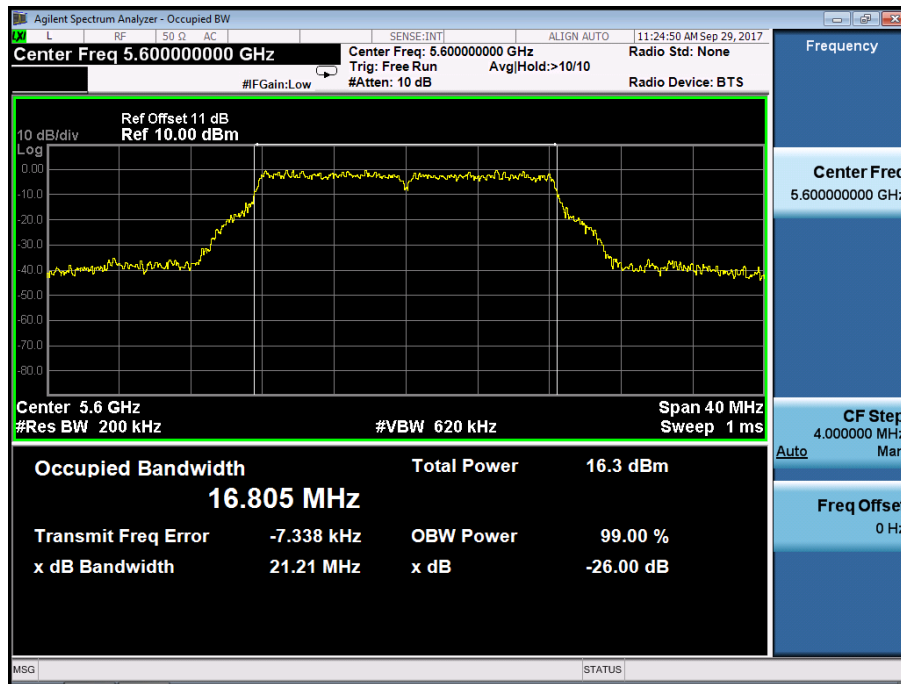

Ant1

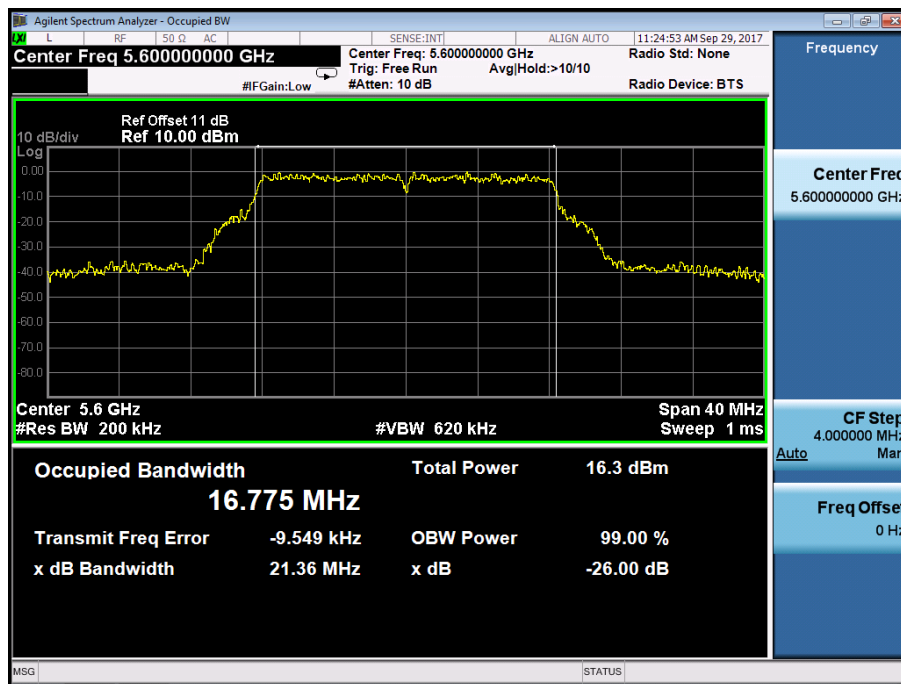

Emission Bandwidth&99% Occupied Bandwidth UNII Band II-C
 Test Model 802.11a Frequency(MHz) 5700
Ant0

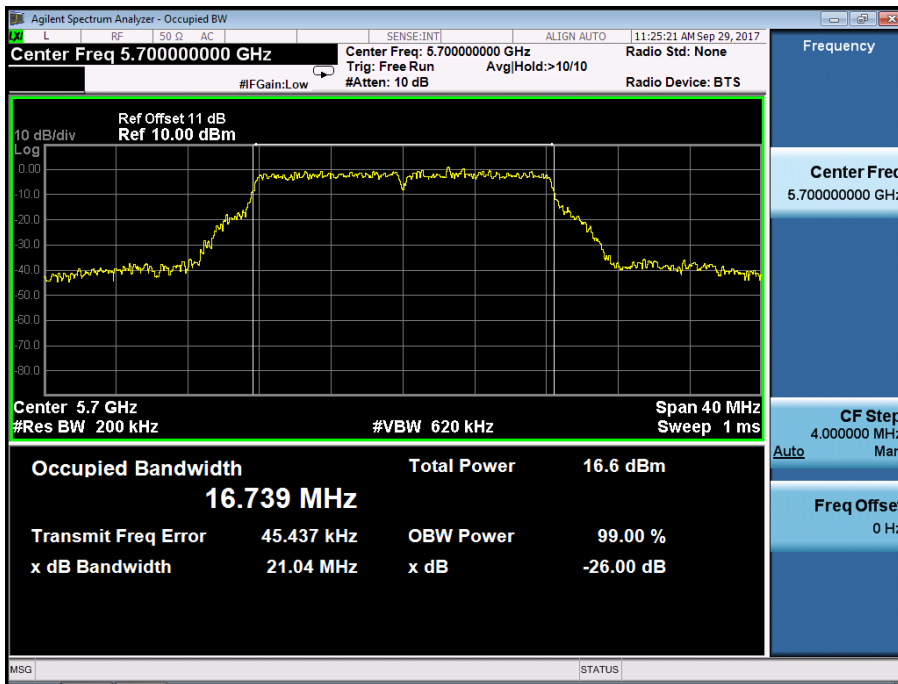

Ant1

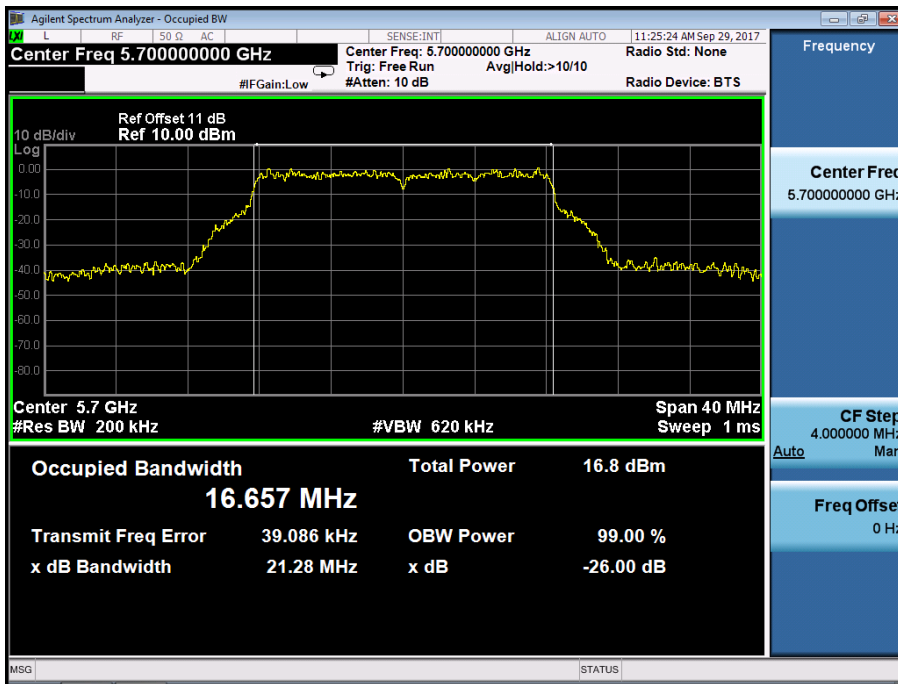

Emission Bandwidth & 99% Occupied Bandwidth UNII Band III
 Test Model 802.11a Frequency (MHz) 5745
Ant0

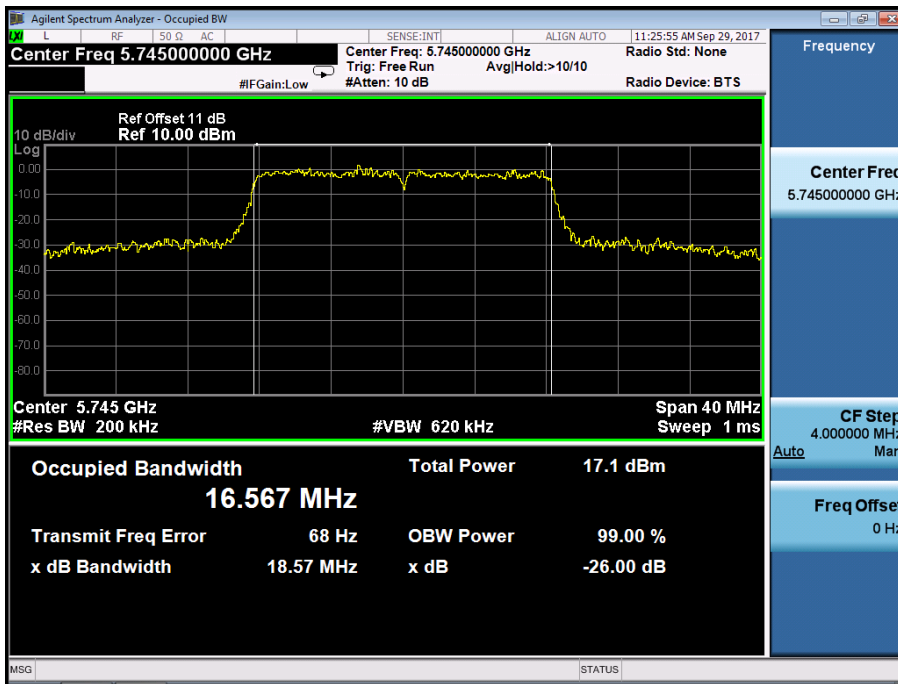

Ant1

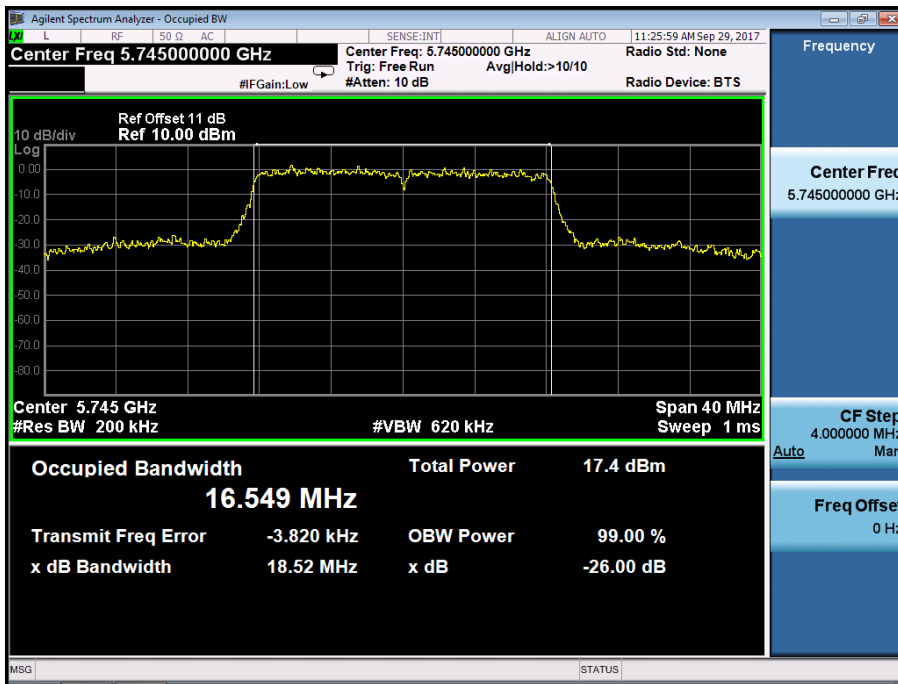

Emission Bandwidth & 99% Occupied Bandwidth UNII Band III
 Test Model 802.11a Frequency (MHz) 5785
Ant0

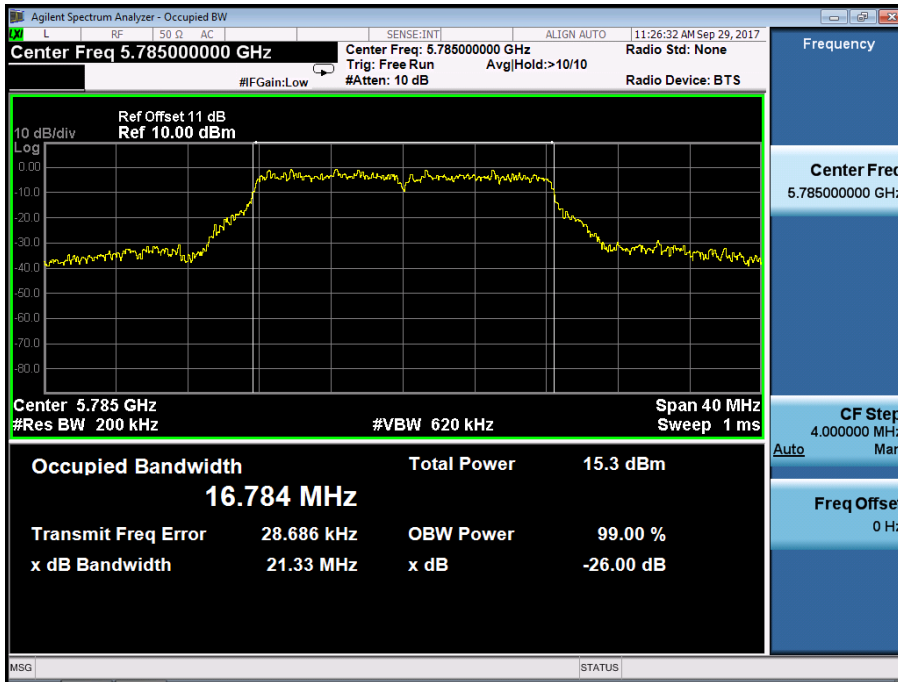

Ant1

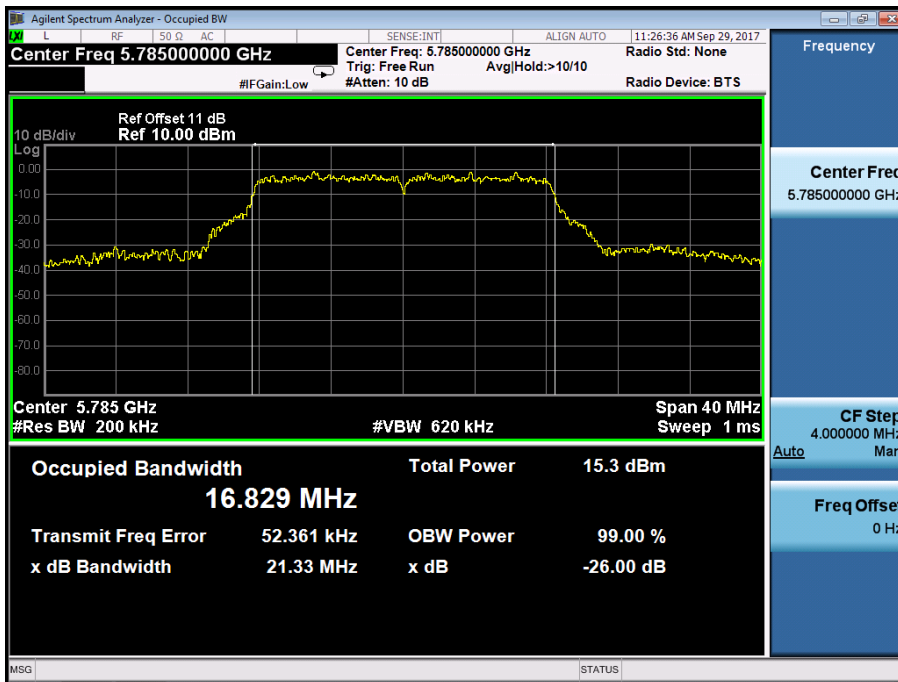

Emission Bandwidth & 99% Occupied Bandwidth UNII Band III
 Test Model 802.11a Frequency (MHz) 5825
Ant0

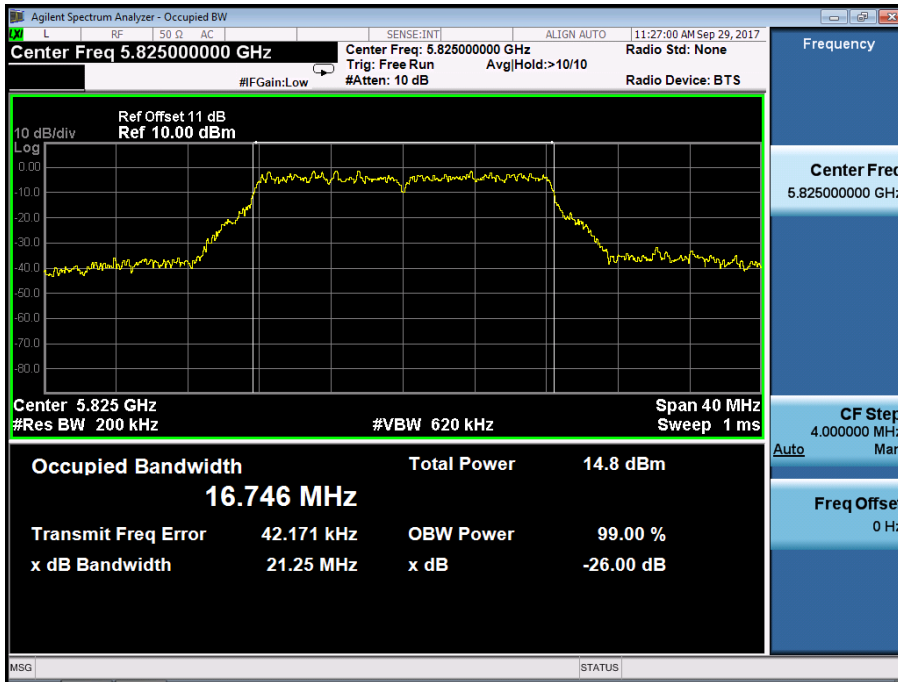

Ant1

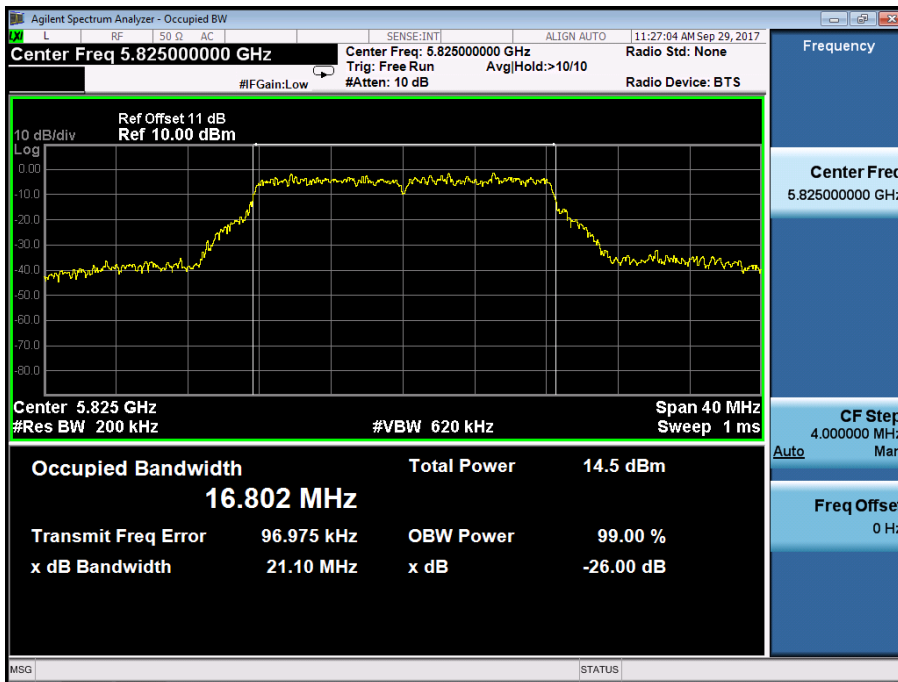

Emission Bandwidth & 99% Occupied Bandwidth UNII Band I
 Test Model 802.11n(VHT20) mode Frequency(MHz) 5180
 Ant0

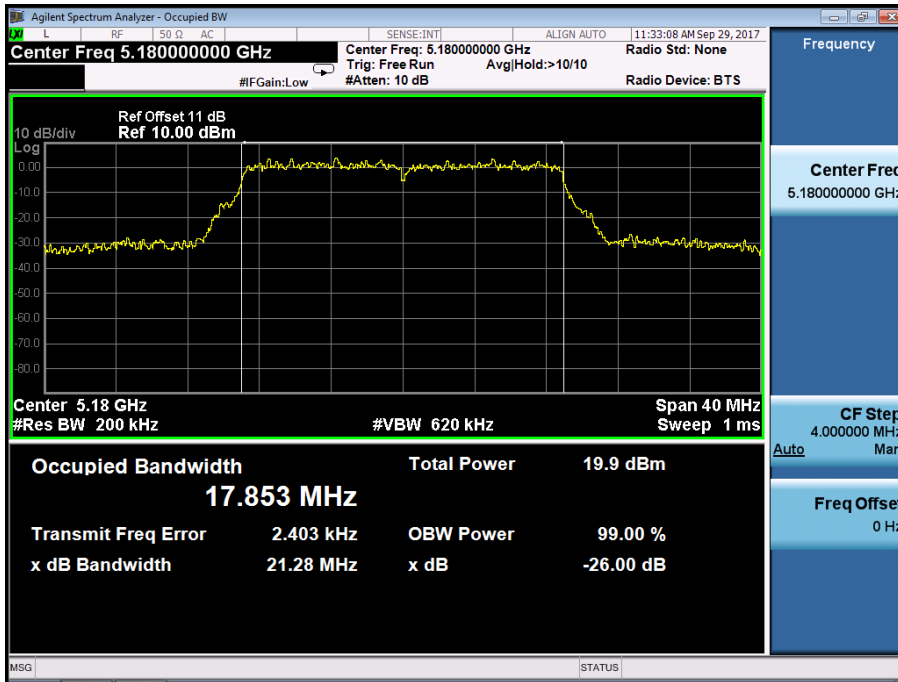

Ant1

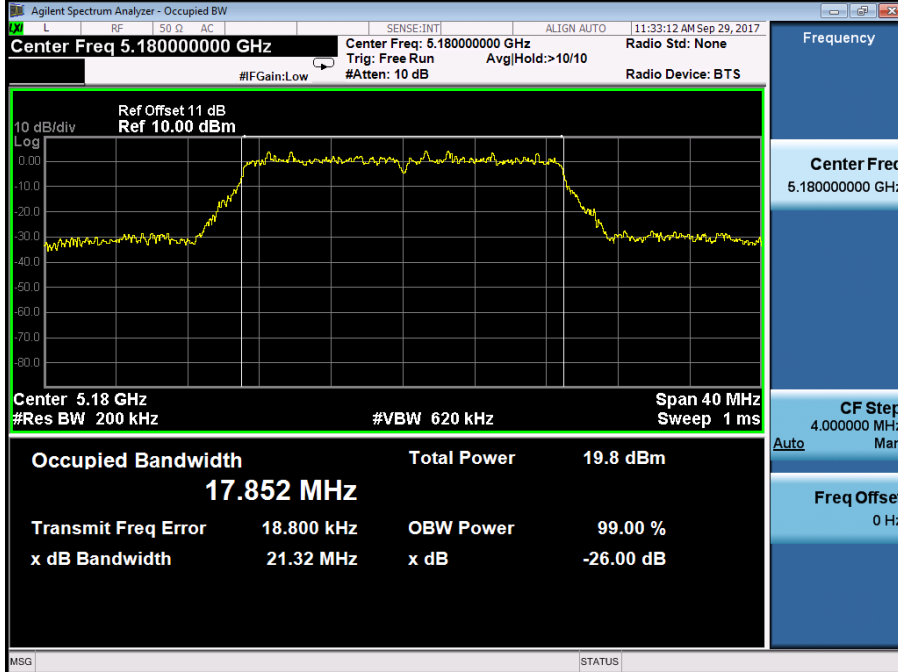

Emission Bandwidth&99% Occupied Bandwidth UNII Band I
 Test Model 802.11n(VHT20) mode Frequency(MHz) 5200
 Ant0

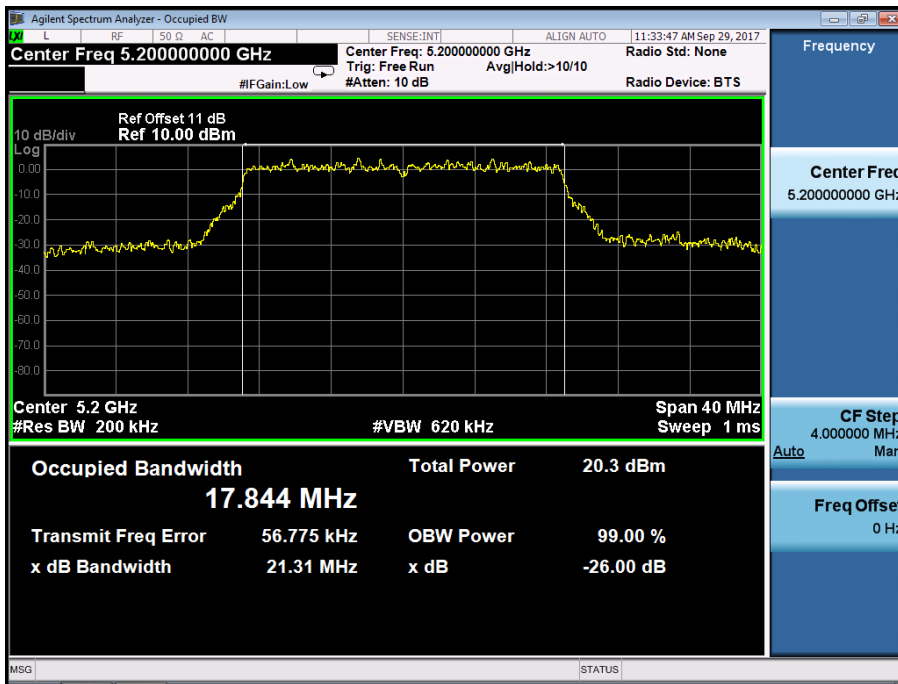

Ant1

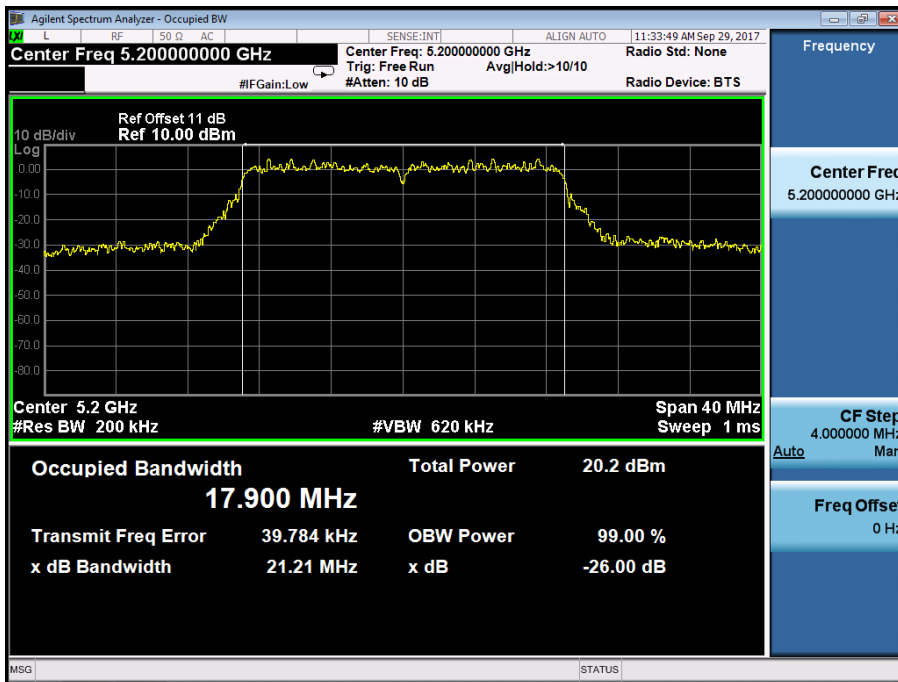

Emission Bandwidth&99% Occupied Bandwidth UNII Band I
 Test Model 802.11n(VHT20) mode Frequency(MHz) 5240
 Ant0

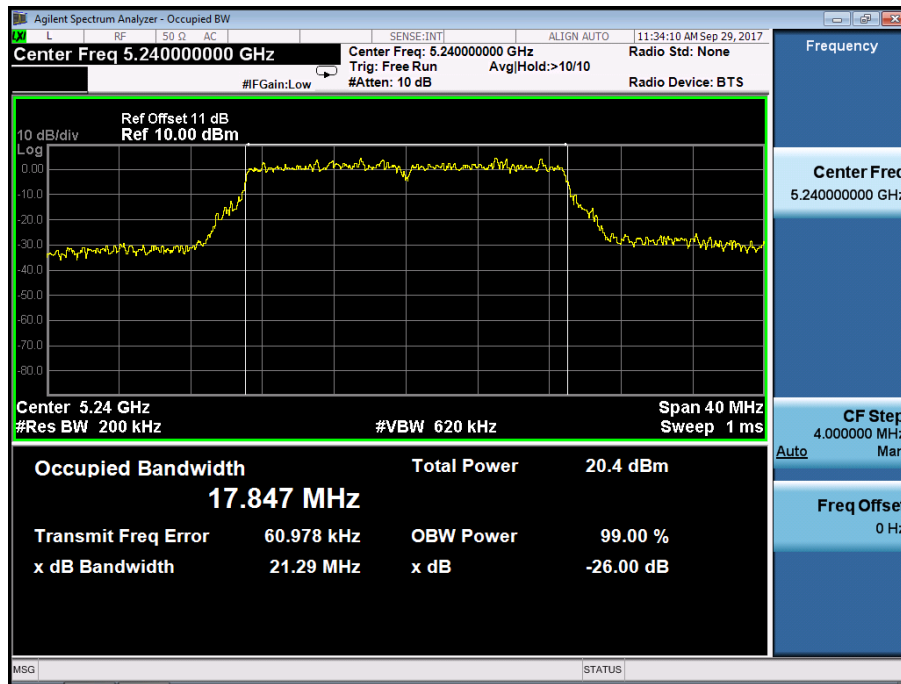

Ant1

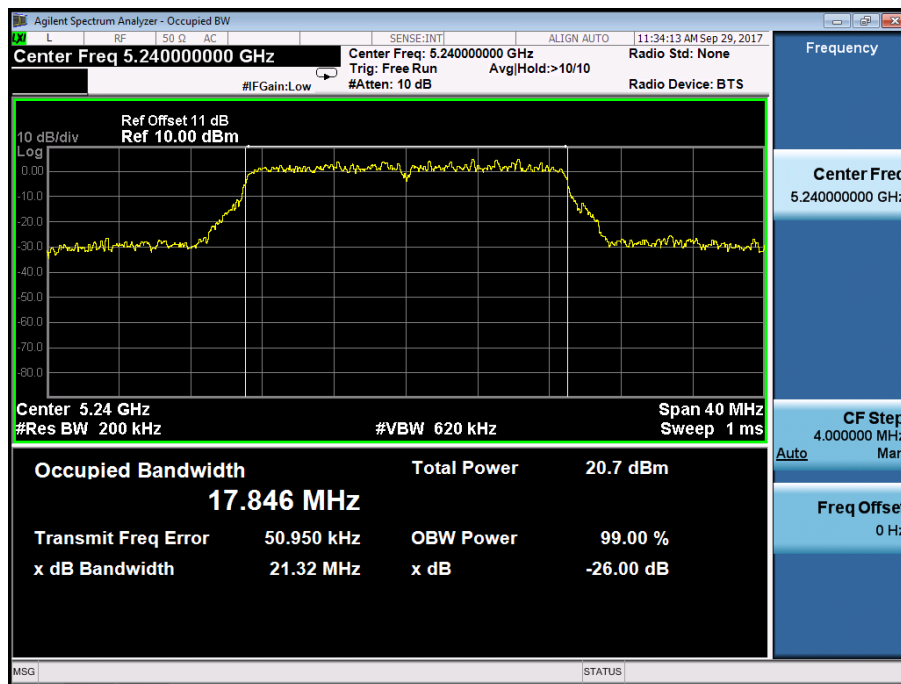

Emission Bandwidth&99% Occupied Bandwidth UNII Band II-A
 Test Model 802.11n(VHT20) mode Frequency(MHz) 5260
Ant0

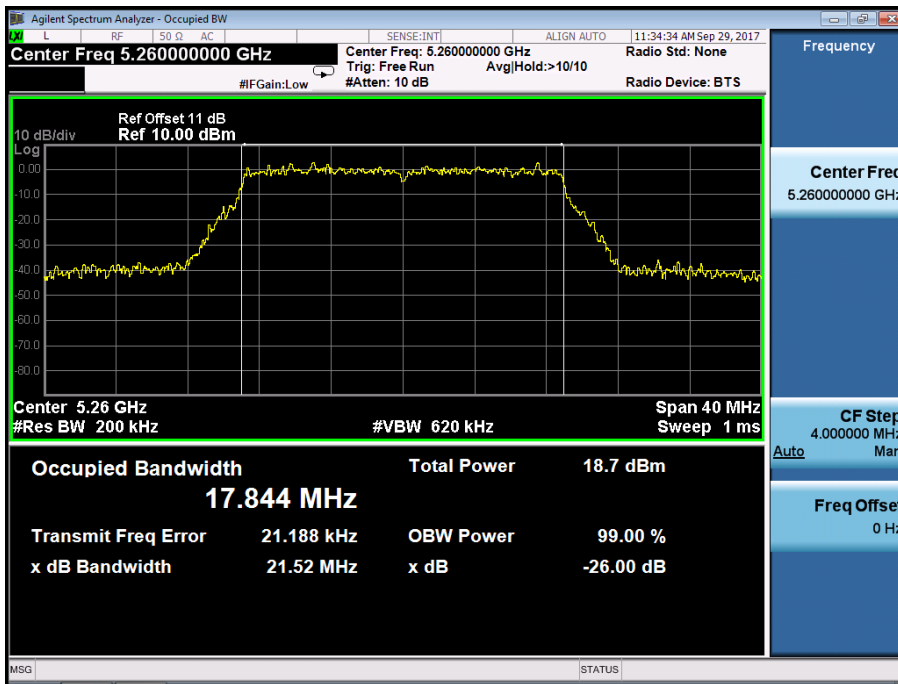

Ant1

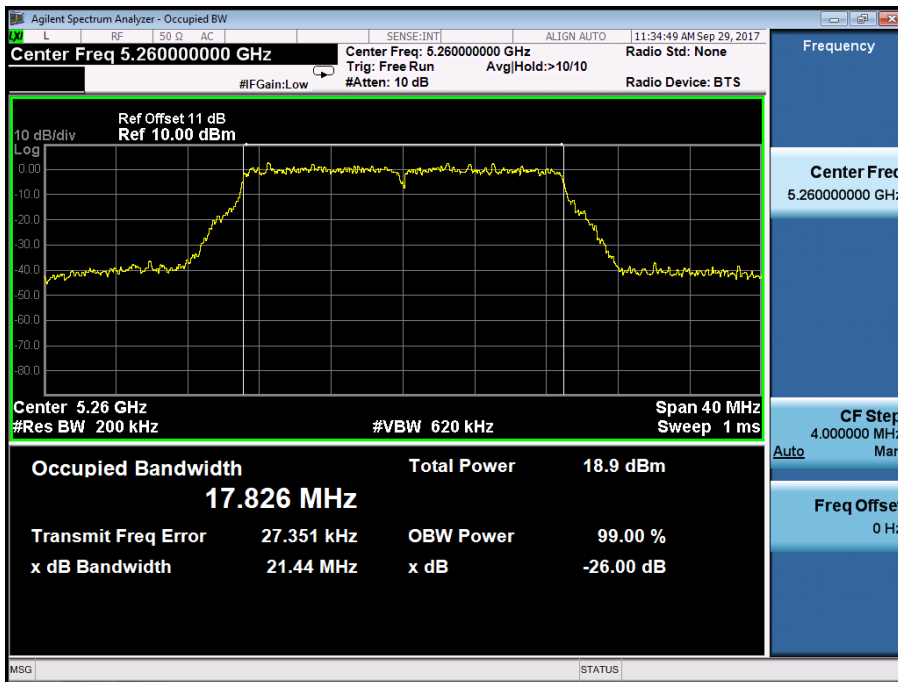

Emission Bandwidth & 99% Occupied Bandwidth UNII Band II-A
 Test Model 802.11n(VHT20) mode Frequency(MHz) 5280
Ant0

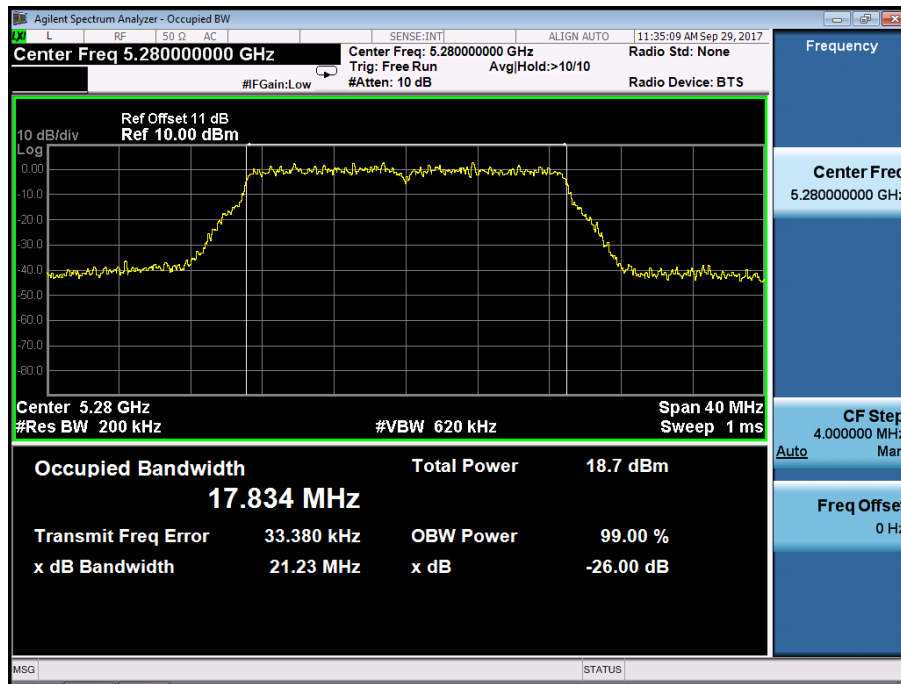

Ant1

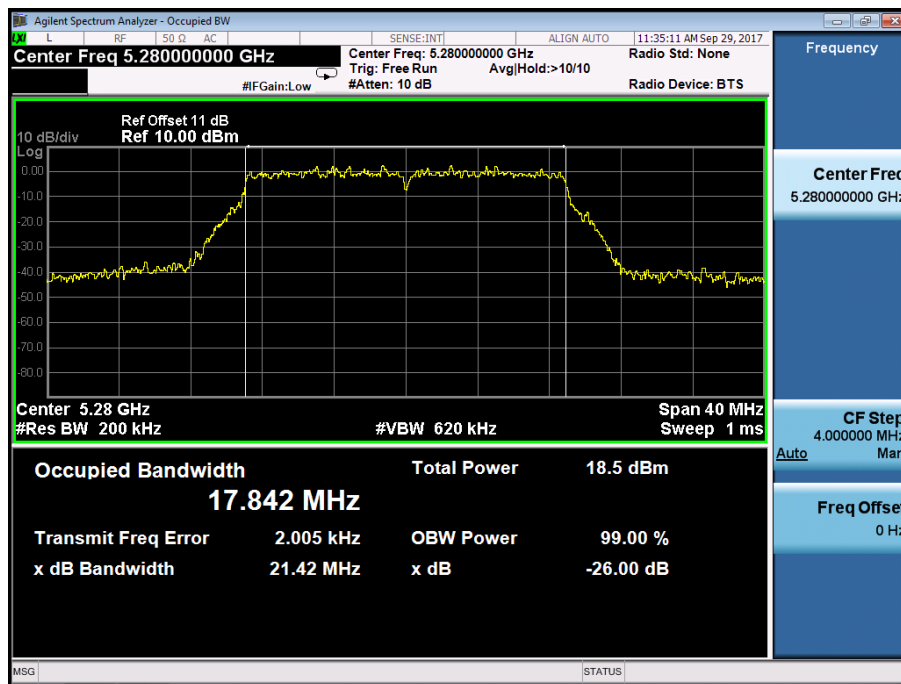

Emission Bandwidth & 99% Occupied Bandwidth UNII Band II-A
 Test Model 802.11n(VHT20) mode Frequency(MHz) 5320
Ant0

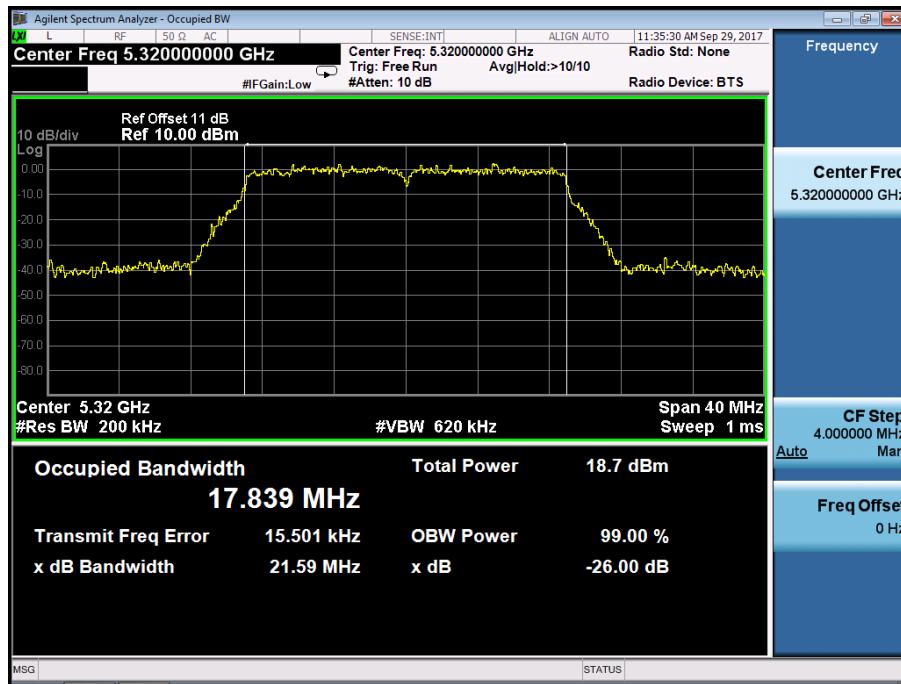

Ant1

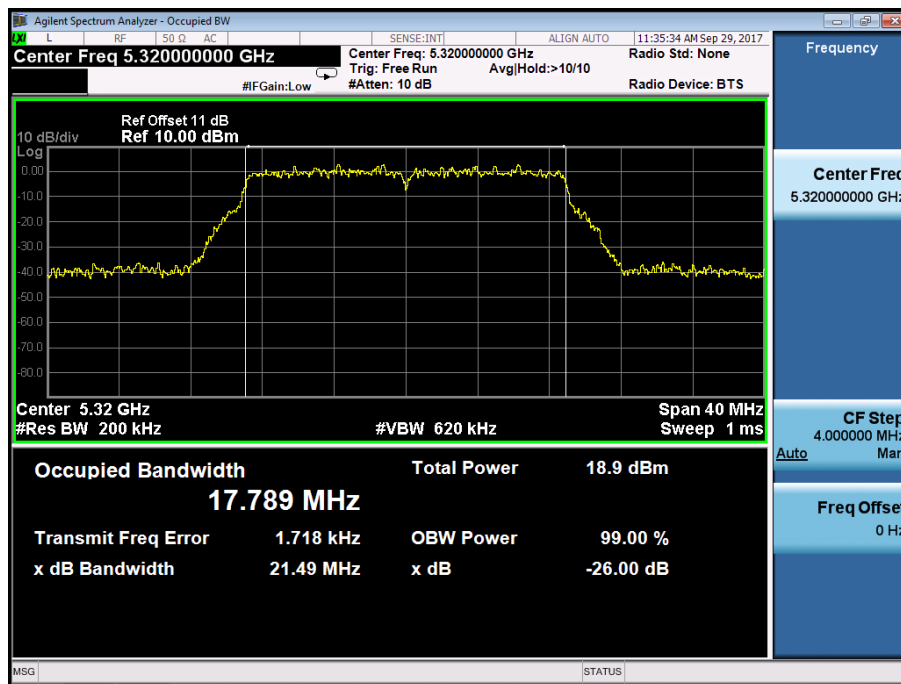

Emission Bandwidth & 99% Occupied Bandwidth UNII Band II-C
 Test Model 802.11n(VHT20) mode Frequency(MHz) 5500
Ant0

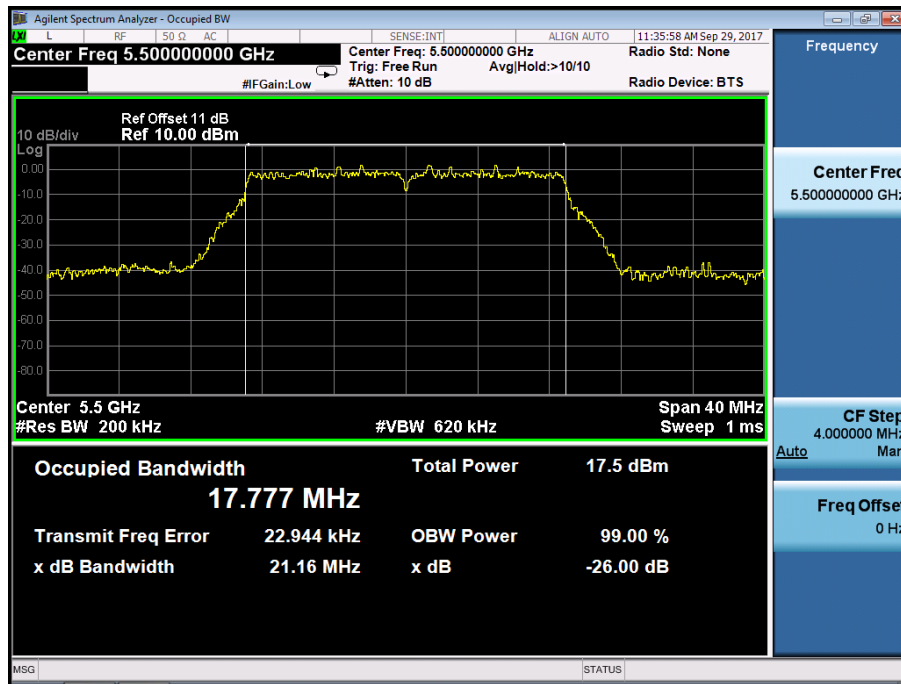

Ant1

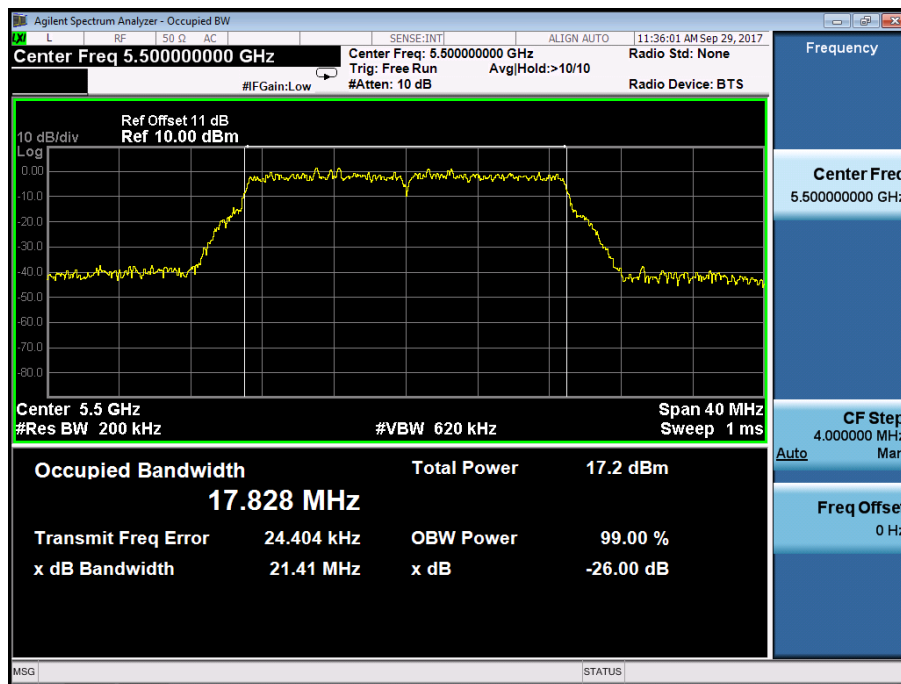

Emission Bandwidth&99% Occupied Bandwidth UNII Band II-C
 Test Model 802.11n(VHT20) mode Frequency(MHz) 5600
 Ant0

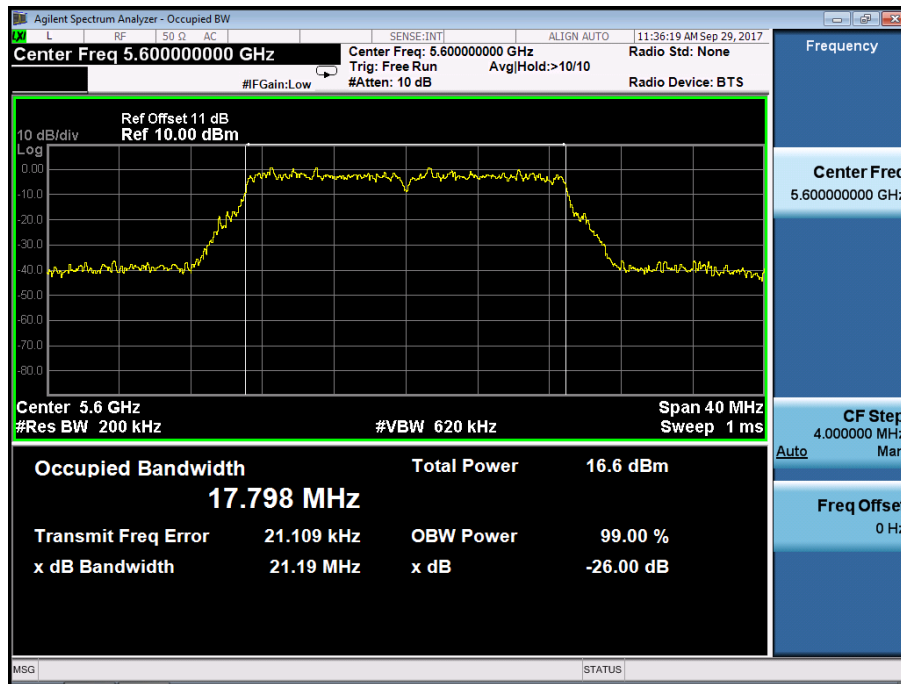

Ant1

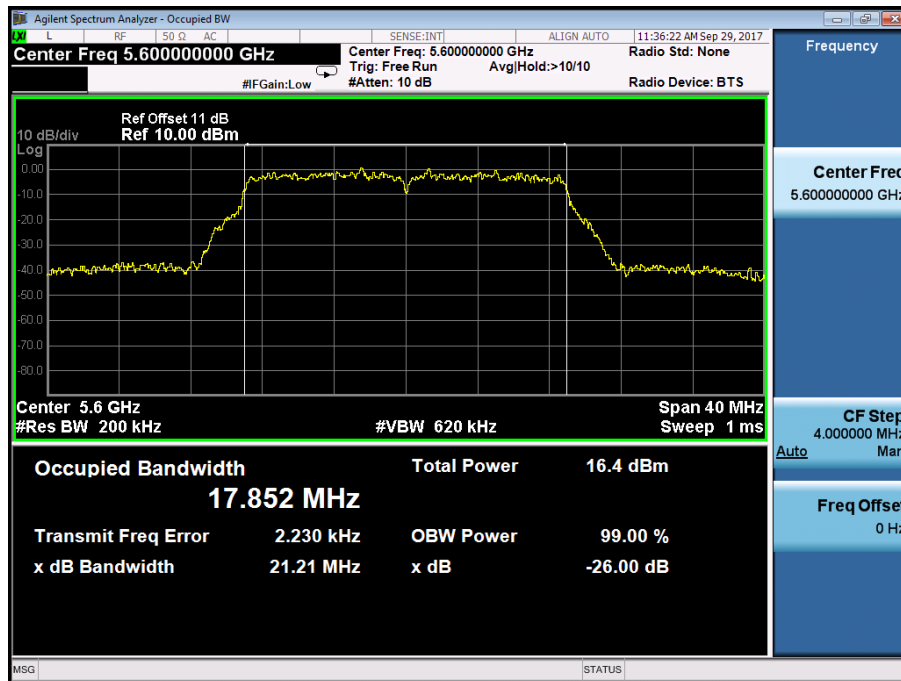

Emission Bandwidth & 99% Occupied Bandwidth UNII Band II-C
 Test Model 802.11n(VHT20) mode Frequency(MHz) 5700
Ant0

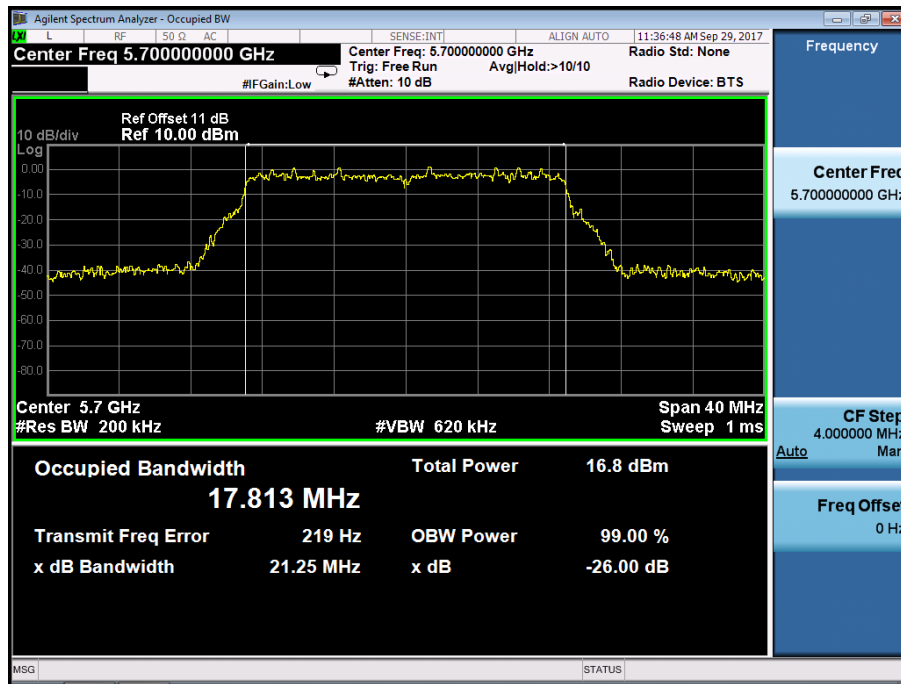

Ant1

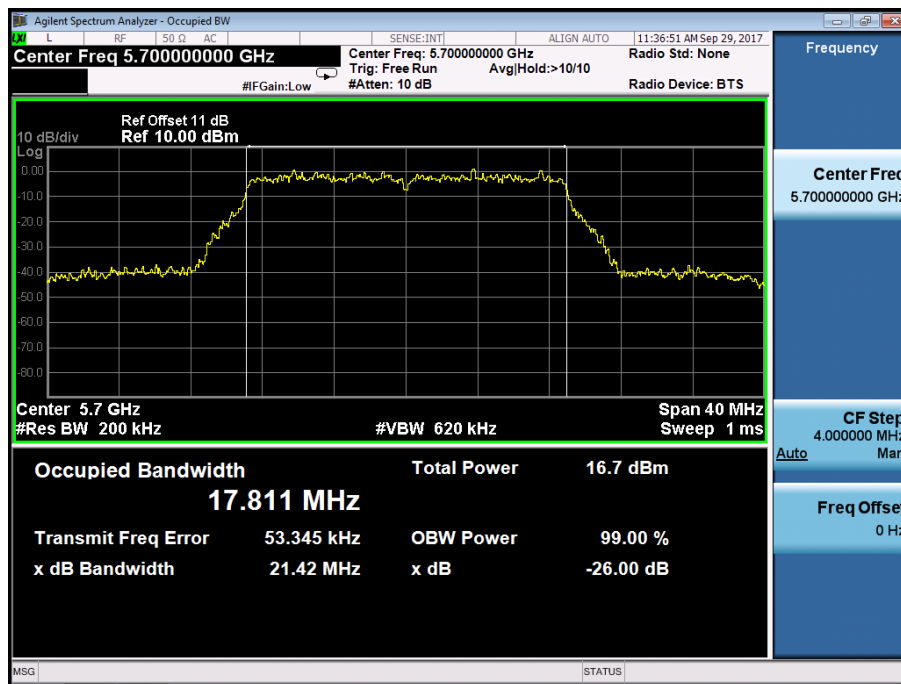

Emission Bandwidth & 99% Occupied Bandwidth UNII Band III
 Test Model 802.11n(VHT20) mode Frequency(MHz) 5745
 Ant0

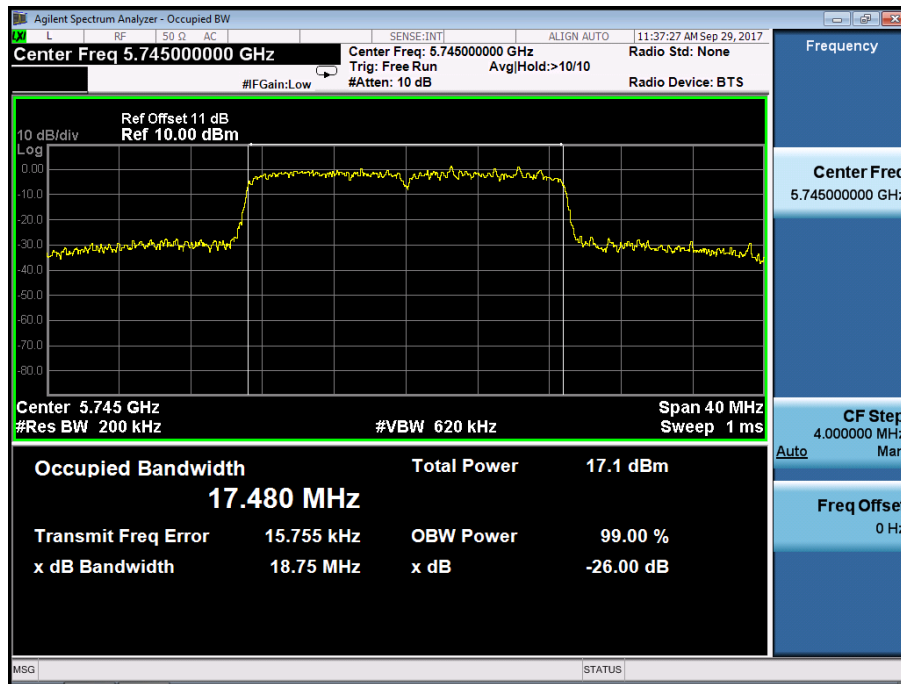

Ant1

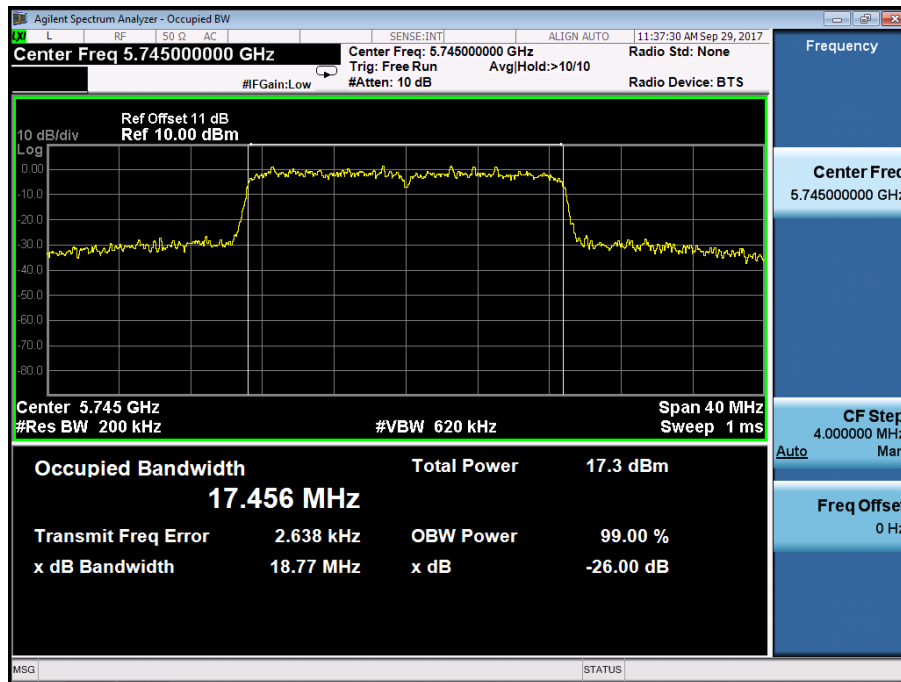

Emission Bandwidth&99% Occupied Bandwidth UNII Band III
 Test Model 802.11n(VHT20) mode Frequency(MHz) 5785
 Ant0

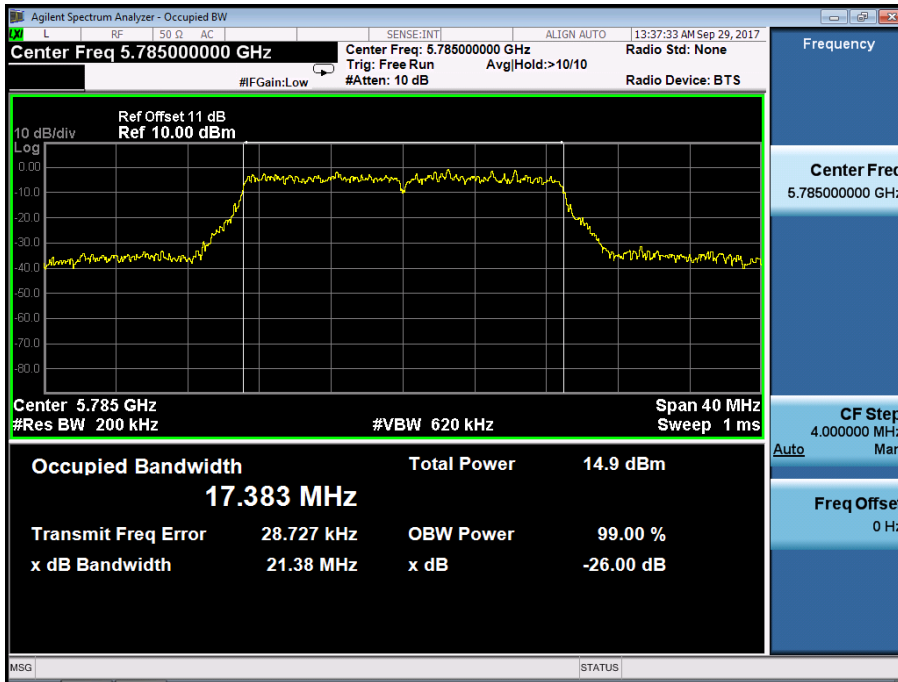

Ant1

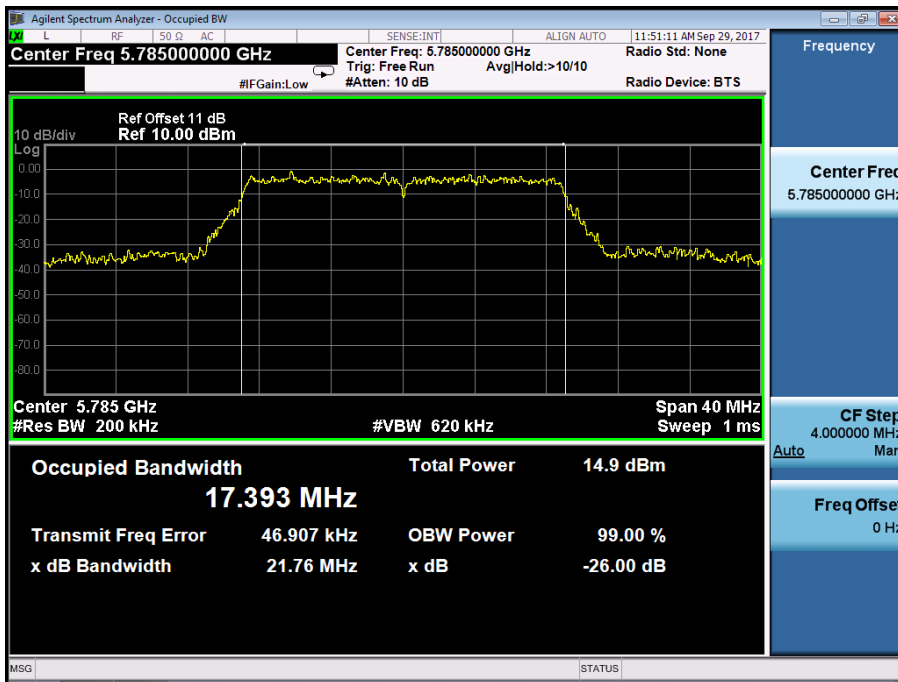

Emission Bandwidth & 99% Occupied Bandwidth UNII Band III
 Test Model 802.11n(VHT20) mode Frequency(MHz) 5825
Ant0

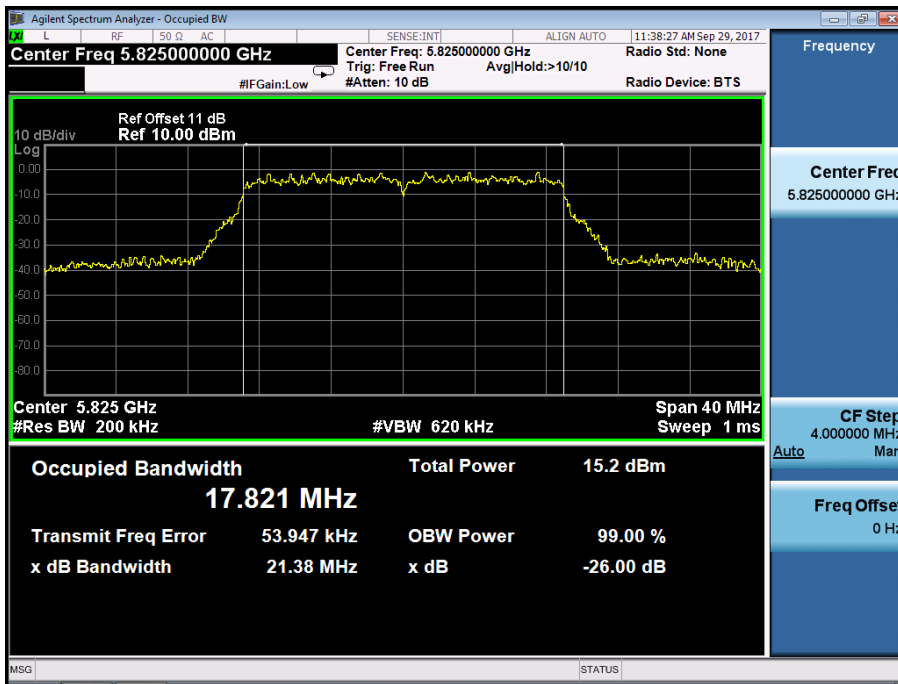

Ant1

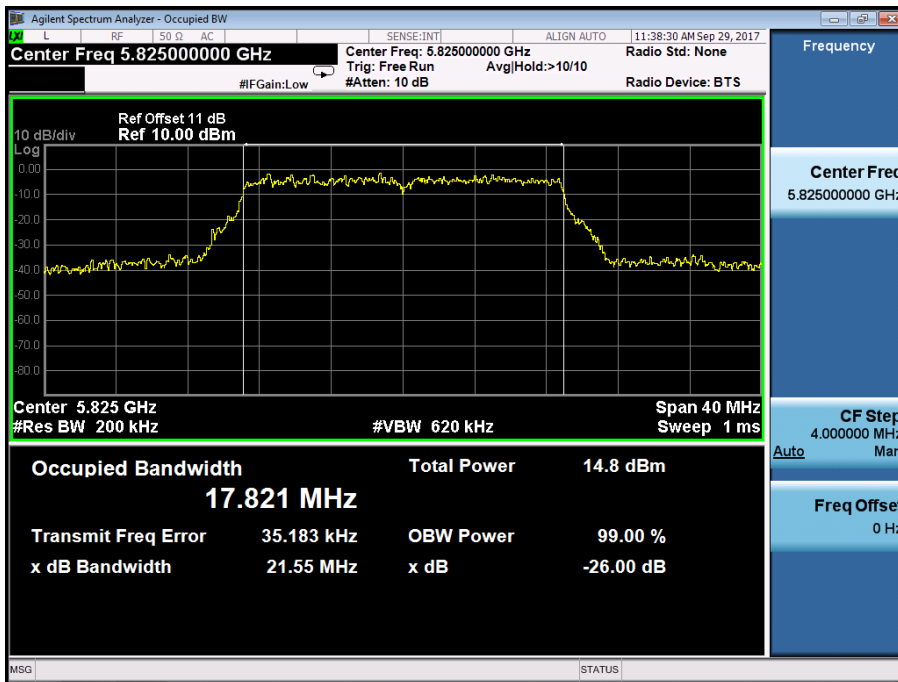

Emission Bandwidth & 99% Occupied Bandwidth UNII Band I
 Test Model 802.11ac(VHT20) mode Frequency(MHz) 5180
 Ant0

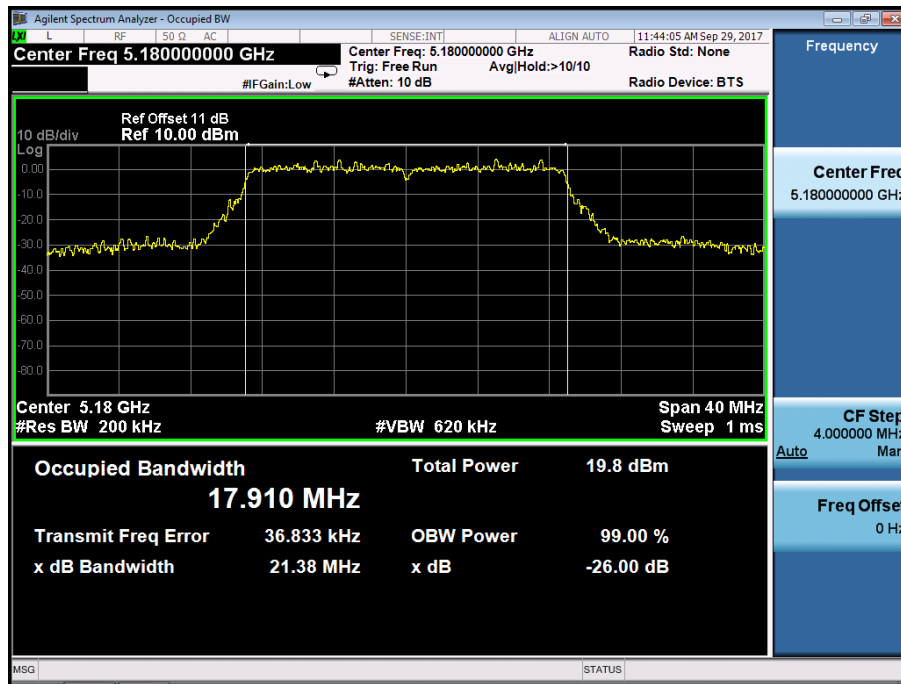

Ant1

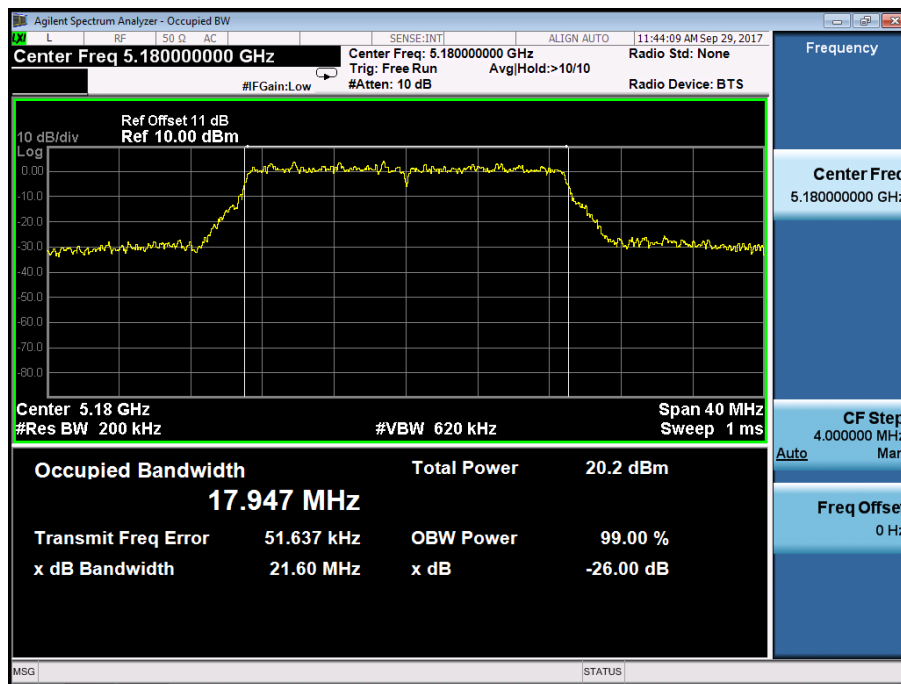

Emission Bandwidth&99% Occupied Bandwidth UNII Band I
 Test Model 802.11ac(VHT20) mode Frequency(MHz) 5200
 Ant0

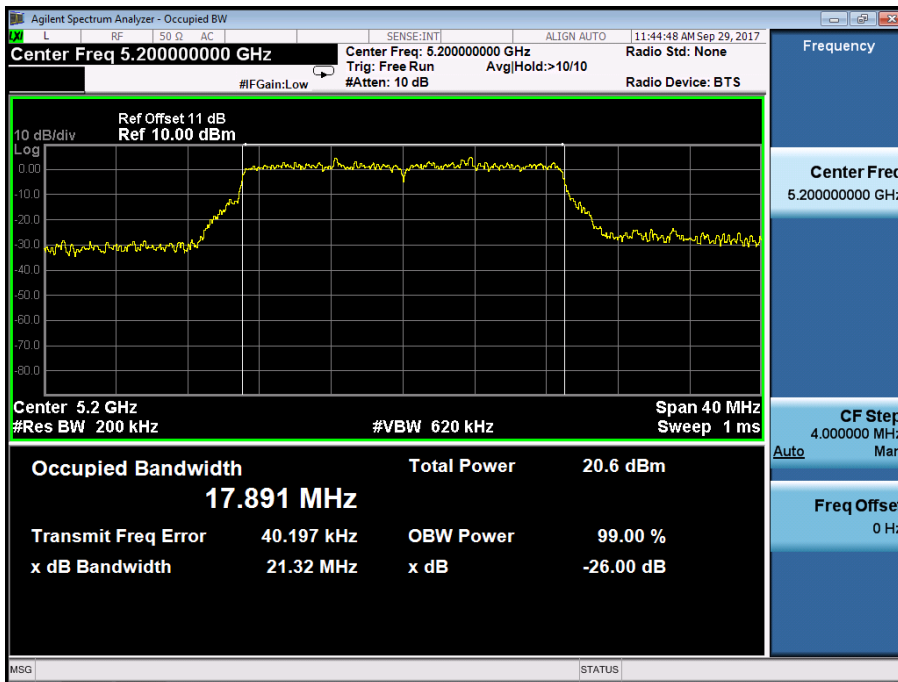

Ant1

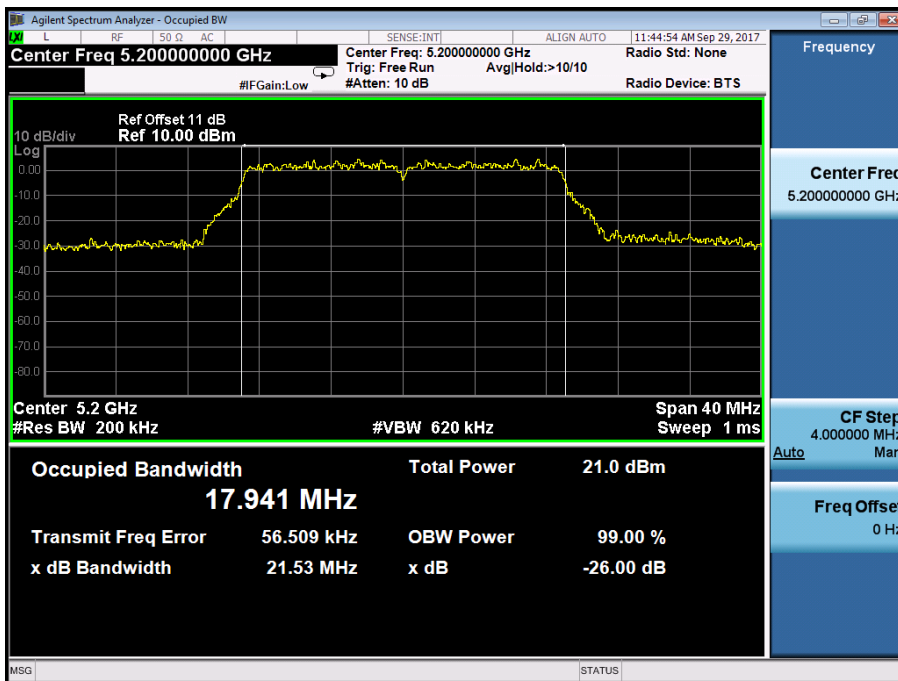

Emission Bandwidth & 99% Occupied Bandwidth UNII Band I
 Test Model 802.11ac(VHT20) mode Frequency(MHz) 5240
 Ant0

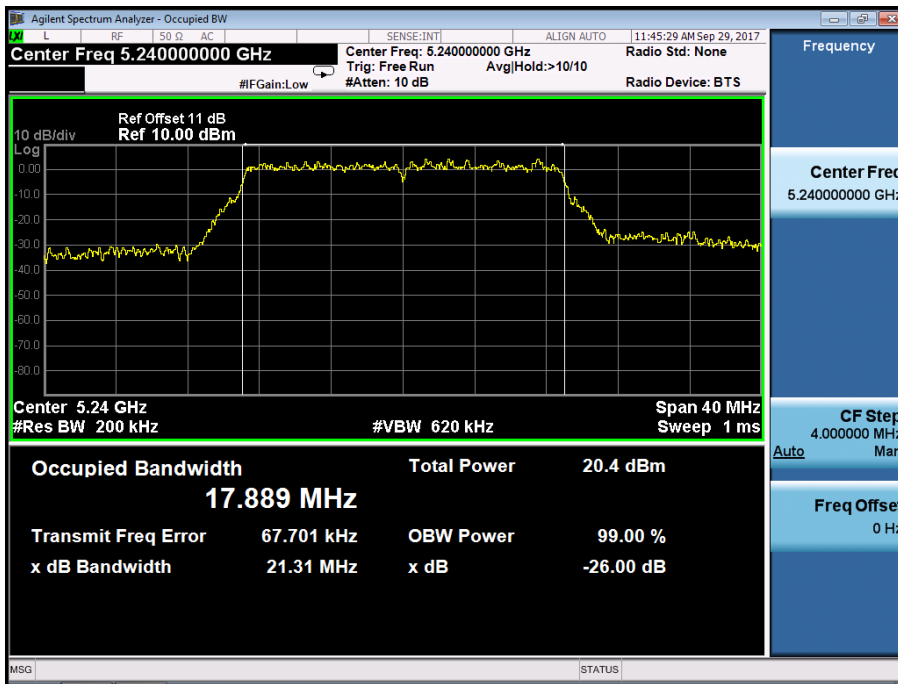

Ant1

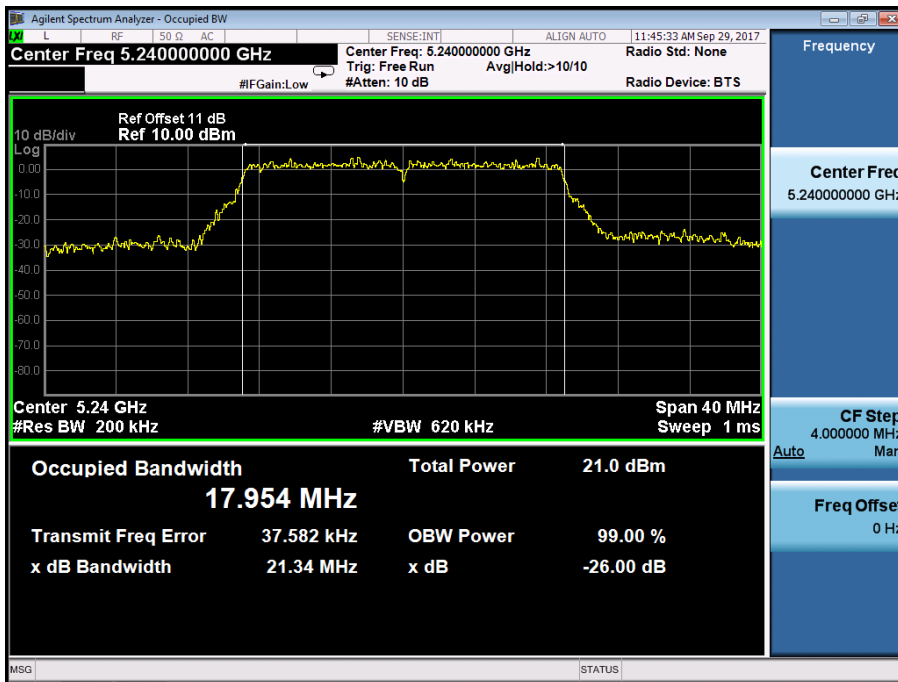

Emission Bandwidth&99% Occupied Bandwidth UNII Band II-A
 Test Model 802.11ac(VHT20) mode Frequency(MHz) 5260
Ant0

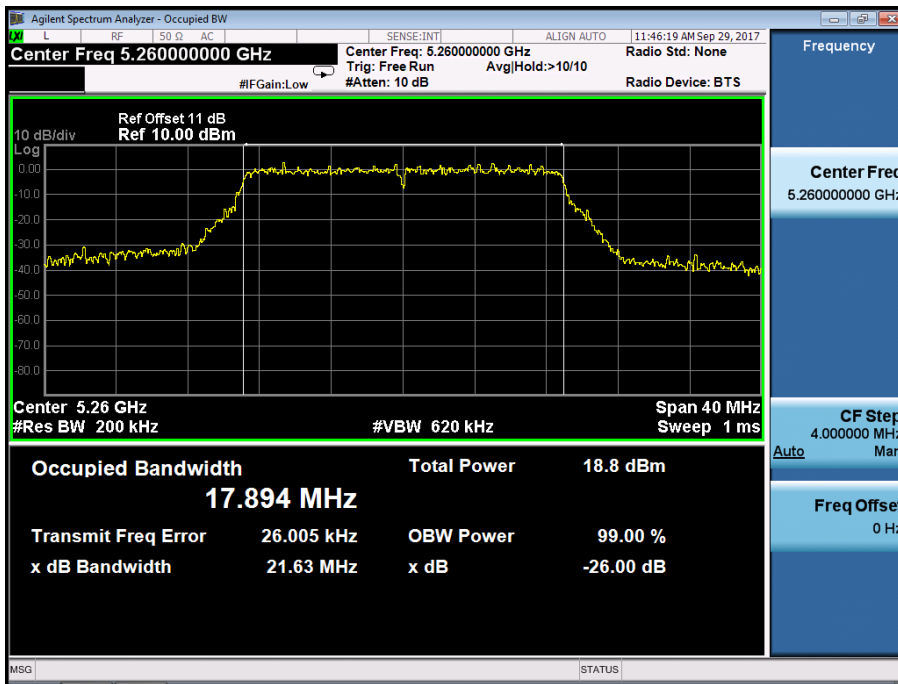

Ant1

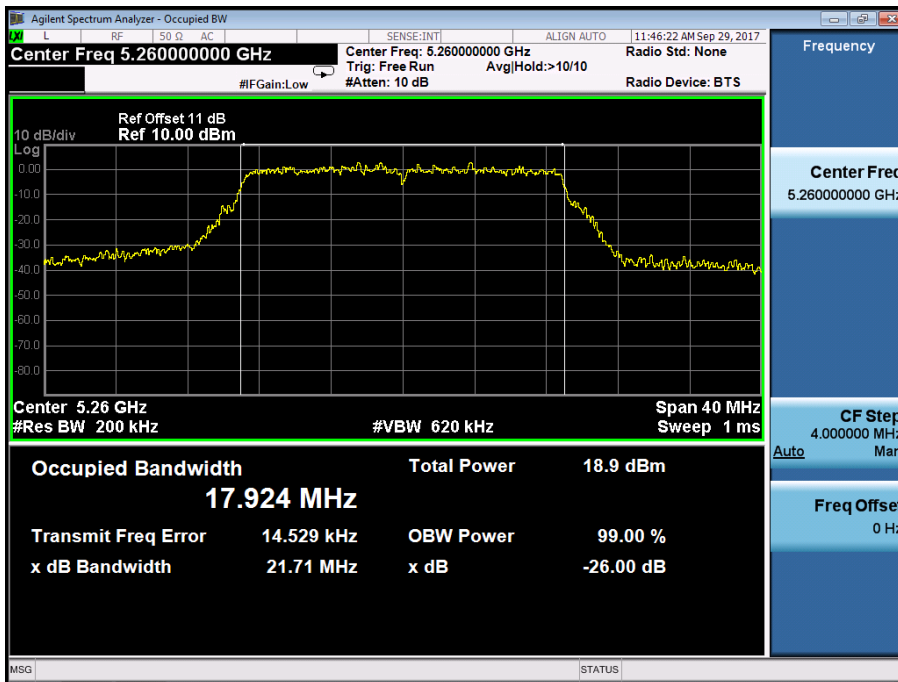

Emission Bandwidth&99% Occupied Bandwidth UNII Band II-A
 Test Model 802.11ac(VHT20) mode Frequency(MHz) 5280
Ant0

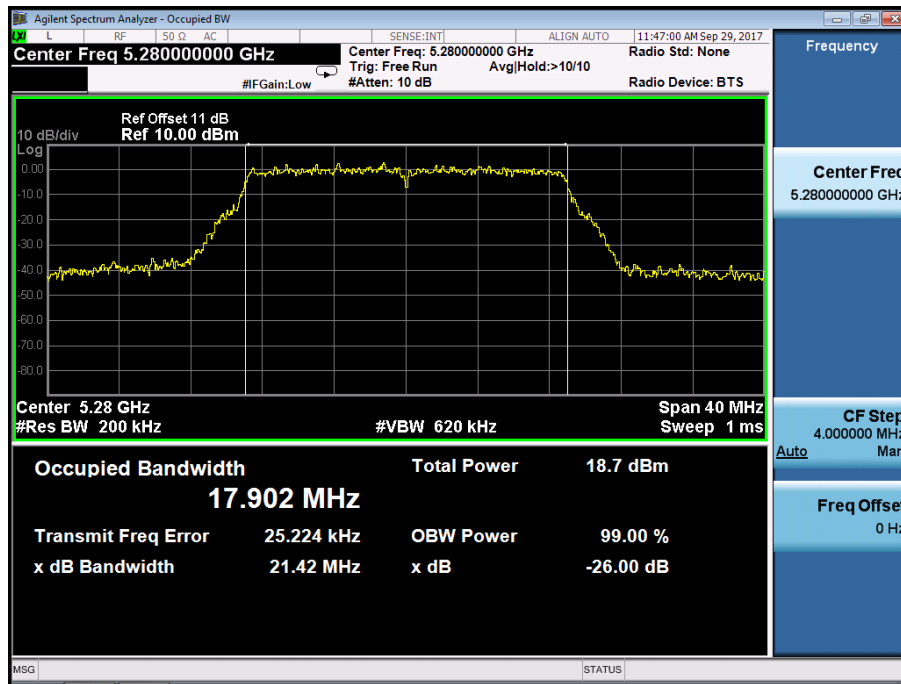

Ant1

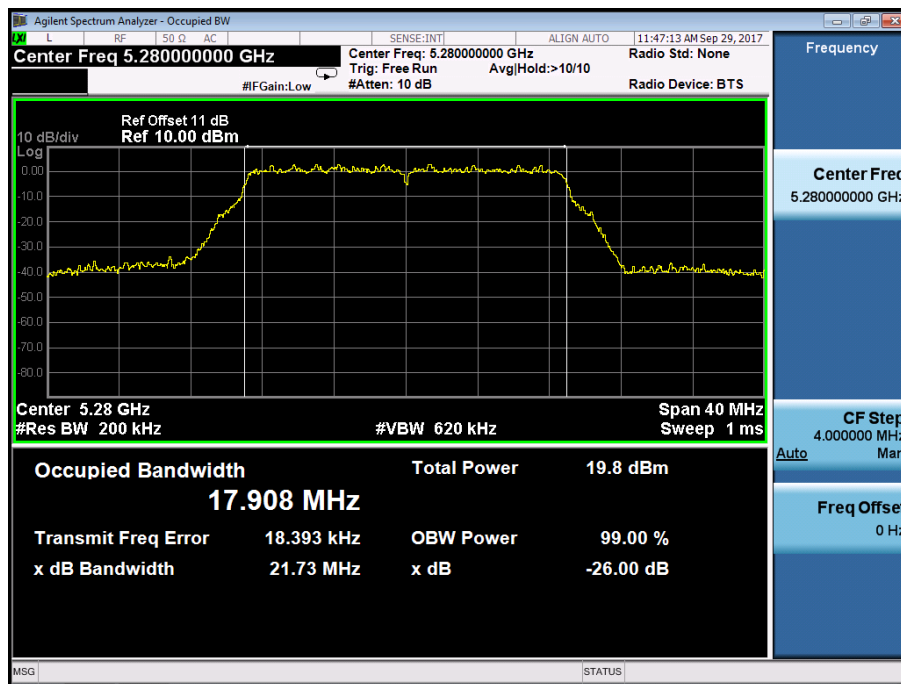

Emission Bandwidth & 99% Occupied Bandwidth UNII Band II-A
 Test Model 802.11ac(VHT20) mode Frequency(MHz) 5320
Ant0

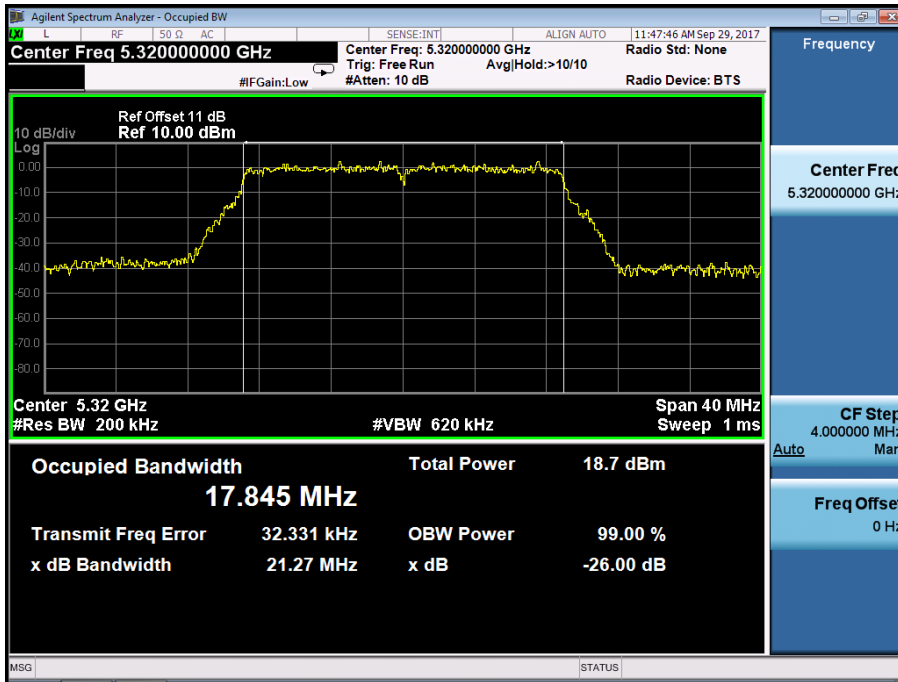

Ant1

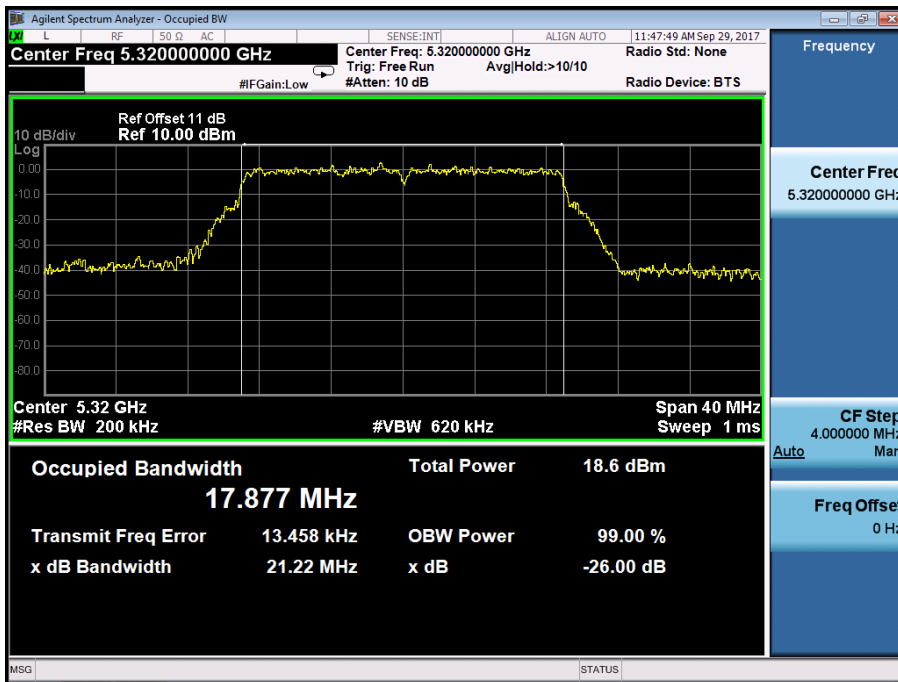

Emission Bandwidth&99% Occupied Bandwidth UNII Band II-C
 Test Model 802.11ac(VHT20) mode Frequency(MHz) 5500
Ant0

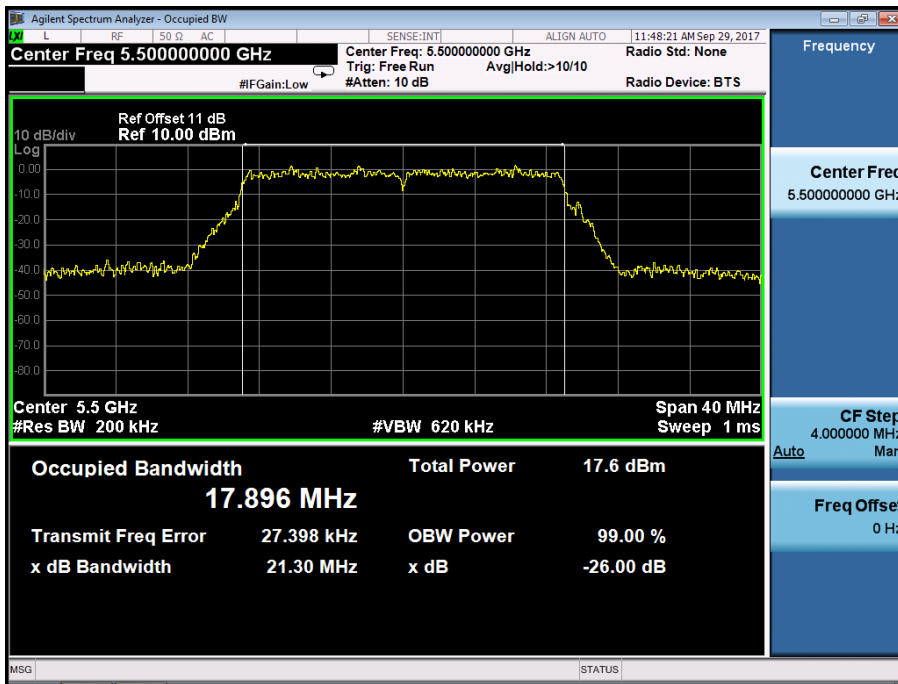

Ant1

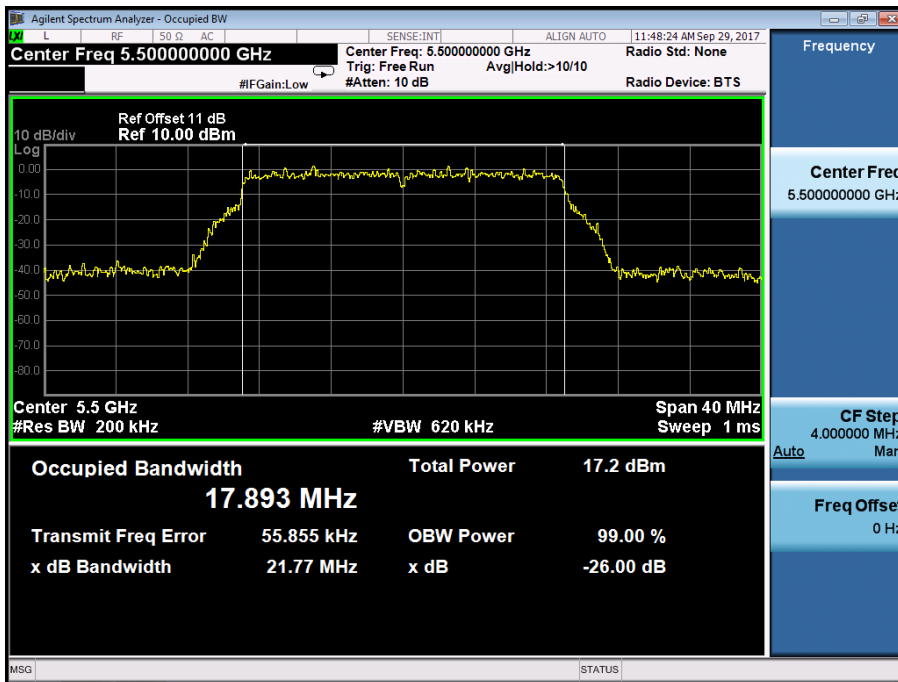

Emission Bandwidth&99% Occupied Bandwidth UNII Band II-C
 Test Model 802.11ac(VHT20) mode Frequency(MHz) 5600
 Ant0

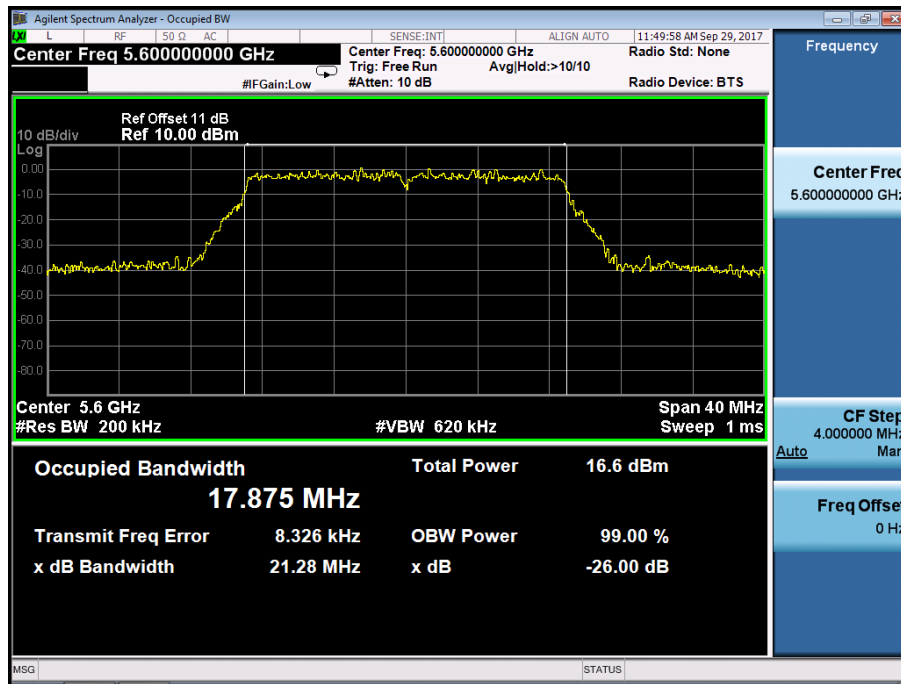

Ant1

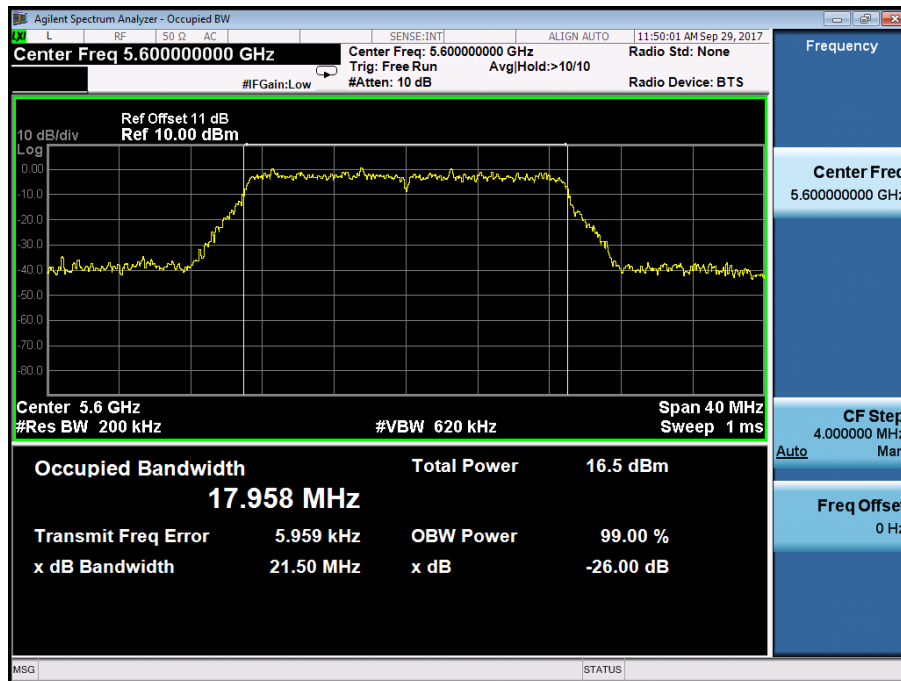

Emission Bandwidth & 99% Occupied Bandwidth UNII Band II-C
 Test Model 802.11ac(VHT20) mode Frequency(MHz) 5700
Ant0

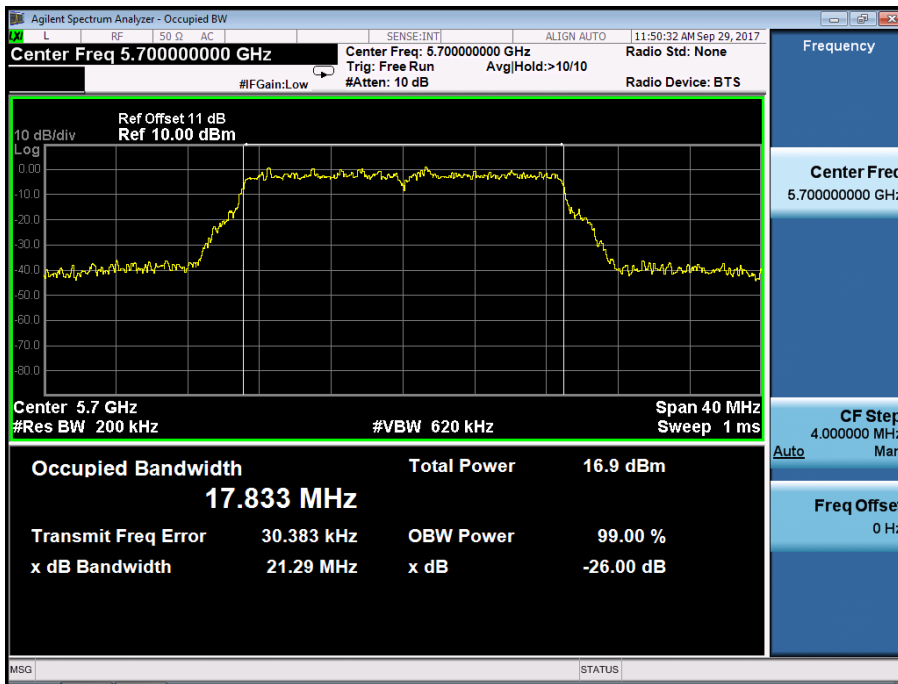

Ant1

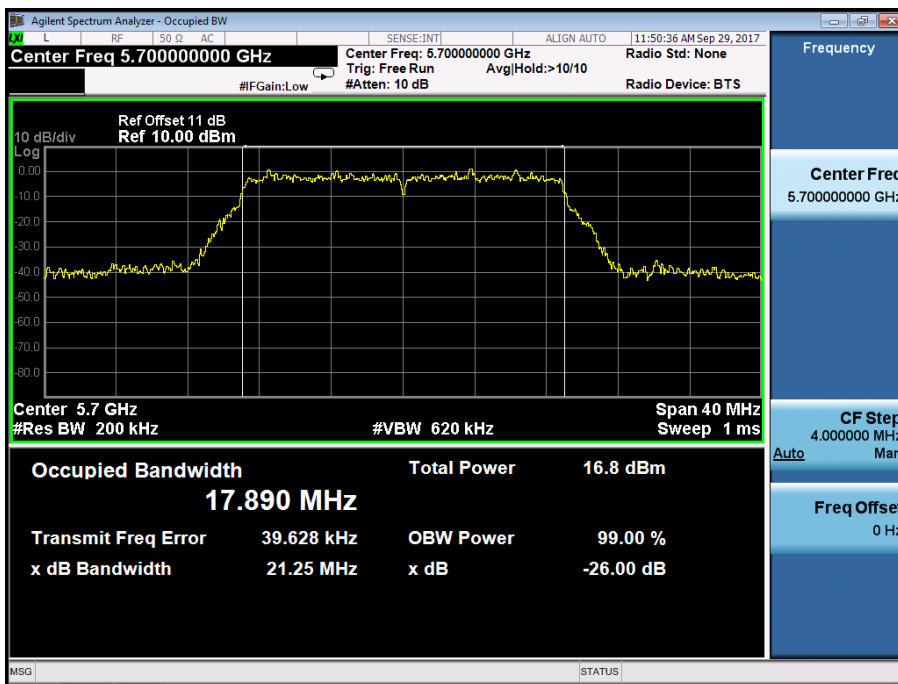

Emission Bandwidth & 99% Occupied Bandwidth UNII Band III
 Test Model 802.11ac(VHT20) mode Frequency(MHz) 5745
 Ant0

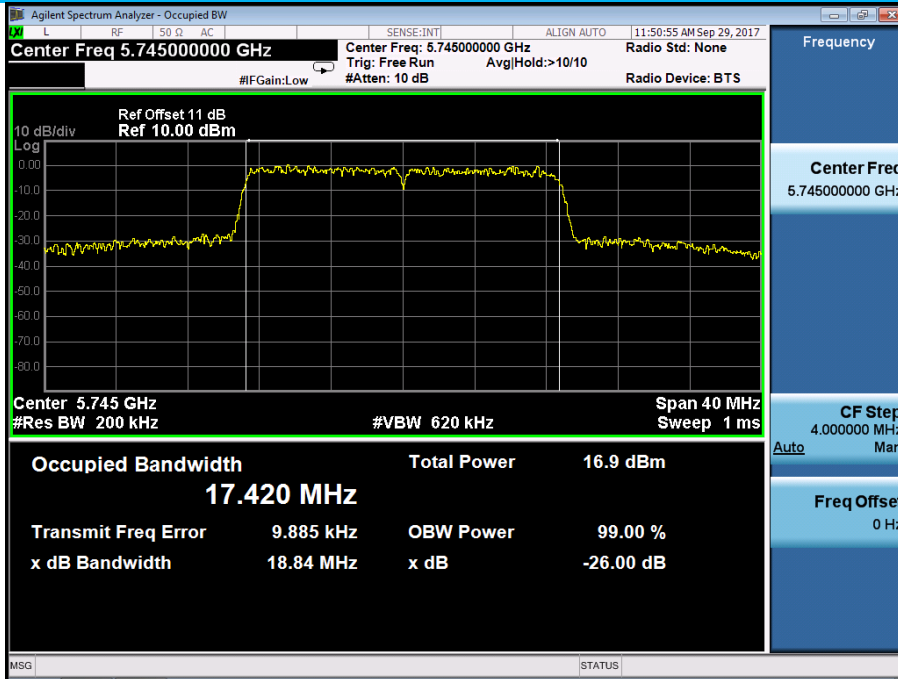

Ant1

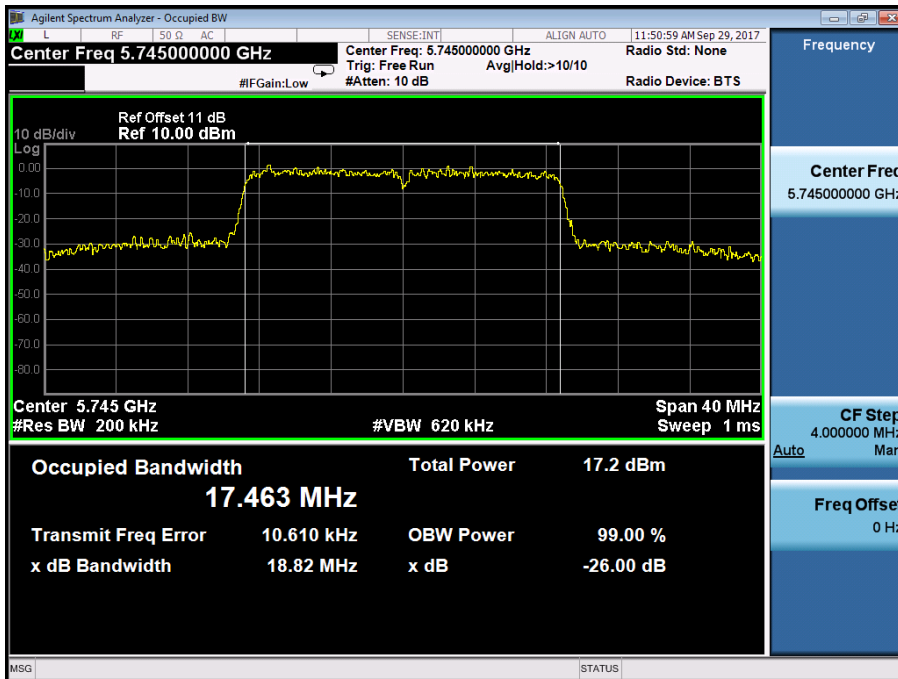

Emission Bandwidth&99% Occupied Bandwidth UNII Band III
 Test Model 802.11ac(VHT20) mode Frequency(MHz) 5785
 Ant0

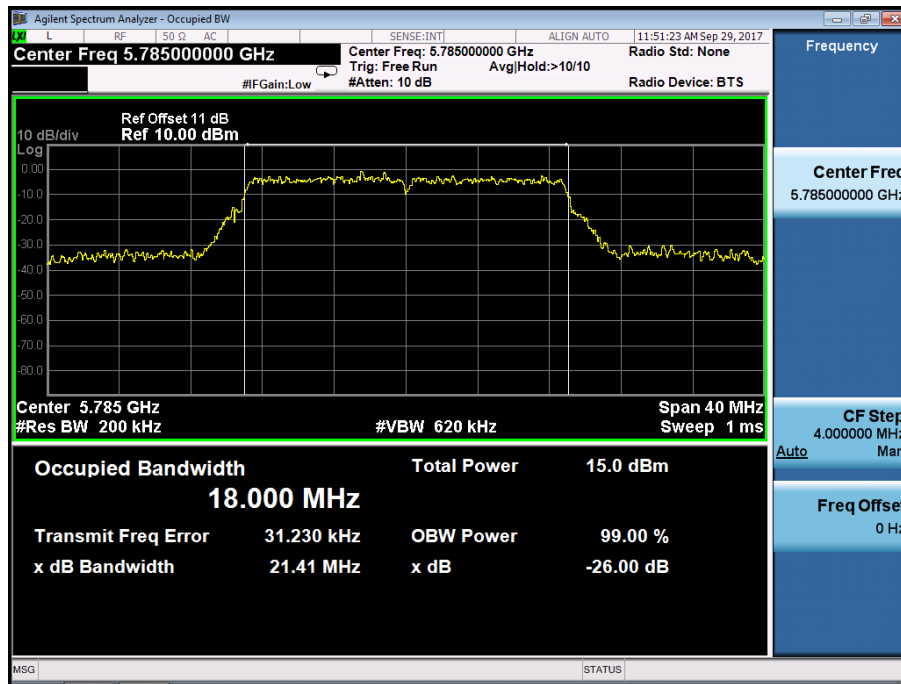

Ant1

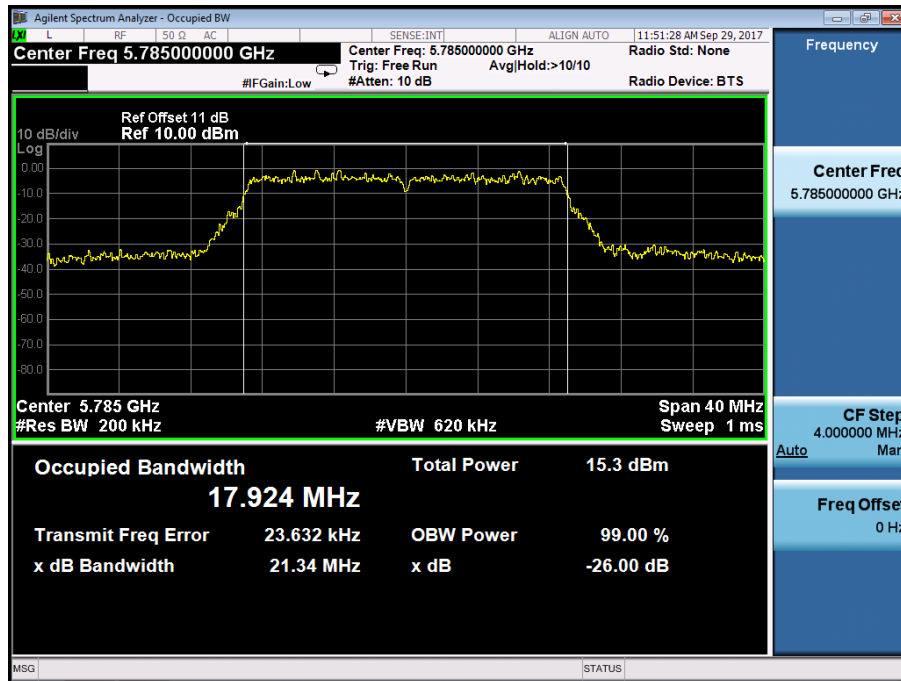

Emission Bandwidth&99% Occupied Bandwidth UNII Band III
 Test Model 802.11ac(VHT20) mode Frequency(MHz) 5825
 Ant0

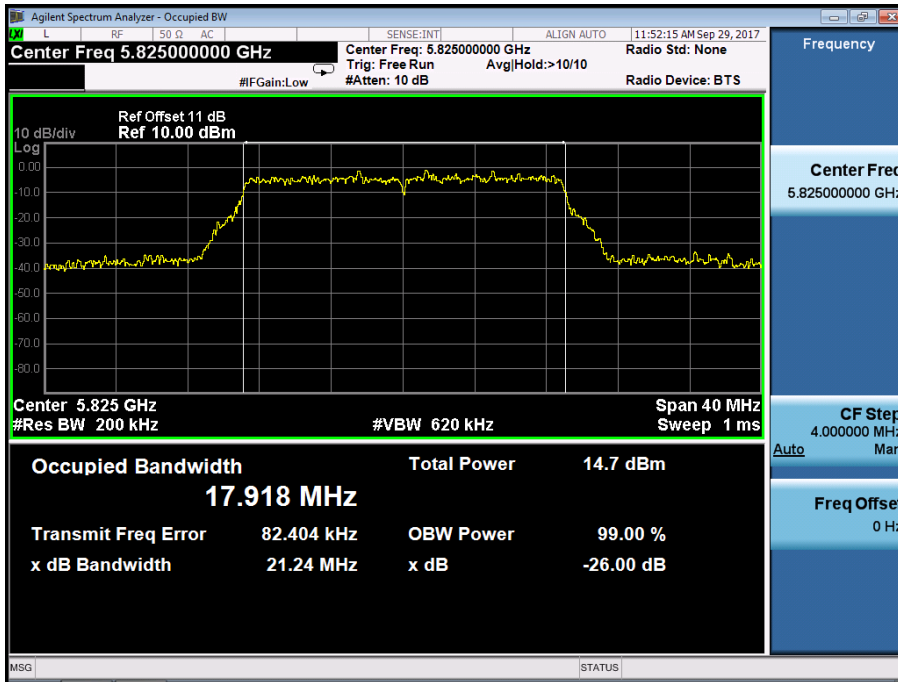

Ant1

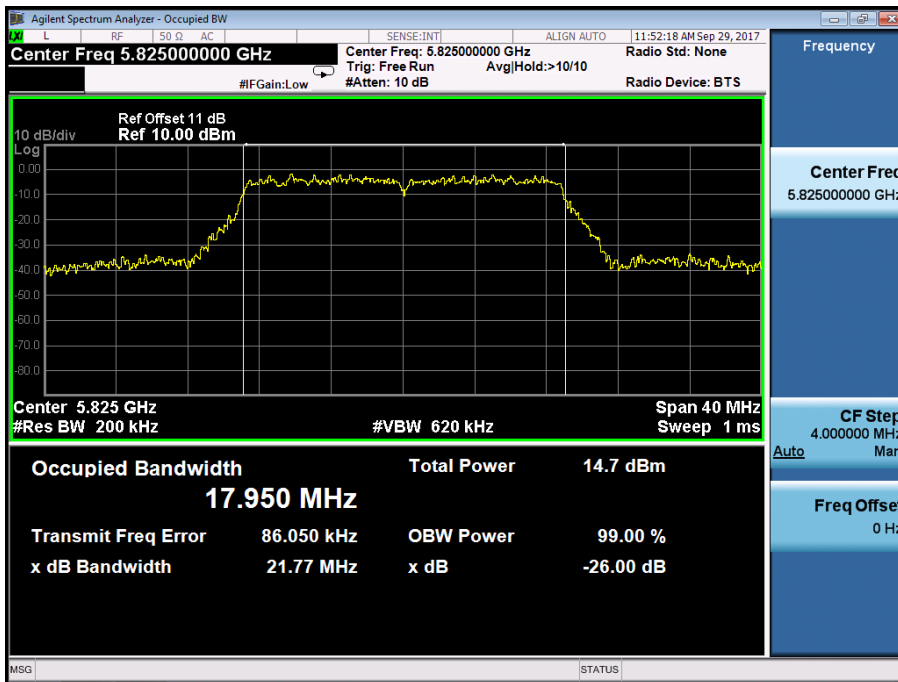

Emission Bandwidth & 99% Occupied Bandwidth UNII Band I
 Test Model 802.11n(VHT40) mode Frequency(MHz) 5190
 Ant0

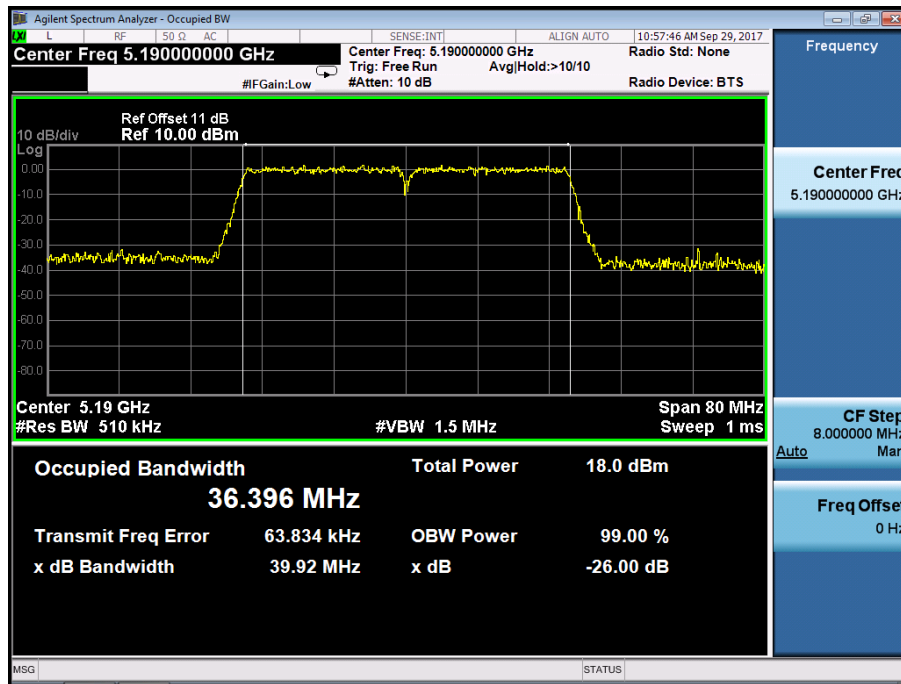

Ant1

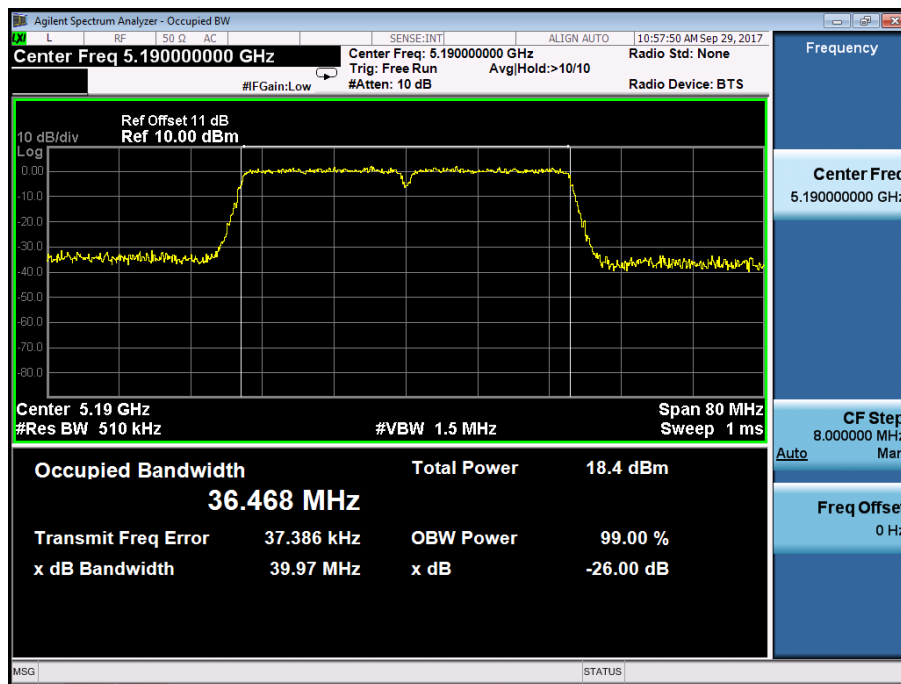

Emission Bandwidth & 99% Occupied Bandwidth UNII Band I
 Test Model 802.11n(VHT40) mode Frequency(MHz) 5230
 Ant0

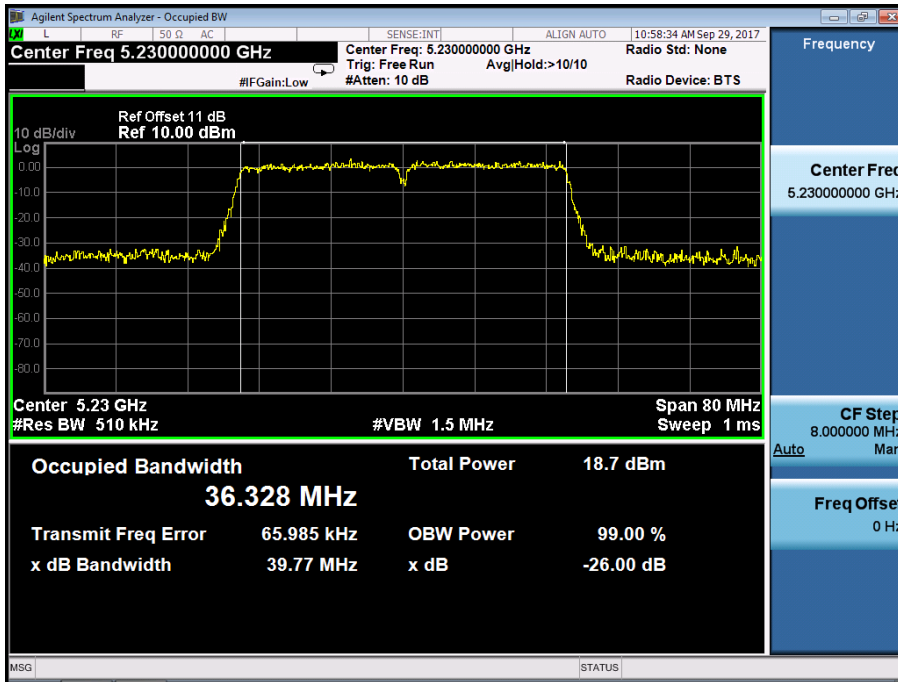

Ant1

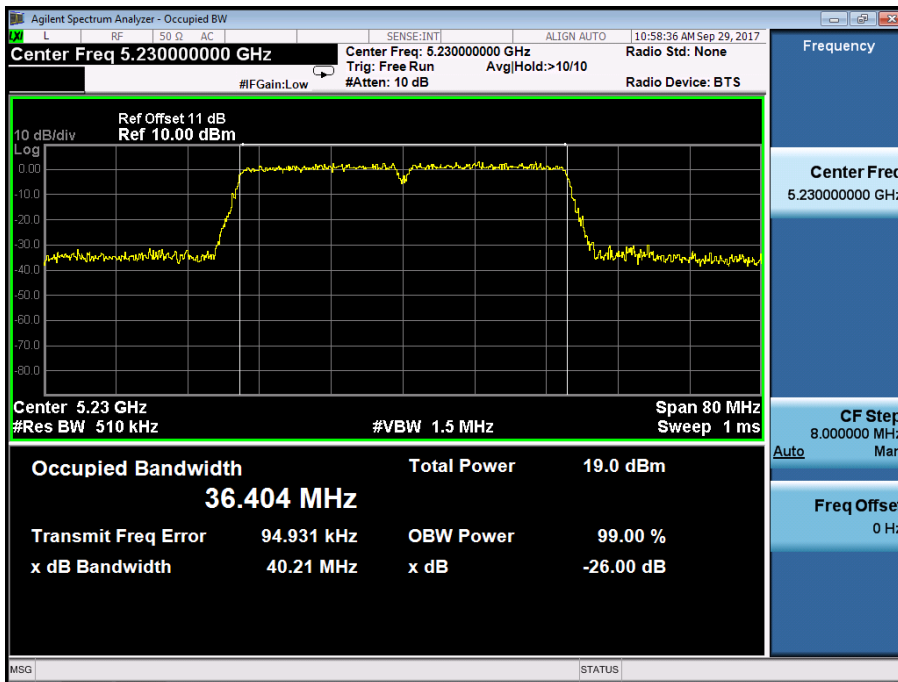

Emission Bandwidth & 99% Occupied Bandwidth UNII Band II-A
 Test Model 802.11n(VHT40) mode Frequency(MHz) 5270
 Ant0

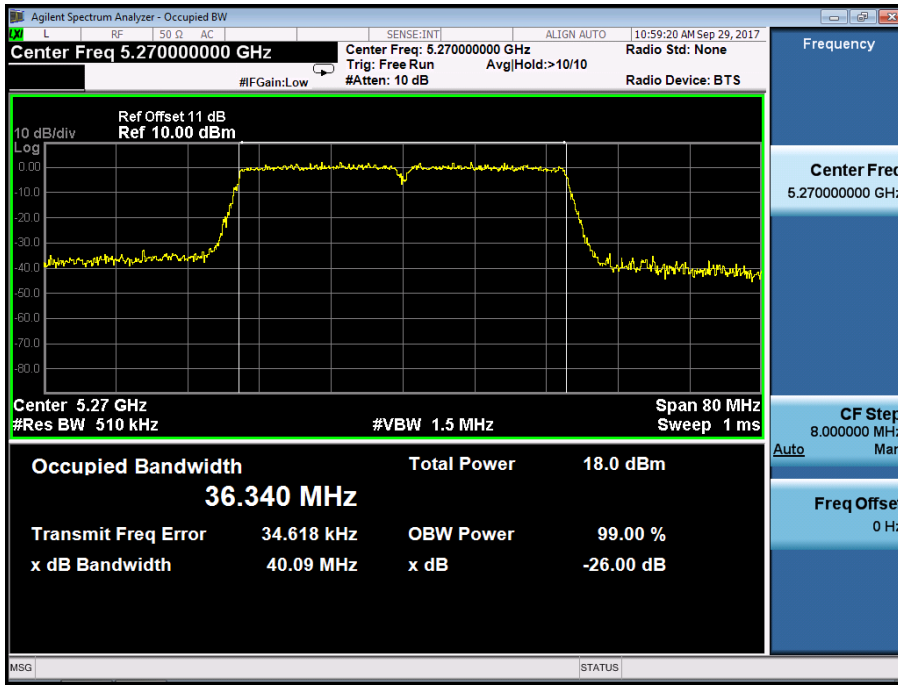

Ant1

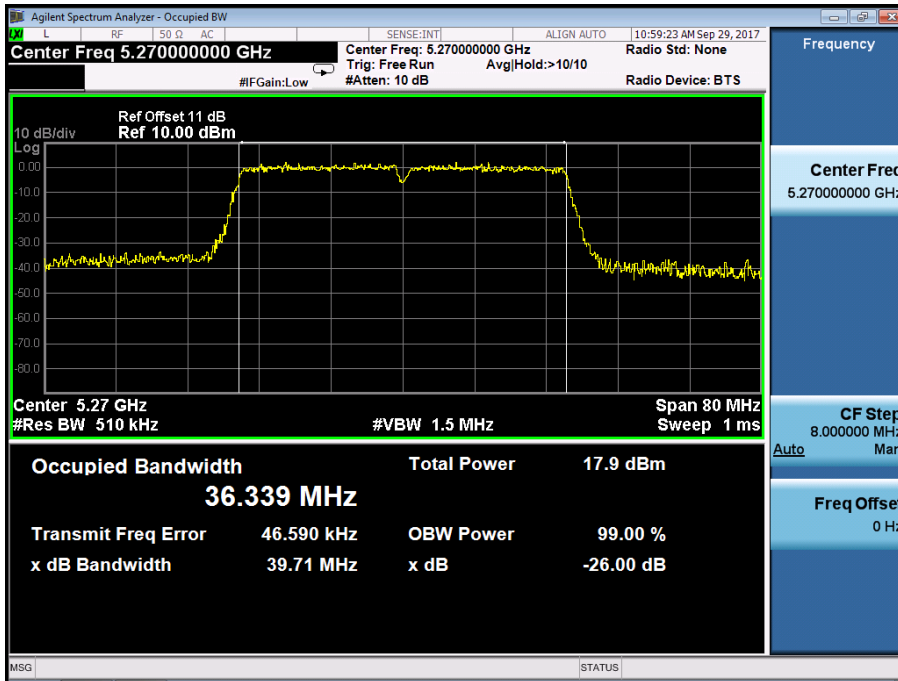

Emission Bandwidth & 99% Occupied Bandwidth UNII Band II-A
 Test Model 802.11n(VHT40) mode Frequency(MHz) 5310
Ant0

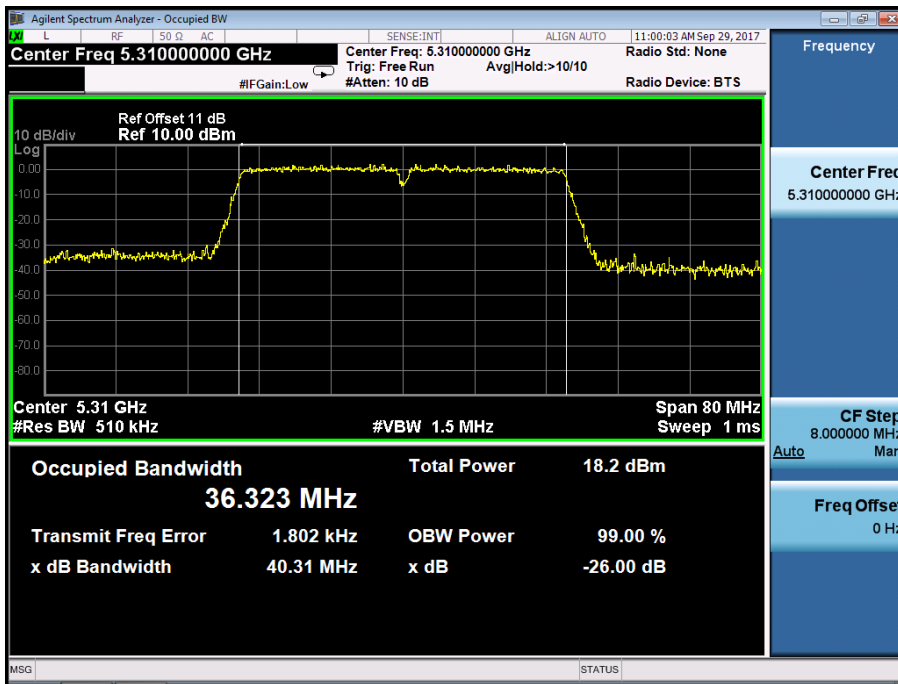

Ant1

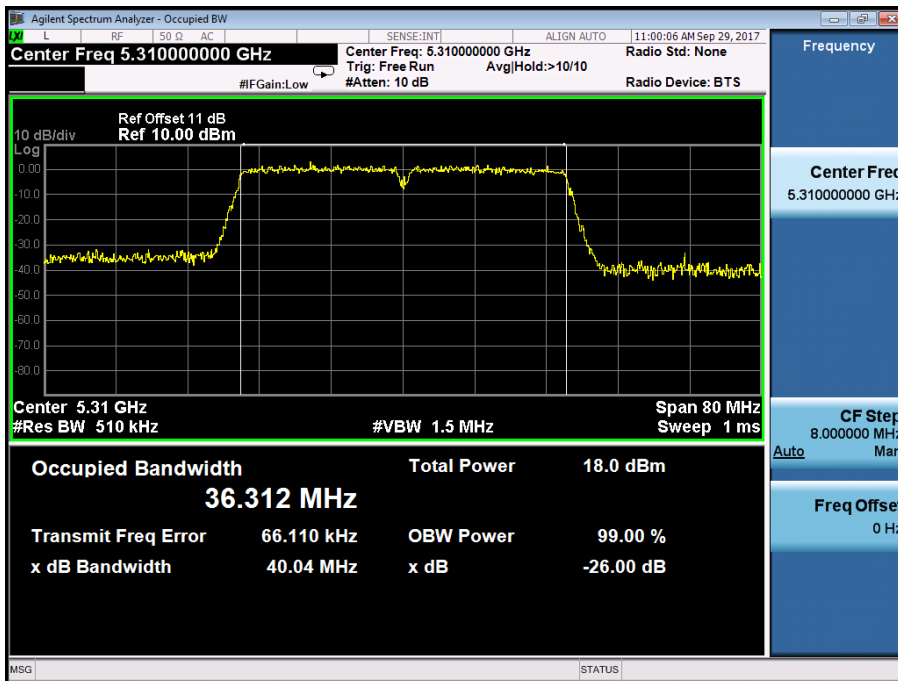

Emission Bandwidth & 99% Occupied Bandwidth UNII Band II-C
 Test Model 802.11n(VHT40) mode Frequency(MHz) 5510
Ant0

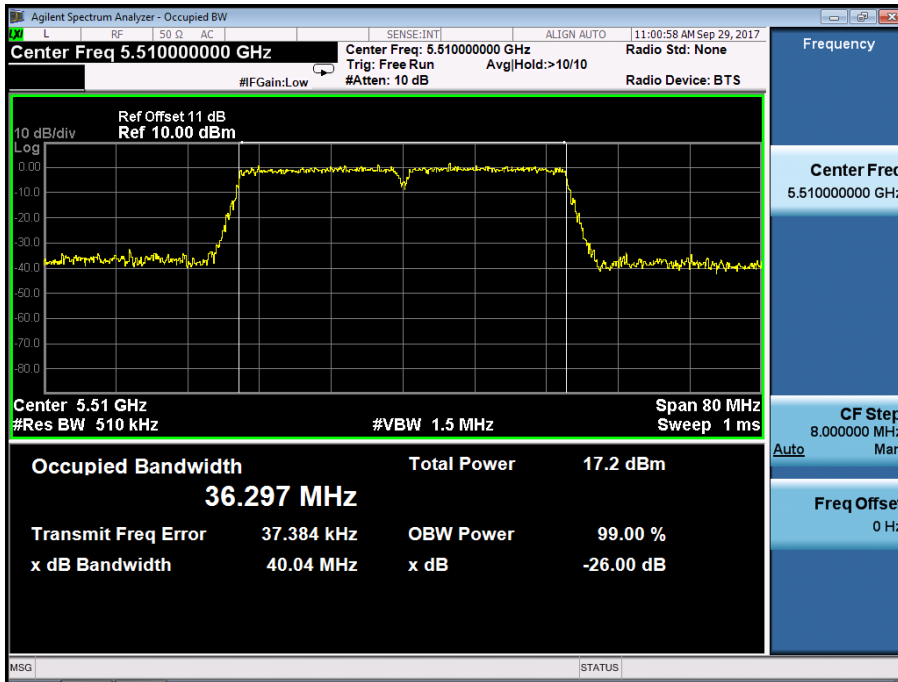

Ant1

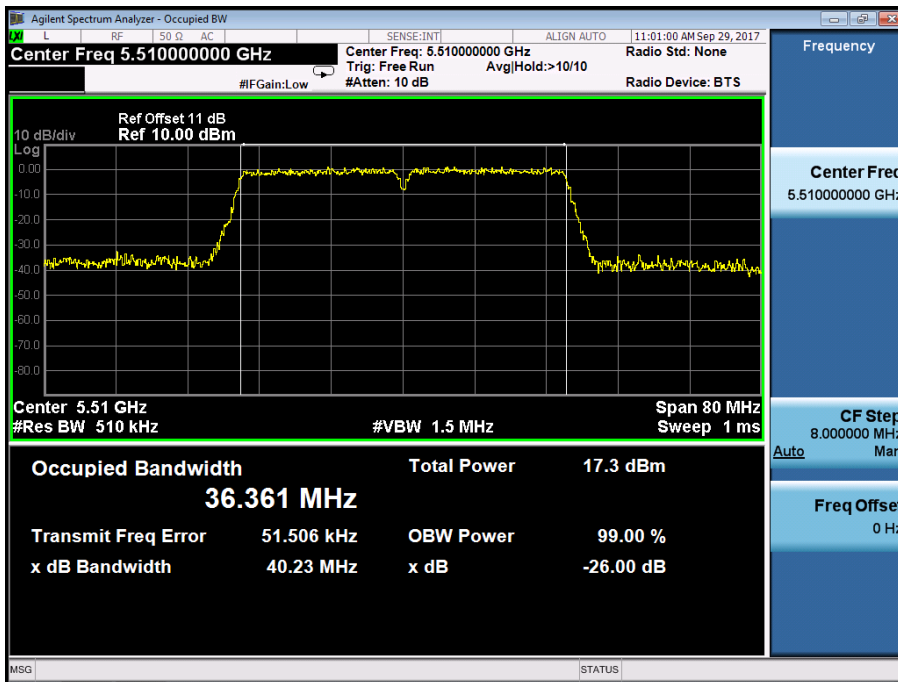

Emission Bandwidth & 99% Occupied Bandwidth UNII Band II-C
 Test Model 802.11n(VHT40) mode Frequency(MHz) 5590
Ant0

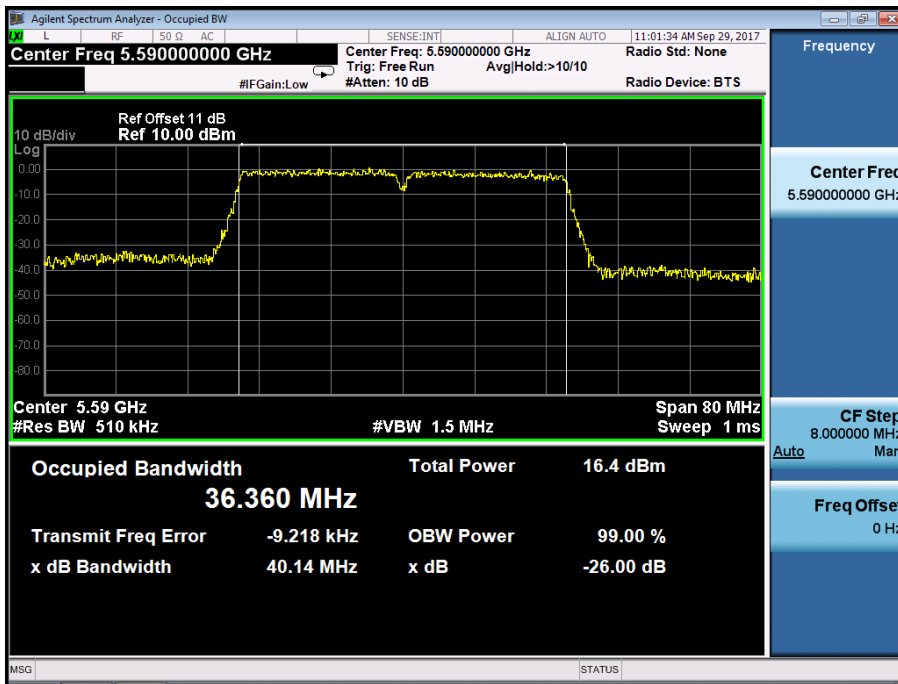

Ant1

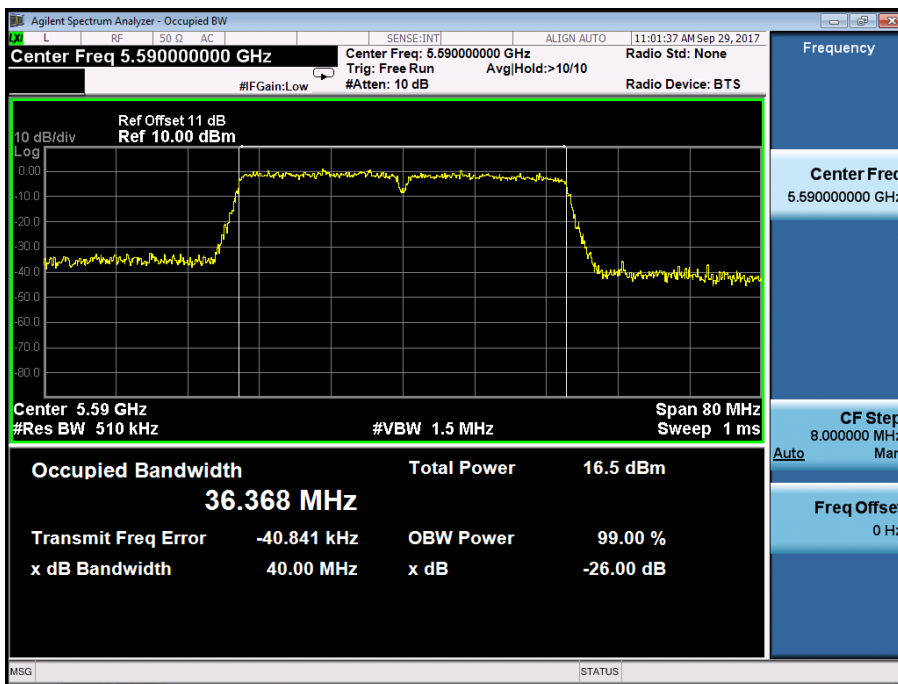

Emission Bandwidth & 99% Occupied Bandwidth UNII Band II-C
 Test Model 802.11n(VHT40) mode Frequency(MHz) 5670
Ant0

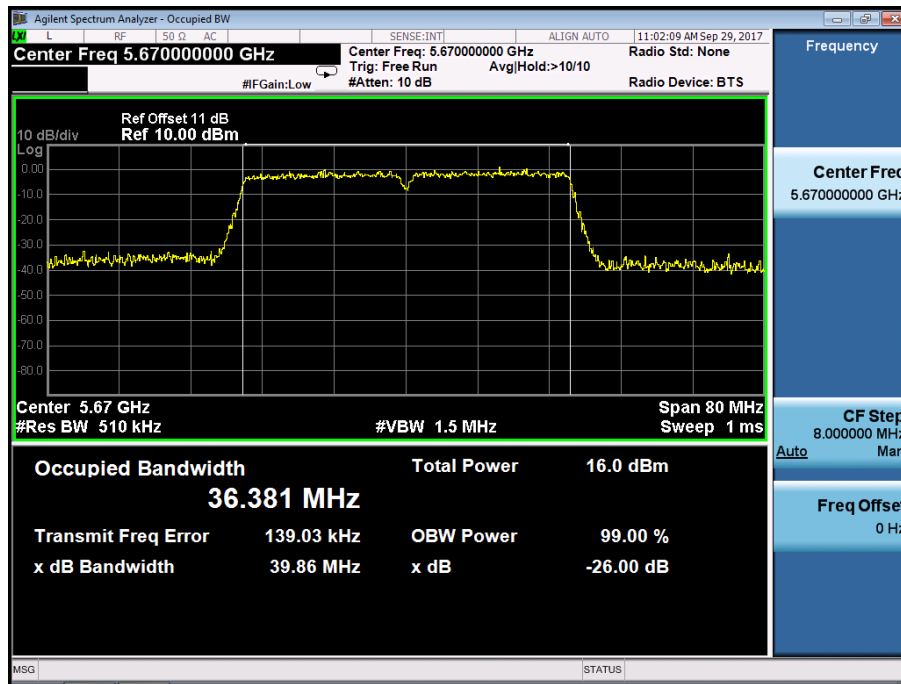

Ant1

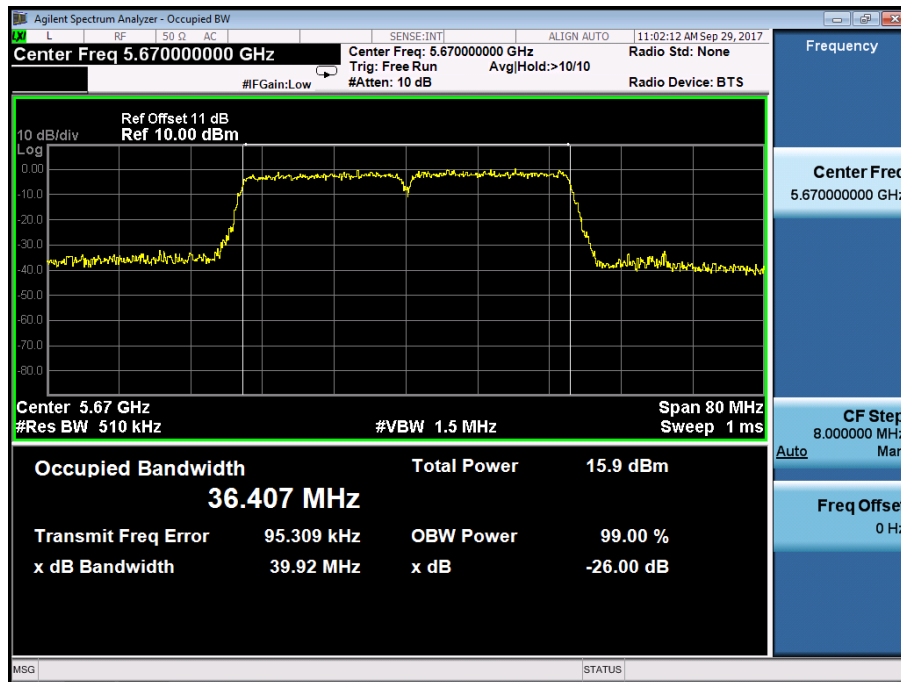

Emission Bandwidth&99% Occupied Bandwidth UNII Band III
 Test Model 802.11n(VHT40) mode Frequency(MHz) 5755
 Ant0

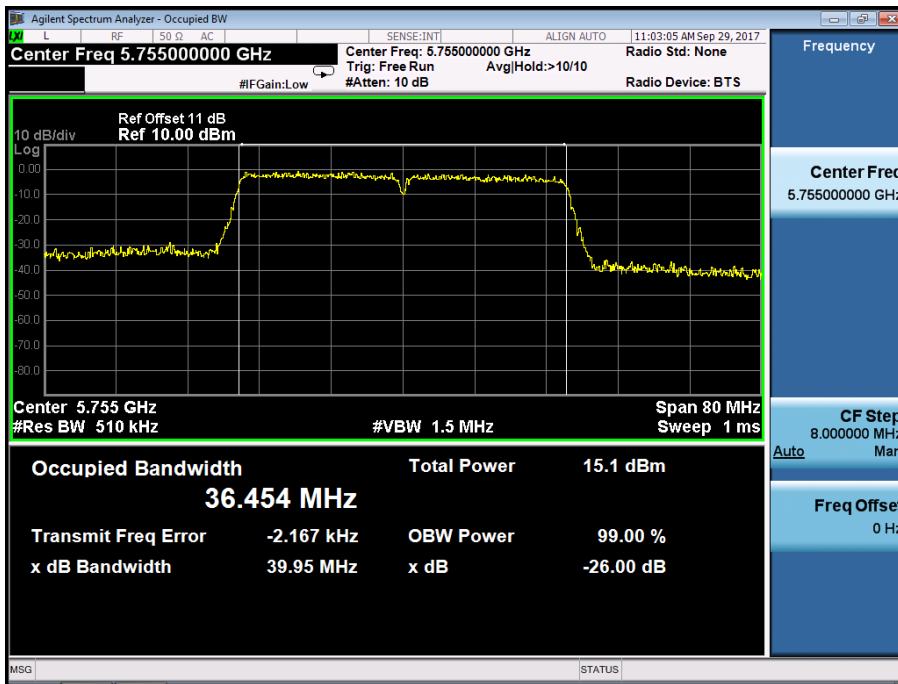

Ant1

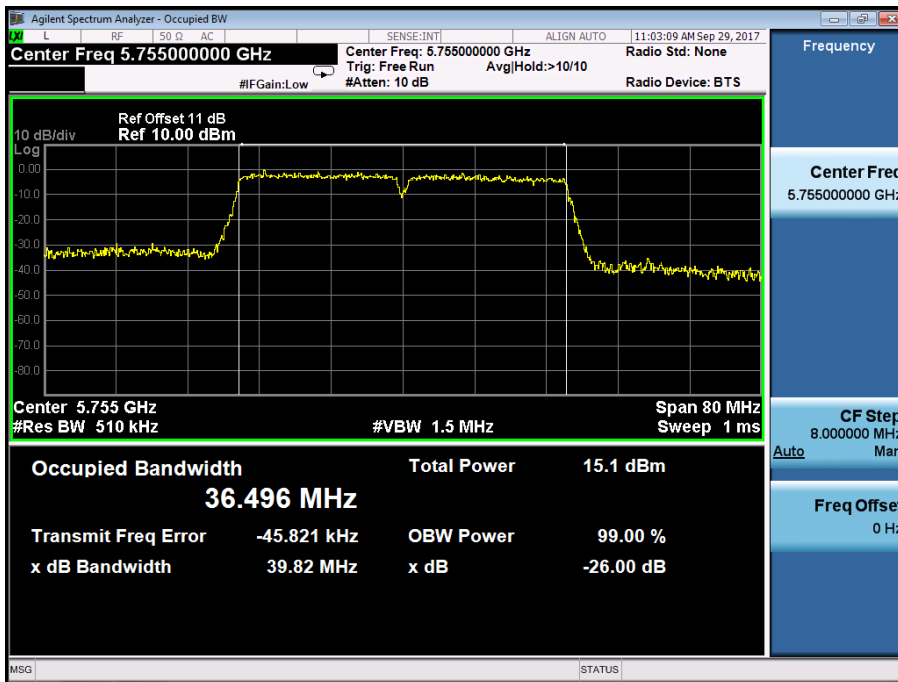

Emission Bandwidth&99% Occupied Bandwidth UNII Band III
 Test Model 802.11n(VHT40) mode Frequency(MHz) 5795
Ant0

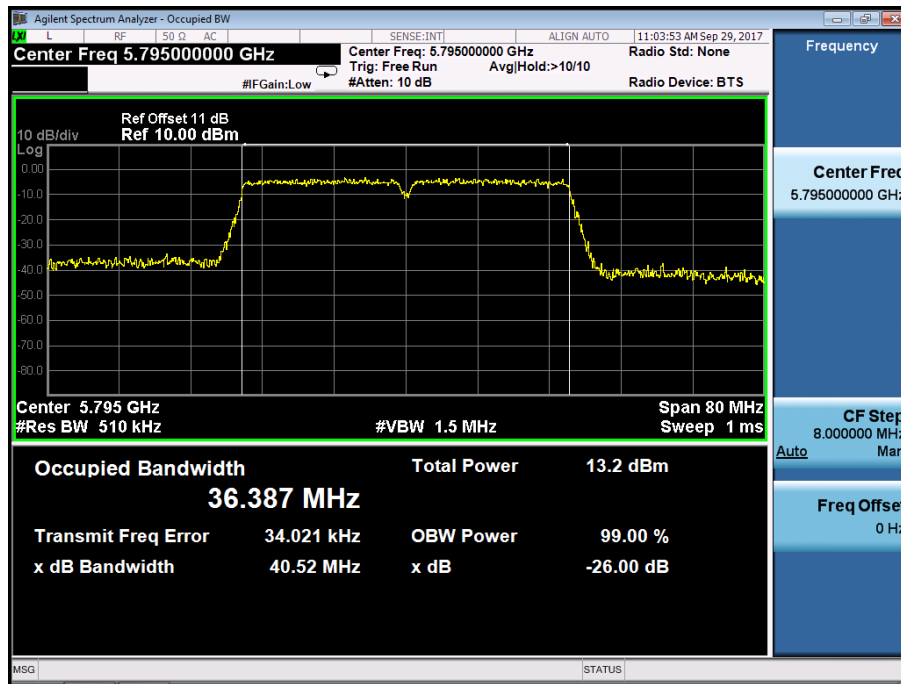

Ant1

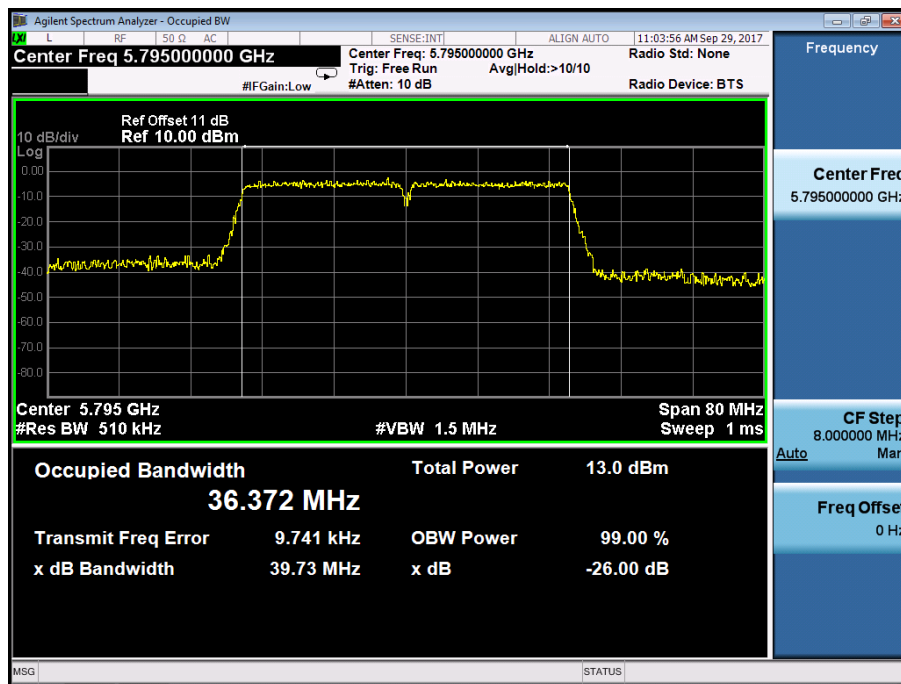

Emission Bandwidth & 99% Occupied Bandwidth UNII Band I
 Test Model 802.11ac(VHT40) mode Frequency(MHz) 5190
 Ant0

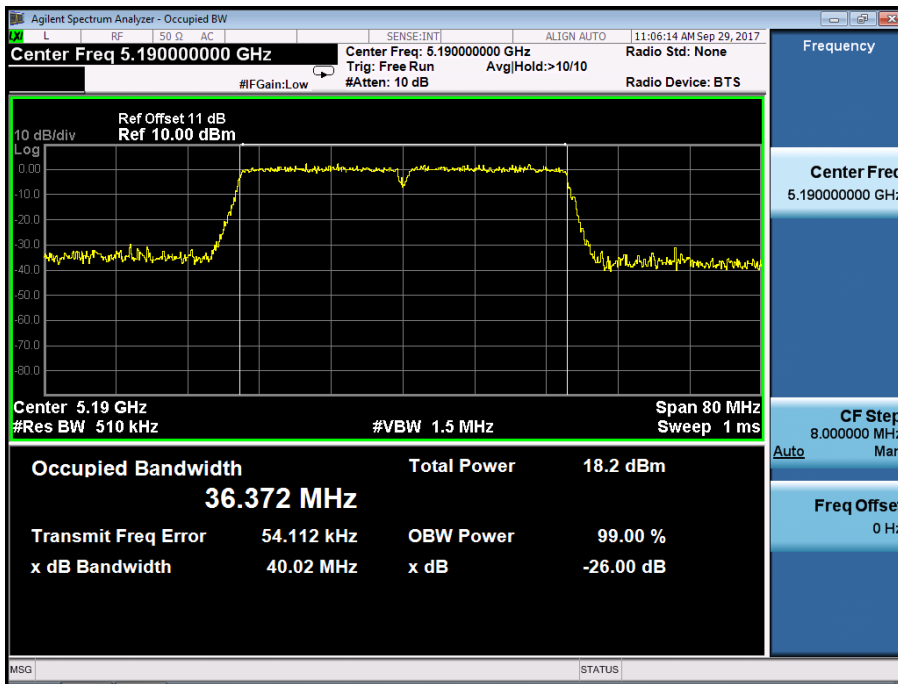

Ant1

