

FC

Test Report

Product Name	Tablet PC
Model No.	MS-N0J1
FCC ID.	I4L-MSN0J1

Applicant	MICRO-STAR INT'L Co., LTD.
Address	No. 69, Li-De St., Jung-He District, New Taipei City, Taiwan

Date of Receipt	Dec. 30, 2011
Issued Date	Mar. 23, 2012
Report No.	121116R-RFUSP43V01
Report Version	V1.0



The Test Results relate only to the samples tested.
The test report shall not be reproduced except in full without the written approval of Quietek Corporation.
This report must not be used to claim product endorsement by NVLAP any agency of the U.S. Government

Test Report Certification

Issued Date: Mar. 23, 2012

Report No.: 121116R-RFUSP43V01



Product Name	Tablet PC
Applicant	MICRO-STAR INT'L Co., LTD.
Address	No. 69, Li-De St., Jung-He District, New Taipei City, Taiwan
Manufacturer	MICRO-STAR INT'L Co., LTD.
Model No.	MS-N0J1
FCC ID.	I4L-MSN0J1
EUT Rated Voltage	AC 100-240V, 50-60Hz
EUT Test Voltage	AC 120V/ 60Hz
Trade Name	msi
Applicable Standard	FCC CFR Title 47 Part 15 Subpart C: 2010 ANSI C63.4: 2003
Test Result	Complied

The Test Results relate only to the samples tested.

The test report shall not be reproduced except in full without the written approval of Quietek Corporation.

This report must not be used to claim product endorsement by NVLAP any agency of the U.S. Government

Documented By : Jinn Chen
(Senior Adm. Specialist / Jinn Chen)

Tested By : Henk Huang
(Assistant Engineer / Henk Huang)

Approved By : [Signature]
(Manager / Vincent Lin)

TABLE OF CONTENTS

Description	Page
1. GENERAL INFORMATION	5
1.1. EUT Description.....	5
1.2. Operational Description.....	7
1.3. Tested System Details.....	8
1.4. Configuration of Tested System	9
1.5. EUT Exercise Software	9
1.6. Test Facility	10
2. CONDUCTED EMISSION	11
2.1. Test Equipment.....	11
2.2. Test Setup	11
2.3. Limits.....	12
2.4. Test Procedure	12
2.5. Uncertainty	12
2.6. Test Result of Conducted Emission.....	13
3. PEAK POWER OUTPUT	15
3.1. Test Equipment.....	15
3.2. Test Setup	15
3.3. Limit	15
3.4. Test Procedure	15
3.5. Uncertainty	15
3.6. Test Result of Peak Power Output.....	16
4. RADIATED EMISSION	18
4.1. Test Equipment.....	18
4.2. Test Setup	18
4.3. Limits.....	19
4.4. Test Procedure	20
4.5. Uncertainty	20
4.6. Test Result of Radiated Emission.....	21
5. RF ANTENNA CONDUCTED TEST	29
5.1. Test Equipment.....	29
5.2. Test Setup	29
5.3. Limits.....	29
5.4. Test Procedure	29
5.5. Uncertainty	29
5.6. Test Result of RF Antenna Conducted Test.....	30
6. BAND EDGE	42
6.1. Test Equipment.....	42
6.2. Test Setup	43
6.3. Limit	44
6.4. Test Procedure	44
6.5. Uncertainty	44

6.6.	Test Result of Band Edge	45
7.	CHANNEL NUMBER.....	53
7.1.	Test Equipment	53
7.2.	Test Setup	53
7.3.	Limit	53
7.4.	Test Procedure	53
7.5.	Uncertainty	53
7.6.	Test Result of Channel Number.....	54
8.	CHANNEL SEPARATION.....	56
8.1.	Test Equipment	56
8.2.	Test Setup	56
8.3.	Limit	56
8.4.	Test Procedure	56
8.5.	Uncertainty	56
8.6.	Test Result of Channel Separation.....	57
9.	DWELL TIME.....	61
9.1.	Test Equipment	61
9.2.	Test Setup	61
9.3.	Limit	61
9.4.	Test Procedure	61
9.5.	Uncertainty	61
9.6.	Test Result of Dwell Time	62
10.	OCCUPIED BANDWIDTH	66
10.1.	Test Equipment	66
10.2.	Test Setup	66
10.3.	Limits.....	66
10.4.	Test Procedure	66
10.5.	Uncertainty	66
10.6.	Test Result of Occupied Bandwidth	67
11.	EMI REDUCTION METHOD DURING COMPLIANCE TESTING	73
Attachment 1: EUT Test Photographs		
Attachment 2: EUT Detailed Photographs		

1. GENERAL INFORMATION

1.1. EUT Description

Product Name	Tablet PC
Trade Name	msi
Model No.	MS-N0J1
FCC ID.	I4L-MSN0J1
Frequency Range	2402 – 2480MHz
Channel Number	79
Type of Modulation	FHSS: GFSK(1Mbps) / π /4DQPSK(2Mbps) / 8DPSK(3Mbps)
Antenna Type	Printed on PCB / PIFA
Channel Control	Auto
Antenna Gain	Refer to the table “Antenna List”
Power Adapter	MFR: DELTA, M/N: ADP-18TB A Input: 100-240V, 50-60Hz 0.6A Output: 12V $\overline{=}$ 1.5A Cable Out: Non-shielded, 1.5m, with one ferrite bonded.

Antenna List

No.	Manufacturer	Part No.	Antenna Type	Peak Gain
1	msi	N0J1-WIFI-Internal (main)	PIFA	3.36 dBi for 2.4 GHz
		N0J1-WIFI-External (aux)		

Note:

- The antenna of EUT is conform to FCC 15.203.

Frequency of Each Channel:

Channel	Frequency	Channel	Frequency	Channel	Frequency	Channel	Frequency
Channel 00:	2402 MHz	Channel 20:	2422 MHz	Channel 40:	2442 MHz	Channel 60:	2462 MHz
Channel 01:	2403 MHz	Channel 21:	2423 MHz	Channel 41:	2443 MHz	Channel 61:	2463 MHz
Channel 02:	2404 MHz	Channel 22:	2424 MHz	Channel 42:	2444 MHz	Channel 62:	2464 MHz
Channel 03:	2405 MHz	Channel 23:	2425 MHz	Channel 43:	2445 MHz	Channel 63:	2465 MHz
Channel 04:	2406 MHz	Channel 24:	2426 MHz	Channel 44:	2446 MHz	Channel 64:	2466 MHz
Channel 05:	2407 MHz	Channel 25:	2427 MHz	Channel 45:	2447 MHz	Channel 65:	2467 MHz
Channel 06:	2408 MHz	Channel 26:	2428 MHz	Channel 46:	2448 MHz	Channel 66:	2468 MHz
Channel 07:	2409 MHz	Channel 27:	2429 MHz	Channel 47:	2449 MHz	Channel 67:	2469 MHz
Channel 08:	2410 MHz	Channel 28:	2430 MHz	Channel 48:	2450 MHz	Channel 68:	2470 MHz
Channel 09:	2411 MHz	Channel 29:	2431 MHz	Channel 49:	2451 MHz	Channel 69:	2471 MHz
Channel 10:	2412 MHz	Channel 30:	2432 MHz	Channel 50:	2452 MHz	Channel 70:	2472 MHz
Channel 11:	2413 MHz	Channel 31:	2433 MHz	Channel 51:	2453 MHz	Channel 71:	2473 MHz
Channel 12:	2414 MHz	Channel 32:	2434 MHz	Channel 52:	2454 MHz	Channel 72:	2474 MHz
Channel 13:	2415 MHz	Channel 33:	2435 MHz	Channel 53:	2455 MHz	Channel 73:	2475 MHz
Channel 14:	2416 MHz	Channel 34:	2436 MHz	Channel 54:	2456 MHz	Channel 74:	2476 MHz
Channel 15:	2417 MHz	Channel 35:	2437 MHz	Channel 55:	2457 MHz	Channel 75:	2477 MHz
Channel 16:	2418 MHz	Channel 36:	2438 MHz	Channel 56:	2458 MHz	Channel 76:	2478 MHz
Channel 17:	2419 MHz	Channel 37:	2439 MHz	Channel 57:	2459 MHz	Channel 77:	2479 MHz
Channel 18:	2420 MHz	Channel 38:	2440 MHz	Channel 58:	2460 MHz	Channel 78:	2480 MHz
Channel 19:	2421 MHz	Channel 39:	2441 MHz	Channel 59:	2461 MHz		

Note:

1. The EUT is Tablet PC with a built-in 2.4GHz WLAN and Bluetooth transceiver, this report for Bluetooth.
2. These tests were conducted on a sample for the purpose of demonstrating compliance of Bluetooth transmitter with Part 15 Subpart C Paragraph 15.247 for spread spectrum devices.
3. Regarding to the operation frequency, the lowest, middle and highest frequency are selected to perform the test.
4. The radiation measurements are performed in X, Y, Z axis positioning. Only the worst case is shown in the report.

Test Mode	Mode 1: Transmit - 1Mbps (GFSK) Mode 2: Transmit - 3Mbps (8DPSK)
-----------	---

1.3. Tested System Details

The types for all equipment, plus descriptions of all cables used in the tested system (including inserted cards) are:

	Product	Manufacturer	Model No.	Serial No.	Power Cord
1	Monitor	LG	W2261VT	907YHZK07303	Non-Shielded, 1.8m
2	Keyboard	Logitech	Y-U0009	LZ027HU	N/A
3	Earphone	AIWA	N/A	N/A	N/A
4	Modem	ACEEX	DM-1414	0102027558	Non-Shielded, 1.8m
5	Notebook PC	DELL	PPT	N/A	Non-Shielded, 1.8m
6	DVD	DELL	PD01S	N/A	N/A
7	Earphone	AIWA	N/A	N/A	N/A

	Signal Cable Type	Signal cable Description
A	HDMI Cable	Non-Shielded, 2m
B	USB Cable	Non-Shielded, 1m
C	Earphone Cable	Non-Shielded, 1m
D	Modem Cable	Non-Shielded, 1m
E	USB Cable	Non-Shielded, 1m
F	USB Cable	Non-Shielded, 1m
G	Earphone Cable	Non-Shielded, 1m
H	D-SUB Cable	Non-Shielded, 1.5m
I	USB Cable	Non-Shielded, 1m
J	mini USB to USB Cable	Non-Shielded, 1m

1.4. Configuration of Tested System

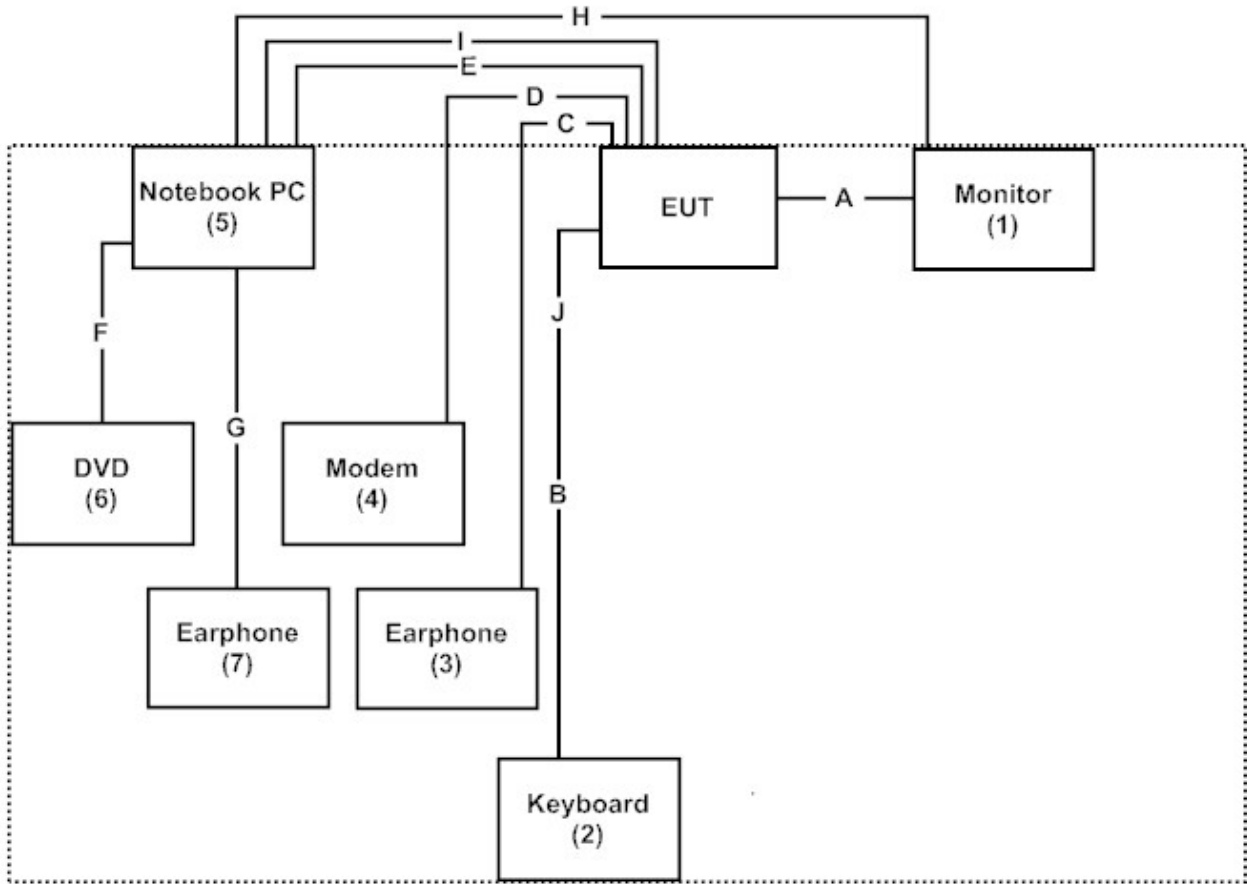

1.5. EUT Exercise Software

- (1) Setup the EUT as shown in Section 1.4
- (2) Execute software on the EUT.
- (3) Configure the test mode, the test channel, and the data rate.
- (4) Press “OK” to start the continuous Transmit.
- (5) Verify that the EUT works properly.

1.6. Test Facility

Ambient conditions in the laboratory:

Items	Required (IEC 68-1)	Actual
Temperature (°C)	15-35	20-35
Humidity (%RH)	25-75	30-65
Barometric pressure (mbar)	860-1060	950-1000

The related certificate for our laboratories about the test site and management system can be downloaded from Quietek Corporation's Web Site: <http://www.quietek.com/tw/ctg/cts/accreditations.htm>
The address and introduction of Quietek Corporation's laboratories can be founded in our Web site: <http://www.quietek.com/>

Site Description: File on
Federal Communications Commission
FCC Engineering Laboratory
7435 Oakland Mills Road
Columbia, MD 21046
Registration Number: 92195

Accreditation on NVLAP
NVLAP Lab Code: 200533-0

Site Name: Quietek Corporation
Site Address: No.5-22, Ruishukeng,
Linkou Dist. New Taipei City 24451,
Taiwan, R.O.C.
TEL: 886-2-8601-3788 / FAX : 886-2-8601-3789
E-Mail : service@quietek.com

FCC Accreditation Number: TW1014

2. Conducted Emission

2.1. Test Equipment

	Equipment	Manufacturer	Model No. / Serial No.	Last Cal.	Remark
X	Test Receiver	R & S	ESCS 30 / 825442/018	Sep., 2011	
X	Artificial Mains Network	R & S	ENV4200 / 848411/10	Feb., 2012	Peripherals
X	LISN	R & S	ESH3-Z5 / 825562/002	Feb., 2012	EUT
	DC LISN	Schwarzbeck	8226 / 176	Mar, 2012	EUT
X	Pulse Limiter	R & S	ESH3-Z2 / 357.8810.52	Feb., 2012	
	No.1 Shielded Room				

Note:

1. All equipments are calibrated every one year.
2. The test instruments marked by “X” are used to measure the final test results.

2.2. Test Setup

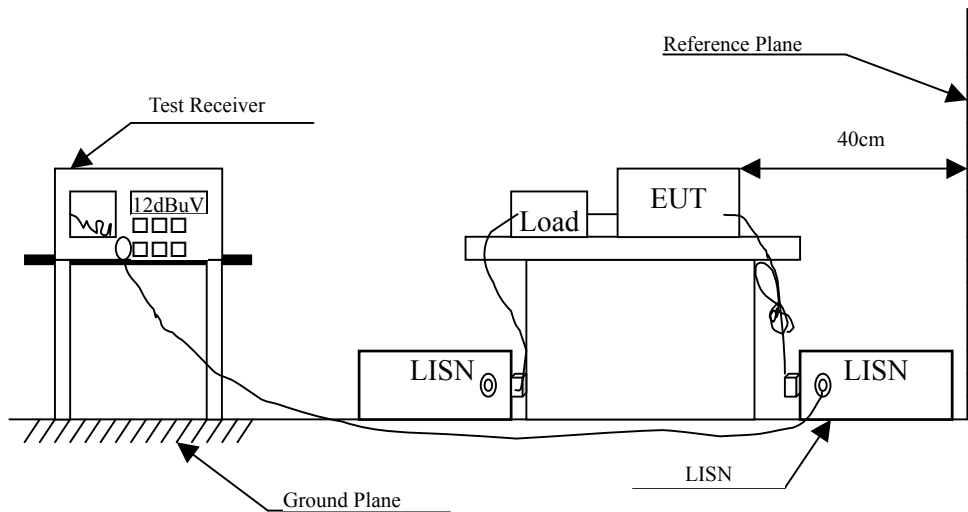

2.3. Limits

FCC Part 15 Subpart C Paragraph 15.207 (dBuV) Limit		
Frequency MHz	Limits	
	QP	AV
0.15 - 0.50	66-56	56-46
0.50-5.0	56	46
5.0 - 30	60	50

Remarks: In the above table, the tighter limit applies at the band edges.

2.4. Test Procedure

The EUT and Peripherals are connected to the main power through a line impedance stabilization network (L.I.S.N.). This provides a 50 ohm /50uH coupling impedance for the measuring equipment. The peripheral devices are also connected to the main power through a LISN that provides a 50ohm /50uH coupling impedance with 50ohm termination. (Please refer to the block diagram of the test setup and photographs.)

Both sides of A.C. line are checked for maximum conducted interference. In order to find the maximum emission, the relative positions of equipment and all the interface cables must be changed according to ANSI C63.4: 2003 on conducted measurement.

Conducted emissions were investigated over the frequency range from 0.15MHz to 30MHz using a receiver bandwidth of 9kHz.

The EUT was setup to ANSI C63.4, 2003; tested to FHSS test procedure of FCC Public Notice DA 00-705 for compliance to FCC 47CFR 15.247 requirements.

2.5. Uncertainty

± 2.26 dB

2.6. Test Result of Conducted Emission

Product : Tablet PC
 Test Item : Conducted Emission Test
 Power Line : Line 1
 Test Mode : Mode 2: Transmit - 3Mbps (8DPSK) (2441MHz)

Frequency MHz	Correct Factor dB	Reading Level dBuV	Measurement Level dBuV	Margin dB	Limit dBuV
LINE 1					
Quasi-Peak					
0.170	9.840	39.040	48.880	-16.549	65.429
0.181	9.840	38.720	48.560	-16.554	65.114
0.228	9.840	31.780	41.620	-22.151	63.771
0.275	9.840	26.560	36.400	-26.029	62.429
0.369	9.840	23.870	33.710	-26.033	59.743
1.068	9.850	18.050	27.900	-28.100	56.000
Average					
0.170	9.840	21.930	31.770	-23.659	55.429
0.181	9.840	23.050	32.890	-22.224	55.114
0.228	9.840	20.700	30.540	-23.231	53.771
0.275	9.840	11.040	20.880	-31.549	52.429
0.369	9.840	14.490	24.330	-25.413	49.743
1.068	9.850	17.140	26.990	-19.010	46.000

Note:

1. All Reading Levels are Quasi-Peak and average value.
2. "█" means the worst emission level.
3. Measurement Level = Reading Level + Correct Factor

Product : Tablet PC
 Test Item : Conducted Emission Test
 Power Line : Line 2
 Test Mode : Mode 2: Transmit - 3Mbps (8DPSK) (2441MHz)

Frequency MHz	Correct Factor dB	Reading Level dBuV	Measurement Level dBuV	Margin dB	Limit dBuV
LINE 2					
Quasi-Peak					
0.150	9.843	41.420	51.263	-14.737	66.000
0.216	9.840	35.520	45.360	-18.754	64.114
0.396	9.840	26.680	36.520	-22.451	58.971
0.638	9.840	17.470	27.310	-28.690	56.000
1.072	9.840	21.010	30.850	-25.150	56.000
1.502	9.850	18.430	28.280	-27.720	56.000
Average					
0.150	9.843	24.300	34.143	-21.857	56.000
0.216	9.840	27.660	37.500	-16.614	54.114
0.396	9.840	21.380	31.220	-17.751	48.971
0.638	9.840	15.150	24.990	-21.010	46.000
1.072	9.840	19.610	29.450	-16.550	46.000
1.502	9.850	17.330	27.180	-18.820	46.000

Note:

1. All Reading Levels are Quasi-Peak and average value.
2. "█" means the worst emission level.
3. Measurement Level = Reading Level + Correct Factor

3. Peak Power Output

3.1. Test Equipment

	Equipment	Manufacturer	Model No./Serial No.	Last Cal.
X	Power Meter	Anritsu	ML2495A/6K00003357	May, 2011
X	Power Sensor	Anritsu	MA2411B/0738448	Jun, 2011

Note: 1. All equipments are calibrated every one year.
 2. The test instruments marked by “X” are used to measure the final test results.

3.2. Test Setup

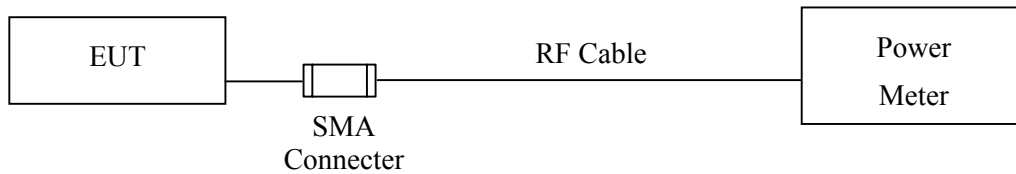

3.3. Limit

The maximum peak power shall be less 1Watt.

3.4. Test Procedure

The EUT was setup to ANSI C63.4, 2003; tested to FHSS test procedure of FCC Public Notice DA 00-705 for compliance to FCC 47CFR 15.247 requirements.

3.5. Uncertainty

± 1.27 dB

3.6. Test Result of Peak Power Output

Product : Tablet PC
Test Item : Peak Power Output
Test Site : No.3 OATS
Test Mode : Mode 1: Transmit - 1Mbps (GFSK)

Channel No.	Frequency (MHz)	Measurement (dBm)	Required Limit	Result
Channel 00	2402.00	5.87	1 Watt= 30 dBm	Pass
Channel 39	2441.00	6.97	1 Watt= 30 dBm	Pass
Channel 78	2480.00	7.67	1 Watt= 30 dBm	Pass

Product : Tablet PC
Test Item : Peak Power Output
Test Site : No.3 OATS
Test Mode : Mode 2: Transmit - 3Mbps (8DPSK)

Channel No.	Frequency (MHz)	Measurement (dBm)	Required Limit	Result
Channel 00	2402.00	6.07	1 Watt= 30 dBm	Pass
Channel 39	2441.00	7.14	1 Watt= 30 dBm	Pass
Channel 78	2480.00	7.85	1 Watt= 30 dBm	Pass

4. Radiated Emission

4.1. Test Equipment

The following test equipments are used during the radiated emission test:

Test Site		Equipment	Manufacturer	Model No./Serial No.	Last Cal.
☒ Site # 3	X	Bilog Antenna	Schaffner Chase	CBL6112B/2673	Sep., 2011
	X	Horn Antenna	Schwarzbeck	BBHA9120D/D305	Sep., 2011
	X	Horn Antenna	Schwarzbeck	BBHA9170/208	Jul., 2011
	X	Pre-Amplifier	Agilent	8447D/2944A09549	Sep., 2011
	X	Spectrum Analyzer	Agilent	E4407B / US39440758	May, 2011
	X	Test Receiver	R & S	ESCS 30/ 825442/018	Sep., 2011
	X	Coaxial Cable	Quietek	QTK-CABLE/ CAB5	Feb., 2012
	X	Controller	Quietek	QTK-CONTROLLER/ CTRL3	N/A
	X	Coaxial Switch	Anritsu	MP59B/6200265729	N/A

- Note: 1. All equipments are calibrated every one year.
 2. The test instruments marked by "X" are used to measure the final test results.

4.2. Test Setup

Below 1GHz

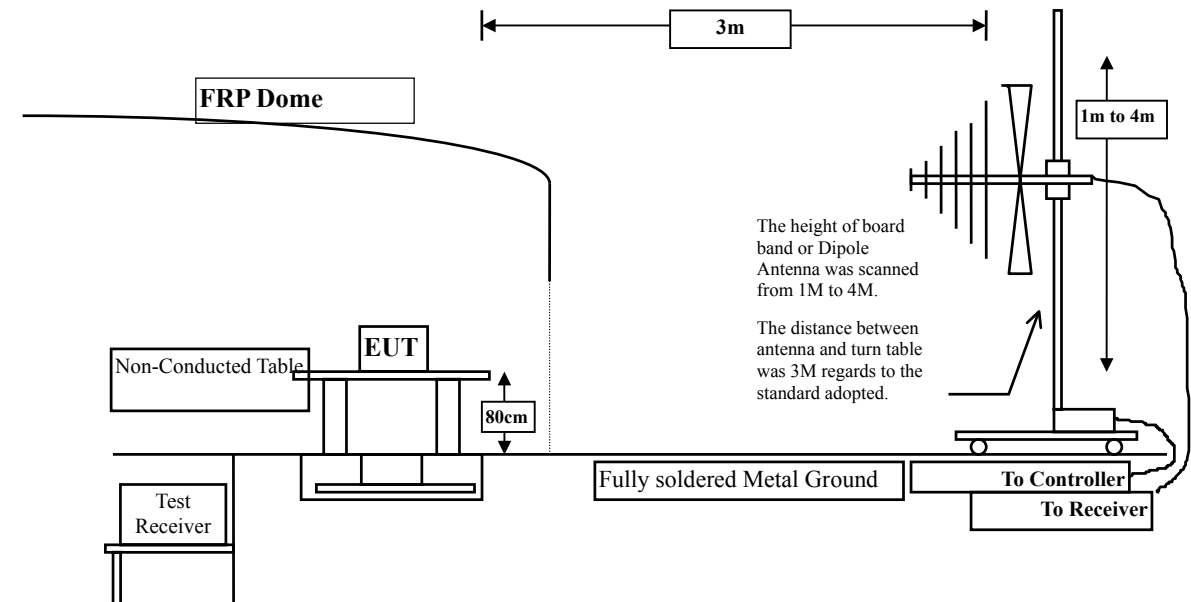

Above 1GHz

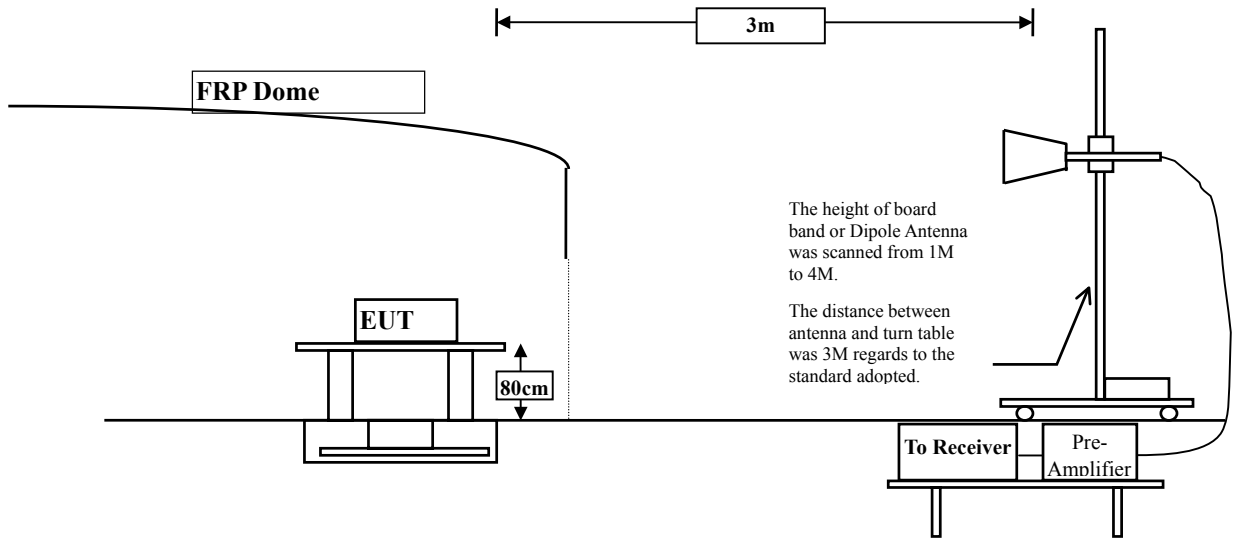

4.3. Limits

➤ General Radiated Emission Limits

Emissions radiated outside of the specified frequency bands, except for harmonics, shall be attenuated by at least 20dB below the level of the fundamental or to the general radiated emission limits in paragraph 15.209, whichever is the lesser attenuation.

FCC Part 15 Subpart C Paragraph 15.209 Limits		
Frequency MHz	uV/m @3m	dBuV/m@3m
30-88	100	40
88-216	150	43.5
216-960	200	46
Above 960	500	54

- Remarks:
1. RF Voltage (dBuV) = 20 log RF Voltage (uV)
 2. In the Above Table, the tighter limit applies at the band edges.
 3. Distance refers to the distance in meters between the measuring instrument antenna and the closed point of any part of the device or system.

4.4. Test Procedure

The EUT was setup according to ANSI C63.4, 2003 and tested according to FHSS test procedure of FCC Public Notice DA 00-705 for compliance to FCC 47CFR 15.247 requirements.

The EUT is placed on a turn table which is 0.8 meter above ground. The turn table is rotated 360 degrees to determine the position of the maximum emission level. The EUT was positioned such that the distance from antenna to the EUT was 3 meters.

The antenna is scanned from 1 meter to 4 meters to find out the maximum emission level. This is repeated for both horizontal and vertical polarization of the antenna. In order to find the maximum emission, all of the interface cables were manipulated according to ANSI C63.4:2003 on radiated measurement.

The resolution bandwidth below 1GHz setting on the field strength meter is 120 kHz and above 1GHz is 1MHz.

Radiated emission measurements below 1GHz are made using broadband Bilog antenna and above 1GHz are made using Horn Antennas.

The measurement is divided into the Preliminary Measurement and the Final Measurement.

The suspected frequencies are searched for in Preliminary Measurement with the measurement antenna kept pointed at the source of the emission both in azimuth and elevation, with the polarization of the antenna oriented for maximum response. The antenna is pointed at an angle towards the source of the emission, and the EUT is rotated in both height and polarization to maximize the measured emission. The emission is kept within the illumination area of the 3 dB bandwidth of the antenna.

The worst radiated emission is measured on the Final Measurement.

The measurement frequency range from 30MHz - 10th Harmonic of fundamental was investigated.

4.5. Uncertainty

± 3.9 dB above 1GHz

± 3.8 dB below 1GHz

4.6. Test Result of Radiated Emission

Product : Tablet PC
 Test Item : Harmonic Radiated Emission
 Test Site : No.3 OATS
 Test Mode : Mode 1: Transmit - 1Mbps (GFSK)(2402MHz)

Frequency MHz	Correct Factor dB	Reading Level dBuV	Measurement Level dBuV/m	Margin dB	Limit dBuV/m
Horizontal					
Peak Detector:					
4804.000	3.327	37.500	40.827	-33.173	74.000
7206.000	10.136	36.060	46.196	-27.804	74.000
9608.000	13.706	35.100	48.806	-25.194	74.000
Average Detector:					
--					
Vertical					
Peak Detector:					
4804.000	6.638	38.500	45.137	-28.863	74.000
7206.000	11.005	36.380	47.385	-26.615	74.000
9608.000	14.103	35.460	49.563	-24.437	74.000
Average Detector:					
--					

Note:

1. All Readings below 1GHz are Quasi-Peak, above 1GHz are performed with peak and/or average measurements as necessary.
2. Peak measurements: RBW = 1MHz, VBW = 3 MHz, Sweep: Auto.
3. Average measurements: RBW = 1MHz, VBW = 10 Hz, Sweep: Auto.
4. Measurement Level = Reading Level + Correct Factor.
5. Correct Factor = Antenna factor + Cable loss – Amplifier gain.
6. The average measurement was not performed when the peak measured data under the limit of average detection.
7. The emission levels of other frequencies are very lower than the limit and not show in test report.

Product : Tablet PC
 Test Item : Harmonic Radiated Emission
 Test Site : No.3 OATS
 Test Mode : Mode 1: Transmit - 1Mbps (GFSK)(2441MHz)

Frequency MHz	Correct Factor dB	Reading Level dBuV	Measurement Level dBuV/m	Margin dB	Limit dBuV/m
Horizontal					
Peak Detector:					
4882.000	3.001	36.550	39.551	-34.449	74.000
7323.000	11.846	34.630	46.477	-27.523	74.000
9764.000	12.563	36.450	49.013	-24.987	74.000
Average Detector:					
--					
Vertical					
Peak Detector:					
4882.000	5.713	36.540	42.254	-31.746	74.000
7323.000	12.727	35.450	48.178	-25.822	74.000
9764.000	13.028	36.050	49.078	-24.922	74.000
Average Detector:					
--					

Note:

1. All Readings below 1GHz are Quasi-Peak, above 1GHz are performed with peak and/or average measurements as necessary.
2. Peak measurements: RBW = 1MHz, VBW = 3 MHz, Sweep: Auto.
3. Average measurements: RBW = 1MHz, VBW = 10 Hz, Sweep: Auto.
4. Measurement Level = Reading Level + Correct Factor.
5. Correct Factor = Antenna factor + Cable loss – Amplifier gain.
6. The average measurement was not performed when the peak measured data under the limit of average detection.
7. The emission levels of other frequencies are very lower than the limit and not show in test report.

Product : Tablet PC
 Test Item : Harmonic Radiated Emission
 Test Site : No.3 OATS
 Test Mode : Mode 1: Transmit - 1Mbps (GFSK)(2480MHz)

Frequency MHz	Correct Factor dB	Reading Level dBuV	Measurement Level dBuV/m	Margin dB	Limit dBuV/m
Horizontal					
Peak Detector:					
4960.000	2.760	37.780	40.540	-33.460	74.000
7440.000	12.567	34.220	46.786	-27.214	74.000
9920.000	13.456	35.210	48.666	-25.334	74.000
Average Detector:					
--					
Vertical					
Peak Detector:					
4960.000	5.557	39.330	44.887	-29.113	74.000
7440.000	13.426	34.480	47.905	-26.095	74.000
9920.000	13.958	35.950	49.908	-24.092	74.000
Average Detector:					
--					

Note:

1. All Readings below 1GHz are Quasi-Peak, above 1GHz are performed with peak and/or average measurements as necessary.
2. Peak measurements: RBW = 1MHz, VBW = 3 MHz, Sweep: Auto.
3. Average measurements: RBW = 1MHz, VBW = 10 Hz, Sweep: Auto.
4. Measurement Level = Reading Level + Correct Factor.
5. Correct Factor = Antenna factor + Cable loss – Amplifier gain.
6. The average measurement was not performed when the peak measured data under the limit of average detection.
7. The emission levels of other frequencies are very lower than the limit and not show in test report.

Product : Tablet PC
 Test Item : Harmonic Radiated Emission
 Test Site : No.3 OATS
 Test Mode : Mode 2: Transmit - 3Mbps (8DPSK)(2402MHz)

Frequency MHz	Correct Factor dB	Reading Level dBuV	Measurement Level dBuV/m	Margin dB	Limit dBuV/m
Horizontal					
Peak Detector:					
4804.000	3.327	37.320	40.647	-33.353	74.000
7206.000	10.136	35.830	45.966	-28.034	74.000
9608.000	13.706	35.120	48.826	-25.174	74.000
Average Detector:					
--					
Vertical					
Peak Detector:					
4804.000	6.638	37.420	44.057	-29.943	74.000
7206.000	11.005	36.350	47.355	-26.645	74.000
9608.000	14.103	34.970	49.073	-24.927	74.000
Average Detector:					
--					

Note:

1. All Readings below 1GHz are Quasi-Peak, above 1GHz are performed with peak and/or average measurements as necessary.
2. Peak measurements: RBW = 1MHz, VBW = 3 MHz, Sweep: Auto.
3. Average measurements: RBW = 1MHz, VBW = 10 Hz, Sweep: Auto.
4. Measurement Level = Reading Level + Correct Factor.
5. Correct Factor = Antenna factor + Cable loss – Amplifier gain.
6. The average measurement was not performed when the peak measured data under the limit of average detection.
7. The emission levels of other frequencies are very lower than the limit and not show in test report.

Product : Tablet PC
 Test Item : Harmonic Radiated Emission
 Test Site : No.3 OATS
 Test Mode : Mode 2: Transmit - 3Mbps (8DPSK) (2441MHz)

Frequency MHz	Correct Factor dB	Reading Level dBuV	Measurement Level dBuV/m	Margin dB	Limit dBuV/m
Horizontal					
Peak Detector:					
4882.000	3.001	38.170	41.171	-32.829	74.000
7323.000	11.846	35.170	47.017	-26.983	74.000
9764.000	12.563	36.830	49.393	-24.607	74.000
Average Detector:					
--					
Vertical					
Peak Detector:					
4884.000	5.689	39.280	44.970	-29.030	74.000
7323.000	12.727	34.990	47.718	-26.282	74.000
9764.000	13.028	35.860	48.888	-25.112	74.000
Average Detector:					
--					

Note:

1. All Readings below 1GHz are Quasi-Peak, above 1GHz are performed with peak and/or average measurements as necessary.
2. Peak measurements: RBW = 1MHz, VBW = 3 MHz, Sweep: Auto.
3. Average measurements: RBW = 1MHz, VBW = 10 Hz, Sweep: Auto.
4. Measurement Level = Reading Level + Correct Factor.
5. Correct Factor = Antenna factor + Cable loss – Amplifier gain.
6. The average measurement was not performed when the peak measured data under the limit of average detection.
7. The emission levels of other frequencies are very lower than the limit and not show in test report.

Product : Tablet PC
 Test Item : Harmonic Radiated Emission
 Test Site : No.3 OATS
 Test Mode : Mode 2: Transmit - 3Mbps (8DPSK) (2480MHz)

Frequency MHz	Correct Factor dB	Reading Level dBuV	Measurement Level dBuV/m	Margin dB	Limit dBuV/m
Horizontal					
Peak Detector:					
4960.000	2.760	37.030	39.790	-34.210	74.000
7440.000	12.567	34.210	46.776	-27.224	74.000
9920.000	13.456	35.650	49.106	-24.894	74.000
Average Detector:					
--					
Vertical					
Peak Detector:					
4960.000	5.557	38.380	43.937	-30.063	74.000
7440.000	13.426	35.100	48.525	-25.475	74.000
9920.000	13.958	35.850	49.808	-24.192	74.000
Average Detector:					
--					

Note:

1. All Readings below 1GHz are Quasi-Peak, above 1GHz are performed with peak and/or average measurements as necessary.
2. Peak measurements: RBW = 1MHz, VBW = 3 MHz, Sweep: Auto.
3. Average measurements: RBW = 1MHz, VBW = 10 Hz, Sweep: Auto.
4. Measurement Level = Reading Level + Correct Factor.
5. Correct Factor = Antenna factor + Cable loss – Amplifier gain.
6. The average measurement was not performed when the peak measured data under the limit of average detection.
7. The emission levels of other frequencies are very lower than the limit and not show in test report.

Product : Tablet PC
 Test Item : General Radiated Emission
 Test Site : No.3 OATS
 Test Mode : Mode 1: Transmit - 1Mbps (GFSK) (2441MHz)

Frequency MHz	Correct Factor dB	Reading Level dBuV	Measurement Level dBuV/m	Margin dB	Limit dBuV/m
Horizontal					
115.360	-8.770	32.962	24.192	-19.308	43.500
229.820	-8.162	39.910	31.748	-14.252	46.000
402.480	-2.263	34.850	32.587	-13.413	46.000
662.440	2.084	29.600	31.684	-14.316	46.000
778.840	4.169	30.893	35.062	-10.938	46.000
864.200	5.671	24.758	30.429	-15.571	46.000
Vertical					
115.360	-2.630	35.364	32.734	-10.766	43.500
200.720	-7.835	44.505	36.670	-6.830	43.500
402.480	-5.823	37.033	31.210	-14.790	46.000
691.540	2.421	31.907	34.328	-11.672	46.000
807.940	3.586	35.356	38.941	-7.059	46.000
951.500	6.621	31.649	38.270	-7.730	46.000

Note:

1. All Readings below 1GHz are Quasi-Peak, above 1GHz are performed with peak and/or average measurements as necessary.
2. Peak measurements: RBW = 1MHz, VBW = 3 MHz, Sweep: Auto.
3. Average measurements: RBW = 1MHz, VBW = 10 Hz, Sweep: Auto.
4. Measurement Level = Reading Level + Correct Factor.
5. Correct Factor = Antenna factor + Cable loss – Amplifier gain.
6. The average measurement was not performed when the peak measured data under the limit of average detection.
7. The emission levels of other frequencies are very lower than the limit and not show in test report.

Product : Tablet PC
 Test Item : General Radiated Emission
 Test Site : No.3 OATS
 Test Mode : Mode 2: Transmit - 3Mbps (8DPSK) (2441MHz)

Frequency MHz	Correct Factor dB	Reading Level dBuV	Measurement Level dBuV/m	Margin dB	Limit dBuV/m
Horizontal					
53.280	-12.652	38.538	25.886	-14.114	40.000
229.820	-8.162	38.519	30.357	-15.643	46.000
402.480	-2.263	35.330	33.067	-12.933	46.000
577.080	3.169	27.389	30.558	-15.442	46.000
778.840	4.169	28.161	32.330	-13.670	46.000
922.400	6.334	24.738	31.072	-14.928	46.000
Vertical					
115.360	-2.630	31.851	29.221	-14.279	43.500
200.720	-7.835	41.343	33.508	-9.992	43.500
402.480	-5.823	35.419	29.596	-16.404	46.000
518.880	-0.546	31.954	31.408	-14.592	46.000
778.840	2.889	31.624	34.513	-11.487	46.000
951.500	6.621	28.039	34.660	-11.340	46.000

Note:

1. All Readings below 1GHz are Quasi-Peak, above 1GHz are performed with peak and/or average measurements as necessary.
2. Peak measurements: RBW = 1MHz, VBW = 3 MHz, Sweep: Auto.
3. Average measurements: RBW = 1MHz, VBW = 10 Hz, Sweep: Auto.
4. Measurement Level = Reading Level + Correct Factor.
5. Correct Factor = Antenna factor + Cable loss – Amplifier gain.
6. The average measurement was not performed when the peak measured data under the limit of average detection.
7. The emission levels of other frequencies are very lower than the limit and not show in test report.

5. RF Antenna Conducted Test

5.1. Test Equipment

Equipment	Manufacturer	Model No./Serial No.	Last Cal.
Spectrum Analyzer	R&S	FSP40 / 100170	Jun, 2011
Spectrum Analyzer	Agilent	E4407B / US39440758	Jun, 2011
X Spectrum Analyzer	Agilent	N9010A / MY48030495	Apr., 2011

Note: 1. All equipments are calibrated every one year.
 2. The test instruments Marked “X” are used to measure the final test results.

5.2. Test Setup

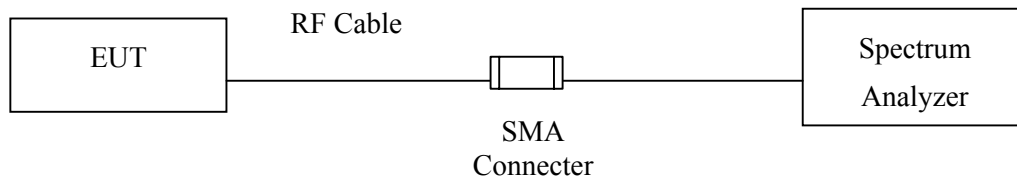

5.3. Limits

According to FCC Section 15.247(d). In any 100 kHz bandwidth outside the frequency band in which the spread spectrum or digitally modulated intentional radiator is operating, the radio frequency power that is produced by the intentional radiator shall be at least 20 dB below that in the 100 kHz bandwidth within the band that contains the highest level of the desired power, based on either an RF conducted or measurement, provided the transmitter demonstrates compliance with the peak conducted power limits. If the transmitter complies with the conducted power limits based on the use of RMS averaging over a time interval, the attenuation required under this paragraph shall be 30 dB instead of 20 dB.

5.4. Test Procedure

The EUT was setup to ANSI C63.4, 2003; tested to FHSS test procedure of FCC Public Notice DA 00-705 for compliance to FCC 47CFR 15.247 requirements.

5.5. Uncertainty

± 150Hz

5.6. Test Result of RF Antenna Conducted Test

Product : Tablet PC
 Test Item : RF Antenna Conducted Test
 Test Site : No.3 OATS
 Test Mode : Mode 1: Transmit - 1Mbps (GFSK)

Figure Channel 00:

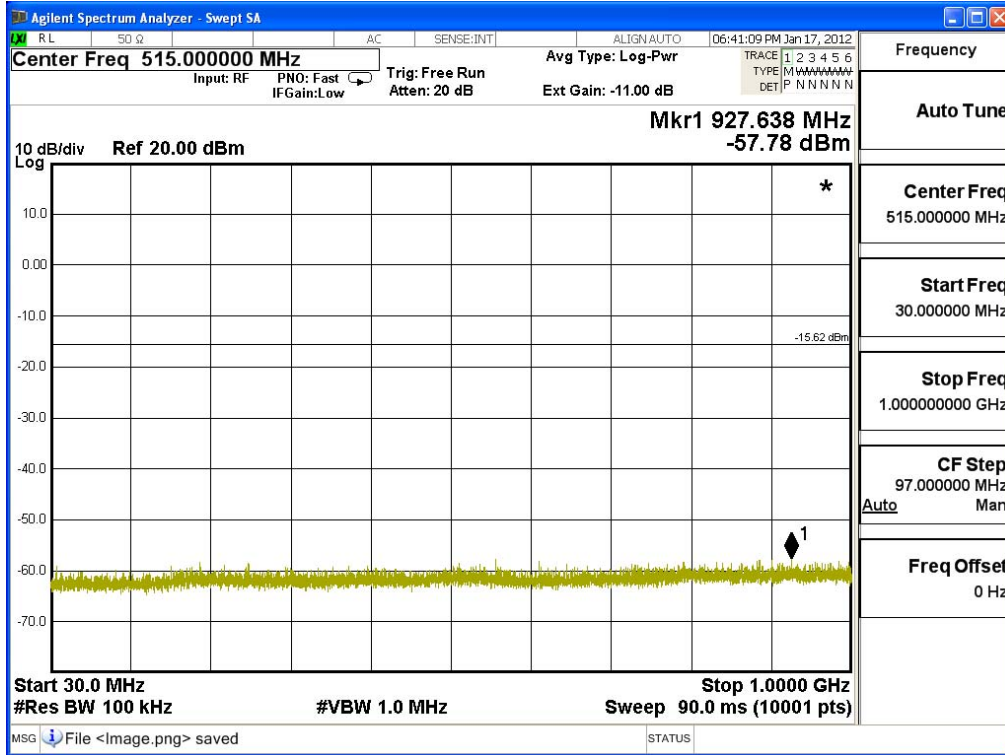

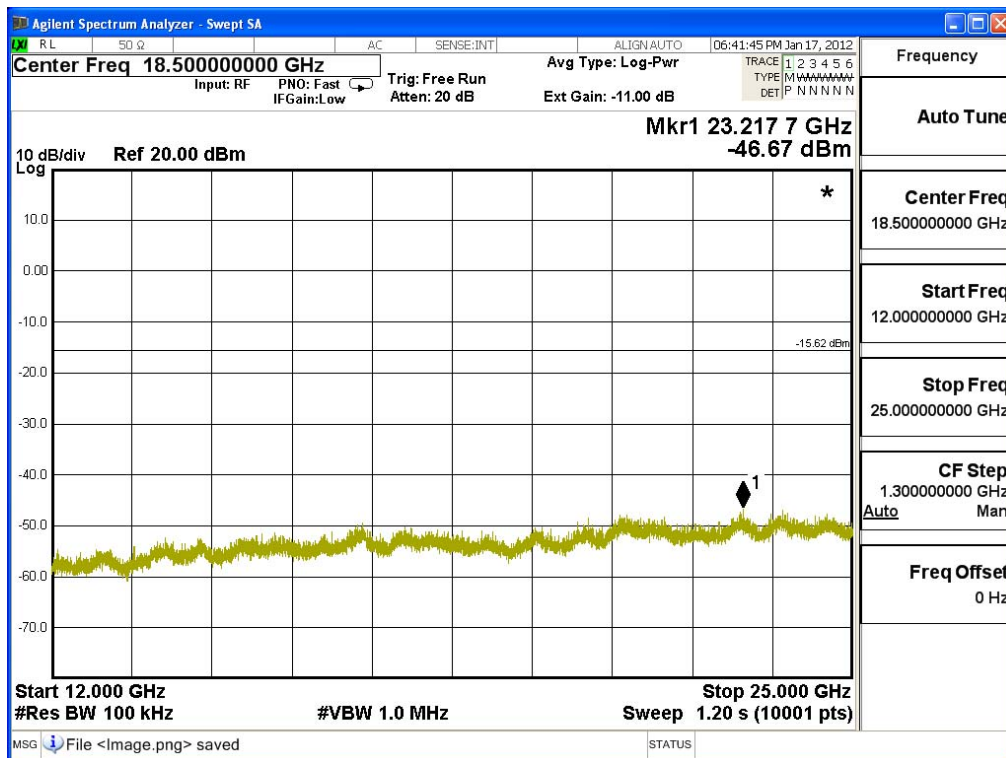
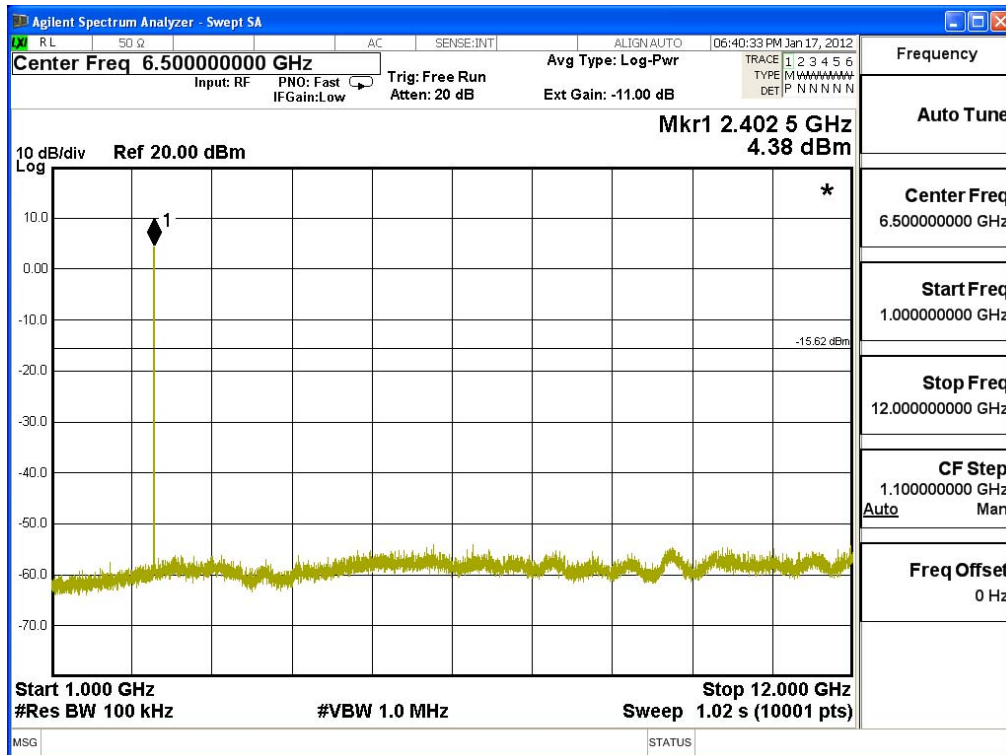

Product : Tablet PC
 Test Item : RF Antenna Conducted Test
 Test Site : No.3 OATS
 Test Mode : Mode 1: Transmit - 1Mbps (GFSK)

Figure Channel 39:

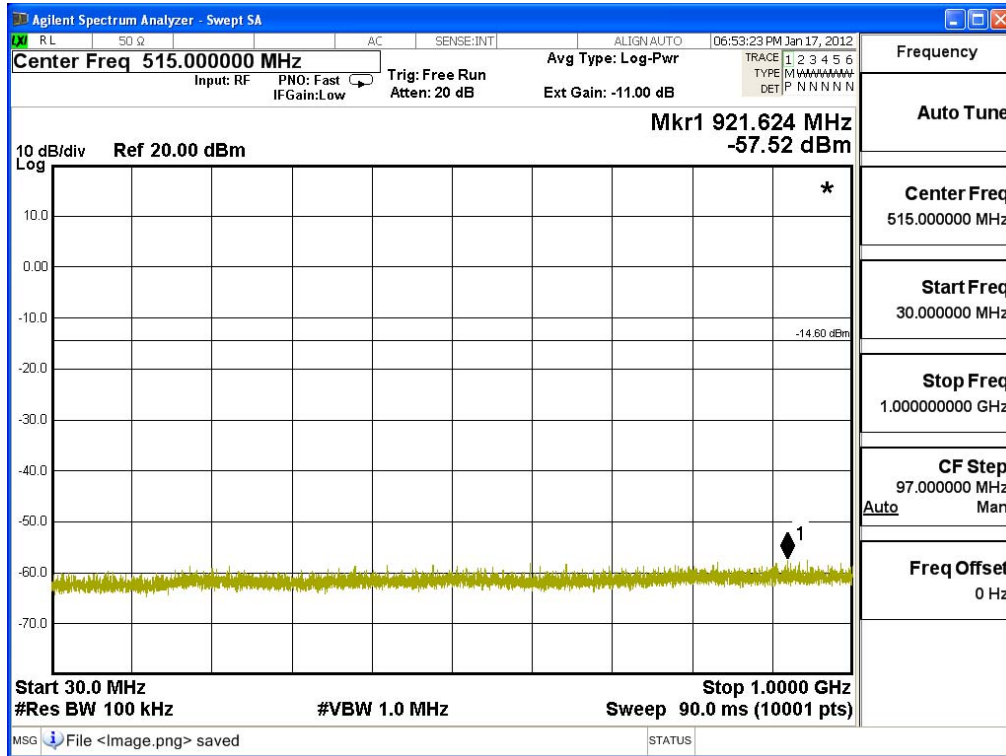

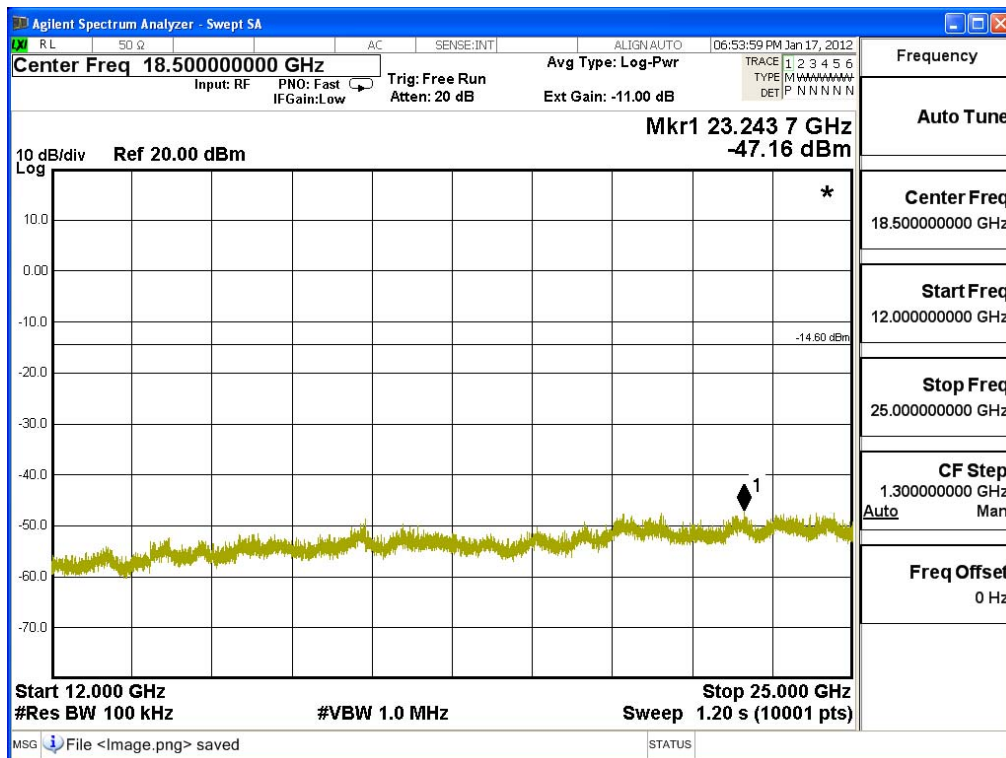
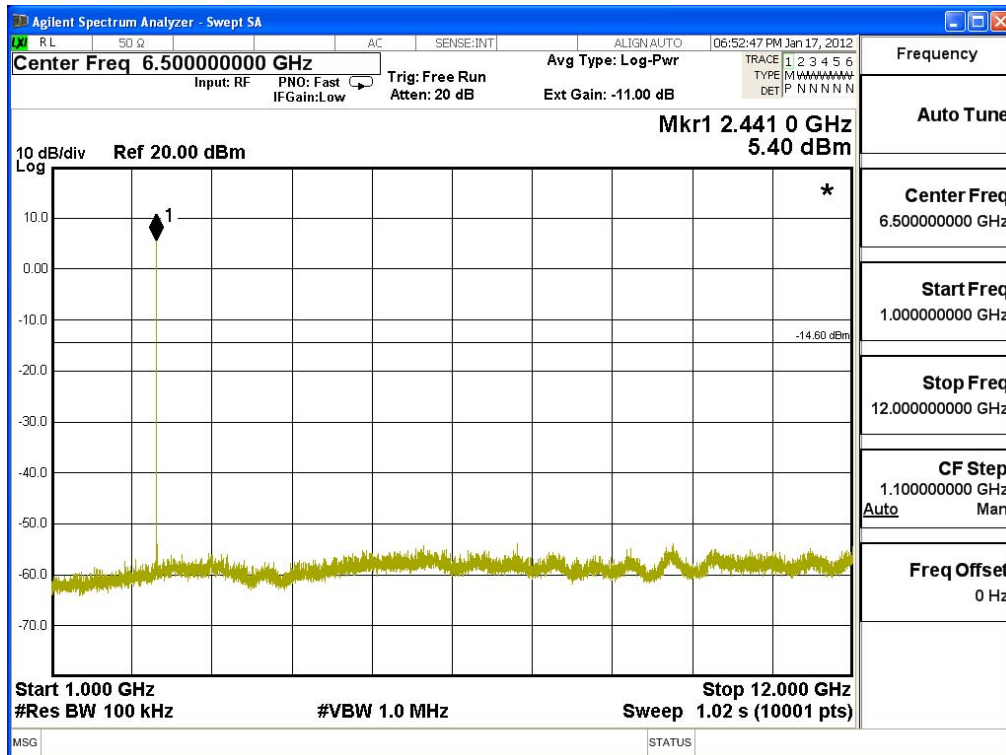

Product : Tablet PC
 Test Item : RF Antenna Conducted Test
 Test Site : No.3 OATS
 Test Mode : Mode 1: Transmit - 1Mbps (GFSK)

Figure Channel 78:

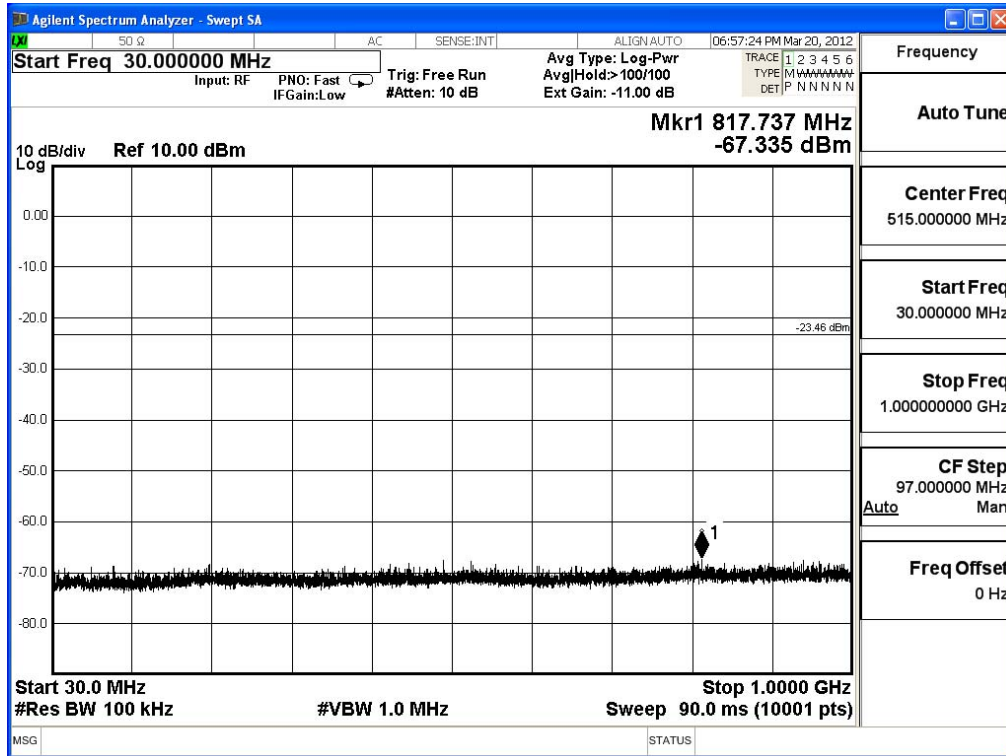

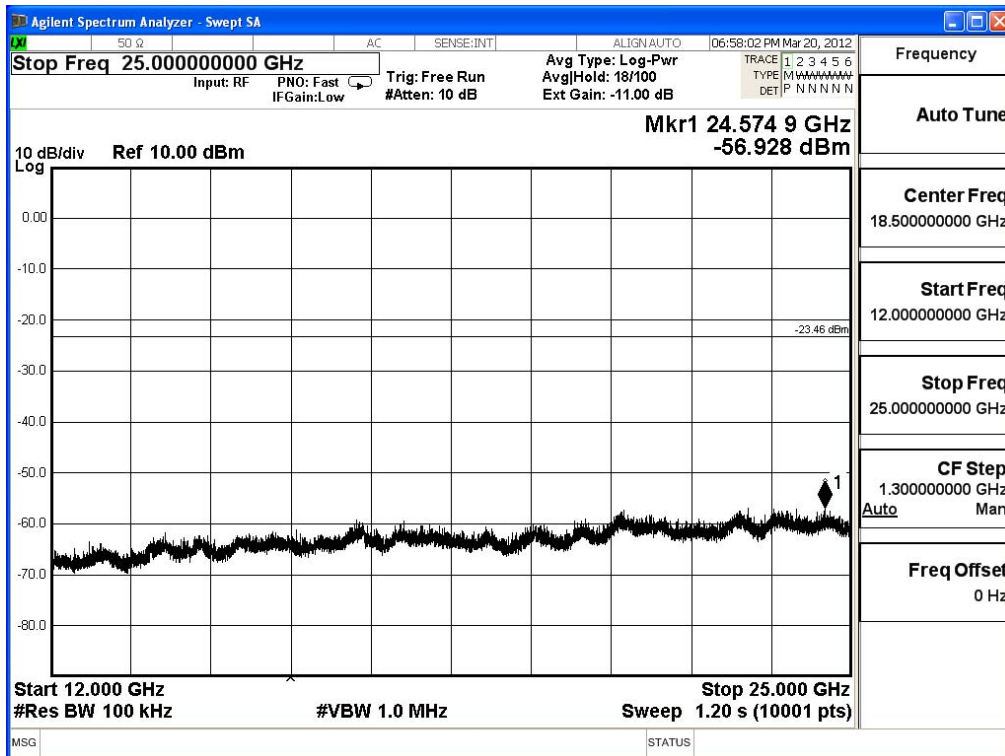
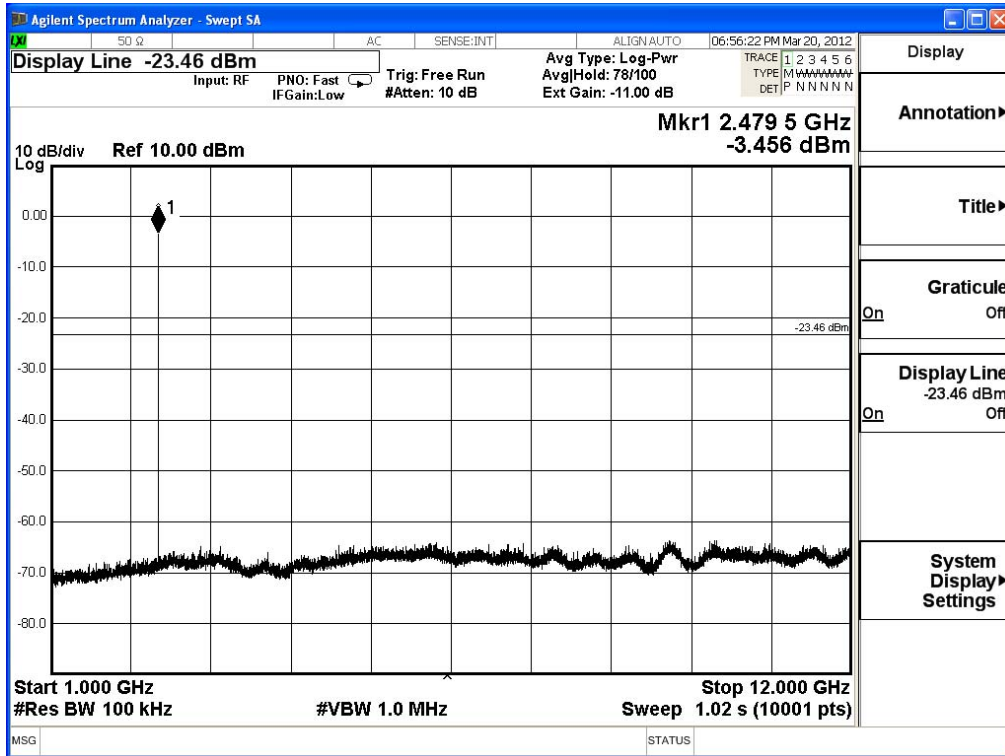

Product : Tablet PC
 Test Item : RF Antenna Conducted Test
 Test Site : No.3 OATS
 Test Mode : Mode 2: Transmit - 3Mbps (8DPSK)

Figure Channel 00:

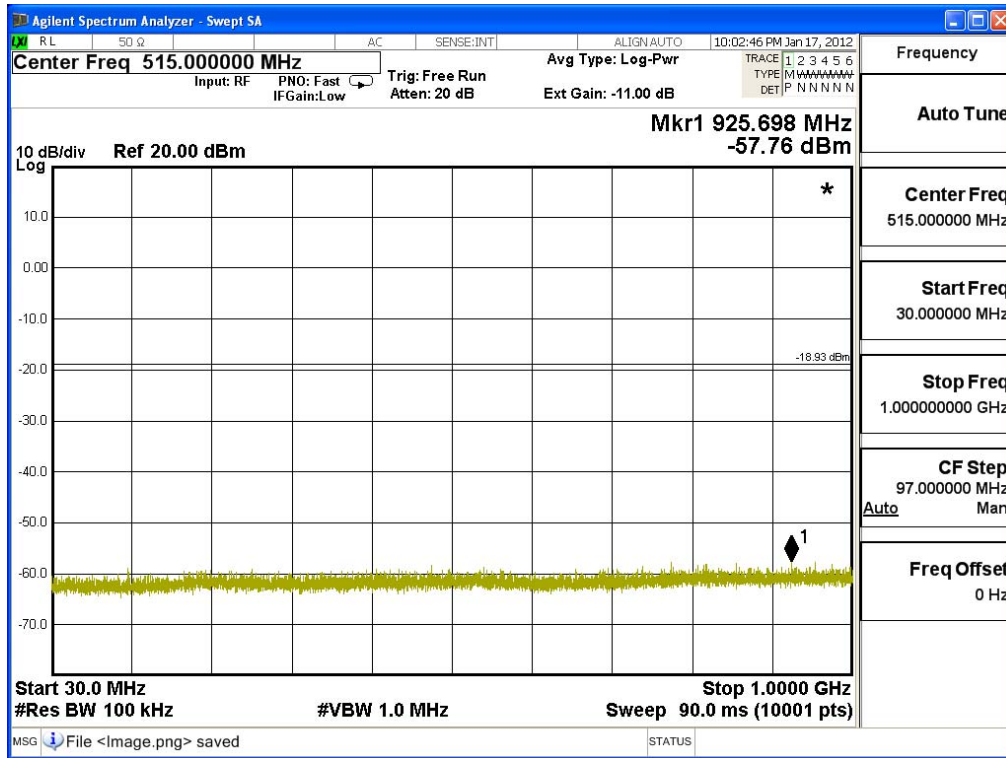

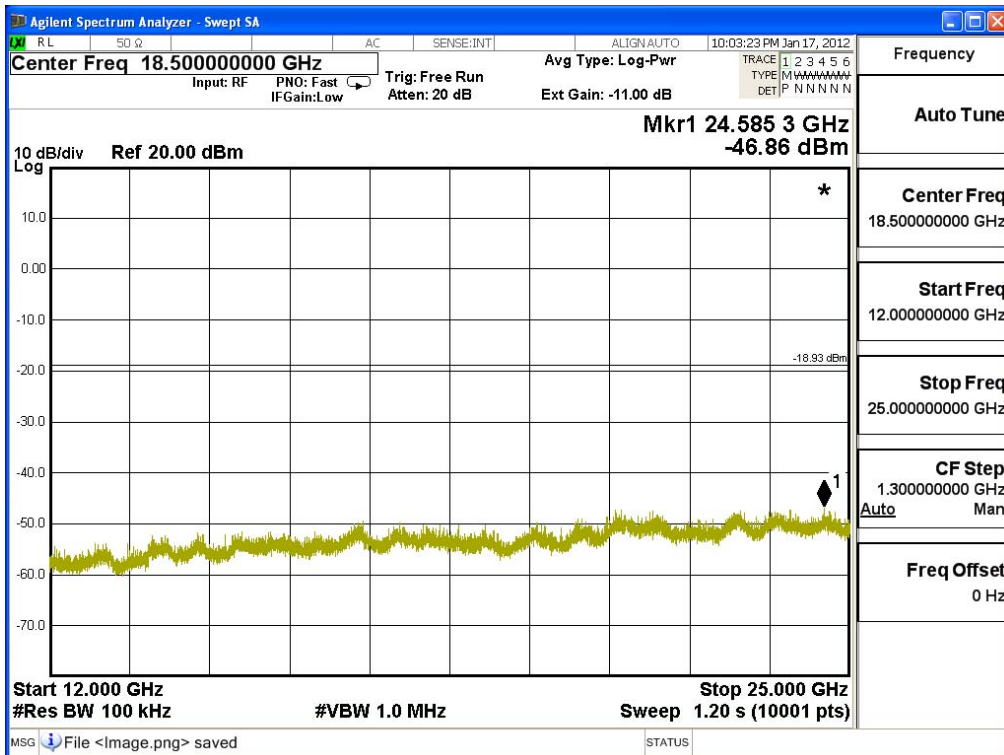
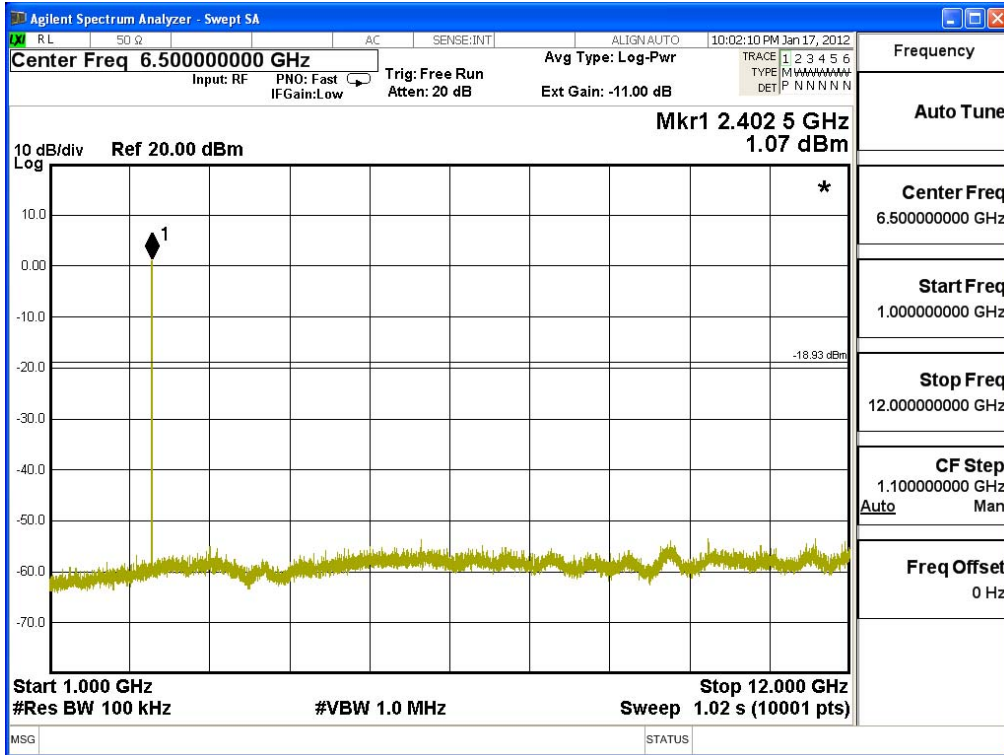

Product : Tablet PC
 Test Item : RF Antenna Conducted Test
 Test Site : No.3 OATS
 Test Mode : Mode 2: Transmit - 3Mbps (8DPSK)

Figure Channel 39:

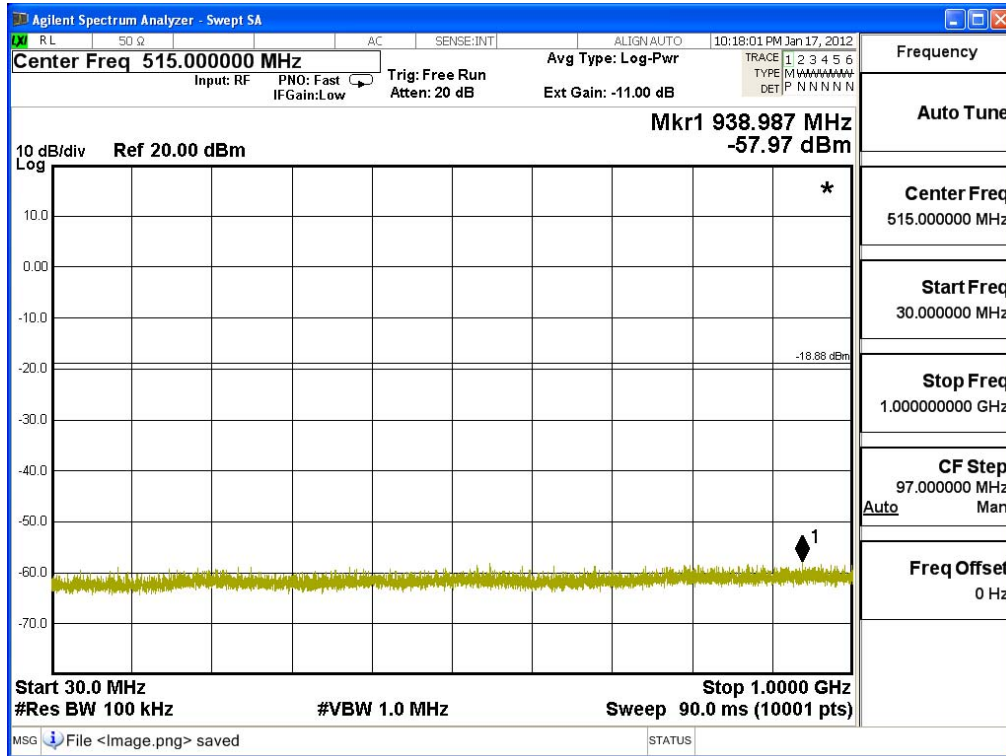

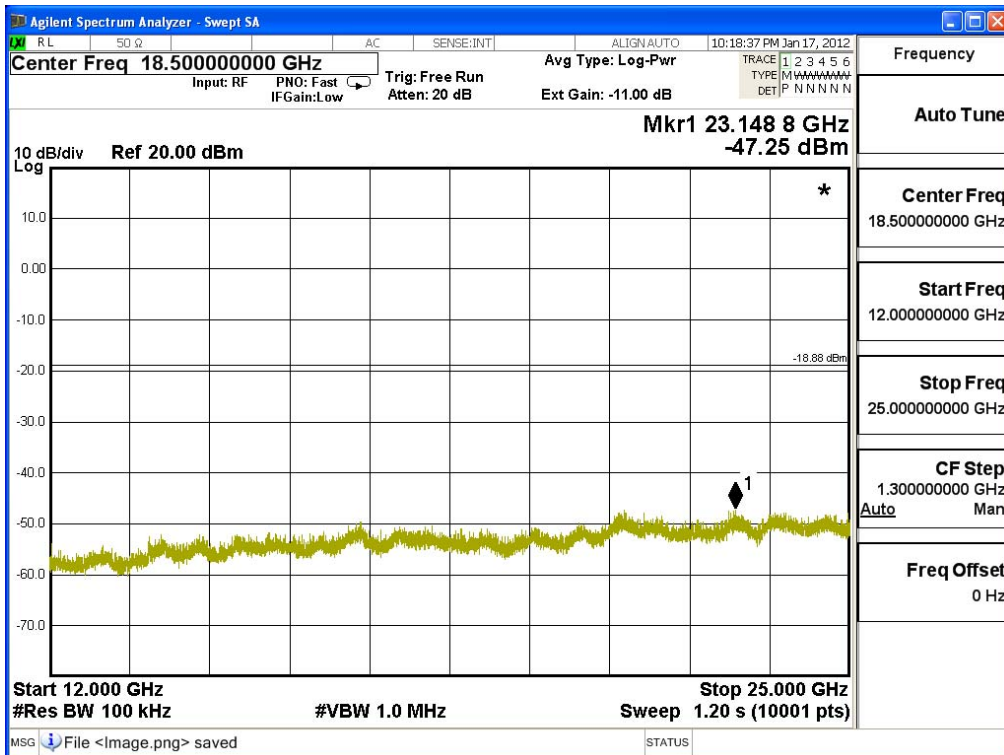
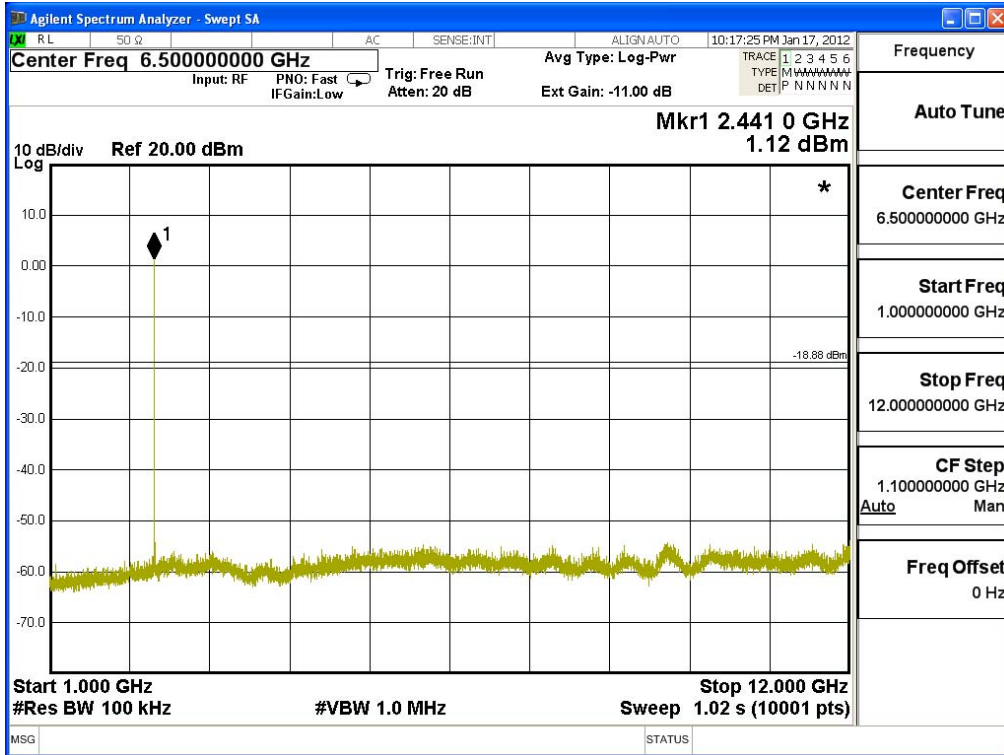

Product : Tablet PC
 Test Item : RF Antenna Conducted Test
 Test Site : No.3 OATS
 Test Mode : Mode 2: Transmit - 3Mbps (8DPSK)

Figure Channel 78:

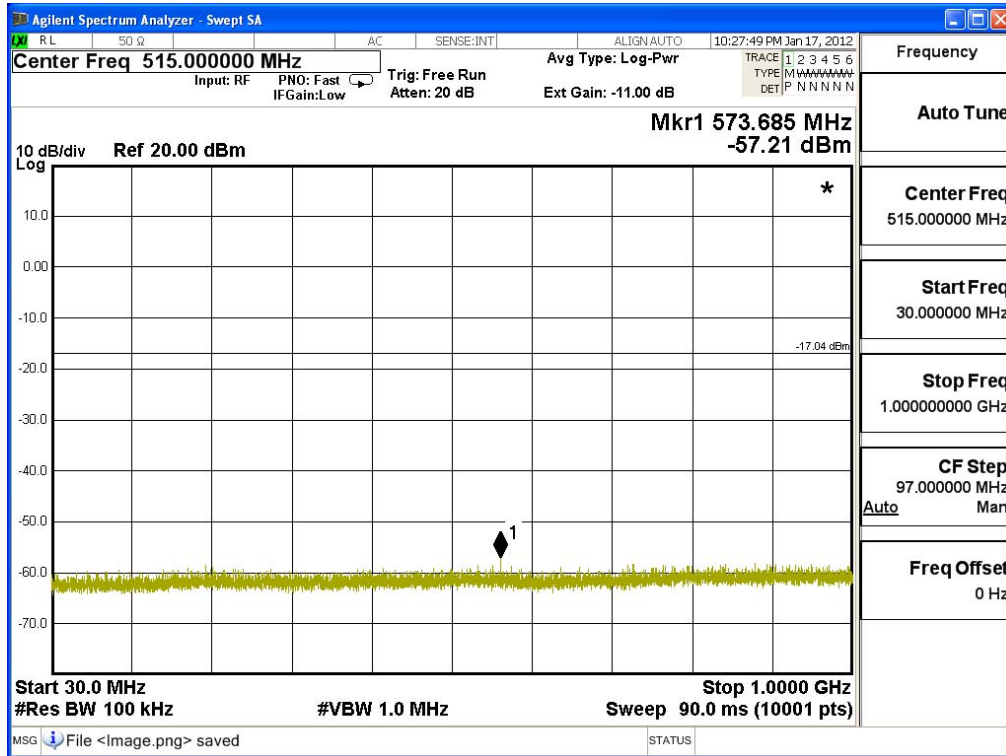

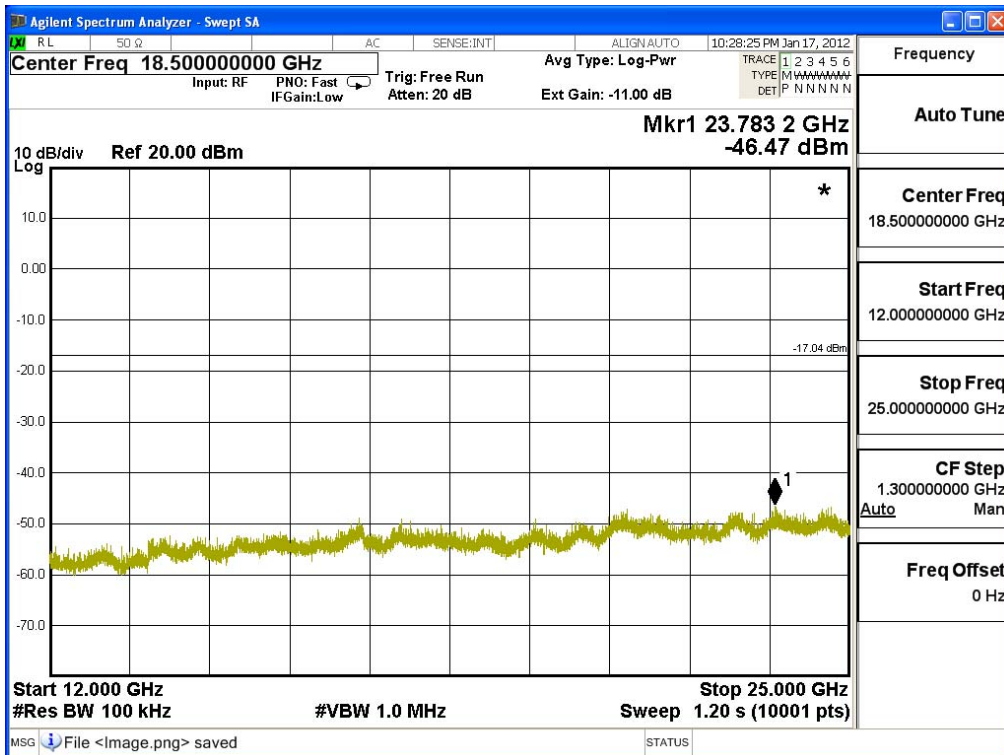
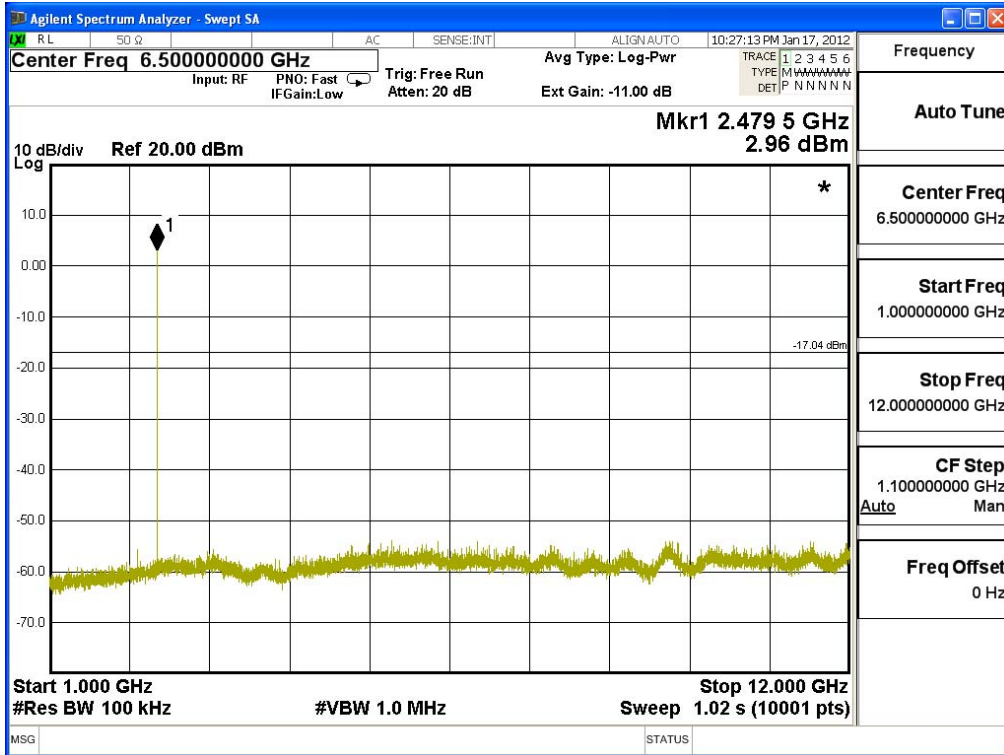

6. Band Edge

6.1. Test Equipment

RF Conducted Measurement

The following test equipments are used during the band edge tests:

	Equipment	Manufacturer	Model No./Serial No.	Last Cal.
	Spectrum Analyzer	R&S	FSP40 / 100170	Jun, 2011
	Spectrum Analyzer	Agilent	E4407B / US39440758	Jun, 2011
X	Spectrum Analyzer	Agilent	N9010A / MY48030495	Apr., 2011

RF Radiated Measurement:

The following test equipments are used during the band edge tests:

Test Site		Equipment	Manufacturer	Model No./Serial No.	Last Cal.
☒ Site # 3		Bilog Antenna	Schaffner Chase	CBL6112B/2673	Sep., 2011
	X	Horn Antenna	Schwarzbeck	BBHA9120D/D305	Sep., 2011
		Horn Antenna	Schwarzbeck	BBHA9170/208	Jul., 2011
	X	Pre-Amplifier	Agilent	8447D/2944A09549	Sep., 2011
	X	Spectrum Analyzer	Agilent	E4407B / US39440758	May, 2011
		Test Receiver	R & S	ESCS 30/ 825442/018	Sep., 2011
	X	Coaxial Cable	Quietek	QTK-CABLE/ CAB5	Feb., 2012
	X	Controller	Quietek	QTK-CONTROLLER/ CTRL3	N/A
	X	Coaxial Switch	Anritsu	MP59B/6200265729	N/A

- Note:
1. All equipments are calibrated every one year.
 2. The test instruments marked by "X" are used to measure the final test results.

6.2. Test Setup

RF Conducted Measurement

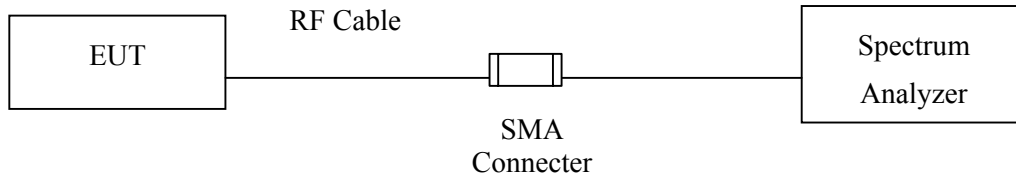

RF Radiated Measurement:

Above 1GHz

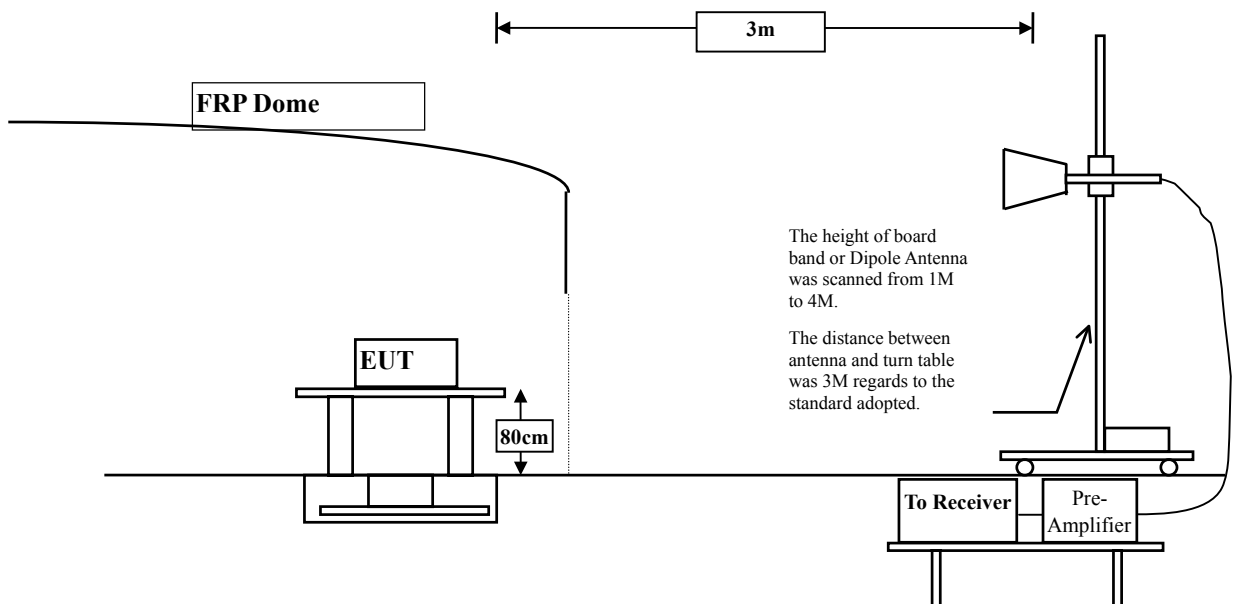

6.3. Limit

In any 100 kHz bandwidth outside the frequency band in which the spread spectrum intentional radiator is operating, the radio frequency power that is produced by the intentional radiator shall be at least 20 dB below that in the 100 kHz bandwidth within the band that contains the highest level of the desired power, based on either an RF conducted or a radiated measurement. Attenuation below the general limits specified in Section 15.209(a) is not required. In addition, radiated emissions which fall in the restricted bands, as defined in Section 15.205(a), must also comply with the radiated emission limits specified in Section 15.209(a) (see Section 15.205(c)).

6.4. Test Procedure

The EUT and its simulators are placed on a turn table which is 0.8 meter above ground. The turn table can rotate 360 degrees to determine the position of the maximum emission level. The EUT was positioned such that the distance from antenna to the EUT was 3 meters.

The antenna can move up and down between 1 meter and 4 meters to find out the maximum emission level.

Both horizontal and vertical polarization of the antenna are set on measurement. In order to find the maximum emission, all of the interface cables must be manipulated according to ANSI C63.4:2003 on radiated measurement.

The bandwidth below 1GHz setting on the field strength meter is 120 kHz, above 1GHz are 1 MHz. The EUT was setup to ANSI C63.4, 2003; tested to FHSS test procedure of FCC Public Notice DA 00-705 for compliance to FCC 47CFR 15.247 requirements.

6.5. Uncertainty

± 3.9 dB above 1GHz

± 3.8 dB below 1GHz

6.6. Test Result of Band Edge

Product : Tablet PC
 Test Item : Band Edge
 Test Site : No.3 OATS
 Test Mode : Mode 1: Transmit - 1Mbps (GFSK)

Fundamental Filed Strength

Antenna Pole	Frequency [MHz]	Correction Factor [dB/m]	Reading Level [dBuV]	Emission Level [dBuV/m]	Detector
Horizontal	2402	30.48	68.67	100.244	Peak
Horizontal	2402	30.48	43.19	74.764	Average
Vertical	2402	30.917	68.02	98.937	Peak
Vertical	2402	30.917	56.89	87.807	Average

Note: 1:Spectrum Analyzer setting:

Peak detector: RBW=1MHz, VBW=1MHz

Average detector: RBW=1MHz, VBW=10Hz

Band Edge Test Data

Antenna Pole	Test Frequency (MHz)	Fundamental (dBuV/m)	Δ (dB)	Band Edge Field Strength (dBuV/m)	Limit (dBuV/m)	Detector
Horizontal	2355.9	100.244	53.14	47.104	74.000	Peak
Horizontal	2389.8	74.764	52.59	22.174	54.000	Average
Vertical	2355.9	98.937	53.14	45.797	74.000	Peak
Vertical	2389.8	87.807	52.59	35.217	54.000	Average

Note:

The Band Edge Field Strength was calculated using the Fundamental and Conducted Band Edge measurements per the Marker-Delta Method with the following formula:

Band Edge field Strength = F - Δ

F = Fundamental field Strength (Peak or Average)

Δ = Conducted Band Edge Delta (Peak or Average)

Peak Detector of conducted Band Edge Delta

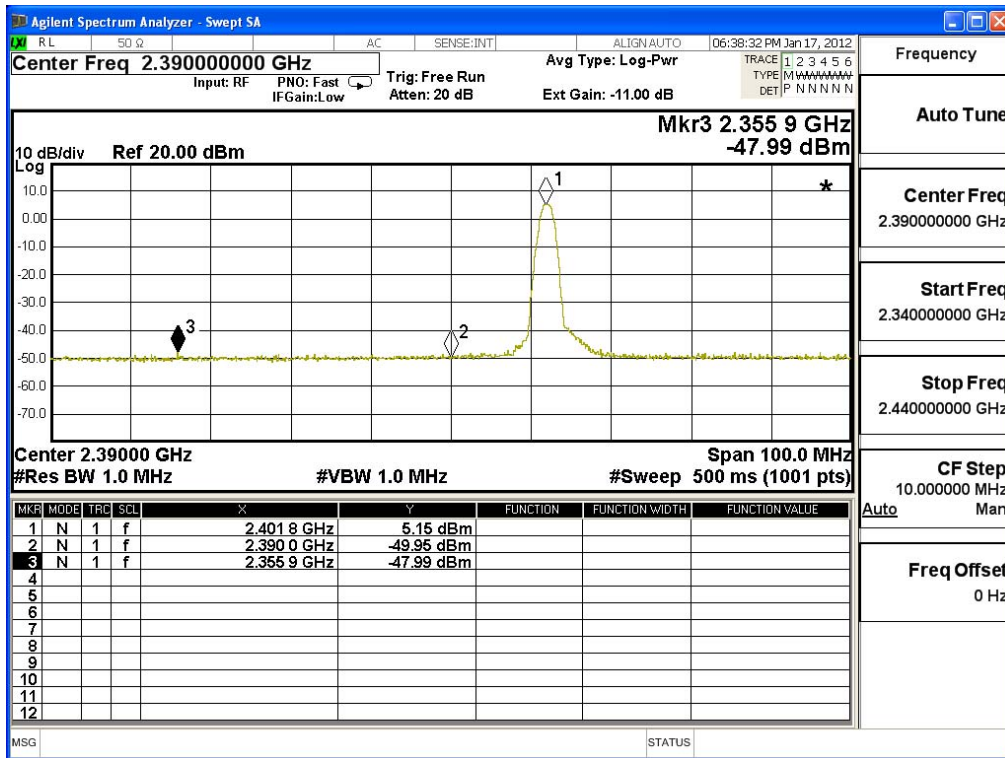

Average Detector of conducted Band Edge Delta

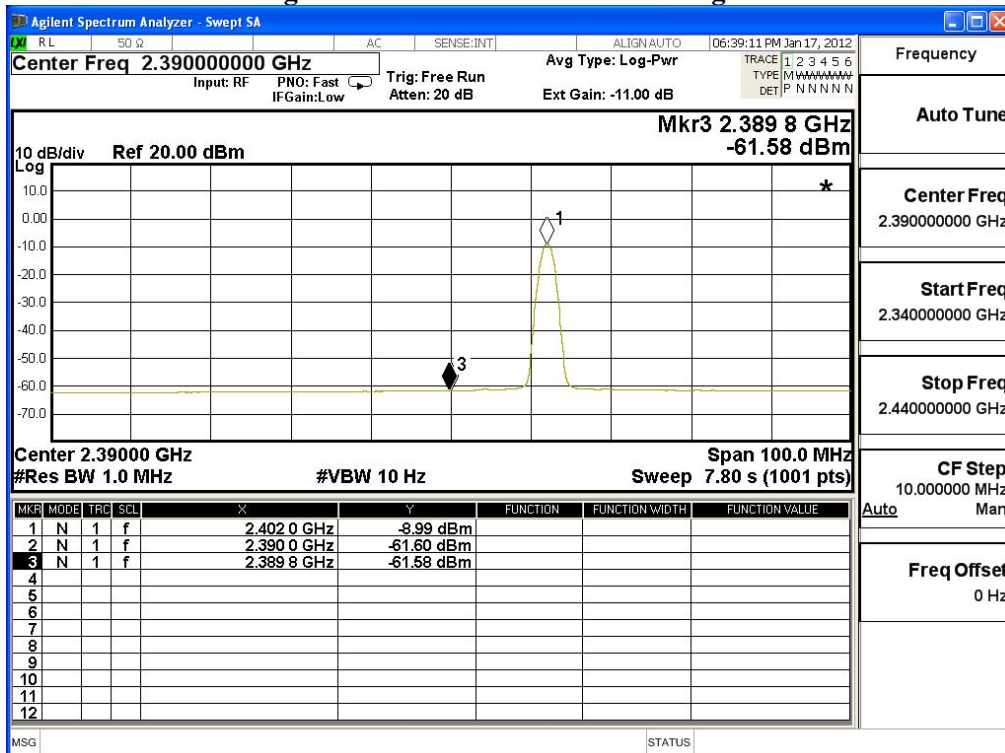

Product : Tablet PC
 Test Item : Band Edge
 Test Site : No.3 OATS
 Test Mode : Mode 1: Transmit - 1Mbps (GFSK)

Fundamental Filed Strength

Antenna Pole	Frequency [MHz]	Correction Factor [dB/m]	Reading Level [dBuV]	Emission Level [dB(uV/m)]	Detector
Horizontal	2480	32.155	72.03	104.186	Peak
Horizontal	2480	32.155	44.71	76.866	Average
Vertical	2480	31.412	70.89	102.302	Peak
Vertical	2480	31.412	59.23	90.642	Average

Note: 1:Spectrum Analyzer setting:

Peak detector: RBW=1MHz, VBW=1MHz

Average detector: RBW=1MHz, VBW=10Hz

Band Edge Test Data

Antenna Pole	Test Frequency (MHz)	Fundamental (dBuV/m)	Δ (dB)	Band Edge Field Strength (dBuV/m)	Limit (dBuV/m)	Detector
Horizontal	2483.5	104.186	48.61	55.576	74.000	Peak
Horizontal	2483.5	76.866	52.55	24.316	54.000	Average
Vertical	2483.5	102.302	48.61	53.692	74.000	Peak
Vertical	2483.5	90.642	52.55	38.092	54.000	Average

Note:

The Band Edge Field Strength was calculated using the Fundamental and Conducted Band Edge measurements per the Marker-Delta Method with the following formula:

Band Edge field Strength = $F - \Delta$

F = Fundamental field Strength (Peak or Average)

Δ = Conducted Band Edge Delta (Peak or Average)

Peak Detector of conducted Band Edge Delta

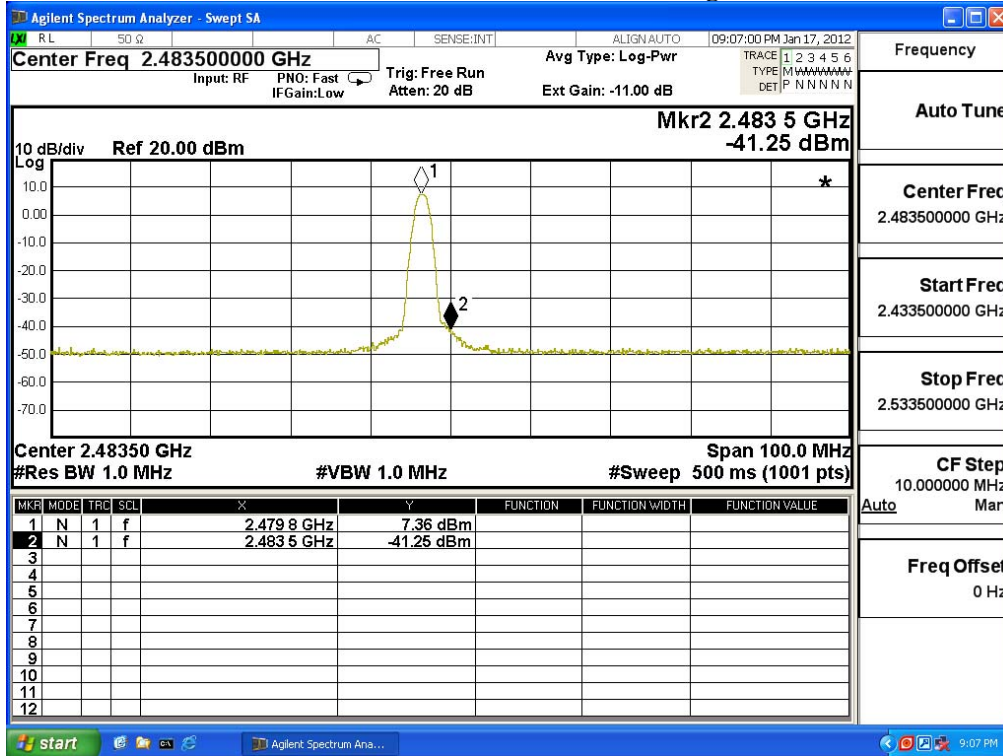

Average Detector of conducted Band Edge Delta

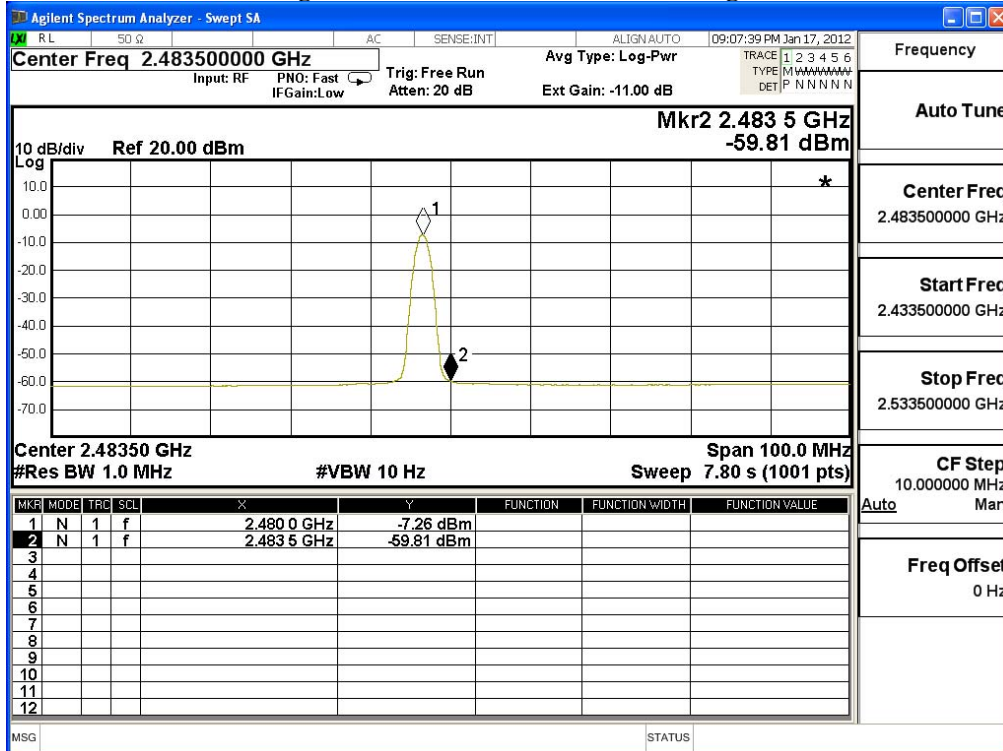

Product : Tablet PC
 Test Item : Band Edge
 Test Site : No.3 OATS
 Test Mode : Mode 2: Transmit - 3Mbps (8DPSK)

Fundamental Filed Strength

Antenna Pole	Frequency [MHz]	Correction Factor [dB/m]	Reading Level [dBuV]	Emission Level [dBuV/m]	Detector
Horizontal	2402	31.573	68.51	100.084	Peak
Horizontal	2402	31.573	54.94	86.514	Average
Vertical	2402	30.917	67.82	98.737	Peak
Vertical	2402	30.917	53.91	84.827	Average

Note: 1:Spectrum Analyzer setting:

Peak detector: RBW=1MHz, VBW=1MHz

Average detector: RBW=1MHz, VBW=10Hz

Band Edge Test Data

Antenna Pole	Test Frequency (MHz)	Fundamental (dBuV/m)	Δ (dB)	Band Edge Field Strength (dBuV/m)	Limit (dBuV/m)	Detector
Horizontal	2380.9	100.084	53.02	47.064	74.000	Peak
Horizontal	2389.9	86.514	50.09	36.424	54.000	Average
Vertical	2380.9	98.737	53.02	45.717	74.000	Peak
Vertical	2389.9	84.827	50.09	34.737	54.000	Average

Note:

The Band Edge Field Strength was calculated using the Fundamental and Conducted Band Edge measurements per the Marker-Delta Method with the following formula:

Band Edge field Strength = F - Δ

F = Fundamental field Strength (Peak or Average)

Δ = Conducted Band Edge Delta (Peak or Average)

Peak Detector of conducted Band Edge Delta

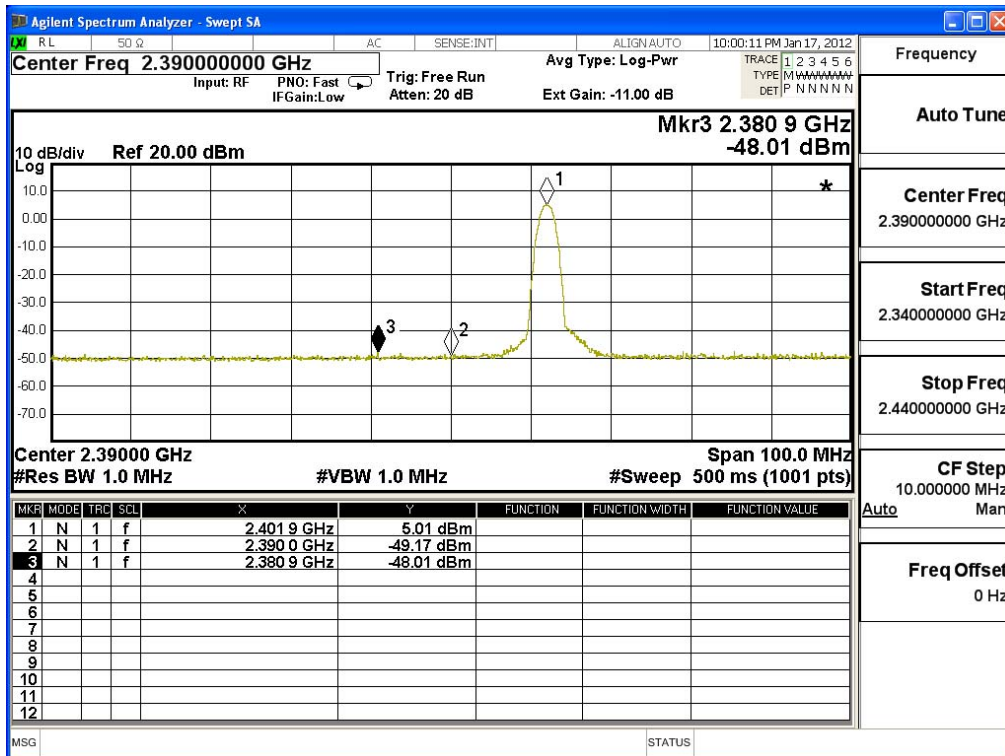

Average Detector of conducted Band Edge Delta

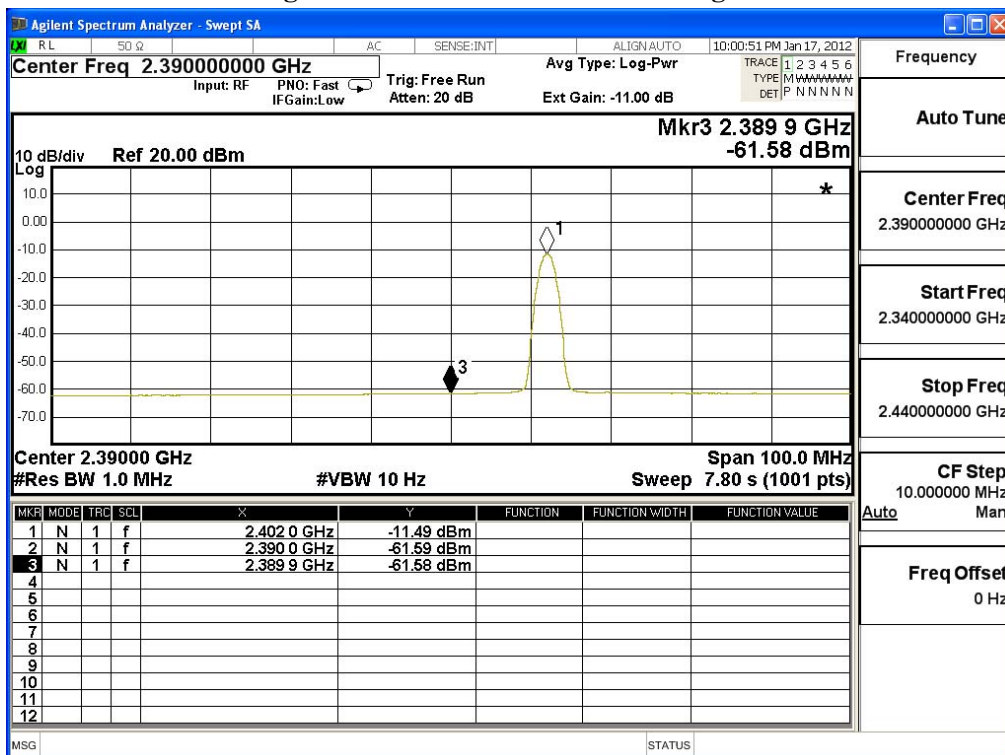

Product : Tablet PC
 Test Item : Band Edge
 Test Site : No.3 OATS
 Test Mode : Mode 2: Transmit - 3Mbps (8DPSK)

Fundamental Filed Strength

Antenna Pole	Frequency [MHz]	Correction Factor [dB/m]	Reading Level [dBuV]	Emission Level [dB(uV/m)]	Detector
Horizontal	2480	32.155	71.6	103.756	Peak
Horizontal	2480	32.155	57.19	89.346	Average
Vertical	2480	31.412	70.52	101.932	Peak
Vertical	2480	31.412	56.22	87.632	Average

Note: 1:Spectrum Analyzer setting:

Peak detector: RBW=1MHz, VBW=1MHz

Average detector: RBW=1MHz, VBW=10Hz

Band Edge Test Data

Antenna Pole	Test Frequency (MHz)	Fundamental (dBuV/m)	Δ (dB)	Band Edge Field Strength (dBuV/m)	Limit (dBuV/m)	Detector
Horizontal	2483.6	103.756	48.18	55.576	74.000	Peak
Horizontal	2483.5	89.346	50.01	39.336	54.000	Average
Vertical	2483.6	101.932	48.18	53.752	74.000	Peak
Vertical	2483.5	87.632	50.01	37.622	54.000	Average

Note:

The Band Edge Field Strength was calculated using the Fundamental and Conducted Band Edge measurements per the Marker-Delta Method with the following formula:

Band Edge field Strength = F - Δ

F = Fundamental field Strength (Peak or Average)

Δ = Conducted Band Edge Delta (Peak or Average)

Peak Detector of conducted Band Edge Delta

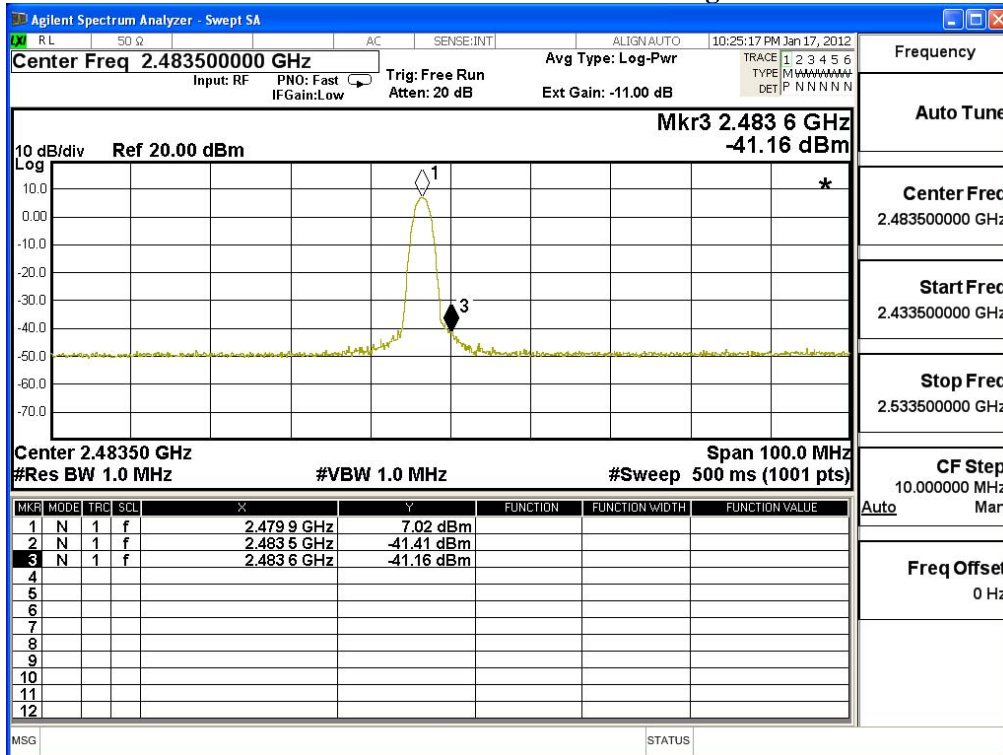

Average Detector of conducted Band Edge Delta

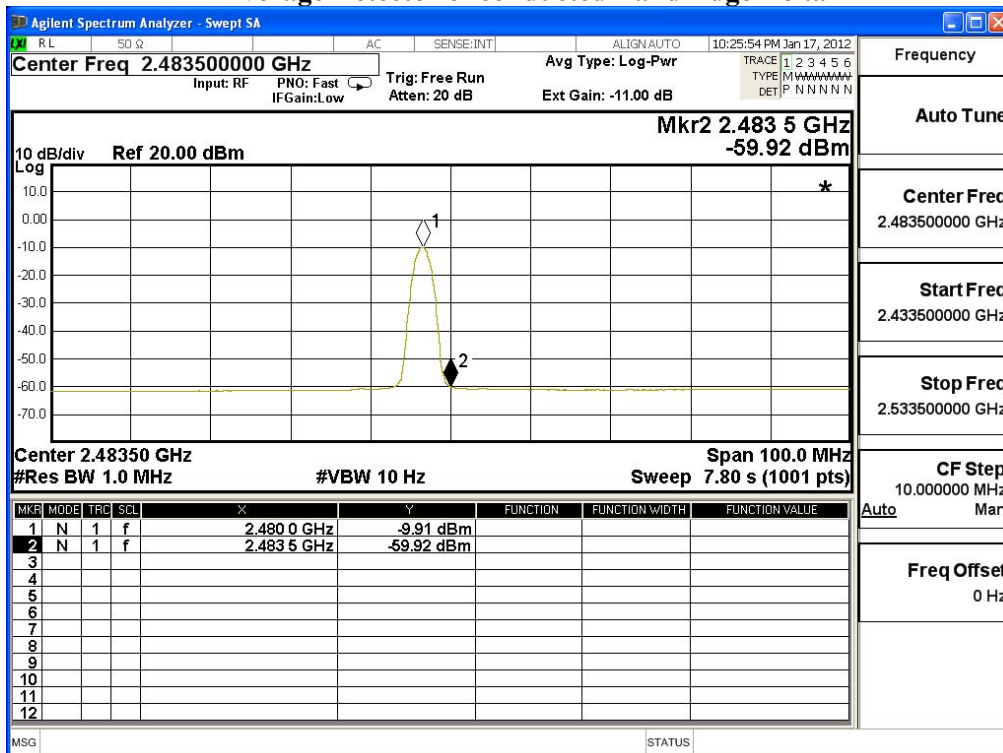

7. Channel Number

7.1. Test Equipment

	Equipment	Manufacturer	Model No./Serial No.	Last Cal.
	Spectrum Analyzer	R&S	FSP40 / 100170	Jun, 2011
	Spectrum Analyzer	Agilent	E4407B / US39440758	Jun, 2011
X	Spectrum Analyzer	Agilent	N9010A / MY48030495	Apr., 2011

Note: 1. All equipments are calibrated every one year.
 2. The test instruments marked by “X” are used to measure the final test results.

7.2. Test Setup

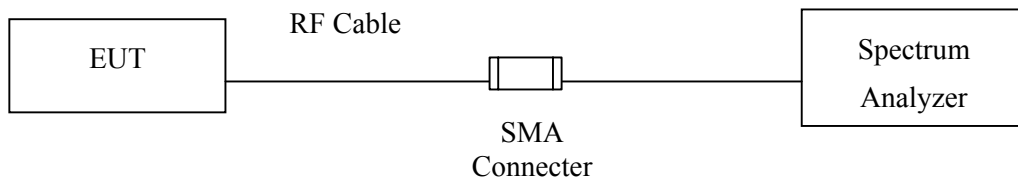

7.3. Limit

Frequency hopping systems operating in the 2400-2483.5 MHz bands shall use at least 75 hopping frequencies.

7.4. Test Procedure

The EUT was setup to ANSI C63.4, 2003; tested to FHSS test procedure of FCC Public Notice DA 00-705 for compliance to FCC 47CFR 15.247 requirements.

7.5. Uncertainty

N/A

7.6. Test Result of Channel Number

Product : Tablet PC
 Test Item : Channel Number
 Test Site : No.3 OATS
 Test Mode : Mode 1: Transmit - 1Mbps (GFSK)

Frequency Range (MHz)	Measurement (Hopping Channel)	Required Limit (Hopping Channel)	Result
2402 ~ 2480	79	>75	Pass

2402-2421MHz

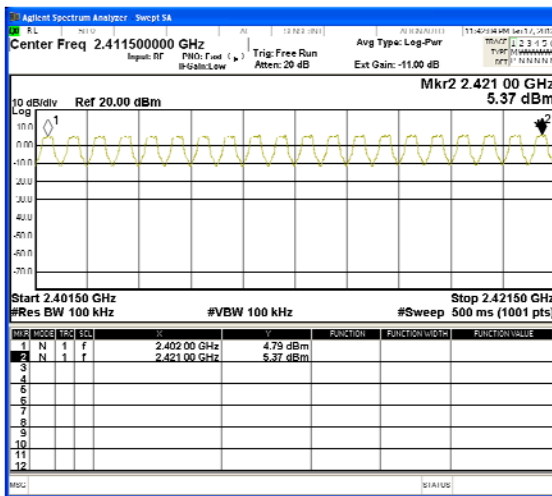

2422-2441MHz

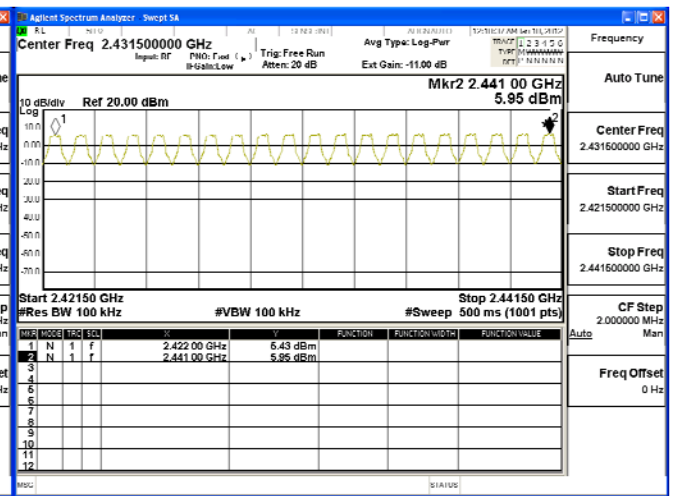

2442-2461MHz

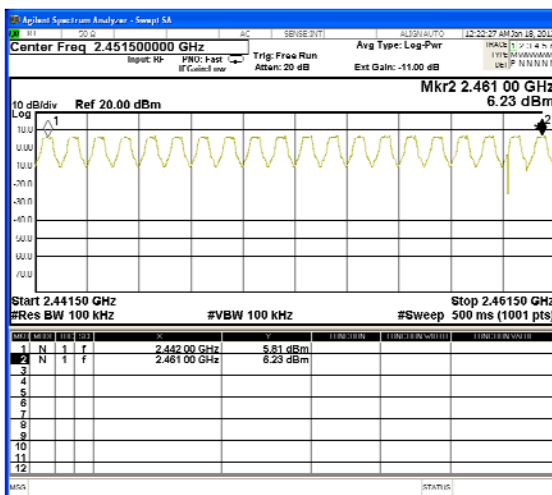

2462-2480MHz

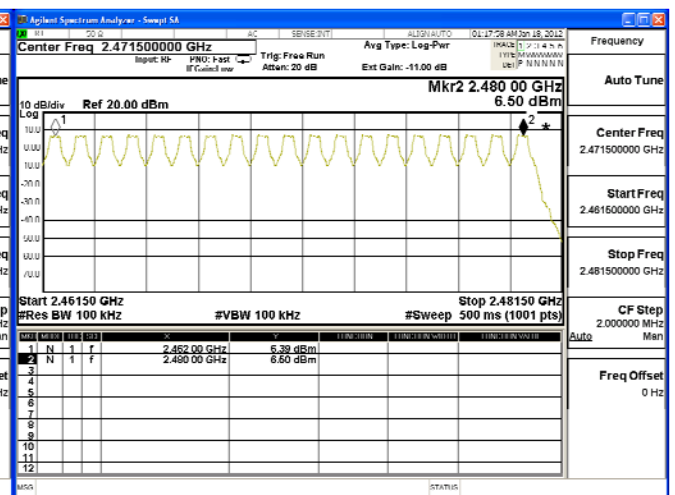

Product : Tablet PC
 Test Item : Channel Number
 Test Site : No.3 OATS
 Test Mode : Mode 2: Transmit - 3Mbps (8DPSK)

Frequency Range (MHz)	Measurement (Hopping Channel)	Required Limit (Hopping Channel)	Result
2402 ~ 2480	79	>75	Pass

2402-2421MHz

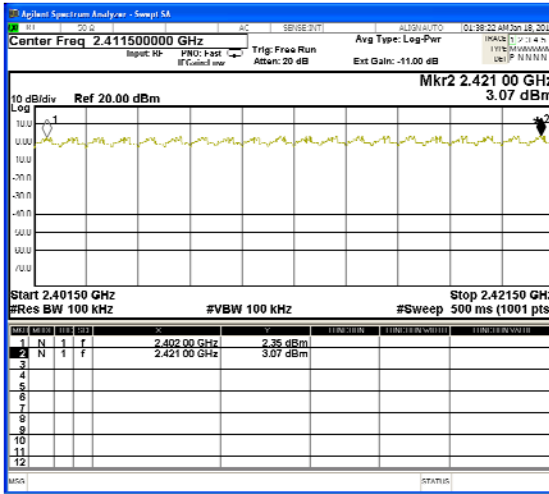

2422-2441MHz

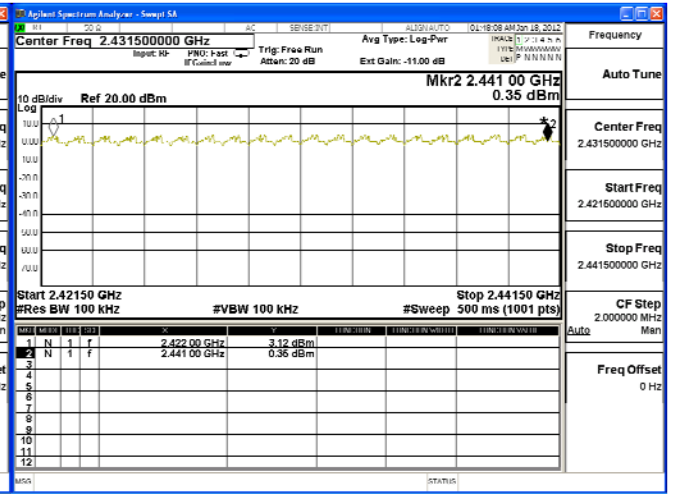

2442-2461MHz

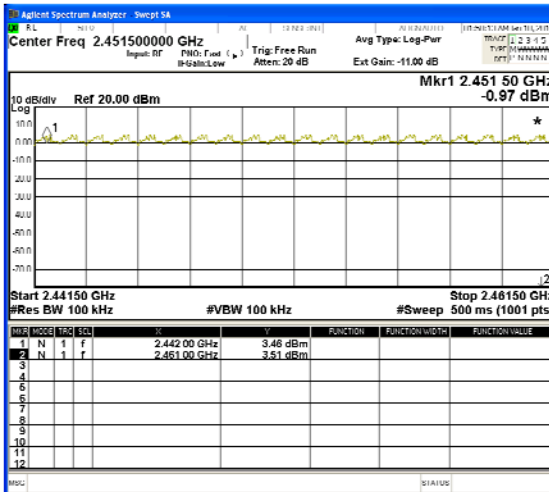

2462-2480MHz

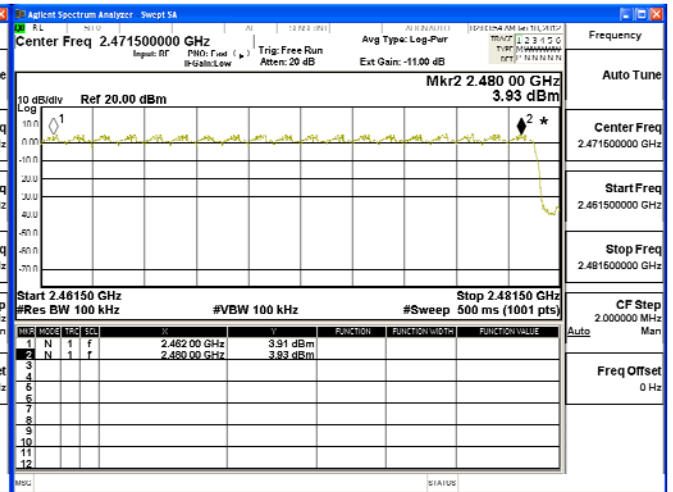

8. Channel Separation

8.1. Test Equipment

	Equipment	Manufacturer	Model No./Serial No.	Last Cal.
	Spectrum Analyzer	R&S	FSP40 / 100170	Jun, 2011
	Spectrum Analyzer	Agilent	E4407B / US39440758	Jun, 2011
X	Spectrum Analyzer	Agilent	N9010A / MY48030495	Apr., 2011

Note: 1. All equipments are calibrated every one year.
 2. The test instruments mark by “X” are used to measure the final test results.

8.2. Test Setup

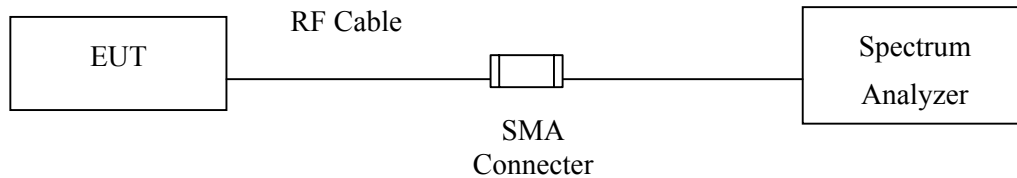

8.3. Limit

Frequency hopping systems shall have hopping channel carrier frequencies separated by a minimum of 25 kHz or the 20 dB bandwidth of the hopping channel, whichever is greater.

8.4. Test Procedure

The EUT was setup to ANSI C63.4, 2003; tested to FHSS test procedure of FCC Public Notice DA 00-705 for compliance to FCC 47CFR 15.247 requirements.

8.5. Uncertainty

± 150Hz

8.6. Test Result of Channel Separation

Product : Tablet PC
 Test Item : Channel Separation
 Test Site : No.3 OATS
 Test Mode : Mode 1: Transmit - 1Mbps (GFSK)

Channel No.	Frequency (MHz)	Measurement Level (kHz)	Limit (kHz)	Limit of (2/3)*20dB Bandwidth (kHz)	Result
00	2402	1000	>25 kHz	746.7	Pass
39	2441	1000	>25 kHz	746.7	Pass
78	2480	1000	>25 kHz	746.7	Pass

NOTE: The 20dB Bandwidth is refer to section 10.

Channel 00 2402MHz

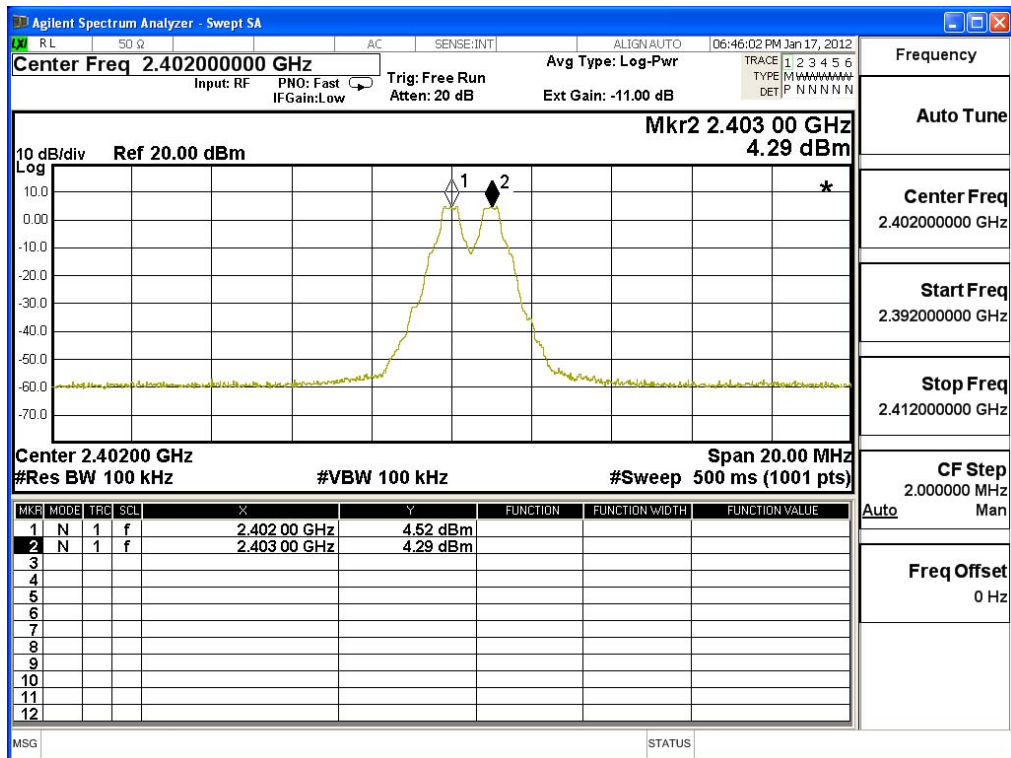

Channel 39 2441MHz

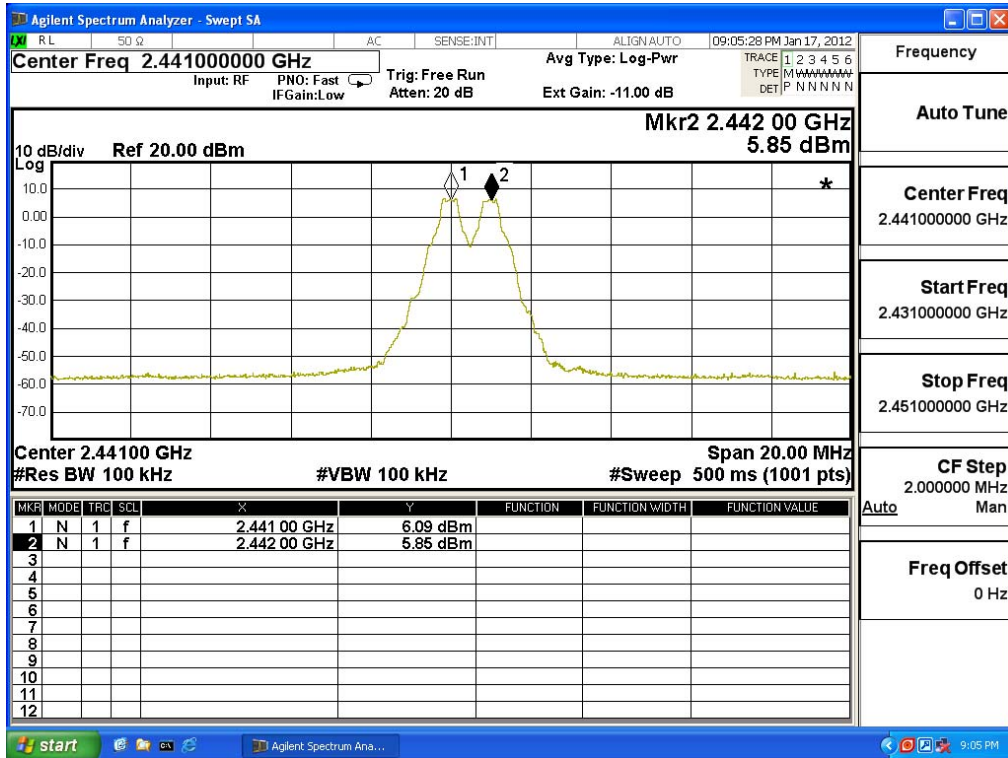

Channel 78 2480 MHz

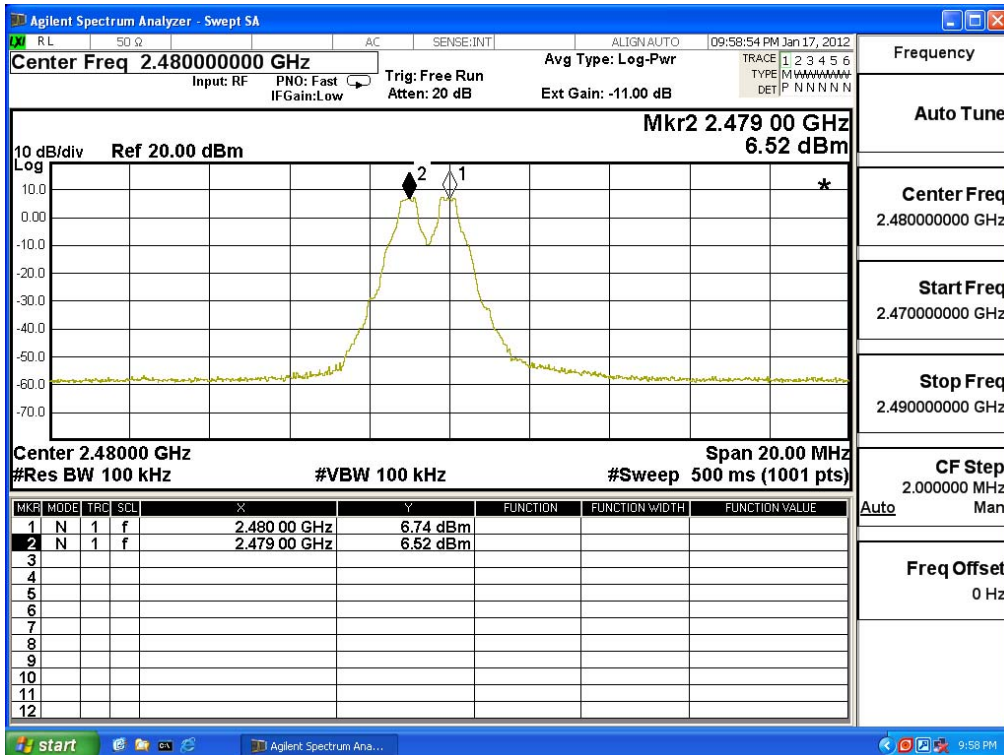

Product : Tablet PC
 Test Item : Channel Separation
 Test Site : No.3 OATS
 Test Mode : Mode 2: Transmit - 3Mbps (8DPSK)

Channel No.	Frequency (MHz)	Measurement Level (kHz)	Limit (kHz)	Limit of (2/3)*20dB Bandwidth (kHz)	Result
00	2402	1000	>25 kHz	940.0	Pass
39	2441	1000	>25 kHz	946.7	Pass
78	2480	1000	>25 kHz	940.0	Pass

NOTE: The 20dB Bandwidth is refer to section 10.

Channel 00 2402MHz

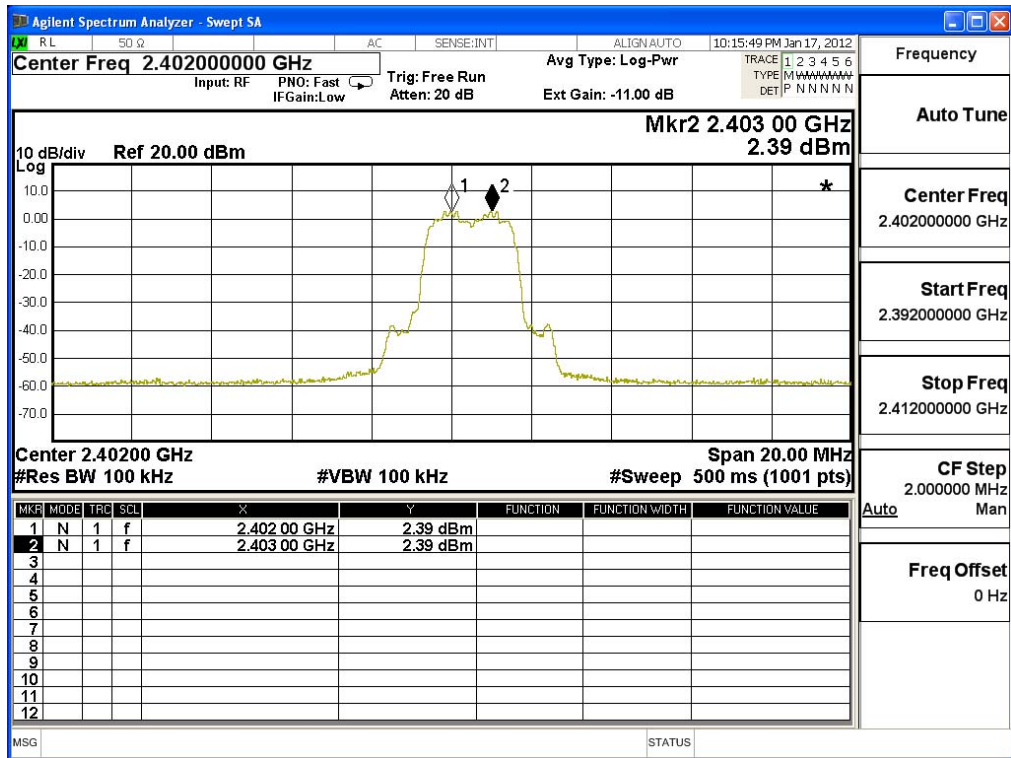

Channel 39 2441MHz

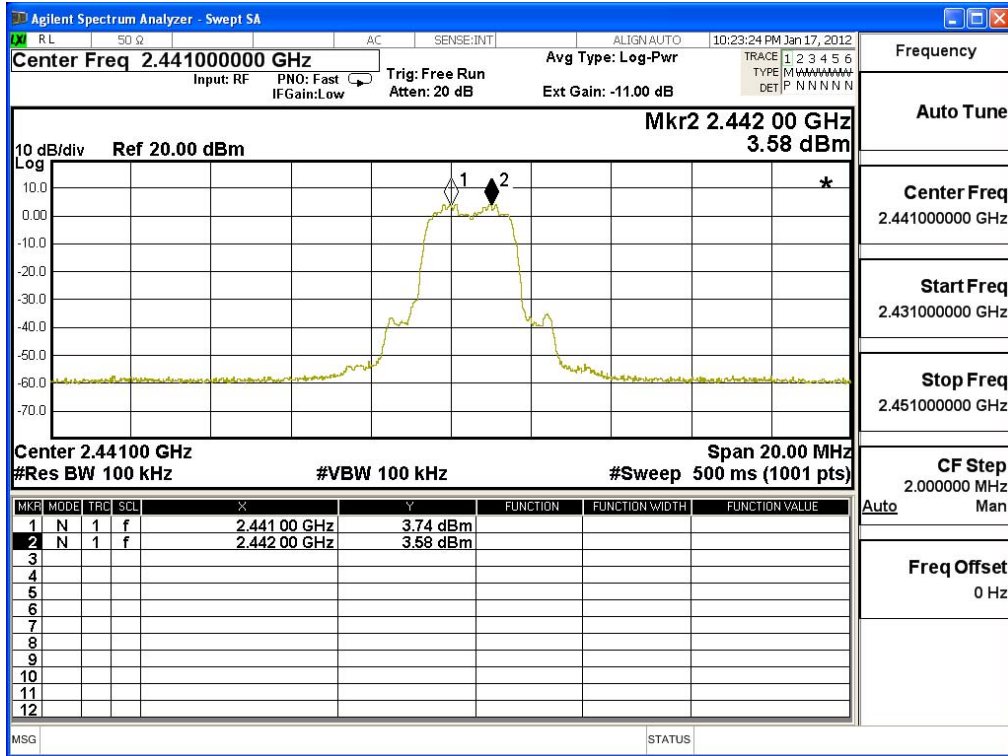

Channel 78 2480 MHz

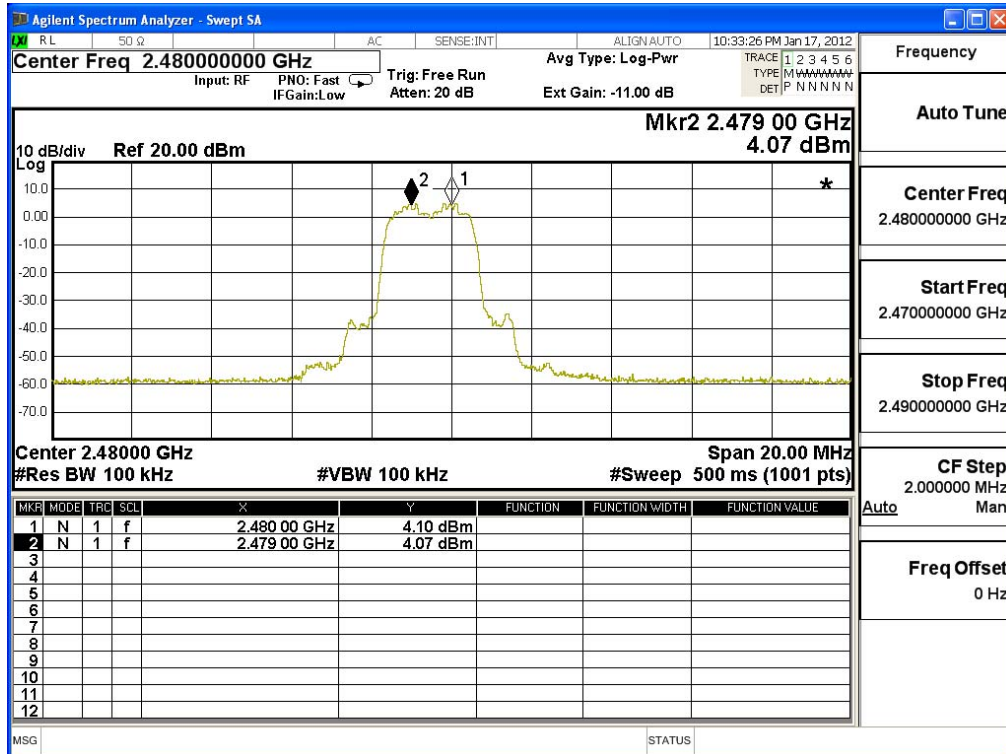

9. Dwell Time

9.1. Test Equipment

	Equipment	Manufacturer	Model No./Serial No.	Last Cal.
	Spectrum Analyzer	R&S	FSP40 / 100170	Jun, 2011
	Spectrum Analyzer	Agilent	E4407B / US39440758	Jun, 2011
X	Spectrum Analyzer	Agilent	N9010A / MY48030495	Apr., 2011

Note: 1. All equipments are calibrated every one year.
 2. The test instruments marked by “X” are used to measure the final test results.

9.2. Test Setup

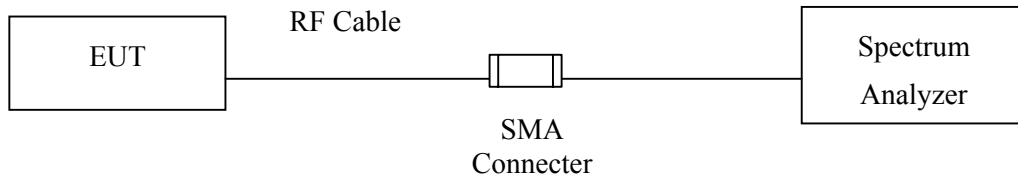

9.3. Limit

The dwell time shall be the average time of occupancy on any frequency shall not be greater than 0.4 seconds within a 30 second period.

9.4. Test Procedure

The EUT was setup to ANSI C63.4, 2003; tested to FHSS test procedure of FCC Public Notice DA 00-705 for compliance to FCC 47CFR 15.247 requirements.

9.5. Uncertainty

± 25msec

9.6. Test Result of Dwell Time

Product : Tablet PC
 Test Item : Dwell Time
 Test Site : No.3 OATS
 Test Mode : Mode 1: Transmit - 1Mbps (GFSK) (Channel 00,39,78 –DH5)

Frequency (MHz)	Time slot length (ms)	Hopping of Number	Sweep time (ms)	Duty cycle	Dwell Time (Sec)	Limit (Sec)	Result
2402	2.890	13	50	0.75	0.301	0.4	Pass
2441	2.880	13	50	0.75	0.300	0.4	Pass
2480	2.890	13	50	0.75	0.301	0.4	Pass

Duty cycle = ((Time slot length(ms)*Hopping of Number) / Sweep time (ms))

Dwell time = (Duty cycle / 79) * (79*0.4)

CH 00 Time Interval between hops

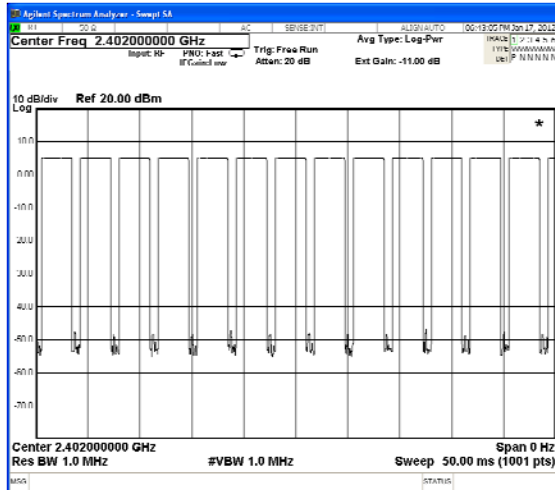

CH 00 Transmission Time

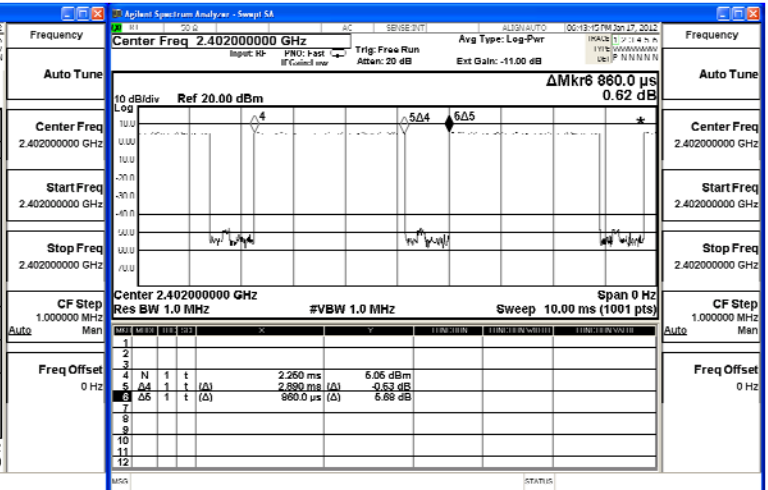

CH39 Time Interval between hops

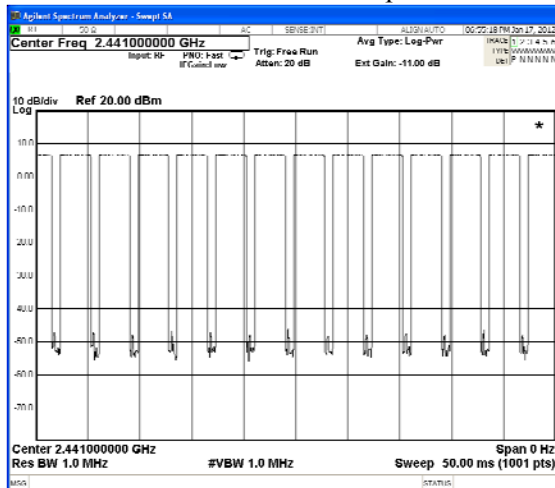

CH 39Transmission Time

