



Spectrum Research & Testing Lab., Inc.
No. 101-10, Ling 8,
Shan-Tong Li, Chung-Li
City, Taoyuan, Taiwan

TEST REPORT

Reference No.:C05030802
Report No.:FCCA05030802
FCC ID:I4L-MS6970A
Page:1 of 49
Date: Mar. 21, 2005

Product Name: BToes
Model Number: MS-6970A
Applicant: MICRO-STAR INT'L CO., LTD.
No. 69, Li-De St, Jung-He City, Taipei Hsien, Taiwan
Date of Receipt: Mar. 08, 2005
Finished date of Test: Mar. 18, 2005
Applicable Standards: 47 CFR Part 15, Subpart C
ANSI C63.4:2003

We, **Spectrum Research & Testing Laboratory Inc.**, hereby certify that one sample of the above was tested in our laboratory with positive results according to the above-mentioned standards. The records in the report are an accurate account of the results. Details of the results are given in the subsequent pages of this report.

Checked By : Hugo Yeh , Date: 3/21/2005
(Hugo Yeh)

Approved By : JH , Date: 3/21/2005
(Johnson Ho, Director)



Lab Code: 200099-0



TABLE OF CONTENTS

1. DOCUMENT POLICY AND TEST STATEMENT	4
1.1 DOCUMENT POLICY	4
1.2 TEST STATEMENT	4
1.3 EUT MODIFICATION.....	4
2. DESCRIPTION OF EUT AND TEST MODE	5
2.1 GENERAL DESCRIPTION OF EUT	5
2.2 DESCRIPTION OF SUPPORT UNIT.....	6
2.3 DESCRIPTION OF TEST MODE	6
3. DESCRIPTION OF APPLIED STANDARDS.....	6
4 TECHNICAL CHARACTERISTICS TEST	7
4.1 CHANNEL SEPARATION TEST	7
4.1.1 LIMIT	7
4.1.2 TEST EQUIPMENT	7
4.1.3 TEST SET-UP	7
4.1.4 TEST PROCEDURE.....	7
4.1.5 EUT OPERATING CONDITION.....	8
4.1.6 TEST RESULT.....	8
4.2 20DB BANDWIDTH.....	12
4.2.1 LIMIT	12
4.2.2 TEST EQUIPMENT	12
4.2.3 TEST SET-UP	12
4.2.4 TEST PROCEDURE.....	12
4.2.5 EUT OPERATING CONDITION.....	12
4.2.6 TEST RESULT.....	13
4.3 QUANTITY OF HOPPING CHANNEL TEST	17
4.3.1 LIMIT	17
4.3.2 TEST EQUIPMENT	17
4.3.3 TEST SET-UP	17
4.3.4 TEST PROCEDURE.....	17
4.3.5 EUT OPERATING CONDITION.....	17
4.3.6 TEST RESULT.....	18
4.4 TIME OF OCCUPANCY (DWELL TIME)	19
4.4.1 LIMIT	19
4.4.2 TEST EQUIPMENT	19
4.4.3 TEST SET-UP	19
4.4.4 TEST PROCEDURE.....	19
4.4.5 EUT OPERATING CONDITION.....	19
4.4.6 TEST RESULT.....	20
4.5 PEAK POWER TEST	24
4.5.1 LIMIT	24



4.5.2	TEST EQUIPMENT	24
4.5.3	TEST SET-UP	25
4.5.4	TEST PROCEDURE.....	25
4.5.5	EUT OPERATING CONDITION.....	25
4.5.6	TEST RESULT.....	25
4.6	BAND EDGE TEST	28
4.6.1	LIMIT	28
4.6.2	TEST EQUIPMENT	29
4.6.3	TEST SET-UP	30
4.6.4	TEST PROCEDURE.....	31
4.6.5	EUT OPERATING CONDITION.....	31
4.6.6	TEST RESULT.....	31
4.7	SPURIOUS RADIATED EMISSION TEST.....	34
4.7.1	LIMIT	34
4.7.2	TEST EQUIPMENT	35
4.7.3	TEST SET-UP	36
4.7.4	TEST PROCEDURE.....	37
4.7.5	EUT OPERATING CONDITION.....	37
4.7.6	TEST RESULT.....	38
4.8	CONDUCTED EMISSION TEST	42
4.8.1	CONDUCTED EMISSION LIMIT	42
4.8.2	TEST EQUIPMENT	42
4.8.3	TEST SETUP.....	43
4.8.4	TEST PROCEDURE.....	43
4.8.5	TEST RESULT.....	44
5.	ANTENNA APPLICATION.....	45
5.1	ANTENNA REQUIREMENT.....	45
5.2	RESULT	45
6.	PHOTOS OF TESTING	46
7.	TERMS OF ABRIVATION.....	49



**Spectrum Research &
Testing Lab., Inc.**
No. 101-10, Ling 8,
Shan-Tong Li, Chung-Li
City, Taoyuan, Taiwan

TEST REPORT

Reference No.:C05030802
Report No.:FCCA05030802
FCC ID:I4L-MS6970A
Page:4 of 49
Date: Mar. 21, 2005

1. DOCUMENT POLICY AND TEST STATEMENT

1.1 DOCUMENT POLICY

- The report shall not be reproduced except in full, without the written approval of SRT Lab, Inc.

1.2 TEST STATEMENT

- The test results in the report apply only to the unit tested by SRT Lab.
- There was no deviation from the requirements of test standards during the test.
- AC power source, 120 VAC/60 Hz, was used during the test.

1.3 EUT MODIFICATION

- No modification in SRT Lab.



2. DESCRIPTION OF EUT AND TEST MODE

2.1 GENERAL DESCRIPTION OF EUT

PRODUCT	BToes
MODEL NO.	MS-6970A
POWER SUPPLY	DC 5V, 8~100mA
CABLE	N/A
FREQUENCY BAND	2.402~2.480GHz
CARRIER FREQUENCY	2.402~2.480GHz
NUMBER OF CHANNEL	79
CHANNEL SPACING	1MHz
RATED RF OUTPUT POWER	0~+4dBm(1~2.5mW)
I.F. & L.O.	L.O.:16MHz
MODULATION TYPE	1Mbps (GFSK) 2Mbps($\pi/4$ DQPSK), 3Mbps (8 DPSK) modulation modes.
DUTY CYCLE	Max 1600 hops/sec
BIT RATE OF TRANSMISSION	1Mbps/2Mbps/3Mbps
OPERATION TEMPERATURE RANGE	0~65°C
MODE OF OPERATION	Duplex
ANTENNA TYPE	Printed Antenna
ANTENNA GAIN	0dBi

NOTE :

For more detailed information, please refer to the EUT's specification or user's manual provided by manufacturer.



2.2 DESCRIPTION OF SUPPORT UNIT

The transmitter part of EUT was tested with a PC system and configured by the requirement of ANSI C63.4. All interface ports were connected to the appropriate support units via specific cables. The support units and cables are listed below.

NO	DEVICE	BRAND	MODEL #	FCC ID/DOC	CABLE
1	NOTEBOOK	DELL	PP01L	DOC	1.5m unshielded power cord
2	PRINTER	EPSON	STYLUS C20SX	DOC	1.5m unshielded power cord 1.2m shielded data cable
3	MODEM	ACEEX	DM-1414	DOC	1.5m unshielded DC power cable 1.2m shielded data cable
4	BLUETOOTH HEADPHONE	AIR2U	BHS02A	DOC	N/A

NOTE : For the actual test configuration, please refer to the photos of testing.

2.3 DESCRIPTION OF TEST MODE

This EUT is a FHSS system, we use BlueTest to control the EUT with RS232, Let EUT hopping on and transmit at every channel with highest power, Only output power use conducted method, others are using radiated method. After Sirfdemo330R1 send the command to EUT, it can be removed, and the EUT keep hopping.79 channels are provided by EUT. The 3 channels of lower, medium and higher were chosen for test.

Channel	Frequency(MHz)
0	2402
39	2441
78	2480

NOTE :

1. Below 1 GHz, the channel 0, 39 and 78 were pre-tested in chamber. The channel 78, worst case one, was chosen for conducted and radiated emission test.
2. Above 1 GHz, the channel 0, 39 and 78 were tested individually.

3. DESCRIPTION OF APPLIED STANDARDS

The EUT is a kind of wireless product and to be connected with a PC system for normal use. According to the specifications provided by the applicant, it must comply with the requirements of the following standards:

47 CFR Part 15, Subpart C

ANSI C63.4: 2003

Public DA00-705 (March 2000)

All tests have been performed and recorded as the above standards.



4 TECHNICAL CHARACTERISTICS TEST

4.1 CHANNEL SEPARATION TEST

4.1.1 LIMIT

FCC Part15, Subpart C Section 15.247(a)(1). Frequency hopping systems shall have hopping channel carrier frequencies separated by a minimum of 25 kHz or the 20 dB bandwidth of the hopping channel, whichever is greater.

FREQUENCY RANGE (MHz)	Limit(kHz)
902-928	>25kHz
2400-2483.5	>25kHz
5725-5850	>25kHz

4.1.2 TEST EQUIPMENT

The following test equipment was used during the radiated emission test :

EQUIPMENT/ FACILITIES	SPECIFICATIONS	MANUFACTURER	MODEL#/ SERIAL#	DUE DATE OF CAL. & CAL. CENTER
SPECTRUM	9kHz-7GHz	ROHDE & SCHWARZ	FSP7/ 839511/010	MAR. 2005 ETC

NOTE: The calibration interval of the above test equipment is one year and the calibrations are traceable to NML/ROC and NIST/USA.

4.1.3 TEST SET-UP

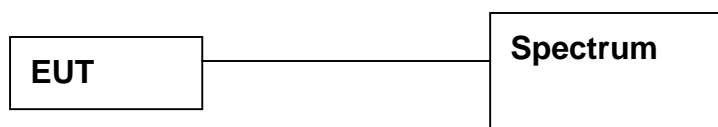

The EUT was connected to a spectrum through a 50 RF cable.

4.1.4 TEST PROCEDURE

The EUT was operating in hopping mode or could be controlled its channel. Printed out the test result from the spectrum by hard copy function.



4.1.5 EUT OPERATING CONDITION

1. Set the EUT under transmission condition continuously at a specific channel frequency.
2. Under Windows 2000 ran "EMI TEST" and "Media Player" programs.
3. PC sent "H" pattern or accessed the following peripherals directly or via EUT:
 - RS232
 - Printer
 - FDD
 - HDD

4.1.6 TEST RESULT

Temperature: 26°C Humidity: 55%RH
Spectrum Detector: PK Tested by: Julian Chiang
Test Result: PASS

CHANNEL NUMBER	CHANNEL FREQUENCY (MHz)	SEPARATION READ VALUE (kHz)	MINIMUM LIMIT (kHz)
0	2402	1004.000	756
39	2441	1004.000	780
78	2480	1020.000	792



Spectrum Research & Testing Lab., Inc.
No. 101-10, Ling 8,
Shan-Tong Li, Chung-Li
City, Taoyuan, Taiwan

TEST REPORT

Reference No.:C05030802
Report No.:FCCA05030802
FCC ID:I4L-MS6970A
Page:9 of 49
Date: Mar. 21, 2005

CH0:

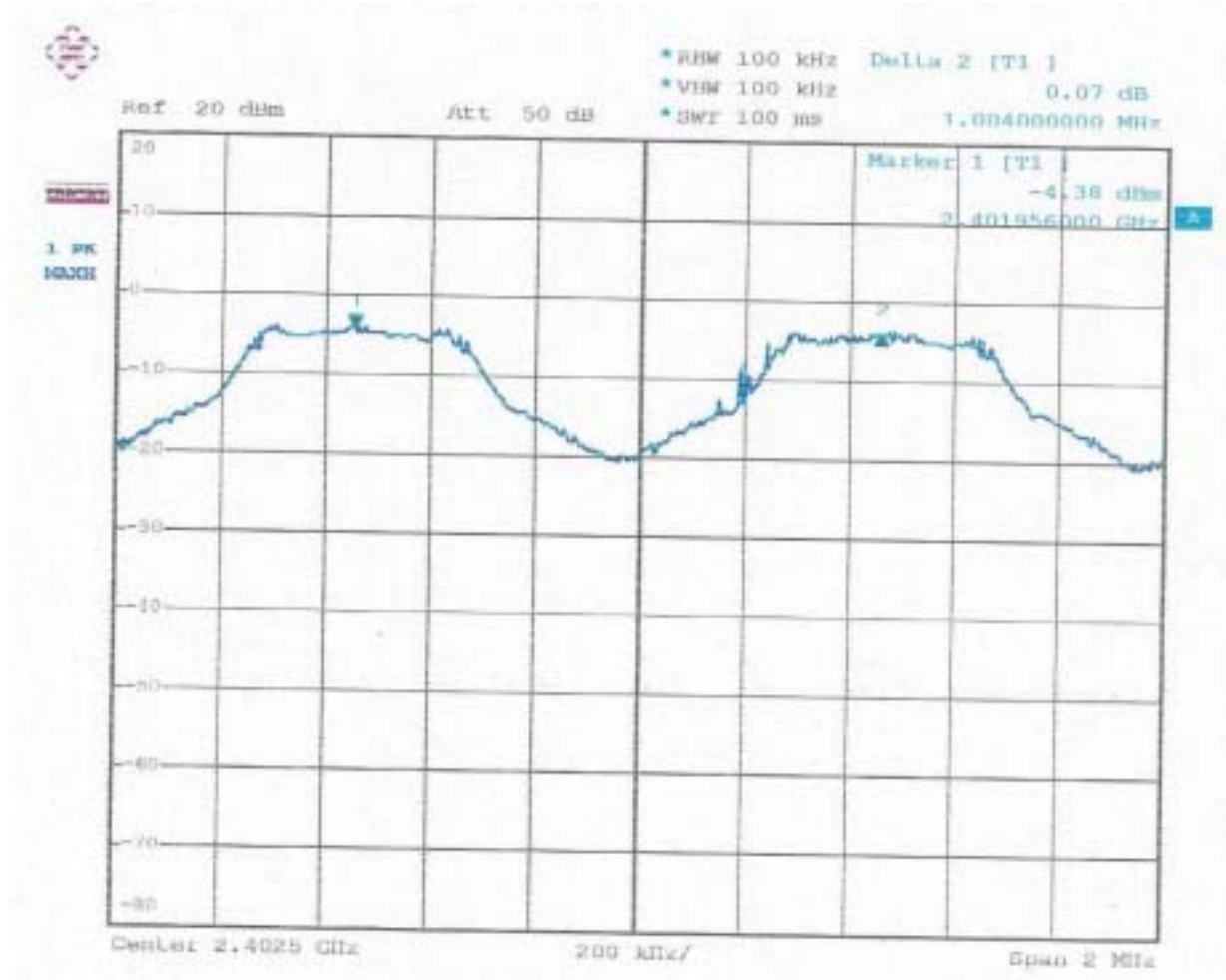



Spectrum Research & Testing Lab., Inc.
No. 101-10, Ling 8,
Shan-Tong Li, Chung-Li
City, Taoyuan, Taiwan

TEST REPORT

Reference No.:C05030802
Report No.:FCCA05030802
FCC ID:I4L-MS6970A
Page:10 of 49
Date: Mar. 21, 2005

CH39:

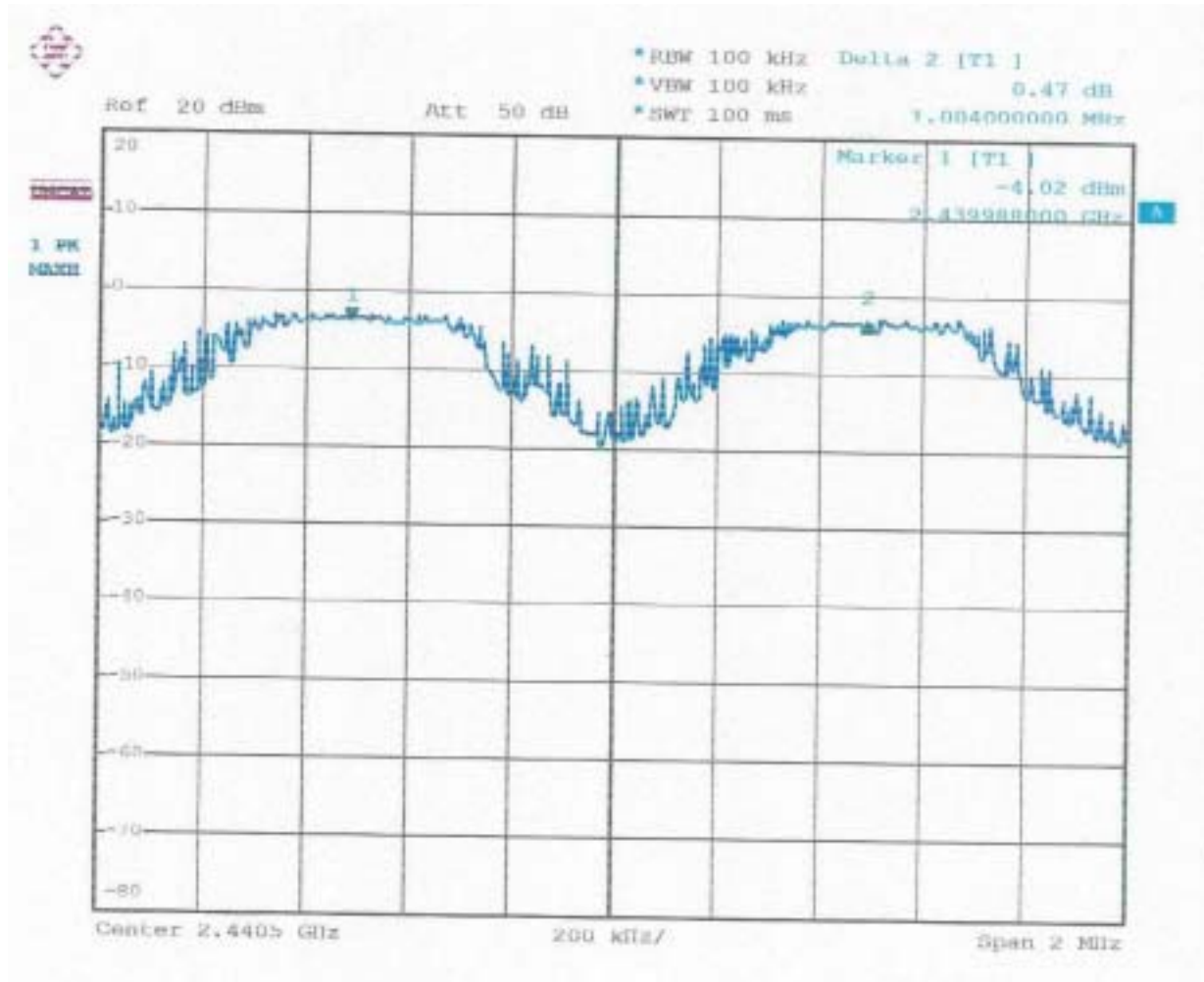



Spectrum Research & Testing Lab., Inc.
No. 101-10, Ling 8,
Shan-Tong Li, Chung-Li
City, Taoyuan, Taiwan

TEST REPORT

Reference No.:C05030802
Report No.:FCCA05030802
FCC ID:I4L-MS6970A
Page:11 of 49
Date: Mar. 21, 2005

CH78:

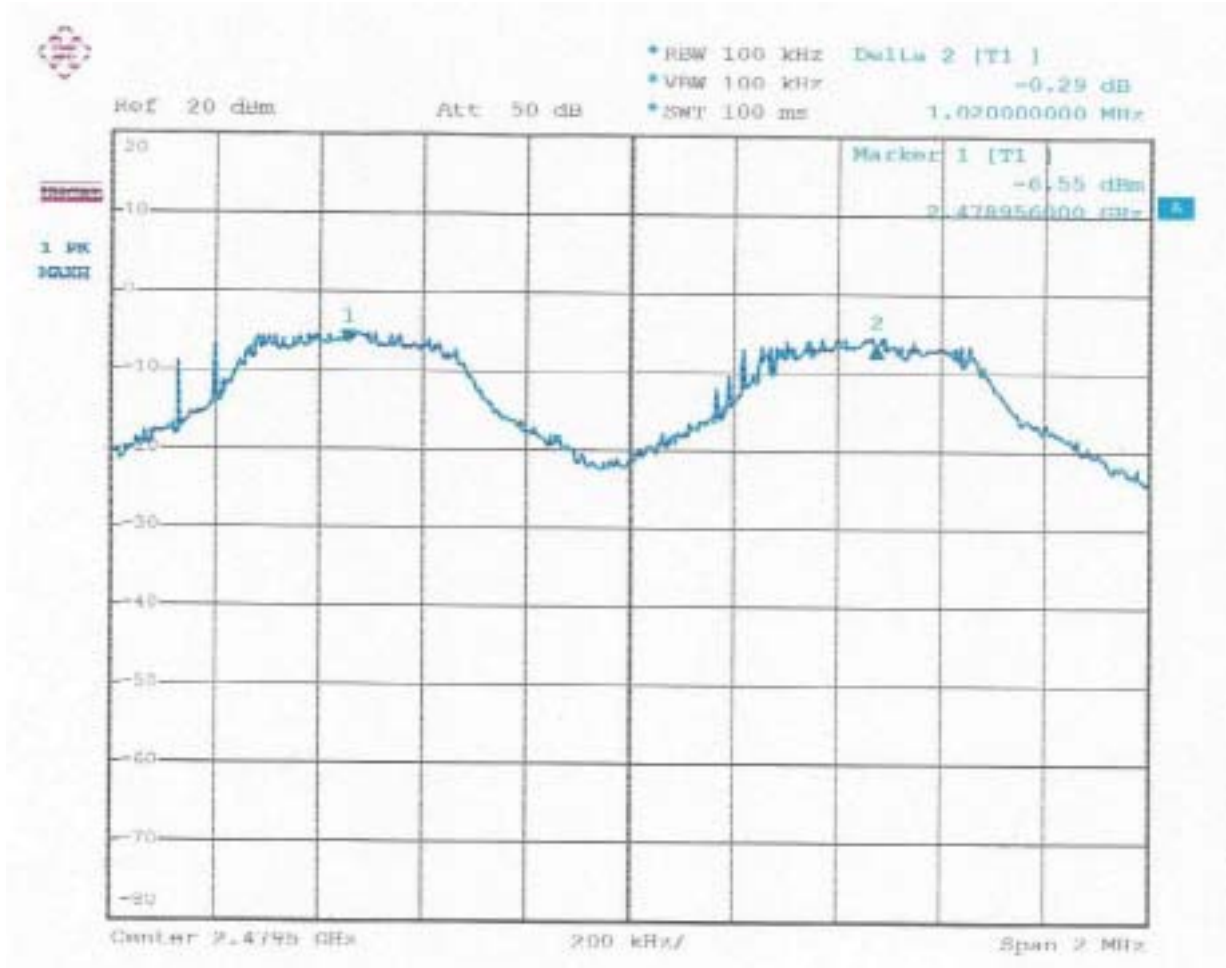



4.2 20dB Bandwidth

4.2.1 LIMIT

FREQUENCY Range (MHz)	Quantity of Hopping Channel	Limit(kHz)			
		50	25	15	75
902-928		<250	>250	NA	NA
2400-2483.5		NA	NA	>1000	<1000

4.2.2 TEST EQUIPMENT

The following test equipment was used during the test:

EQUIPMENT/ FACILITIES	SPECIFICATIONS	MANUFACTURER	MODEL#/ SERIAL#	DUE DATE OF CAL. & CAL. CENTER
SPECTRUM	9kHz-7GHz	ROHDE & SCHWARZ	FSP7/ 839511/010	MAR. 2005 ETC

NOTE: The calibration interval of the above test equipment is one year and the calibrations are traceable to NML/ROC and NIST/USA.

4.2.3 TEST SET-UP

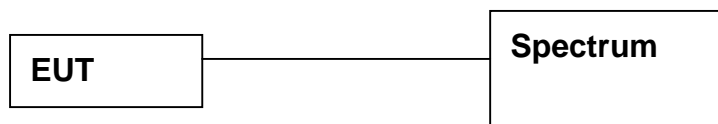

The EUT was connected to a spectrum through a 50 RF cable.

4.2.4 TEST PROCEDURE

The EUT was operating in hopping mode or could be controlled its channel. Printed out the test result from the spectrum by hard copy function.

4.2.5 EUT OPERATING CONDITION

Same as section 4.1.5 of this report.



Spectrum Research & Testing Lab., Inc.
No. 101-10, Ling 8,
Shan-Tong Li, Chung-Li
City, Taoyuan, Taiwan

TEST REPORT

Reference No.:C05030802
Report No.:FCCA05030802
FCC ID:I4L-MS6970A
Page:13 of 49
Date: Mar. 21, 2005

4.2.6 TEST RESULT

Temperature: 26°C Humidity: 55%RH
Spectrum Detector: PK Tested by: Julian Chiang
Test Result: PASS

CHANNEL NUMBER	CHANNEL FREQUENCY (MHz)	20dB DOWN BW (kHz)
0	2402	756
39	2441	780
78	2480	792



Spectrum Research & Testing Lab., Inc.
No. 101-10, Ling 8,
Shan-Tong Li, Chung-Li
City, Taoyuan, Taiwan

TEST REPORT

Reference No.:C05030802
Report No.:FCCA05030802
FCC ID:I4L-MS6970A
Page:14 of 49
Date: Mar. 21, 2005

CH0:

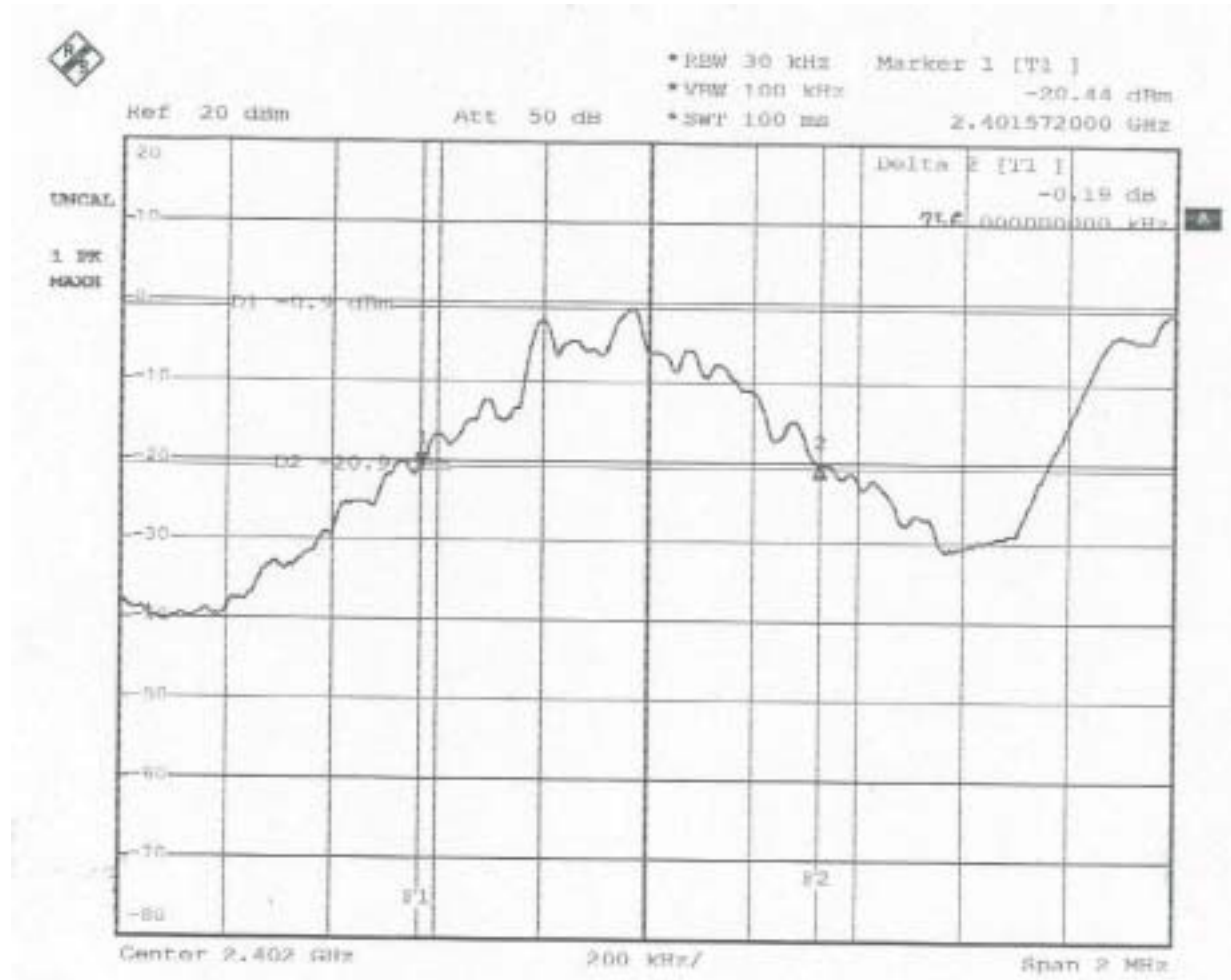



Ch39:

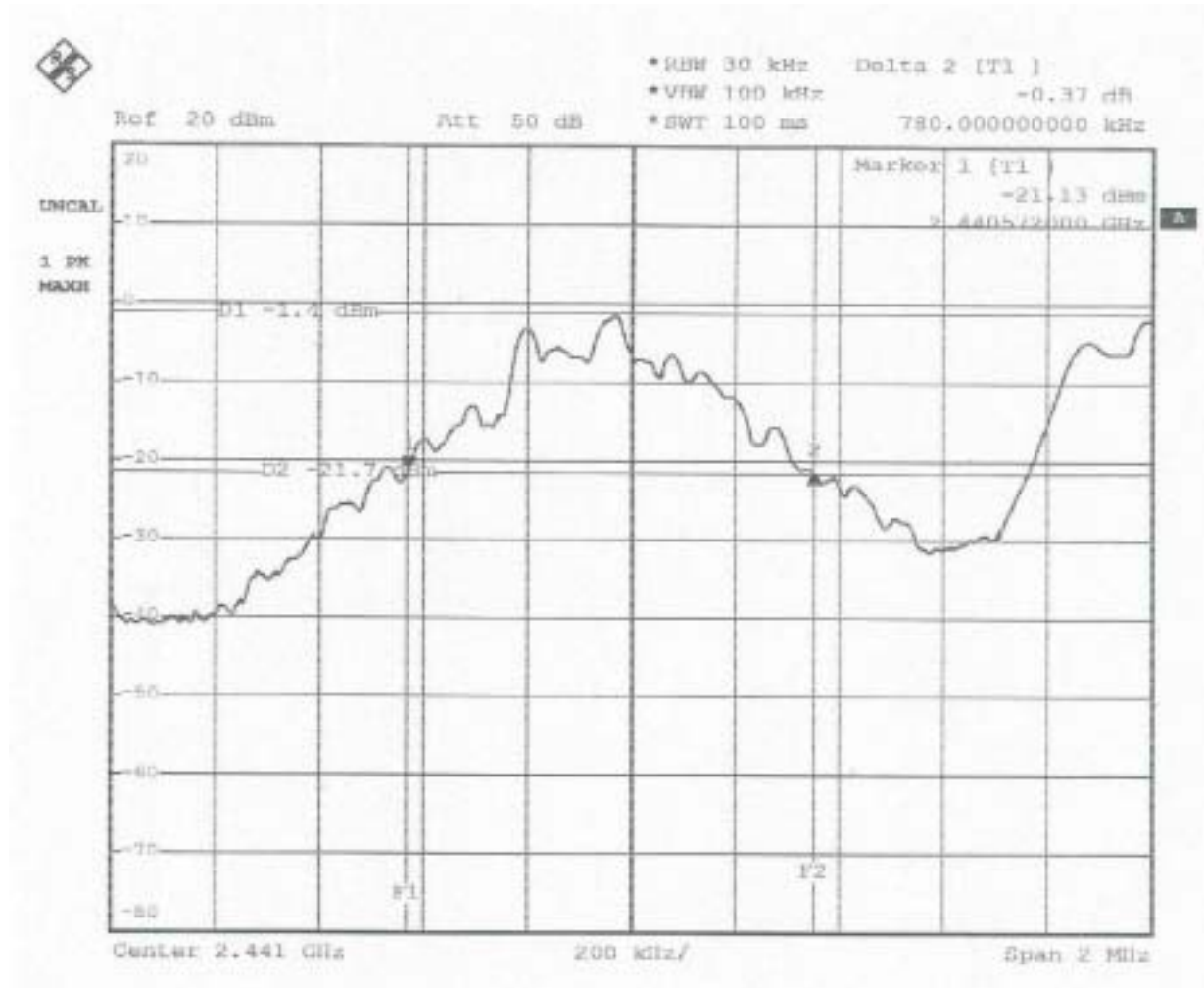



Spectrum Research & Testing Lab., Inc.
No. 101-10, Ling 8,
Shan-Tong Li, Chung-Li
City, Taoyuan, Taiwan

TEST REPORT

Reference No.:C05030802
Report No.:FCCA05030802
FCC ID:I4L-MS6970A
Page:16 of 49
Date: Mar. 21, 2005

CH78:

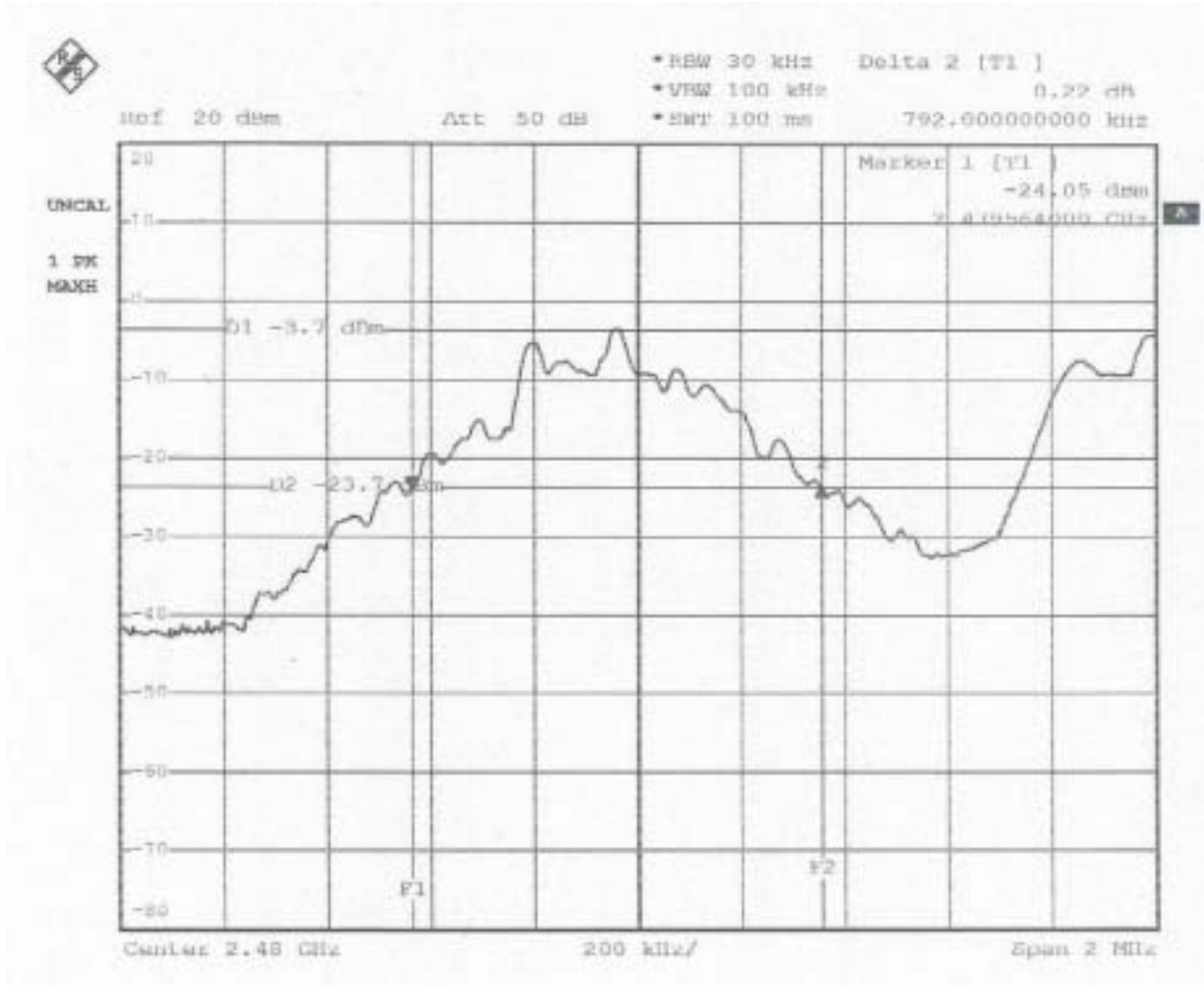



4.3 QUANTITY OF HOPPING CHANNEL TEST

4.3.1 LIMIT

FCC Part15, Subpart C Section 15.247.

FREQUENCY RANGE (MHz)	Limit (Quantity of Hopping Channel)			
	20dB bandwidth <250kHz	20dB bandwidth >250kHz	20dB bandwidth <1MHz	20dB bandwidth >1MHz
902-928	50	25	N/A	N/A
2400-2483.5	N/A	N/A	75	15
5725-5850	N/A	N/A	75	N/A

4.3.2 TEST EQUIPMENT

The following test equipment was used during the test:

EQUIPMENT/FACILITIES	SPECIFICATIONS	MANUFACTURER	MODEL#/SERIAL#	DUE DATE OF CAL. & CAL. CENTER
SPECTRUM	9kHz-7GHz	ROHDE & SCHWARZ	FSP7/ 839511/010	MAR. 2005 ETC

NOTE: The calibration interval of the above test equipment is one year and the calibrations are traceable to NML/ROC and NIST/USA.

4.3.3 TEST SET-UP

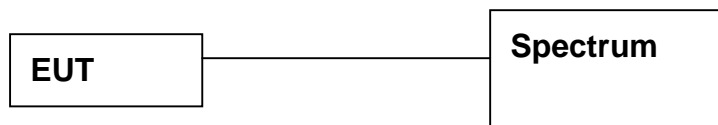

The EUT was connected to a spectrum through a 50 RF cable.

4.3.4 TEST PROCEDURE

The EUT was operating in hopping mode or could be controlled its channel. Printed out the test result from the spectrum by hard copy function.

4.3.5 EUT OPERATING CONDITION

Same as section 4.1.5 of this report.



Spectrum Research & Testing Lab., Inc.
 No. 101-10, Ling 8,
 Shan-Tong Li, Chung-Li
 City, Taoyuan, Taiwan

TEST REPORT

Reference No.:C05030802
 Report No.:FCCA05030802
 FCC ID:I4L-MS6970A
 Page:18 of 49
 Date: Mar. 21, 2005

4.3.6 TEST RESULT

Temperature: 26°C Humidity: 55%RH
 Spectrum Detector: PK Tested by: Julian Chiang
 Test Result: PASS

HOPPING CHANNEL FREQUENCY RANGE	QUANTITY OF HOPPING CHANNEL READ VALUE	QUANTITY OF HOPPING CHANNEL LIMIT
2402~2480	79	75

CH0-CH78

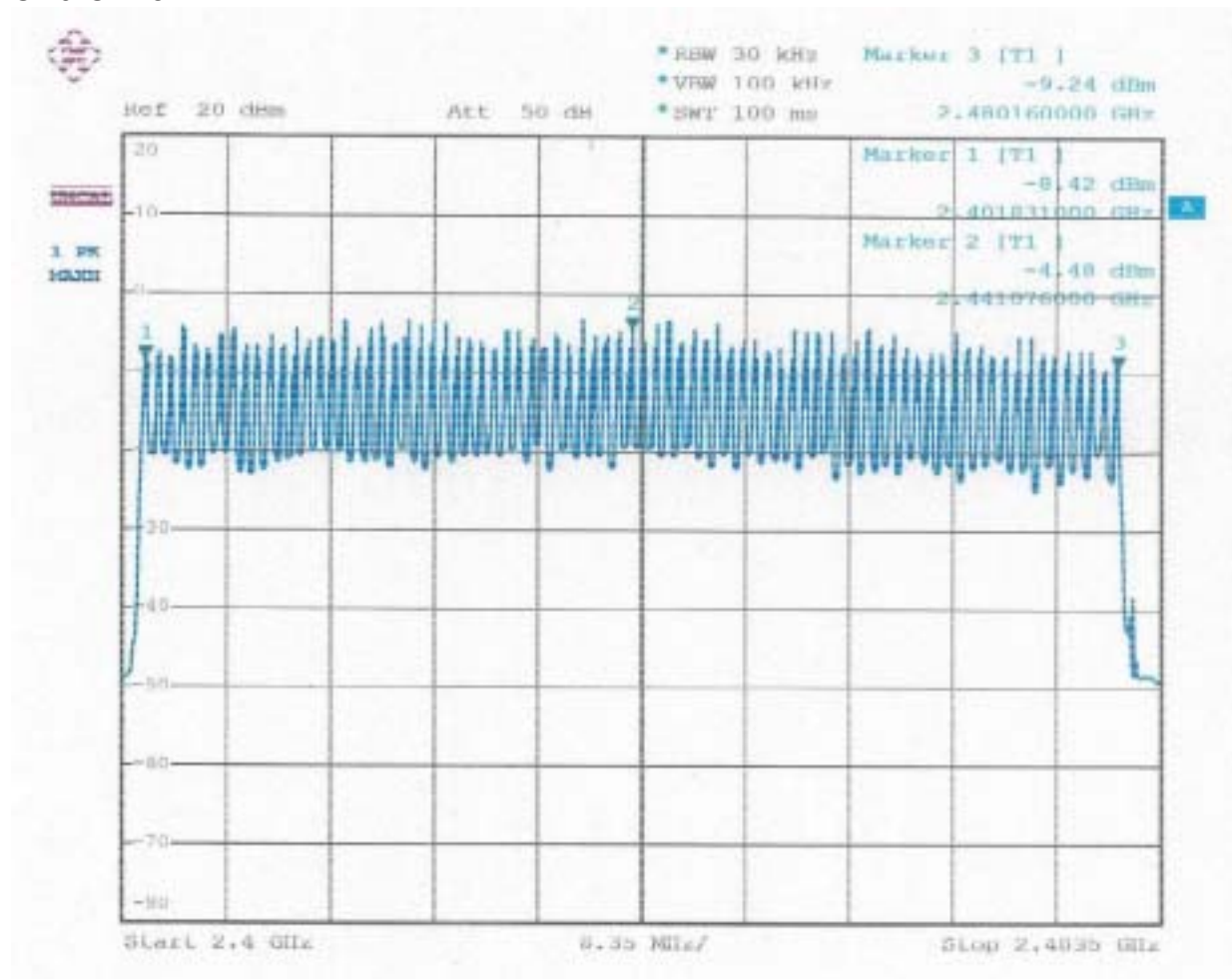



4.4 Time of occupancy (Dwell Time)

4.4.1 LIMIT

FCC Part15, Subpart C Section 15.247.

FREQUENCY RANGE (MHz)	LIMIT (ms)		
	20dB bandwidth <250kHz(50Channel)	20dB bandwidth >250kHz(25Channel)	20dB bandwidth <1MHz(75Channel)
902-928	400(20s)	400(10s)	NA
2400-2483.5	NA	NA	400(30s)
5725-5850	NA	NA	400(30s)

NOTE: The “()” is all channel’s average time of occupancy.

4.4.2 TEST EQUIPMENT

The following test equipment was used during the test:

EQUIPMENT/ FACILITIES	SPECIFICATIONS	MANUFACTURER	MODEL#/ SERIAL#	DUE DATE OF CAL. & CAL. CENTER
SPECTRUM	9kHz-7GHz	ROHDE & SCHWARZ	FSP7/ 839511/010	MAR. 2005 ETC

NOTE: The calibration interval of the above test equipment is one year and the calibrations are traceable to NML/ROC and NIST/USA.

4.4.3 TEST SET-UP

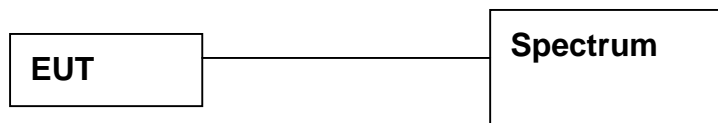

The EUT was connected to a spectrum through a 50 RF cable.

4.4.4 TEST PROCEDURE

The EUT was operating in hopping mode or could be controlled its channel. Printed out the test result from the spectrum by hard copy function.

4.4.5 EUT OPERATING CONDITION

Same as section 4.1.5 of this report.



Spectrum Research & Testing Lab., Inc.
No. 101-10, Ling 8,
Shan-Tong Li, Chung-Li
City, Taoyuan, Taiwan

TEST REPORT

Reference No.:C05030802
Report No.:FCCA05030802
FCC ID:I4L-MS6970A
Page:20 of 49
Date: Mar. 21, 2005

4.4.6 TEST RESULT

Temperature: 26°C

Humidity: 55%RH

Spectrum Detector: PK

Tested by: Julian Chiang

Test Result: PASS

CHANNEL NUMBER	CHANNEL FREQUENCY (MHz)	Pulse Time (μs)	Burts (in 1 sec.)	Time of occupancy (Dwell Time) (ms)	Average time of occupancy LIMIT (ms)
0	2402.00	452	10	135.6	400
39	2441.00	448	10	134.4	400
78	2480.00	446	10	133.8	400

Note:

Dwell Time:

Pulse Time*Burts*10*30



CH0:

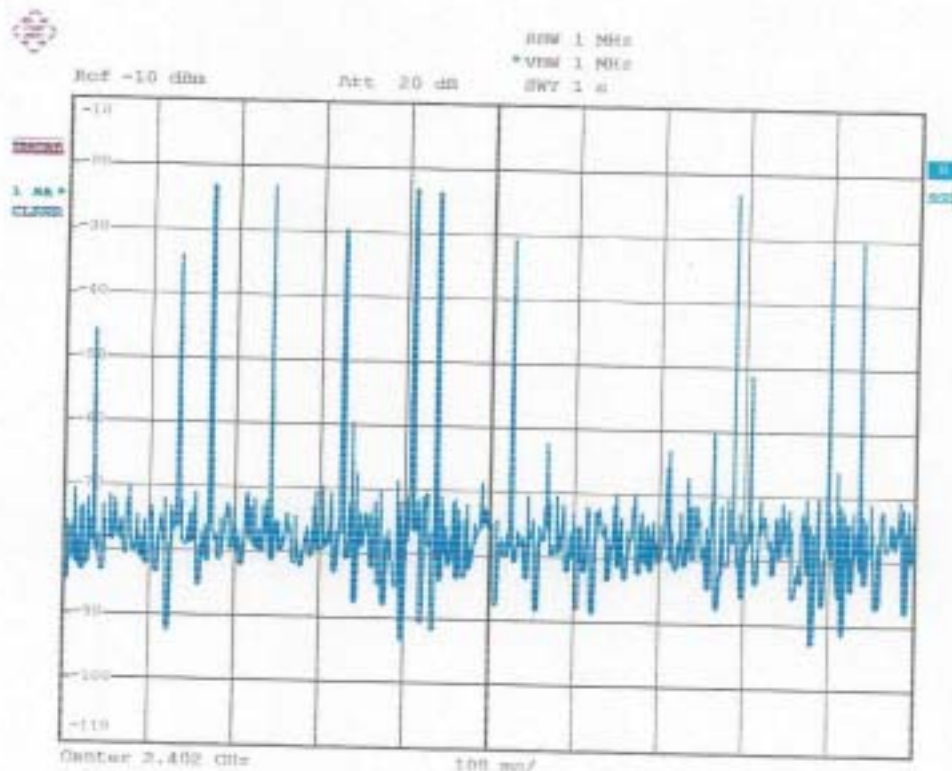
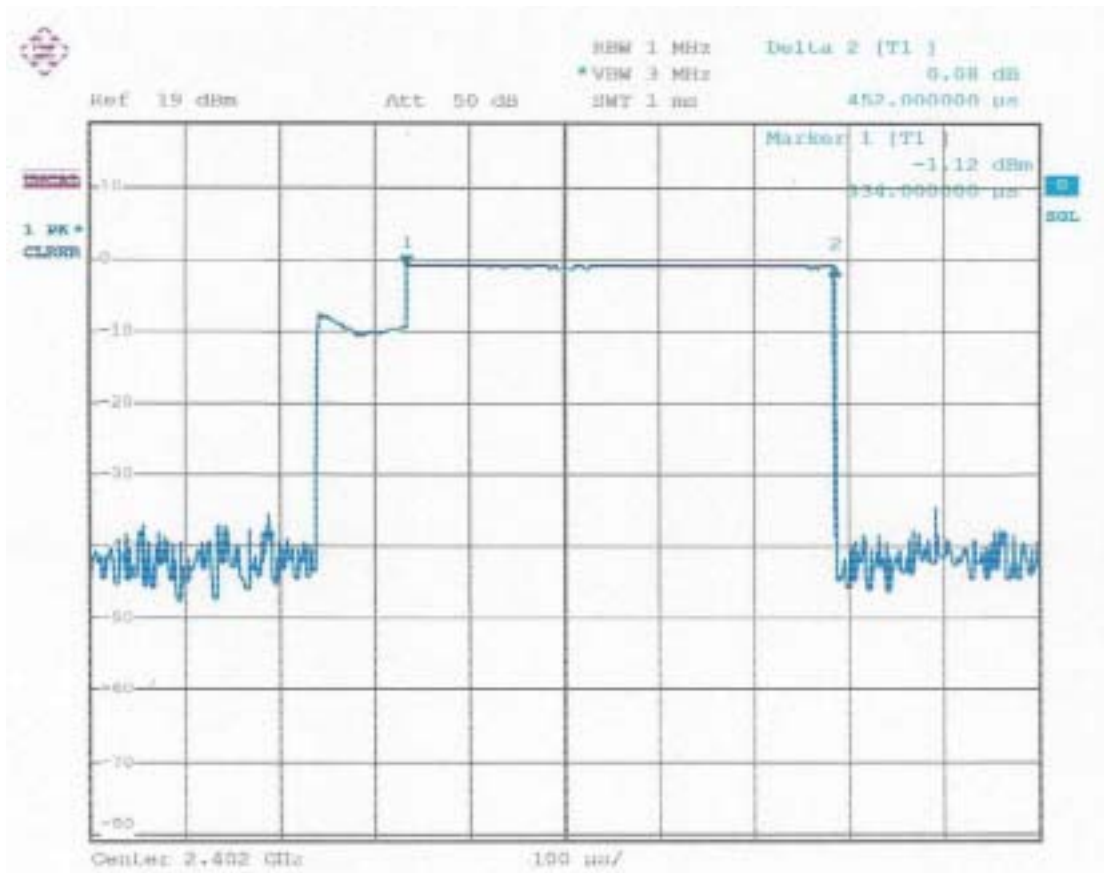



Ch39:

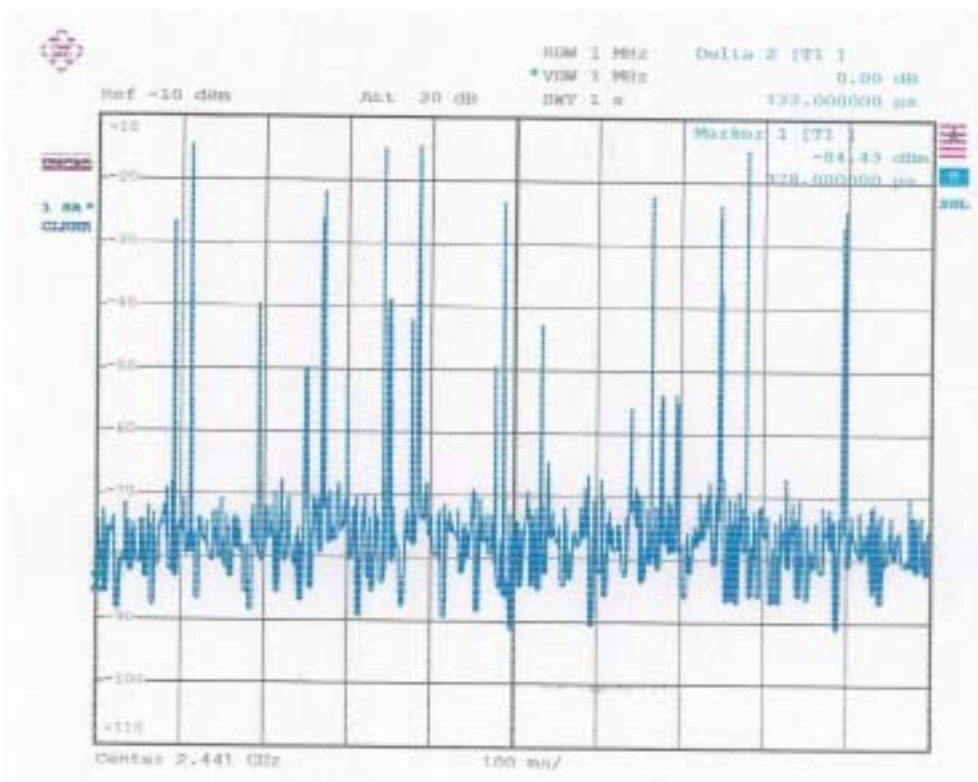
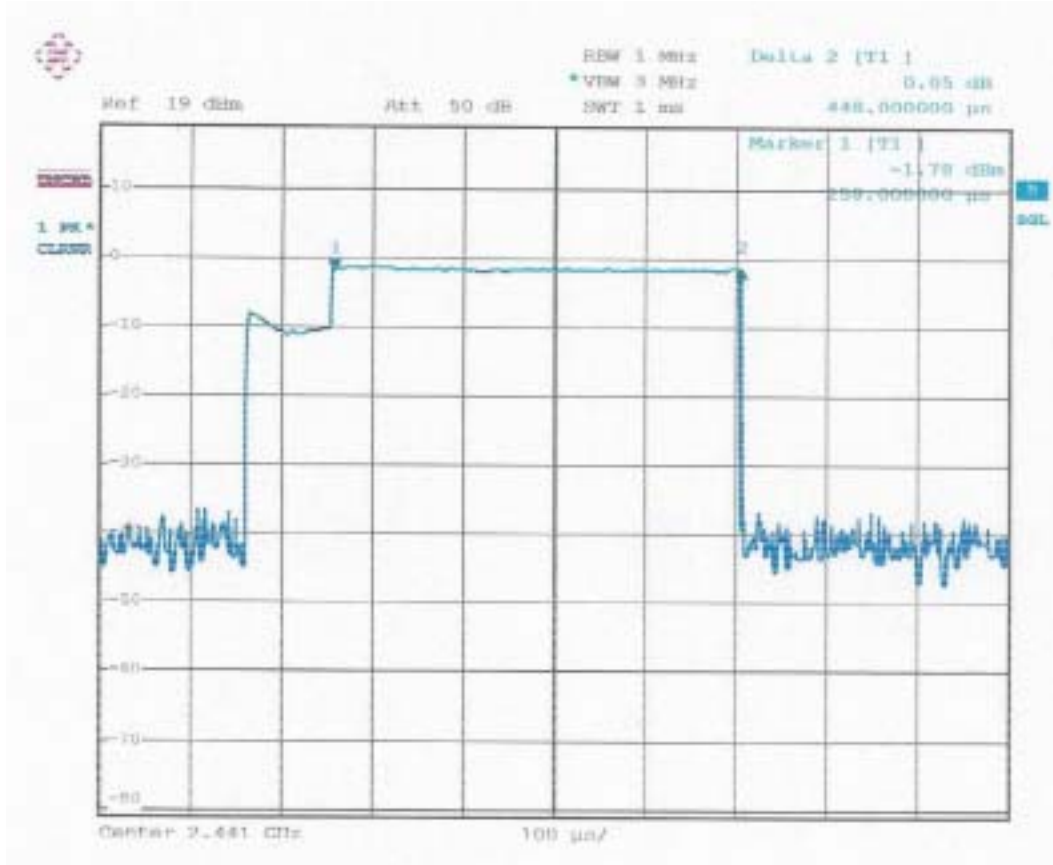



CH78:

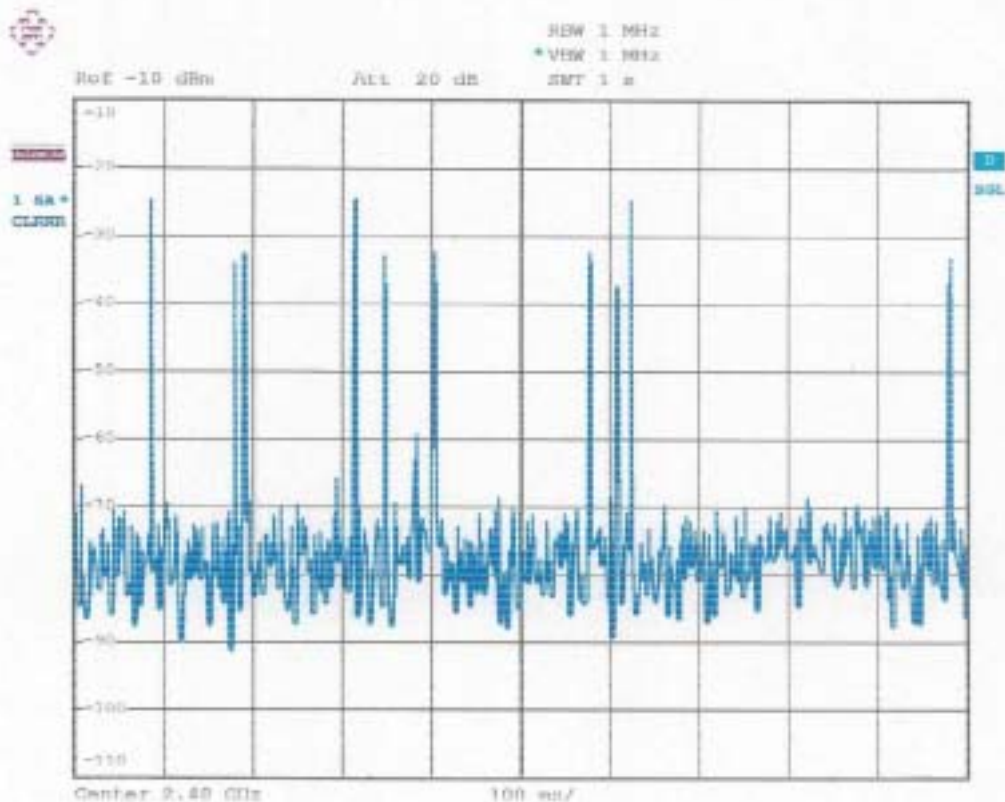
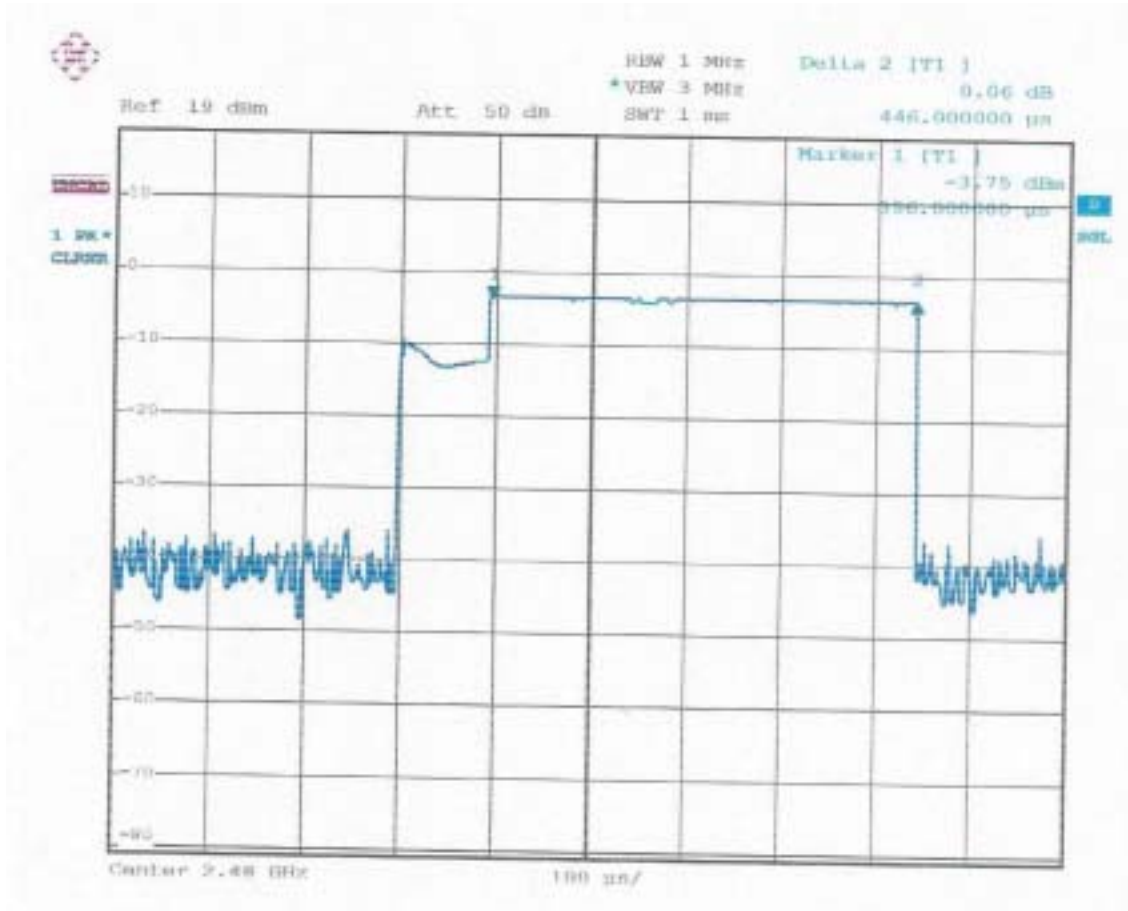



Spectrum Research & Testing Lab., Inc.
No. 101-10, Ling 8,
Shan-Tong Li, Chung-Li
City, Taoyuan, Taiwan

TEST REPORT

Reference No.:C05030802
Report No.:FCCA05030802
FCC ID:I4L-MS6970A
Page:24 of 49
Date: Mar. 21, 2005

4.5 PEAK POWER TEST

4.5.1 LIMIT

FCC Part15, Subpart C Section 15.247.

FREQUENCY RANGE (MHz)	LIMIT(W)				
	Quantity of Hopping Channel	50	25	15	75
902-928		1(30dBm)	0.125(21dBm)	NA	NA
2400-2483.5		NA	NA	0.125(21dBm)	1(30dBm)
5725-5850		NA	NA	NA	1(30dBm)

4.5.2 TEST EQUIPMENT

The following test equipment was used during the test :

EQUIPMENT/FACILITIES	SPECIFICATIONS	MANUFACTURER	MODEL#/SERIAL#	DUE DATE OF CAL. & CAL. CENTER
SPECTRUM	9kHz-7GHz	ROHDE & SCHWARZ	FSP7/ 839511/010	MAR. 2005 ETC
POWER METER	N/A	BOONTON	4232A/ 29001	MAY 2005 ETC
POWER SENSOR	DC-18GHz 0.3 μ W-100mW 50	BOONTON	51011-EMC/ 31184	JUN. 2005 ETC

NOTE: The calibration interval of the above test equipment is one year and the calibrations are traceable to NML/ROC and NIST/USA.



4.5.3 TEST SET-UP

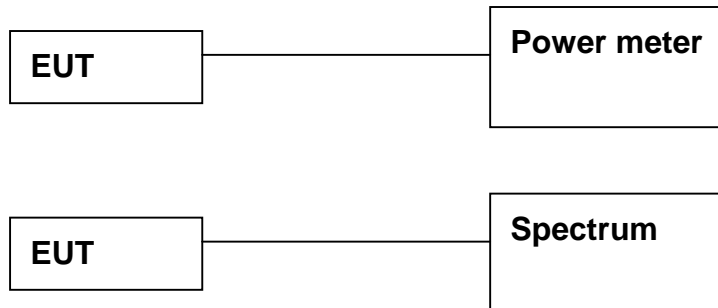

The EUT was connected to a spectrum through a 50 RF cable.

4.5.4 TEST PROCEDURE

The EUT was operating in hopping mode or could control its channel.
 Printed out the test result from the spectrum by hard copy function.
 Recorded the read value of the power meter.

4.5.5 EUT OPERATING CONDITION

Same as section 4.1.5 of this report.

4.5.6 TEST RESULT

Temperature:	<u>26°C</u>	Humidity:	<u>55%RH</u>
Spectrum Detector:	<u>PK</u>	Tested by:	<u>Julian Chiang</u>
Test Result:	<u>PASS</u>		

CHANNEL NUMBER	CHANNEL FREQUENCY (MHz)	PEAK POWER OUTPUT (dBm)	PEAK POWER LIMIT (dBm)
0	2402.0000	1.49	30
39	2441.0000	1.54	30
78	2480.0000	0.51	30



CH0:

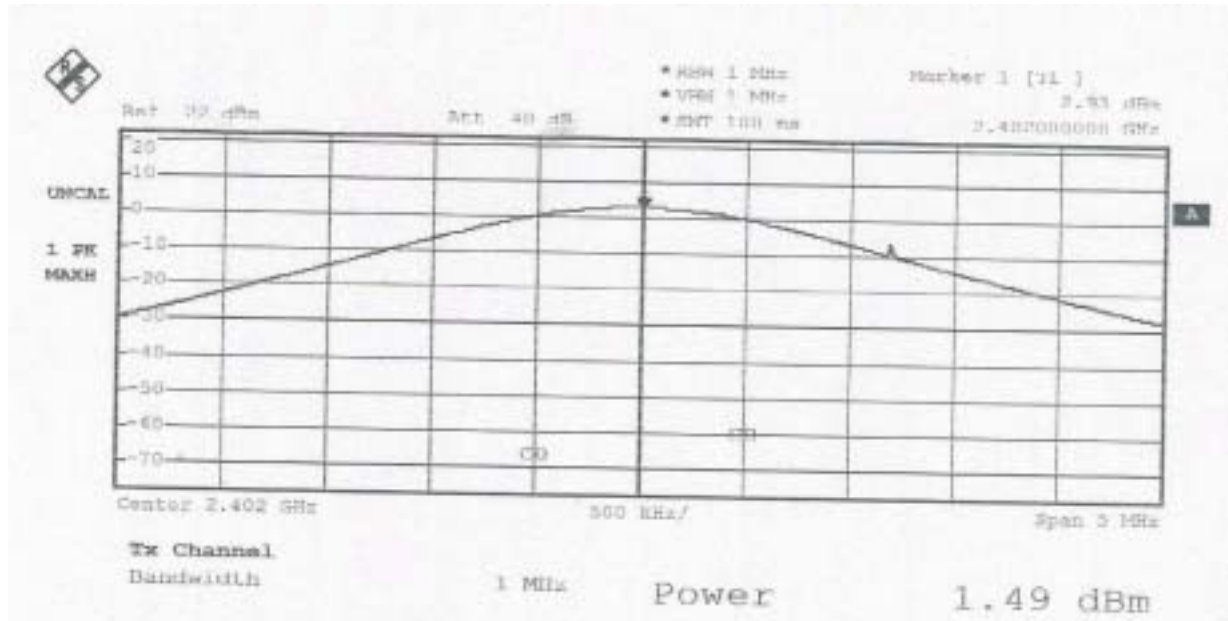

CH39:

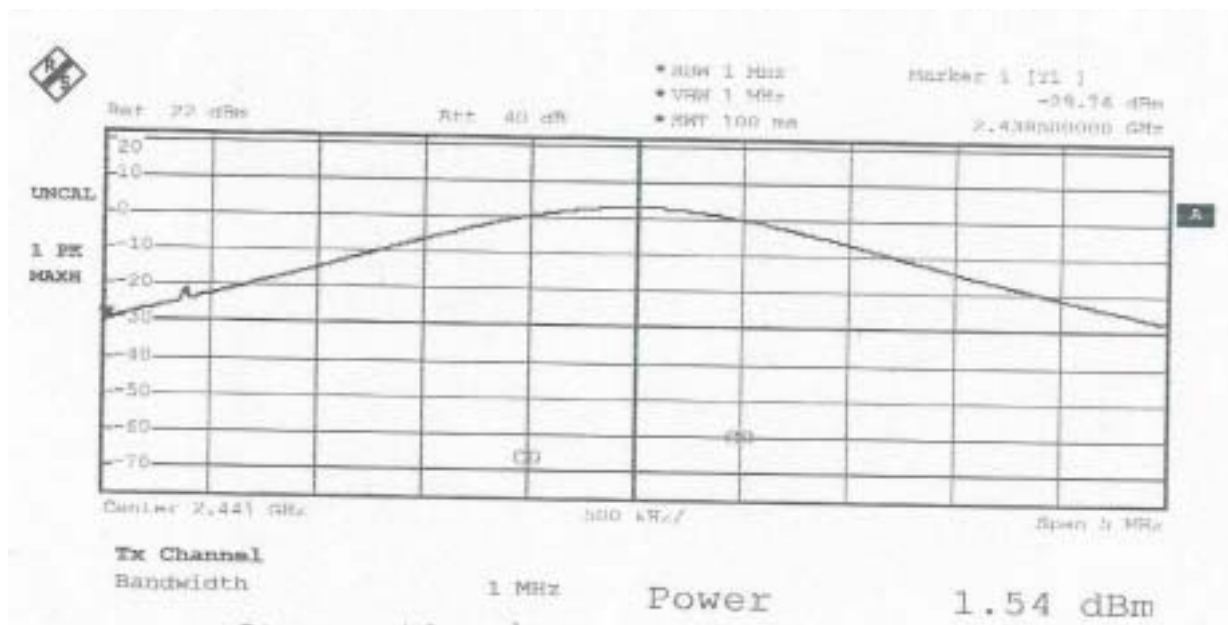



Spectrum Research & Testing Lab., Inc.
No. 101-10, Ling 8,
Shan-Tong Li, Chung-Li
City, Taoyuan, Taiwan

TEST REPORT

Reference No.:C05030802
Report No.:FCCA05030802
FCC ID:I4L-MS6970A
Page:27 of 49
Date: Mar. 21, 2005

CH78:

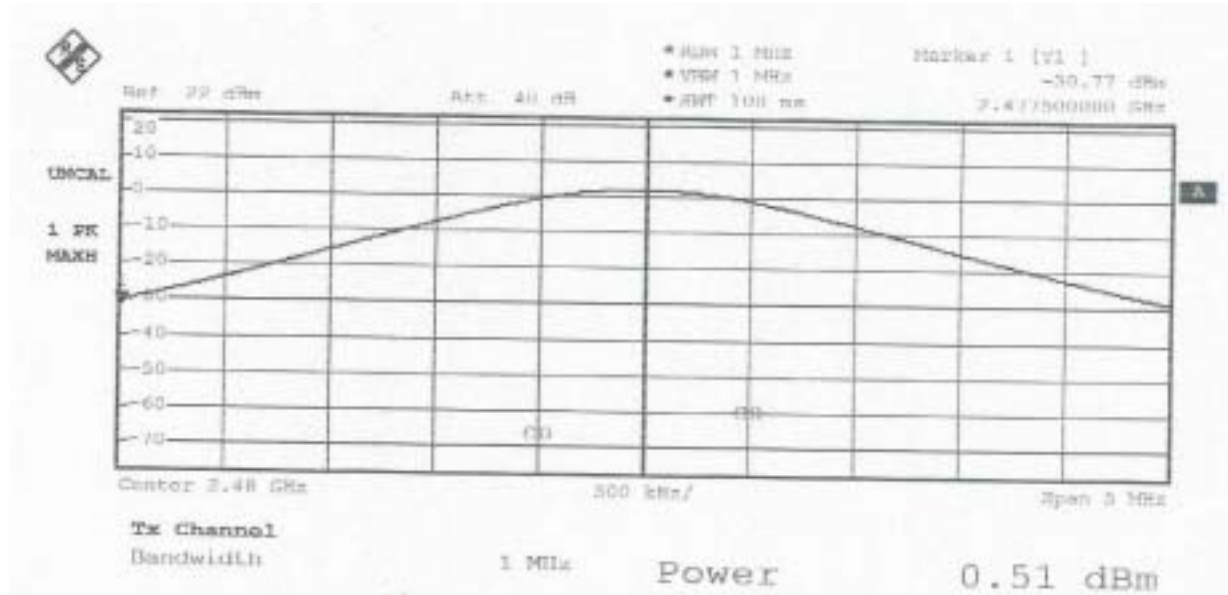



4.6 BAND EDGE TEST

4.6.1 LIMIT

FCC Part15, Subpart C Section 15.247. In any 100 kHz bandwidth outside the frequency band in which the spread spectrum intentional radiator is operating, the radio frequency power that is produced by the intentional radiator shall be at least 20 dB below that in the 100 kHz bandwidth within the band that contains the highest level of the desired power, based on either an RF conducted or a radiated measurement. Attenuation below the general limits specified in Section 15.209(a) is not required. In addition, radiated emissions which fall in the restricted bands, as defined in Section 15.205(a), must also comply with the radiated emission limits specified in Section 15.209(a) (see Section 15.205(c)).

OPERATING FREQUENCY RANGE (MHz)	SPURIOUS EMISSION FREQUENCY (MHz)	LIMIT	
		Peak power ration to emission(dBc)	Emission level(dBuV/m)
902-928	<902	>20	NA
	>928	>20	NA
	960-1240	NA	54
2400-2483.5	<2400	>20	NA
	>2483.5-2500	NA	54
5725-5850	<5350-5460	NA	54
	<5725	>20	NA
	>5850	>20	NA



Spectrum Research & Testing Lab., Inc.
No. 101-10, Ling 8,
Shan-Tong Li, Chung-Li
City, Taoyuan, Taiwan

TEST REPORT

Reference No.:C05030802
Report No.:FCCA05030802
FCC ID:I4L-MS6970A
Page:29 of 49
Date: Mar. 21, 2005

4.6.2 TEST EQUIPMENT

The following test equipment was used during the test :

EQUIPMENT/ FACILITIES	SPECIFICATIONS	MANUFACTURER	MODEL#/ SERIAL#	DUE DATE OF CAL. & CAL. CENTER
SPECTRUM	9kHz-7GHz	ROHDE & SCHWARZ	FSP7/ 839511/010	MAR. 2005 ETC
EMI TEST RECEIVER	9 kHz TO 2750 MHz	ROHDE & SCHWARZ	ESCS30/ 830245/012	OCT. 2005 ETC
SPECTRUM	9KHz-26.5GHz	HP	8953E/ 3710A03220	MAY 2005 ETC
PRE-AMPLIFIER	1GHz-26.5GHz Gain:30dB	HP	8449B/ 3008A01019	NOV. 2005 ETC
BI-LOG ANTENNA	25 MHz TO 2 GHz	EMCO	3142/ 9701-1124	APR. 2005 SRT
HORN ANTENNA	1GHz to 18GHz	EMCO	3115/ 9602-4681	DEC. 2005 ETC
OATS	3 - 10 M measurement	SRT	SRT-1	APR. 2005 SRT

NOTE: The calibration interval of the above test equipment is one year and the calibrations are traceable to NML/ROC and NIST/USA.



4.6.3 TEST SET-UP

FOR RF CONDUCTED TEST (dBc)



The EUT was connected to the spectrum through a 50 Ω RF cable.

FOR RADIATED EMISSION TEST

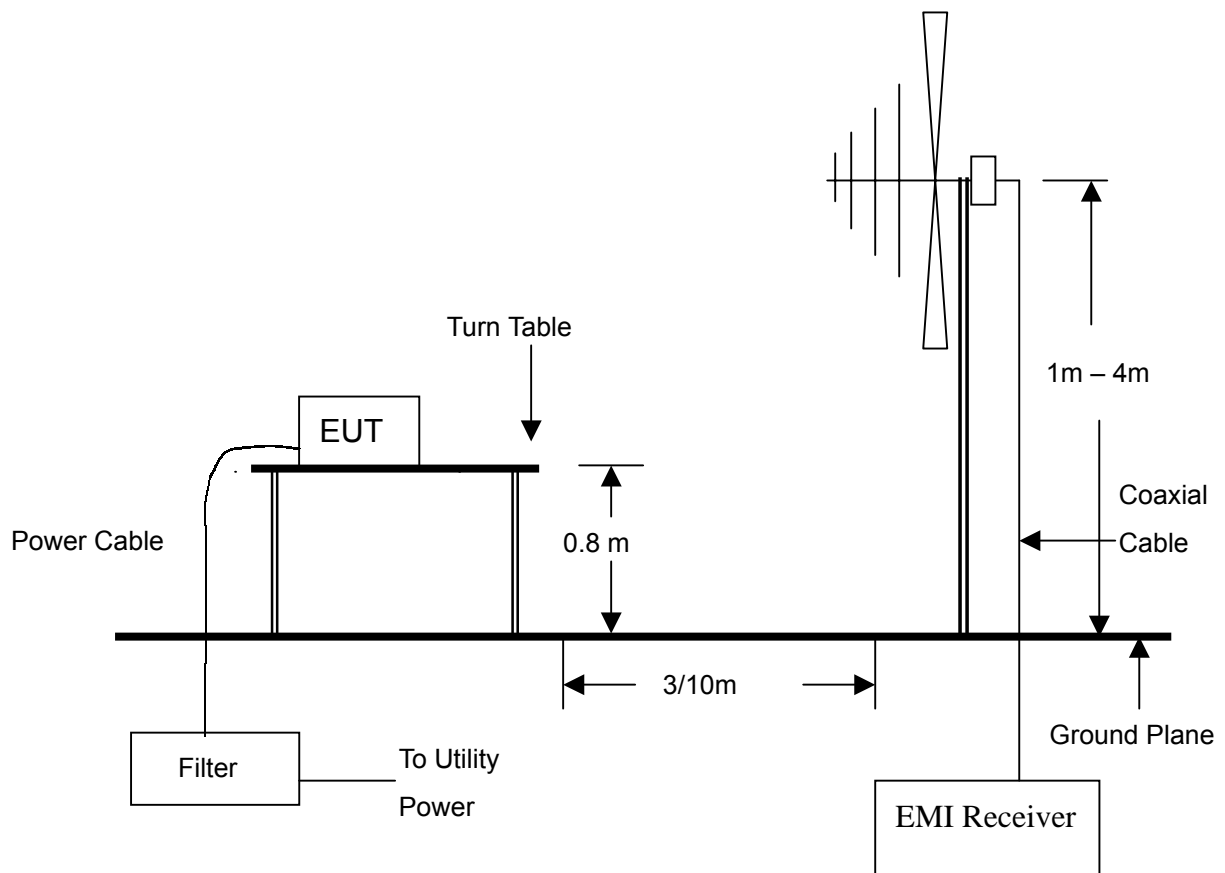

NOTE :

1. The EUT system was put on a wooden table with 0.8m heights above a ground plane.
2. For the actual test configuration, please refer to the photos of testing.



4.6.4 TEST PROCEDURE

1. The EUT was operating in hopping mode or could be controlled its channel.
Printed out the test result from the spectrum by hard copy function.
2. The EUT was tested according to the requirement of ANSI C63.4 and CISPR 22.
The measurements were made at an open area test site with 10 meter measurement distance under 1 GHz and with 3m distance above 1GHz. The frequency spectrum measured started from 30 MHz. Under 1 GHz. All readings were quasi-peak values with 120 kHz resolution bandwidth of the test receiver. Above 1 GHz, the measurements were made at an open area test site with 3 meter measurement distance and all readings were peak and average values with 1 MHz resolution bandwidth of the test receiver. The EUT system was operated in all typical methods by users. The cables connected to EUT and support units were moved to find the maximum emission levels for each frequency.

4.6.5 EUT OPERATING CONDITION

Same as section 4.1.5 of this report.

4.6.6 TEST RESULT

Temperature: 26°C Humidity: 55%RH
Spectrum Detector: PK & AV Tested by: Julian Chiang
Test Result: PASS

1. Conducted test

Frequency (MHz)	PEAK POWER OUTPUT (dBm)	Emission read Value(dBm)	Result of Band edge (dBc)	Band edge LIMIT (dBc)
<2400	1.49	-35.86	37.35	>20dBc
>2483.5	0.51	-42.91	43.42	>20dBc

2. Radiated emission test

Frequency (MHz)	Antenna polarization (H/V)	Reading (dBuV)		Emission (dBuV/m)		Band edge Limit (dBuV/m)	
		PK	AV	PK	AV	PK	AV
<2400	H	50.1	*	45.9	*	74.0	54.0
>2483.5	H	47.8	*	43.8	*	74.0	54.0



Spectrum Research & Testing Lab., Inc.
No. 101-10, Ling 8,
Shan-Tong Li, Chung-Li
City, Taoyuan, Taiwan

TEST REPORT

Reference No.:C05030802
Report No.:FCCA05030802
FCC ID:I4L-MS6970A
Page:32 of 49
Date: Mar. 21, 2005

<2400MHz:

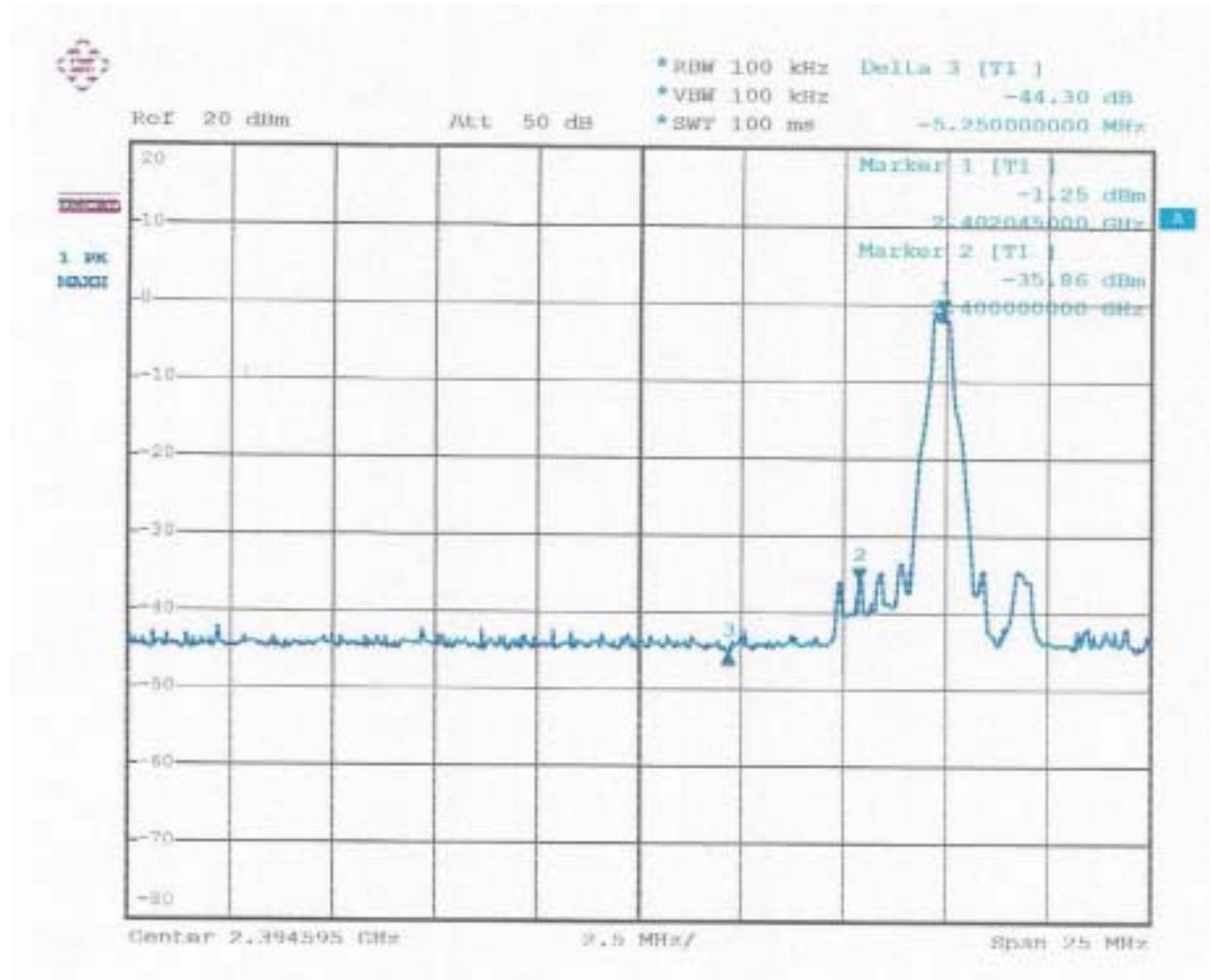



Spectrum Research & Testing Lab., Inc.
No. 101-10, Ling 8,
Shan-Tong Li, Chung-Li
City, Taoyuan, Taiwan

TEST REPORT

Reference No.:C05030802
Report No.:FCCA05030802
FCC ID:I4L-MS6970A
Page:33 of 49
Date: Mar. 21, 2005

>2483.5MHz

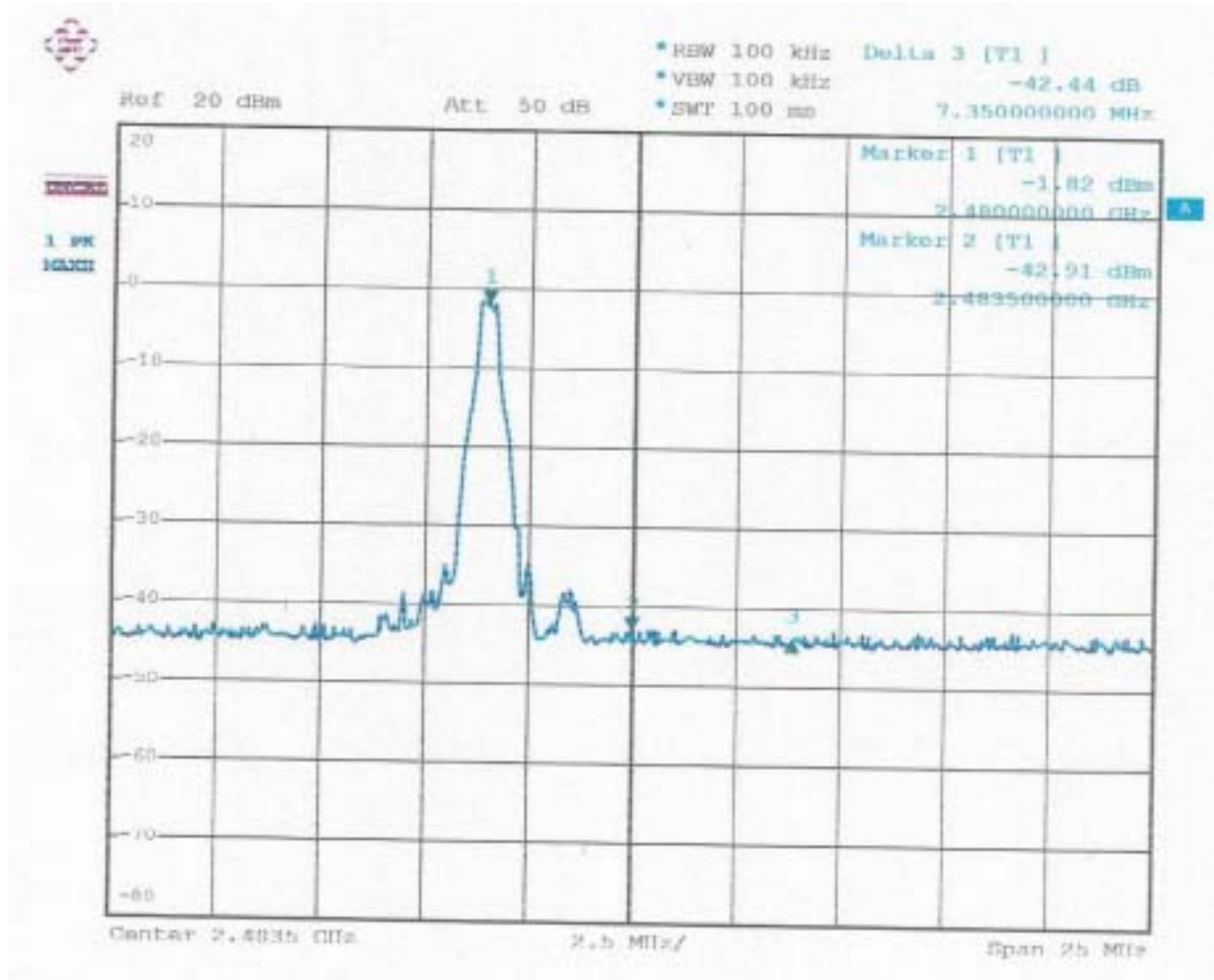



4.7 SPURIOUS RADIATED EMISSION TEST

4.7.1 LIMIT

FCC Part15, Subpart C Section 15.209 limit of radiated emission for frequency below1000MHz. The emissions from an intentional radiator shall not exceed the field strength levels specified in the following table:

FREQUENCY (MHz)	DISTANCE (m)	FIELD STRENGTH (dB μ V/m)
30 - 88	3	40.0
88 - 216	3	43.5
216 - 960	3	46.0
ABOVE 960	3	54.0

- NOTE** :
1. In the emission tables above , the tighter limit applies at the band edges.
 2. Distance refers to the distance between measuring instrument , antenna , and the closest point of any part of the device or system.

FCC Part 15, Section15.35(b) limit of radiated emission for frequency above 1000 MHz

FREQUENCY (MHz)	Class A (dBuV/m) (at 3m)		Class B (dBuV/m) (at 3m)	
	PEAK	AVERAGE	PEAK	AVERAGE
Above 1000	80.0	60.0	74.0	54.0

FCC Part 15, Subpart C Section 15.249. The field strength of emissions from intentional radiators operated within these frequency bands shall comply with the following:

FUNDAMENTAL FREQUENCY (MHz)	FIELD STRENGTH OF FUNDAMENTAL (dBuV/m) (at 3m)		FIELD STRENGTH OF HARMONICS (dBuV/m) (at 3m)	
	PEAK	AVERAGE	PEAK	AVERAGE
902-928	114	94	74.0	54.0
2400-2483.5	114	94	74.0	54.0
5725-5875	114	94	74.0	54.0
24000-24250	128	108	88.0	68.0



Spectrum Research & Testing Lab., Inc.
No. 101-10, Ling 8,
Shan-Tong Li, Chung-Li
City, Taoyuan, Taiwan

TEST REPORT

Reference No.:C05030802
Report No.:FCCA05030802
FCC ID:I4L-MS6970A
Page:35 of 49
Date: Mar. 21, 2005

4.7.2 TEST EQUIPMENT

The following test equipment was used during the radiated emission test :

EQUIPMENT/ FACILITIES	SPECIFICATIONS	MANUFACTURER	MODEL#/ SERIAL#	DUE DATE OF CAL. & CAL. CENTER
EMI TEST RECEIVER	20 kHz TO 1 GHz	ROHDE & SCHWARZ	ESVS30/ 841977/003	SEP. 2005 ETC
BI-LOG ANTENNA	25 MHz TO 2 GHz	EMCO	3142/ 9701-1124	APR. 2005 SRT
OATS	3 – 10 M MEASUREMENT	SRT	SRT-1	APR. 2005 SRT
COAXIAL CABLE	25M	SUNCITY	J400/ 25M	AUG. 2005 SRT
FILTER	2 LINE, 30A	FIL.COIL	FC-943/ 869	N/A
FREQUENCY CONVERTER	N/A	APC	AFC-2KBB/ F100030031	AUG. 2005 SRT

NOTE:

1. The calibration interval of the above test equipment is one year and the calibrations are traceable to NML/ROC and NIST/USA.
2. The Open Area Test Site (SRT-1) is registered by FCC with No. 90957 and VCCI with No. R-1081.
3. The Open Area Test Site (SRT-2) is registered by FCC with No. 98458 and VCCI with No. R-1168.



4.7.3 TEST SET-UP

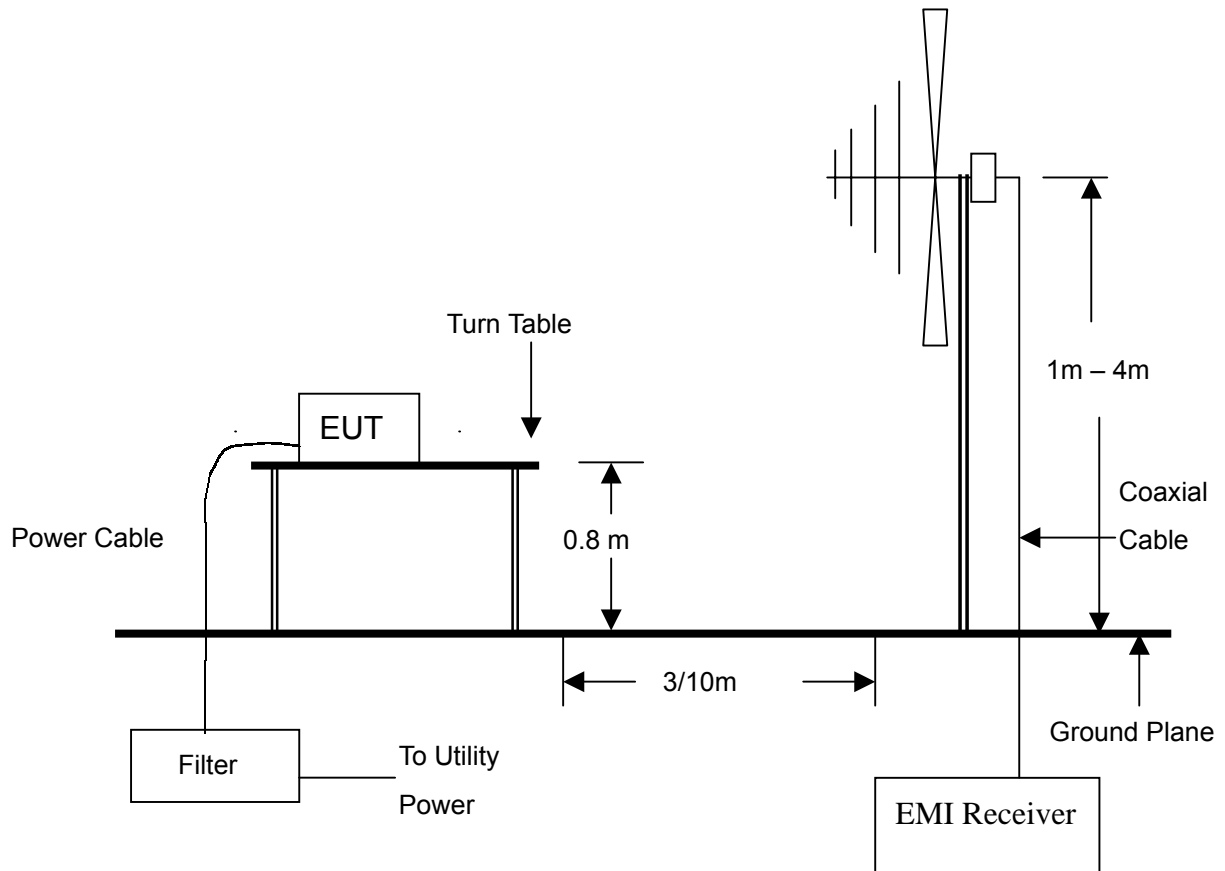

NOTE :

1. The EUT system was put on a wooden table with 0.8m heights above a ground plane.
2. For the actual test configuration, please refer to the photos of testing.



**Spectrum Research &
Testing Lab., Inc.**
No. 101-10, Ling 8,
Shan-Tong Li, Chung-Li
City, Taoyuan, Taiwan

TEST REPORT

Reference No.:C05030802
Report No.:FCCA05030802
FCC ID:I4L-MS6970A
Page:37 of 49
Date: Mar. 21, 2005

4.7.4 TEST PROCEDURE

The EUT was tested according to the requirement of ANSI C63.4 and CISPR 22. The measurements were made at an open area test site with 10 meter measurement distance under 1 GHz and with 3m distance above 1GHz. The frequency spectrum measured started from 30 MHz. Under 1 GHz. All readings were quasi-peak values with 120 kHz resolution bandwidth of the test receiver. Above 1 GHz, the measurements were made at an open area test site with 3 meter measurement distance and all readings were peak and average values with 1 MHz resolution bandwidth of the test receiver. The EUT system was operated in all typical methods by users. The cables connected to EUT and support units were moved to find the maximum emission levels for each frequency.

4.7.5 EUT OPERATING CONDITION

Same as section 4.1.5 of this report.



4.7.6 TEST RESULT

Temperature:	25°C	Humidity:	60%RH
Ferquency Range:	30 – 1000 MHz	Test mode:	RX
Receiver Detector:	Q.P. or AV.	Measured Distance:	3m
Tested by:	Julian Chiang		

Antenna Polarization : Horizontal

Frequency (MHz)	Cable Loss (dB)	Antenna Factor (dB/m)	Reading Data (dBμV)	Emission Level (dBμV/m)	Limit (dBμV/m)	Margin (dB)	EL(m)	AZ(°)
31.9340	0.37	13.19	9.4	23.0	40.0	-17.0	217.8	4.0
84.3350	1.24	7.40	10.3	18.9	40.0	-21.1	82.1	4.0
166.7330	1.91	8.53	12.5	22.9	43.5	-20.6	128.9	3.6
386.2900	3.17	15.91	8.3	27.4	46.0	-18.6	29.8	2.9
464.1130	3.11	17.03	7.7	27.8	46.0	-18.2	189.7	2.7
664.3570	4.56	20.48	6.9	31.9	46.0	-14.1	45.2	1.9

Antenna Polarization : Vertical

Frequency (MHz)	Cable Loss (dB)	Antenna Factor (dB/m)	Reading Data (dBμV)	Emission Level (dBμV/m)	Limit (dBμV/m)	Margin (dB)	EL(m)	AZ(°)
31.8770	0.37	13.19	10.2	23.8	40.0	-16.2	89.2	1.5
85.2780	1.24	7.35	12.3	20.9	40.0	-19.1	89.7	1.3
305.2900	2.44	14.21	7.4	24.0	46.0	-22.0	238.9	1.8
383.6700	3.18	15.84	9.8	28.8	46.0	-17.2	83.4	1.7
667.2500	4.51	20.54	6.7	31.8	46.0	-14.2	289.3	1.0
825.4040	4.89	22.10	6.6	33.6	46.0	-12.4	349.8	1.5

- NOTE :**
1. Measurement uncertainty is less than +/-2dB
 2. "": Measurement does not apply for this frequency.
 3. Emission Level = Reading Value + Ant. Factor + Cable Loss
 4. The field strength of other emission frequencies were very low against the limit.



Temperature: 25°C Humidity: 60%RH
 Frequency Range: 1 – 25 GHz Test mode: Ch0
 Receiver Detector: PK. or AV. Measured Distance: 3m
 Tested by: Julian Chiang

Antenna Polarization : Horizontal

Freq./MHz	Cable Loss (dB)	Ant. Fact. (dB)	Reading (dBuV)		Emission (dBuV/m)		Limit Line (dBuV/m)		Margin (dBuV/m)		AZ (o)	EL (m)
			PK	AV	PK	AV	PK	AV	PK	AV		
2402.00(F)	-32.16	28.54	88.0	55.6	84.4	52.0	N/A	N/A	N/A	N/A	172.9	1.0
4804.00	-30.47	33.64	51.7	*	54.9	*	74.0	54.0	-19.1	*	78.9	1.1
7206.00	-28.90	36.26	51.5	*	58.9	*	74.0	54.0	-15.1	*	37.8	1.0
2394.56	-32.18	27.99	50.1	*	45.9	*	74.0	54.0	-28.1	*	78.1	1.0
2406.55	-32.17	28.01	49.2	*	45.0	*	74.0	54.0	-29.0	*	74.2	1.3
2422.69	-32.20	28.04	50.3	*	46.1	*	74.0	54.0	-27.9	*	78.3	1.0

Antenna Polarization : Vertical

Freq/MHz	Cable Loss (dB)	Ant. Fact. (dB)	Reading (dBuV)		Emission (dBuV/m)		Limit Line (dBuV/m)		Margin (dBuV/m)		AZ (o)	EL (m)
			PK	AV	PK	AV	PK	AV	PK	AV		
2402.00(F)	-32.16	28.00	86.7	52.7	82.5	48.5	N/A	N/A	N/A	N/A	37.8	1.0
4804.00	-30.47	33.64	53.5	30.8	56.6	34.0	74.0	54.0	-17.4	-20.0	62.4	1.0
7206.00	-28.90	36.26	51.3	*	58.7	*	74.0	54.0	-15.3	*	73.8	1.1
2387.34	-32.21	27.97	48.9	*	44.7	*	74.0	54.0	-29.3	*	347.8	1.2
2414.38	-32.18	28.03	49.6	*	45.4	*	74.0	54.0	-28.6	*	78.9	1.0
2420.38	-32.19	28.04	49.8	*	45.6	*	74.0	54.0	-28.4	*	68.3	1.0

- NOTE :**
1. Measurement uncertainty is less than +/-2dB
 2. "*": Measurement does not apply for this frequency.
 3. Emission Level = Reading Value + Ant. Factor + Cable Loss
 4. The field strength of other emission frequencies were very low against the limit.
 - 5.(F):The field strength of fundamental frequency.



TEST REPORT

Temperature:	<u>25°C</u>	Humidity:	<u>60%RH</u>
Ferquency Range:	<u>1 – 25 GHz</u>	Test mode:	<u>Ch39</u>
Receiver Detector:	<u>PK. or AV.</u>	Measured Distance:	<u>3m</u>
Tested by:	<u>Julian Chiang</u>		

Antenna Polarization : Horizontal

Freq./MHz	Cable Loss (dB)	Ant. Fact. (dB)	Reading (dBuV)		Emission (dBuV/m)		Limit Line (dBuV/m)		Margin (dBuV/m)		AZ (o)	EL (m)
			PK	AV	PK	AV	PK	AV	PK	AV		
2441.00(F)	-32.23	28.62	94.5	57.3	90.9	53.7	N/A	N/A	N/A	N/A	39.8	1.0
4882.00	-30.26	33.71	51.2	30.8	54.6	34.2	74.0	54.0	-19.4	-19.8	348.7	1.1
7323.00	-29.04	36.36	51.6	30.9	58.9	38.2	74.0	54.0	-15.1	-15.8	74.3	1.0
2430.35	-32.21	28.06	49.3	*	45.2	*	74.0	54.0	-28.8	*	347.1	1.0
2438.19	-32.22	28.08	48.3	*	44.2	*	74.0	54.0	-29.8	*	324.7	1.2
2487.35	-32.18	28.17	49.1	*	45.1	*	74.0	54.0	-28.9	*	64.0	1.1

Antenna Polarization : Vertical

Freq./MHz	Cable Loss (dB)	Ant. Fact. (dB)	Reading (dBuV)		Emission (dBuV/m)		Limit Line (dBuV/m)		Margin (dBuV/m)		AZ (o)	EL (m)
			PK	AV	PK	AV	PK	AV	PK	AV		
2441.00(F)	-32.23	28.08	87.1	52.8	83.0	48.7	N/A	N/A	N/A	N/A	39.8	1.0
4882.00	-30.26	33.71	49.7	30.2	53.1	33.6	74.0	54.0	-20.9	-20.4	378.5	1.0
7323.00	-29.04	36.36	51.1	30.5	58.4	37.8	74.0	54.0	-15.6	-16.2	3.1	1.2
2416.57	-32.19	28.03	48.7	*	44.5	*	74.0	54.0	-29.5	*	37.2	1.2
2447.92	-32.24	28.09	49.2	*	45.1	*	74.0	54.0	-28.9	*	67.2	1.1
2475.39	-32.20	28.15	49.2	*	45.2	*	74.0	54.0	-28.8	*	86.4	1.1

- NOTE :**
1. Measurement uncertainty is less than +/-2dB
 2. "**": Measurement does not apply for this frequency.
 3. Emission Level = Reading Value + Ant. Factor + Cable Loss
 4. The field strength of other emission frequencies were very low against the limit.
 - 5.(F):The field strength of fundamental frequency.



TEST REPORT

Temperature:	<u>25°C</u>	Humidity:	<u>60%RH</u>
Ferquency Range:	<u>1 – 25GHz</u>	Test mode:	<u>Ch78</u>
Receiver Detector:	<u>PK. or AV.</u>	Measured Distance:	<u>3m</u>
Tested by:	<u>Julian Chiang</u>		

Antenna Polarization : Horizontal

Freq./MHz	Cable Loss (dB)	Ant. Fact. (dB)	Reading (dBuV)		Emission (dBuV/m)		Limit Line (dBuV/m)		Margin (dBuV/m)		AZ (o)	EL (m)
			PK	AV	PK	AV	PK	AV	PK	AV		
2480.00(F)	-32.19	28.73	87.8	54.1	84.3	50.6	N/A	N/A	N/A	N/A	74.3	1.0
4960.00	-30.26	33.77	48.6	29.4	52.1	32.9	74.0	54.0	-21.9	-21.1	324.2	1.0
7440.00	-28.95	36.45	50.7	30.4	58.2	37.9	74.0	54.0	-15.8	-16.1	76.4	1.0
2427.28	-32.20	28.05	47.3	*	43.2	*	74.0	54.0	-30.8	*	63.4	1.0
2469.52	-32.21	28.14	48.4	*	44.3	*	74.0	54.0	-29.7	*	37.2	1.0
2487.91	-32.18	28.17	48.1	*	44.1	*	74.0	54.0	-29.9	*	64.2	1.1

Antenna Polarization : Vertical

Freq./MHz	Cable Loss (dB)	Ant. Fact. (dB)	Reading (dBuV)		Emission (dBuV/m)		Limit Line (dBuV/m)		Margin (dBuV/m)		AZ (o)	EL (m)
			PK	AV	PK	AV	PK	AV	PK	AV		
2480.00(F)	-32.19	28.16	89.5	56.7	85.5	52.7	N/A	N/A	N/A	N/A	63.2	1.0
4960.00	-30.26	33.77	52.1	31.0	55.6	34.5	74.0	54.0	-18.4	-19.5	73.8	1.0
7440.00	-28.95	36.45	50.7	29.4	58.2	36.9	74.0	54.0	-15.8	-17.1	234.8	1.0
2437.66	-32.22	28.07	48.5	*	44.4	*	74.0	54.0	-29.6	*	278.7	1.1
2469.38	-32.21	28.14	49.1	*	45.0	*	74.0	54.0	-29.0	*	78.5	1.1
2491.46	-32.17	28.18	47.8	*	43.8	*	74.0	54.0	-30.2	*	27.3	1.0

- NOTE :**
1. Measurement uncertainty is less than +/- 2dB
 2. "**": Measurement does not apply for this frequency.
 3. Emission Level = Reading Value + Ant. Factor + Cable Loss
 4. The field strength of other emission frequencies were very low against the limit.
 - 5.(F):The field strength of fundamental frequency.



4.8 CONDUCTED EMISSION TEST

4.8.1 CONDUCTED EMISSION LIMIT

FREQUENCY (MHz)	Class A (dB μ V)		Class B (dB μ V)	
	Quasi-peak	Average	Quasi-peak	Average
0.15 - 0.5	79	66	66 - 56	56 - 46
0.5 - 5.0	73	60	56	46
5.0 - 30.0	73	60	60	50

NOTE:

1. The lower limit shall apply at the transition frequencies.
2. The limit decreases in line with the logarithm of the frequency in the range of 0.15 to 0.50 MHz.

4.8.2 TEST EQUIPMENT

The following test equipment was used for the test:

EQUIPMENT/ FACILITIES	SPECIFICATIONS	MANUFACTURER	MODEL#/ SERIAL#	DUE DATE OF CAL. & CAL. CENTER
EMI TEST RECEIVER	9 kHz TO 30 MHz	ROHDE & SCHWARZ	ESHS30/ 826003/008	AUG. 2005 ETC
LISN (for EUT)	50 μ H, 50 ohm	FCC	FCC-LISN-50-25-2/ 01017	NOV. 2005 ETC
LISN (for Peripheral)	50 μ H, 50 ohm	FCC	FCC-LISN-50-25-2/ 01018	NOV. 2005 ETC
50 ohm TERMINATOR	50 ohm	HP	11593A/ 2	OCT. 2005 ETC
COAXIAL CABLE	3m	SUNCITY	J400/ 3M	JUL. 2005 SRT
ISOLATION TRANSFORMER	N/A	APC	AFC-11015/ F102040016	N/A
FILTER	2 LINE, 30A	FIL.COIL	FC-943/ 771	N/A
GROUND PLANE	2.3M (H) x 2.4M (W)	SRT	N/A	N/A
GROUND PLANE	2.4M (H) x 2.4M (W)	SRT	N/A	N/A

NOTE: The calibration interval of the above test equipment is one year and the calibrations are traceable to NML/ROC and NIST/USA.



4.8.3 TEST SETUP

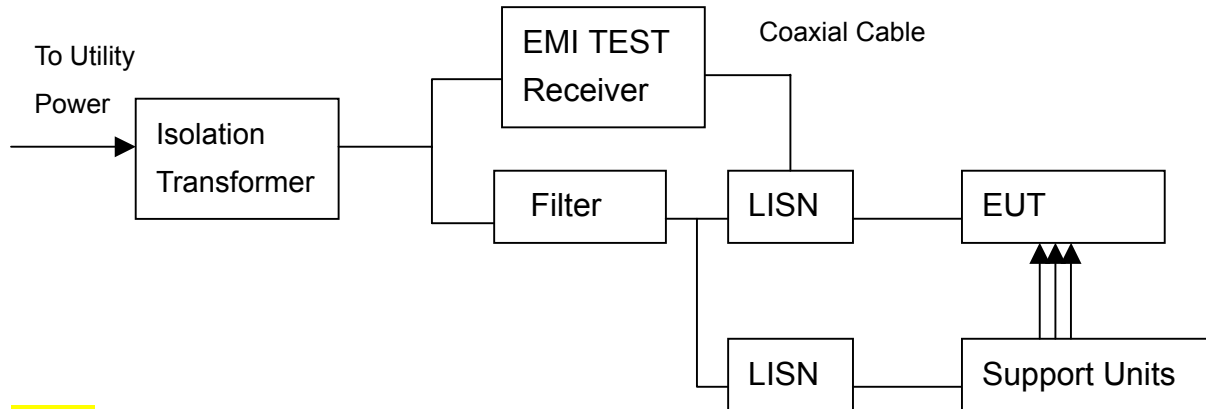

NOTE:

1. The EUT was put on a wooden table with 0.8m heights above ground plane, and 0.4m away from reference ground plane (> 2mx2m).
2. For the actual test configuration, please refer to the photos of testing.
3. The serial no. of the LISN connected to EUT is 01017.
4. The serial no. of the LISN connected to support units is 01018.

4.8.4 TEST PROCEDURE

The EUT was tested according to the requirement of ANSI C63.4:2003 and CISPR22:2003. The frequency spectrum from 0.15 MHz to 30 MHz was investigated. The LISN used was 50 ohm/50 μ H as specified. All readings were quasi-peak and average values with 10 kHz resolution bandwidth of the test receiver. The EUT system was operated in all typical methods by users. Both lines of the power mains of EUT were measured and the cables connected to EUT and support units were moved to find the maximum emission levels for each frequency.

First, find the margin or higher points at least 6 points by software, then use manual to find the maximum data. The procedure is referred on the test procedure of SRT LAB.



4.8.5 TEST RESULT

Temperature:	20 °C	Humidity:	58 %RH
Ferquency Range:	0.15 – 30 MHz	Test Mode:	Link
Receiver Detector:	Q.P. and AV.	Tested By:	Julian Chiang
		Tested Date:	Mar. 18, 2005

Power Line Measured : Line

Freq. (MHz)	Correct. Factor (dB)	Reading Value (dB μ V)		Emission Level (dB μ V)		Limit (dB μ V)		Margin (dB)	
		Q.P.	AV.	Q.P.	AV.	Q.P.	AV.	Q.P.	AV.
0.156	0.30	50.16	22.56	50.46	22.86	65.66	55.66	-15.20	-32.80
0.572	0.24	30.62	24.16	30.86	24.40	56.00	46.00	-25.14	-21.60
3.368	0.10	40.12	34.64	40.22	34.74	56.00	46.00	-15.78	-11.26
6.929	0.10	36.88	31.53	36.98	31.63	60.00	50.00	-23.02	-18.37
7.487	0.10	37.20	31.01	37.30	31.11	60.00	50.00	-22.70	-18.89
15.502	0.10	31.56	23.69	31.66	23.79	60.00	50.00	-28.34	-26.21

Power Line Measured : Neutral

Freq. (MHz)	Correct. Factor (dB)	Reading Value (dB μ V)		Emission Level (dB μ V)		Limit (dB μ V)		Margin (dB)	
		Q.P.	AV.	Q.P.	AV.	Q.P.	AV.	Q.P.	AV.
0.153	0.30	50.52	22.70	50.82	23.00	65.82	55.82	-15.00	-32.82
0.548	0.24	30.66	22.77	30.90	23.01	56.00	46.00	-25.10	-22.99
3.903	0.10	39.78	34.18	39.88	34.28	56.00	46.00	-16.12	-11.72
4.229	0.10	38.70	32.73	38.80	32.83	56.00	46.00	-17.20	-13.17
7.426	0.10	37.36	31.44	37.46	31.54	60.00	50.00	-22.54	-18.46
27.813	0.10	33.32	27.56	33.42	27.66	60.00	50.00	-26.58	-22.34

NOTE :

1. Measurement uncertainty is +/-1.32dB
2. Emission level = Reading value + Correction factor
3. Correction Factor = Cable loss + Insertion loss of LISN
4. Margin value = Emission level - Limit
5. The emission of other frequencies were very low against the limit.
6. "-": The Quasi-peak reading value also meets average limit and measurement with the average detector is unnecessary.



Spectrum Research & Testing Lab., Inc.
No. 101-10, Ling 8,
Shan-Tong Li, Chung-Li
City, Taoyuan, Taiwan

TEST REPORT

Reference No.:C05030802
Report No.:FCCA05030802
FCC ID:I4L-MS6970A
Page:45 of 49
Date: Mar. 21, 2005

5. Antenna application

5.1 Antenna requirement

The EUT's antenna is met the requirement of FCC part15C section15.203 and 15.204.

FCC part15C section15.247 requirement:

Systems operating in the 2400-2483.5 MHz band that are used exclusively for fixed, point-to-point operations may employ transmitting antennas with directional gain greater than 6 dBi provided the maximum peak output power of the intentional radiator is reduced by 1 dB for every 3 dB that the directional gain of the antenna exceeds 6 dBi.

5.2 Result

The EUT's antenna used a dipole antenna and integrated on PCB. The antenna's gain is 0dBi and meets the requirement.



6. PHOTOS OF TESTING

- Radiated test(RX)

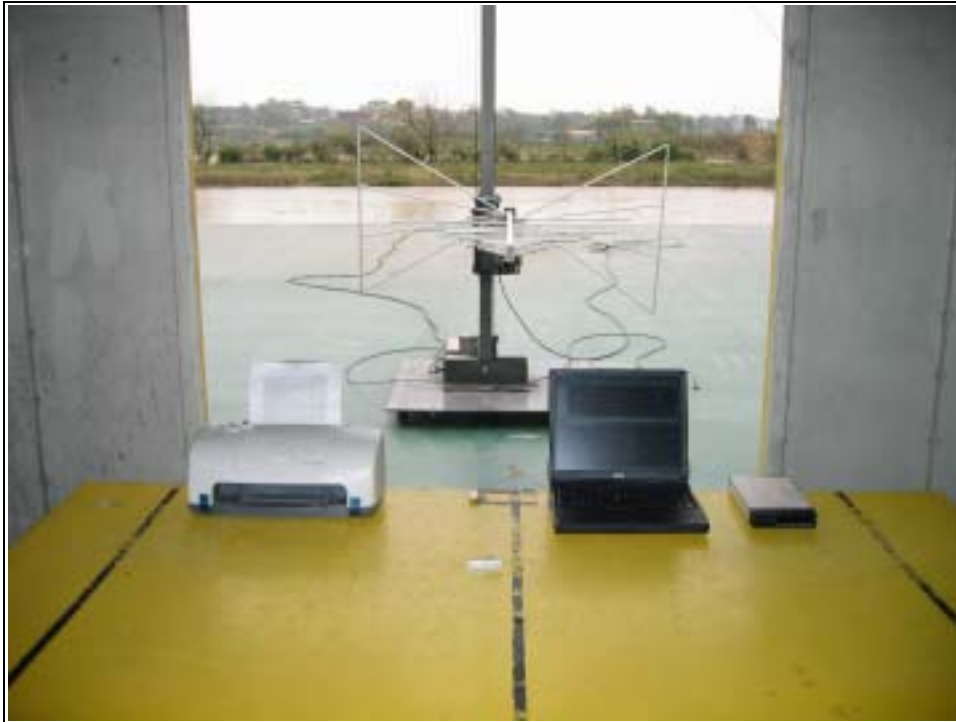



- Radiated test(TX)





Spectrum Research & Testing Lab., Inc.
No. 101-10, Ling 8,
Shan-Tong Li, Chung-Li
City, Taoyuan, Taiwan

TEST REPORT

Reference No.:C05030802
Report No.:FCCA05030802
FCC ID:I4L-MS6970A
Page:48 of 49
Date: Mar. 21, 2005

- Conducted test

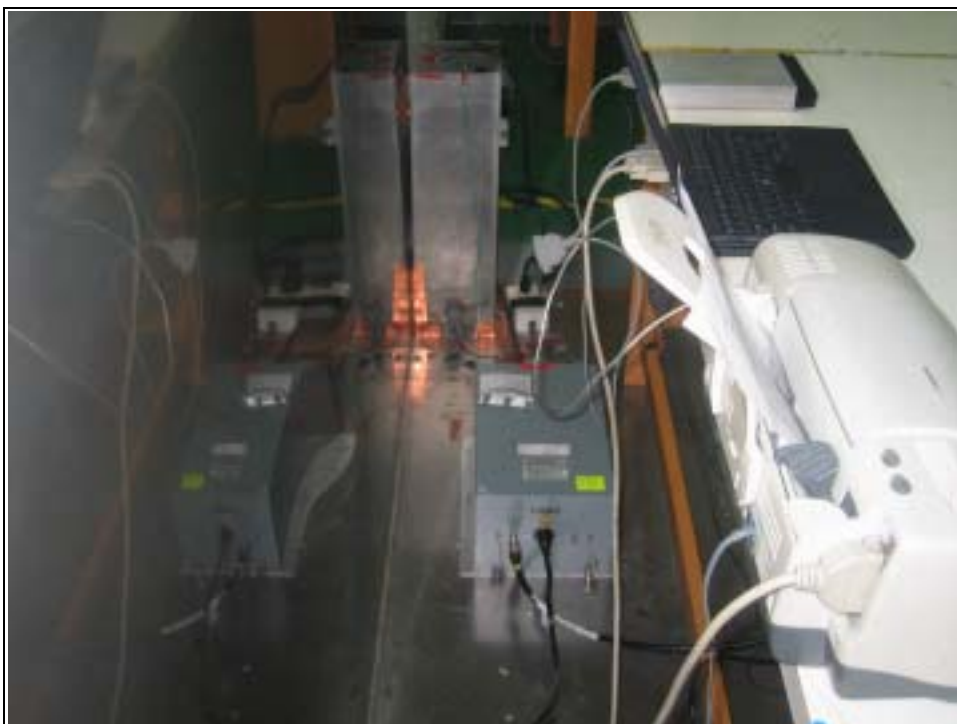



Spectrum Research & Testing Lab., Inc.
No. 101-10, Ling 8,
Shan-Tong Li, Chung-Li
City, Taoyuan, Taiwan

TEST REPORT

Reference No.:C05030802
Report No.:FCCA05030802
FCC ID:I4L-MS6970A
Page:49 of 49
Date: Mar. 21, 2005

7. TERMS OF ABRIVATION

AV.	Average detection
AZ(°)	Turn table azimuth
Correct.	Correction
EL(m)	Antenna height (meter)
EUT	Equipment Under Test
Horiz.	Horizontal direction
LISN	Line Impedance Stabilization Network
NSA	Normalized Site Attenuation
Q.P.	Quasi-peak detection
SRT Lab	Spectrum Research & Testing Laboratory, Inc.
Vert.	Vertical direction