



Test Report

Product Name: BToes

Model No.: MS-6970

FCC ID.: I4L-MS6970

Applicant : MICRO-STAR INT'L Co., LTD.

Address : No. 69, Li-De st., Jung-He City, Taipei Hsien, Taiwan, R.O.C.

Date of Receipt : Jan. 10, 2003

Date of Test : Mar. 07, 2003

Report No. : 031L033FI

The Test Results relate only to the samples tested.

The test report shall not be reproduced except in full without the written approval of Quietek Corporation.

This report must not be used to claim product endorsement by NVLAP any agency of the U.S. Government

Test Report Certification

Test Date : Mar. 07, 2003

Report No. : 031L033FI



Accredited by NIST (NVLAP)

NVLAP Lab Code: 200347-0

Product Name : BToes
Applicant : MICRO-STAR INT'L Co., LTD.
Address : No. 69, Li-De st., Jung-He City, Taipei Hsien, Taiwan, R.O.C.
Manufacturer : MICRO-STAR INT'L Co., LTD.
Model No. : MS-6970
FCC ID. : I4L-MS6970
Rated Voltage : DC 5V (Power from PC/Notebook)
Trade Name : MICRO-STAR
Measurement Standard : FCC Part 15 Subpart C Paragraph 15.247
Measurement Procedure : ANSI C63.4:1992
Test Result : Complied



The Test Results relate only to the samples tested.

The test report shall not be reproduced except in full without the written approval of Quietek Corporation.

This report must not be used to claim product endorsement by NVLAP any agency of the U.S. Government



Documented By : 
(Ellie Cheng)
Tested By : 
(John Wu)
Approved By : 
(Gene Chang)

TABLE OF CONTENTS

Description	Page
1. GENERAL INFORMATION	5
1.1. EUT Description.....	5
1.2. Operational Description.....	6
1.3. Tested System Details.....	7
1.4. Configuration of Tested System	8
1.5. EUT Exercise Software	8
1.6. Test Facility	9
2. Conducted Emission	10
2.1. Test Equipment List.....	10
2.2. Test Setup	10
2.3. Limits.....	10
2.4. Test Procedure	11
2.5. Test Result of Conducted Emission.....	12
3. Peak Power Output	13
3.1. Test Equipment	13
3.2. Test Setup	13
3.3. Test Condition.....	13
3.4. Limit	13
3.5. Test Result of Peak Power Output.....	14
4. Radiated Emission	15
4.1. Test Equipment	15
4.2. Test Setup	15
4.3. Test Condition.....	16
4.4. Limits.....	16
4.5. Test Procedure	16
4.6. Test Result of Radiated Emission	17
5. Band Edge	23
5.1. Test Equipment	23
5.2. Test Setup	23
5.3. Test Condition.....	24
5.4. Limit	24
5.5. Test Result of Band Edge	25
6. Occupied Bandwidth	27
6.1. Test Equipment	27
6.2. Test Setup	27
6.3. Test Condition.....	27
6.4. Limit	27
6.5. Test Result of Occupied Bandwidth	28
7. Channel of Number	29
7.1. Test Equipment	29
7.2. Test Setup	29
7.3. Test Condition.....	29

7.4.	Limit	29
7.5.	Test Result of Channel Number.....	30
8.	Channel Separation	32
8.1.	Test Equipment	32
8.2.	Test Setup	32
8.3.	Test Condition.....	32
8.4.	Limit	32
8.5.	Test Result of Channel Separation.....	33
9.	Dwell Time.....	34
9.1.	Test Equipment	34
9.2.	Test Setup	34
9.3.	Test Condition.....	34
9.4.	Limit	34
9.5.	Test Result of Dwell Time	35
10.	EMI Reduction Method During Compliance Testing.....	36

Attachment 1: EUT Test Photographs

Attachment 2: EUT Detailed Photographs

1. GENERAL INFORMATION

1.1. EUT Description

Product Name : BToes
 Trade Name : MICRO-STAR
 FCC ID. : I4L-MS6970
 Model No. : MS-6970
 Frequency Range : 2400MHz to 2483.5MHz
 Channel Number : 79
 Type of Modulation : Frequency Hopping Spread Spectrum
 Antenna Type : Printed
 Operator Selection of
 Operating Frequency : By software

Frequency of Each Channel:

Channel	Frequency	Channel	Frequency	Channel	Frequency	Channel	Frequency
Channel 00:	2402 MHz	Channel 20:	2422 MHz	Channel 40:	2442 MHz	Channel 60:	2462 MHz
Channel 01:	2403 MHz	Channel 21:	2423 MHz	Channel 41:	2443 MHz	Channel 61:	2463 MHz
Channel 02:	2404 MHz	Channel 22:	2424 MHz	Channel 42:	2444 MHz	Channel 62:	2464 MHz
Channel 03:	2405 MHz	Channel 23:	2425 MHz	Channel 43:	2445 MHz	Channel 63:	2465 MHz
Channel 04:	2406 MHz	Channel 24:	2426 MHz	Channel 44:	2446 MHz	Channel 64:	2466 MHz
Channel 05:	2407 MHz	Channel 25:	2427 MHz	Channel 45:	2447 MHz	Channel 65:	2467 MHz
Channel 06:	2408 MHz	Channel 26:	2428 MHz	Channel 46:	2448 MHz	Channel 66:	2468 MHz
Channel 07:	2409 MHz	Channel 27:	2429 MHz	Channel 47:	2449 MHz	Channel 67:	2469 MHz
Channel 08:	2410 MHz	Channel 28:	2430 MHz	Channel 48:	2450 MHz	Channel 68:	2470 MHz
Channel 09:	2411 MHz	Channel 29:	2431 MHz	Channel 49:	2451 MHz	Channel 69:	2471 MHz
Channel 10:	2412 MHz	Channel 30:	2432 MHz	Channel 50:	2452 MHz	Channel 70:	2472 MHz
Channel 11:	2413 MHz	Channel 31:	2433 MHz	Channel 51:	2453 MHz	Channel 71:	2473 MHz
Channel 12:	2414 MHz	Channel 32:	2434 MHz	Channel 52:	2454 MHz	Channel 72:	2474 MHz
Channel 13:	2415 MHz	Channel 33:	2435 MHz	Channel 53:	2455 MHz	Channel 73:	2475 MHz
Channel 14:	2416 MHz	Channel 34:	2436 MHz	Channel 54:	2456 MHz	Channel 74:	2476 MHz
Channel 15:	2417 MHz	Channel 35:	2437 MHz	Channel 55:	2457 MHz	Channel 75:	2477 MHz
Channel 16:	2418 MHz	Channel 36:	2438 MHz	Channel 56:	2458 MHz	Channel 76:	2478 MHz
Channel 17:	2419 MHz	Channel 37:	2439 MHz	Channel 57:	2459 MHz	Channel 77:	2479 MHz
Channel 18:	2420 MHz	Channel 38:	2440 MHz	Channel 58:	2460 MHz	Channel 78:	2480 MHz
Channel 19:	2421 MHz	Channel 39:	2441 MHz	Channel 59:	2461 MHz		

Note:

1. These tests were conducted on a sample of the equipment for the purpose of demonstrating compliance with Part 15 Subpart C Paragraph 15.247 for spread spectrum devices.
2. Regards to the frequency band operation; the lowest , middle and highest frequency of channel were selected to perform the test, then shown on this report.
3. This device is a composite device in accordance with Part 15 paragraph 15.5. The function for the receiver was, measured and made a test report that the report number is 031L033F, certified under verification.
4. Quietek had verified among construction and function in typical operation, then shown in this test report.

1.2. Operational Description

The EUT is an USB interface Bluetooth device with 79 hopping channels.

This device provides wireless technology that revolutionizes personal connectivity. It is the solution for the seamless integration of Bluetooth technology into personal computer enabling short-range wireless connections between desktop/laptop computers, Bluetooth-enabled peripherals (printers, faxes,...), portable handheld devices, and connectivity to the Internet.

1.3. Tested System Details

The types for all equipment, plus descriptions of all cables used in the tested system (including inserted cards) are:

	Product	Manufacturer	Model No.	Serial No.	Power Cord	FCC ID
(1)	Notebook PC	DELL	PP01L	2724903568	Non-shielded, 1.8m	DoC
(2)	Monitor	ADI	CM703	038054T10203875A	Non-shielded, 1.8m	DoC
(3)	Modem	ACEEX	DM-1414	0102027557	Non-shielded, 1.8m	DoC
(4)	Mouse	SYNNES	MW3-P	000120549	Non-shielded, 1.8m	DoC
(5)	Earphone	PRO.2	PH-124	N/A	--	DoC
(6)	Monitor	SONY	PVM-14M2U	2105742	Non-shielded, 1.8m	DoC
(7)	Printer	EPSON	Color 680	023895	Non-shielded, 1.8m	DoC
(8)	Notebook PC	DELL	PP01L	2724903568	Non-shielded, 1.8m	DoC

	Signal Cable Type	Signal Cable Description
A.	VGA Cable	Shielded, 1.8m, with a ferrite core bonded
B.	RS232 Cable	Shielded, 1.5m
C.	PS/2 Cable	Shielded, 1.8m
D.	Audio Cable	Non-Shielded, 1.8m
E.	S-Video Cable	Shielded, 1.5m
F.	Printer Cable	Shielded, 1.5m
G.	Phone line Cable	Non-Shielded, 1.8m
H.	LAN Cable	Non-Shielded, 1.8m

1.4. Configuration of Tested System

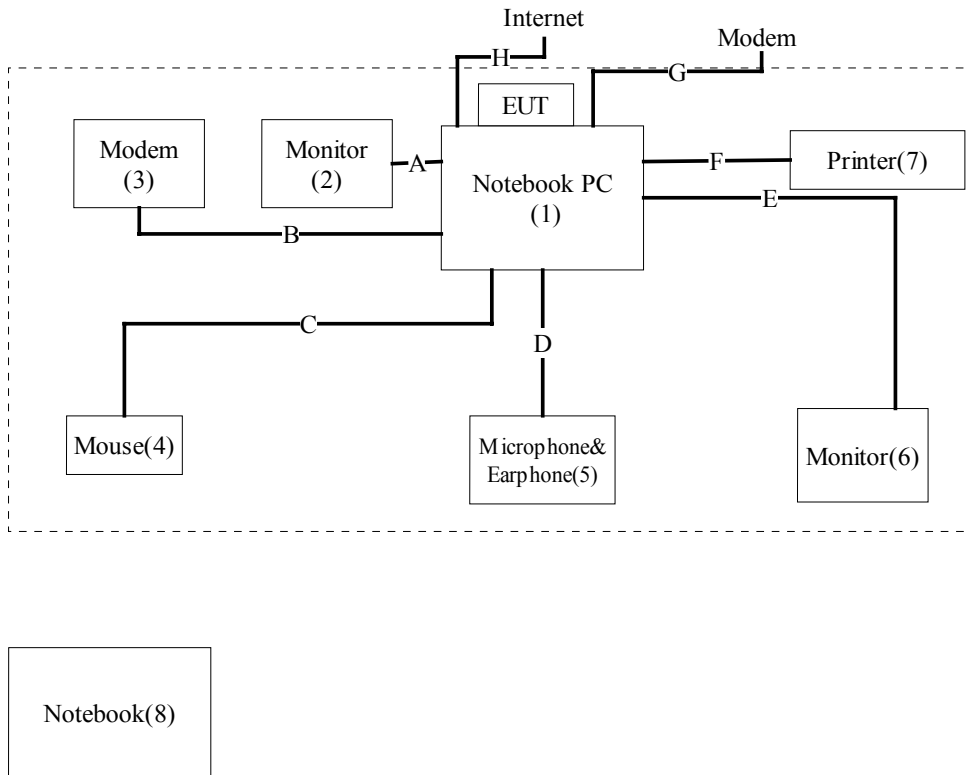

1.5. EUT Exercise Software

- (1) Setup the EUT and simulators as shown on 1.4.
- (2) Turn on the power of all equipment.
- (3) Notebook PC reads data from disk.
- (4) Data will be transmitting through EUT.
- (5) The transmitted status will be shown on the monitor.
- (6) Repeat the above procedure (4) to (5).

1.6. Test Facility

Ambient conditions in the laboratory:

Items	Required (IEC 68-1)	Actual
Temperature (°C)	15-35	20-35
Humidity (%RH)	25-75	50-65
Barometric pressure (mbar)	860-1060	950-1000

Site Description: November 3, 1998 File on
 Federal Communications Commission
 FCC Engineering Laboratory
 7435 Oakland Mills Road
 Columbia, MD 21046
 Reference 31040/SIT1300F2
 August 30, 2001 Accreditation on NVLAP
 NVLAP Lab Code: 200347-0



Site Name: Quietek Corporation

Site Address: No.75-1, Wang-Yeh Valley, Yung-Hsing,
 Chiung-Lin, Hsin-Chu County,
 Taiwan, R.O.C.
 TEL : 886-3-592-8858 / FAX : 886-3-592-8859
 E-Mail: service@quietek.com

2. Conducted Emission

2.1. Test Equipment List

The following test equipment are used during the conducted emission test:

Item	Instrument	Manufacturer	Type No./Serial No	Last Cal.	Remark
1	Test Receiver	R & S	ESCS 30/825442/17	May, 2002	
2	L.I.S.N.	R & S	ESH3-Z5/825016/6	May, 2002	EUT
3	L.I.S.N.	Kyoritsu	KNW-407/8-1420-3	May, 2002	Peripherals
4	Pulse Limiter	R & S	ESH3-Z2	N/A	
5	No. 4 Shielded Room			N/A	

Note: All equipment upon which need to calibrated are with calibration period of 1 year.

2.2. Test Setup

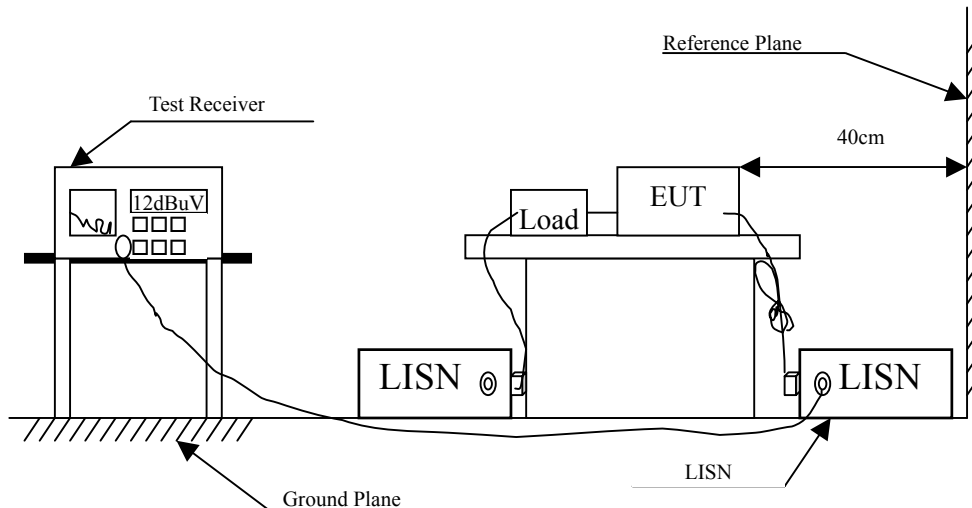

2.3. Limits

FCC Part 15 Paragraph 15.207 (dBuV)		
Frequency MHz	Limits	
	QP	AV
0.15 - 0.50	66-56	56-46
0.50-5.0	56	46
5.0 - 30	60	50

2.4. Test Procedure

The EUT and simulators are connected to the main power through a line impedance stabilization network (L.I.S.N.). This provides a 50 ohm /50uH coupling impedance for the measuring equipment. The peripheral devices are also connected to the main power through a LISN that provides a 50ohm/50uH coupling impedance with 50ohm termination. (Please refers to the block diagram of the test setup and photographs.)

Both sides of A.C. line are checked for maximum conducted interference. In order to find the maximum emission, the relative positions of equipment and all of the interface cables must be changed according to ANSI C63.4:1992 on conducted measurement.

Conducted emissions were investigated over the frequency range from 0.15MHz to 30MHz using a receiver bandwidth of 9kHz.

2.5. Test Result of Conducted Emission

Product : BToes
 Test Item : Conducted Emission Test
 Test Site : No.4 Shielded Room
 Test Mode : Normal Operation

Frequency MHz	Cable Loss dB	LISN Factor dB	Reading Level dBuV	Emission Level dBuV	Limits dBuV
Line 1					
Quasi-Peak:					
*0.182	0.21	0.10	47.30	47.61	64.39
0.240	0.21	0.10	42.02	42.33	62.09
0.303	0.21	0.10	35.32	35.63	60.16
1.575	0.16	0.12	30.68	30.96	56.00
4.969	0.29	0.17	28.33	28.79	56.00
17.849	0.36	0.41	37.03	37.80	60.00
Average					
0.182	0.21	0.10	39.90	40.21	54.39
0.240	0.21	0.10	32.60	32.91	52.10
0.303	0.21	0.10	29.30	29.61	50.16
1.575	0.16	0.12	28.50	28.78	46.00
4.969	0.29	0.17	25.30	25.76	46.00
17.849	0.36	0.41	35.20	35.97	50.00
Line 2					
Quasi-Peak:					
*0.181	0.21	0.10	46.47	46.78	64.43
0.245	0.21	0.10	39.93	40.24	61.94
0.302	0.21	0.10	34.79	35.10	60.18
1.513	0.16	0.12	28.59	28.87	56.00
3.577	0.23	0.16	31.51	31.89	56.00
3.577	0.23	0.16	31.57	31.95	56.00
17.847	0.36	0.41	37.36	38.13	60.00
Average					
0.181	0.21	0.10	38.00	38.31	54.44
0.245	0.21	0.10	33.70	34.01	51.92
0.302	0.21	0.10	28.60	28.91	50.19
1.513	0.16	0.12	26.90	27.18	46.00
3.577	0.23	0.16	24.80	25.18	46.00
17.847	0.36	0.41	35.70	36.47	50.00

Remarks :

1. All Readings below 1GHz are Quasi-Peak value.
2. “ * ” means that this data is the worst emission level.
3. Emission Level = Reading Level + LISN Factor + Cable loss

3. Peak Power Output

3.1. Test Equipment

The following test equipments are used during the radiated emission tests:

Equipment	Manufacturer	Model No./Serial No.	Last Cal.
X Spectrum	Advantest	R3272 / 72421194	May, 2002

Note: 1. All equipment upon which need to calibrated are with calibration period of 1 year.
 2. Mark "X" test instruments are used to measure the final test results.

3.2. Test Setup

Conduction Power Measurement

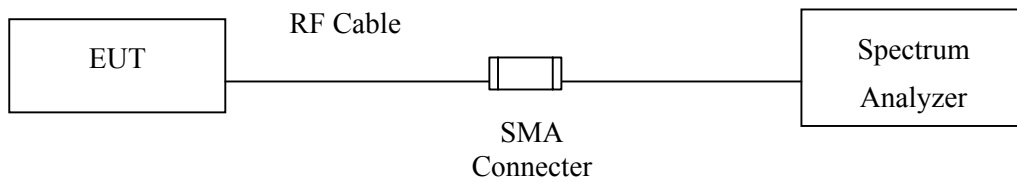

3.3. Test Condition

Standard Temperature and Humidity, Standard Test Voltage

3.4. Limit

The maximum peak power shall be less 1 Watt.

3.5. Test Result of Peak Power Output

Product : BToes
Test Item : Peak Power Output Data
Test Site : No.1 OATS
Test Mode : Normal Operation

Channel No.	Frequency (MHz)	Measurement	Required Limit	Result
Channel 00	2402.04	9.11dBm	1 Watt= 30 dBm	Pass
Channel 39	2440.02	8.73dBm	1 Watt= 30 dBm	Pass
Channel 78	2479.96	9.05dBm	1 Watt= 30 dBm	Pass

Note:

1. Spectrum Analyzer setting: RBW=1MHz=VBW

4. Radiated Emission

4.1. Test Equipment

The following test equipment are used during the radiated emission test:

Test Site	Equipment	Manufacturer	Model No./Serial No.	Last Cal.
Site # 1	X Test Receiver	R & S	ESCS 30 / 825442/14	May, 2002
	X Spectrum Analyzer	Advantest	R3261C / 71720140	May, 2002
	X Pre-Amplifier	HP	8447D/3307A01812	May, 2002
	X Bilog Antenna	Chase	CBL6112B / 12452	Sep., 2002
	X Horn Antenna	EM	EM6917 / 103325	May, 2002
Site # 2	Test Receiver	R & S	ESCS 30 / 825442/17	May, 2002
	Spectrum Analyzer	Advantest	R3261C / 71720609	May, 2002
	Pre-Amplifier	HP	8447D/3307A01814	May, 2002
	Bilog Antenna	Chase	CBL6112B / 2455	Sep., 2002
	Horn Antenna	EM	EM6917 / 103325	May, 2002

- Note:
1. All equipments that need to calibrate are with calibration period of 1 year.
 2. Mark "X" test instruments are used to measure the final test results.

4.2. Test Setup

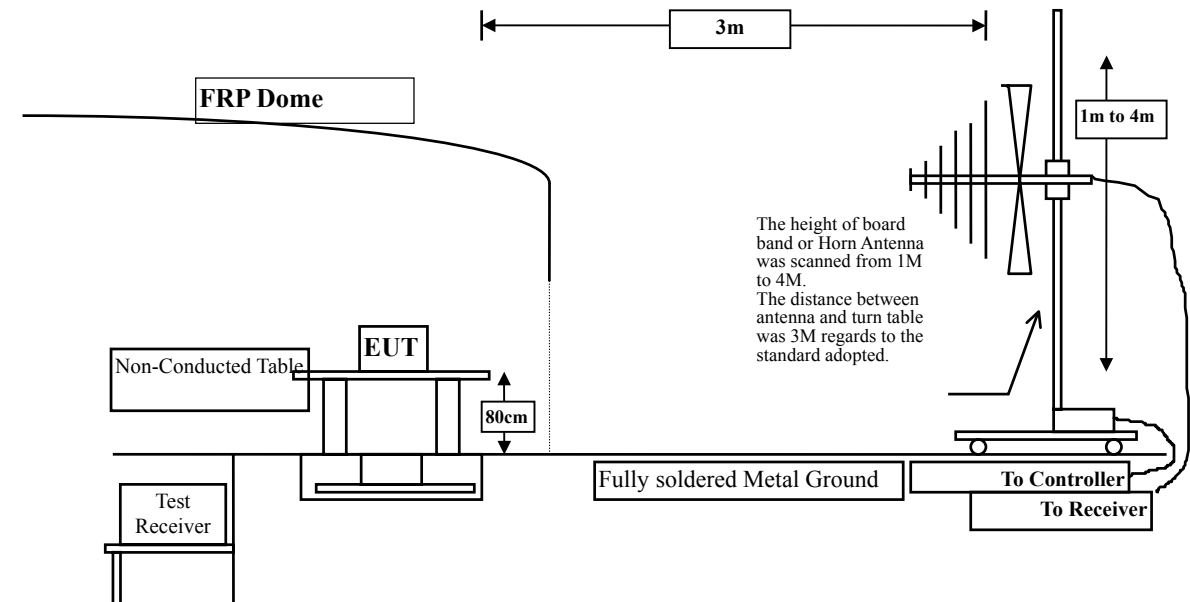

4.3. Test Condition

Standard Temperature and Humidity, Standard Test Voltage

4.4. Limits

➤ **General Radiated Emission Limits**

Emissions radiated outside of the specified frequency bands, except for harmonics, shall be attenuated by at least 20dB below the level of the fundamental or to the general radiated emission limits in paragraph 15.209, whichever is the lesser attenuation.

FCC Part 15 Subpart C Paragraph 15.209(a) Limits		
Frequency MHz	uV/m @3m	dBuV/m@3m
30-88	100	40
88-216	150	43.5
216-960	200	46
Above 960	500	54

- Remarks :
1. RF Voltage (dBuV) = 20 log RF Voltage (uV)
 2. In the Above Table, the tighter limit applies at the band edges.
 3. Distance refers to the distance in meters between the measuring instrument antenna and the closed point of any part of the device or system.

4.5. Test Procedure

The EUT and its simulators are placed on a turn table which is 0.8 meter above ground. The turn table can rotate 360 degrees to determine the position of the maximum emission level. The EUT was positioned such that the distance from antenna to the EUT was 3 meters. The antenna can move up and down between 1 meter and 4 meters to find out the maximum emission level.

Both horizontal and vertical polarization of the antenna are set on measurement. In order to find the maximum emission, all of the interface cables must be manipulated according to ANSI C63.4:1992 on radiated measurement.

The additional latch filter below 1GHz was used to measure the level of harmonics radiated emission during field strength of harmonics measurement.

The bandwidth below 1GHz setting on the field strength meter (R&S Test Receiver ESCS 30)is 120 kHz, above 1GHz are 1 MHz.

The frequency range from 30MHz to 10th harmonics is checked.

4.6. Test Result of Radiated Emission

Product : BToes
 Test Item : Harmonic Radiated Emission Data
 Test Site : No.1 OATS
 Test Mode : Channel 00

Freq.	Cable Loss	Probe Factor	PreAMP	Reading Level	Emission Level	Margin	Limit
MHz	dB	dB/m	dB	dBuV	dBuV/m	dB	dBuV/m

Horizontal

Peak Detector

4804.075	6.15	33.55	28.92	40.27	51.05	22.95	74.00
7206.826	7.31	36.73	28.99	38.26	53.32	20.68	74.00
9608.225	8.70	38.20	28.33	35.35	53.92	20.08	74.00
12010.58	9.93	39.02	16.00	20.00	52.95	21.05	74.00
14412.67	10.65	40.64	17.02	18.99	53.26	20.74	74.00
16814.85	12.25	41.59	16.08	13.75	51.50	22.50	74.00
19218.57	12.70	37.96	17.95	18.27	50.98	23.02	74.00
21619.88	13.01	37.43	18.75	20.27	51.96	22.04	74.00
24022.35	13.62	39.19	19.05	19.11	52.87	21.13	74.00

Vertical

Peak Detector

4808.075	6.17	33.64	28.93	42.27	53.14	20.86	74.00
7206.676	7.31	36.73	28.99	38.41	53.47	20.53	74.00
9608.375	8.70	38.20	28.33	35.31	53.88	20.12	74.00
12011.25	9.93	39.02	16.00	20.59	53.54	20.46	74.00
14414.58	10.65	40.64	17.02	18.61	52.88	21.12	74.00
16814.68	12.25	41.59	16.08	14.11	51.86	22.14	74.00
19216.94	12.70	37.96	17.95	19.31	52.02	21.98	74.00
21617.85	13.01	37.43	18.75	20.29	51.98	22.02	74.00
24022.51	13.62	39.19	19.05	18.12	51.88	22.12	74.00

Note:

1. All Readings below 1GHz are Quasi-Peak, above are average value.
2. Emission Level = Reading Level + Probe Factor + Cable loss-PreAMP.
3. The average measurement was not performed when the peak measured data under the limit of average detection.

Product : BToes
 Test Item : Harmonic Radiated Emission Data
 Test Site : No.1 OATS
 Test Mode : Channel 39

Freq.	Cable Loss	Probe Factor	PreAMP	Reading Level	Emission Level	Margin	Limit
MHz	dB	dB/m	dB	dBuV	dBuV/m	dB	dBuV/m

Horizontal

Peak Detector

4882.676	6.21	33.82	28.96	40.21	51.28	22.72	74.00
7323.826	7.39	36.98	28.96	38.24	53.64	20.36	74.00
9764.976	8.87	38.37	28.10	34.21	53.35	20.65	74.00
12206.35	10.16	39.08	16.31	19.58	52.51	21.49	74.00
14646.38	10.67	39.96	17.87	18.57	51.33	22.67	74.00
17087.51	12.30	43.13	16.29	13.25	52.40	21.60	74.00
19529.60	12.76	37.97	18.19	20.58	53.12	20.88	74.00
21970.55	13.05	37.32	18.80	21.15	52.72	21.28	74.00
24412.89	13.73	39.38	19.10	17.16	51.17	22.83	74.00

Vertical

Peak Detector

4882.526	6.21	33.82	28.96	40.41	51.48	22.52	74.00
7323.225	7.39	36.98	28.96	38.25	53.65	20.35	74.00
9764.826	8.87	38.37	28.10	34.18	53.32	20.68	74.00
12206.32	10.16	39.08	16.31	21.02	53.95	20.05	74.00
14648.02	10.67	39.96	17.87	19.58	52.34	21.66	74.00
17088.53	12.30	43.13	16.29	11.21	50.36	23.64	74.00
19528.27	12.76	37.97	18.19	20.85	53.39	20.61	74.00
21969.09	13.05	37.32	18.80	21.14	52.71	21.29	74.00
24411.68	13.73	39.38	19.10	17.68	51.69	22.31	74.00

Note:

1. All Readings below 1GHz are Quasi-Peak, above are average value.
2. Emission Level = Reading Level + Probe Factor + Cable loss-PreAMP.
3. The average measurement was not performed when the peak measured data under the limit of average detection.

Product : BToes
 Test Item : Harmonic Radiated Emission Data
 Test Site : No.1 OATS
 Test Mode : Channel 78

Freq.	Cable	Probe	PreAMP	Reading	Emission	Margin	Limit
	Loss	Factor		Level	Level		
MHz	dB	dB/m	dB	dBuV	dBuV/m	dB	dBuV/m

Horizontal

Peak Detector

4960.075	6.27	33.95	29.00	40.23	51.45	22.55	74.00
7440.225	7.47	37.26	28.92	36.91	52.71	21.29	74.00
9920.075	9.06	38.52	27.90	34.00	53.69	20.31	74.00
12401.36	10.38	39.16	16.11	19.57	53.00	21.00	74.00
14882.69	10.69	39.20	17.10	20.36	53.16	20.84	74.00
17361.84	12.36	44.97	16.51	11.57	52.38	21.62	74.00
19840.98	12.82	37.97	18.44	19.56	51.91	22.09	74.00
22321.59	13.14	37.48	18.84	20.51	52.29	21.71	74.00
24800.67	13.84	39.59	19.14	19.62	53.91	20.09	74.00

Vertical

Peak Detector

4882.676	6.21	33.82	28.96	40.21	51.28	22.72	74.00
7323.826	7.39	36.98	28.96	38.24	53.64	20.36	74.00
9764.976	8.87	38.37	28.10	34.21	53.35	20.65	74.00
12206.35	10.16	39.08	16.31	19.58	52.51	21.49	74.00
14646.38	10.67	39.96	17.87	18.57	51.33	22.67	74.00
17087.51	12.30	43.13	16.29	13.25	52.40	21.60	74.00
19529.60	12.76	37.97	18.19	20.58	53.12	20.88	74.00
21970.55	13.05	37.32	18.80	21.15	52.72	21.28	74.00
24412.89	13.73	39.38	19.10	17.16	51.17	22.83	74.00

Note:

1. All Readings below 1GHz are Quasi-Peak, above are average value.
2. Emission Level = Reading Level + Probe Factor + Cable loss-PreAMP.
3. The average measurement was not performed when the peak measured data under the limit of average detection.

Product : BToes
 Test Item : General Radiated Emission Data
 Test Site : No.1 OATS
 Test Mode : Channel 00

Freq.	Cable	Probe	PreAMP	Reading	Emission	Margin	Limit
MHz	Loss	Factor		Level	Level		
	dB	dB/m	dB	dBuV	dBuV/m	dB	dBuV/m
Horizontal:							
72.596	1.09	6.64	0.00	11.56	19.29	20.71	40.00
132.480	1.40	11.49	0.00	6.20	19.09	24.41	43.50
146.290	1.47	10.56	0.00	8.59	20.61	22.89	43.50
196.275	1.73	8.20	0.00	7.49	17.42	26.08	43.50
206.580	1.78	8.41	0.00	10.34	20.53	22.97	43.50
*334.580	2.44	12.56	0.00	10.68	25.68	20.32	46.00

Vertical:							
64.875	1.05	5.93	0.00	12.35	19.33	20.67	40.00
118.590	1.32	10.49	0.00	7.56	19.38	24.12	43.50
129.420	1.38	10.59	0.00	6.95	18.93	24.57	43.50
174.593	1.61	8.52	0.00	9.50	19.63	23.87	43.50
222.684	1.86	9.05	0.00	8.24	19.15	26.85	46.00
*396.254	2.76	15.89	0.00	7.23	25.88	20.12	46.00

Note:

1. All Readings below 1GHz are Quasi-Peak, above are average value.
2. “ * ”, means this data is the worst emission level.
3. Emission Level = Reading Level + Probe Factor + Cable loss- Pre Amp.

Product : BToes
 Test Item : General Radiated Emission Data
 Test Site : No.1 OATS
 Test Mode : Channel 39

Freq.	Cable	Probe	PreAMP	Reading	Emission	Margin	Limit
MHz	Loss	Factor		Level	Level		
	dB	dB/m	dB	dBuV	dBuV/m	dB	dBuV/m
Horizontal:							
84.960	1.15	8.68	0.00	8.92	18.76	21.24	40.00
116.257	1.31	11.96	0.00	6.58	19.85	23.65	43.50
146.912	1.47	10.64	0.00	6.59	18.71	24.79	43.50
172.640	1.60	8.69	0.00	8.94	19.24	24.26	43.50
226.670	1.88	9.08	0.00	10.28	21.24	24.76	46.00
*271.980	2.12	11.73	0.00	12.67	26.52	19.48	46.00

Vertical:							
108.673	1.27	10.65	0.00	5.64	17.56	25.94	43.50
144.530	1.46	9.86	0.00	8.46	19.77	23.73	43.50
156.790	1.52	8.83	0.00	7.92	18.28	25.22	43.50
216.840	1.83	9.26	0.00	7.64	18.73	27.27	46.00
*288.648	2.20	12.29	0.00	9.13	23.63	22.37	46.00
516.260	3.37	16.59	0.00	2.37	22.33	23.67	46.00

Note:

1. All Readings below 1GHz are Quasi-Peak, above are average value.
2. “ * ”, means this data is the worst emission level.
3. Emission Level = Reading Level + Probe Factor + Cable loss- Pre Amp.

Product : BToes
 Test Item : General Radiated Emission Data
 Test Site : No.1 OATS
 Test Mode : Channel 78

Freq.	Cable	Probe	PreAMP	Reading	Emission	Margin	Limit
MHz	Loss	Factor		Level	Level		
	dB	dB/m	dB	dBuV	dBuV/m	dB	dBuV/m

Horizontal:

52.490	0.98	6.64	0.00	7.68	15.30	24.70	40.00
*86.297	1.16	8.78	0.00	10.37	20.31	19.69	40.00
133.640	1.40	11.39	0.00	6.45	19.24	24.26	43.50
184.570	1.66	8.02	0.00	9.57	19.26	24.24	43.50
202.954	1.76	8.54	0.00	11.57	21.87	21.63	43.50
280.674	2.16	12.02	0.00	11.68	25.86	20.14	46.00

Vertical:

33.700	0.89	17.04	0.00	6.17	24.10	15.90	40.00
*43.500	0.94	9.57	0.00	14.27	24.78	15.22	40.00
128.800	1.38	10.53	0.00	8.19	20.10	23.40	43.50
153.200	1.50	8.93	0.00	10.86	21.30	22.20	43.50
166.900	1.57	8.47	0.00	13.16	23.20	20.30	43.50
344.160	2.49	12.82	0.00	9.81	25.12	20.88	46.00

Note:

1. All Readings below 1GHz are Quasi-Peak, above are average value.
2. “ * ”, means this data is the worst emission level.
3. Emission Level = Reading Level + Probe Factor + Cable loss- Pre Amp.

5. Band Edge

5.1. Test Equipment

The following test equipments are used during the band edge tests:

	Equipment	Manufacturer	Model No./Serial No.	Last Cal.
X	Spectrum Analyzer	Advantest	R3272 / 72421194	May, 2002
X	Test Receiver	R & S	ESCS 30 / 825442/14	May, 2002
X	Spectrum Analyzer	Advantest	R3261C / 71720140	May, 2002
X	Pre-Amplifier	HP	8447D/3307A01812	May, 2002
X	Bilog Antenna	Chase	CBL6112B / 12452	Sep., 2002
X	Horn Antenna	EM	EM6917 / 103325	May, 2002

- Note:
1. All equipments that need to calibrate are with calibration period of 1 year.
 2. Mark "X" test instruments are used to measure the final test results.

5.2. Test Setup

RF Conducted Measurement:

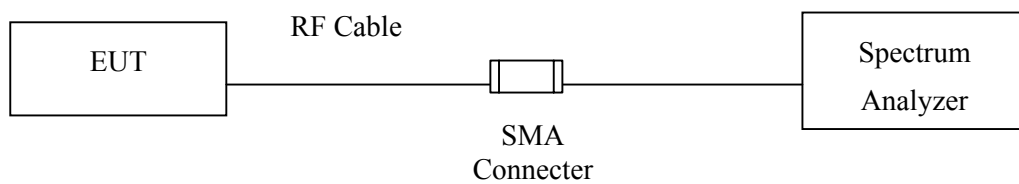

RF Radiated Measurement:

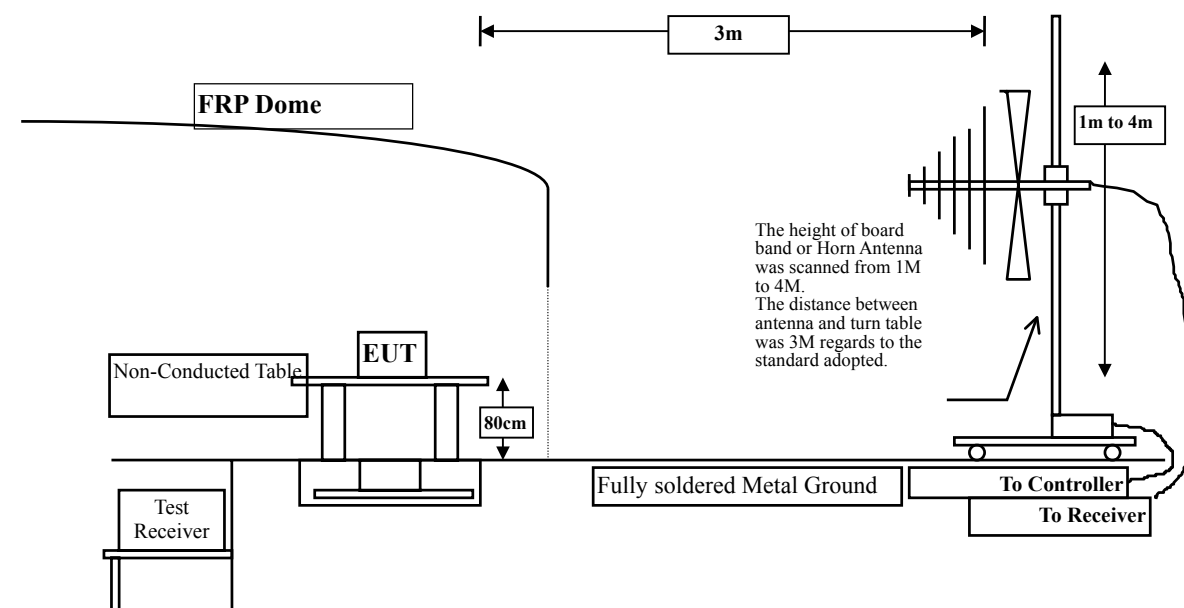

5.3. Test Condition

Standard Temperature and Humidity, Standard Test Voltage

5.4. Limit

In any 100 kHz bandwidth outside the frequency band in which the spread spectrum intentional radiator is operating, the radio frequency power that is produced by the intentional radiator shall be at least 20 dB below that in the 100 kHz bandwidth within the band that contains the highest level of the desired power, based on either an RF conducted or a radiated measurement. Attenuation below the general limits specified in Section 15.209(a) is not required. In addition, radiated emissions which fall in the restricted bands, as defined in Section 15.205(a), must also comply with the radiated emission limits specified in Section 15.209(a) (see Section 15.205(c)).

5.5. Test Result of Band Edge

Product : BToes
 Test Item : Band Edge Data
 Test Site : No.1 OATS
 Test Mode : Channel 00

RF Radiated Measurement:

Polarization	Frequency (MHz)	Required Limit (dBc)	Result
Horizontal	<2400	>20	Pass
Vertical	<2400	>20	Pass

Figure Channel 00: (Horizontal)

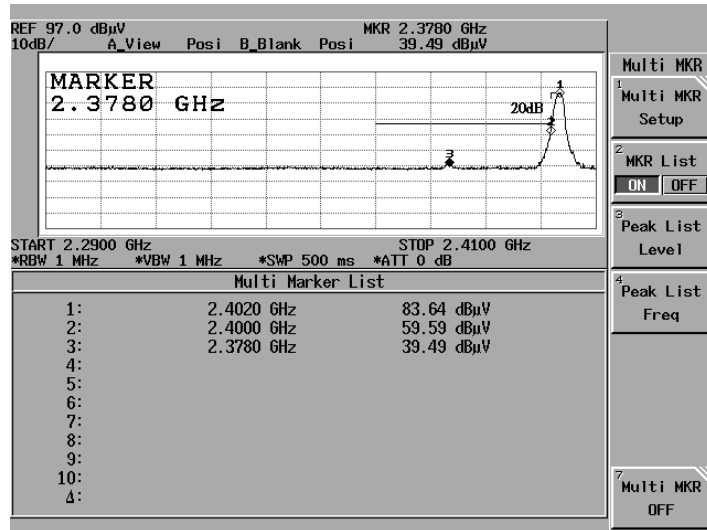
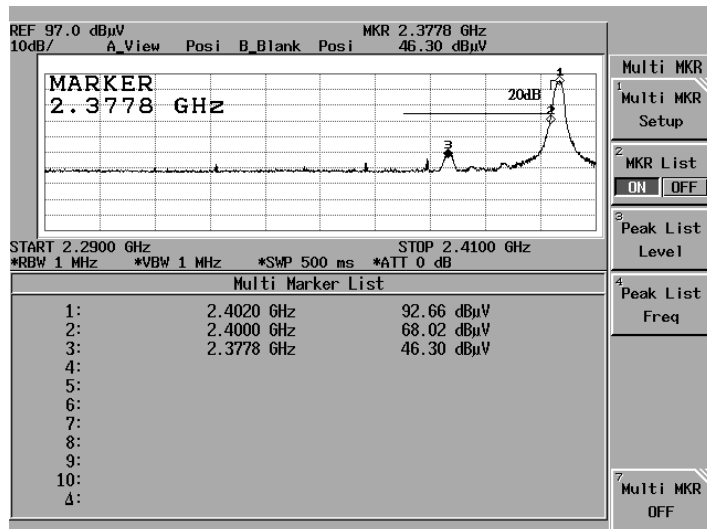

Figure Channel 00: (Vertical)



Product : BToes
 Test Item : Band Edge Data
 Test Site : No.1 OATS
 Test Mode : Channel 78

RF Radiated Measurement:

Polarization	Frequency (MHz)	Reading Level (dBuV)	Emission Level (dBuV/m)	Limit (dBuV/m)	Result
Horizontal	2484.14	39.95	42.90	74	Pass
Vertical	2491.67	40.66	43.61	74	Pass

Figure Channel 78:

(Horizontal)

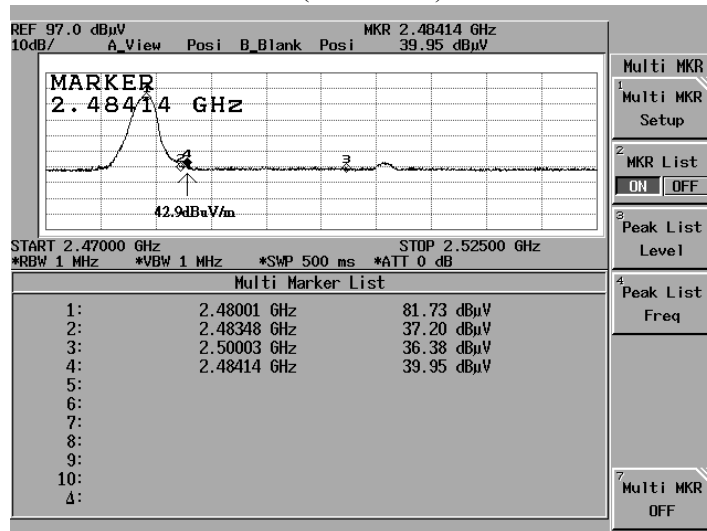
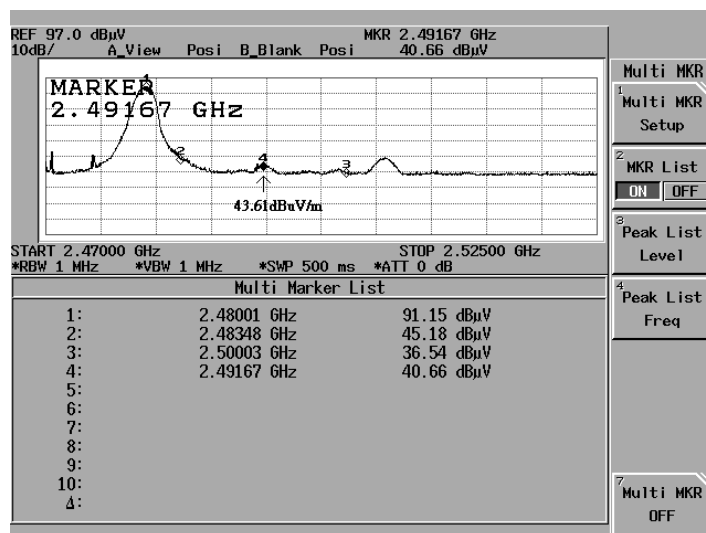

Figure Channel 78:

(Vertical)



6. Occupied Bandwidth

6.1. Test Equipment

The following test equipments are used during the radiated emission tests:

	Equipment	Manufacturer	Model No./Serial No.	Last Cal.
X	Spectrum	Advantest	R3272 / 72421194	May, 2002

Note: 1. All equipment upon which need to calibrated are with calibration period of 1 year.
 2. Mark "X" test instruments are used to measure the final test results.

6.2. Test Setup

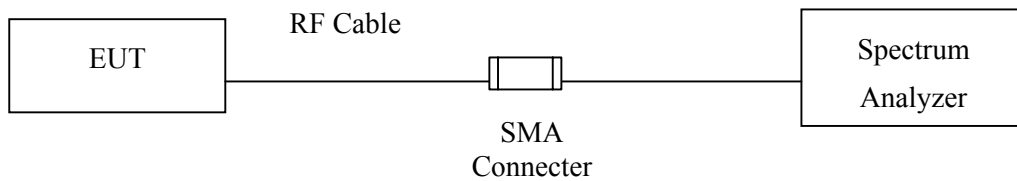

6.3. Test Condition

Standard Temperature and Humidity, Standard Test Voltage

6.4. Limit

The maximum 20 dB bandwidth of the hopping channel is 1 MHz.

6.5. Test Result of Occupied Bandwidth

Product : BToes
 Test Item : Occupied Bandwidth Data
 Test Site : No.1 OATS
 Test Mode : Normal Operation

Channel No.	Frequency (MHz)	Measurement Level (MHz)	Required Limit (MHz)	Result
00	2401.980	0.38	<1	Pass
39	2439.975	0.37	<1	Pass
78	2479.980	0.37	<1	Pass

Channel 00

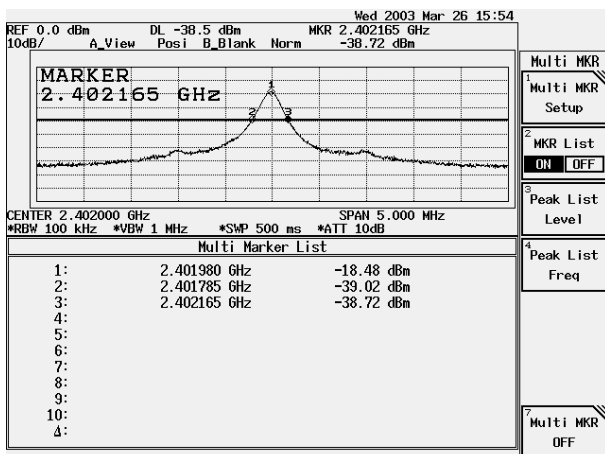

Channel 39

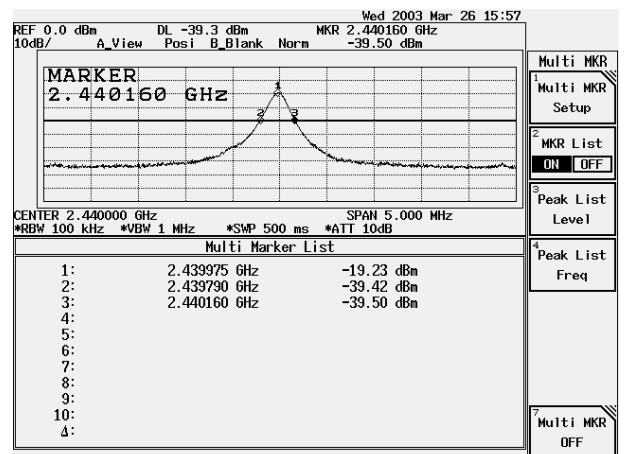

Channel 78:

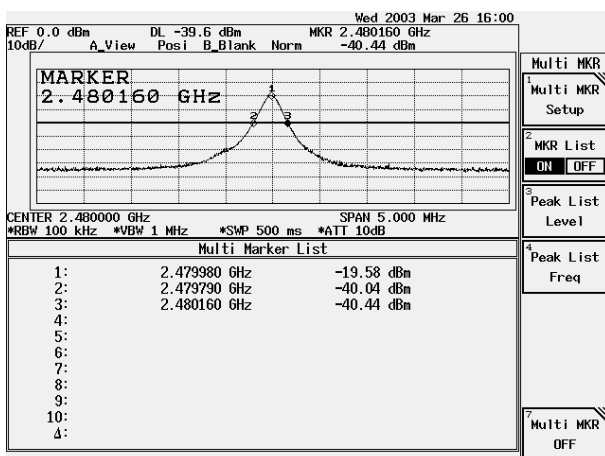

7. Channel of Number

7.1. Test Equipment

The following test equipments are used during the radiated emission tests:

	Equipment	Manufacturer	Model No./Serial No.	Last Cal.
X	Spectrum	Advantest	R3272 / 72421194	May, 2002

Note: 1. All equipment upon which need to calibrated are with calibration period of 1 year.
 2. Mark "X" test instruments are used to measure the final test results.

7.2. Test Setup

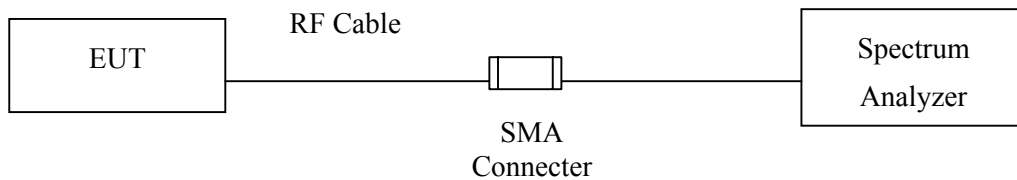

7.3. Test Condition

Standard Temperature and Humidity, Standard Test Voltage

7.4. Limit

Frequency hopping systems operating in the 2400-2483.5 MHz bands shall use at least 75 hopping frequencies.

7.5. Test Result of Channel Number

Product : BToes
 Test Item : Sweep of Channel Number
 Test Site : No.1 OATS
 Test Mode : Normal Operation

Frequency Range (MHz)	Measurement (Hopping Channel)	Required Limit (Hopping Channel)	Result
2402 ~ 2480	79	>75	Pass

2402-2411MHz

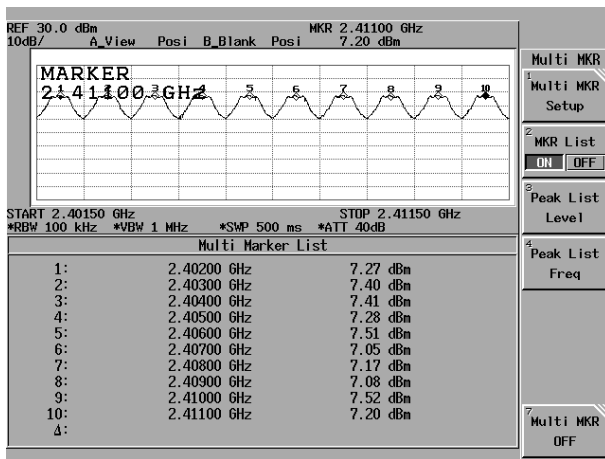

2412-2421MHz

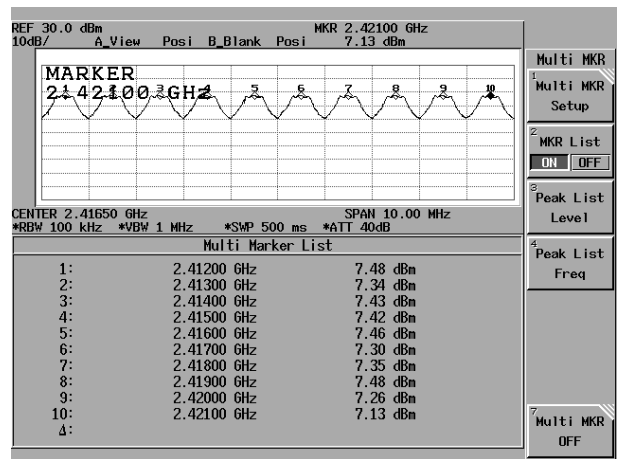

2422-2431MHz

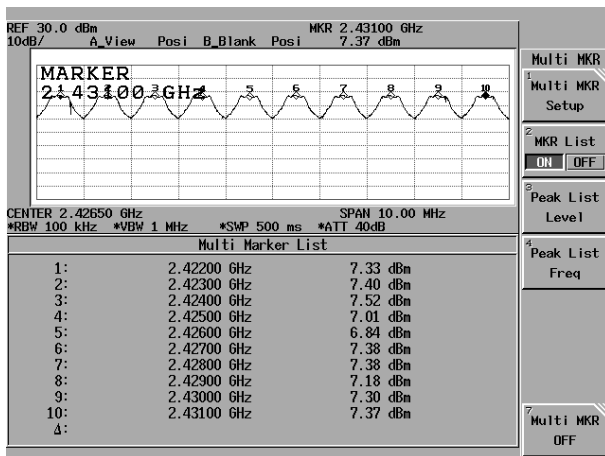

2432-2441MHz

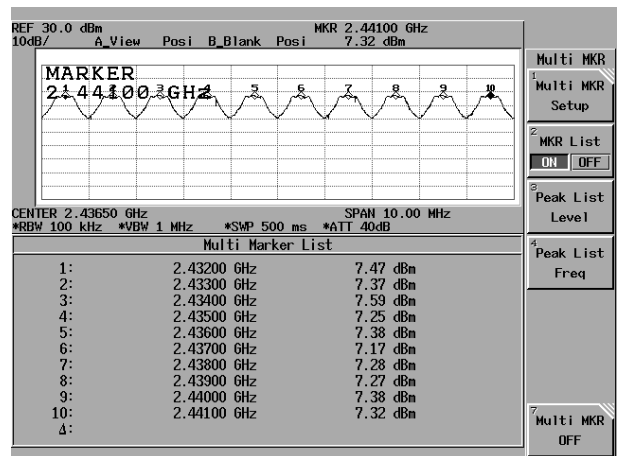

Product : BToes
 Test Item : Sweep of Channel Number
 Test Site : No.1 OATS
 Test Mode : Normal Operation

2442-2451MHz

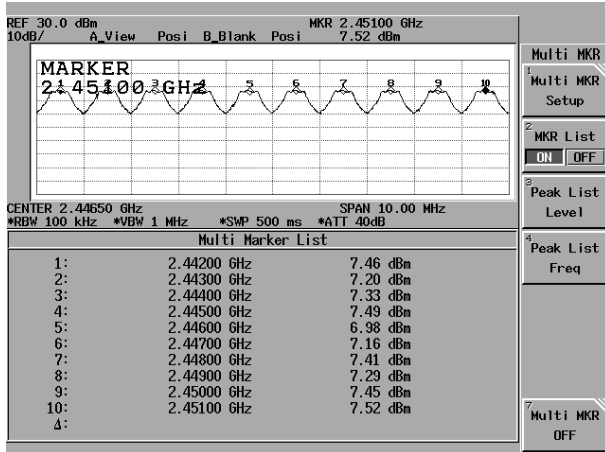

2452-2461MHz

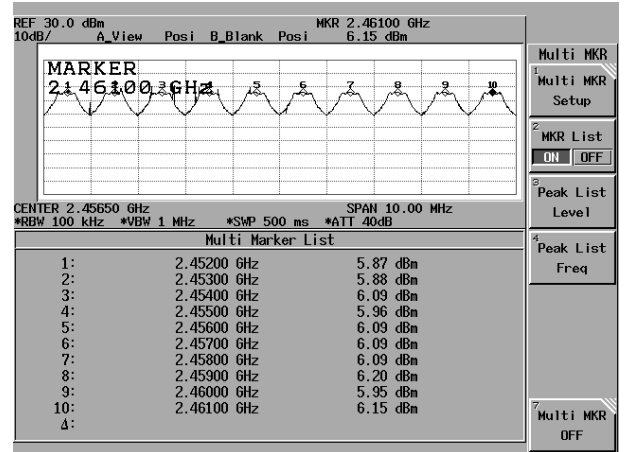

2462-2471MHz

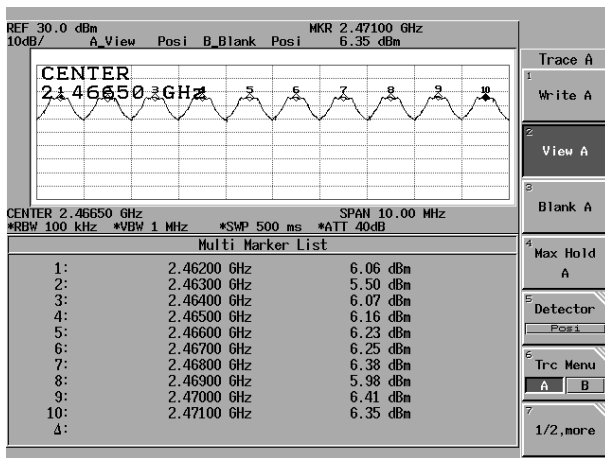

2472-2480MHz

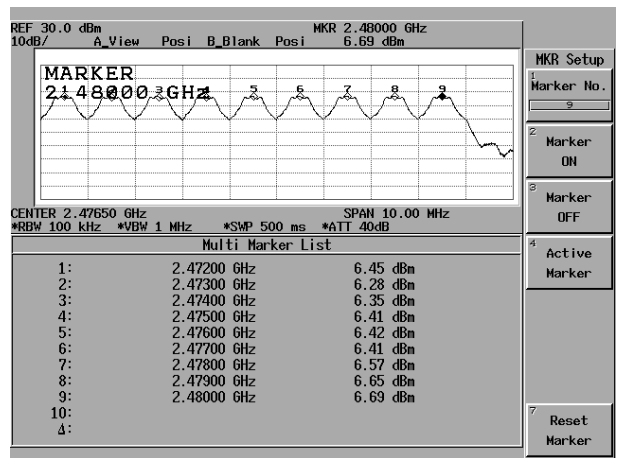

8. Channel Separation

8.1. Test Equipment

The following test equipments are used during the radiated emission tests:

	Equipment	Manufacturer	Model No./Serial No.	Last Cal.
X	Spectrum	Advantest	R3272 / 72421194	May, 2002

Note: 1. All equipment upon which need to calibrated are with calibration period of 1 year.
 2. Mark "X" test instruments are used to measure the final test results.

8.2. Test Setup

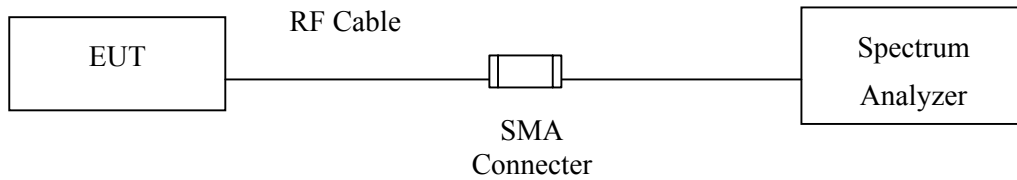

8.3. Test Condition

Standard Temperature and Humidity, Standard Test Voltage

8.4. Limit

Frequency hopping systems shall have hopping channel carrier frequencies separated by a minimum of 25 kHz or the 20 dB bandwidth of the hopping channel, whichever is greater.

8.5. Test Result of Channel Separation

Product : BToes
 Test Item : Channel Separation Data
 Test Site : No.1 OATS
 Test Mode : Normal Operation

Measurement Level (MHz)	Required Limit (kHz)	Result
0.995	>25	Pass

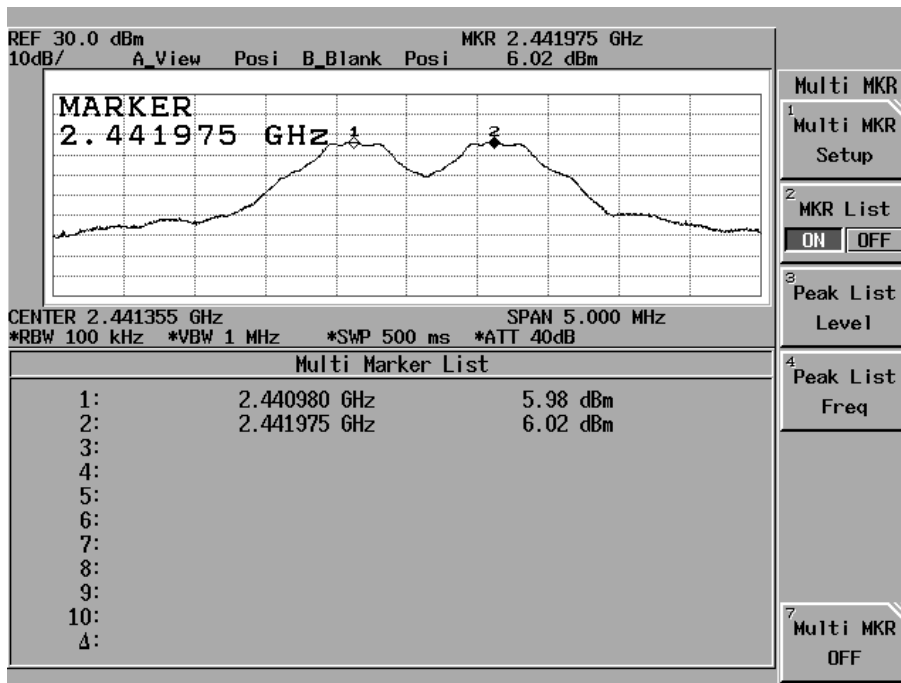

9. Dwell Time

9.1. Test Equipment

The following test equipments are used during the radiated emission tests:

	Equipment	Manufacturer	Model No./Serial No.	Last Cal.
X	Spectrum	Advantest	R3272 / 72421194	May, 2002

Note: 1. All equipment upon which need to calibrated are with calibration period of 1 year.
 2. Mark "X" test instruments are used to measure the final test results.

9.2. Test Setup

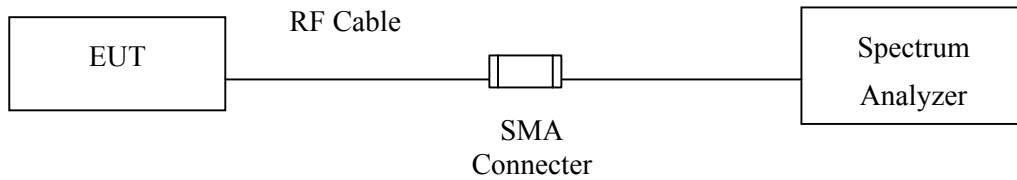

9.3. Test Condition

Standard Temperature and Humidity, Standard Test Voltage

9.4. Limit

The dwell time shall be the average time of occupancy on any frequency shall not be greater than 0.4 seconds within a 30 second period.

9.5. Test Result of Dwell Time

Product : BToes
 Test Item : Dwell Time Data
 Test Site : No.1 OATS
 Test Mode : Normal Operation

Channel No.	Measurement Level (ms)	Required Limit (Sec)	Result
00	255.999 (ms)	<0.4 (sec)	Pass
39	255.999 (ms)	<0.4 (sec)	Pass
78	255.999 (ms)	<0.4 (sec)	Pass

2402MHz

2441MHz

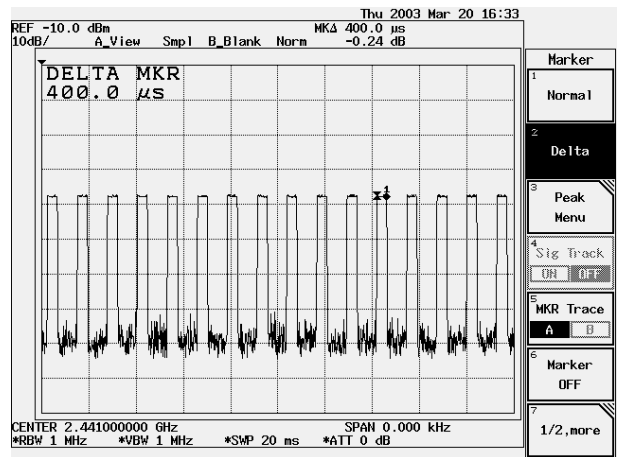
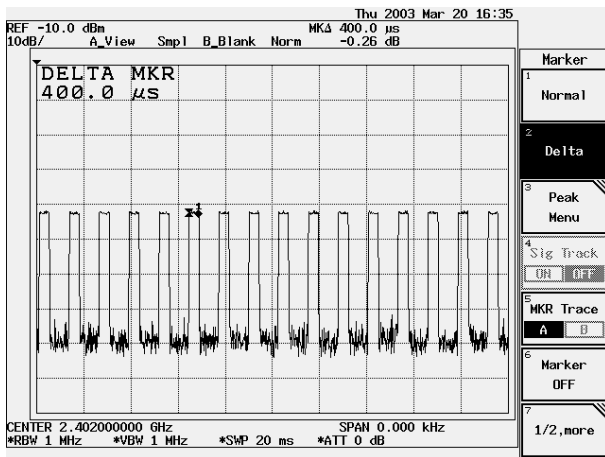

Z

2480MHz

40Ch

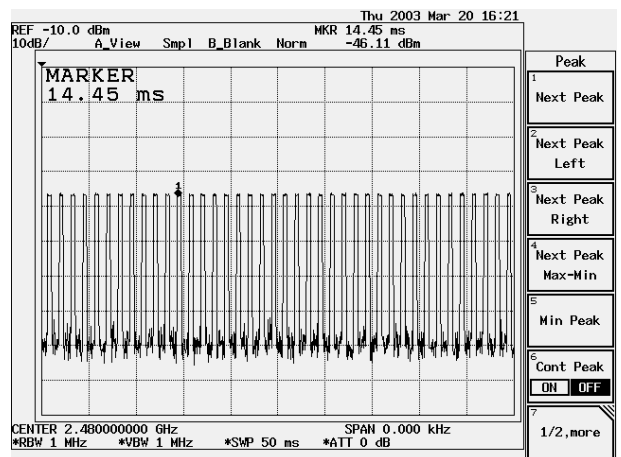
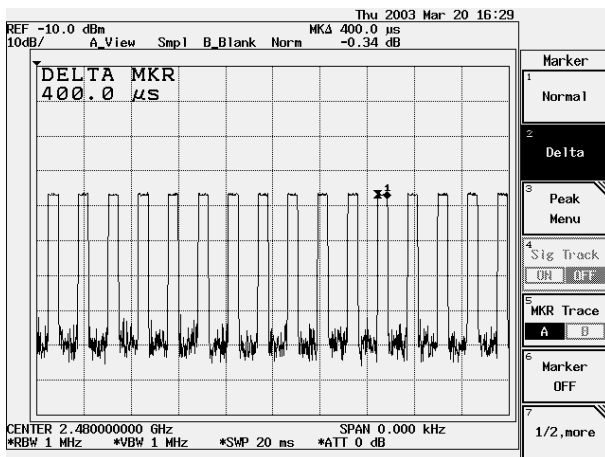

10. EMI Reduction Method During Compliance Testing

No modification was made during testing.

Attachment 1: EUT Test Photographs

Attachment 2: EUT Detailed Photographs