

# FC

## Test Report

Product Name	FS-510
Model No.	MS-6872
FCC ID.	I4L-MS6872

Applicant	MICRO-STAR INTL Co., LTD.
Address	No. 69, Li-De St., Jung-He City, Taipei Hsien, Taiwan, R.O.C.

Date of Receipt	June 09, 2006
Issued Date	June 28, 2006
Report No.	066L091-RF-US-P06V01

The Test Results relate only to the samples tested.

The test report shall not be reproduced except in full without the written approval of Quietek Corporation.

This report must not be used to claim product endorsement by NVLAP any agency of the U.S. Government

# Test Report Certification

Issued Date: June 28, 2006

Report No.: 066L091-RF-US-P06V01



Product Name	FS-510
Applicant	MICRO-STAR INTL Co., LTD.
Address	No. 69, Li-De St., Jung-He City, Taipei Hsien, Taiwan, R.O.C.
Manufacturer	MICRO-STAR INTL Co., LTD.
Model No.	MS-6872
FCC ID.	I4L-MS6872
Rated Voltage	AC 120V/60Hz
Working Voltage	DC5V
Trade Name	MSI
Applicable Standard	FCC CFR Title 47 Part 15 Subpart C: 2005 ANSI C63.4: 2003 CISPR 22: 2005
Test Result	Complied



The Test Results relate only to the samples tested.  
 The test report shall not be reproduced except in full without the written approval of Quietek Corporation.  
 This report must not be used to claim product endorsement by NVLAP any agency of the U.S. Government

Documented By : Rita Huang  
 ( Rita Huang )



Tested By : Dino Chen  
 ( Dino Chen )

Approved By : Gene Chang  
 ( Gene Chang )



## TABLE OF CONTENTS

Description	Page
<b>1. GENERAL INFORMATION .....</b>	<b>5</b>
1.1. EUT Description .....	5
1.2. Operational Description .....	7
1.3. Test System Details .....	8
1.4. Configuration of Test System .....	8
1.5. EUT Exercise Software .....	8
1.6. Test Facility .....	9
<b>2. CONDUCTED EMISSION .....</b>	<b>10</b>
2.1. Test Equipment .....	10
2.2. Test Setup .....	10
2.3. Limits .....	11
2.4. Test Procedure .....	11
2.5. Uncertainty .....	11
2.6. Test Result of Conducted Emission .....	12
<b>3. PEAK POWER OUTPUT .....</b>	<b>14</b>
3.1. Test Equipment .....	14
3.2. Test Setup .....	14
3.3. Limit .....	14
3.4. Uncertainty .....	14
3.5. Test Result of Peak Power Output .....	15
<b>4. RADIATED EMISSION .....</b>	<b>16</b>
4.1. Test Equipment .....	16
4.2. Test Setup .....	17
4.3. Limits .....	17
4.4. Test Procedure .....	18
4.5. Uncertainty .....	18
4.6. Test Result of Radiated Emission .....	19
<b>5. BAND EDGE .....</b>	<b>23</b>
5.1. Test Equipment .....	23
5.2. Test Setup .....	23
5.3. Limit .....	24
5.4. Test Procedure .....	24
5.5. Uncertainty .....	24
5.6. Test Result of Band Edge .....	25
<b>6. CHANNEL NUMBER.....</b>	<b>29</b>
6.1. Test Equipment .....	29

---

6.2.	Test Setup .....	29
6.3.	Limit .....	29
6.4.	Uncertainty .....	29
6.5.	Test Result of Channel Number.....	30
<b>7.</b>	<b>CHANNEL SEPARATION.....</b>	<b>31</b>
7.1.	Test Equipment .....	31
7.2.	Test Setup .....	31
7.3.	Limit .....	31
7.4.	Uncertainty .....	31
7.5.	Test Result of Channel Separation.....	32
<b>8.</b>	<b>DWELL TIME.....</b>	<b>33</b>
8.1.	Test Equipment .....	33
8.2.	Test Setup .....	33
8.3.	Limit .....	33
8.4.	Uncertainty .....	33
8.5.	Test Result of Dwell Time.....	34
<b>9.</b>	<b>OCCUPIED BANDWIDTH .....</b>	<b>40</b>
9.1.	Test Equipment .....	40
9.2.	Test Setup .....	40
9.3.	Limits.....	40
9.4.	Uncertainty .....	40
9.5.	Test Result of Occupied Bandwidth .....	41
<b>10.</b>	<b>EMI REDUCTION METHOD DURING COMPLIANCE TESTING .....</b>	<b>44</b>

Attachment 1: EUT Test Photographs  
Attachment 2: EUT Detailed Photographs

## 1. GENERAL INFORMATION

### 1.1. EUT Description

Product Name	FS-510
Trade Name	MSI
FCC ID.	I4L-MS6872
Model No.	MS-6872
Frequency Range	2402 - 2480MHz
Channel Number	79
Type of Modulation	FHSS
Antenna Type	Chip Antenna
Channel Control	Auto
Antenna Gain	Refer to the table "Antenna List"

#### Antenna List

No.	Manufacturer	Part No.	Peak Gain
1	YAGEO	CAN4311153002401K	4dBi for 2.4 GHz

Frequency of Each Channel:

Channel 00:	2402 MHz	Channel 20:	2422 MHz	Channel 40:	2442 MHz	Channel 60:	2462 MHz
Channel 01:	2403 MHz	Channel 21:	2423 MHz	Channel 41:	2443 MHz	Channel 61:	2463 MHz
Channel 02:	2404 MHz	Channel 22:	2424 MHz	Channel 42:	2444 MHz	Channel 62:	2464 MHz
Channel 03:	2405 MHz	Channel 23:	2425 MHz	Channel 43:	2445 MHz	Channel 63:	2465 MHz
Channel 04:	2406 MHz	Channel 24:	2426 MHz	Channel 44:	2446 MHz	Channel 64:	2466 MHz
Channel 05:	2407 MHz	Channel 25:	2427 MHz	Channel 45:	2447 MHz	Channel 65:	2467 MHz
Channel 06:	2408 MHz	Channel 26:	2428 MHz	Channel 46:	2448 MHz	Channel 66:	2468 MHz
Channel 07:	2409 MHz	Channel 27:	2429 MHz	Channel 47:	2449 MHz	Channel 67:	2469 MHz
Channel 08:	2410 MHz	Channel 28:	2430 MHz	Channel 48:	2450 MHz	Channel 68:	2470 MHz
Channel 09:	2411 MHz	Channel 29:	2431 MHz	Channel 49:	2451 MHz	Channel 69:	2471 MHz
Channel 10:	2412 MHz	Channel 30:	2432 MHz	Channel 50:	2452 MHz	Channel 70:	2472 MHz
Channel 11:	2413 MHz	Channel 31:	2433 MHz	Channel 51:	2453 MHz	Channel 71:	2473 MHz
Channel 12:	2414 MHz	Channel 32:	2434 MHz	Channel 52:	2454 MHz	Channel 72:	2474 MHz
Channel 13:	2415 MHz	Channel 33:	2435 MHz	Channel 53:	2455 MHz	Channel 73:	2475 MHz
Channel 14:	2416 MHz	Channel 34:	2436 MHz	Channel 54:	2456 MHz	Channel 74:	2476 MHz
Channel 15:	2417 MHz	Channel 35:	2437 MHz	Channel 55:	2457 MHz	Channel 75:	2477 MHz
Channel 16:	2418 MHz	Channel 36:	2438 MHz	Channel 56:	2458 MHz	Channel 76:	2478 MHz
Channel 17:	2419 MHz	Channel 37:	2439 MHz	Channel 57:	2459 MHz	Channel 77:	2479 MHz
Channel 18:	2420 MHz	Channel 38:	2440 MHz	Channel 58:	2460 MHz	Channel 78:	2480 MHz
Channel 19:	2421 MHz	Channel 39:	2441 MHz	Channel 59:	2461 MHz		

The system receivers have input bandwidths that match the hopping channel bandwidths of their corresponding transmitters and shift frequencies in synchronization with the transmitted signals

Frequency hopping spread spectrum systems are not required to employ all available hopping channels during each transmission. The transmitter is presented with a continuous data stream. In addition, a system employing short transmission bursts must comply with the definition of a frequency hopping system and must distribute its 79 channels and over the minimum number of hopping channels (75 channels).

The incorporation of intelligence within a frequency hopping spread spectrum system that permits the system to recognize other users within the spectrum band so that it individually and independently chooses and adapts its hopsets to avoid hopping on occupied channels is permitted. The coordination of frequency hopping systems in any other manner for the express purpose of avoiding the simultaneous occupancy of individual hopping frequencies by multiple transmitters is not permitted.

Note:

1. The EUT is FS-510 with a built-in 2.4GHz transceiver.
2. These tests were conducted on a sample of the equipment for the purpose of demonstrating compliance with Part 15 Subpart C Paragraph 15.247 for spread spectrum devices.
3. Regarding to the operation frequency band, the lowest, middle, and highest frequency are selected to perform the test.
4. QuieTek verified constructions and functions, which are shown in the test report, in typical operation.

## 1.2. Operational Description

The EUT is a FS-510 with a built-in 2.4GHz transceiver. The signals are modulated by frequency hopping spread spectrum. The number of channels is 79 in 2402-2480MHz.

The EUT provides wireless technology that revolutionizes personal connectivity. It is the solution for the seamless integration of Bluetooth technology into personal computer enabling short-range wireless connections between desktop/laptop computers, Bluetooth-enabled peripherals, and portable handheld devices.

Test Mode	Mode 1: Transmitter
-----------	---------------------

### 1.3. Test System Details

The types for all equipment, plus descriptions of all cables used in the tested system (including inserted cards) are:

	Product	Manufacturer	Model No.	Serial No.	Power Cord
(1)	Notebook PC	DELL	PPT	N/A	Non-Shielded, 0.8m

	Signal Cable Type	Signal cable Description
A.	RS-232 Cable	Shielded, 1.5m
B.	USB Cable	Shielded, 1.5m

### 1.4. Configuration of Test System

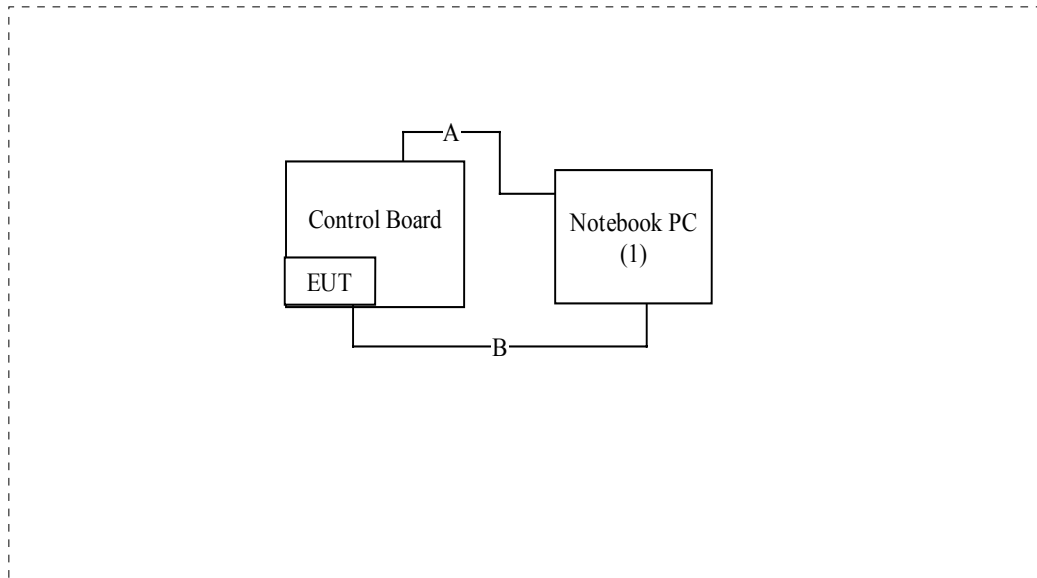

### 1.5. EUT Exercise Software

- (1) Setup the EUT as shown in Section 1.4.
- (2) Connect the EUT to the notebook via a control board, a RS232 cable, and a USB cable.
- (3) Execute the BlueTest program on the notebook.
- (4) Setup the test channel and the packet type.
- (5) Press OK to start the continuous transmission.
- (6) Verify the EUT operation properly.



**1.6. Test Facility**

Ambient conditions in the laboratory:

Items	Required (IEC 68-1)	Actual
Temperature (°C)	15-35	20-35
Humidity (%RH)	25-75	30-65
Barometric pressure (mbar)	860-1060	950-1000

Site Description: Federal Communications Commission  
 FCC Engineering Laboratory  
 7435 Oakland Mills Road  
 Columbia, MD 21046  
 Reference 31040/SIT1300F2  
 NVLAP Lab Code: 200533-0



Site Name: Quietek Corporation  
 Site Address: No. 5-22, Ruei-Shu Valley, Ruei-Ping Tsuen,  
 Lin-Kou Shiang, Taipei,  
 Taiwan, R.O.C.  
 TEL: 886-2-8601-3788 / FAX : 886-2-8601-3789  
 E-Mail : [service@quietek.com](mailto:service@quietek.com)



## 2. Conducted Emission

### 2.1. Test Equipment

Item	Instrument	Manufacturer	Type No./Serial No	Last Cal.	Remark
1	EMI Test Receiver	R&S	ESCS 30/100367	Aug, 2005	
2	LISN	R&S	ESH3-Z5/836679/023	July, 2005	EUT
3	LISN	R&S	ESH3-Z5/836679/017	Feb, 2006	Peripherals
4	Pulse Limiter	R&S	ESH3-Z2/357.8810.52	Sep, 2005	
5	No.7 Shielded Room			N/A	

Note: All equipments are calibrated every one year.

### 2.2. Test Setup

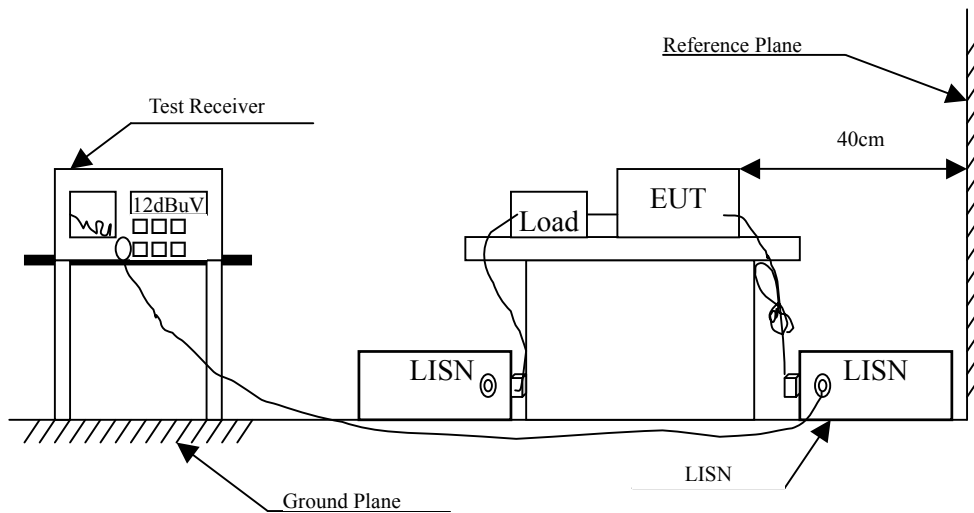

**2.3. Limits**

<b>FCC Part 15 Subpart C Paragraph 15.207 (dBuV) Limit</b>		
Frequency MHz	Limits	
	QP	AV
0.15 - 0.50	66-56	56-46
0.50-5.0	56	46
5.0 - 30	60	50

Remarks: In the above table, the tighter limit applies at the band edges.

**2.4. Test Procedure**

The EUT and simulators are connected to the main power through a line impedance stabilization network (L.I.S.N.). This provides a 50 ohm /50uH coupling impedance for the measuring equipment. The peripheral devices are also connected to the main power through a LISN that provides a 50ohm /50uH coupling impedance with 50ohm termination. (Please refers to the block diagram of the test setup and photographs.)

Both sides of A.C. line are checked for maximum conducted interference. In order to find the maximum emission, the relative positions of equipment and all of the interface cables must be changed according to ANSI C63.4: 2003 on conducted measurement.

Conducted emissions were invested over the frequency range from 0.15MHz to 30MHz using a receiver bandwidth of 9kHz.

**2.5. Uncertainty**

± 2.26 dB

## 2.6. Test Result of Conducted Emission

Product : FS-510  
 Test Item : Conducted Emission Test  
 Power Line : Line 1  
 Test Mode : Mode 1: Transmitter (Channel 39)

Frequency MHz	Correct Factor dB	Reading Level dBuV	Measurement Level dBuV	Margin dB	Limit dBuV
<b>Quasi-Peak</b>					
0.216	0.533	44.380	44.913	-19.201	64.114
0.435	0.300	43.060	43.360	-14.497	57.857
1.412	0.330	35.960	36.290	-19.710	56.000
3.091	0.370	24.400	24.770	-31.230	56.000
5.853	0.460	16.820	17.280	-42.720	60.000
25.228	1.200	17.130	18.330	-41.670	60.000
<b>Average</b>					
0.216	0.533	33.030	33.563	-20.551	54.114
0.435	0.300	24.300	24.600	-23.257	47.857
1.412	0.330	25.350	25.680	-20.320	46.000
3.091	0.370	14.980	15.350	-30.650	46.000
5.853	0.460	5.950	6.410	-43.590	50.000
25.228	1.200	15.840	17.040	-32.960	50.000

Note:

1. All reading levels are quasi-peak and average value.
2. "■" means the worst emission level.
3. Measurement Level = Reading Level + Correct Factor.

Product : FS-510  
 Test Item : Conducted Emission Test  
 Power Line : Line 2  
 Test Mode : Mode 1: Transmitter (Channel 39)

Frequency MHz	Correct Factor dB	Reading Level dBuV	Measurement Level dBuV	Margin dB	Limit dBuV
<b>Quasi-Peak</b>					
0.212	0.300	43.610	43.910	-20.319	64.229
0.326	0.300	33.700	34.000	-26.971	60.971
0.916	0.320	37.320	37.640	-18.360	56.000
1.517	0.338	35.760	36.098	-19.902	56.000
3.255	0.380	25.890	26.270	-29.730	56.000
5.021	0.420	16.640	17.060	-42.940	60.000
<b>Average</b>					
0.212	0.300	32.970	33.270	-20.959	54.229
0.326	0.300	25.020	25.320	-25.651	50.971
0.916	0.320	28.840	29.160	-16.840	46.000
1.517	0.338	25.350	25.688	-20.312	46.000
3.255	0.380	16.370	16.750	-29.250	46.000
5.021	0.420	8.010	8.430	-41.570	50.000

Note:

1. All reading levels are quasi-peak and average value.
2. "█" means the worst emission level.
3. Measurement Level = Reading Level + Correct Factor.

### 3. Peak Power Output

#### 3.1. Test Equipment

	Equipment	Manufacturer	Model No./Serial No.	Last Cal.
X	Spectrum Analyzer	Agilent	E4407B / US39440758	May, 2006

Note: 1. All equipments are calibrated every one year.  
 2. Test instruments marked “X” are used to measure the final test results.

#### 3.2. Test Setup

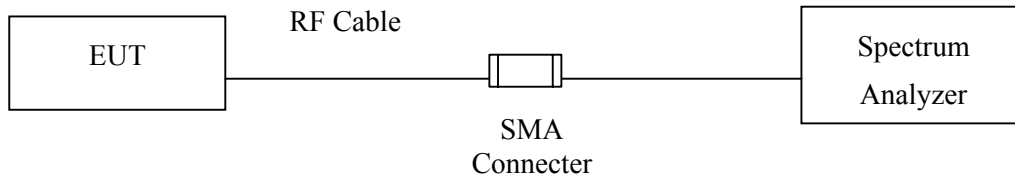

#### 3.3. Limit

The maximum peak power shall be less 1Watt.

#### 3.4. Uncertainty

± 1.27 dB

### 3.5. Test Result of Peak Power Output

Product : FS-510  
 Test Item : Peak Power Output  
 Test Site : No.3 OATS  
 Test Mode : Mode 1: Transmitter

Channel No.	Frequency (MHz)	Measurement	Required Limit	Result
Channel 00	2402.00	2.39dBm	1 Watt= 30 dBm	Pass
Channel 39	2441.00	2.09dBm	1 Watt= 30 dBm	Pass
Channel 78	2480.00	1.28dBm	1 Watt= 30 dBm	Pass

Channel 00

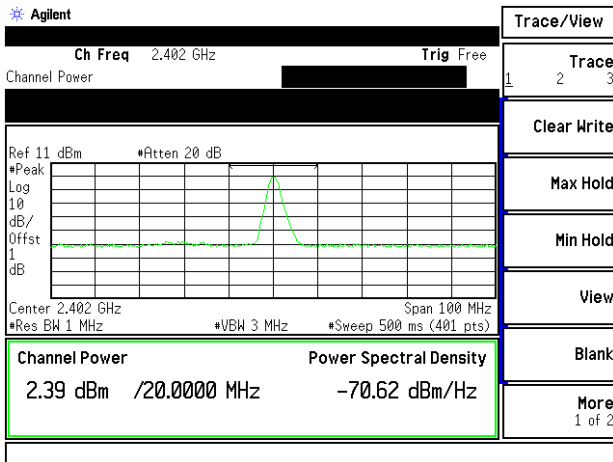

Channel 39

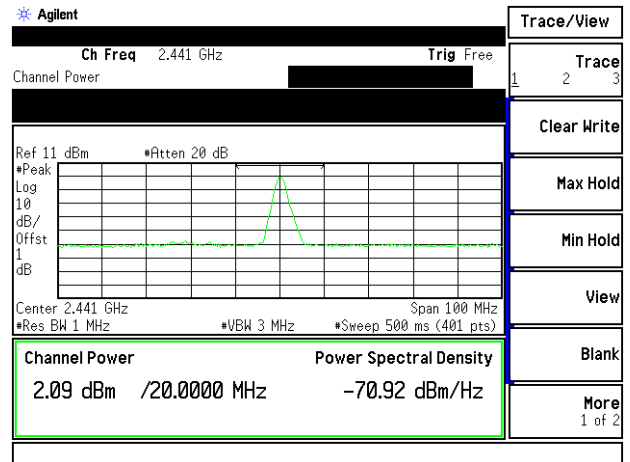

Channel 78

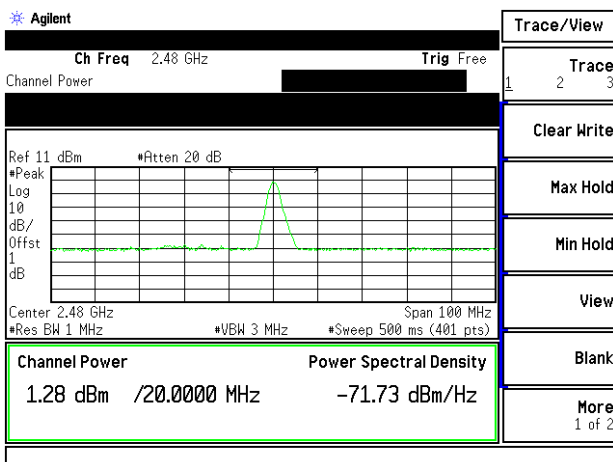

## 4. Radiated Emission

### 4.1. Test Equipment

Test Site		Equipment	Manufacturer	Model No./Serial No.	Last Cal.
<input type="checkbox"/> Site # 1		Test Receiver	R & S	ESVS 10 / 834468/003	May, 2006
		Spectrum Analyzer	Advantest	R3162/ 00803480	May, 2006
		Pre-Amplifier	Advantest	BB525C/ 3307A01812	May, 2006
		Bilog Antenna	SCHAFFNER	CBL6112B / 2697	Sep., 2005
<input type="checkbox"/> Site # 2		Test Receiver	R & S	ESCS 30 / 836858 / 022	May, 2006
		Spectrum Analyzer	Advantest	R3162 / 100803466	May, 2006
		Pre-Amplifier	Advantest	BB525C/3307A01814	May, 2006
		Bilog Antenna	SCHAFFNER	CBL6112B / 2705	May, 2006
		Horn Antenna	ETS	3115 / 0005-6160	Sep., 2005
		Pre-Amplifier	QTK	QTK-AMP-01/ 0001	May, 2006
<input checked="" type="checkbox"/> Site # 3	X	Test Receiver	R & S	ESI 26 / 838786/004	May, 2006
	X	Spectrum Analyzer	Advantest	R3162 / 100803480	May, 2006
	X	Bilog Antenna	SCHAFFNER	CBL6112B / 2697	May, 2006
	X	Horn Antenna	Schwarzbeck	9120D / 305, 306	July, 2005
	X	Horn Antenna	Schwarzbeck	BBHA9170 / 208, 209	July, 2005
	X	Pre-Amplifier	QTK	QTK-AMP-03 / 0003	May, 2006
	X	Pre-Amplifier	HP	8449B / 3008A01123	July, 2005
	X	Pre-Amplifier	MITEQ	AMF-4D-180400-45-6P	May, 2006

- Note: 1. All equipments are calibrated every one year.  
 2. Test equipments marked "X" are used to measure the final test results.



4.2. Test Setup

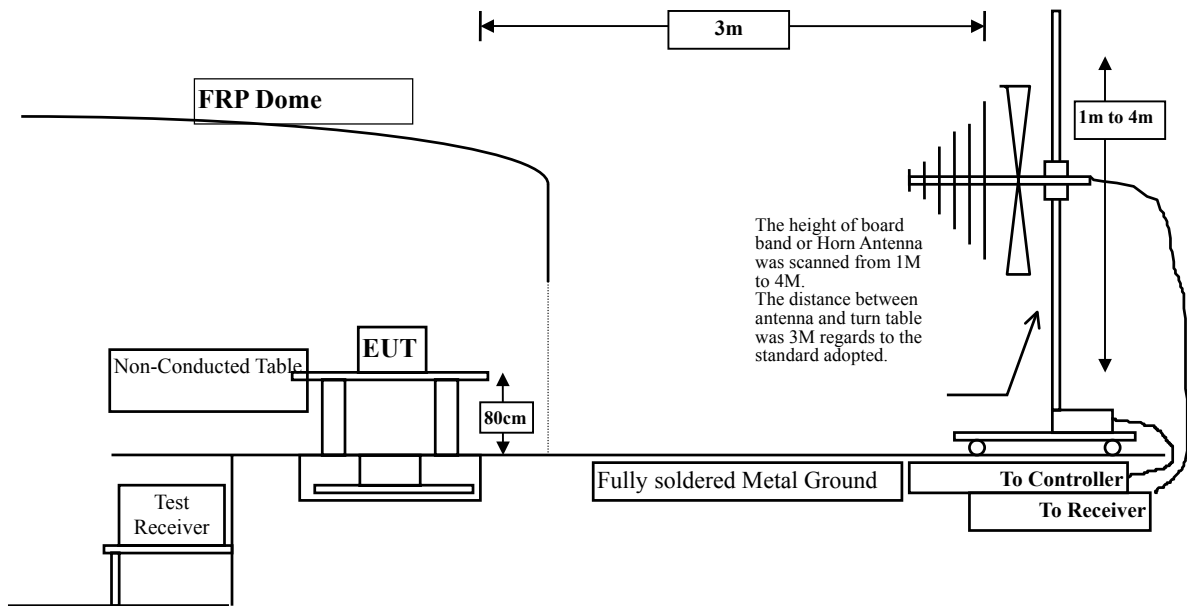

4.3. Limits

➤ General Radiated Emission Limits

Emissions radiated outside of the specified frequency bands, except for harmonics, shall be attenuated by at least 20dB below the level of the fundamental or to the general radiated emission limits in paragraph 15.209, whichever is the lesser attenuation.

FCC Part 15 Subpart C Paragraph 15.209 Limits		
Frequency MHz	uV/m @3m	dBuV/m@3m
30-88	100	40
88-216	150	43.5
216-960	200	46
Above 960	500	54

- Remarks:
1. RF Voltage (dBuV) = 20 log RF Voltage (uV)
  2. In the Above Table, the tighter limit applies at the band edges.
  3. Distance refers to the distance in meters between the measuring instrument antenna and the closed point of any part of the device or system.

#### 4.4. Test Procedure

The EUT and its simulators are placed on a turn table which is 0.8 meter above ground. The turn table can rotate 360 degrees to determine the position of the maximum emission level.

The EUT was positioned such that the distance from antenna to the EUT was 3 meters.

The antenna can move up and down between 1 meter and 4 meters to find out the maximum emission level.

Both horizontal and vertical polarization of the antenna are set on measurement. In order to find the maximum emission, all of the interface cables must be manipulated according to ANSI C63.4: 2003 on radiated measurement.

The additional latch filter below 1GHz was used to measure the level of harmonics radiated emission during field strength of harmonics measurement.

The bandwidth below 1GHz setting on the field strength meter is 120 kHz, above 1GHz are 1 MHz.

The frequency range from 30MHz to 10th harmonics is checked.

#### 4.5. Uncertainty

± 3.9 dB above 1GHz

± 3.8 dB below 1GHz

#### 4.6. Test Result of Radiated Emission

Product : FS-510  
 Test Item : Harmonic Radiated Emission  
 Test Site : No.3 OATS  
 Test Mode : Mode 1: Transmitter (Channel 00)

Frequency MHz	Correct Factor dB	Reading Level dBuV	Measurement Level dBuV/m	Margin dB	Limit dBuV/m
<b>Horizontal</b>					
<b>Peak Detector:</b>					
4804.270	3.055	43.090	46.145	-27.855	74.000
7206.000	8.533	34.130	42.663	-31.337	74.000
9608.000	10.883	33.150	44.034	-29.966	74.000
12010.000	14.177	32.070	46.247	-27.753	74.000
<b>Average Detector:</b>					
--					
<b>Vertical</b>					
<b>Peak Detector:</b>					
4804.210	3.055	42.740	45.795	-28.205	74.000
7206.000	8.533	34.760	43.293	-30.707	74.000
9608.000	10.883	33.160	44.044	-29.956	74.000
12010.000	14.177	31.460	45.637	-28.363	74.000
<b>Average Detector:</b>					
--					

Note:

1. The reading levels below 1GHz and above 1GHz are quasi-peak values and peak/average values, respectively.
2. Receiver setting (Peak Detector) : RBW:1MHz; VBW:1MHz; Span:100MHz ◦
3. Receiver setting (AVG Detector) : RBW:1MHz; VBW:30Hz; Span:20MHz ◦
4. Emission Level = Reading Level + Correct Factor.
5. The average measurement was not performed when the peak measured data under the limit of average detection. If the readings given are average, peak measurement should also be supplied.

Product : FS-510  
 Test Item : Harmonic Radiated Emission  
 Test Site : No.3 OATS  
 Test Mode : Mode 1: Transmitter (Channel 39)

Frequency MHz	Correct Factor dB	Reading Level dBuV	Measurement Level dBuV/m	Margin dB	Limit dBuV/m
<b>Horizontal</b>					
<b>Peak Detector:</b>					
4882.190	3.291	41.970	45.262	-28.738	74.000
7323.000	8.822	32.680	41.501	-32.499	74.000
9764.000	10.966	33.440	44.407	-29.593	74.000
12205.000	14.080	31.970	46.051	-27.949	74.000
<b>Average Detector:</b>					
--					
<b>Vertical</b>					
<b>Peak Detector:</b>					
4882.230	3.292	43.050	46.342	-27.658	74.000
7323.000	8.822	34.980	43.801	-30.199	74.000
9764.000	10.966	32.940	43.907	-30.093	74.000
12205.000	14.080	32.320	46.401	-27.599	74.000
<b>Average Detector:</b>					
--					

Note:

1. The reading levels below 1GHz and above 1GHz are quasi-peak values and peak/average values, respectively.
2. Receiver setting (Peak Detector) : RBW:1MHz; VBW:1MHz; Span:100MHz ◦
3. Receiver setting (AVG Detector) : RBW:1MHz; VBW:30Hz; Span:20MHz ◦
4. Emission Level = Reading Level + Correct Factor.
5. The average measurement was not performed when the peak measured data under the limit of average detection. If the readings given are average, peak measurement should also be supplied.

Product : FS-510  
 Test Item : Harmonic Radiated Emission  
 Test Site : No.3 OATS  
 Test Mode : Mode 1: Transmitter (Channel 78)

Frequency MHz	Correct Factor dB	Reading Level dBuV	Measurement Level dBuV/m	Margin dB	Limit dBuV/m
<b>Horizontal</b>					
<b>Peak Detector:</b>					
4960.090	3.544	44.970	48.514	-25.486	74.000
7440.000	9.106	33.840	42.946	-31.054	74.000
9920.000	11.057	33.730	44.787	-29.213	74.000
12400.000	13.985	31.470	45.456	-28.544	74.000
<b>Average Detector:</b>					
--					
<b>Vertical</b>					
<b>Peak Detector:</b>					
4960.170	3.544	46.020	49.564	-24.436	74.000
7440.000	9.106	34.160	43.266	-30.734	74.000
9920.000	11.057	33.390	44.447	-29.553	74.000
12400.000	13.985	32.380	46.366	-27.634	74.000
<b>Average Detector:</b>					
--					

Note:

1. Reading levels below 1GHz and above 1GHz are quasi-peak values and peak/average values, respectively.
2. Receiver setting (Peak Detector) : RBW:1MHz; VBW:1MHz; Span:100MHz ◦
3. Receiver setting (AVG Detector) : RBW:1MHz; VBW:30Hz; Span:20MHz ◦
4. Emission Level = Reading Level + Correct Factor.
5. The average measurement was not performed when the peak measured data under the limit of average detection. If the readings given are average, peak measurement should also be supplied.

Product : FS-510  
 Test Item : General Radiated Emission  
 Test Site : No.3 OATS  
 Test Mode : Mode 1: Transmitter (Channel 39)

Frequency MHz	Correct Factor dB	Reading Level dBuV	Measurement Level dBuV/m	Margin dB	Limit dBuV/m
<b>Horizontal</b>					
360.461	15.425	23.204	38.629	-7.371	46.000
383.788	15.779	22.215	37.995	-8.005	46.000
467.375	18.703	17.697	36.400	-9.600	46.000
492.645	18.349	16.118	34.467	-11.533	46.000
515.972	18.966	16.325	35.290	-10.710	46.000
611.222	20.507	12.705	33.213	-12.787	46.000
<b>Vertical</b>					
323.527	14.309	14.976	29.285	-16.715	46.000
383.788	16.842	18.424	35.267	-10.733	46.000
500.421	18.356	13.858	32.214	-13.786	46.000
525.691	18.785	14.616	33.401	-12.599	46.000
564.569	21.160	6.092	27.252	-18.748	46.000
900.862	23.650	6.850	30.500	-15.500	46.000

Note:

1. The reading levels below 1GHz are quasi-peak values.
2. “█” means the worst emission level.
3. Measurement Level = Reading Level + Correct Factor
4. The radiated emissions below 1GHz of the lowest, middle, highest frequency are pretested. Only the worst case is shown on the report.

## 5. Band Edge

### 5.1. Test Equipment

Equipment	Manufacturer	Model No./Serial No.	Last Cal.
X Test Receiver	R & S	ESI 26 / 838786/004	May, 2006
X Spectrum Analyzer	Advantest	R3162 / 100803480	May, 2006
X Bilog Antenna	SCHAFFNER	CBL6112B / 2697	May, 2006
X Horn Antenna	Schwarzbeck	9120D / 305, 306	July, 2005
X Horn Antenna	Schwarzbeck	BBHA9170 / 208, 209	July, 2005
X Pre-Amplifier	QTK	QTK-AMP-03 / 0003	May, 2006
X Pre-Amplifier	HP	8449B / 3008A01123	July, 2005
X Pre-Amplifier	MITEQ	AMF-4D-180400-45-6P	May, 2006

OATS No.3

- Note:
1. All equipments are calibrated every one year.
  2. The test equipments marked "X" are used to measure the final test results.

### 5.2. Test Setup

#### RF Radiated Measurement:

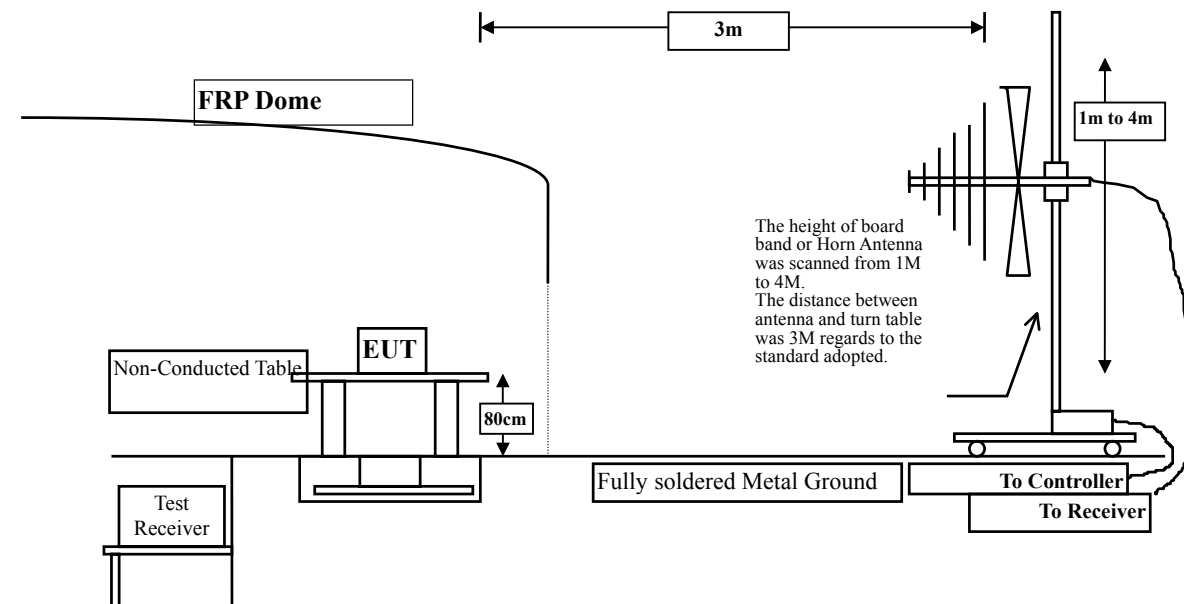

### 5.3. Limit

In any 100 kHz bandwidth outside the frequency band in which the spread spectrum intentional radiator is operating, the radio frequency power that is produced by the intentional radiator shall be at least 20 dB below that in the 100 kHz bandwidth within the band that contains the highest level of the desired power, based on either an RF conducted or a radiated measurement. Attenuation below the general limits specified in Section 15.209(a) is not required. In addition, radiated emissions which fall in the restricted bands, as defined in Section 15.205(a), must also comply with the radiated emission limits specified in Section 15.209(a) (see Section 15.205(c)).

### 5.4. Test Procedure

The EUT and its simulators are placed on a turn table which is 0.8 meter above ground. The turn table can rotate 360 degrees to determine the position of the maximum emission level. The EUT was positioned such that the distance from antenna to the EUT was 3 meters.

The antenna can move up and down between 1 meter and 4 meters to find out the maximum emission level.

Both horizontal and vertical polarization of the antenna are set on measurement. In order to find the maximum emission, all of the interface cables must be manipulated according to ANSI C63.4:2003 on radiated measurement.

The bandwidth below 1GHz setting on the field strength meter is 120 kHz, above 1GHz are 1 MHz.

### 5.5. Uncertainty

± 3.9 dB above 1GHz

± 3.8 dB below 1GHz



**5.6. Test Result of Band Edge**

Product : FS-510  
 Test Item : Band Edge  
 Test Site : No.3 OATS  
 Test Mode : Mode 1: Transmitter (Channel 00)

**RF Radiated Measurement:**

Channel No.	Frequency (MHz)	Required Limit (dBc)	Result
00	<2400	>20	Pass

**RF Radiated Measurement (Horizontal):**

Channel No.	Frequency (MHz)	Correct Factor (dB)	Reading Level (dBuV)	Emission Level (dBuV/m)	Peak Limit (dBuV/m)	Average Limit (dBuV/m)	Result
00(Peak)	2378.607	-2.933	48.398	45.465	74.00	54.00	Pass
00(Avg)	--		--	--	74.00	54.00	Pass

**Figure Channel 00:** (Horizontal)

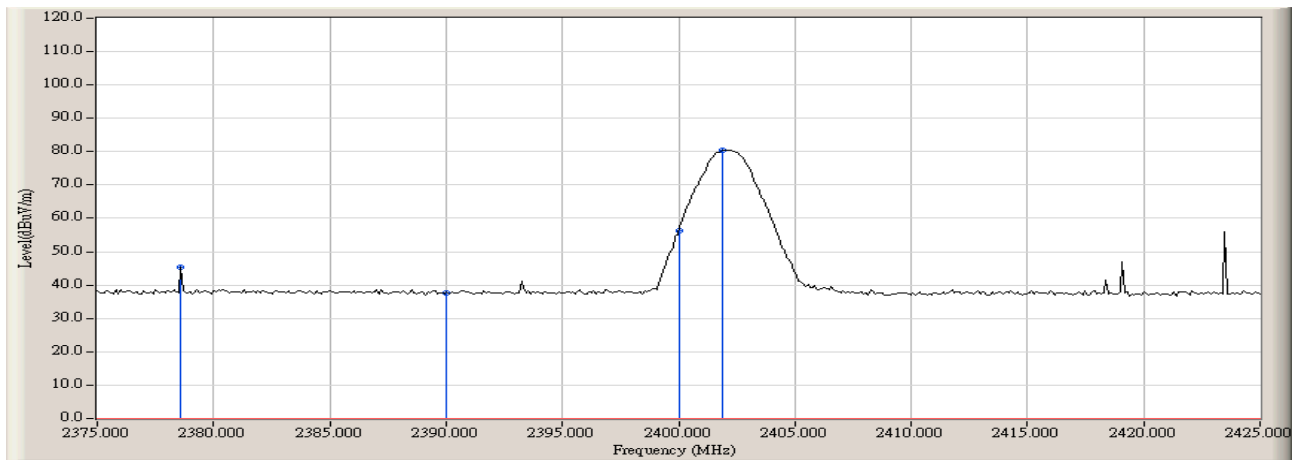

Note:

RBW=1MHz, VBW=1MHz, Sweep Time=500ms.

Product : FS-510  
 Test Item : Band Edge  
 Test Site : No.3 OATS  
 Test Mode : Mode 1: Transmitter (Channel 00)

**RF Radiated Measurement:**

Channel No.	Frequency (MHz)	Required Limit (dBc)	Result
00	<2400	>20	Pass

**RF Radiated Measurement (Vertical):**

Channel No.	Frequency (MHz)	Correct Factor (dB)	Reading Level (dBuV)	Emission Level (dBuV/m)	Peak Limit (dBuV/m)	Average Limit (dBuV/m)	Result
00(Peak)	2376.703	-2.941	49.953	47.013	74.00	54.00	Pass
00(Avg)	--		--	--	74.00	54.00	Pass

**Figure Channel 00:** (Vertical)

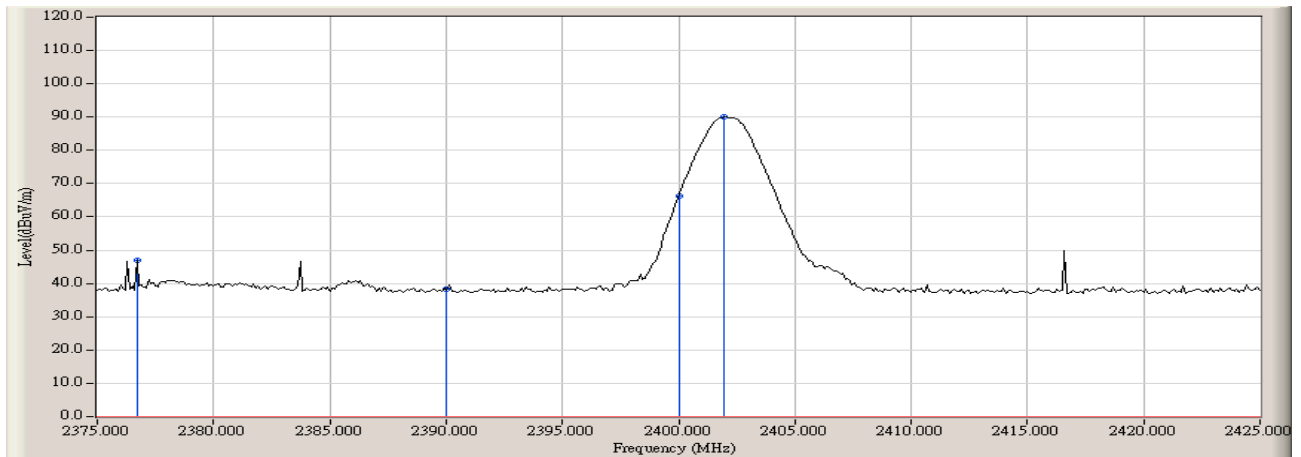

Note:

RBW=1MHz, VBW=1MHz, Sweep Time=500ms.

Product : FS-510  
 Test Item : Band Edge  
 Test Site : No.3 OATS  
 Test Mode : Mode 1: Transmitter (Channel 78)

**RF Radiated Measurement:**

Channel No.	Frequency (MHz)	Required Limit (dBc)	Result
78	>2483.5	>20	Pass

**RF Radiated Measurement (Horizontal):**

Channel No.	Frequency (MHz)	Correct Factor (dB)	Reading Level (dBuV)	Emission Level (dBuV/m)	Peak Limit (dBuV/m)	Average Limit (dBuV/m)	Result
00(Peak)	2483.500	-2.442	48.544	46.102	74.00	54.00	Pass
00(Avg)	--		--	--	74.00	54.00	Pass

**Figure Channel 78:** (Horizontal)

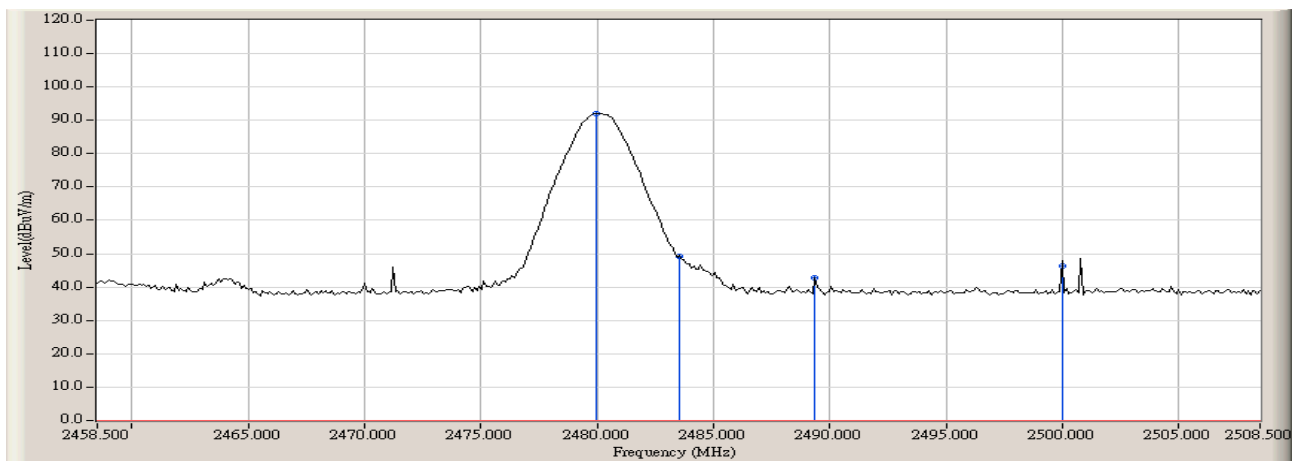

Note:

RBW=1MHz, VBW=1MHz, Sweep Time=500ms.

Product : FS-510  
 Test Item : Band Edge  
 Test Site : No.3 OATS  
 Test Mode : Mode 1: Transmitter (Channel 78)

**RF Radiated Measurement:**

Channel No.	Frequency (MHz)	Required Limit (dBc)	Result
78	>2483.5	>20	Pass

**RF Radiated Measurement (Vertical):**

Channel No.	Frequency (MHz)	Correct Factor (dB)	Reading Level (dBuV)	Emission Level (dBuV/m)	Peak Limit (dBuV/m)	Average Limit (dBuV/m)	Result
00(Peak)	2483.500	-2.442	51.644	49.202	74.00	54.00	Pass
00(Avg)	--		--	--	74.00	54.00	Pass

**Figure Channel 78:** (Vertical)

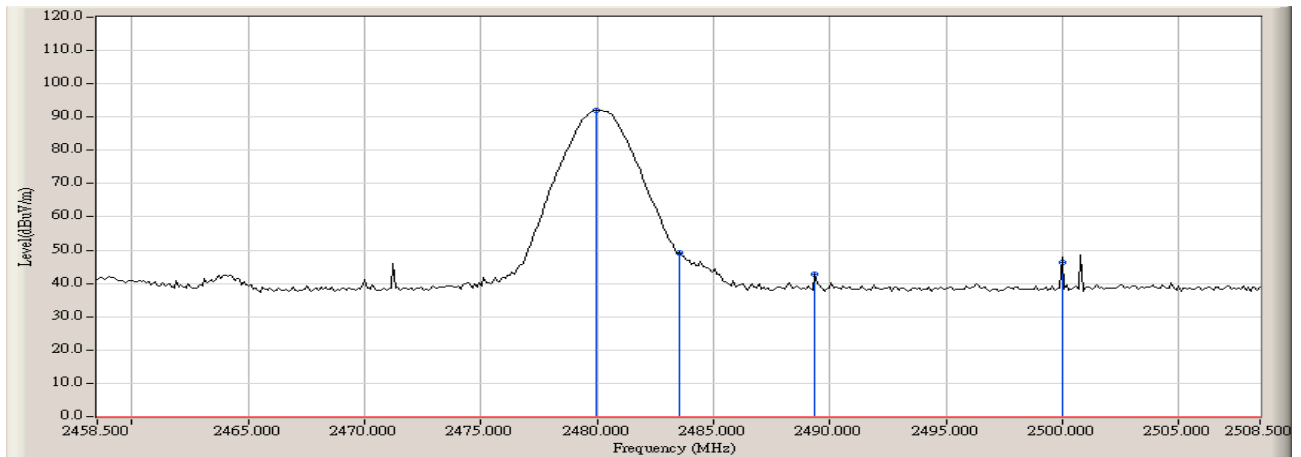

Note:

RBW=1MHz, VBW=1MHz, Sweep Time=500ms.

Note: The average measurement was not performed when the peak measured data under the limit of average detection. If the readings given are average, peak measurement should also be supplied.

**6. Channel Number**

**6.1. Test Equipment**

	Equipment	Manufacturer	Model No./Serial No.	Last Cal.
X	Spectrum Analyzer	Agilent	E4407B / US39440758	May, 2006

Note: 1. All equipments are calibrated every one year.  
 2. The test equipments marked “X” are used to measure the final test results.

**6.2. Test Setup**

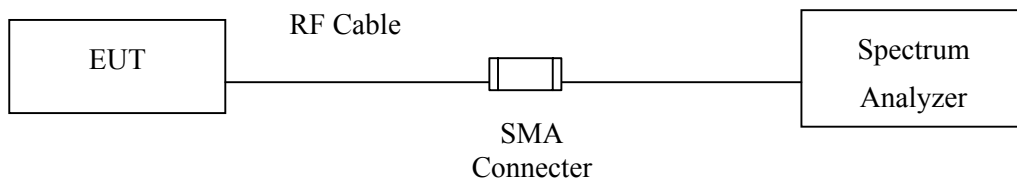

**6.3. Limit**

Frequency hopping systems operating in the 2400-2483.5 MHz bands shall use at least 75 hopping frequencies.

**6.4. Uncertainty**

N/A

### 6.5. Test Result of Channel Number

Product : FS-510  
 Test Item : Channel Number  
 Test Site : No.3 OATS  
 Test Mode : Mode 1: Transmitter

Frequency Range (MHz)	Measurement (Hopping Channel)	Required Limit (Hopping Channel)	Result
2402 ~ 2480	79	>75	Pass

2402-2421MHz

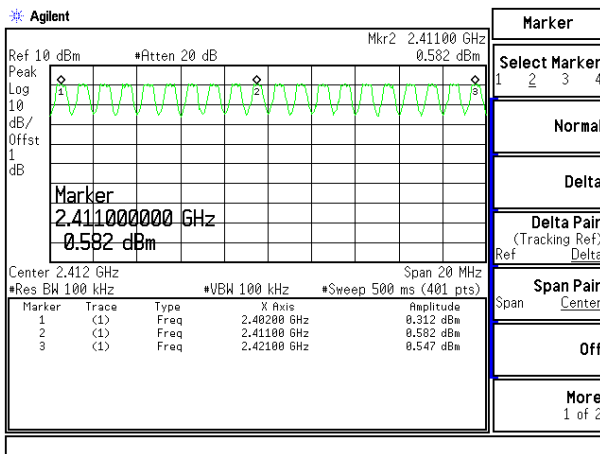

2422-2441MHz

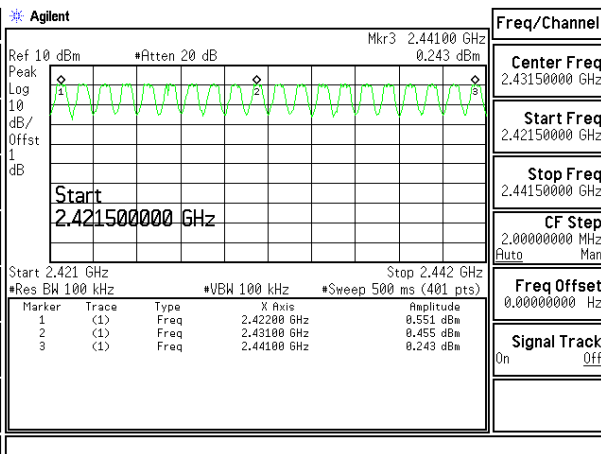

2442-2471MHz

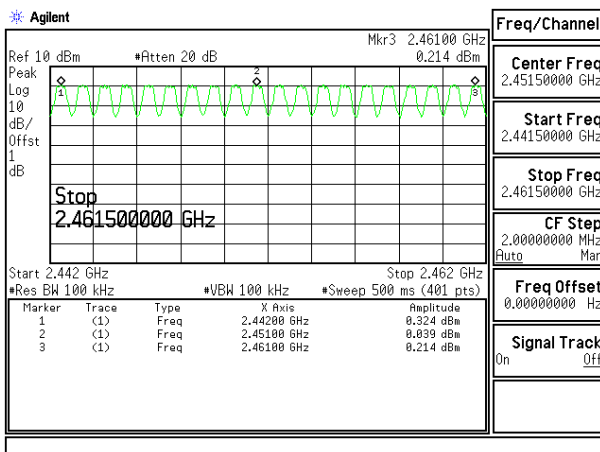

2472-2481MHz

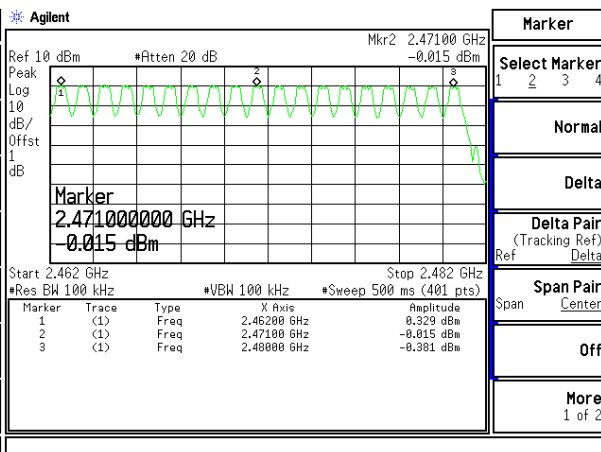

## 7. Channel Separation

### 7.1. Test Equipment

	Equipment	Manufacturer	Model No./Serial No.	Last Cal.
X	Spectrum Analyzer	Agilent	E4407B / US39440758	May, 2005

Note: 1. All equipments are calibrated every one year.  
 2. The test instruments marked “X” are used to measure the final test results.

### 7.2. Test Setup

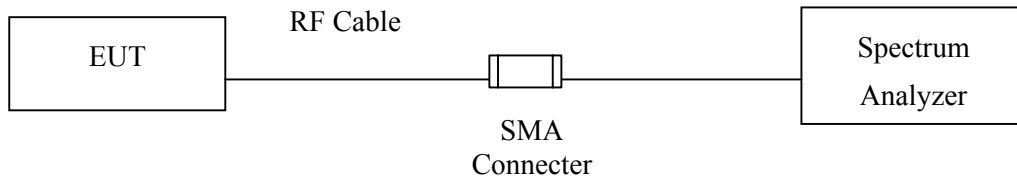

### 7.3. Limit

Frequency hopping systems shall have hopping channel carrier frequencies separated by a minimum of 25 kHz or the 20 dB bandwidth of the hopping channel, whichever is greater. Alternatively, frequency hopping systems operating in the 2400-2483.5 MHz band may have hopping channel carrier frequencies that are separated by 25 kHz or two-thirds of the 20 dB bandwidth of the hopping channel, whichever is greater, provided the systems operate with an output power no greater than 125mW.

### 7.4. Uncertainty

± 150Hz

### 7.5. Test Result of Channel Separation

Product : FS-510  
 Test Item : Channel Separation  
 Test Site : No.3 OATS  
 Test Mode : Mode 1: Transmitter

Frequency (MHz)	Measurement Level (MHz)	Required Limit	Result
2402	1.00	>25 kHz or 2/3 * 20 dB BW	Pass
2441	1.00	>25 kHz or 2/3 * 20 dB BW	Pass
2480	1.00	>25 kHz or 2/3 * 20 dB BW	Pass

Channel 00 2402MHz

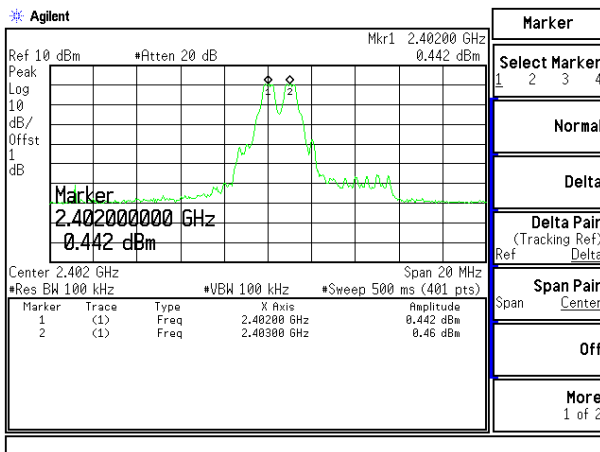

Channel 39 2441MHz

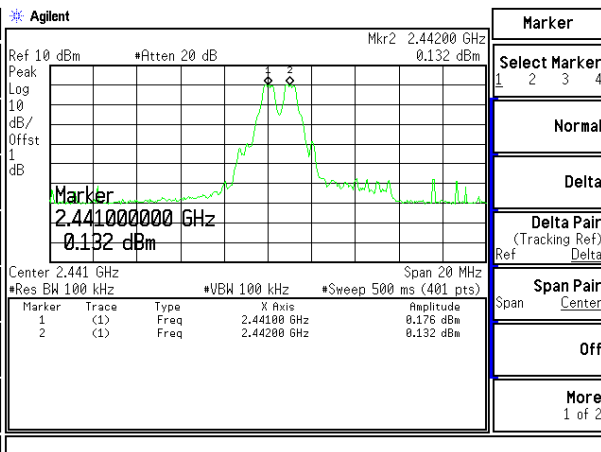

Channel 78 2480 MHz

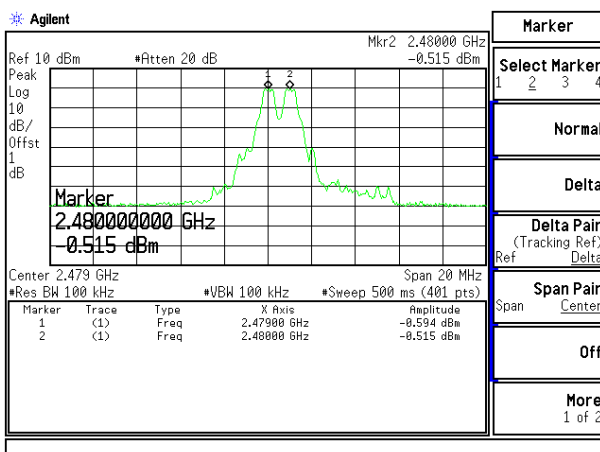



**8. Dwell Time**

**8.1. Test Equipment**

	Equipment	Manufacturer	Model No./Serial No.	Last Cal.
X	Spectrum Analyzer	Agilent	E4407B / US39440758	May, 2006

Note: 1. All equipments are calibrated every one year.  
 2. The test equipments marked “X” are used to measure the final test results.

**8.2. Test Setup**

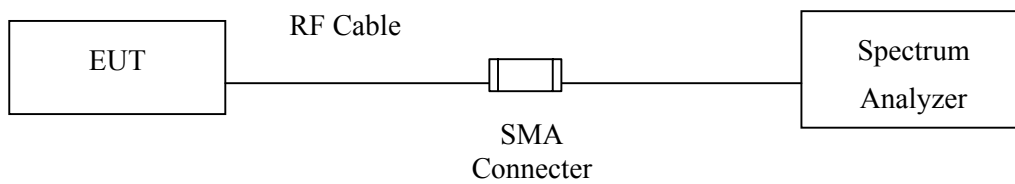

**8.3. Limit**

The dwell time shall be the average time of occupancy on any frequency shall not be greater than 0.4 seconds within a 30 second period.

**8.4. Uncertainty**

± 25msec

### 8.5. Test Result of Dwell Time

Product : FS-510  
 Test Item : Dwell Time  
 Test Site : No.3 OATS  
 Test Mode : Mode 1: Transmitter (Channel 00,39,78 –DH1)

Channel (MHz)	Measurement Level (ms)	Required Limit (sec.)	Result
CH 00 2402	128	< 0.4	Pass
CH 39 2441	128	< 0.4	Pass
CH 78 2480	128	< 0.4	Pass

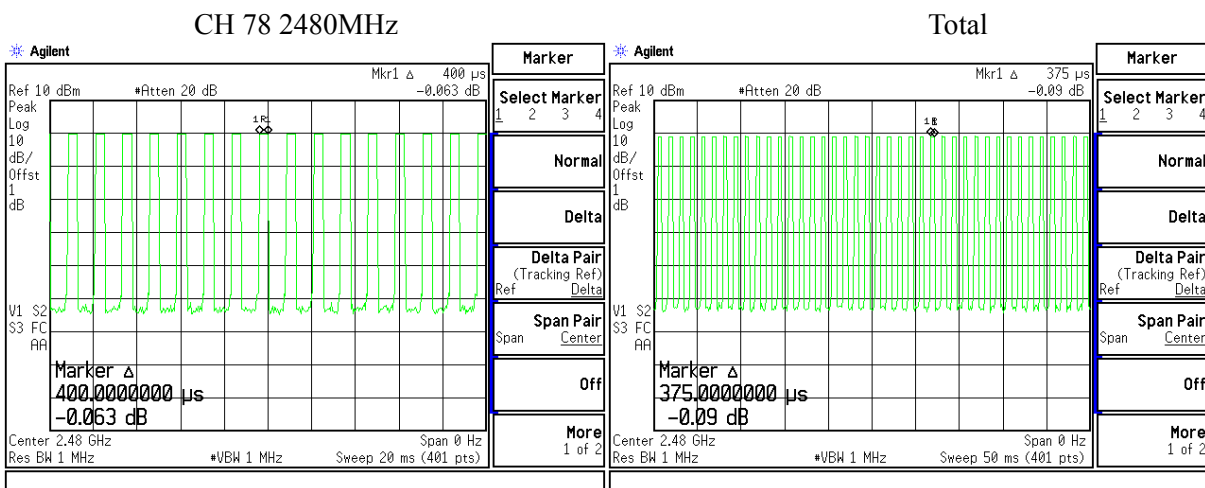
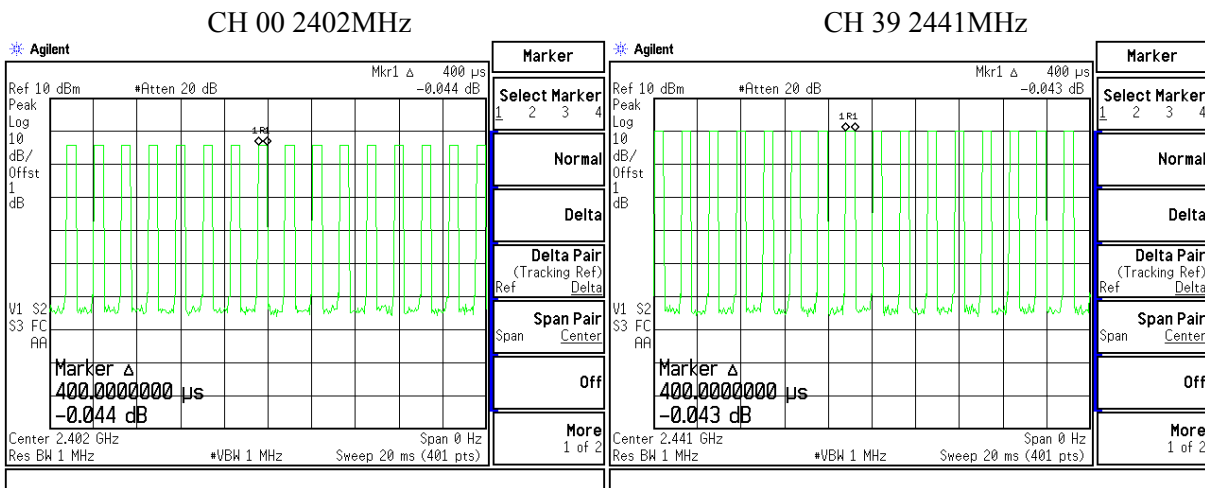

Note: Dwell time = time slot length \* hop rate / number of hopping channels \* period

#### Occupancy Time of Frequency Hopping System

Test Time Period:  $0.4 * 79 = 31.6\text{sec}$ , Hopping Times Within 1sec:  $40/50\text{msec} = 0.8 \text{ hops/msec}$ .

A) 2402MHz The Maximum Occupancy Time Within 31.6sec:  $400 \mu\text{s} * 800 / 79 * 31.6 = 128\text{msec}$  ◦

B) 2441MHz The Maximum Occupancy Time Within 31.6sec:  $400 \mu\text{s} * 800 / 79 * 31.6 = 128\text{msec}$  ◦

C) 2480MHz The Maximum Occupancy Time Within 31.6sec:  $400 \mu\text{s} * 800 / 79 * 31.6 = 128\text{msec}$  ◦

Test Result: The average occupancy times of the highest, middle and lowest channel are less than 0.4sec, and thus complies the standard.

PS: (1) From Bluetooth Specification, It Hops 1640 Times in 1sec. The Average Occupancy Time of Each 79 Channels is  $1600/79$  Times, Therefore, We Calculate The Maximum Occupancy Time (worst care) As Below:

A) 2402Mhz The Occupancy Time of Each Pulse is 0.4msec, The Maximum Occupancy Time within 31.6sec is  $0.4\text{msec} * 1640/79 * 31.6 = 289.056\text{msec}$

B) 2441MHz The Occupancy Time of Each Pulse is 0.4msec, The Maximum Occupancy Time within 31.6sec is  $0.4\text{msec} * 1640/79 * 31.6 = 289.056\text{msec}$

C) 2480MHz The Occupancy Time of Each Pulse is 0.4msec, The Maximum Occupancy Time within 31.6sec is  $0.4\text{msec} * 1640/79 * 31.6 = 289.056\text{msec}$

Test Result: The average occupancy times of the highest, middle and lowest channel are less than 0.4sec, and thus complies the standard.

Product : FS-510  
 Test Item : Dwell Time  
 Test Site : No.3 OATS  
 Test Mode : Mode 1: Transmitter (Channel 00,39,78 –DH3)

Channel (MHz)	Measurement Level (ms)	Required Limit (sec.)	Result
CH 00 2402	132	< 0.4	Pass
CH 39 2441	132	< 0.4	Pass
CH 78 2480	132	< 0.4	Pass

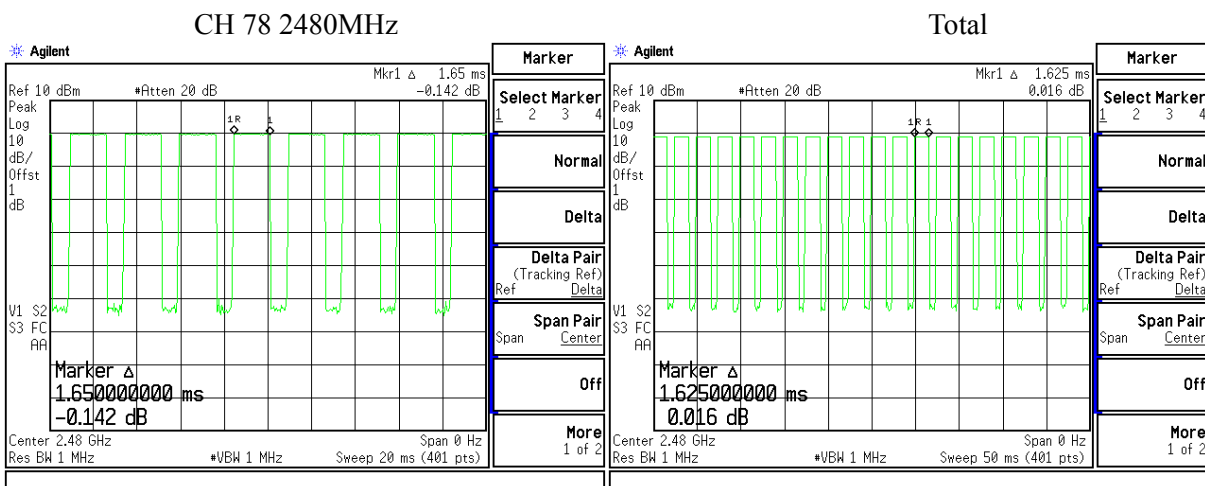
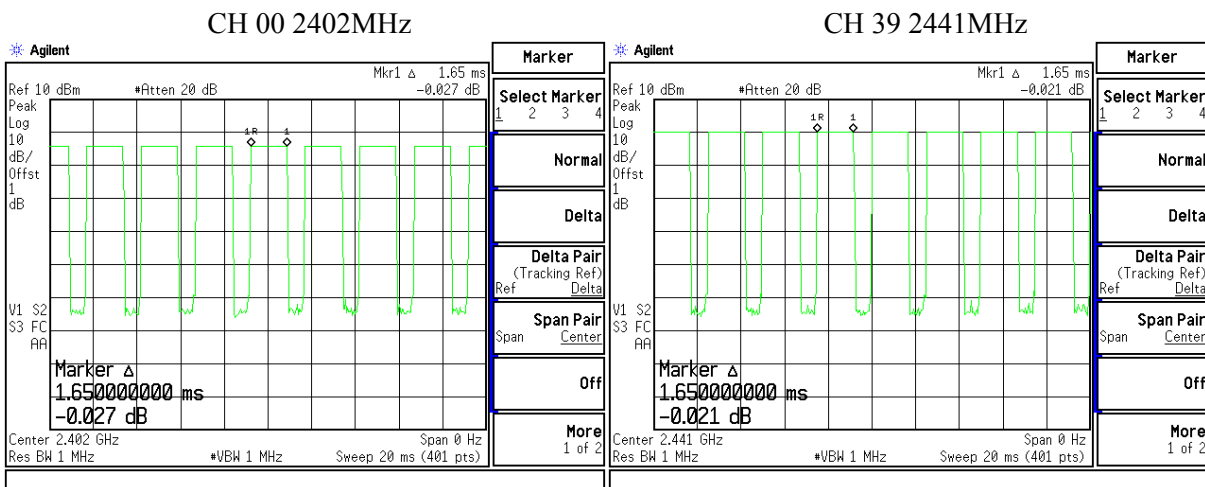

Note: Dwell time = time slot length \* hop rate / number of hopping channels \* period

#### Occupancy Time of Frequency Hopping System

Test Time Period:  $0.4 * 79 = 31.6\text{sec}$ , Hopping Times Within 1sec:  $20/100\text{msec} = 0.2 \text{ hops/msec}$ .

A) 2402MHz The Maximum Occupancy Time Within 31.6sec:  $1650 \mu\text{s} * 200 / 79 * 31.6 = 132\text{msec}$  ◦

B) 2441MHz The Maximum Occupancy Time Within 31.6sec:  $1650 \mu\text{s} * 200 / 79 * 31.6 = 132\text{msec}$  ◦

C) 2480MHz The Maximum Occupancy Time Within 31.6sec:  $1650 \mu\text{s} * 200 / 79 * 31.6 = 132\text{msec}$  ◦

Test Result: The average occupancy times of the highest, middle and lowest channel are less than 0.4sec, and thus complies the standard.

PS: (1) From Bluetooth Specification, It Hops 1640 Times in 1sec. The Average Occupancy Time of Each 79 Channels is  $1600/79$  Times, Therefore, We Calculate The Maximum Occupancy Time (worst care) As Below:

A) 2402Mhz The Occupancy Time of Each Pulse is 0.4msec, The Maximum Occupancy Time within 31.6sec is  $0.4\text{msec} * 1640/79 * 31.6 = 289.056\text{msec}$

B) 2441MHz The Occupancy Time of Each Pulse is 0.4msec, The Maximum Occupancy Time within 31.6sec is  $0.4\text{msec} * 1640/79 * 31.6 = 289.056\text{msec}$

C) 2480MHz The Occupancy Time of Each Pulse is 0.4msec, The Maximum Occupancy Time within 31.6sec is  $0.4\text{msec} * 1640/79 * 31.6 = 289.056\text{msec}$

Test Result: The average occupancy times of the highest, middle and lowest channel are less than 0.4sec, and thus complies the standard.

Product : FS-510  
 Test Item : Dwell Time  
 Test Site : No.3 OATS  
 Test Mode : Mode 1: Transmitter (Channel 00,39,78 –DH5)

Channel (MHz)	Measurement Level (ms)	Required Limit (sec.)	Result
CH 00 2402	150.08	< 0.4	Pass
CH 39 2441	150.08	< 0.4	Pass
CH 78 2480	148.2	< 0.4	Pass

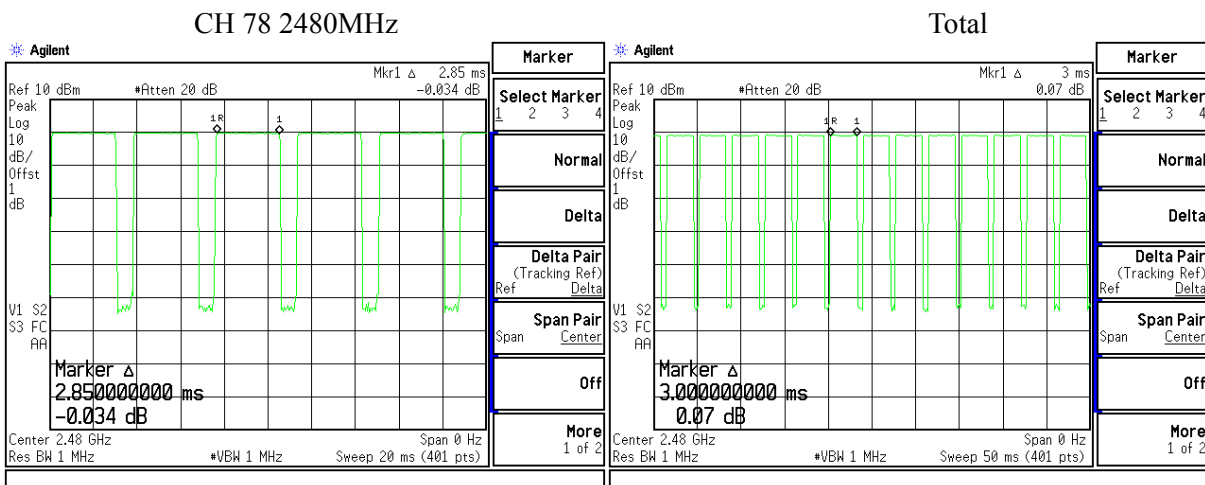
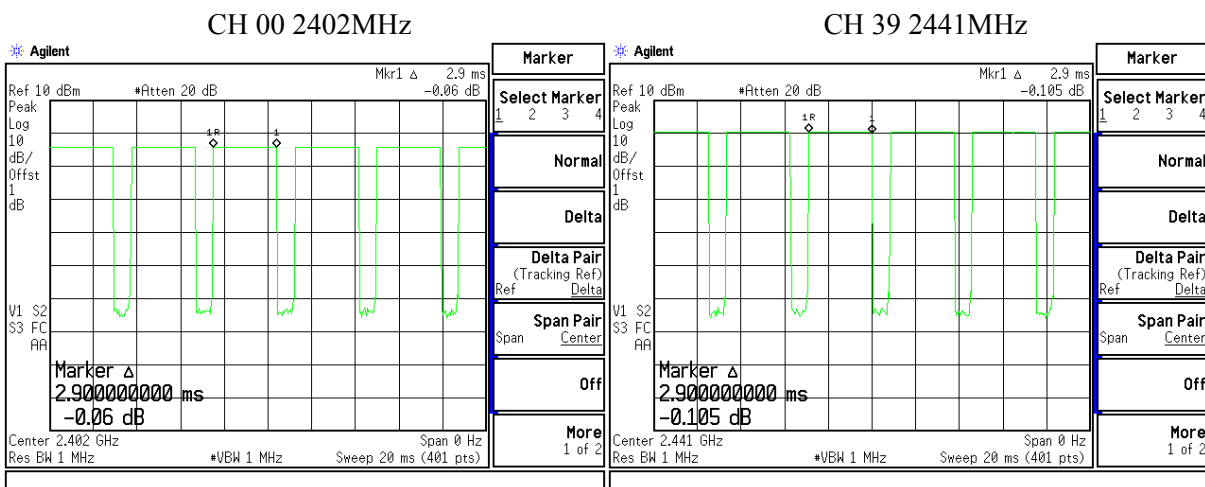

Note: Dwell time = time slot length \* hop rate / number of hopping channels \* period

#### Occupancy Time of Frequency Hopping System

Test Time Period:  $0.4 * 79 = 31.6\text{sec}$ , Hopping Times Within 1sec:  $13/100\text{msec} = 0.13 \text{ hops/msec}$ .

A) 2402MHz The Maximum Occupancy Time Within 31.6sec:  $2900 \mu\text{s} * 130 / 79 * 31.6 = 150.08\text{msec}$  °

B) 2441MHz The Maximum Occupancy Time Within 31.6sec:  $2900 \mu\text{s} * 130 / 79 * 31.6 = 150.08\text{msec}$  °

C) 2480MHz The Maximum Occupancy Time Within 31.6sec:  $2850 \mu\text{s} * 130 / 79 * 31.6 = 148.2\text{msec}$  °

Test Result: The average occupancy times of the highest, middle and lowest channel are less than 0.4sec, and thus complies the standard.

PS: (1) From Bluetooth Specification, It Hops 1640 Times in 1sec. The Average Occupancy Time of Each 79 Channels is 1600/79 Times, Therefore, We Calculate The Maximum Occupancy Time (worst care) As Below:

A) 2402Mhz The Occupancy Time of Each Pulse is 0.4msec, The Maximum Occupancy Time within 31.6sec is  $0.4\text{msec} * 1640 / 79 * 31.6 = 289.056\text{msec}$

B) 2441MHz The Occupancy Time of Each Pulse is 0.4msec, The Maximum Occupancy Time within 31.6sec is  $0.4\text{msec} * 1640 / 79 * 31.6 = 289.056\text{msec}$

C) 2480MHz The Occupancy Time of Each Pulse is 0.4msec, The Maximum Occupancy Time within 31.6sec is  $0.4\text{msec} * 1640 / 79 * 31.6 = 289.056\text{msec}$

Test Result: The average occupancy times of the highest, middle and lowest channel are less than 0.4sec, and thus complies the standard.

**9. Occupied Bandwidth**

**9.1. Test Equipment**

	Equipment	Manufacturer	Model No./Serial No.	Last Cal.
X	Spectrum Analyzer	Agilent	E4407B / US39440758	May, 2006

Note: 1. All equipments are calibrated every one year.  
 2. The test instruments Marked “X” are used to measure the final test results.

**9.2. Test Setup**

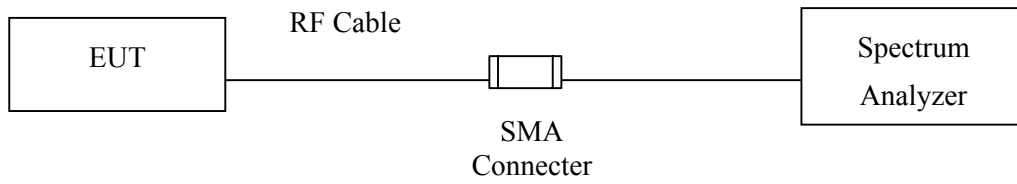

**9.3. Limits**

N/A

**9.4. Uncertainty**

± 150Hz



**9.5. Test Result of Occupied Bandwidth**

Product : FS-510  
 Test Item : Occupied Bandwidth Data  
 Test Site : No.3 OATS  
 Test Mode : Mode 1: Transmitter (2402MHz)

Channel No.	Frequency (MHz)	Measurement Level (kHz)	Required Limit (kHz)	Result
00	2402	1247	--	N/A

**Figure Channel 00:**

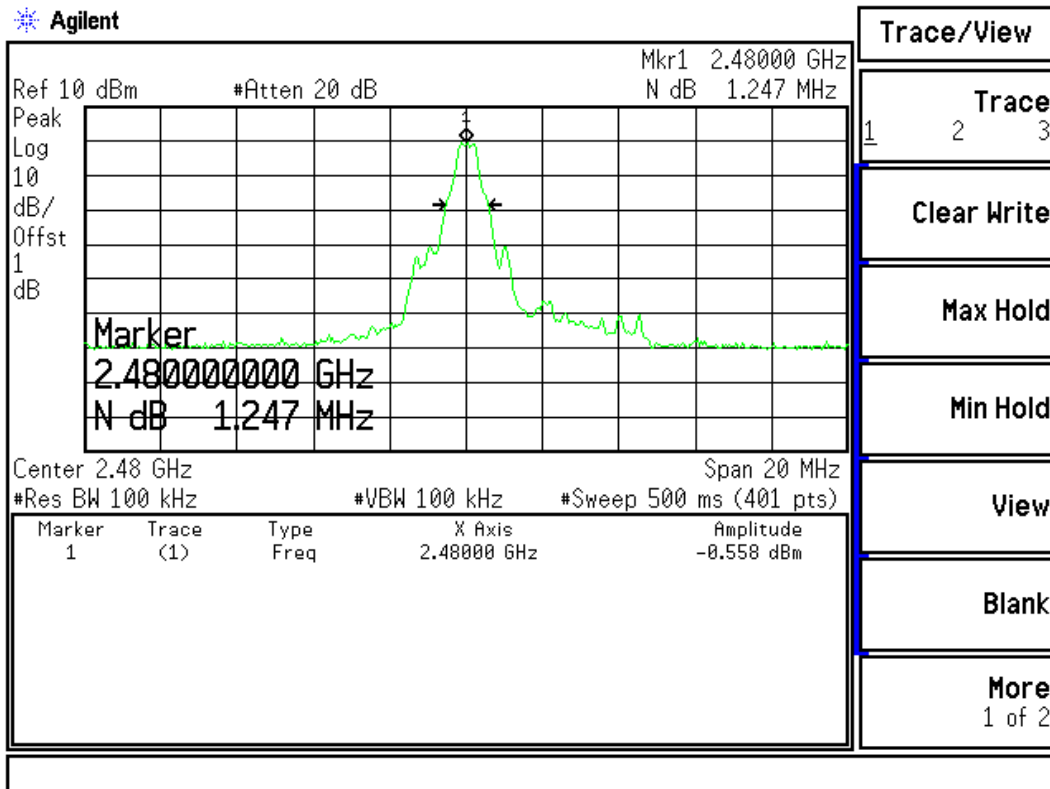

Product : FS-510  
 Test Item : Occupied Bandwidth Data  
 Test Site : No.3 OATS  
 Test Mode : Mode 1: Transmitter (2441MHz)

Channel No.	Frequency (MHz)	Measurement Level (kHz)	Required Limit (kHz)	Result
39	2441	1247	--	N/A

**Figure Channel 39:**

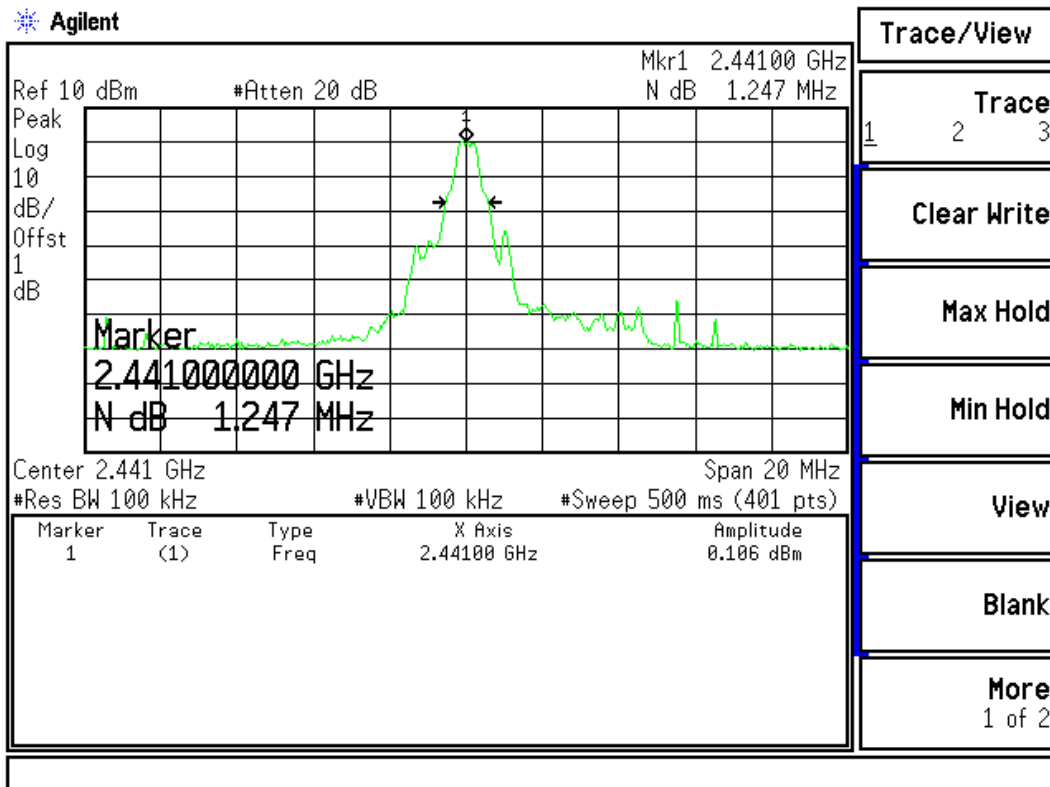

Product : FS-510  
 Test Item : Occupied Bandwidth Data  
 Test Site : No.3 OATS  
 Test Mode : Mode 1: Transmitter (2480MHz)

Channel No.	Frequency (MHz)	Measurement Level (kHz)	Required Limit (kHz)	Result
78	2480	1247	--	N/A

**Figure Channel 78:**

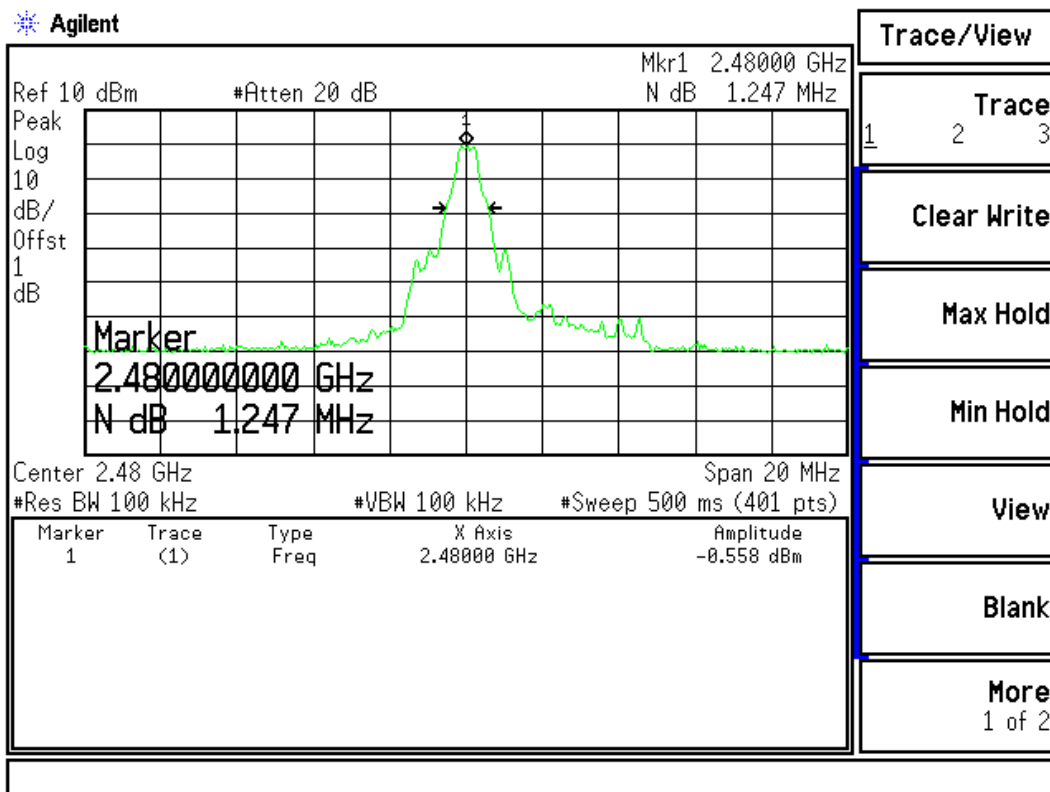

## 10. EMI Reduction Method During Compliance Testing

No modification was made during testing.