



Test Report

Product Name	Bluetooth Music Audio Transmitter
Model No.	MS-6868J
FCC ID.	I4L-MS6868J

Applicant	MICRO-STAR INTL Co., LTD.
Address	No. 69, Li-De St., Jung-He City, Taipei Hsien, Taiwan, R.O.C.

Date of Receipt	July 06, 2006
Issued Date	Aug. 23, 2006
Report No.	067L073-RF-US-P06V01

The Test Results relate only to the samples tested.

The test report shall not be reproduced except in full without the written approval of Quietek Corporation.

This report must not be used to claim product endorsement by NVLAP any agency of the U.S. Government

Test Report Certification

Issued Date: Aug. 23, 2006

Report No.: 067L073-RF-US-P06V01



Product Name	Bluetooth Music Audio Transmitter
Applicant	MICRO-STAR INTL Co., LTD.
Address	No. 69, Li-De St., Jung-He City, Taipei Hsien, Taiwan, R.O.C.
Manufacturer	MICRO-STAR INTL Co., LTD.
Model No.	MS-6868J
FCC ID.	I4L-MS6868J
Rated Voltage	AC 120V/60Hz
Working Voltage	AC 120V/60Hz
Trade Name	MSI
Applicable Standard	FCC CFR Title 47 Part 15 Subpart C: 2005 ANSI C63.4: 2003 CISPR 22: 2005
Test Result	Complied



The Test Results relate only to the samples tested.

The test report shall not be reproduced except in full without the written approval of Quietek Corporation.

This report must not be used to claim product endorsement by NVLAP any agency of the U.S. Government

Documented By : Rita Huang

(Rita Huang)



Tested By : Tom Hsieh

(Tom Hsieh)



0914

Approved By : George Chen

(George Chen)

TABLE OF CONTENTS

Description	Page
1. GENERAL INFORMATION	5
1.1. EUT Description.....	5
1.2. Operational Description.....	7
1.3. Test System Details	8
1.4. Configuration of Test System	8
1.5. EUT Exercise Software	8
1.6. Test Facility	10
2. CONDUCTED EMISSION	11
2.1. Test Equipment.....	11
2.2. Test Setup	11
2.3. Limits.....	12
2.4. Test Procedure	12
2.5. Uncertainty	12
2.6. Test Result of Conducted Emission.....	12
3. PEAK POWER OUTPUT	15
3.1. Test Equipment.....	15
3.2. Test Setup	15
3.3. Limit	15
3.4. Uncertainty	15
3.5. Test Result of Peak Power Output.....	16
4. RADIATED EMISSION	17
4.1. Test Equipment.....	17
4.2. Test Setup	18
4.3. Limits.....	18
4.4. Test Procedure	19
4.5. Uncertainty	19
4.6. Test Result of Radiated Emission.....	20
5. BAND EDGE	24
5.1. Test Equipment.....	24
5.2. Test Setup	24
5.3. Limit	25
5.4. Test Procedure	25
5.5. Uncertainty	25
5.6. Test Result of Band Edge	26
6. CHANNEL NUMBER.....	31
6.1. Test Equipment.....	31
6.2. Test Setup	31
6.3. Limit	31
6.4. Uncertainty	31
6.5. Test Result of Channel Number.....	32
7. CHANNEL SEPARATION.....	32

7.1.	Test Equipment	33
7.2.	Test Setup	33
7.3.	Limit	33
7.4.	Uncertainty	33
7.5.	Test Result of Channel Separation.....	34
8.	DWELL TIME	35
8.1.	Test Equipment	35
8.2.	Test Setup	35
8.3.	Limit	35
8.4.	Uncertainty	35
8.5.	Test Result of Dwell Time	36
9.	OCCUPIED BANDWIDTH	42
9.1.	Test Equipment	42
9.2.	Test Setup	42
9.3.	Limits.....	42
9.4.	Uncertainty	42
9.5.	Test Result of Occupied Bandwidth	43
10.	EMI REDUCTION METHOD DURING COMPLIANCE TESTING	46

Attachment 1: EUT Test Photographs
Attachment 2: EUT Detailed Photographs

1. GENERAL INFORMATION

1.1. EUT Description

Product Name	Bluetooth Music Audio Transmitter
Trade Name	MSI
FCC ID.	I4L-MS6868J
Model No.	MS-6868J
Frequency Range	2402 - 2480MHz
Type of Modulation	FHSS
Channel Number	79
Channel Control	Auto
Antenna Type	Chip Antenna
Antenna Gain	Refer to the table "Antenna List"
Power Adapter	MFR: SCOPE M/N: ZK-1006
Audio Cable	Non-Shielded, 0.11m
Mini USB Cable	Non-Shielded, 1m

Antenna List

No.	Manufacturer	Part No.	Peak Gain
1	YAGEO	CAN4311 1150 02451K	4.1 dBi for 2.4 GHz

Frequency of Each Channel:

Channel	Frequency	Channel	Frequency	Channel	Frequency	Channel	Frequency
Channel 00:	2402 MHz	Channel 20:	2422 MHz	Channel 40:	2442 MHz	Channel 60:	2462 MHz
Channel 01:	2403 MHz	Channel 21:	2423 MHz	Channel 41:	2443 MHz	Channel 61:	2463 MHz
Channel 02:	2404 MHz	Channel 22:	2424 MHz	Channel 42:	2444 MHz	Channel 62:	2464 MHz
Channel 03:	2405 MHz	Channel 23:	2425 MHz	Channel 43:	2445 MHz	Channel 63:	2465 MHz
Channel 04:	2406 MHz	Channel 24:	2426 MHz	Channel 44:	2446 MHz	Channel 64:	2466 MHz
Channel 05:	2407 MHz	Channel 25:	2427 MHz	Channel 45:	2447 MHz	Channel 65:	2467 MHz
Channel 06:	2408 MHz	Channel 26:	2428 MHz	Channel 46:	2448 MHz	Channel 66:	2468 MHz
Channel 07:	2409 MHz	Channel 27:	2429 MHz	Channel 47:	2449 MHz	Channel 67:	2469 MHz
Channel 08:	2410 MHz	Channel 28:	2430 MHz	Channel 48:	2450 MHz	Channel 68:	2470 MHz
Channel 09:	2411 MHz	Channel 29:	2431 MHz	Channel 49:	2451 MHz	Channel 69:	2471 MHz
Channel 10:	2412 MHz	Channel 30:	2432 MHz	Channel 50:	2452 MHz	Channel 70:	2472 MHz
Channel 11:	2413 MHz	Channel 31:	2433 MHz	Channel 51:	2453 MHz	Channel 71:	2473 MHz
Channel 12:	2414 MHz	Channel 32:	2434 MHz	Channel 52:	2454 MHz	Channel 72:	2474 MHz
Channel 13:	2415 MHz	Channel 33:	2435 MHz	Channel 53:	2455 MHz	Channel 73:	2475 MHz
Channel 14:	2416 MHz	Channel 34:	2436 MHz	Channel 54:	2456 MHz	Channel 74:	2476 MHz
Channel 15:	2417 MHz	Channel 35:	2437 MHz	Channel 55:	2457 MHz	Channel 75:	2477 MHz
Channel 16:	2418 MHz	Channel 36:	2438 MHz	Channel 56:	2458 MHz	Channel 76:	2478 MHz
Channel 17:	2419 MHz	Channel 37:	2439 MHz	Channel 57:	2459 MHz	Channel 77:	2479 MHz
Channel 18:	2420 MHz	Channel 38:	2440 MHz	Channel 58:	2460 MHz	Channel 78:	2480 MHz
Channel 19:	2421 MHz	Channel 39:	2441 MHz	Channel 59:	2461 MHz		

The system receivers have input bandwidths that match the hopping channel bandwidths of their corresponding transmitters and shift frequencies in synchronization with the transmitted signals

Frequency hopping spread spectrum systems are not required to employ all available hopping channels during each transmission. The transmitter is presented with a continuous data stream. In addition, a system employing short transmission bursts must comply with the definition of a frequency hopping system and must distribute its 79 channels and over the minimum number of hopping channels (75 channels).

The incorporation of intelligence within a frequency hopping spread spectrum system that permits the system to recognize other users within the spectrum band so that it individually and independently chooses and adapts its hopsets to avoid hopping on occupied channels is permitted. The coordination of frequency hopping systems in any other manner for the express purpose of avoiding the simultaneous occupancy of individual hopping frequencies by multiple transmitters is not permitted.

Note:

1. The EUT is a Bluetooth Music Audio Transmitter with a built-in 2.4GHz transceiver.
2. These tests were conducted on a sample of the equipment for the purpose of demonstrating compliance with Part 15 Subpart C Paragraph 15.247 for spread spectrum devices.
3. Regarding to the operation frequency band, the lowest, middle, and highest frequency are selected to perform the test.
4. QuieTek verified constructions and functions, which are shown in the test report, in typical operation.
5. The radiation measurements are performed in X, Y, Z axis positioning. Only the worst case is shown in the report.

1.2. Operational Description

The EUT is a Bluetooth Music Audio Transmitter with a built-in 2.4GHz transceiver. The signals are modulated by frequency hopping spread spectrum. The number of channels is 79 in 2402-2480MHz.

The EUT provides wireless technology that revolutionizes personal connectivity. It is the solution for the seamless integration of Bluetooth technology into personal computer enabling short-range wireless connections between desktop/laptop computers, Bluetooth-enabled peripherals, and portable handheld devices.

Test Mode	Mode 1: Transmitter
-----------	---------------------

1.3. Test System Details

The types for all equipment, plus descriptions of all cables used in the tested system (including inserted cards) are:

	Product	Manufacturer	Model No.	Serial No.	Power Cord
(1)	External Socket	N/A	N/A	N/A	Non-Shielded, 1.5m
(2)	RF Control board	MSI	TL372	N/A	N/A
(3)	Notebook PC	DELL	PP18L	42649348672	Non-Shielded, 1.8m

	Signal Cable Type	Signal cable Description
A.	Mini USB Cable	Non-Shielded, 1.0m
B.	RS232 Cable	Shielded, 1.5m
C.	USB Cable	Shielded, 1.0m

1.4. Configuration of Test System

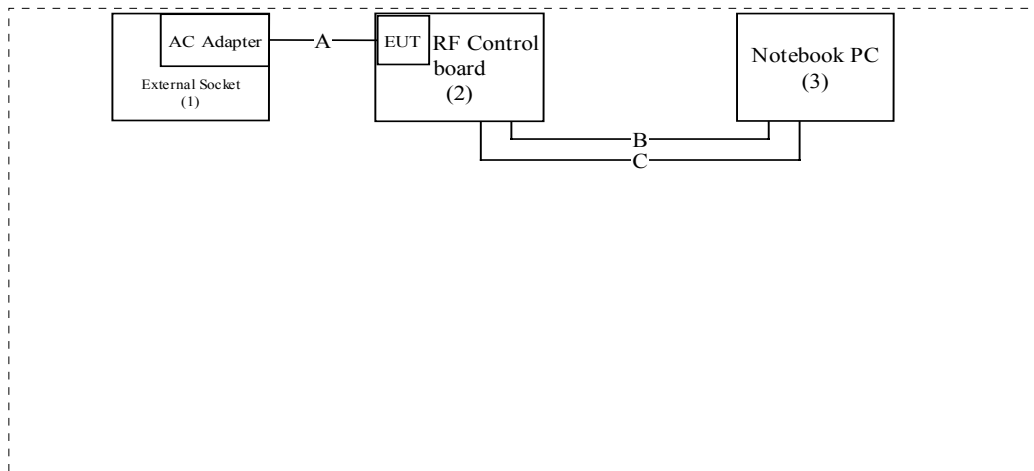

1.5. EUT Exercise Software

- (1) Setup the EUT as shown in Section 1.4.
- (2) Execute the BlueTest (v1.9.1) program on the notebook.
- (3) Configure the test channel and the packet type.
- (4) Press “OK” to start the continuous transmission.
- (5) Verify the EUT operation properly.

1.6. Test Facility

Ambient conditions in the laboratory:

Items	Required (IEC 68-1)	Actual
Temperature (°C)	15-35	20-35
Humidity (%RH)	25-75	30-65
Barometric pressure (mbar)	860-1060	950-1000

Site Description: Federal Communications Commission
 FCC Engineering Laboratory
 7435 Oakland Mills Road
 Columbia, MD 21046
 Reference 31040/SIT1300F2



Accreditation on NVLAP
 NVLAP Lab Code: 200533-0



Site Name: Quietek Corporation
 Site Address: No. 5-22, Ruei-Shu Valley, Ruei-Ping Tsuen,
 Lin-Kou Shiang, Taipei,
 Taiwan, R.O.C.
 TEL: 886-2-8601-3788 / FAX : 886-2-8601-3789
 E-Mail : service@quietek.com



2. Conducted Emission

2.1. Test Equipment

Item	Instrument	Manufacturer	Type No./Serial No	Last Cal.	Remark
1	EMI Test Receiver	R&S	ESCS 30/100367	Aug., 2006	
2	LISN	R&S	ESH3-Z5/836679/023	July, 2006	EUT
3	LISN	R&S	ESH3-Z5/836679/017	Feb., 2006	Peripherals
4	Pulse Limiter	R&S	ESH3-Z2/357.8810.52	Sep., 2005	
5	No.7 Shielded Room			N/A	

Note: All equipments are calibrated every one year.

2.2. Test Setup

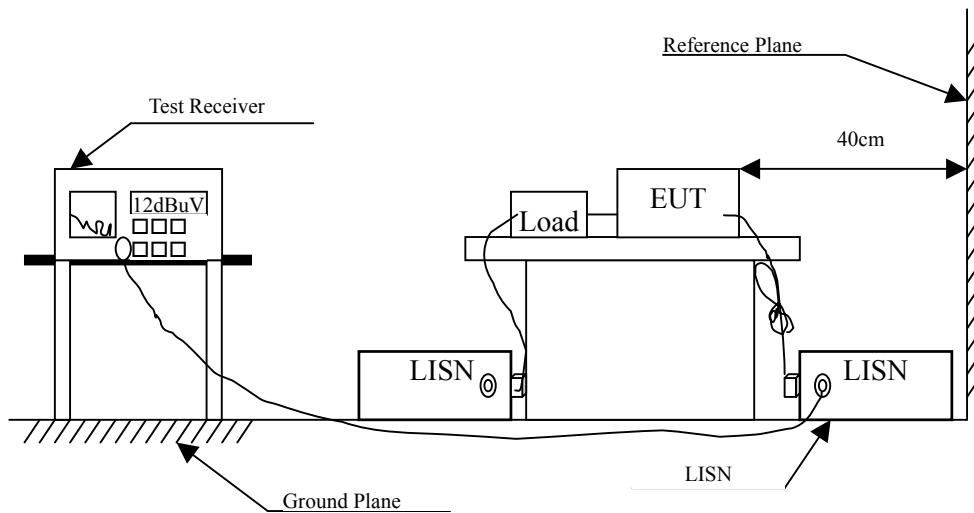

2.3. Limits

FCC Part 15 Subpart C Paragraph 15.207 (dBuV) Limit		
Frequency MHz	Limits	
	QP	AV
0.15 - 0.50	66-56	56-46
0.50-5.0	56	46
5.0 - 30	60	50

Remarks: In the above table, the tighter limit applies at the band edges.

2.4. Test Procedure

The EUT and simulators are connected to the main power through a line impedance stabilization network (L.I.S.N.). This provides a 50 ohm /50uH coupling impedance for the measuring equipment. The peripheral devices are also connected to the main power through a LISN that provides a 50ohm /50uH coupling impedance with 50ohm termination. (Please refers to the block diagram of the test setup and photographs.)

Both sides of A.C. line are checked for maximum conducted interference. In order to find the maximum emission, the relative positions of equipment and all of the interface cables must be changed according to ANSI C63.4: 2003 on conducted measurement.

Conducted emissions were invested over the frequency range from 0.15MHz to 30MHz using a receiver bandwidth of 9kHz.

2.5. Uncertainty

± 2.26 dB

2.6. Test Result of Conducted Emission

Product : Bluetooth Music Audio Transmitter
 Test Item : Conducted Emission Test
 Power Line : Line 1
 Test Mode : Mode 1: Transmitter (Channel 39)

Frequency	Correct	Reading	Measurement	Margin	Limit
-----------	---------	---------	-------------	--------	-------

MHz	Factor dB	Level dBuV	Level dBuV	dB	dBuV
Quasi-Peak					
0.267	0.305	56.560	56.865	-5.792	62.657
0.408	0.300	54.210	54.510	-4.119	58.629
0.430	0.300	49.240	49.540	-8.460	58.000
0.728	0.310	49.150	49.460	-6.540	56.000
1.013	0.319	45.210	45.529	-10.471	56.000
1.279	0.320	45.990	46.310	-9.690	56.000
Average					
0.267	0.305	36.930	37.235	-15.422	52.657
0.408	0.300	41.970	42.270	-6.359	48.629
0.430	0.300	39.860	40.160	-7.840	48.000
0.728	0.310	35.270	35.580	-10.420	46.000
1.013	0.319	27.000	27.319	-18.681	46.000
1.279	0.320	28.670	28.990	-17.010	46.000

Note:

1. All reading levels are quasi-peak and average value.
2. "■" means the worst emission level.
3. Measurement Level = Reading Level + Correct Factor.

Product : Bluetooth Music Audio Transmitter
 Test Item : Conducted Emission Test
 Power Line : Line 2
 Test Mode : Mode 1: Transmitter (Channel 39)

Frequency MHz	Correct Factor dB	Reading Level dBuV	Measurement Level dBuV	Margin dB	Limit dBuV
Quasi-Peak					
0.201	0.300	56.700	57.000	-7.543	64.543
0.275	0.300	51.690	51.990	-10.439	62.429
0.340	0.303	51.090	51.393	-9.178	60.571
0.670	0.310	52.840	53.150	-2.850	56.000
1.142	0.330	48.250	48.580	-7.420	56.000
1.267	0.330	44.850	45.180	-10.820	56.000
Average					
0.201	0.300	35.030	35.330	-19.213	54.543
0.275	0.300	31.770	32.070	-20.359	52.429
0.340	0.303	33.480	33.783	-16.788	50.571
0.670	0.310	35.770	36.080	-9.920	46.000
1.142	0.330	29.230	29.560	-16.440	46.000
1.267	0.330	27.460	27.790	-18.210	46.000

Note:

1. All reading levels are quasi-peak and average value.
2. "■" means the worst emission level.
3. Measurement Level = Reading Level + Correct Factor.

3. Peak Power Output

3.1. Test Equipment

	Equipment	Manufacturer	Model No./Serial No.	Last Cal.
X	EMI Test Receiver	R & S	ESI 26 / 838786/004	May, 2006

- Note:
1. All equipments are calibrated every one year.
 2. Test instruments marked by “X” are used to measure the final test results.

3.2. Test Setup

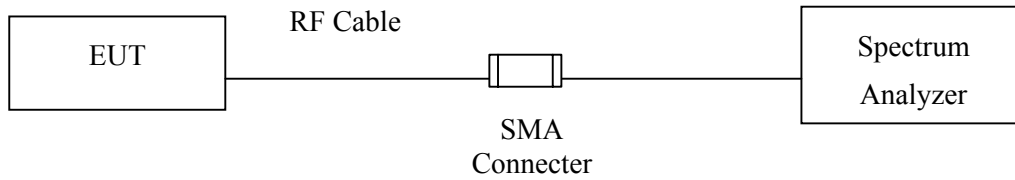

3.3. Limit

The maximum peak power shall be less 1Watt.

3.4. Uncertainty

± 1.27 dB

3.5. Test Result of Peak Power Output

Product : Bluetooth Music Audio Transmitter
 Test Item : Peak Power Output
 Test Site : No.3 OATS
 Test Mode : Mode 1: Transmitter

Channel No.	Frequency (MHz)	Measurement	Required Limit	Result
Channel 00	2402.00	-1.55dBm	1 Watt= 30 dBm	Pass
Channel 39	2441.00	-0.88dBm	1 Watt= 30 dBm	Pass
Channel 78	2480.00	-0.86dBm	1 Watt= 30 dBm	Pass

Channel 00

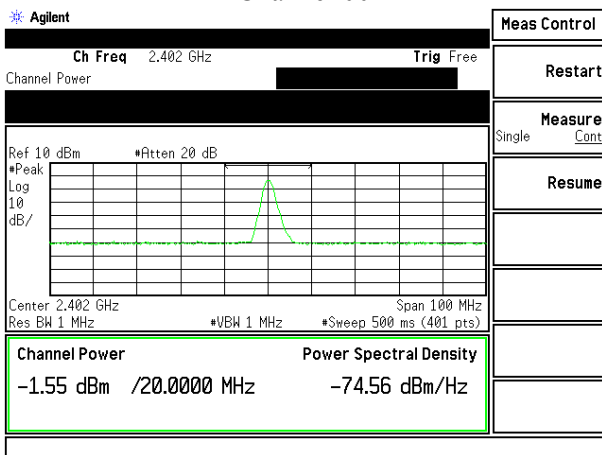

Channel 39

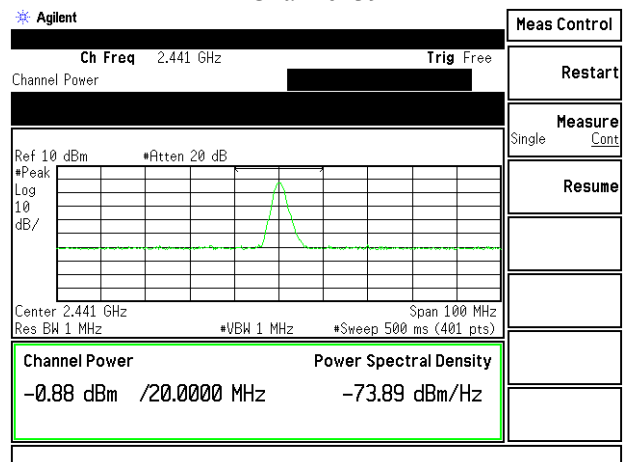

Channel 78

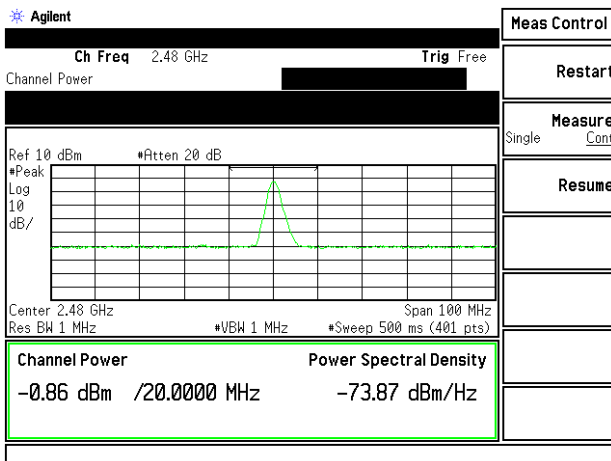

4. Radiated Emission

4.1. Test Equipment

Test Site		Equipment	Manufacturer	Model No./Serial No.	Last Cal.
<input type="checkbox"/> Site # 1		Test Receiver	R & S	ESVS 10 / 834468/003	May, 2006
		Spectrum Analyzer	Advantest	R3162/ 00803480	May, 2006
		Pre-Amplifier	Advantest	BB525C/ 3307A01812	May, 2006
		Bilog Antenna	SCHAFFNER	CBL6112B / 2697	Sep., 2005
<input type="checkbox"/> Site # 2		Test Receiver	R & S	ESCS 30 / 836858 / 022	May, 2006
		Spectrum Analyzer	Advantest	R3162 / 100803466	May, 2006
		Pre-Amplifier	Advantest	BB525C/3307A01814	May, 2006
		Bilog Antenna	SCHAFFNER	CBL6112B / 2705	May, 2006
		Horn Antenna	ETS	3115 / 0005-6160	Sep., 2005
		Pre-Amplifier	QTK	QTK-AMP-01/ 0001	May, 2006
<input checked="" type="checkbox"/> Site # 3	X	Test Receiver	R & S	ESI 26 / 838786/004	May, 2006
	X	Spectrum Analyzer	Advantest	R3162 / 100803480	May, 2006
	X	Bilog Antenna	SCHAFFNER	CBL6112B / 2697	May, 2006
	X	Horn Antenna	Schwarzbeck	9120D / 305, 306	July, 2006
	X	Horn Antenna	Schwarzbeck	BBHA9170 / 208, 209	July, 2006
	X	Pre-Amplifier	QTK	QTK-AMP-03 / 0003	May, 2006
	X	Pre-Amplifier	HP	8449B / 3008A01123	July, 2006
	X	Pre-Amplifier	MITEQ	AMF-4D-180400-45-6P	May, 2006

- Note: 1. All equipments are calibrated every one year.
 2. Test equipments marked by "X" are used to measure the final test results.

4.2. Test Setup

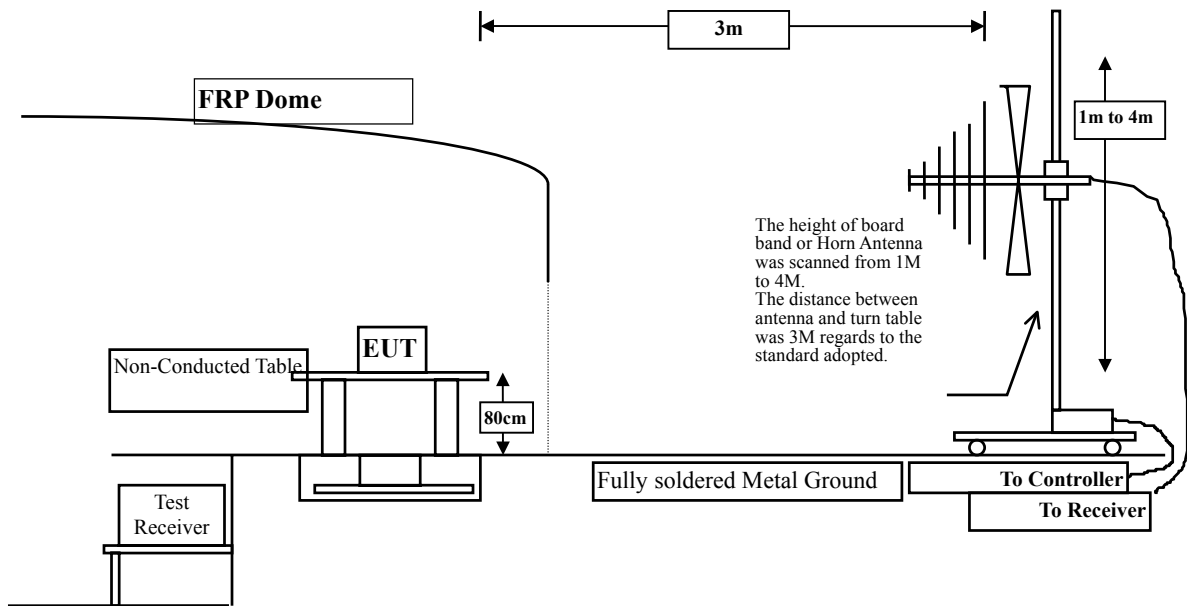

4.3. Limits

➤ General Radiated Emission Limits

Emissions radiated outside of the specified frequency bands, except for harmonics, shall be attenuated by at least 20dB below the level of the fundamental or to the general radiated emission limits in paragraph 15.209, whichever is the lesser attenuation.

FCC Part 15 Subpart C Paragraph 15.209 Limits		
Frequency MHz	uV/m @3m	dBuV/m@3m
30-88	100	40
88-216	150	43.5
216-960	200	46
Above 960	500	54

- Remarks:
1. RF Voltage (dBuV) = 20 log RF Voltage (uV)
 2. In the Above Table, the tighter limit applies at the band edges.
 3. Distance refers to the distance in meters between the measuring instrument antenna and the closed point of any part of the device or system.

4.4. Test Procedure

The EUT and its simulators are placed on a turn table which is 0.8 meter above ground. The turn table can rotate 360 degrees to determine the position of the maximum emission level.

The EUT was positioned such that the distance from antenna to the EUT was 3 meters.

The antenna can move up and down between 1 meter and 4 meters to find out the maximum emission level.

Both horizontal and vertical polarization of the antenna are set on measurement. In order to find the maximum emission, all of the interface cables must be manipulated according to ANSI C63.4: 2003 on radiated measurement.

The additional latch filter below 1GHz was used to measure the level of harmonics radiated emission during field strength of harmonics measurement.

The bandwidth below 1GHz setting on the field strength meter is 120 kHz, above 1GHz are 1 MHz.

The frequency range from 30MHz to 10th harmonics is checked.

4.5. Uncertainty

± 3.9 dB above 1GHz

± 3.8 dB below 1GHz

4.6. Test Result of Radiated Emission

Product : Bluetooth Music Audio Transmitter
 Test Item : Harmonic Radiated Emission
 Test Site : No.3 OATS
 Test Mode : Mode 1: Transmitter (Channel 00)

Frequency MHz	Correct Factor dB	Reading Level dBuV	Measurement Level dBuV/m	Margin dB	Limit dBuV/m
Horizontal					
Peak Detector:					
4804.000	3.737	49.983	53.720	-20.280	74.000
7206.000	10.741	38.006	48.747	-25.253	74.000
9608.000	14.854	37.706	52.560	-21.440	74.000
Average Detector:					
--					
Vertical					
Peak Detector:					
4804.000	3.737	50.399	54.136	-19.864	74.000
7206.000	10.741	37.783	48.524	-25.476	74.000
9608.000	14.854	38.189	53.043	-20.957	74.000
Average Detector:					
4804.000	3.737	46.475	50.212	-3.788	54.00

Note:

1. The reading levels below 1GHz and above 1GHz are quasi-peak values and peak/average values, respectively.
2. Receiver setting (Peak Detector) : RBW:1MHz; VBW:1MHz; Span:100MHz ◦
3. Receiver setting (AVG Detector) : RBW:1MHz; VBW:30Hz; Span:20MHz ◦
4. Emission Level = Reading Level + Correct Factor.
5. The average measurement was not performed when the peak measured data under the limit of average detection. If the readings given are average, peak measurement should also be supplied.

Product : Bluetooth Music Audio Transmitter
 Test Item : Harmonic Radiated Emission
 Test Site : No.3 OATS
 Test Mode : Mode 1: Transmitter (Channel 39)

Frequency MHz	Correct Factor dB	Reading Level dBuV	Measurement Level dBuV/m	Margin dB	Limit dBuV/m
Horizontal					
Peak Detector:					
4882.000	3.932	50.480	54.412	-19.588	74.000
7323.000	11.633	37.925	49.557	-24.443	74.000
9764.000	13.740	38.740	52.480	-21.520	74.000
Average Detector:					
4882.000	3.932	47.307	51.239	-2.761	54.000
Vertical					
Peak Detector:					
4882.000	3.932	53.320	57.252	-16.748	74.000
7323.000	11.633	38.542	50.174	-23.826	74.000
9764.000	13.740	37.942	51.682	-22.318	74.000
Average Detector:					
4882.000	3.932	49.670	53.602	-0.398	54.000

Note:

1. The reading levels below 1GHz and above 1GHz are quasi-peak values and peak/average values, respectively.
2. Receiver setting (Peak Detector) : RBW:1MHz; VBW:1MHz; Span:100MHz ◦
3. Receiver setting (AVG Detector) : RBW:1MHz; VBW:30Hz; Span:20MHz ◦
4. Emission Level = Reading Level + Correct Factor.
5. The average measurement was not performed when the peak measured data under the limit of average detection. If the readings given are average, peak measurement should also be supplied.

Product : Bluetooth Music Audio Transmitter
 Test Item : Harmonic Radiated Emission
 Test Site : No.3 OATS
 Test Mode : Mode 1: Transmitter (Channel 78)

Frequency MHz	Correct Factor dB	Reading Level dBuV	Measurement Level dBuV/m	Margin dB	Limit dBuV/m
Horizontal					
Peak Detector:					
4960.000	4.151	50.202	54.352	-19.648	74.000
7440.000	12.067	37.660	49.726	-24.274	74.000
9920.000	13.472	37.806	51.277	-22.723	74.000
Average Detector:					
4960.000	4.151	46.160	50.310	-3.690	54.000
Vertical					
Peak Detector:					
4960.000	4.151	51.940	56.090	-17.910	74.000
7440.000	12.067	37.162	49.228	-24.772	74.000
9920.000	13.472	38.076	51.547	-22.453	74.000
Average Detector:					
4960.000	4.151	47.985	52.135	-1.865	54.000

Note:

1. Reading levels below 1GHz and above 1GHz are quasi-peak values and peak/average values, respectively.
2. Receiver setting (Peak Detector) : RBW:1MHz; VBW:1MHz; Span:100MHz ◦
3. Receiver setting (AVG Detector) : RBW:1MHz; VBW:30Hz; Span:20MHz ◦
4. Emission Level = Reading Level + Correct Factor.
5. The average measurement was not performed when the peak measured data under the limit of average detection. If the readings given are average, peak measurement should also be supplied.

Product : Bluetooth Music Audio Transmitter
 Test Item : General Radiated Emission
 Test Site : No.3 OATS
 Test Mode : Mode 1: Transmitter (Channel 39)

Frequency MHz	Correct Factor dB	Reading Level dBuV	Measurement Level dBuV/m	Margin dB	Limit dBuV/m
Horizontal					
175.500	8.949	19.551	28.500	-15.000	43.500
190.100	8.555	21.200	29.755	-13.745	43.500
199.900	8.821	20.900	29.721	-13.779	43.500
206.600	8.848	20.700	29.548	-13.952	43.500
253.900	12.715	18.100	30.815	-15.185	46.000
272.500	12.246	18.900	31.146	-14.854	46.000
Vertical					
37.100	14.482	18.100	32.582	-7.418	40.000
105.100	10.474	20.100	30.573	-12.927	43.500
110.100	11.261	21.200	32.461	-11.039	43.500
175.500	8.907	28.100	37.007	-6.493	43.500
202.100	8.953	16.200	25.153	-18.347	43.500
207.100	9.136	15.600	24.736	-18.764	43.500

Note:

1. The reading levels below 1GHz are quasi-peak values.
2. “█” means the worst emission level.
3. Measurement Level = Reading Level + Correct Factor
4. The radiated emissions below 1GHz of the lowest, middle, highest frequency are pretested. Only the worst case is shown on the report.

5. Band Edge

5.1. Test Equipment

Equipment	Manufacturer	Model No./Serial No.	Last Cal.
X Test Receiver	R & S	ESI 26 / 838786/004	May, 2006
X Spectrum Analyzer	Advantest	R3162 / 100803480	May, 2006
X Bilog Antenna	SCHAFFNER	CBL6112B / 2697	May, 2006
X Horn Antenna	Schwarzbeck	9120D / 305, 306	July, 2006
X Horn Antenna	Schwarzbeck	BBHA9170 / 208, 209	July, 2006
X Pre-Amplifier	QTK	QTK-AMP-03 / 0003	May, 2006
X Pre-Amplifier	HP	8449B / 3008A01123	July, 2006
X Pre-Amplifier	MITEQ	AMF-4D-180400-45-6P	May, 2006

OATS No.3

- Note:
1. All equipments are calibrated every one year.
 2. The test equipments marked by "X" are used to measure the final test results.

5.2. Test Setup

RF Radiated Measurement:

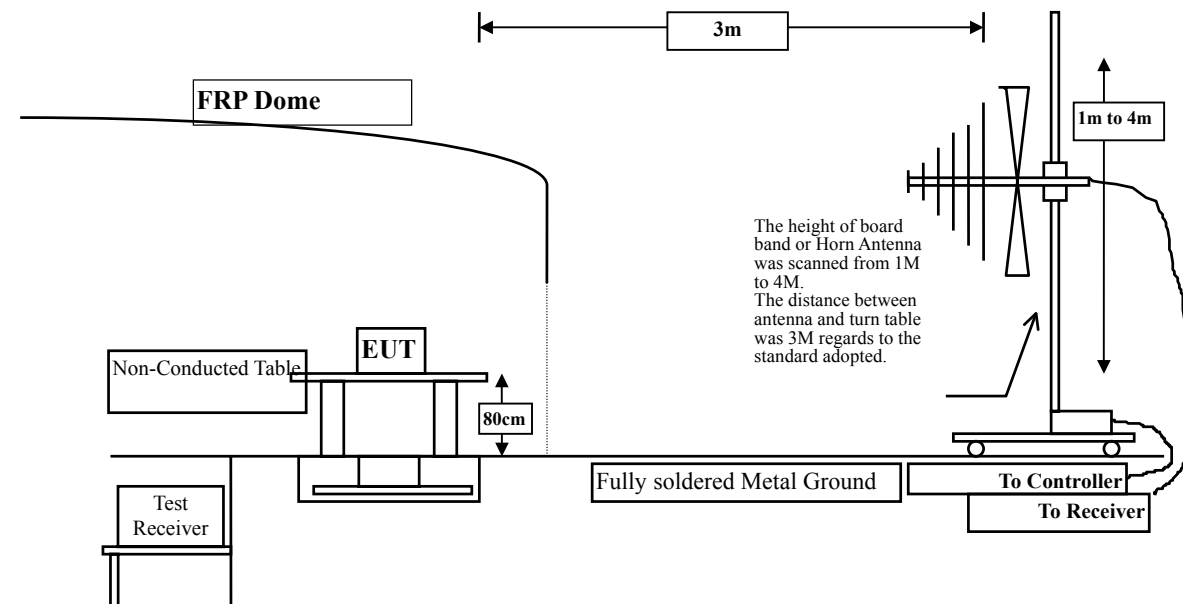

5.3. Limit

In any 100 kHz bandwidth outside the frequency band in which the spread spectrum intentional radiator is operating, the radio frequency power that is produced by the intentional radiator shall be at least 20 dB below that in the 100 kHz bandwidth within the band that contains the highest level of the desired power, based on either an RF conducted or a radiated measurement. Attenuation below the general limits specified in Section 15.209(a) is not required. In addition, radiated emissions which fall in the restricted bands, as defined in Section 15.205(a), must also comply with the radiated emission limits specified in Section 15.209(a) (see Section 15.205(c)).

5.4. Test Procedure

The EUT and its simulators are placed on a turn table which is 0.8 meter above ground. The turn table can rotate 360 degrees to determine the position of the maximum emission level. The EUT was positioned such that the distance from antenna to the EUT was 3 meters.

The antenna can move up and down between 1 meter and 4 meters to find out the maximum emission level.

Both horizontal and vertical polarization of the antenna are set on measurement. In order to find the maximum emission, all of the interface cables must be manipulated according to ANSI C63.4:2003 on radiated measurement.

The bandwidth below 1GHz setting on the field strength meter is 120 kHz, above 1GHz are 1 MHz.

5.5. Uncertainty

± 3.9 dB above 1GHz

± 3.8 dB below 1GHz

5.6. Test Result of Band Edge

Product : Bluetooth Music Audio Transmitter
 Test Item : Band Edge
 Test Site : No.3 OATS
 Test Mode : Mode 1: Transmitter (Channel 00)

RF Radiated Measurement:

Channel No.	Frequency (MHz)	Required Limit (dBc)	Result
00	<2400	>20	Pass

RF Radiated Measurement (Horizontal):

Channel No.	Frequency (MHz)	Correct Factor (dB)	Reading Level (dBuV)	Emission Level (dBuV/m)	Peak Limit (dBuV/m)	Average Limit (dBuV/m)	Result
00(Peak)	2387.000	-2.267	47.572	45.305	74.00	54.00	Pass
00(Avg)	--	--	--	--	74.00	54.00	Pass

Figure Channel 00:

Horizontal (Peak)

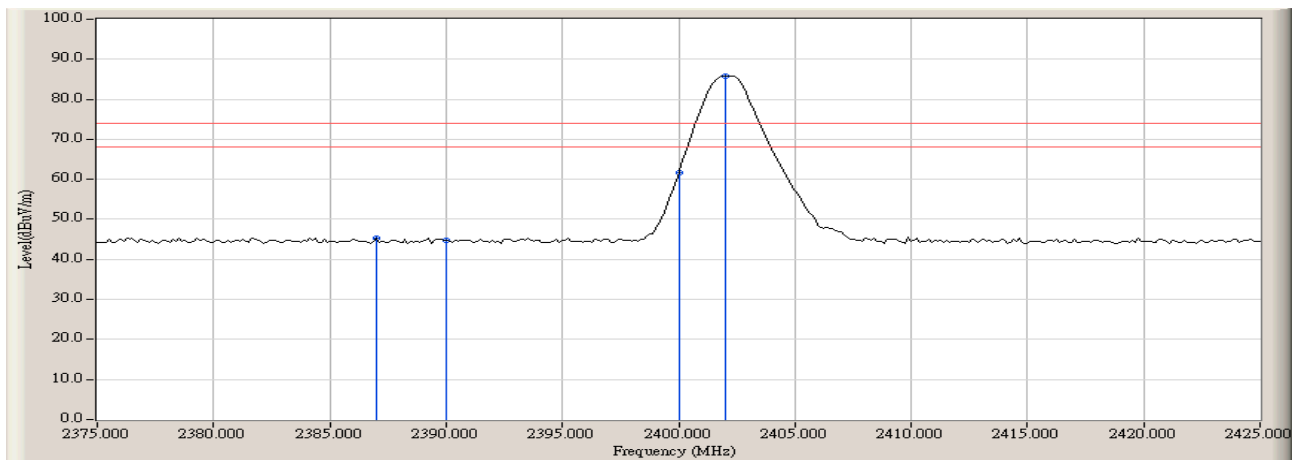

Note:

RBW=1MHz, VBW=1MHz, Sweep Time=500ms.

Product : Bluetooth Music Audio Transmitter
 Test Item : Band Edge
 Test Site : No.3 OATS
 Test Mode : Mode 1: Transmitter (Channel 00)

RF Radiated Measurement:

Channel No.	Frequency (MHz)	Required Limit (dBc)	Result
00	<2400	>20	Pass

RF Radiated Measurement (Vertical):

Channel No.	Frequency (MHz)	Correct Factor (dB)	Reading Level (dBUV)	Emission Level (dBUV/m)	Peak Limit (dBUV/m)	Average Limit (dBUV/m)	Result
00(Peak)	2375.500	-2.305	47.557	45.252	74.00	54.00	Pass
00(Avg)	--	--	--	--	74.00	54.00	Pass

Figure Channel 00: Vertical (Peak)

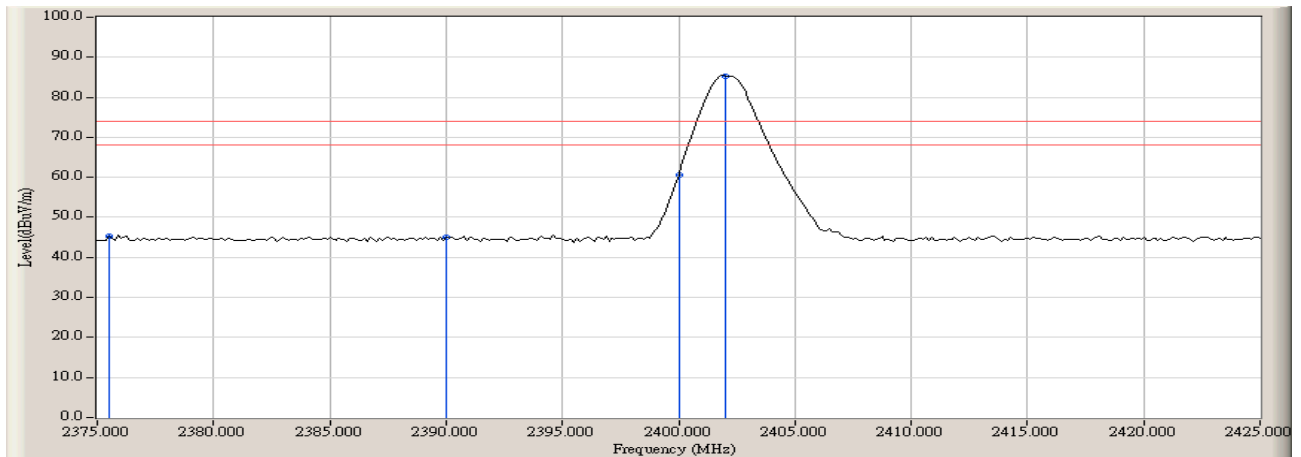

Note:

RBW=1MHz, VBW=1MHz, Sweep Time=500ms.

Product : Bluetooth Music Audio Transmitter
 Test Item : Band Edge
 Test Site : No.3 OATS
 Test Mode : Mode 1: Transmitter (Channel 78)

RF Radiated Measurement:

Channel No.	Frequency (MHz)	Required Limit (dBc)	Result
78	>2483.5	>20	Pass

RF Radiated Measurement (Horizontal):

Channel No.	Frequency (MHz)	Correct Factor (dB)	Reading Level (dBuV)	Emission Level (dBuV/m)	Peak Limit (dBuV/m)	Average Limit (dBuV/m)	Result
00(Peak)	2483.500	-1.896	58.633	56.738	74.00	54.00	Pass
00(Avg)	2483.500	-1.896	55.398	53.503	74.00	54.00	Pass

Figure Channel 78: Horizontal (Peak)

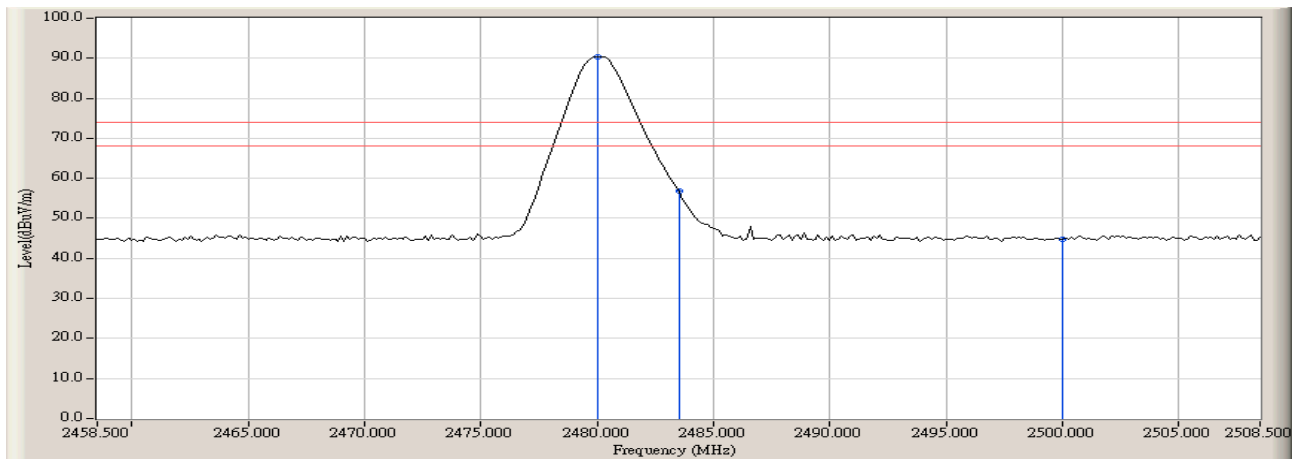

Note:
 RBW=1MHz, VBW=1MHz, Sweep Time=500ms

Figure Channel 78:

Horizontal (Average)

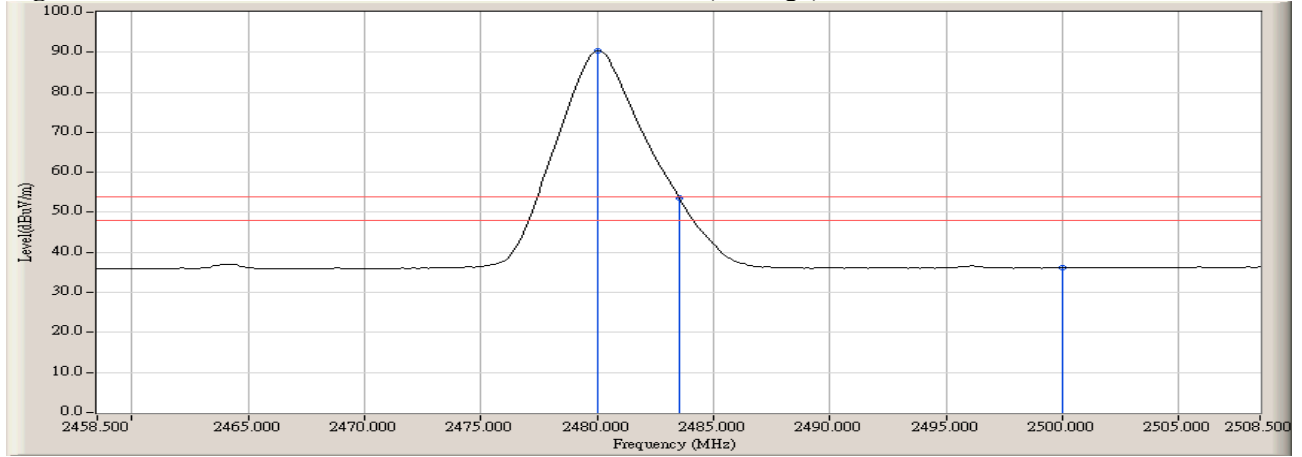

Note:

1. RBW=1MHz, VBW=3kHz, Sweep Time=500ms
2. VBW Justification: Ton (on time of a pulse)=400us, $VBW \geq 1/Ton=2.5kHz$

Product : Bluetooth Music Audio Transmitter
 Test Item : Band Edge
 Test Site : No.3 OATS
 Test Mode : Mode 1: Transmitter (Channel 78)

RF Radiated Measurement:

Channel No.	Frequency (MHz)	Required Limit (dBc)	Result
78	>2483.5	>20	Pass

RF Radiated Measurement (Vertical):

Channel No.	Frequency (MHz)	Correct Factor (dB)	Reading Level (dBuV)	Emission Level (dBuV/m)	Peak Limit (dBuV/m)	Average Limit (dBuV/m)	Result
00(Peak)	2483.500	-1.896	55.316	53.421	74.00	54.00	Pass
00(Avg)	--	--	--	--	74.00	54.00	Pass

Figure Channel 78:

Vertical (Peak)

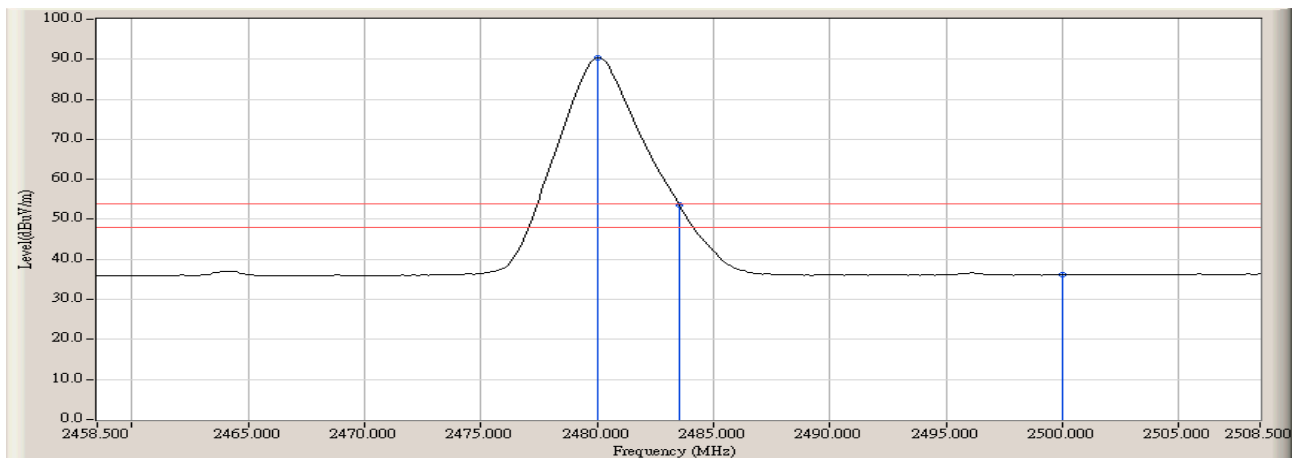

Note:
 RBW=1MHz, VBW=1MHz, Sweep Time=500ms.

Note: The average measurement was not performed when the peak measured data under the limit of average detection. If the readings given are average, peak measurement should also be supplied.

6. Channel Number

6.1. Test Equipment

	Equipment	Manufacturer	Model No./Serial No.	Last Cal.
X	EMI Test Receiver	R & S	ESI 26 / 838786/004	May, 2006

Note: 1. All equipments are calibrated every one year.
 2. The test equipments marked by “X” are used to measure the final test results.

6.2. Test Setup

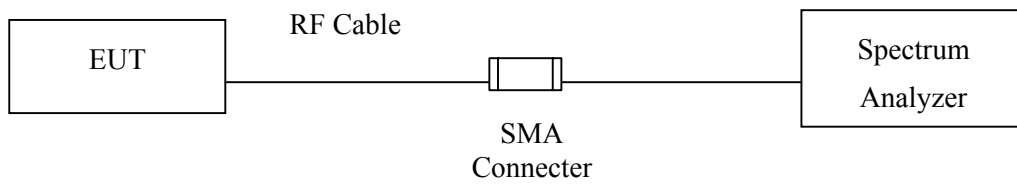

6.3. Limit

Frequency hopping systems operating in the 2400-2483.5 MHz bands shall use at least 75 hopping frequencies.

6.4. Uncertainty

N/A

6.5. Test Result of Channel Number

Product : Bluetooth Music Audio Transmitter
 Test Item : Channel Number
 Test Site : No.3 OATS
 Test Mode : Mode 1: Transmitter

Frequency Range (MHz)	Measurement (Hopping Channel)	Required Limit (Hopping Channel)	Result
2402 ~ 2480	79	>75	Pass

2402-2421MHz

2422-2441MHz

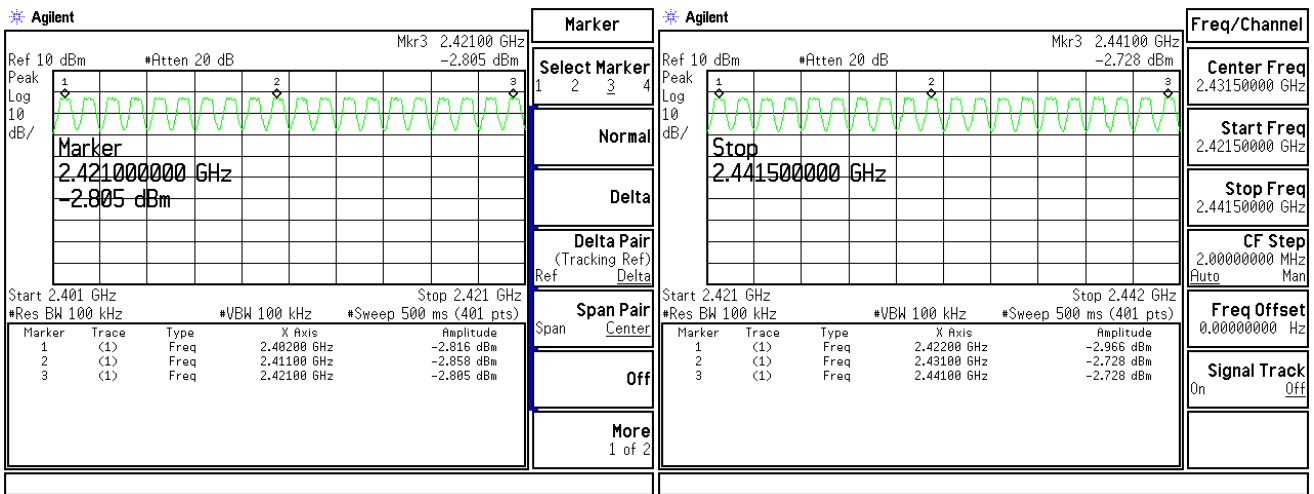

2442-2471MHz

2472-2481MHz

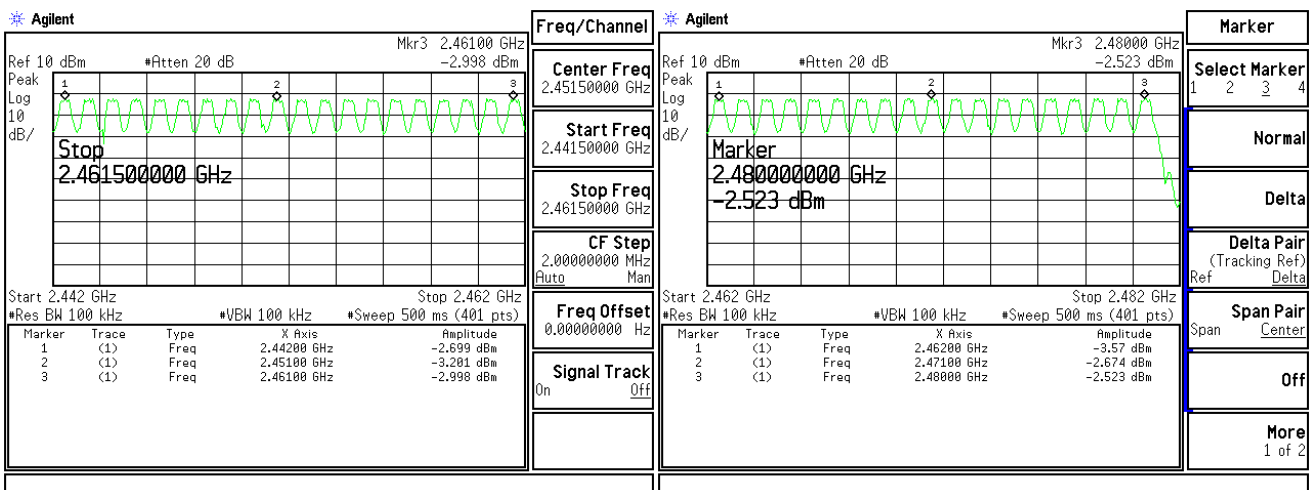

7. Channel Separation

7.1. Test Equipment

	Equipment	Manufacturer	Model No./Serial No.	Last Cal.
X	EMI Test Receiver	R & S	ESI 26 / 838786/004	May, 2006

Note: 1. All equipments are calibrated every one year.
 2. The test instruments marked by “X” are used to measure the final test results.

7.2. Test Setup

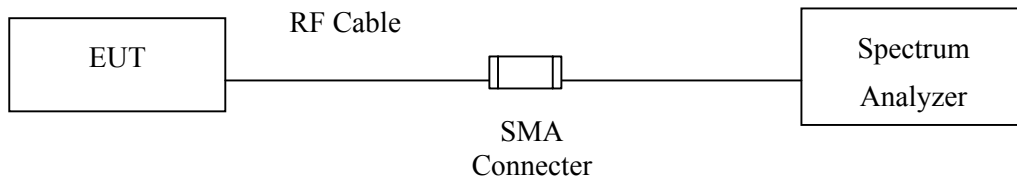

7.3. Limit

Frequency hopping systems shall have hopping channel carrier frequencies separated by a minimum of 25 kHz or the 20 dB bandwidth of the hopping channel, whichever is greater. Alternatively, frequency hopping systems operating in the 2400-2483.5 MHz band may have hopping channel carrier frequencies that are separated by 25 kHz or two-thirds of the 20 dB bandwidth of the hopping channel, whichever is greater, provided the systems operate with an output power no greater than 125mW.

7.4. Uncertainty

± 150Hz

7.5. Test Result of Channel Separation

Product : Bluetooth Music Audio Transmitter
 Test Item : Channel Separation
 Test Site : No.3 OATS
 Test Mode : Mode 1: Transmitter

Frequency (MHz)	Measurement Level (MHz)	Required Limit	Result
2402	1.00	>25 kHz or 2/3 * 20 dB BW	Pass
2441	1.00	>25 kHz or 2/3 * 20 dB BW	Pass
2480	1.00	>25 kHz or 2/3 * 20 dB BW	Pass

Channel 00 2402MHz

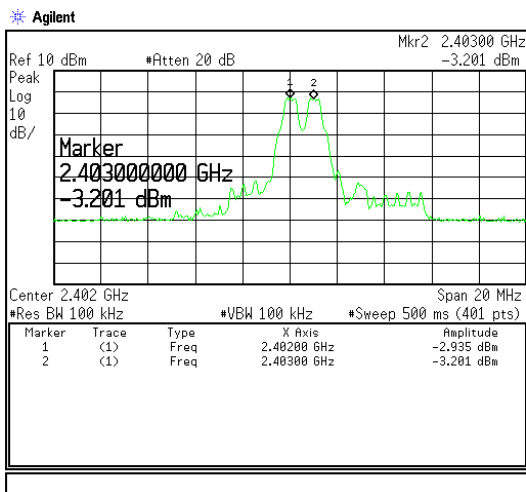

Select Marker	1 2 3 4
Normal	
Delta	
Delta Pair (Tracking Ref)	Ref Delta
Span Pair	Span Center
Off	
More	1 of 2

Channel 39 2441MHz

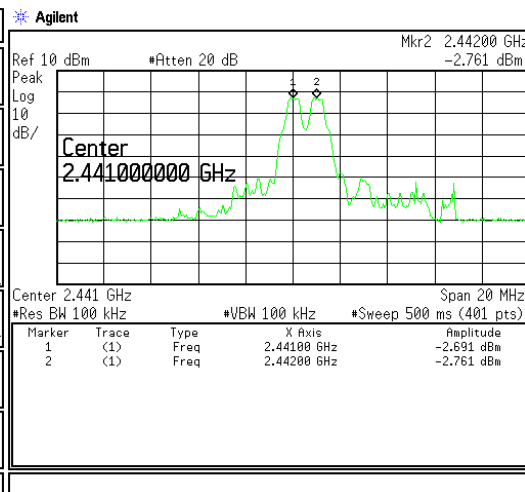

Freq/Channel	
Center Freq	2.44100000 GHz
Start Freq	2.43100000 GHz
Stop Freq	2.45100000 GHz
CF Step	2.00000000 MHz Auto Man
Freq Offset	0.00000000 Hz
Signal Track	On Off

Channel 78 2480 MHz

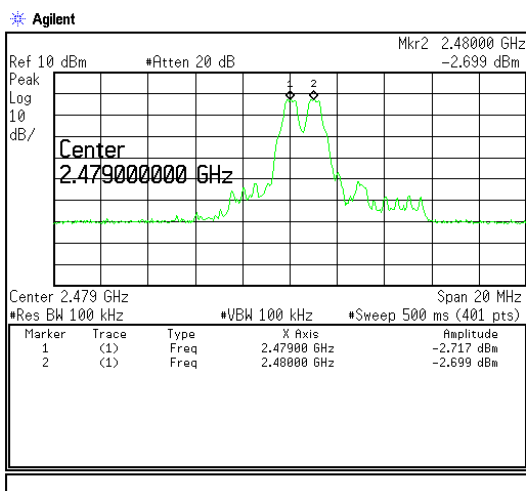

Freq/Channel	
Center Freq	2.47900000 GHz
Start Freq	2.46900000 GHz
Stop Freq	2.48900000 GHz
CF Step	2.00000000 MHz Auto Man
Freq Offset	0.00000000 Hz
Signal Track	On Off

8. Dwell Time

8.1. Test Equipment

	Equipment	Manufacturer	Model No./Serial No.	Last Cal.
X	EMI Test Receiver	R & S	ESI 26 / 838786/004	May, 2006

Note: 1. All equipments are calibrated every one year.
 2. The test equipments marked "X" are used to measure the final test results.

8.2. Test Setup

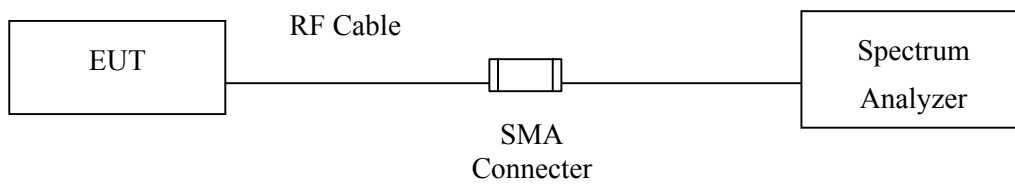

8.3. Limit

The dwell time shall be the average time of occupancy on any frequency shall not be greater than 0.4 seconds within a 30 second period.

8.4. Uncertainty

± 25msec

8.5. Test Result of Dwell Time

Product : Bluetooth Music Audio Transmitter
 Test Item : Dwell Time
 Test Site : No.3 OATS
 Test Mode : Mode 1: Transmitter (Channel 00,39,78 –DH1)

Channel (MHz)	Measurement Level (ms)	Required Limit (sec.)	Result
CH 00 2402	128	< 0.4	Pass
CH 39 2441	128	< 0.4	Pass
CH 78 2480	128	< 0.4	Pass

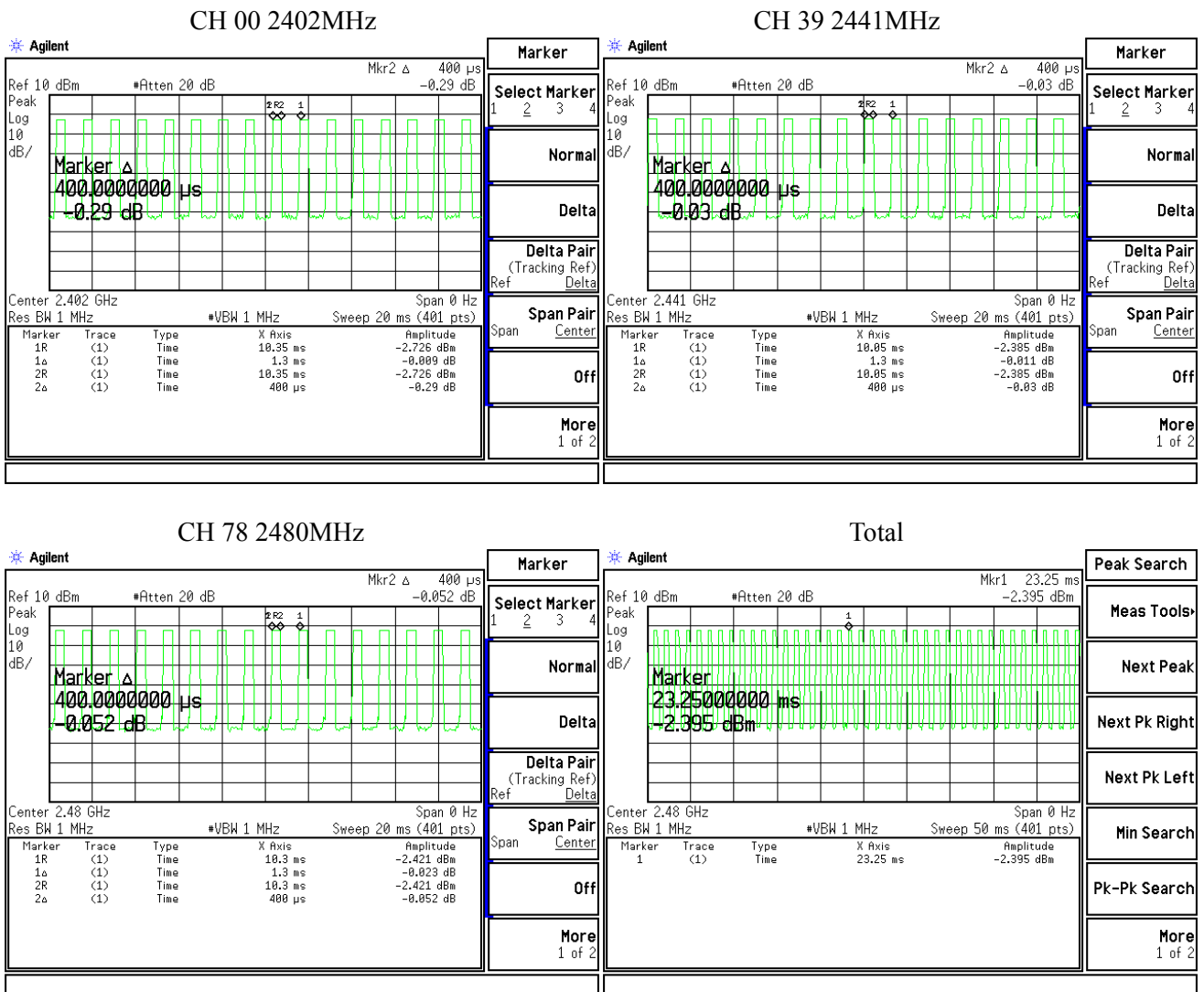

Note: Dwell time = time slot length * hop rate / number of hopping channels * period

Occupancy Time of Frequency Hopping System

Test Time Period: $0.4 * 79 = 31.6\text{sec}$, Hopping Times Within 1sec: $40/50\text{msec} = 0.8 \text{ hops/msec}$.

A) 2402MHz The Maximum Occupancy Time Within 31.6sec: $400 \mu\text{s} * 800 / 79 * 31.6 = 128\text{msec}$ ◦

B) 2441MHz The Maximum Occupancy Time Within 31.6sec: $400 \mu\text{s} * 800 / 79 * 31.6 = 128\text{msec}$ ◦

C) 2480MHz The Maximum Occupancy Time Within 31.6sec: $400 \mu\text{s} * 800 / 79 * 31.6 = 128\text{msec}$ ◦

Test Result: The average occupancy times of the highest, middle and lowest channel are less than 0.4sec, and thus complies the standard.

PS: (1) From Bluetooth Specification, It Hops 1640 Times in 1sec. The Average Occupancy Time of Each 79 Channels is $1600/79$ Times, Therefore, We Calculate The Maximum Occupancy Time (worst care) As Below:

A) 2402Mhz The Occupancy Time of Each Pulse is 0.4msec, The Maximum Occupancy Time within 31.6sec is $0.4\text{msec} * 1640/79 * 31.6 = 289.056\text{msec}$

B) 2441MHz The Occupancy Time of Each Pulse is 0.4msec, The Maximum Occupancy Time within 31.6sec is $0.4\text{msec} * 1640/79 * 31.6 = 289.056\text{msec}$

C) 2480MHz The Occupancy Time of Each Pulse is 0.4msec, The Maximum Occupancy Time within 31.6sec is $0.4\text{msec} * 1640/79 * 31.6 = 289.056\text{msec}$

Test Result: The average occupancy times of the highest, middle and lowest channel are less than 0.4sec, and thus complies the standard.

Product : Bluetooth Music Audio Transmitter
 Test Item : Dwell Time
 Test Site : No.3 OATS
 Test Mode : Mode 1: Transmitter (Channel 00,39,78 –DH3)

Channel (MHz)	Measurement Level (ms)	Required Limit (sec.)	Result
CH 00 2402	264	< 0.4	Pass
CH 39 2441	264	< 0.4	Pass
CH 78 2480	264	< 0.4	Pass

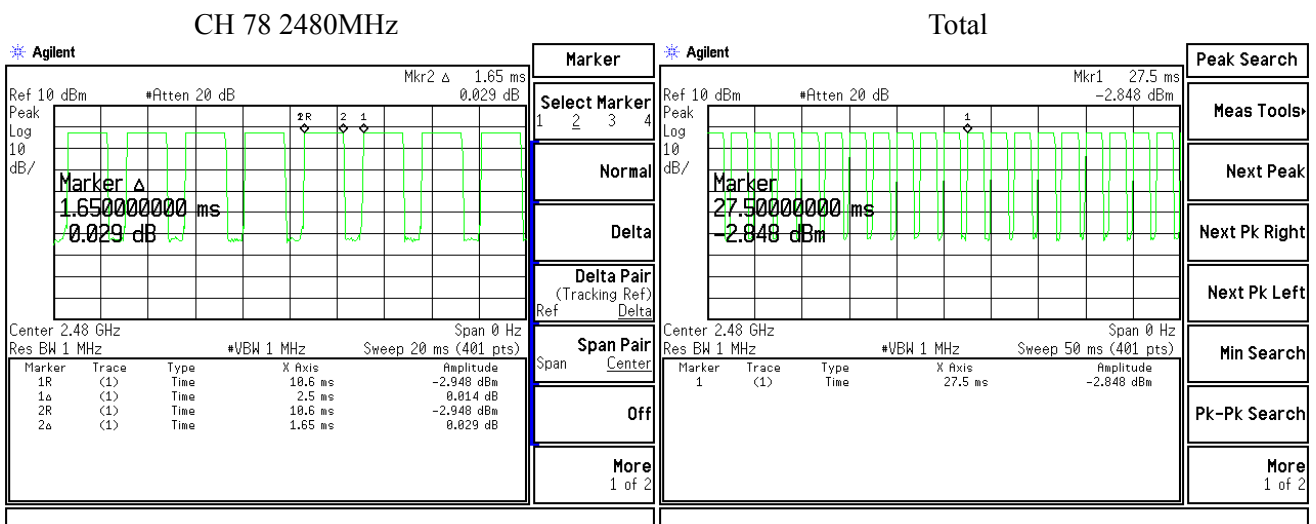
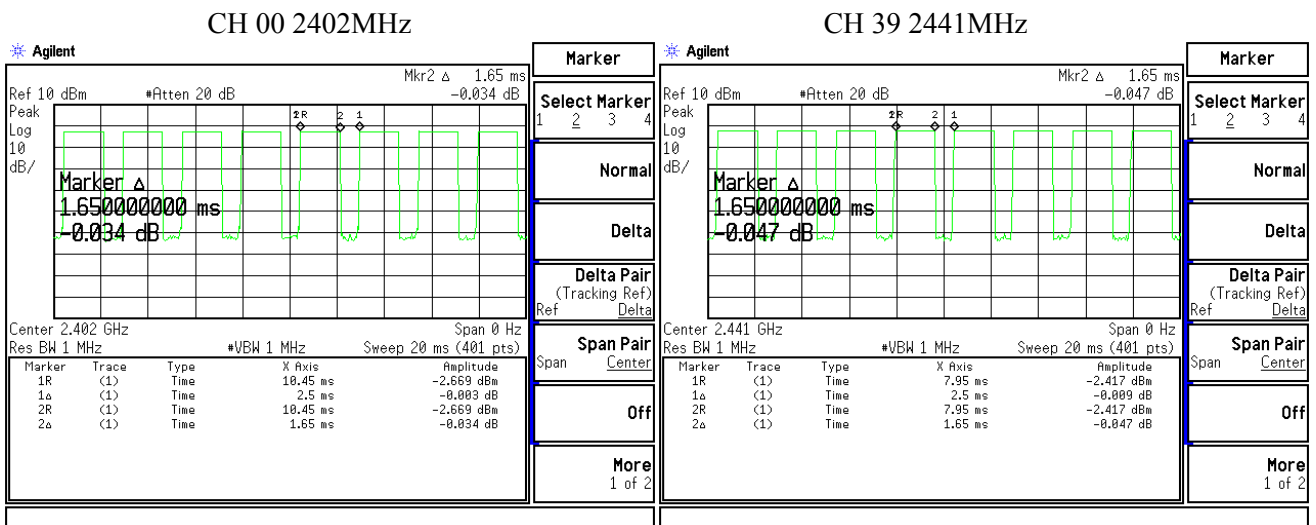

Note: Dwell time = time slot length * hop rate / number of hopping channels * period

Occupancy Time of Frequency Hopping System

Test Time Period: $0.4 * 79 = 31.6\text{sec}$, Hopping Times Within 1sec: $20/50\text{msec} = 0.4 \text{ hops/msec}$.

A) 2402MHz The Maximum Occupancy Time Within 31.6sec: $1650 \mu\text{s} * 400 / 79 * 31.6 = 264\text{msec}$ °

B) 2441MHz The Maximum Occupancy Time Within 31.6sec: $1650 \mu\text{s} * 400 / 79 * 31.6 = 264\text{msec}$ °

C) 2480MHz The Maximum Occupancy Time Within 31.6sec: $1650 \mu\text{s} * 400 / 79 * 31.6 = 264\text{msec}$ °

Test Result: The average occupancy times of the highest, middle and lowest channel are less than 0.4sec, and thus complies the standard.

PS: (1) From Bluetooth Specification, It Hops 1640 Times in 1sec. The Average Occupancy Time of Each 79 Channels is $1600/79$ Times, Therefore, We Calculate The Maximum Occupancy Time (worst care) As Below:

A) 2402Mhz The Occupancy Time of Each Pulse is 0.4msec, The Maximum Occupancy Time within 31.6sec is $0.4\text{msec} * 1640/79 * 31.6 = 289.056\text{msec}$

B) 2441MHz The Occupancy Time of Each Pulse is 0.4msec, The Maximum Occupancy Time within 31.6sec is $0.4\text{msec} * 1640/79 * 31.6 = 289.056\text{msec}$

C) 2480MHz The Occupancy Time of Each Pulse is 0.4msec, The Maximum Occupancy Time within 31.6sec is $0.4\text{msec} * 1640/79 * 31.6 = 289.056\text{msec}$

Test Result: The average occupancy times of the highest, middle and lowest channel are less than 0.4sec, and thus complies the standard.

Product : Bluetooth Music Audio Transmitter
 Test Item : Dwell Time
 Test Site : No.3 OATS
 Test Mode : Mode 1: Transmitter (Channel 00,39,78 –DH5)

Channel (MHz)	Measurement Level (ms)	Required Limit (sec.)	Result
CH 00 2402	301.6	< 0.4	Pass
CH 39 2441	301.6	< 0.4	Pass
CH 78 2480	301.6	< 0.4	Pass

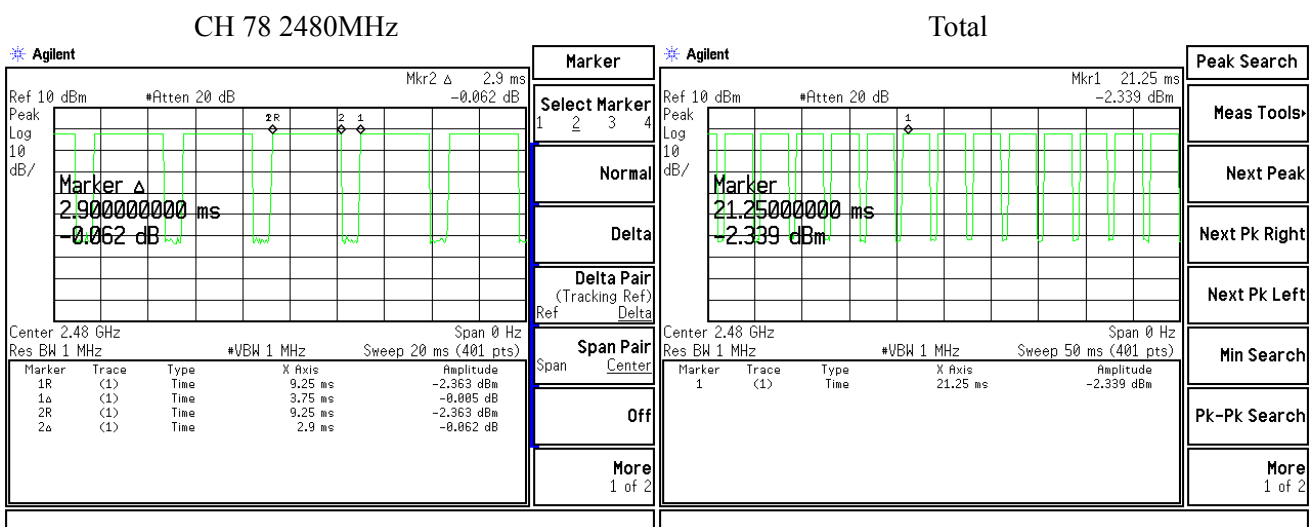
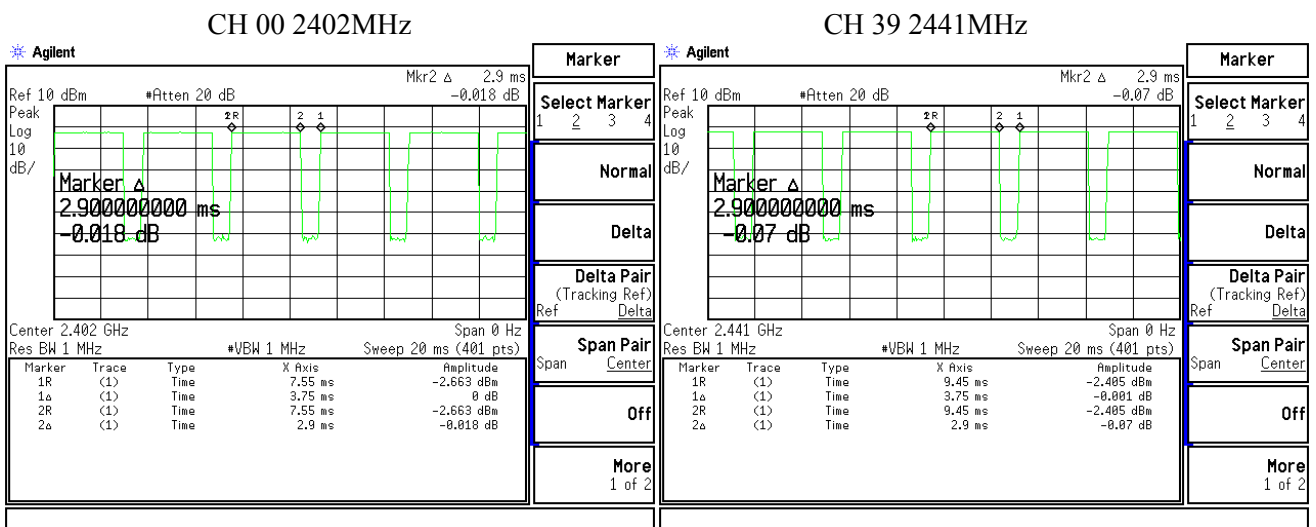

Note: Dwell time = time slot length * hop rate / number of hopping channels * period

Occupancy Time of Frequency Hopping System

Test Time Period: $0.4 * 79 = 31.6\text{sec}$, Hopping Times Within 1sec: $13/50\text{msec} = 0.26\text{ hops/msec}$.

A) 2402MHz The Maximum Occupancy Time Within 31.6sec: $2900 \mu\text{s} * 260 / 79 * 31.6 = 301.6\text{msec}$ ◦

B) 2441MHz The Maximum Occupancy Time Within 31.6sec: $2900 \mu\text{s} * 260 / 79 * 31.6 = 301.6\text{msec}$ ◦

C) 2480MHz The Maximum Occupancy Time Within 31.6sec: $2900 \mu\text{s} * 260 / 79 * 31.6 = 301.6\text{msec}$ ◦

Test Result: The average occupancy times of the highest, middle and lowest channel are less than 0.4sec, and thus complies the standard.

PS: (1) From Bluetooth Specification, It Hops 1640 Times in 1sec. The Average Occupancy Time of Each 79 Channels is $1600/79$ Times, Therefore, We Calculate The Maximum Occupancy Time (worst care) As Below:

A) 2402Mhz The Occupancy Time of Each Pulse is 0.4msec, The Maximum Occupancy Time within 31.6sec is $0.4\text{msec} * 1640/79 * 31.6 = 289.056\text{msec}$

B) 2441MHz The Occupancy Time of Each Pulse is 0.4msec, The Maximum Occupancy Time within 31.6sec is $0.4\text{msec} * 1640/79 * 31.6 = 289.056\text{msec}$

C) 2480MHz The Occupancy Time of Each Pulse is 0.4msec, The Maximum Occupancy Time within 31.6sec is $0.4\text{msec} * 1640/79 * 31.6 = 289.056\text{msec}$

Test Result: The average occupancy times of the highest, middle and lowest channel are less than 0.4sec, and thus complies the standard.

9. Occupied Bandwidth

9.1. Test Equipment

	Equipment	Manufacturer	Model No./Serial No.	Last Cal.
X	EMI Test Receiver	R & S	ESI 26 / 838786/004	May, 2006

- Note: 1. All equipments are calibrated every one year.
 2. The test instruments Marked “X” are used to measure the final test results.

9.2. Test Setup

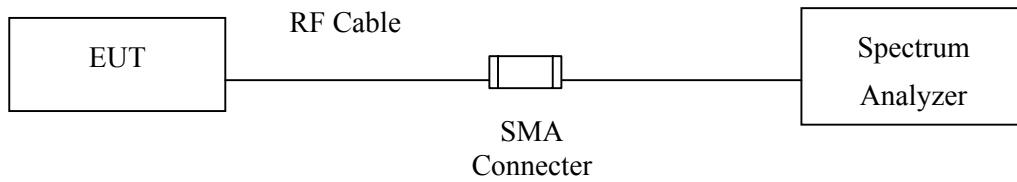

9.3. Limits

N/A

9.4. Uncertainty

± 150Hz

9.5. Test Result of Occupied Bandwidth

Product : Bluetooth Music Audio Transmitter
 Test Item : Occupied Bandwidth Data
 Test Site : No.3 OATS
 Test Mode : Mode 1: Transmitter (2402MHz)

Channel No.	Frequency (MHz)	Measurement Level (kHz)	Required Limit (kHz)	Result
00	2402	1247	--	N/A

Figure Channel 00:

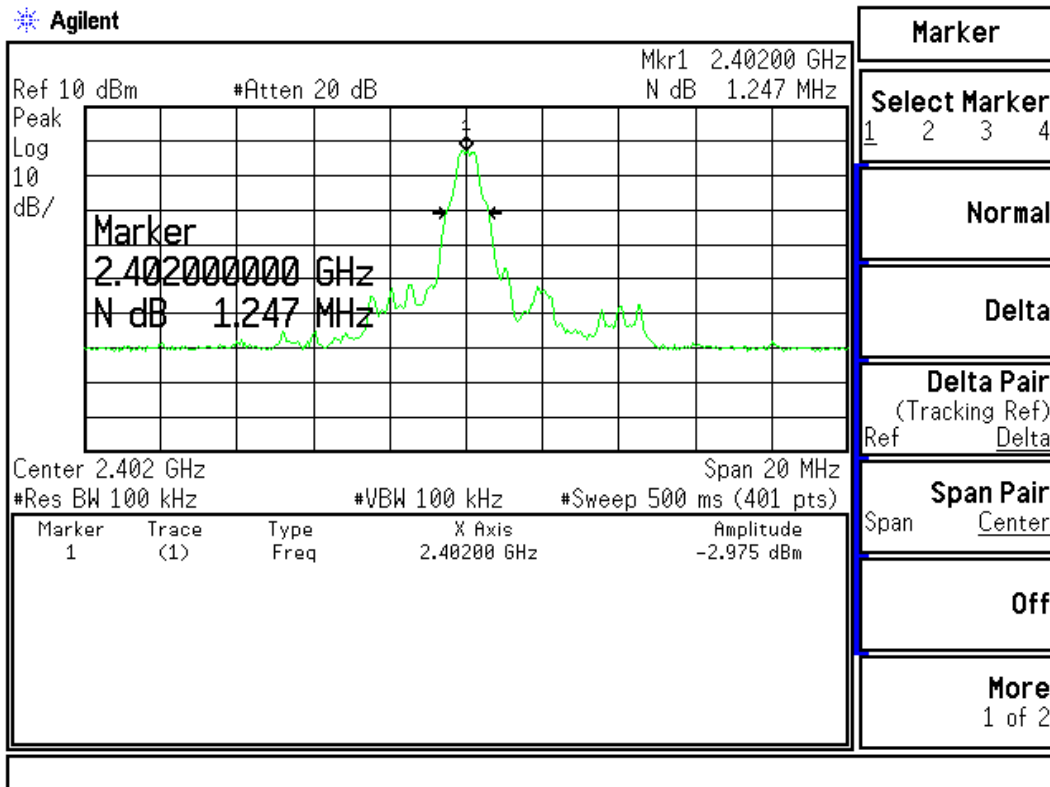

Product : Bluetooth Music Audio Transmitter
 Test Item : Occupied Bandwidth Data
 Test Site : No.3 OATS
 Test Mode : Mode 1: Transmitter (2441MHz)

Channel No.	Frequency (MHz)	Measurement Level (kHz)	Required Limit (kHz)	Result
39	2441	1247	--	N/A

Figure Channel 39:

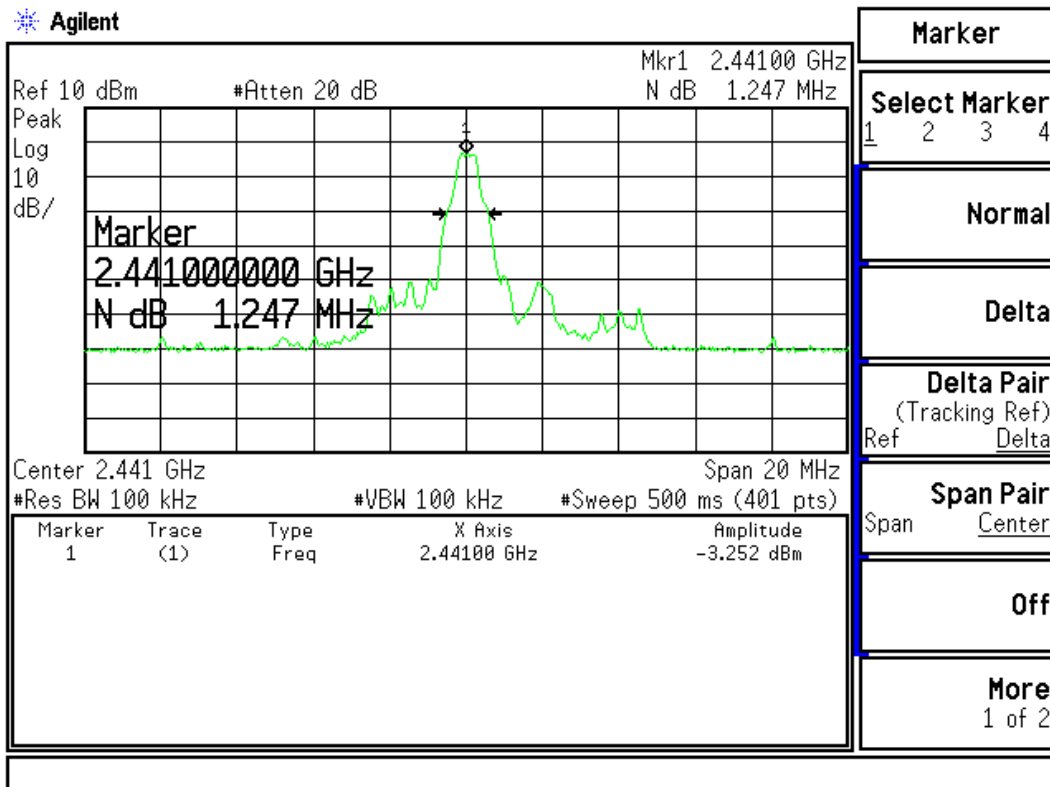

Product : Bluetooth Music Audio Transmitter
 Test Item : Occupied Bandwidth Data
 Test Site : No.3 OATS
 Test Mode : Mode 1: Transmitter (2480MHz)

Channel No.	Frequency (MHz)	Measurement Level (kHz)	Required Limit (kHz)	Result
78	2480	1247	--	N/A

Figure Channel 78:

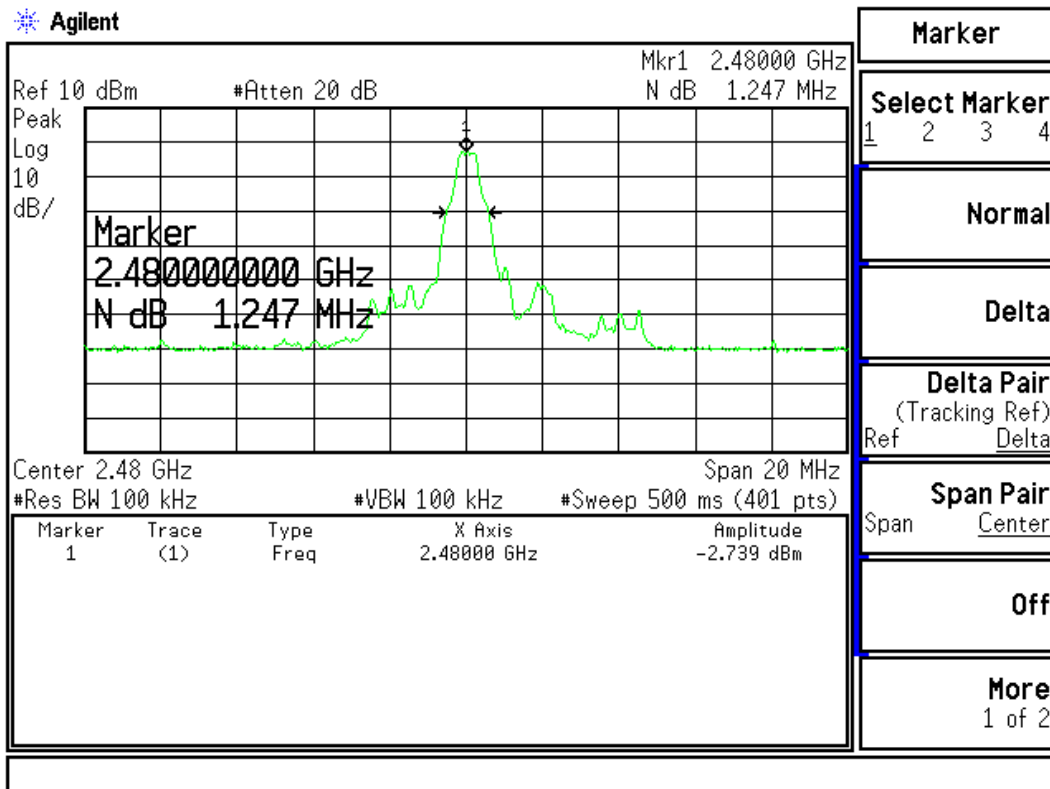

10. EMI Reduction Method During Compliance Testing

No modification was made during testing.